

123B/124B/125B

Industrial ScopeMeter®

Test Equipment Depot - 800.517.8431 - 99 Washington Street Melrose, MA 02176 - TestEquipmentDepot.com

Users Manual

January 2016

© 2016 Fluke Corporation. All rights reserved. Specifications are subject to change without notice.

All product names are trademarks of their respective companies.

LIMITED WARRANTY AND LIMITATION OF LIABILITY

Each Fluke product is warranted to be free from defects in material and workmanship under normal use and service. The warranty period is three years and begins on the date of shipment. Parts, product repairs, and services are warranted for 90 days. This warranty extends only to the original buyer or end-user customer of a Fluke authorized reseller, and does not apply to fuses, disposable batteries, or to any product which, in Fluke's opinion, has been misused, altered, neglected, contaminated, or damaged by accident or abnormal conditions of operation or handling. Fluke warrants that software will operate substantially in accordance with its functional specifications for 90 days and that it has been properly recorded on non-defective media. Fluke does not warrant that software will be error free or operate without interruption.

Fluke authorized resellers shall extend this warranty on new and unused products to end-user customers only but have no authority to extend a greater or different warranty on behalf of Fluke. Warranty support is available only if product is purchased through a Fluke authorized sales outlet or Buyer has paid the applicable international price. Fluke reserves the right to invoice Buyer for importation costs of repair/replacement parts when product purchased in one country is submitted for repair in another country.

Fluke's warranty obligation is limited, at Fluke's option, to refund of the purchase price, free of charge repair, or replacement of a defective product which is returned to a Fluke authorized service center within the warranty period.

To obtain warranty service, contact your nearest Fluke authorized service center to obtain return authorization information, then send the product to that service center, with a description of the difficulty, postage and insurance prepaid (FOB Destination). Fluke assumes no risk for damage in transit. Following warranty repair, the product will be returned to Buyer, transportation prepaid (FOB Destination). If Fluke determines that failure was caused by neglect, misuse, contamination, alteration, accident, or abnormal condition of operation or handling, including overvoltage failures caused by use outside the product's specified rating, or normal wear and tear of mechanical components, Fluke will provide an estimate of repair costs and obtain authorization before commencing the work. Following repair, the product will be returned to the Buyer transportation prepaid and the Buyer will be billed for the repair and return transportation charges (FOB Shipping Point).

THIS WARRANTY IS BUYER'S SOLE AND EXCLUSIVE REMEDY AND IS IN LIEU OF ALL OTHER WARRANTIES, EXPRESS OR IMPLIED, INCLUDING BUT NOT LIMITED TO ANY IMPLIED WARRANTY OF MERCHANTABILITY OR FITNESS FOR A PARTICULAR PURPOSE. FLUKE SHALL NOT BE LIABLE FOR ANY SPECIAL, INDIRECT, INCIDENTAL OR CONSEQUENTIAL DAMAGES OR LOSSES, INCLUDING LOSS OF DATA, ARISING FROM ANY CAUSE OR THEORY.

Since some countries or states do not allow limitation of the term of an implied warranty, or exclusion or limitation of incidental or consequential damages, the limitations and exclusions of this warranty may not apply to every buyer. If any provision of this Warranty is held invalid or unenforceable by a court or other decision-maker of competent jurisdiction, such holding will not affect the validity or enforceability of any other provision.

Table of Contents

Title	Page
Introduction	1
How to Contact Fluke	1
Safety Information	1
Test Tool Kit Contents	5
Get Started	7
Battery Pack	7
Mains Power Source	8
SD Memory Cards	8
Test Tool Setup	9
Reset the Test Tool	9
Screen Brightness	10
Menu Selection	10
Measurement Connections	11
Input A	11
Input B	11
COM	11

Measurement Probe Setup	11
Tilt Stand.....	12
Hanger	12
Language Selection	12
Scope and Meter Mode	13
How to Read the Screen.....	14
Connect-and-View™	15
Measurements	15
Inputs	19
Voltage Measurements	19
Ohm, Continuity, Diode, Capacitance Measurements.....	19
Current Measurements	19
Temperature Measurements.....	19
Power Measurements	19
IntellaSet™ / AutoReading.....	19
Measurement Type.....	20
Screen Freeze	21
How to Hold a Stable Reading	21
Relative Measurements	22
Auto Range/Manual Range.....	23
Screen Graphic Adjustment.....	23
Amplitude	23
Time Base	23
Waveform Position	23
Noise Reduction.....	24
Glitch Display	24
Waveform Smoothing.....	25
Reading Smoothing.....	26
How to Display the Envelope of a Waveform	26
Waveform Acquisition	27

Single Acquisition	27
Slow Signals	28
AC Coupling.....	29
Waveform Trigger.....	29
Set Trigger Level and Slope	29
Select Trigger Parameters.....	30
Cursor Measurements	32
Horizontal Cursors	32
Vertical Cursors	33
Rise Time Measurements.....	34
High Frequency Measurements with 10:1 Probe.....	35
Probe Attenuation.....	35
Probe Adjustment	35
Power and Harmonics Mode	35
Volts/Amps/Watt Measurements	36
Harmonics Measurements.....	38
Zooming Harmonics	42
Fieldbus Mode.....	42
How to Read the Screen	44
How to View the Bus Waveform Screen.....	47
Test Limits	48
Recorder Mode	49
Start and Stop Meter Recording	50
Cursor Measurements	52
Zoom In/Out on Logged Meter Data	53
Events	53
Scope Record Mode.....	53
Save and Recall Data Sets	55
Test Sequence	56
Setting Recall	57

Data Set Management	57
Waveform Comparison	58
Communication	59
Optical Interface	59
Wireless Interface	59
Maintenance	61
How to Clean	61
Storage	61
Battery Replacement	61
10:1 Scope Probes	62
Calibration Information	63
Replaceable Parts and Accessories	64
Tips	67
Battery Life	67
Power Off Timer	67
Autoset Options	68
Grounding Guidelines	68
Specifications	69
Dual Input Oscilloscope	69
Dual Input Meter	71
Cursor Readout (124B, 125B)	78
Recorder	79
Power Quality (125B)	80
Field Bus Measurements (125B)	81
Miscellaneous	82
Environmental	83

List of Tables

Table	Title	Page
1.	Symbols.....	4
2.	Packing List.....	5
3.	Parts of the Screen.....	14
4.	Volt/Amp Readings.....	37
5.	Watt Readings.....	37
6.	Harmonics Voltage Measurements.....	39
7.	Harmonics Current Measurements.....	40
8.	Harmonics Power Measurements.....	41
9.	Bus Measurement Inputs.....	43
10.	Field Bus Test Screen.....	44
11.	Test Signal Properties.....	45
12.	Bus Test Screen Indicators.....	46
13.	Replaceable Parts and Accessories.....	65
14.	Optional Accessories.....	66

List of Figures

Figure	Title	Page
1.	Test Tool Kit	6
2.	Battery Charging	7
3.	Power Up/Reset Screen	9
4.	Input Connections for Measurement	11
5.	Tilt Stand and Hanger	12
6.	Auto Set Function	15
7.	Measurement Setup	16
8.	Correct Grounding Setup	17
9.	Temperature and Current Measurement Setup	18
10.	AutoReading Function	20
11.	Waveform Smoothing	25
12.	Bus Health Indicator Boundaries	47
13.	WiFi USB Adapter	59
14.	10:1 Scope Probes	63
15.	Max. Input Voltage vs. Frequency for BB120 and STL120-IV	85
16.	Safe Handling: Max. Voltage Between Test Tool Reference and Earth Ground	85

Introduction

The 123B/124B/125B ScopeMeter® (the Test Tool or Product) is an integrated Test Tool, with oscilloscope, multimeter, and 'paperless' recorder in one easy-to-use instrument.

Safety Information

A **Warning** identifies hazardous conditions and procedures that are dangerous to the user.

A **Caution** identifies conditions and procedures that can cause damage to the Product or the equipment under test.

Warning

To prevent possible electrical shock, fire, or personal injury:













- **Read all safety information before you use the Product.**
- **Use the Product only as specified, or the protection supplied by the Product can be compromised.**
- **Carefully read all instructions.**

- Do not apply more than one phase of a multiphase system simultaneously to any COM ⚡ (common) connection. All Common (COM) connections should be equipotential, as marked.
- Remove the batteries if the Product is not used for an extended period of time, or if stored in temperatures above 50 °C. If the batteries are not removed, battery leakage can damage the Product.
- The battery door must be closed and locked before you operate the Product.
- Comply with local and national safety codes. Use personal protective equipment (approved rubber gloves, face protection, and flame-resistant clothes) to prevent shock and arc blast injury where hazardous live conductors are exposed.
- Do not apply more than the rated voltage, between the terminals or between each terminal and earth ground.
- Limit operation to the specified measurement category, voltage, or amperage ratings.
- Use Product-approved measurement category (CAT), voltage, and amperage rated accessories (probes, test leads, and adapters) for all measurements.
- Measure a known voltage first to make sure that the Product operates correctly.
- Use the correct terminals, function, and range for measurements.
- De-energize the circuit or wear personal protective equipment in compliance with local requirements before you apply or remove the flexible current probe from hazardous live conductors.
- Do not touch voltages > 30 V ac rms, 42 V ac peak, or 60 V dc.
- Do not use the Product around explosive gas, vapor, or in damp or wet environments.

- Do not use the Product if it operates incorrectly.
- Examine the case before you use the Product. Look for cracks or missing plastic. Carefully look at the insulation around the terminals.
- Do not use test leads if they are damaged. Examine the test leads for damaged insulation, exposed metal, or if the wear indicator shows. Check test lead continuity.
- Use only cables with correct voltage ratings.
- Connect the common test lead before the live test lead and remove the live test lead before the common test lead.
- Keep fingers behind the finger guards on the probes.
- Remove all probes, test leads, and accessories before the battery door is opened.
- Remove all probes, test leads, and accessories that are not necessary for the measurement.
- Do not exceed the Measurement Category (CAT) rating of the lowest rated individual component of a Product, probe, or accessory.
- Do not use a current measurement as an indication that a circuit is safe to touch. A voltage measurement is necessary to know if a circuit is hazardous.
- Disable the Product if it is damaged.
- Do not use the Product if it is damaged.
- Do not use the Product above its rated frequency.
- Do not use the Current Probe if it has damaged insulation, exposed metal, or if the wear indicator is visible.
- Do not wear loose-fitting clothing or jewelry and keep long hair tied back when near rotating machinery. Use approved eye protection and approved personal-protective equipment where necessary.

See Table 1 for a list of symbols used on the Product and in this manual.

Table 1. Symbols

Symbol	Description	Symbol	Description
	WARNING. RISK OF DANGER.		WARNING. HAZARDOUS VOLTAGE. Risk of electric shock.
	Consult user documentation.		Conforms to European Union directives.
	Double Insulated		Conforms to relevant South Korean EMC Standards.
	Earth		Certified by CSA Group to North American safety standards.
	Equipotential		Battery Safety Approval
	Conforms to relevant Australian Safety and EMC standards.		
CAT III	Measurement Category III is applicable to test and measuring circuits connected to the distribution part of the building's low-voltage MAINS installation.		
CAT IV	Measurement Category IV is applicable to test and measuring circuits connected at the source of the building's low-voltage MAINS installation.		
	This product contains a Lithium-ion battery. Do not mix with solid waste stream. Spent batteries should be disposed of by a qualified recycler or hazardous materials handler per local regulations. Contact your authorized Fluke Service Center for recycling information.		
	This product complies with the WEEE Directive marking requirements. The affixed label indicates that you must not discard this electrical/electronic product in domestic household waste. Product Category: With reference to the equipment types in the WEEE Directive Annex I, this product is classed as category 9 "Monitoring and Control Instrumentation" product. Do not dispose of this product as unsorted municipal waste.		

Test Tool Kit Contents

Table 2 is a list of the items included in your Test Tool kit.

Also see Figure 1.

Table 2. Packing List

Item	Description	12x-B	12x-B/S
1	Fluke Test Tool	123B, 124B or 125B	123B/S, 124B/S or 125B/S
2	Rechargeable Li-ion Battery Pack	●	●
3	Switch Mode Power Supply, Adapter/Battery Charger	●	●
4	Shielded Test Leads with Black Ground Leads	●	●
5	Test Lead Black (for Grounding)	●	●
6	Hook Clips (red, blue)	●	●
7	Banana-to-BNC Adapters (black)	● (x1)	● (x2)
8	Safety Information + CD-ROM with Users Manuals	●	●
9	10:1 Voltage Probe	124B, 125B	124B/S, 125B/S
10	i400s AC Current Clamp	125B	125B
11	USB Angled Adapter	●	●
12	WiFi USB Adapter	depends on version	
13	Soft Carrying Case		●
14	Magnetic Hanger		●
15	FlukeView® ScopeMeter® Software for Windows®		●
16	Screen Protector		●

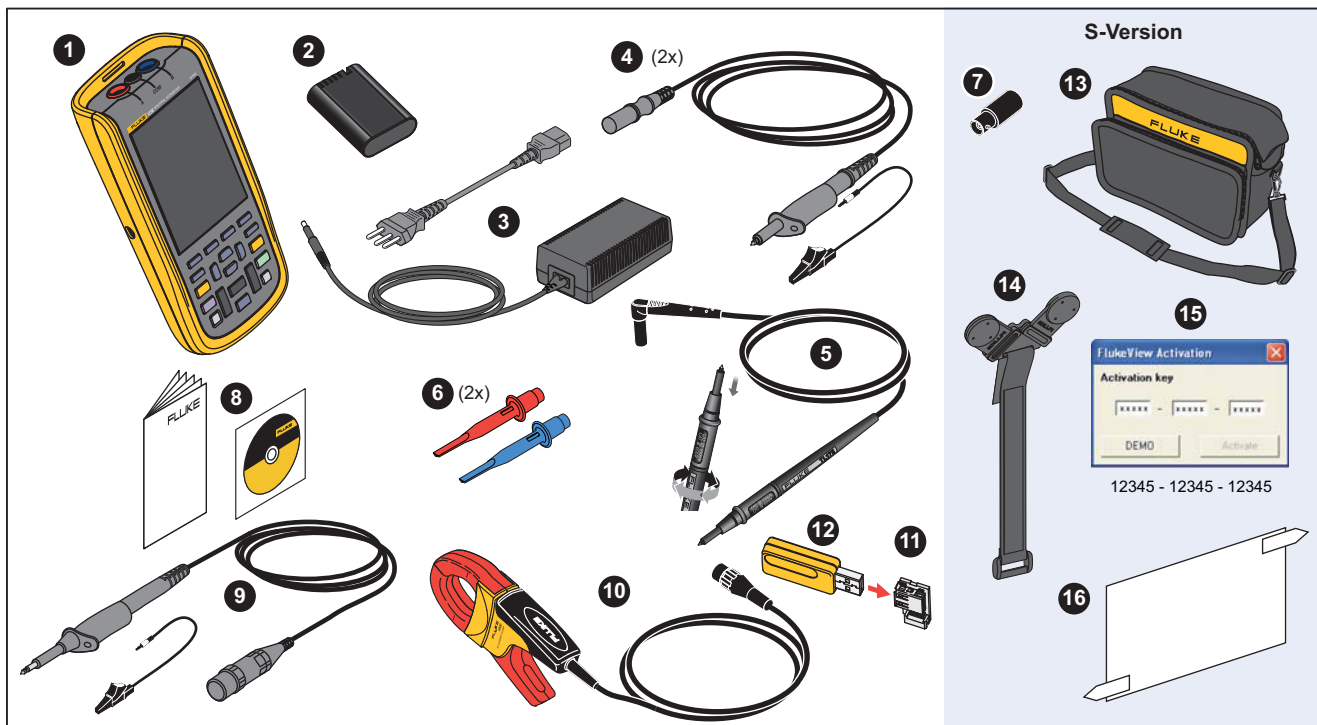

Figure 1. Test Tool Kit

hvx01.eps

Get Started

Before you use your Test Tool for the first time, read this section.

Battery Pack

Li-ion batteries may be discharged at delivery. Completely discharged batteries can cause the Test Tool not to start up when it is turned on. To reach full charge, charge for 4 hours with the Test Tool turned off.

When fully charged, the batteries provide up to 7 hours (single channel, time base slower than 1 μ s/div) of use when the backlight is dimmed.

The battery status shows as an icon in the top right corner of the screen:

 - full charge

 - about 5 minutes of operation remains

To charge the batteries and power the instrument, connect the power adapter as shown in Figure 2. To charge the batteries more quickly, turn off the Test Tool.

Caution

To prevent overheating of the batteries during charging, do not exceed the allowable ambient temperature in the specifications.

Note

The power adapter does not damage the Test Tool even when connected over consecutive days. The power adapter automatically switches to a trickle charge.

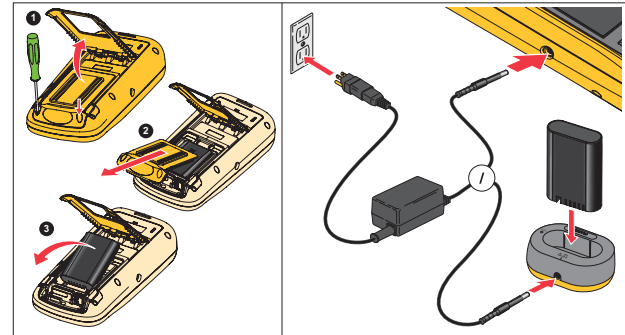

hvx51.eps

Figure 2. Battery Charging

Alternatively, you may choose to exchange the battery (Fluke accessory BP290) with a fully charged one and use the external battery charger EBC290 (optional Fluke accessory).

To accommodate connection to various line power sockets, the BC430/820 universal Battery Charger / Power Adapter is equipped with a male plug that must be connected to a line cord appropriate for local use. Because the adapter is isolated, the line cord does not need to be equipped with a terminal for connection to protective ground. Or use a line cord with a protective grounding terminal.

Mains Power Source

To use the mains power source:

1. Attach the power cord to the mains power.
2. Attach the DC power connector in the left side of the Test Tool.
3. Push  to turn on the Test Tool.

The Test Tool turns on within 10 seconds in its last setup configuration.

SD Memory Cards

The Test Tool has a SD Memory Card for storage of recorder measurement data or data sets (see page 55). The file format is FAT32. This data is retained also when the Test Tool is disconnected from its power sources. The memory card is located in the battery compartment.

To lock or unlock the card, press it down. The correct position of the card is shown in the compartment. This compartment also contains a connector for adding WiFi connectivity with a USB flash drive. See *Wireless Connectivity* for more information.

Caution

To prevent damage to the SD memory card, do not touch the contacts.

Test Tool Setup

This section explains the basics for how to use your Test Tool.

Reset the Test Tool

To restore the Test Tool to the factory default settings:

1. Push and hold **MENU** + **Ⓞ**.
2. Release **Ⓞ**.
3. Release **MENU**.

Figure 3 shows the Test Tool screen the first time you power on or after a successful reset.

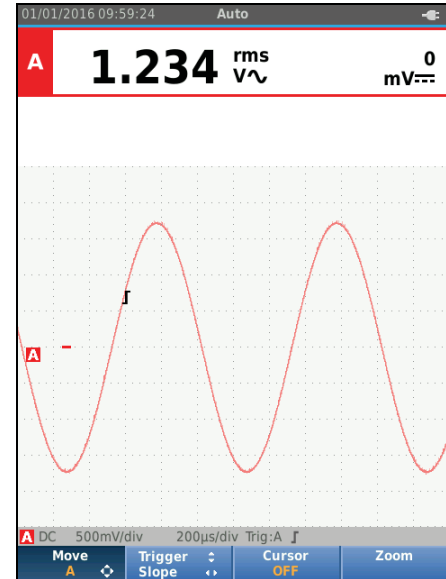



hvx10.eps

Figure 3. Power Up/Reset Screen

Screen Brightness















By default the display is at the brightest setting. To extend the battery life, you can decrease the brightness setting.

To change the brightness of the display:



1. With the Test Tool turned on, push  for >3 seconds and release.
2. Push   to increase or decrease the backlight.

Menu Selection

The buttons on the keypad provide the navigation through the functions you see on the display. For example, this is the basic sequence for how to adjust a parameter:

-  open the **MENU**
-   move cursor to highlight **USER OPTIONS**
-  select the USER OPTIONS menu
-   move cursor to highlight **Date Format**
-  select DATE FORMAT menu
-   move cursor to highlight a date format
-  confirm the selection
-     select the date
-  confirm the selection

Tips:

- Push  a second time to close the **MENU** and resume normal measurement. This toggle enables you to check the menu without changing the settings.
- When you do not change an item with the cursor keys, push  to step through a menu without changing the setup of the Test Tool.
- Gray text in a menu or button bar indicates that the function is disabled or the status is not valid.

Measurement Connections

The Test Tool has two 4 mm safety-shielded banana jack inputs (red input A and blue input B) and a black safety 4 mm banana jack input (COM). See Figure 4.

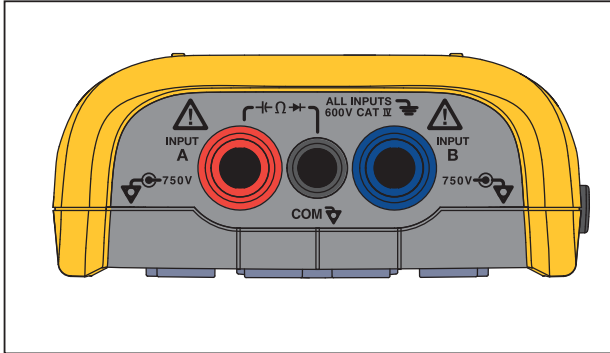

hvx05.eps

Figure 4. Input Connections for Measurement

Input A

Use the input A (red) for all single input measurements.

Input B

For measurements on two different signals, use B input (blue) together with input A (red).

COM

Use the COM input (black) as the single ground for low frequency, continuity, Ohm (Ω), diode, and capacitance measurements.

⚠⚠ Warning

To prevent electrical shock or fire, use only one COM ∇ (common) connection, or ensure that all connections to COM ∇ are at the same potential.

Measurement Probe Setup

The Test Tool supports measurement probes, for example:

- 10:1 voltage probe
- 1 mV/°C temperature probe
- 10 mV/A current clamp

To set up a specific probe type:

1. Push **SCOPE METER** to open the Scope and Meter menu.
2. Push **F3** to open the **INPUT A** menu.
3. Use **▲/▼** to highlight **SELECT**.
4. Push **ENTER** to open the **PROBE** select menu.
5. Use **▲/▼** to highlight the probe type.
6. Push **ENTER** to accept the probe type and close the menu.

Tilt Stand

The Test Tool is equipped with a tilt stand, allowing viewing from an angle. You can also use the tilt stand to hang the Test Tool at a convenient viewing position. See Figure 5.

Hanger

The optional hanger accessory is magnetic and used to hang the Test Tool on metal surfaces such as a cabinet door. See Figure 5.

Language Selection

To change the language:

1. Push **MENU** to open the Menu.
2. Use **▲▼** to highlight **USER OPTIONS**.
3. Push **ENTER** to open the USER OPTIONS menu.
4. Use **▲▼** to highlight **Language**.
5. Push **ENTER** to open the USER > LANGUAGE menu.
6. Use **▲▼** to highlight the language preference.
7. Push **ENTER** to accept the change and exit the menu.

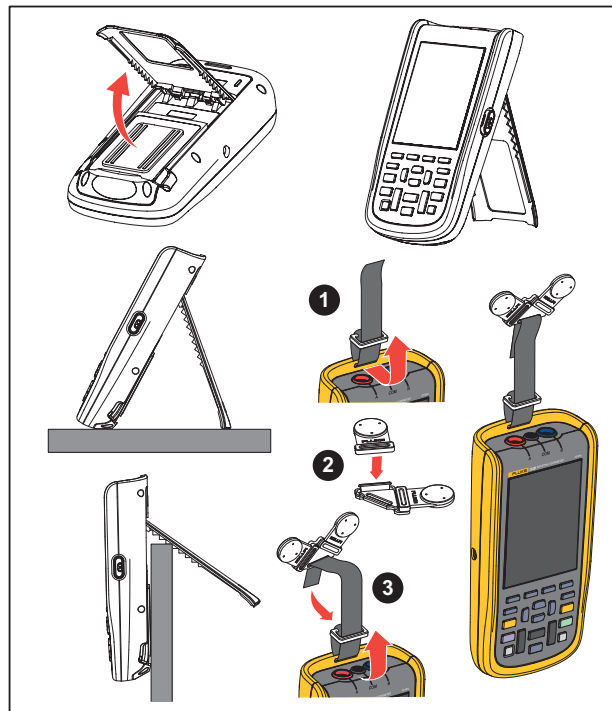

hvx50.eps

Figure 5. Tilt Stand and Hanger

7.

Scope and Meter Mode

The Scope and Meter mode is the default operation mode. When in another mode, such as Recorder, Power Harmonics, or BusHealth, push  to return to Scope and Meter operation. In Scope and Meter mode, the button bar looks like this:



To go to the Move and Zoom button bar, push  until you have left any open button bar or menu.



The yellow text on the button bar indicates the status. Push the button to change the status.

Warning

To prevent possible electrical shock, fire, or personal injury:

- Do not touch exposed metal on banana plugs. They can have voltages that could cause death.
- Disconnect power and discharge all high-voltage capacitors before you measure resistance, continuity, capacitance, or a diode junction.
- Do not put metal objects into connectors.
- Do not use exposed metal BNC or banana plug connectors.
- Do not use the HOLD function to measure unknown potentials. When HOLD is turned on, the display does not change when a different potential is measured.

How to Read the Screen

The screen is divided into these areas: Information, Reading, Waveform, Status, and Menu. See Table 3.

Table 3. Parts of the Screen

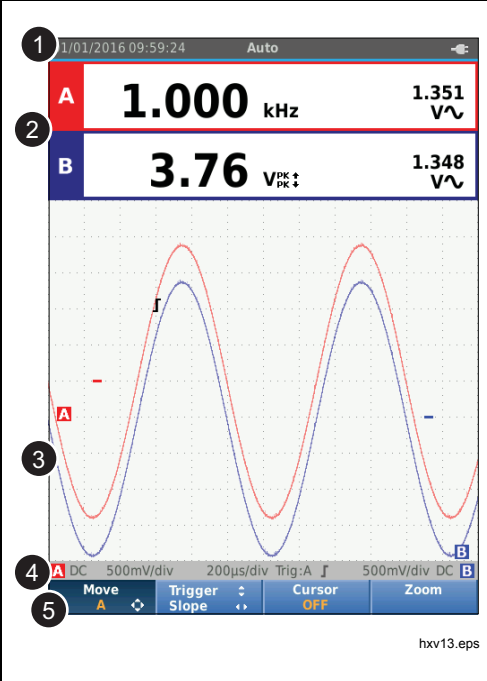
	Item	Area	Description
	1	Information	Date, time, and indicators like Auto range, Hold/Run, AutoHold, and battery status.
2	2	Reading	Numeric readings. If only input A is on, you will see the input A readings only.
3	3	Waveform	Waveforms. If only input A is on, you will see the input A waveform only.
4	4	Status	Displays status of attenuations, timebase, couplings, trigger source, and trigger slope.
5	5	Button Bar	Displays the choices available with <input type="button" value="F1"/> <input type="button" value="F2"/> <input type="button" value="F3"/> <input type="button" value="F4"/> .

When you change a setup, a part of the screen shows the choices. Use  to access the menu choices.

Connect-and-View™

The Connect-and-View™ function (Auto Set) enables hands-off operation to display complex unknown signals. This function optimizes the position, range, time base, and triggering to ensure a stable display on most waveforms. The setup will track the changes if the signal changes. This feature is enabled by default.

To enable the Connect-and-View™ function when in Manual mode:

1. Connect the red test lead from red input A to the unknown signal to be measured.
2. Push  to toggle between the Auto (automatic) and Manual modes.

In Figure 6 the screen displays “**1.234**” in large numbers and “**50.00**” in smaller numbers. A scope trace gives a graphical representation of the waveform.

The trace identifier **A** is visible at the left side of the waveform area. The zero icon (-) identifies the ground level of the waveform.

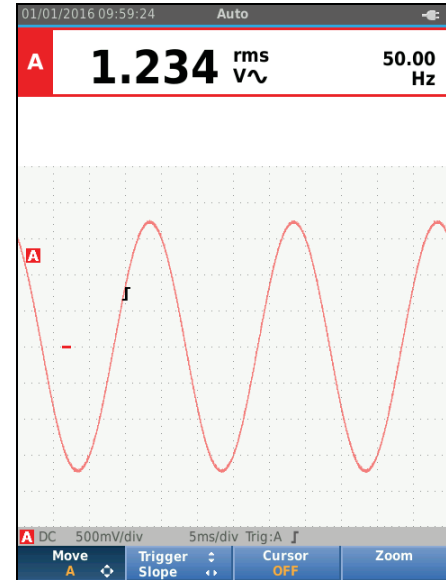

hxv55.eps

Figure 6. Auto Set Function

Measurements

The reading area shows the numeric readings of the chosen measurements on the waveform that is applied to the input jack. Figure 7, Figure 8, and Figure 9 illustrate the setups for measurements.

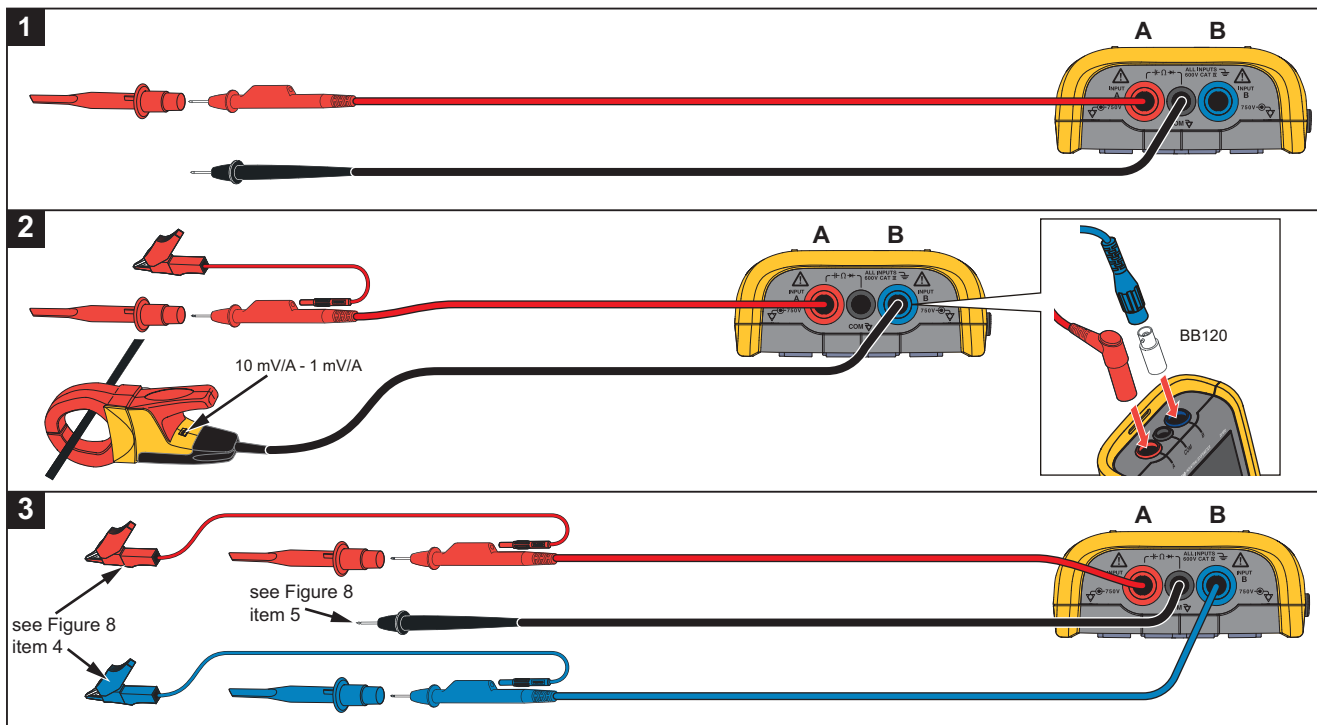

Figure 7. Measurement Setup

hvx03.eps

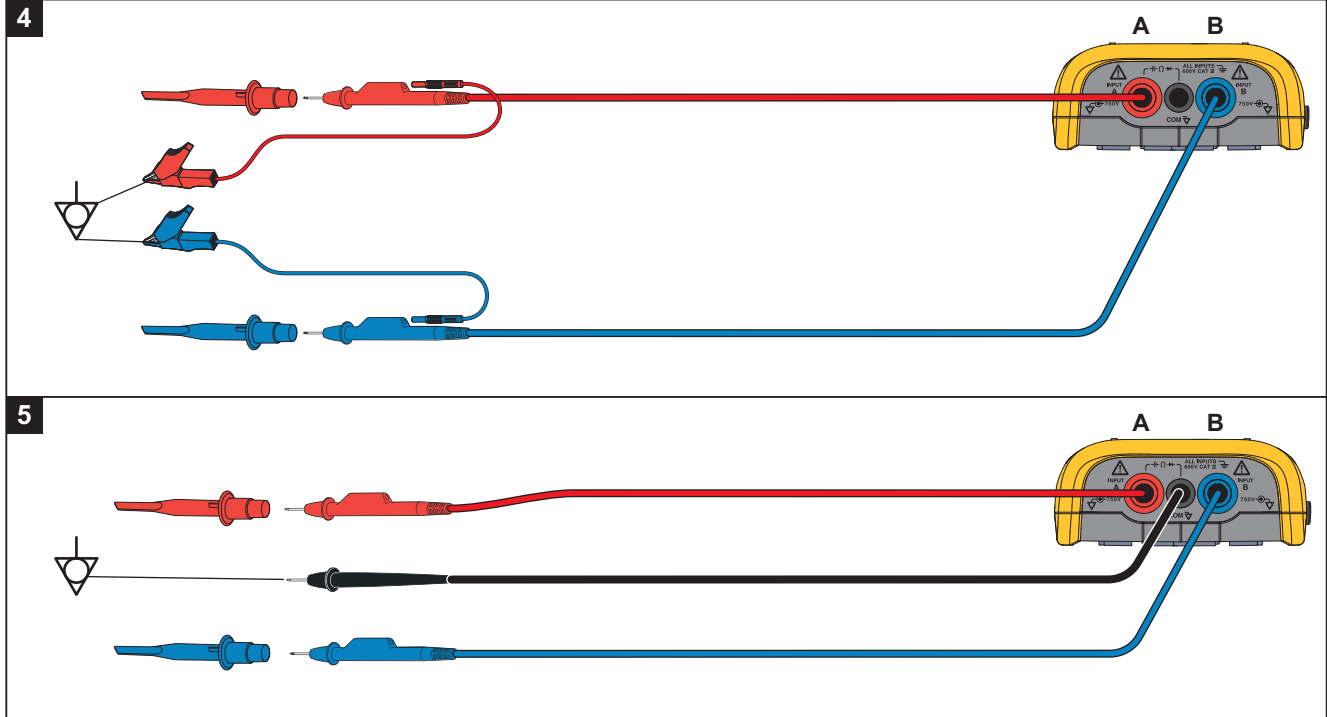

Figure 8. Correct Grounding Setup

hvx04.eps

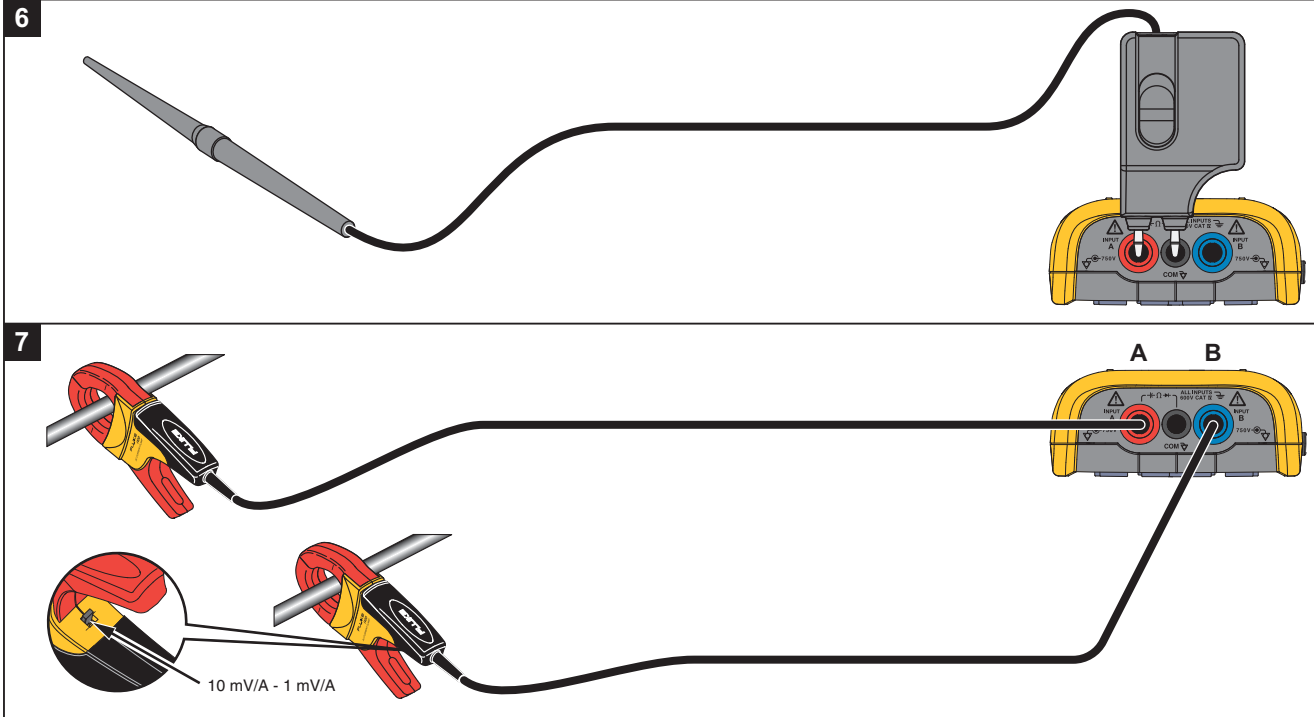

Figure 9. Temperature and Current Measurement Setup

hvx57.eps

Inputs

Voltage Measurements

For proper grounding, connect the short ground leads to the same ground potential, see Figure 8 setup 4. You can also use test leads for grounding, see Figure 8 setup 5. See also *Grounding Guidelines* on page 68.

Ohm, Continuity, Diode, Capacitance Measurements

Use the red shielded test lead from input A and the black unshielded ground lead from COM (common) for Ohms (Ω), continuity, diode, and capacitance measurements. See Figure 7 setup 1.

Current Measurements

Select the probe setting that matches the used current clamp and its setting, for example, 1 mV/A. See Figure 9 and *Measurement Probe Setup*.

Temperature Measurements

Use a 1 mV/°C or 1 mV/°F temperature transmitter (not available in all countries) to get the correct temperature reading. See Figure 9.





Power Measurements

Select correct probe settings for voltage measurement on input A and current measurement on input B. See Figure 7 setup 2.

IntellaSet™ / AutoReading

The AutoReading function uses Fluke IntellaSet™ technology to enable hands-off operation to display meter readings that correspond with the shape of the waveform. This function automatically selects the meter readings that are most often used with the measurement of the waveform shape. As an example, when the waveform is a line voltage signal, the V ac + dc and Hz readings show automatically.

To enable the AutoReading function on input A:

1. Push  to open the Scope and Meter button bar.
2. Push  to open the MEASURE menu. See Figure 10.
3. Push  to select the **AutoReading** to **ON**.
4. Push  to select **Done** and close the menu.

To disable this function, repeat the steps and select the **AutoReading** to **OFF**.

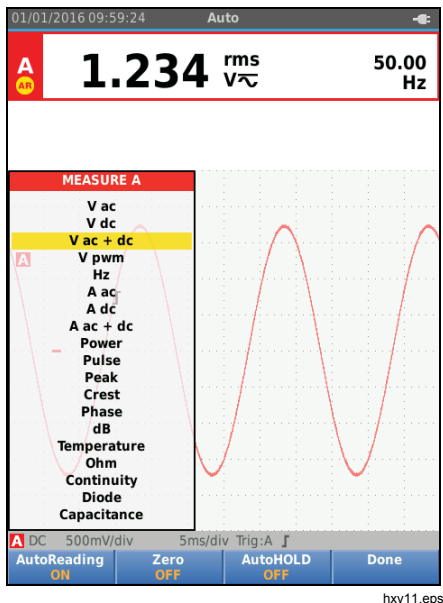

Figure 10. AutoReading Function

Measurement Type

To manually set up or change the measurement type:

1. Push **SCOPE METER** to open the Scope and Meter button bar.
2. Push **F1** to open the MEASURE menu for Input A. Push **F4** to open the MEASURE menu for Input B.
3. Push **◀/▶** to highlight the measurement type, for example, **Hz**.

When more setup selections are available for a measurement type, you see a **▶**. Push **ENTER** to open the submenu and make a selection.

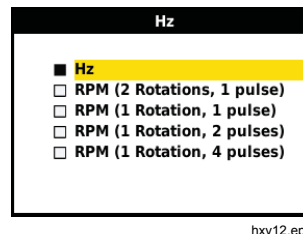

4. Push **ENTER** to accept the measurement type and close the menu.
5. Confirm that the selected measurement type is the main reading. The former main reading moves to the smaller secondary reading position.

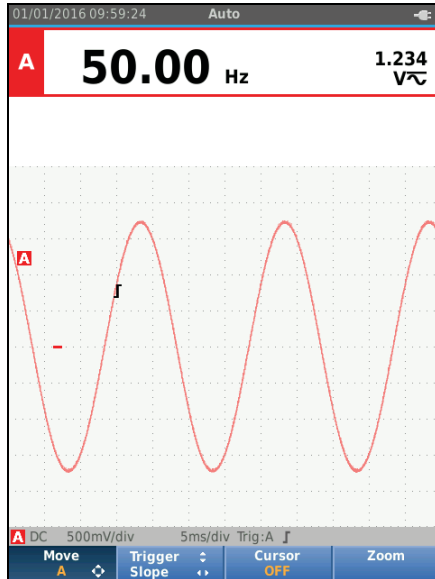

hvx13-1.eps

Screen Freeze

You can freeze the screen (all readings and waveforms) at any time:

1. Push **HOLD RUN** to freeze the screen. The information area at the top of the screen shows **HOLD**.
2. Push **HOLD RUN** again to resume measurements.

How to Hold a Stable Reading

The AutoHold® mode captures a stable main (large) reading on the display. When the Test Tool detects a new stable reading, it beeps and shows the new reading.

To use the AutoHold function:

1. Push **SCOPE METER** to open the Scope and Meter button bar.
2. Push **F1** to open the MEASURE A button bar.
3. Push **F3** to enable AutoHOLD. The Information area of the screen updates and the button label shows **AutoHOLD ON**.
4. Push **F4** to close the MEASURE A menu and button bar.
5. Wait to hear the audible beep that means you have a stable reading.
6. Repeat Step 1 to Step 4 to disable the AutoHold function.

Relative Measurements

Zero Reference shows the present measurement result with respect to the defined value. Use this feature to monitor the measured value in relation to a known good value.

To setup:

1. Push **SCOPE METER** to open the Scope and Meter button bar.
2. Push **F1** to open the MEASURE A button bar.
3. Push **F2** to enable the relative measurement (Zero On).
4. Push **F4** to close the MEASURE A menu and button bar.

The relative measurement is now the main reading, and the former main measurement is now the smaller secondary reading position.

5. Repeat Step 1 to Step 4 to disable the relative measurement.

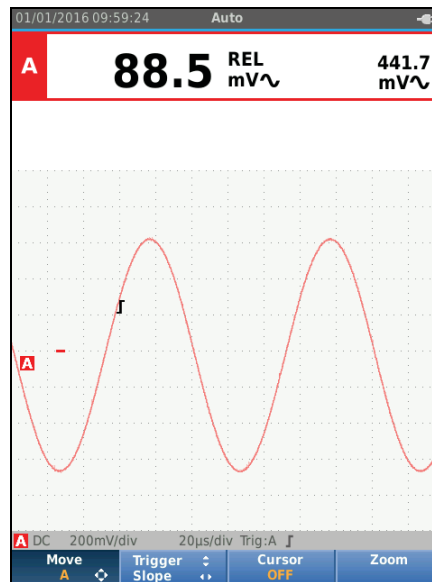

hvx14.eps

Auto Range/Manual Range

Push **AUTO** to toggle between the Manual and Auto Ranging modes.

When Auto Range is active, the Information area shows Auto and the Test Tool automatically adjusts the position, range, time base, and triggering (Connect-and-View). This ensures a stable display on nearly all waveforms. The Status area shows the range, the time base for both inputs, and the trigger information.

When Manual is active, the Information area shows Manual.

Screen Graphic Adjustment

From Auto Range, use **← → ↺ ↻** to manually change the waveform trace. This turns off the Connect-and-View function. Observe that Auto in the Information area disappears.

Amplitude

The available amplitude settings are from 5 mV/div to 200 V/div with the use of test leads.

1. Push **mV** to enlarge the waveform.
2. Push **V** to reduce the waveform.

Time Base

The available time base settings are 10 ns/div or 20 ns/div (depends on model) to 5 s/div in normal mode.

1. Push **TIME** (s) to increase the number of periods.
2. Push **TIME** (ns) to decrease the number of periods.

Waveform Position

You can move the waveforms around on the screen.

Repeatedly push **BACK** until all menus and secondary button bars close.

1. Push **F1** to select **Move A**.
2. Use **← → ↺ ↻** to move the A waveform on the screen.

The trigger identifier (**⏏**) moves horizontally and vertically on the screen as the waveform moves.

Note

The waveform positions are fixed for 3-phase power measurements.

Noise Reduction

To view the waveform without higher frequency noise:

1. Push **SCOPE METER** to open the Scope and Meter button bar.
2. Push **F3** to open the INPUT SETTINGS menu.
3. Use **▲ ▼** to highlight the Noise filter as **ON**.
4. Push **ENTER** to make the change.

This noise filter is a 10 kHz bandwidth limit filter.

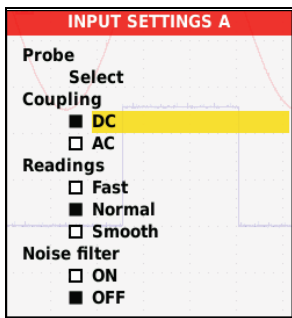

hvx15.eps

Glitch Display

By default, the displayed waveform shows glitches. For each time position the minimum and maximum values since the last time position are shown. A glitch of 25 ns or wider is still visible on the screen even when using a slower timebase.

To disable this feature and see one sample/channel for each sample time:

1. Push **SCOPE METER** to open the Scope and Meter button bar.
2. Push **F2** to open the SCOPE menu.
3. Use **▲ ▼** to highlight the Type as Glitch Off.

This feature will be turned off for both channel A and channel B.

4. Push **ENTER** to make the change.
5. Push **F4** to exit the menu.

Waveform Smoothing

To smooth the waveform:

1. Push **SCOPE METER** to open the Scope and Meter button bar.
2. Push **F2** to open the SCOPE SETTINGS menu.

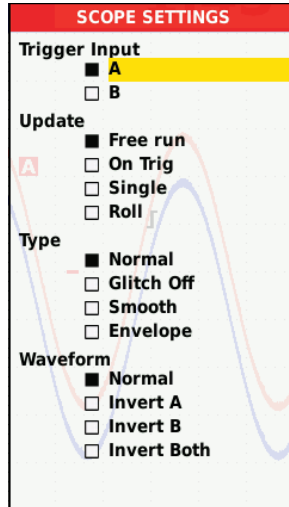

hxx16.eps

3. Use **▲▼** to highlight the Type as **Smooth**. Both the input A and input B waveforms are smoothed.
4. Push **ENTER** to make the change.

5. Push **F4** to exit the menu.

Waveform smoothing suppresses noise without loss of bandwidth. Waveform samples with and without smoothing are shown in Figure 11. Smoothing is the average of eight acquired waveforms. Glitch detect is turned off in this mode.

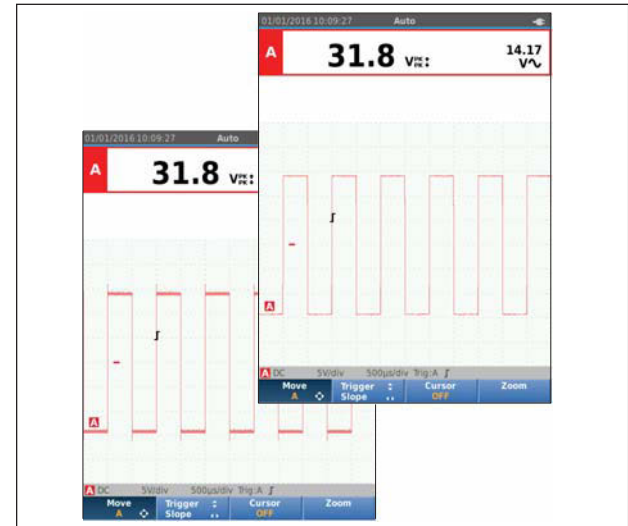

hxx17.eps

Figure 11. Waveform Smoothing

Reading Smoothing

To smooth the readings on A:

1. Push **SCOPE METER** to open the Scope and Meter button bar.
2. Push **F3** to open the INPUT SETTINGS menu.
3. Use **▲▼** to highlight the Readings as **Smooth**.
4. Push **ENTER** to make the change.
5. Push **F4** to exit the menu.

For best results, set Readings to:

- *Fast* for short averaging, fast response
- *Normal* is the default setting
- *Smooth* for long averaging, stable readings

How to Display the Envelope of a Waveform

The Test Tool records the envelope (minimum and maximum) of the live waveforms for inputs A and B.

Repeat the first two actions of *Smoothing the Waveform*, and then do the following:

To display the waveform envelope:

1. Push **SCOPE METER** to open the Scope and Meter button bar.
2. Push **F2** to open the SCOPE SETTINGS menu.
3. Use **▲▼** to highlight the Type as **Envelope**.

4. Push **ENTER** to make the change.

5. Push **F4** to exit the menu.

The screen shows the resultant envelope waveform. You can use Envelope to observe the variations in time or amplitude of input waveforms over a longer time period.

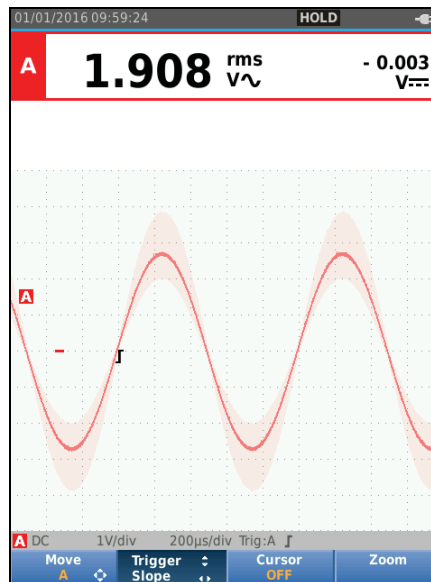

hvx18.eps

Waveform Acquisition

The Test Tool can be setup to acquire waveforms as needed for a specific application. This section explains the setup options.

Single Acquisition

To catch single events, you can perform a single shot (one time screen update).

To set up the Test Tool for a single shot on the input A waveform:

1. Connect the probe to the signal to be measured.
2. Push **SCOPE METER** to open the Scope and Meter button bar.
3. Push **F2** to open the SCOPE SETTINGS menu.
4. Use **▲ ▼** to highlight the Update as **Single**.
5. Push **ENTER** to make the change.
6. Push **F4** to exit the menu.

The Test Tool will now show the acquisition screen and the Information area updates:

- Waiting** Test Tool is waiting for a trigger
- Run** single acquisition is triggered
- Hold** single acquisition is complete

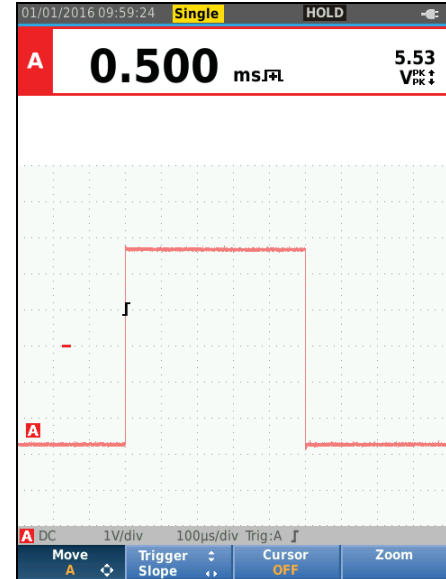

hvx19.eps

To continue with the next single acquisition:

7. Push **HOLD RUN** and wait for another single acquisition trigger.

Slow Signals

The roll mode function supplies a visual log of waveform activity. Use slow signals to measure lower frequency waveforms.

1. Push **SCOPE METER** to open the Scope and Meter button bar.
2. Push **F2** to open the SCOPE SETTINGS menu.
3. Use **▲ ▼** to highlight the Update as **Roll**.
4. Push **ENTER** to make the change.
5. Push **F4** to exit the menu.

The waveform moves across the screen from right to left like a normal chart recorder. The Test Tool does not make measurements while recording.

6. Push **HOLD RUN** to freeze the waveform in roll mode.

The measurement values show only after you push **HOLD RUN**.

To capture longer waveform recordings, see *Recorder Mode*.

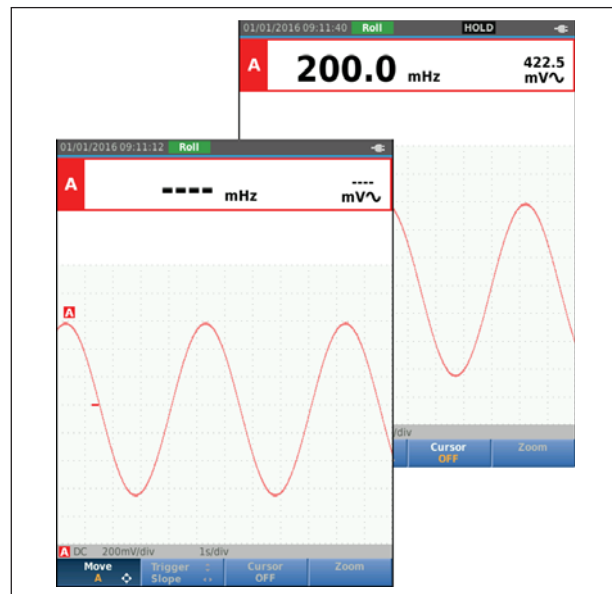

hvx20.eps

AC Coupling

Use AC-coupling to observe a small ac signal that rides on a dc signal.

To select ac-coupling on input A:

1. Push **SCOPE METER** to open the Scope and Meter button bar.
2. Push **F3** to open the INPUT SETTINGS menu.
3. Use **▲▼** to highlight the Coupling as **AC**.
4. Push **ENTER** to make the change.
5. Push **F4** to exit the menu.

Waveform Trigger

The trigger tells the Test Tool when to start the waveform trace. You can:

- select which input signal to use
- select which edge this should occur
- define the condition for a new update of the waveform

The bottom line of the waveform area identifies the trigger parameters in use. Trigger icons on the screen indicate the trigger level and slope.

Note



The trigger settings are fixed for 3-phase power measurements.

Set Trigger Level and Slope

For quick operation, use **AUTO** to automatically trigger on nearly all signals. **AUTO** toggles between the Auto and Manual mode. The current operating mode is shown in the Information Area.

To optimize trigger level and slope manually:

1. Repeatedly push **BACK** until all menus and secondary button bars close.
2. Push **F2** to enable and use **⏏▲▼** to set the Trigger level and slope adjustment.

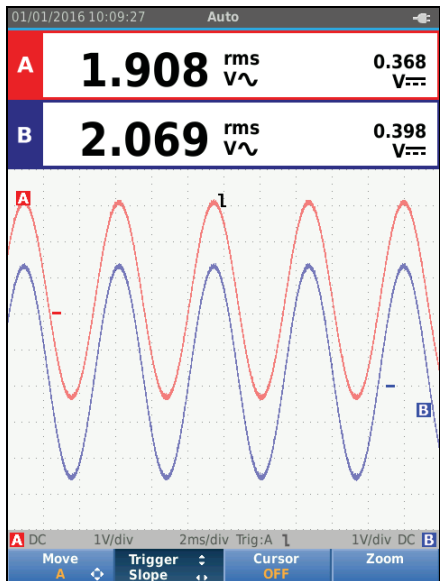

- Use  to adjust the Trigger level continuously. Observe that the trigger icon on the third time division line indicates the trigger level.
- Use  for Trigger on either positive slope or negative slope of the chosen waveform.



hxv21.eps

Select Trigger Parameters

To trigger on the Input A waveform and configure the auto range trigger for waveforms down to 1 Hz:

- Push  to open the Scope and Meter button bar.
- Push  to open the SCOPE SETTINGS menu.

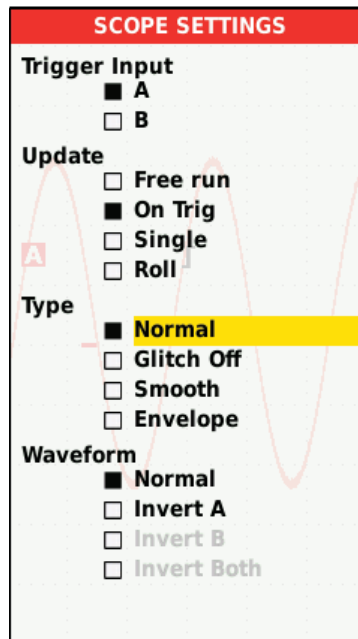

hxv22.eps

3. Push **ENTER** to highlight A in the Trigger Input group.
4. Use **▲▼** to highlight the Update as **On trig**.
5. Push **ENTER** to make the change.
6. Push **F4** to accept all trigger selections and return to normal measurement.

To autorange on signals down to 1 Hz:

1. Push **MENU** to open the MENU.
2. Use **▲▼** to highlight **USER OPTIONS**.
3. Push **ENTER** to open the USER OPTIONS MENU.
4. Use **▲▼** to highlight **Autoset Settings**.
5. Push **ENTER** to open the USER > AUTOSET MENU.
6. Use **▲▼** to highlight the **Search For Signals** as > 1 Hz.
7. Push **ENTER** to make the change.

8. Push **MENU** to close all menus.

Note

Setting the automatic triggering to >1 Hz will slow down the auto range.

The Information area updates with:

Wait	no trigger found
ON TRIGGER	screen updates only when valid triggers occur

Note

Gray text in a menu or button bar indicates that the function is disabled or the status is not valid.





Cursor Measurements

Cursors allow you to make precise digital measurements on waveforms. Cursors are disabled for 3-phase power measurements.

Horizontal Cursors

Use horizontal cursors to measure the amplitude, high and low value, or overshoot of a waveform.

To use the cursors for a voltage measurement:

1. Repeatedly push **BACK** until all menus and secondary button bars close.
2. Push **F3** to select CURSOR ON.
3. Push **F1** to select . Observe that two horizontal cursor lines are shown on the screen.
4. Push **F2** to select the upper cursor.
5. Use   to move the position of the upper cursor on the waveform.
6. Push **F2** to select the lower cursor.
7. Use   to move the position of the lower cursor on the waveform.

Note

Even when the key labels are not displayed at the bottom of the screen, you can still use the arrow keys.

The readout shows the voltage difference between the two cursors and the voltages at the cursors in relation to the zero icon (-).

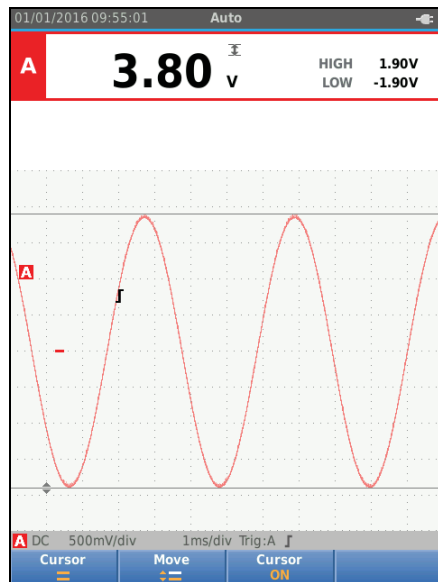

hxv23.eps

Vertical Cursors

Use vertical cursors to measure the time difference “t” between the cursors and the voltage difference between the two markers.

To use the cursors for a time measurement:

1. Push **F3** to select CURSOR ON.
2. Push **F1** to select **II**. Observe that two vertical cursor lines are shown on the screen. Markers (-) identify the point where the cursors cross the waveform.
3. Push **F2** to select the left cursor.
4. Use **←** to move the position of the left cursor on the waveform.
5. Push **F2** to select the right cursor.
6. Use **←** to move the position of the right cursor on the waveform.

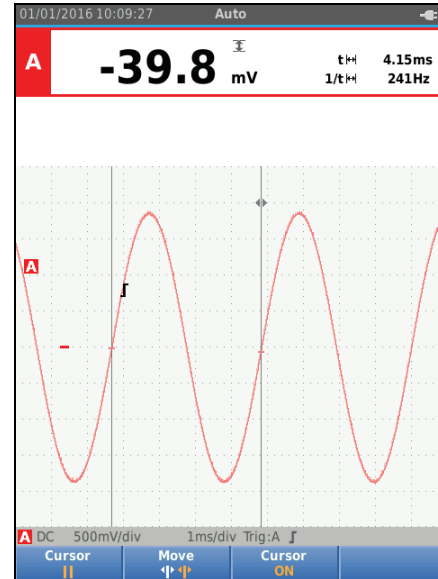

hxv24.eps

Rise Time Measurements

To measure rise time:

1. Push **F3** to select CURSOR ON.
2. Push **F1** to select \updownarrow (rise time). Observe that two horizontal cursors are displayed.
3. Push **F4** if only one trace is displayed and select MANUAL or AUTO. AUTO automatically does steps 5 to 7. For two traces, select the required trace A or B.
4. Use \blacktriangleleft \blacktriangleright to move the upper cursor to 100% of the trace height. A marker is shown at 90%.
5. Push **F2** to select the other cursor.
6. Use \blacktriangleleft \blacktriangleright to move the lower cursor to 0% of the trace height. A marker is shown at 10%.

The reading now shows the risetime from 10%-90% of the trace amplitude and the voltage at the cursors in relation to the zero icon (-).

7. Push **F3** to disable the cursors.

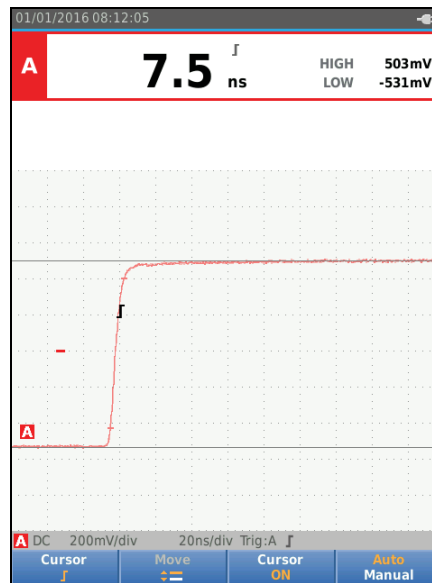

hvx25.eps

High Frequency Measurements with 10:1 Probe







Fluke recommends the VP41 10:1 Probe to measure high frequency signals in circuits with high impedance. The loading of the circuit by a 10:1 Probe is much lower than that of a 1:1 Shielded Test Lead.

Probe attenuation and probe adjustment must be observed when using a 10:1 Probe.

Probe Attenuation

The Probe attenuates the signal 10X. The example below is for a Probe connected to input A.

To adapt the Test Tool's voltage readout to this attenuation:

1. Push  to open the Scope and Meter button bar.
2. Push  to open the INPUT SETTINGS menu.
3. Use  to go to **Select>**.
4. Push  to open the PROBE SELECT menu.
5. Use  to highlight **10:1 V**.
6. Push  to make the change.

Observe that the 10X attenuation of the Probe is compensated in the voltage readout.

Probe Adjustment

The VP41 Probe is always adapted correctly to its inputs. High frequency adjustment is not necessary.

Other 10:1 Probes however must be adjusted for optimal High Frequency performance. See *10:1 Scope Probes* for information about how to adjust these Probes.

Power and Harmonics Mode

The Power and Harmonics mode offers:

- Single phase power measurements with waveform and harmonics display
- Voltage RMS, Current RMS, frequency, and phase measurements
- Active, apparent, and reactive power measurements
- Power factor, $\cos \phi$, and total harmonic distortion measurements

This section is a step-by-step introduction to power and harmonics measurements. It does not cover all of the capabilities of the Test Tool but gives basic examples to show how to use the menus and perform basic operations.

To use the power and harmonics functions, connect the voltage leads and current probe as shown in Figure 7 setup 2.

To select the power and harmonics mode:

1. Push **MENU** to open the SETTINGS menu.
2. Use **▲▼** to highlight **POWER HARMONICS**.
3. Push **ENTER** to open the Ampere Probe on B SETTINGS menu.

If the voltage probe on A and current probe on B have not been selected before, complete Step 4 to Step 10.

4. Push **F3** to select the probe settings.

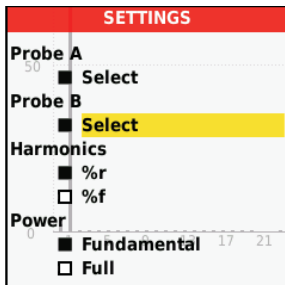

hvx26.eps

5. Use **▲▼** to highlight **SELECT...** in Probe A group.
6. Push **ENTER** to open the Probe A menu.
7. Use **▲▼** to highlight the Probe A type.
8. Push **ENTER** to make the change.
9. Push **F3** to select the probe settings.
10. Use **▲▼** to highlight the Probe B (current clamp) type.
11. Push **ENTER** to make the change.

Other settings stay the same.

Volts/Amps/Watt Measurements

This function simultaneously shows the voltage and current signal. Use this function to get a first impression of the voltage and current signal before you examine the signal in more detail with the other functions.

To select the type of measurement:

1. Push **F2** to select the waveform display.
2. Push **F1** to toggle between the Voltage/Current or Power readings.

Table 4 is a list of the visible readings when Voltage/Current is selected.

Table 4. Volt/Amp Readings

	
hxv27.eps	
Symbol	Description
rms V~	Voltage AC value on channel A
Hz	Frequency of voltage signal on channel A
rms A~	Current AC value on channel B
A<B Deg	Phase angle between voltage on channel A and current on channel B

Table 5 is a list of the visible readings when Power is selected.

Table 5. Watt Readings

	
hxv28.eps	
Symbol	Description
KW	Active power in Watt
VA	Apparent power in Volt Ampere
VAR	Reactive power in Volt Ampere
Hz	Frequency
PF	Power factor. The ratio between active power and apparent power.

Harmonics Measurements

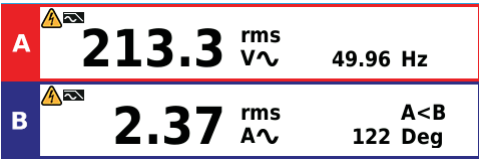
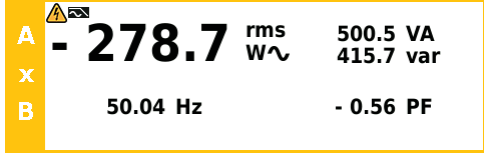
Harmonics are periodic distortions of voltage, current, or power sine waves. A waveform can be considered a combination of various sinewaves with different frequencies and magnitudes. The contribution of each component to the full signal is measured.

Harmonics power distribution systems are often caused by non-linear loads such as switched mode DC power supplies in computers, TVs, and adjustable speed motor drives. Harmonics can cause transformers, conductors, and motors to overheat.

In the Harmonics function, the Test Tool measures harmonics to the 51st. Related data such as DC components, THD (Total Harmonic Distortion), and K factor are measured.

You can display the harmonics of:

- Voltage measurements on Input A
- Current measurements on Input B
- Power measurements calculated from Voltage measurements on Input A and Current measurements on Input B.

In the Harmonics mode the Test Tool always uses the AUTO mode. The vertical sensitivity range and the time base range are automatically adjusted to the most suitable range for the applied input signal. The ranging keys (mV / V / TIME s ns) and (AUTO) are locked.

Input A is forced to measure voltage. Input B is forced to measure current.

To make harmonics measurements:

1. Push (F2) to select the harmonics display.
2. Push (F1) to toggle between the voltage, current or power readings.
3. Push (F4) to turn on the cursor.

When the harmonics display with voltage measurements is selected, the screen shows as in Table 6. For harmonics display when current measurements are selected, see Table 7. For harmonics display when watts measurements are selected, see Table 8.

Table 6. Harmonics Voltage Measurements

	Readout	Description
 <p style="text-align: right; font-size: small;">hvx29.eps</p>	rms V AC	Voltage AC value on channel A
	THD %f	THD is the amount of harmonics in a signal as a percentage of the total RMS value (THD%r) or as a percentage of the fundamental (THD%f). It is a measure of the degree to which a waveform deviates from a purely sinusoidal form. 0% indicates that there is no distortion. You can select THD%r or THD%f in the Settings menu (F3).
	Nr (3)	The harmonics component as selected with the cursor. Use ↔ to move the cursor. In the example screen this is the third harmonic. The values to the right of this number will change when the cursor is moved to another harmonic component.
	V	Voltage of the harmonic component as selected by the cursor.
	%f	The amount of the selected harmonic component in the voltage signal as a percentage of the total RMS value (THD%r) or as a percentage of the fundamental (THD%f). You can select %r or %f in the Settings menu (F3).
	Deg	The phase angle between the harmonic component and the fundamental voltage.

Table 7. Harmonics Current Measurements

Readout	Description
Rms AAC	Current AC value on channel A
THD %f	THD is the amount of harmonics in a signal as a percentage of the total RMS value (THD%) or as a percentage of the fundamental (THD%f). It is a measure of the degree to which a waveform deviates from a purely sinusoidal form. 0 % indicates that there is no distortion. You can select THD%r or THD%f in the Settings menu (F1).
KF	K-Factor indicates the losses in transformers due to harmonic currents.
Nr (3)	The harmonics component as selected with the cursor. Use ↔ to move the cursor. In the example screen this is the third harmonic. The values to the right of this number will change when the cursor is moved to another harmonic component.
A	Current of the harmonic component as selected by the cursor.
%f	The amount of the selected harmonic component in the current signal as a percentage of the total RMS value (THD%r) or as a percentage of the fundamental (THD%f). You can select %r or %f in the Settings menu (F3).
Deg	The phase angle between the harmonic component and the fundamental current.



hvx30.ep

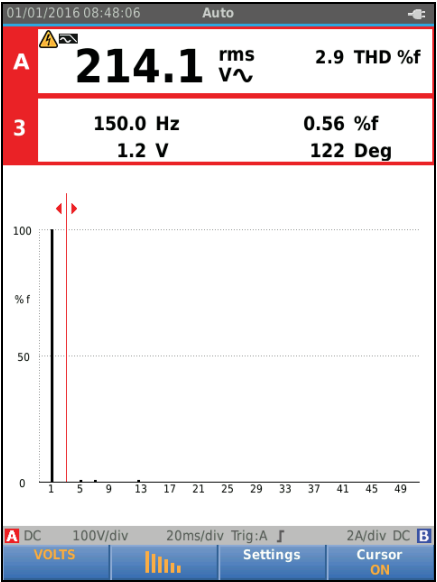
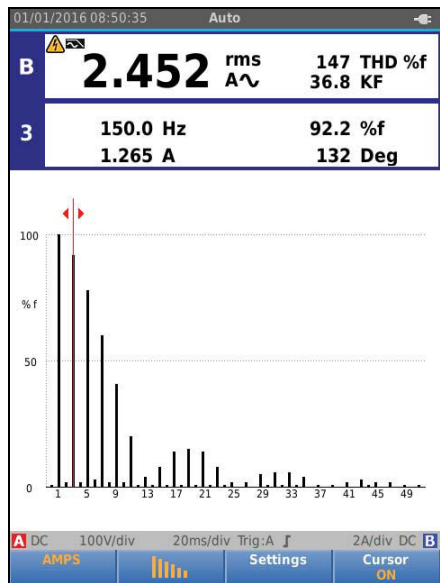

Table 8. Harmonics Power Measurements

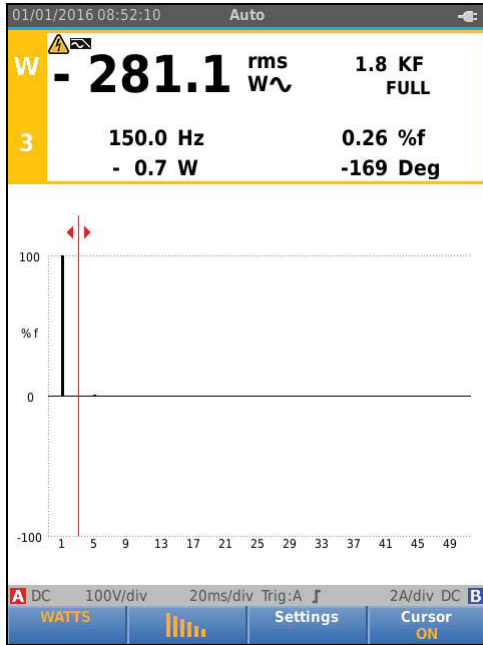
Readout	Description
W	Active power in Watts
KF	K-Factor indicates the losses in transformers due to harmonic currents.
Nr (3)	The harmonics component as selected with the cursor. Use ↔ to move the cursor. In the example screen this is the third harmonic. The values to the right of this number will change when the cursor is moved to another harmonic component.
W	Power of the harmonic component as selected by the cursor.
%f	The amount of the selected harmonic component in the current signal as a percentage of the total RMS value (THD%r) or as a percentage of the fundamental (THD%f). You can select %r or %f in the Settings menu (F1).
Deg	The phase angle between the harmonic component and the fundamental current.



hxv31.ep

Zooming Harmonics

If the harmonics bars screen is shown, you can zoom vertically for a more detailed view. Use   to zoom in or zoom out.

The scale at the left side changes when zooming in or out.

Fieldbus Mode

Fieldbuses are bi-directional, digital, serial control networks used in process control and industrial automation.

The Test Tool can indicate the status of the following aspects of the OSI model Physical Layer:

- Voltage levels (bias, high level, low level)
- Bit width – baud rate
- Rise and fall time
- Distortion

The Test Tool can show the bus signal waveform in the Eye-pattern mode, see page 47.

The Test Tool operates in full automatic (ranging and triggering) mode. Test limits are preset, but can be changed, see page 47.







For supported bus types and protocols see Table 9.

For extended information on Fieldbuses and fieldbus measurement, see Appendix A of this manual.

Note

To check a suspected cable you can make resistance measurements and capacitance measurements using the Scope/Meter mode.



To do fieldbus measurements:

1. Push  to open the MENU.
2. Use   to highlight **BUSHEALTH**.
3. Push  to open the BUS HEALTH menu.
4. Use   to highlight the bus type.

Select **User1** or **User2** to create a customized set of limits to test nonstandard bus systems. See page 48 for information about how to set the test limits.

Default settings are RS232 for User1 and Foundation Fieldbus H1 for User2.

5. Push  to make the change.

For bus types with additional options, a secondary menu is available. Use   to highlight the option and  to make the change.

An example of the screen is shown in Table 10.

6. Connect the inputs as shown in Figure 8, setup 4.

BUS HEALTH
AS-I
CAN Interbus S DeviceNet Modbus RS232 Modbus RS485 Foundation Fieldbus Profibus DP Profibus PA RS232 RS485 User 1 User 2

hxv32.eps

- Use the BB120 Banana-to-BNC Adapter to connect a BNC cable for bus measurements.

You can use the optional BHT190 Bushealth Test adapter to easily connect the probe tip to a bus that uses a DB9, RJ-45, or a M12 connector.

Table 9. Bus Measurement Inputs

Bus	Subtype	Input		Advised Probe
		A	B	
AS-i		x	-	STL120
CAN		x	x	STL120
Interbus S	RS-422	x	-	VP41
DeviceNet		x	x	STL120
Modbus	RS-232	x	-	STL120
	RS-485	x	x	STL120
Foundation fieldbus	H1	x	-	STL120
Profibus	DP/RS-485	x	x	STL120
	PA/31.25 kBit/s	x	-	STL120
RS-232		x	-	STL120
RS-485		x	x	STL120

How to Read the Screen

The bus test screen shows the status of the various signal properties. To open, go the main screen and push **F3**. Information is represented in four columns, see Table 10.

Table 10. Field Bus Test Screen

Item	Description
A	Signal property under test, for example, VHigh. Rows show each signal property and corresponding data. See Table 11 for a description of the signal properties for the bus types.
B	Status indicator. See Table 12 for a description of the indicators.
C	Most recent measurement value, for example, 3.5 V. --- indicates that no reading is available OL indicates that the signal is out of the measurement range (overload)
D	Used low (LOW) and high (HIGH) test limits (LIMIT), for example 18.5 31.6V. LIMIT * The * indicates that one or more of the limits are not set to the default value. N/A The limit does Not Apply to this bus type.

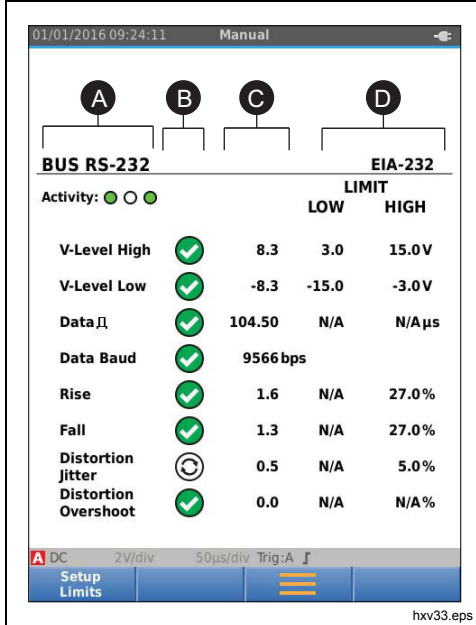

Table 11. Test Signal Properties

Property	Explanation	Property	Explanation
VBias	Bias voltage	CAN-Rec. L	CAN-recessive low level voltage
CAN-Rec. H-L	CAN-recessive high to low level voltage	V High	High level voltage
CAN-Rec. H	CAN-recessive high level voltage	Vpk-pk	Peak to peak voltage
V-Level High-Bias	High level to bias level voltage	V Low	Low level voltage
V-Level Bias-Low	Bias level to low level voltage	V-Level pk-pk	Peak to peak voltage
CAN-DOM. H-L	CAN-dominant high to low level voltage	V-level high	High level voltage
CAN-DOM. H	CAN-dominant high level voltage	V-level low	Low level voltage
CAN-DOM. L	CAN-dominant low level voltage		
Data 	Bit width	Data Baud	Baud rate
Rise	Rise time as % of bit width		
Fall	Fall time as % of bit width		
Distortion Jitter	Jitter distortion	Distortion Amplitude	Amplitude distortion (AS-i bus)
Distortion Overshoot	Signal distortion, over- and undershoot		

Table 12. Bus Test Screen Indicators

Indicator	Description	
○○○	Bus activity indicators	
1 ○ ○ ○	Bus activity indicator 1:	
	● (filled)	voltage measured
	○ (open)	no voltage measured
○ ○ ○ 2 3	Bus activity indicators 2 and 3:	
	○ ○ (both open)	no activity
	* * (blinking)	activity
⌚	Busy, the Test Tool is measuring/processing data.	
⋯	No reading available.	
✔	Test OK. Measurement results are within 80% of allowable range, see Figure 12.	
⚠	Warning. Measurement results are between 80% and 100% of allowable range, see Figure 12.	
✘	Test failed. Measurement results are out of allowable range, see Figure 12.	

Figure 12 shows the bus health indicator boundaries. The high level voltage of a bus must be between +3.0 V (MIN) and +15.0 V (MAX). Depending on the measurement result, the displayed indicator will be:

- ✔ Result is between 4.2 and 13.8V. (10 % of 12 V = 1.2 V)
- ⚠ Result is between 3 V and 4.2 V, or between 13.8 V and 15 V.
- ✘ Result is <3 V or >15 V.



hvx34.eps

Figure 12. Bus Health Indicator Boundaries

How to View the Bus Waveform Screen

To view the waveform eye pattern of the bus voltage:

1. Push **[F3]**. The screen shows the eye pattern. The screen shows the waveforms of one bit time triggered on a positive, as well as, on a negative edge in persistence mode.
2. Push **[F1]** to clear the persisted waveforms and restart to show the waveform.

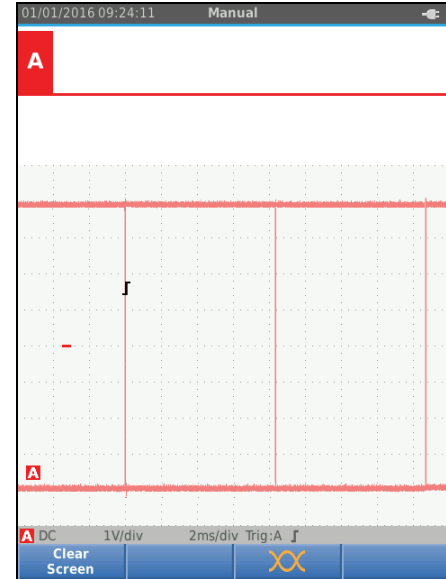

hvx35.eps

3. Push **[HOLD RUN]** to freeze the screen. Push **[HOLD RUN]** again to clear the persistence waveform and restart the waveform eye pattern.

Test Limits

The test limits apply to the selected bus type. To change the test limits:

1. Push **MENU** to open the MENU.
2. Use **▲▼** to highlight **BUSHEALTH**.
3. Push **ENTER** to open the BUS HEALTH menu.
4. Use **▲▼** to highlight the bus type.

Select **User1** or **User2** to create a customized set of limits to test nonstandard bus systems.

Default settings are RS232 for User1 and Foundation Fieldbus H1 for User2.

5. Push **ENTER** to make the change.
6. From the BUSHEALTH main screen, push **F1** to open the SETUP LIMITS menu. The header shows the bus type.
7. Use **▲▼◀▶** to highlight the property for the limit.

Note

Use **F2** to set all limits to the default setting.

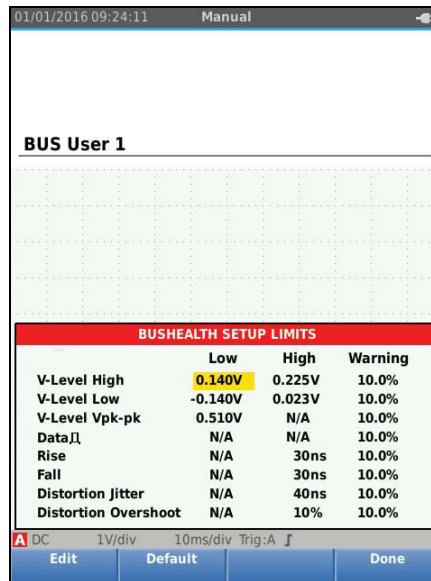

hxv36.eps

8. Edit the limit.

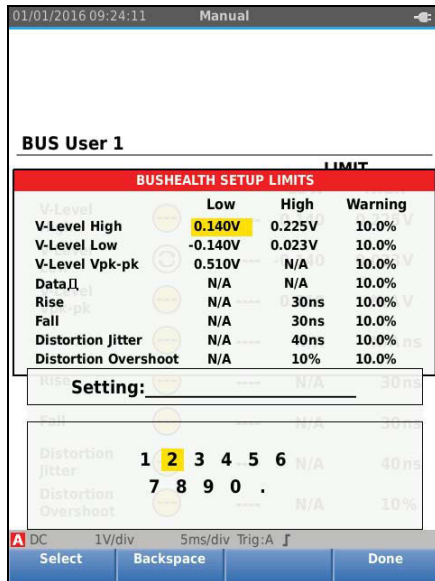

hxv37.eps

An asterisk (*) in the SETUP LIMITS screen indicates that a signal property has limits that differ from the default setting.

9. Push **F3** to select N/A if a limit should not be involved in the test.

10. Push **F4** to accept the limits and return to the test screen.

In the test screen the text **LIMIT** will be followed by an * if any of the limits is not the default limit.

Note

Changed limits persist until a new change is made or the Test Tool is reset.

Recorder Mode

The Test Tool offers recording and logging functionality:

- Meter Recorder to log meter readings over a long period of time.
- Scope Recorder to continuously log waveforms for a long period of time without time gaps (as is the case in Scope and Meter mode).

The Meter Recorder makes the Test Tool act as a paperless recorder that collects a series of parameter measurements over time and shows the result as a graph or a trend-line on screen. This is most useful to understand the change of individual parameters over time or the influence of environmental changes like temperature over time.

The Scope Recorder captures waveforms. The applied input voltage is registered over time and the resulting waveform is stored in a long memory record. This can be used to capture intermittent problems. Deviations from the original signal are stored as events that can be easily viewed after recording without the need to check all information.

Start and Stop Meter Recording

Before you record, apply a stable signal to input A and B.

To set the parameters for recording:

1. Push **RECORD** to open the Recorder button bar.
2. Push **F1** to open the RECORDING SETTINGS menu.

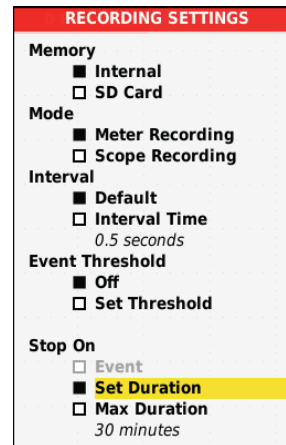

hvx38.eps

3. Use **▲▼** to highlight **Set Duration**.
4. Push **ENTER** to open the RECORDER SETTINGS > DURATION menu.

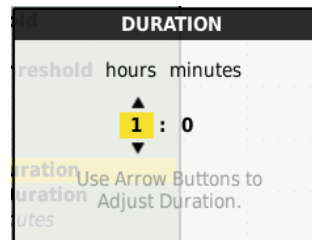

hvx39.eps

5. Use **▲▼** and **ENTER** to enter the time in hours and minutes.
Events are used to determine how often the measured reading deviates from the initial reading when recording starts. It is easy to see the time of a deviation when you view the recording after it stops.
6. Use **▲▼** to highlight **Set Threshold**.
7. Push **ENTER** and use **▲▼** and **ENTER** to enter the percentage deviation for meter readings.
8. Use **▲▼** to highlight the memory type for recording as either the internal memory of the Test Tool or an SD memory card.
9. Push **ENTER** to accept the memory location.
10. Push **F4** when done.
11. To start or stop a recording, push **HOLD RUN** or **F4**.

The Test Tool continuously logs all readings to memory and displays these as graphs. When both input A and input B are on, the upper graph is input A.

Note

The Test Tool beeps when an event occurs. If no event is specified, a beep happens when a new minimum or maximum value is detected.

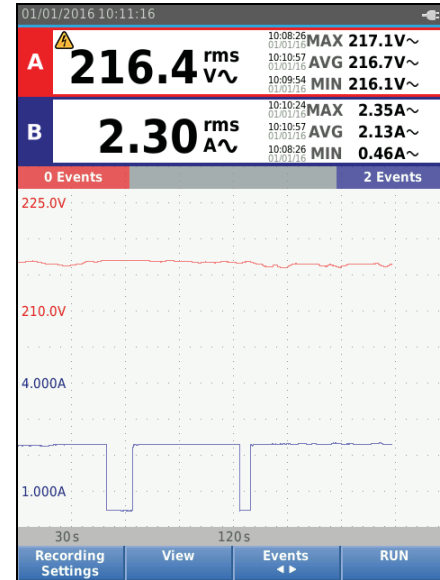

hvx40.eps

The Recorder shows a graph derived from the MAIN readings.

The other readings show the average (AVG), the minimum (MIN), and the maximum (MAX) reading since the Recorder start and the time of the most recent change of a value.

Cursor Measurements

Use the cursor to make precise digital measurements on the plotted graphs. The display shows the measurement results, the date, and the time at the cursor position. Each result is a maximum and a minimum measurement.

To use cursors:

1. Push **HOLD RUN** to stop the graph update and freeze the screen.
2. Push **F2** to open the RECORDING VIEW menu.
3. Use **▲ ▼** to highlight Cursor **On**.
4. Push **ENTER** to accept the change.
5. Push **F4** to exit the menu.
6. Use **← →** to move the cursors.

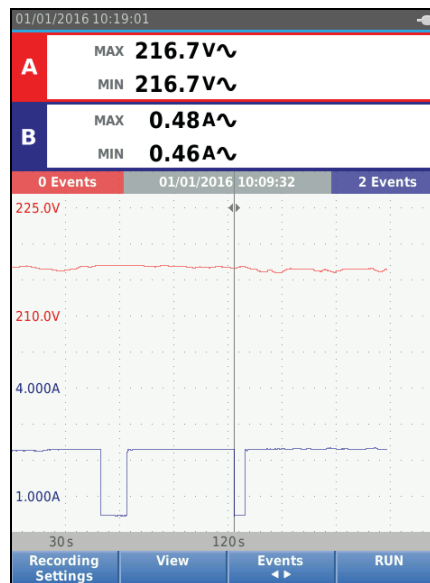

hvx41.eps

The readings show a minimum and maximum value. These are the minimum and maximum values of the readings for the time period that represents one pixel on the display.

Zoom In/Out on Logged Meter Data

By default, the display shows a compressed view of all the data with minimum and maximum pairs for the interval that corresponds with one pixel on the display.

To view uncompressed data in the normal view:

1. Push **F2** to open the RECORDING VIEW menu.
2. Use **▲▼** to highlight **View Normal**.
3. Press **ENTER** to accept the change.

To zoom in or zoom out on the logged data in normal view, push **TIME**. This button is a rocker switch. Use the left (s) end to zoom in. Use the right end (ns) to zoom out. When a cursor is on, zoom is centered on the area around the cursor.

Events

Deviations from the initial readings specified in the Recorder Settings menu as a percentage, are marked as events.

To jump between the start of discrete events:

1. Push **F3** to select **Events < >**.
2. Use **⏪** to jump between events. The readings on the top positions will mark the value at the start of the event.

Scope Record Mode

The Scope Record mode shows all the waveform data as a long waveform of each active input. This display mode can be used to show intermittent events. Because of the deep memory, recording can be done for a long period. The Test Tool stores 1 sample/channel for each sample time. Defining event thresholds allows you to quickly view details of the signal that deviate from the normal signal.

Cursor Measurements, Zoom, and Events are available in the Scope Record mode.

Before you record, apply a stable signal to input A and input B.

To set the parameters for Scope Record:

1. Push **RECORD** to open the Recorder button bar.
2. Push **F1** to open the RECORDING SETTINGS menu.
3. Use **▲▼** to highlight **Scope Recording**.
4. Push **ENTER** to accept the change.
5. Use **▲▼** to highlight **Set Duration**.
6. Push **ENTER** to open the DURATION menu.

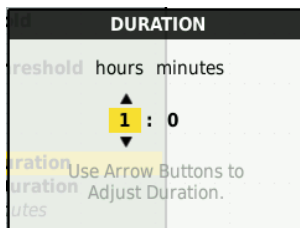

hvx39.eps

7. Use **▲▼** and **▶◀** and **ENTER** to set the time.

Events are used to determine how often a waveform deviates from the initial waveform when recording starts. It is easy to see the time of a deviation when you view the recording after it stops.

8. Use **▲▼** to highlight **Threshold**.
9. Push **ENTER** and use **▲▼** and **ENTER** to set the percentage of deviation for time (relative to 1 period) and the amplitude deviation (relative to peak-to-peak) for waveforms. Threshold can be used for signals up to 10 kHz.
10. Use **▲▼** to highlight the memory type for recording as either the internal memory of the Test Tool or an SD memory card.
11. Push **ENTER** to accept the memory location.
12. Push **F4** when done.

13. To start or stop a recording, push **HOLD RUN** or **F4**.

The Test Tool continuously logs all data to memory. While recording, the display does not update since all the processing capacity is needed for recording.

Note

The Test Tool beeps when an event occurs.

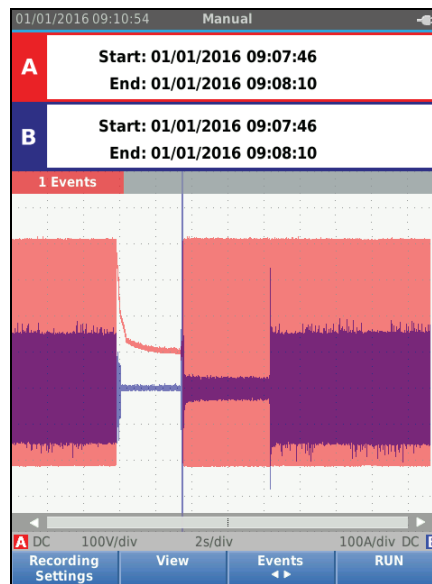

hvx42.eps

Save and Recall Data Sets

The Test Tool has 20 internal data memory locations. In each memory location you can save a data set in Scope and Meter mode.

A data set consists of the screen data, the waveform data, and the Test Tool setup.

To save a data set:

1. Push **MENU** to open the menu.
2. Push **F2** to open the SAVE menu.

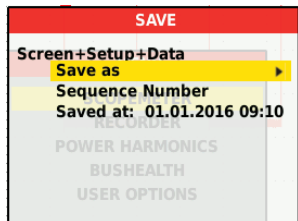

hxv43.eps

3. Push **F1** to toggle between save to **Internal** memory or **SD Card** memory.
4. Use **▲▼** to highlight **Save as...**
5. Push **ENTER** open the Save as menu. Use this menu to name the data set.

You can change the name or save the data set to the default name.

To change the name of the data set:

1. Use **▶◀▲▼** and **F1** to select the characters for the name. **F2** is the backspace to redo a character. **F3** toggles between upper case and lower case characters.
2. Push **F4** to accept the name and exit the menu.

As an option, a sequence number can be set for the stored data set. The number determines the position in the test sequence.

To change the sequence number:

1. Use **▲▼** to highlight **Sequence Number**.
2. Push **ENTER** open the Sequence menu.
3. Use **▶◀▲▼** and **F1** to select the characters for the sequence number. You can also select **None** as the option for sequence number.
4. Push **F4** to accept the number and exit the menu.

If no free memory locations are available, a message pops up for you to overwrite the oldest data set.

To continue:

1. Push **F3** to cancel the overwrite to the oldest data set. You must delete one or more memory locations and then save again. See *Data Set Management* for more information.
2. Push **F4** to overwrite the oldest data set.

Test Sequence

Use test sequences to set up the Test Tool for the most often-used settings or a sequence of frequent tests.

To recall a setting marked with a test sequence number:

1. Push **MENU** to open the menu.
2. Push **F1** to open the TEST SEQUENCE menu.
3. Use **▲▼** to highlight the setup. The selected test sequence number is automatically the next number after a previously selected number and helps you do a sequence of tests. No cursor keys need to be used.
4. Push **ENTER** to accept the setup.

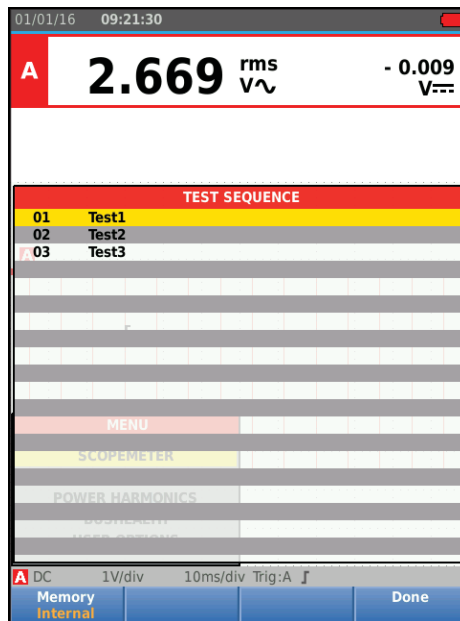

hxv44.eps

Only the data sets stored as a test sequence number are visible in the TEST SEQUENCE menu. Other data sets are visible when you select **F3** (Recall).

Setting Recall

To recall a setting:

1. Push **MENU** to open the menu.
2. Push **F3** to open the RECALL MEMORY menu.
3. When an SD card is installed, use **F1** to toggle between Internal or SD card memory.
4. Use **▲▼** to highlight the setting.
5. Push **ENTER** to accept the setting.

Data Set Management

You can copy, move, rename, and delete a data set.

To manage the data set:

1. Push **MENU** to open the menu.
2. Push **F4** to open the MEMORY menu.
3. When an SD card is installed, use **F1** to toggle between Internal or SD card memory.
4. Use **▲▼** to highlight the memory location.
5. Push **F3** to open the Action button bar. Use the corresponding function key for the copy, move, rename, and delete actions.

Waveform Comparison

Use Recall to easily compare the A and B waveforms with previously measured waveforms. You can compare a waveform of one phase with a waveform of another phase or compare with a previously measured waveform on the same test point.

To recall a reference waveform:

1. Push **MENU** to open the menu.
2. Push **F3** to open the RECALL MEMORY menu.
3. When an SD card is installed, use **F1** to toggle between Internal or SD card memory.
4. Push **F2** to select the Setup and Waveform menu.
5. Use **▲ ▼** to highlight the memory location.
6. Push **ENTER** to select the Setup and reference waveform.

The reference waveform shows on the screen as gray. The reference waveform remains on screen until a setting, such as auto/manual, attenuation, or timebase, is changed.

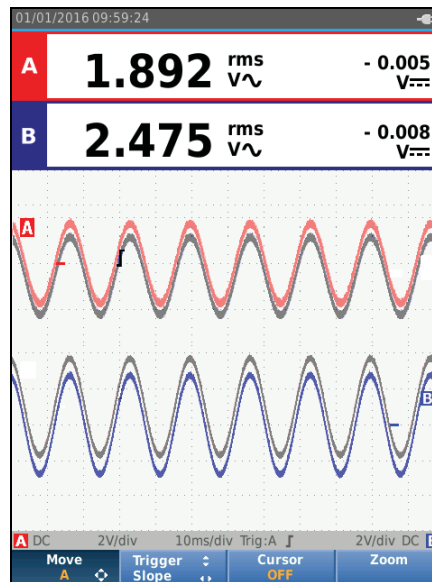

hxv45.eps

Communication

The Test Tool can communicate with:

- PC or laptop that uses FlukeView® ScopeMeter® software with an optical cable or wireless interface
- Tablet or smartphone using Fluke Connect with WiFi interface

Optical Interface

Connect the Test Tool to a computer with a wired connection that uses FlukeView® ScopeMeter® software for Windows®. Use the Optically Isolated USB Adapter/Cable (OC4USB) to connect a computer to the OPTICAL PORT of the Test Tool.

For more information about FlukeView® ScopeMeter® software, see the FlukeView documentation.

Wireless Interface

You can connect the Test Tool with a WiFi USB Adapter to a computer, tablet, or smartphone that has a wireless LAN interface.

To support wireless communication the Test Tool has a port that can be used to insert a WiFi USB adapter. The USB port is behind the battery door. See Figure 13.

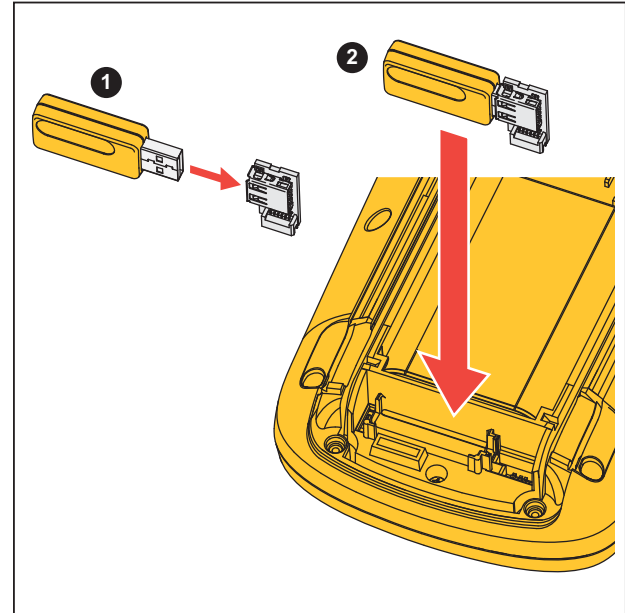

hvx52.eps









Figure 13. WiFi USB Adapter

The battery door must be closed to operate the USB port. A small angled connector is delivered with all versions of the Test Tool to connect the adapter to the connector behind the battery door.

⚠ Caution



Do not use the USB port to directly communicate with an external device.

To set up the Test Tool for use with a wireless connection:

1. Push  + to turn on the WiFi.  shows in the Information area.
2. For the first-time setup, push  to open the Menu.
3. Use   to highlight **USER OPTIONS**.
4. Push  to open the USER OPTIONS menu.
5. Use   to highlight **Information**.
6. Push  to open the INFORMATION menu.
7. Push to open the WiFi Settings menu.

The menu shows:

- WiFi name. The SSID is used to detect the Test Tool WiFi.
- IP Address. Additional information about the connection and not required to establish a connection.

Push  + to turn off WiFi.  disappears from the top of the screen in the Information area.

⚠⚠ Warning

To prevent personal injury and for safe operation of the Product:

- Have an approved technician repair the Product.
- Use only specified replacement parts.
- Before carrying out any maintenance, carefully read the safety information at the beginning of this manual.
- Do not operate the Product with covers removed or the case open. Hazardous voltage exposure is possible.
- Remove the input signals before you clean the Product.

How to Clean

Clean the Test Tool with a damp cloth and a mild soap. Do not use abrasives, solvents, or alcohol. These may damage the text on the Test Tool.

Storage

If you store the Test Tool for an extended period of time, charge the Lithium-ion batteries before storage.

Battery Replacement

⚠⚠ Warning

To prevent possible electrical shock, fire, or personal injury and for safe operation and maintenance of the Product:

- Batteries contain hazardous chemicals that can cause burns or explode. If exposure to chemicals occurs, clean with water and get medical aid.
- Use only the Fluke BP290 as a replacement battery.
- Do not disassemble the battery.
- Repair the Product before use if the battery leaks.
- Use only Fluke approved power adapters to charge the battery.
- Do not short the battery terminals together.

- **Do not disassemble or crush battery cells and battery packs.**
- **Do not keep cells or batteries in a container where the terminals can be shorted.**
- **Do not put battery cells and battery packs near heat or fire. Do not put in sunlight.**

To avoid loss of data, do one of the following before you remove the battery pack:

- Store the data on a computer or a USB device.
- Connect the power adapter.

To replace the battery pack:

1. Turn off the Test Tool.
2. Remove all probes and test leads
3. Unlock the battery cover.
4. Lift the battery cover and remove it from the Test Tool.
5. Lift one side of the battery pack and remove it from the Test Tool.
6. Install a good battery pack.
7. Place the battery cover into position and lock.



10:1 Scope Probes

The 10:1 voltage probe (VP41) that is supplied with the Test Tool (varies by model) is always adjusted correctly and needs no further adjustment. You need to adjust other 10:1 scope probes for optimal response.

Warning

To prevent possible electrical shock, fire, or personal injury, use the BB120 Banana-to-BNC adapter (delivered with the Test Tool) to connect a 10:1 scope probe to the input of the Test Tool.

To adjust probes:

1. Connect the 10:1 scope probe from the blue input B jack to the red input A jack.
2. Use the red 4-mm banana adapter (delivered with the probe) and the banana-to-BNC adapter (BB120). See Figure 14.
3. Push **MENU** to open the Menu.
4. Use   to highlight **USER OPTIONS**.
5. Push **ENTER** to open the USER OPTIONS menu.

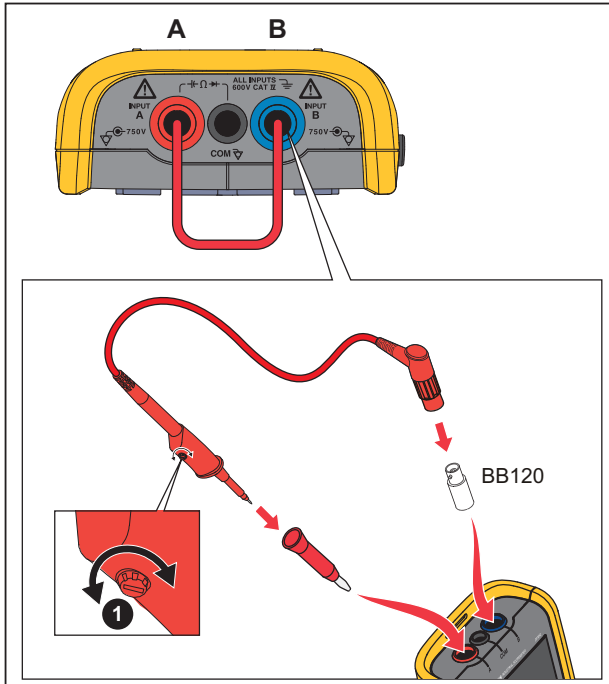

hvx53.eps

Figure 14. 10:1 Scope Probes

6. Use **▲▼** to highlight **Probe Adjust**.

7. Push **ENTER** to open the PROBE ADJUST menu.

A square wave appears on the screen.

8. Adjust the trimmer screw **1** in the probe housing to give an optimum square wave.

9. Push **F4** to exit the menu.

Calibration Information

The Test Tool specifications are based on a 1 year calibration cycle. Recalibration must be done by qualified personnel. Contact your local Fluke representative for more information about recalibration.

To find the firmware version and calibration date of your Test Tool:

1. Push **MENU** to open the Menu.

2. Use **▲▼** to highlight **USER OPTIONS**.

3. Push **ENTER** to open the USER OPTIONS menu.

4. Use **▲▼** to highlight **Information**.

5. Push **ENTER** to open the INFORMATION menu.

The User Information menu screen has information about the model number with firmware version, the serial number, the calibration number with latest calibration date, installed (firmware) options, and memory usage information.

6. Push **F4** to exit the menu.

Table 13. Replaceable Parts and Accessories

Item (see Figure 1)	Description	Order Code
①	Fluke Test Tool	
②	Rechargeable Li-ion Battery Pack	BP290
③	Switch Mode Power Supply, Adapter/Battery Charger	BC430/820
④	Set of two Shielded Test Leads (Red and Blue), designed for use only with the Fluke ScopeMeter® 120 series Test Tool. Set contains the Ground Lead with Alligator Clip (Black)	STL120-IV
⑤	Test Lead Black (for Grounding)	TL175
⑥	Hook Clips (red, blue)	HC120-II
⑦	See Table 14	
⑧	Safety Information + CD-ROM with Users Manuals	
⑨	VP41 10:1 Voltage Probe with hook clip and ground lead	VPS41
⑩	i400s AC Current Clamp	i400s
⑪	USB Angled Adapter	UA120B
⑫	WiFi USB Adapter	
⑬	See Table 14	
⑭	See Table 14	
⑮	See Table 14	
⑯	See Table 14	

Table 14. Optional Accessories

Item (see Figure 1)	Description	Order Code
not shown	Bushealth Test Adapter: connects the probe tip to busses that use a DB9, RJ-45, or a M12 connector	BHT190
not shown	Software & Cable Carrying Case Kit (Supplied with Fluke 12x/S) Set contains the following parts: <ul style="list-style-type: none"> • Screen Protector ⑯ • Magnetic Hanger ⑭ • Soft Carrying Case ⑬ • FlukeView® ScopeMeter® Software for Windows® ⑮ 	SCC 120B SP120B Fluke-1730-Hanger C120B SW90W
⑦	Banana-to-BNC Adapters (black)	BB120-II (set of two)
⑬	Soft Carrying Case	C120B
⑭	Magnetic Hanger	Fluke-1730-Hanger
⑮	FlukeView® ScopeMeter® Software for Windows®	SW90W
⑯	Screen Protector	SP120B

Tips

This section is information and tips on how to best use the Test Tool.

Battery Life

For battery operation, the Test Tool conserves power by shutting itself down. If you have not pressed a key for at least 30 minutes, the Test Tool turns itself off automatically.

Automatic power shutdown will not occur if Record is on, but the backlight will dim. Recording continues if the battery is low. Retention of memories is not jeopardized.

To save battery life without automatic power shutdown you can use the display AUTO-off option. The display turns off after the selected time (30 seconds or 5 minutes).

Note

If the power adapter is connected, automatic power shutdown and the display AUTO-off function is disabled.

Power Off Timer

By default, the power off timer is set to 30 minutes after the last key press. To change the time to 5 minutes or turn off:

1. Push **MENU** to open the Menu.
2. Use **▲▼** to highlight **USER OPTIONS**.
3. Push **ENTER** to open the USER OPTIONS menu.
4. Use **▲▼** to highlight **Battery Save Options**.
5. Push **ENTER** to open the USER > BATTERY SAVE menu.
6. Use **▲▼** to highlight the preference.
7. Push **ENTER** to accept the change and exit the menu.

Autoset Options

On delivery or after a reset, the Autoset function captures waveforms ≥ 15 Hz and sets the input coupling to DC.

Note

Setting the Auto Set adjust to 1 Hz slows down the Auto Set response. The display shows LF-AUTO.

To configure Auto Set for capturing slow waveforms down to 1 Hz:

1. Push **MENU** to open the Menu.
2. Use **▲▼** to highlight **USER OPTIONS**.
3. Push **ENTER** to open the USER OPTIONS menu.
4. Use **▲▼** to highlight **Autoset Settings**.
5. Push **ENTER** to open the USER > AUTOSET menu.
6. Use **▲▼** to highlight **Search For Signals >1 Hz**.
7. Push **ENTER** to accept the change and exit the menu.

To configure Autoset to maintain the actual input coupling (AC or DC), continue from step 5 above:

6. Use **▲▼** to highlight **Couplings Unchanged**.
7. Push **ENTER** to accept the change and exit the menu.

Grounding Guidelines

⚠⚠ Warning

To prevent possible electrical shock, fire, or personal injury, use only one COM (common) connection ∇ or ensure that all connections to COM ∇ are at the same potential.

Incorrect grounding can cause problems. Use these guidelines for proper grounding:

- Use the short ground leads when measuring DC or AC signals on input A and input B. See Figure 8, item 4 on page 17.
- Use the unshielded black ground lead to COM (common) for Ohm (Ω), Continuity, Diode, and Capacitance measurements. See Figure 7, item 1 on page 16.
- Use of the unshielded ground lead is also possible for single or dual input measurements for waveforms with a frequency up to 1 MHz. This may add some hum or noise to the waveform display due to the unshielded ground lead.

Specifications

Dual Input Oscilloscope

Vertical

Frequency Response

DC Coupled

without probes and test leads
(with BB120)

125B, 124B DC to 40 MHz (-3 dB)

123B DC to 20 MHz (-3 dB)

with STL120-IV 1:1 shielded test leads DC to 12.5 MHz (-3 dB) / DC to 20 MHz (-6 dB)

with VP41 10:1 probe

125B, 124B DC to 40 MHz (-3 dB)

123B (optional accessory) DC to 20 MHz (-3 dB)

AC Coupled (LF roll off):

without probes and test leads <10 Hz (-3 dB)

with STL120-IV <10 Hz (-3 dB)

with VP41 10:1 Probe <10 Hz (-3 dB)

Rise Time, excluding probes, test leads <8.75 ns

Input Impedance

without probes and test leads 1 M Ω //20 pF

with BB120 1 M Ω //24 pF

with STL120 1 M Ω //230 pF

with VP41 10:1 Probe 5 M Ω //15.5 pF

Sensitivity 5 mV to 200 V/div

Analog Bandwidth Limiter 10 kHz

Display Modes A, -A, B, -B

Max. Input Voltage A and B

direct, with test leads, or with VP41 Probe 600 Vrms Cat IV, 750 Vrms maximum voltage.

with BB120..... 600 Vrms

(For detailed specifications, see *Safety*, Figure 15 and Figure 16.)

Max. Floating Voltage, from any

terminal to ground 600 Vrms Cat IV, 750 Vrms up to 400 Hz

Vertical Accuracy $\pm(1\% + 0.05 \text{ range/div})$

Max. Vertical Move ± 5 divisions

Horizontal

Scope Modes Normal, Single, Roll

Ranges

Normal:

Equivalent sampling

125B, 124B 10 ns to 500 ns/div

123B..... 20 ns to 500 ns/div

Real time sampling 1 μ s to 5 s/div

Single (real time)..... 1 μ s to 5 s/div

Roll (real time)..... 1s to 60 s/div

Sampling Rate (for both channels simultaneously)

Equivalent sampling (repetitive signals)..... up to 4 GS/s

Real time sampling

1 μ s to 60 s/div 40 MS/s

Time Base Accuracy

Equivalent sampling $\pm(0.4\% + 0.025 \text{ time/div})$

Real time sampling $\pm(0.1\% + 0.025 \text{ time/div})$

Glitch Detection $\geq 25 \text{ ns @ } 20 \text{ ns to } 60 \text{ s/div}$

Horizontal Move 12 divisions, trigger point can be positioned anywhere across the screen

Trigger

Screen Update Free Run, On Trigger

Source A, B

Sensitivity A and B

@ DC to 5 MHz 0.5 divisions or 5 mV

@ 40 MHz

125B, 124B 1.5 divisions

123B 4 divisions

@ 60 MHz

125B, 124B 4 divisions

123B NA

Slope Positive, Negative

Advanced Scope Functions

Display Modes

Normal Captures up to 25 ns glitches and displays analog-like persistence waveform.

Smooth Suppresses noise from a waveform.

Envelope Records and displays the minimum and maximum of waveforms over time.

Auto Set (Connect-and-View™)

Continuous fully automatic adjustments of amplitude, time base, trigger levels, trigger gap, and hold-off. Manual override by user adjustment of amplitude, time base, or trigger level.

Dual Input Meter

The accuracy of all measurements is within \pm (% of reading + number of counts) from 18 °C to 28 °C.

Add 0.1x (specific accuracy) for each °C below 18 °C or above 28 °C. For voltage measurements with 10:1 probe, add probe uncertainty +1 %. More than one waveform period must be visible on the screen.

Input A and Input B**DC Voltage (VDC)**

Ranges.....	500 mV, 5 V, 50 V, 500 V, 750 V
Accuracy	$\pm(0.5 \% + 5 \text{ counts})$
Normal Mode Rejection (SMR).....	$>60 \text{ dB @ } 50 \text{ or } 60 \text{ Hz } \pm 0.1 \%$
Common Mode Rejection (CMRR)	$>100 \text{ dB @ DC}$ $>60 \text{ dB @ } 50, 60, \text{ or } 400 \text{ Hz}$
Full Scale Reading.....	5000 counts

True RMS Voltages (VAC and VAC+DC)

Ranges.....	500 mV, 5 V, 50 V, 500 V, 750 V
Accuracy for 5 to 100 % of range	
DC coupled	
DC to 60 Hz (VAC+DC)	$\pm(1 \% + 10 \text{ counts})$
1 Hz to 60 Hz (VAC)	$\pm(1 \% + 10 \text{ counts})$
AC or DC coupled	
60 Hz to 20 kHz	$\pm(2.5 \% + 15 \text{ counts})$
20 kHz to 1 MHz	$\pm(5 \% + 20 \text{ counts})$
1 MHz to 5 MHz	$\pm(10 \% + 25 \text{ counts})$
5 MHz to 12.5 MHz	$\pm(30 \% + 25 \text{ counts})$
5 MHz to 20 MHz	
(without test leads or probes)	$\pm(30 \% + 25 \text{ counts})$
AC coupled with 1:1 (shielded) test leads	
60 Hz (6 Hz with 10:1 probe).....	-1.5 %
50 Hz (5 Hz with 10:1 probe).....	-2 %
33 Hz (3.3 Hz with 10:1 probe).....	-5 %
10 Hz (1 Hz with 10:1 probe).....	-30 %

Note

For the total accuracy for AC coupled, add the derating values specified in the table to the table of AC or DC coupled.

DC Rejection (only VAC).....	>50 dB
Common Mode Rejection (CMRR)	>100 dB @ DC >60 dB @ 50, 60, or 400 Hz
Full Scale Reading	5000 counts, reading is independent of any signal crest factor.

Peak

Modes.....	Max peak, Min peak, or pk-to-pk
Ranges	500 mV, 5 V, 50 V, 500 V, 2200 V
Accuracy	
Max peak or Min peak.....	5 % of full scale
Peak-to-Peak	10 % of full scale
Full Scale Reading	500 counts

Frequency (Hz)

Ranges	
125B, 124B	1 Hz, 10 Hz, 100 Hz, 1 kHz, 10 kHz, 100 kHz, 1 MHz, 10 MHz, and 70 MHz
123B.....	1 Hz, 10 Hz, 100 Hz, 1 kHz, 10 kHz, 100 kHz, 1 MHz, 10 MHz, and 50 MHz
Frequency Range in Continuous Autose15 Hz (1 Hz) to 50 MHz

Accuracy

125B, 124B

- @ 1 Hz to 1 MHz $\pm(0.5 \% + 2 \text{ counts})$
- @ 1 to 10 MHz..... $\pm(1.0 \% + 2 \text{ counts})$
- @ 10 to 70 MHz..... $\pm(2.5 \% + 2 \text{ counts})$

123B

- @ 1 Hz to 1 MHz $\pm(0.5 \% + 2 \text{ counts})$
- @ 1 to 10 MHz..... $\pm(1.0 \% + 2 \text{ counts})$
- @ 10 to 50 MHz..... $\pm(2.5 \% + 2 \text{ counts})$

(50 MHz in Autorange)

Full Scale Reading..... 10 000 counts

RPM

Max reading 50.00 kRPM

Accuracy $\pm(0.5 \% + 2 \text{ counts})$

Duty Cycle (PULSE)

Range 2 % to 98 %

Frequency Range in Continuous Autoset 15 Hz (1 Hz) to 30 MHz

Accuracy (Logic or Pulse waveforms)

- @ 1 Hz to 1 MHz $\pm(0.5 \% + 2 \text{ counts})$
- @ 1 MHz to 10 MHz $\pm(1.0 \% + 2 \text{ counts})$

Pulse Width (PULSE)

Frequency Range in Continuous Autoset 15 Hz (1 Hz) to 30 MHz

Accuracy (Logic or Pulse waveforms)

- @ 1 Hz to 1 MHz $\pm(0.5 \% + 2 \text{ counts})$
- @ 1 MHz to 10 MHz $\pm(1.0 \% + 2 \text{ counts})$

Full Scale Reading..... 1000 counts

Amperes (AMP)

with current clamp

Ranges	same as VDC, VAC, VAC+DC, or PEAK
Scale Factors	0.1 mV/A, 1 mV/A, 10 mV/A, 100 mV/A, 400 mV/A, 1 V/A, 10 mV/mA
Accuracy	same as VDC, VAC, VAC+DC, or PEAK (add current clamp uncertainty)

with iFlex clamp

Ranges	20 A/division
Maximum Current	75 A @ 40 Hz to 300 Hz
	Frequency derating: $I * F < 22\ 500\ A*Hz$ @ 300 Hz to 3000 Hz
Accuracy	$\pm (1.5\ % + 10\ counts)$ @ 40 Hz to 60 Hz
	$\pm (3\ % + 15\ counts)$ @ 60 Hz to 1000 Hz
	$\pm (6\ % + 15\ counts)$ @ 1000 Hz to 3000 Hz

Temperature (TEMP) with optional temperature probe

Range	200 °C/div (200 °F/div)
Scale Factor	1 mV/°C and 1 mV/°F
Accuracy	as VDC (add temp. probe uncertainty)

Decibel (dB)

0 dBV	1V
0 dBm (600 Ω /50 Ω)	1 mW referenced to 600 Ω or 50 Ω
dB on	VDC, VAC, or VAC+DC
Full Scale Reading	1000 counts

Crest Factor (CREST)

Range	1 to 10
Accuracy	$\pm(5\ % + 1\ count)$
Full Scale Reading	90 counts

Phase

Modes	A to B, B to A
Range	0 to 359 degrees
Accuracy	
<1 MHz	2 degrees
1 MHz to 5 MHz	5 degrees
Resolution	1 degree

Power (125B)

Configurations	1 phase / 3 phase 3 conductor balanced loads (3 phase: fundamental component only, AUTOSET mode only)
Power Factor (PF).....	ratio between Watts and VA
Range	0.00 to 1.00
Watt.....	RMS reading of multiplying corresponding samples of input A (volts) and input B (amperes)
Full Scale reading	999 counts
VA	V _{rms} x A _{rms}
Full Scale Reading.....	999 counts
VA Reactive (VAR)	$\sqrt{((VA)^2 - W^2)}$
Full Scale Reading.....	999 counts

Vpwm

Purpose.....	to measure on pulse width modulated signals, like motor drive inverter outputs
Principle	readings show the effective voltage based on the average value of samples over a whole number of periods of the fundamental frequency
Accuracy	as V _{rms} for sinewave signals

Input A

Ohm (Ω)

Ranges

125B 50 Ω , 500 Ω , 5 k Ω , 50 k Ω , 500 k Ω , 5 M Ω , 30 M Ω

124B, 123B 500 Ω , 5 k Ω , 50 k Ω , 500 k Ω , 5 M Ω , 30 M Ω

Accuracy $\pm(0.6\% + 5 \text{ counts})$
50 $\Omega \pm(2\% + 20 \text{ counts})$

Full Scale Reading:

50 Ω to 5 M Ω 5000 counts

30 M Ω 3000 counts

Measurement Current 0.5 mA to 50 nA, decreases with increasing ranges

Open Circuit Voltage <4 V

Continuity (CONT)

Beep <(30 $\Omega \pm 5 \Omega$) in 50 Ω range

Measurement Current 0.5 mA

Detection of shorts $\geq 1 \text{ ms}$

Diode

Measurement Voltage

@0.5 mA >2.8 V

@open circuit <4 V

Accuracy $\pm(2\% + 5 \text{ counts})$

Measurement Current 0.5 mA

Polarity + on input A, - on COM

Capacitance (CAP)

Ranges 50 nF, 500 nF, 5 μ F, 50 μ F, 500 μ F

Accuracy $\pm(2\% + 10 \text{ counts})$

123B/124B/125B

Users Manual

Full Scale Reading.....	5000 counts
Measurement Current.....	500 nA to 0.5 mA, increases with increasing ranges

Advanced Meter Functions

Zero Set

Set actual value to reference

Fast/Normal/Smooth

Meter settling time Fast: 1 s @ 1 μ s to 10 ms/div.

Meter settling time Normal: 2 s @ 1 μ s to 10 ms/div.

Meter settling time Smooth: 10 s @ 1 μ s to 10 ms/div.

AutoHold (on A)

Captures and freezes a stable measurement result. Beeps when stable. AutoHold works on the main meter reading, with thresholds of 1 Vpp for AC signals and 100 mV for DC signals.

Fixed Decimal Point..... with attenuation keys.

Cursor Readout (124B, 125B)

Sources

A, B

Single Vertical Line

Average, Min and Max Readout

Average, Min, Max and Time from Start of Readout (in ROLL mode, instrument in HOLD)

Min, Max and Time from Start of Readout (in RECORDER mode, instrument in HOLD)

Harmonics values in POWER QUALITY mode.

Dual Vertical Lines

Peak-Peak, Time Distance and Reciprocal Time Distance Readout

Average, Min, Max and Time Distance Readout (in ROLL mode, instrument in HOLD)

Dual Horizontal Lines

High, Low and Peak-Peak Readout

Rise or Fall Time

Transition Time, 0 %-Level and 100 %-Level Readout (Manual or Auto Leveling; Auto Leveling only possible in Single Channel Mode)

Accuracy

As Oscilloscope Accuracy

Recorder

The recorder captures meter readings in Meter Recorder mode or continuously captures waveform samples in Scope Recorder mode. The information is stored on internal memory or on optional SD card with the 125B or 124B.

The results are displayed as Chart recorder display that plots a graph of min and max values of Meter measurements over time or as a waveform recorder display that plots all the captured samples.

Meter Readings

- Measurement Speedmaximum 2 measurements/s
- Record Size2 M readings for 1 channel (400 MB)
- Recorded Time Span2 weeks
- Maximum number of events1024

Waveform record

- Maximum sample rate400 K sample/s
- Record Size Internal memory400 M samples
- Recorded Time Span internal memory15 minutes at 500 μ s/div
11 hours at 20 ms/div

125B, 124B

- Record Size SD card15 G samples
- Recorded Time Span SD card11 hours at 500 μ s/div
14 days at 20 ms/div

Maximum number of events64 events on 1 channel

Power Quality (125B)

Readings	Watt, VA, VAR, PF, DPF, Hz
Watt, VA, var ranges (auto)	250 W to 250 MW, 625 MW, 1.56 GW
when selected: total (%r)	$\pm(2\% + 6 \text{ counts})$
when selected: fundamental (%f).....	$\pm(4\% + 4 \text{ counts})$
DPF	0.00 to 1.00
0.00 to 0.25	not specified
0.25 to 0.90	± 0.04
0.90 to 1.00	± 0.03
PF	0.00 to 1.00, ± 0.04
Frequency range	10.0 Hz to 15.0 kHz 40.0 Hz to 70.0 Hz $\pm(0.5\% + 2 \text{ counts})$
Number of Harmonics	DC to 51
Readings / Cursor readings (fundamental 40 Hz to 70 Hz)	
V rms / A rms	fund. $\pm(3\% + 2 \text{ counts})$ 31st $\pm(5\% + 3 \text{ counts})$, 51st $\pm(15\% + 5 \text{ counts})$
Watt.....	fund. $\pm(5\% + 10 \text{ counts})$ 31st $\pm(10\% + 10 \text{ counts})$, 51st $\pm(30\% + 5 \text{ counts})$
Frequency of fundamental	$\pm 0.25 \text{ Hz}$
Phase Angle.....	fund. $\pm 3^\circ$... 51st $\pm 15^\circ$
K-factor (in Amp and Watt)	$\pm 10\%$

Field Bus Measurements (125B)

Type	Subtype	Protocol
AS-i		NEN-EN50295
CAN		ISO-11898
Interbus S	RS-422	EIA-422
Modbus	RS-232 RS-485	RS-232/EIA-232 RS-485/EIA-485
Foundation Fieldbus	H1	61158 type 1, 31.25 kBit
Profibus	DP PA	EIA-485 61158 type 1
RS-232		EIA-232
RS-485		EIA-485

Miscellaneous**Display**

Type 5.7-inch color active matrix TFT

Resolution 640 x 480 pixels

Waveform Display

Vertical 10 div of 40 pixels

Horizontal 12 div of 40 pixels

Power

External via Power Adapter BC430/820

Input Voltage 15 V DC to 22 V DC

Power 4.1 W typical

Input Connector 5 mm jack

Internal via Battery Pack BP290

Battery Power Rechargeable Li-Ion 10.8 V

Operating Time 7 hours with 50 % backlight brightness

Charging Time 4 hours with Test Tool turned off, 7 hours with Test Tool turned on

Allowable ambient temperature 0 °C to 40 °C (32 °F to 104 °F) during charging

Memory

Number of internal Data set Memories 20 data sets (each consists of screen, waveforms and setup

SD card slot with optional SD card

with max size 32 GB for recording, 20 memory locations for saving data sets

Mechanical

Size 259 mm x 132 mm x 55 mm (10.2 in x 5.2 in x 2.15 in)

Weight 1.4 kg (3.1 lb) including battery pack

Interface

- Optically isolated USB to PC/laptop Transfer screen dumps (bitmaps), settings and data using OC4USB optically isolated USB adapter/cable, (optional), using FlukeView® ScopeMeter® software for Windows®).
- Optional WiFi Adapter Fast transfer of screen dumps (bitmaps), settings and data to PC/laptop, tablet, smartphone, etc. A USB port is provided for attaching the WiFi Adapter. Do not use the USB port with a cable for safety reasons. The USB port is disabled when the battery door is open.

Environmental

Environmental MIL-PRF-28800F, Class 2

Temperature

- Operating and charging 0 °C to 40 °C (32 °F to 104 °F)
- Operating 0 °C to 50 °C (32 °F to 122 °F)
- Storage -20 °C to 60 °C (-4 °F to 140 °F)

Humidity

- Operating
 - @ 0 °C to 10 °C (32 °F to 50 °F) noncondensing
 - @ 10 °C to 30 °C (50 °F to 86 °F) 95 %
 - @ 30 °C to 40 °C (86 °F to 104 °F) 75 %
 - @ 40 °C to 50 °C (104 °F to 122 °F) 45 %
- Storage
 - @ -20 °C to 60 °C (-4 °F to 140 °F) noncondensing

Altitude

- Operating CAT III 600V 3 km (10 000 feet)
- Operating CAT IV 600V 2 km (6 600 feet)
- Storage 12 km (40 000 feet)

123B/124B/125B

Users Manual

Vibration MIL-PRF-28800F, Class 2

Shock 30 g maximum

Electromagnetic Compatibility (EMC)

International IEC 61326-1: Industrial

CISPR 11: Group 1, Class A

Group 1: Equipment has intentionally generated and/or uses conductively-coupled radio frequency energy that is necessary for the internal function of the equipment itself.

Class A: Equipment is suitable for use in all establishments other than domestic and those directly connected to a low-voltage power supply network that supplies buildings used for domestic purposes. There may be potential difficulties in ensuring electromagnetic compatibility in other environments due to conducted and radiated disturbances.

Emissions that exceed the levels required by CISPR 11 can occur when the equipment is connected to a test object.

Korea (KCC) Class A Equipment (Industrial Broadcasting & Communication Equipment)

Class A: Equipment meets requirements for industrial electromagnetic wave equipment and the seller or user should take notice of it. This equipment is intended for use in business environments and not to be used in homes.

USA (FCC)..... 47 CFR 15 subpart B. This product is considered an exempt device per clause 15.103.

Wireless Radio with Adapter

Frequency Range 2412 MHz to 2462 MHz

Output Power <100 mW

Enclosure Protection IP51, ref: EN/IEC60529

Safety

General.....IEC 61010-1: Pollution Degree 2
MeasurementIEC 61010-2-033: CAT IV 600 V / CAT III 750 V

Max. Input Voltage Input A and B

Direct on input or with leads600 Vrms CAT IV for derating, see Figure 15.
With Banana-to-BNC Adapter BB120300 Vrms for derating, see Figure 16.

Max. Floating Voltage

from any terminal to ground600 Vrms Cat IV, 750 Vrms up to 400 Hz

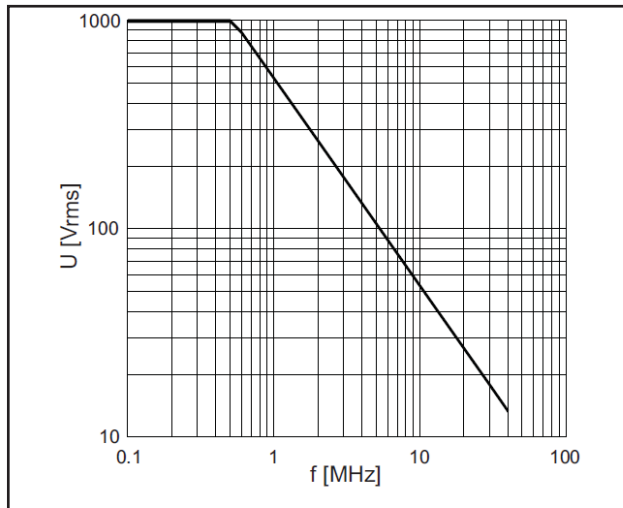

hpp049.eps

Figure 15. Max. Input Voltage vs. Frequency for BB120 and STL120-IV

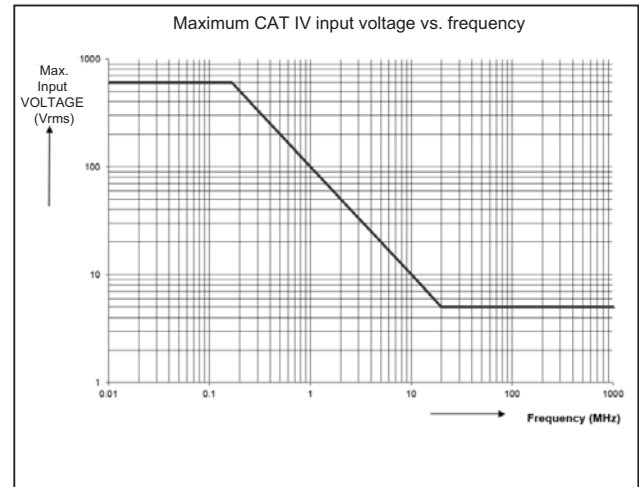

hpp050.ep

Figure 16. Safe Handling: Max. Voltage Between Test Tool Reference and Earth Ground

123B/124B/125B

Users Manual

The Fluke 12xB series, including standard accessories, conforms to the EEC directive 2004/108/EC for EMC immunity, as defined by EN61326-1: 2006, with the addition of the table below.

Trace disturbance with STL120-IV

Frequency	Field strength	No visible disturbance	Disturbance less than 10% of full scale
80 MHz to 1 GHz	10 V/m	1 V/div to 200 V/div	500 mV/div
1.4 GHz to 2 GHz	3 V/m	All ranges	-
2 GHz to 2.7 GHz	1 V/m	All ranges	-

(-) = no visible disturbance

Ranges not specified may have a disturbance of >10 % of full scale.