

# User Manual

**Test Equipment  
Depot**  
1-800-517-8431

99 Washington Street  
Melrose, MA 02176  
Phone 781-665-1400  
Toll Free 1-800-517-8431

Visit us at [www.TestEquipmentDepot.com](http://www.TestEquipmentDepot.com)

**DIGI-SENSE™**

## Data Logging Sound Level Meter

with NIST-Traceable Calibration

### Model 20250-29



THE STANDARD IN PRECISION MEASUREMENT

## **Introduction**

The Digi-Sense Data Logging Sound Level Meter (Model 20250-29) measures sound decibel levels for noise certification and reduction applications. The meter conforms to IEC61672-1 Class 2 standard. Advanced features include data Hold, Max/Min readings, low/medium/high ranges, over and under range, and A and C weighting. The unit offers Fast/Slow response, analog AD/DC outputs, USB connectivity, data logging software, backlight display, and automatic power-off. The instrument is fully tested and calibrated to NIST-traceable standards. Careful use of this meter will provide years of reliable service.

## **Unpacking**

Check individual parts against the list of items below. If anything is missing or damaged, please contact your instrument supplier immediately.

1. Meter
2. Windscreen
3. Earphone plug, 3.5 mm
4. Screwdriver
5. Three AAA batteries
6. USB cable
7. Software
8. User manual
9. NIST-traceable calibration report with data

## **Key Features**

- Wide measurement ranges of 30 to 130 dB
- Precision accuracy of  $\pm 1.4$  dB
- Meets IEC61672-1 Class 2 standard
- User selectable low/medium/high, and auto range measurement levels
- A and C frequency weighting
- Fast and slow time weighting
- Memory of 32,700 readings
- Max/Min and Hold functions
- Over- and under-range indicator
- AC/DC analog outputs
- Data logging software with graphical display
- Download data via USB connectivity
- Large backlit LCD for easy reading
- Low-battery indicator
- Auto power-off after fifteen minutes of nonuse to conserve battery power

## Meter Description

1. Windscreen
2. LCD
3. **REC** button
4. **SETUP** button
5. **FAST/SLOW** button
6. **MAX/MIN** button
7. **LEVEL ▼** button
8. Backlight  button
9. **A/C** frequency weighting
10. **HOLD** button
11. **Power on/off** button
12. External DC 5V power supply terminal
13. USB interface
14. AC/DC signal output earphone outlet
15. Calibration potentiometer
16. Tripod mounting screw
17. Battery cover
18. Microphone

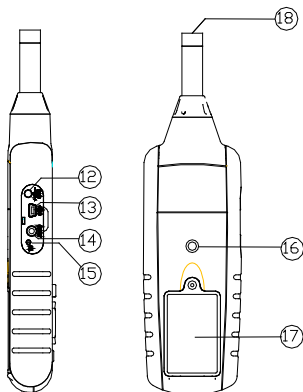
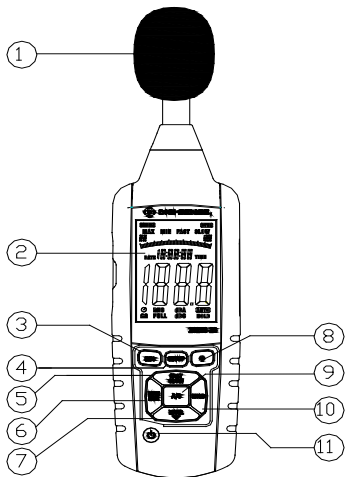

## Display Layout

1. Under-range icon
2. Over-range icon
3. MAX MIN FAST SLOW
4. Minimum hold icon
5. Fast response icon
6. Slow response icon
7. Selected level range
8. Date and time symbols
9. Reading of sound level
10. Auto power-off icon
11. Low-battery icon
12. Recording icon
13. Memory full icon
14. A-Weighting icon
15. C-Weighting icon
16. Auto level range selection
17. Data Hold function icon

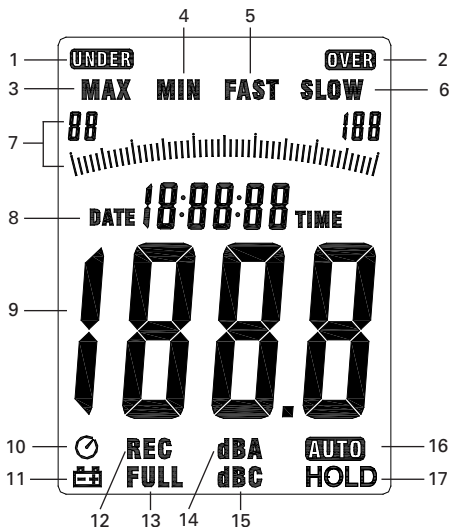

## Setup and Operation

1. Remove the battery cover on the back and put in three AAA batteries. Replace the battery cover.
2. See *Data Zero Function* below to set before powering unit on.
3. Press the **Power on/off** button to turn the meter on.
4. Press the **LEVEL** button to select your desired low/medium/high or auto level. (**Note:** With selected range, ensure that the **UNDER** or **OVER** icon is not displayed, which indicates you are out of range.)
5. Select **dBA** for general noise sound level or **dBC** for measuring sound level of acoustic material.
6. Select **FAST** for instant sound and **SLOW** for average sound levels.
7. Hold the unit in hand or fix-mount it on a tripod and measure sound level at a distance of 3.3 to 4.9 feet (1 to 1.5 meters).

### Data Zero Function

1. Before powering on, press and hold the **REC** button.
2. While holding the **REC** button down, press and hold the **Power on/off** button until the display reads CLR. This indicates that the data in memory has been deleted.



## Enabling the Data Logging Function

1. Press **REC** button after powering unit on.
2. The display will show **REC** and the unit will begin logging data.
3. Press the **REC** button again to exit recording. (**Note:** In order to avoid data errors, do not power the unit off while in **REC** mode. To ensure data integrity, deselect the **REC** function prior to powering meter off.)

## Time and Date Setup

1. Press and hold the **SETUP** button. While holding the **SETUP** button, press and hold the **Power on/off** button. When the **TIME** symbol appears on the display, release the **SETUP** button. The meter is now in the time and date setup mode (see Fig. 1).
2. Press the **SETUP** button a second time (see Fig. 2).
3. While viewing the display above, press the **LEVEL** button to set the minute. Then press the **HOLD** button to save the desired minute.
4. Press the **SETUP** button a third time (see Fig. 3).
5. While viewing the display above, press the **LEVEL** button to secure the desired hour (AM or PM). Then press the **HOLD** button to save the desired hour.
6. Press the **SETUP** button a fourth time (see Fig. 4).

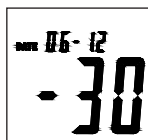

Fig. 1

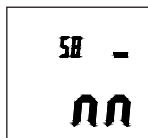

Fig. 2

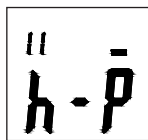

Fig. 3

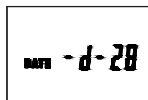

Fig. 4

## Time and Date Setup (Continued)

7. While viewing the display (see Fig. 4), press the **LEVEL** button to choose the desired day of the month. Then press the **HOLD** button to save this day.
8. Press the **SETUP** button a fifth time (see Fig. 5).
9. While viewing the display (see Fig. 5), press the **LEVEL** button to select the desired month of the year. Then press the **HOLD** button to save this month.
10. Press the **SETUP** button a sixth time (see Fig. 6).
11. While viewing the display (see Fig. 6), press the **LEVEL** button for the desired year. Then press the **HOLD** button to save the year. This completes the setup process.
12. Press the **SETUP** button a seventh time (see Fig. 7). This is the time/date reset function. Press the **HOLD** button to save. The time and date will then return to the original factory time and date setup.

**(Note:** When the batteries fail or are replaced, you may have to reprogram the time/date. Simply follow steps #1 through #11 above.)

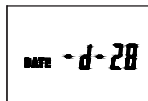

Fig. 4

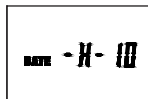

Fig. 5

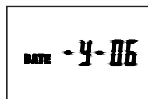

Fig. 6

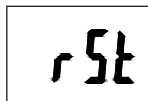

Fig. 7

## Selecting Time Weighting

Press the **FAST/SLOW** button to select fast or slow sampling times. **FAST** = sampling measurement of one time per 125 mS. **SLOW** = sampling measurement of one time per second.



## Viewing the Min and Max Readings

1. Press the **MAX/MIN** button once and **MAX** icon will appear on the display. In this mode, the maximum sound level will be captured and held until a higher sound level is captured.
2. Press the **MAX/MIN** button again and the **MIN** icon will appear on the display. In this mode, the minimum sound level will be captured and held until a lower sound level is captured.
3. Press the button one more time to exit the **MAX/MIN** function.

## Selecting Level Range

Press the **LEVEL** button to select low/medium/high, or auto decibel measuring range. The selected range will appear in the upper left and upper right of the display.

## LCD Backlight

Press the **Backlight**  button to activate or deactivate the display backlight.

## Selecting Frequency Weighting

Press **A/C** button to select A or C weighting. Either the **dBA** (A-weighting) or **dBC** (C-weighting) icon will be displayed.

## Freezing the Reading

Press **HOLD** button to freeze the reading in the display.

## Connecting the USB Cable

1. Turn on the meter and connect the USB cable to the USB port located on the side of the meter.
2. Connect the other end of the USB cable to the computer.
3. Choose the software COM3 (COM).
4. Press the **SETUP** button. The **auto power-off**  icon will disappear from the display, indicating the disabling of the auto power-off function and the successful transmission of USB data. The USB signal output is a 9600 bps serial interface.

## Installing Software

1. Insert the CD into the PC.
2. Run SETUP.EXE on the CD. Follow the installation wizard to complete the installation.
3. Upon successful installation, the Sound Level Meter software icon shortcut will be automatically placed on the PC desktop.
4. If the USB driver needs to be updated (or if you receive the driver error message), go to the folder with the driver on the CD and double click the file CP210xVCPInstaller.exe to update the driver. (With disk in the computer, D drive/USB Driver folder).

## Activating Real-Time Data Logging

1. Once the driver software is installed, start the application software by selecting the Auto (A) function from the Com Port dropdown menu at the top of the menu bar. Then connect the meter to the computer via the USB cable.

2. Make sure the **auto power-off**  icon does not appear in the instrument display by pressing the **SETUP** button. When this symbol is not displayed, the meter is transmitting data to the computer.
3. Select the Real Time (R) from the top menu bar; select Setup (U) from the dropdown menu.
4. In the Setup menu screen, select the preferred Real Time Sampling Rate then press **Start**.
5. You may stop the data logging function by selecting the **Stop** symbol located at the top of the menu bar. Simply select the Excel document symbol at the top of the menu bar to instantly download your current data session to the preformatted Excel document.
6. To set A and B cursors, simply double click on the graphical display of data taken and the cursor information will automatically populate within the cursor designated box.

### **Remote Data Logging/ Downloading Data**

1. Clear all data from the instrument. See *Data Zero Function* instructions on page 6.
2. Set the unit to your desired sampling speed, frequency weighting, and level settings (see pages 8–9).
3. Press **REC** button to begin recording data. The **REC** icon will be displayed in the lower left of the display.
4. When data recording is complete, push the **REC** button again to stop the data logging function. The **REC** icon should disappear from the lower left of the display.

## Remote Data Logging/ Downloading Data (continued)

5. Connect the meter to the computer via the USB cable. See *Connecting the USB Cable* section on page 10. Select the Sound Meter icon from your desktop. (**Note:** Software must already have been successfully installed.)
6. Make sure **auto power-off**  icon is not displayed in the screen. Press **SETUP** button to deactivate if necessary.
7. In the sound level meter software screen, select Data logger (D) from the top menu bar.
8. The summarized record of data will then automatically download to the screen and be tagged with ID, Date/ Time, Unit, Sampling Rate and Nums information.
9. Select Export to Excel (E) from the top menu bar to export data to Excel if desired.
10. Double click on summarized data logging record to graphically view the data on the screen.

## Connecting to the External 5 VDC Power Supply Terminal

To connect with the 5 VDC power supply, the aperture size is: external diameter = 3.5 mm, internal diameter = 1.35 mm.

## Using the AC/DC Signal Output Earphone

### DC:

Output voltage: 10 mV/dB

Output impedance: 1 k $\Omega$

### AC:

Output voltage: 1 V<sub>rms</sub>  
corresponding to each  
range step

Output impedance: 100  $\Omega$

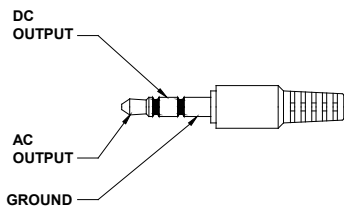

## Using the Calibration Potentiometer

The **CAL** function is for external standard level calibration adjustments. (**Note:** The meter is calibrated against NIST-traceable standards before shipment.) To make calibration adjustments of frequency weighting (A-weighting), time weighting (FAST), or Level range (50 to 100 dB):

1. Insert the microphone housing carefully into the 1/2" insertion hole of the calibrator (94 dB @ 1 KHz).
2. Turn on the switch of calibrator and adjust the CAL potentiometer of the unit until 94.0 dB is displayed.

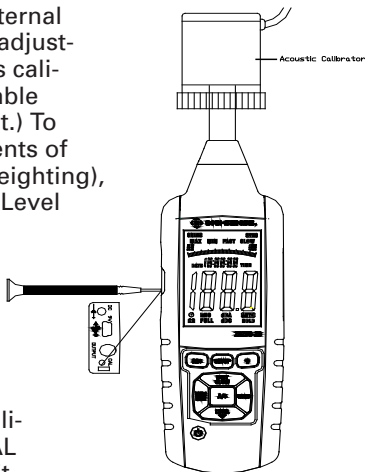

## Specifications

Range	Low: 30 to 80 dB
	Medium: 50 to 100 dB
	High: 80 to 130 dB
	Auto: 30 to 130 dB
Resolution	0.1 dB
Accuracy	±1.4 dB
Weighting	A and C
Time weighting	Fast = 125 m/sec, Slow = 1 sec
Functions	Max/Min, Hold, Low/medium/high ranges, Over-range, Under-range, A and C weighting, Fast/Slow response, Memory, Data logging software, Backlit display, and Automatic power-off
Frequency range	31.5 Hz to 8 kHz
Dynamic range	50 dB
Memory	32,700 readings
Display update	2 times/sec
Connectivity	USB
Analog output	AC/DC outputs from earphone outlet; AC = 1 Vrms, DC = 10 mV/dB
Microphone	1/2" electret condenser microphone
Operating conditions	32 to 104°F (0 to 40°C); 10 to 90% RH
Storage conditions	14 to 140°F (-10 to 60°C); 10 to 75% RH
Approvals	IEC61672 -1 Class 2
Display	4-digit backlit LCD with bar graph
Dimensions (L x W x H)	9 1/4" x 2 7/16" x 1 1/16" (235 x 61 x 27 mm)
Power	Three AAA batteries
Weight	9.8 oz (280 g)

## Maintenance, Recalibration, and Repair

### Maintenance

- When operating the meter in the presence of wind, use the included windscreen to eliminate undesirable signals.
- Keep microphone dry and avoid severe vibration.

### Cleaning & Storage

- Meter should be wiped regularly with a dry cloth; do not use solvents or detergents to clean meter.
- Do not store or operate the instrument in high temperature and humidity environments (see *Specifications* on page 14).

### Battery Replacement

When the **low-battery** icon appears on the screen, replace the three AAA batteries in the rear battery compartment by loosening the screws and removing the battery door. Ensure cover is securely refastened when finished. Remove batteries if unit is not being used for extended time periods.

**It is recommended that Digi-Sense products are calibrated annually** to ensure proper function and accurate measurements; however, your quality system or regulatory body may require more frequent calibrations. To schedule your recalibration, please contact InnoCal, an ISO 17025 calibration laboratory accredited by A2LA.



**Phone:** 1-866-INNOCAL (1-866-466-6225)

**Fax:** 1-847-327-2993

**E-mail:** sales@innocal.com

**Web:** InnoCalSolutions.com

**For Product and Ordering Information, Contact:**



99 Washington Street  
Melrose, MA 02176  
Phone 781-665-1400  
Toll Free 1-800-517-8431



Visit us at [www.TestEquipmentDepot.com](http://www.TestEquipmentDepot.com)