

# Series 2600 System SourceMeter®

## User's Manual

2600S-900-01 Rev. A / May 2006

Test Equipment Depot - 800.517.8431 - 99 Washington Street Melrose, MA 02176 - [TestEquipmentDepot.com](http://TestEquipmentDepot.com)

**KEITHLEY**

A G R E A T E R M E A S U R E O F C O N F I D E N C E

# WARRANTY

Keithley Instruments, Inc. warrants this product to be free from defects in material and workmanship for a period of 1 year from date of shipment.

Keithley Instruments, Inc. warrants the following items for 90 days from the date of shipment: probes, cables, rechargeable batteries, diskettes, and documentation.

During the warranty period, we will, at our option, either repair or replace any product that proves to be defective.

To exercise this warranty, write or call your local Keithley representative, or contact Keithley headquarters in Cleveland, Ohio. You will be given prompt assistance and return instructions. Send the product, transportation prepaid, to the indicated service facility. Repairs will be made and the product returned, transportation prepaid. Repaired or replaced products are warranted for the balance of the original warranty period, or at least 90 days.

## LIMITATION OF WARRANTY

This warranty does not apply to defects resulting from product modification without Keithley's express written consent, or misuse of any product or part. This warranty also does not apply to fuses, software, non-rechargeable batteries, damage from battery leakage, or problems arising from normal wear or failure to follow instructions.

THIS WARRANTY IS IN LIEU OF ALL OTHER WARRANTIES, EXPRESSED OR IMPLIED, INCLUDING ANY IMPLIED WARRANTY OF MERCHANTABILITY OR FITNESS FOR A PARTICULAR USE. THE REMEDIES PROVIDED HEREIN ARE BUYER'S SOLE AND EXCLUSIVE REMEDIES.

NEITHER KEITHLEY INSTRUMENTS, INC. NOR ANY OF ITS EMPLOYEES SHALL BE LIABLE FOR ANY DIRECT, INDIRECT, SPECIAL, INCIDENTAL OR CONSEQUENTIAL DAMAGES ARISING OUT OF THE USE OF ITS INSTRUMENTS AND SOFTWARE EVEN IF KEITHLEY INSTRUMENTS, INC., HAS BEEN ADVISED IN ADVANCE OF THE POSSIBILITY OF SUCH DAMAGES. SUCH EXCLUDED DAMAGES SHALL INCLUDE, BUT ARE NOT LIMITED TO: COSTS OF REMOVAL AND INSTALLATION, LOSSES SUSTAINED AS THE RESULT OF INJURY TO ANY PERSON, OR DAMAGE TO PROPERTY.

**KEITHLEY**

A GREATER MEASURE OF CONFIDENCE

**Series 2600 System  
SourceMeter<sup>®</sup> Instruments  
User's Manual**

©2006, Keithley Instruments, Inc.  
All rights reserved.  
Cleveland, Ohio, U.S.A.  
Document Number: 2600S-900-01 Rev. A

---

# Manual Print History

The print history shown below lists the printing dates of all Revisions and Addenda created for this manual. The Revision Level letter increases alphabetically as the manual undergoes subsequent updates. Addenda, which are released between Revisions, contain important change information that the user should incorporate immediately into the manual. Addenda are numbered sequentially. When a new Revision is created, all Addenda associated with the previous Revision of the manual are incorporated into the new Revision of the manual. Each new Revision includes a revised copy of this print history page.

Revision A (Document Number 2600S-900-01)..... May 2006

The following safety precautions should be observed before using this product and any associated instrumentation. Although some instruments and accessories would normally be used with non-hazardous voltages, there are situations where hazardous conditions may be present.

This product is intended for use by qualified personnel who recognize shock hazards and are familiar with the safety precautions required to avoid possible injury. Read and follow all installation, operation, and maintenance information carefully before using the product. Refer to the manual for complete product specifications.

If the product is used in a manner not specified, the protection provided by the product may be impaired.

The types of product users are:

**Responsible body** is the individual or group responsible for the use and maintenance of equipment, for ensuring that the equipment is operated within its specifications and operating limits, and for ensuring that operators are adequately trained.

**Operators** use the product for its intended function. They must be trained in electrical safety procedures and proper use of the instrument. They must be protected from electric shock and contact with hazardous live circuits.

**Maintenance personnel** perform routine procedures on the product to keep it operating properly, for example, setting the line voltage or replacing consumable materials. Maintenance procedures are described in the manual. The procedures explicitly state if the operator may perform them. Otherwise, they should be performed only by service personnel.

**Service personnel** are trained to work on live circuits, and perform safe installations and repairs of products. Only properly trained service personnel may perform installation and service procedures.

Keithley products are designed for use with electrical signals that are rated Measurement Category I and Measurement Category II, as described in the International Electrotechnical Commission (IEC) Standard IEC 60664. Most measurement, control, and data I/O signals are Measurement Category I and must not be directly connected to mains voltage or to voltage sources with high transient over-voltages. Measurement Category II connections require protection for high transient over-voltages often associated with local AC mains connections. Assume all measurement, control, and data I/O connections are for connection to Category I sources unless otherwise marked or described in the Manual.

Exercise extreme caution when a shock hazard is present. Lethal voltage may be present on cable connector jacks or test fixtures. The American National Standards Institute (ANSI) states that a shock hazard exists when voltage levels greater than 30V RMS, 42.4V peak, or 60VDC are present. **A good safety practice is to expect that hazardous voltage is present in any unknown circuit before measuring.**

Operators of this product must be protected from electric shock at all times. The responsible body must ensure that operators are prevented access and/or insulated from every connection point. In some cases, connections must be exposed to potential human contact. Product operators in these circumstances must be trained to protect themselves from the risk of electric shock. If the circuit is capable of operating at or above 1000 volts, **no conductive part of the circuit may be exposed.**

Do not connect switching cards directly to unlimited power circuits. They are intended to be used with impedance limited sources. NEVER connect switching cards directly to AC mains. When connecting sources to switching cards, install protective devices to limit fault current and voltage to the card.

Before operating an instrument, make sure the line cord is connected to a properly grounded power receptacle. Inspect the connecting cables, test leads, and jumpers for possible wear, cracks, or breaks before each use.

When installing equipment where access to the main power cord is restricted, such as rack mounting, a separate main input power disconnect device must be provided, in close proximity to the equipment and within easy reach of the operator.

For maximum safety, do not touch the product, test cables, or any other instruments while power is applied to the circuit under test. ALWAYS remove power from the entire test system and discharge any capacitors before: connecting or disconnecting cables or jumpers, installing or removing switching cards, or making internal changes, such as installing or removing jumpers.

Do not touch any object that could provide a current path to the common side of the circuit under test or power line (earth) ground. Always make measurements with dry hands while standing on a dry, insulated surface capable of withstanding the voltage being measured.

The instrument and accessories must be used in accordance with its specifications and operating instructions or the safety of the equipment may be impaired.

Do not exceed the maximum signal levels of the instruments and accessories, as defined in the specifications and operating information, and as shown on the instrument or test fixture panels, or switching card.

When fuses are used in a product, replace with same type and rating for continued protection against fire hazard.

Chassis connections must only be used as shield connections for measuring circuits, NOT as safety earth ground connections.

If you are using a test fixture, keep the lid closed while power is applied to the device under test. Safe operation requires the use of a lid interlock.

If a  screw is present, connect it to safety earth ground using the wire recommended in the user documentation.

The  symbol on an instrument indicates that the user should refer to the operating instructions located in the manual.

The  symbol on an instrument shows that it can source or measure 1000 volts or more, including the combined effect of normal and common mode voltages. Use standard safety precautions to avoid personal contact with these voltages.

The  symbol indicates a connection terminal to the equipment frame.

The **WARNING** heading in a manual explains dangers that might result in personal injury or death. Always read the associated information very carefully before performing the indicated procedure.

The **CAUTION** heading in a manual explains hazards that could damage the instrument. Such damage may invalidate the warranty.

Instrumentation and accessories shall not be connected to humans.

Before performing any maintenance, disconnect the line cord and all test cables.

To maintain protection from electric shock and fire, replacement components in mains circuits, including the power transformer, test leads, and input jacks, must be purchased from Keithley Instruments. Standard fuses, with applicable national safety approvals, may be used if the rating and type are the same. Other components that are not safety related may be purchased from other suppliers as long as they are equivalent to the original component. (Note that selected parts should be purchased only through Keithley Instruments to maintain accuracy and functionality of the product.) If you are unsure about the applicability of a replacement component, call a Keithley Instruments office for information.

To clean an instrument, use a damp cloth or mild, water based cleaner. Clean the exterior of the instrument only. Do not apply cleaner directly to the instrument or allow liquids to enter or spill on the instrument. Products that consist of a circuit board with no case or chassis (e.g., data acquisition board for installation into a computer) should never require cleaning if handled according to instructions. If the board becomes contaminated and operation is affected, the board should be returned to the factory for proper cleaning/servicing.

# Table of Contents

---

Section	Title	Page
<b>1</b>	<b>Front Panel Operation</b>	
	Safety symbols and terms .....	1-2
	Front and rear panel familiarization .....	1-2
	Front panel summaries .....	1-2
	Rear panel summaries .....	1-6
	What are the source-measure capabilities? .....	1-8
	Models 2601 and 2602 .....	1-8
	Models 2611 and 2612 .....	1-8
	How do I power-up the instrument? .....	1-9
	How do I make measurements? .....	1-10
	How do I use the buffer? .....	1-15
<b>2</b>	<b>Remote Operation</b>	
	How do I use the remote interface? .....	2-2
	How do I use Test Script Builder? .....	2-4
	How do I use TSB to make measurements? .....	2-9
	How do I use other programs? .....	2-12
	Using LabVIEW .....	2-12
	Using Visual Basic .....	2-14
<b>3</b>	<b>Test Script Processor Interaction</b>	
	What is a script? .....	3-2
	Factory scripts .....	3-2
	User scripts .....	3-2
	How do I run a script from the front panel? .....	3-2
	How do I interact with scripts using Test Script Builder? .....	3-3
	Running a factory script .....	3-4
	Modifying a factory script .....	3-6

Running the user script .....	3-12
Deleting a user script and user tests .....	3-13
How do I use other programs? .....	3-14
Using LabVIEW .....	3-14
Using Visual Basic .....	3-16

## 4 Controlling Multiple SourceMeters (TSP-Link)

How do I set up the TSP-Link system? .....	4-2
How do I use the expanded system? .....	4-4
Accessing resources of TSP-Link nodes .....	4-4
Running scripts in a TSP-Link system .....	4-5

Appendix	Title	Page
----------	-------	------

---

### A Specifications

.....	A-2
-------	-----

### B Frequently Asked Questions

How do I optimize performance? .....	B-2
Setting speed .....	B-2
Disabling auto zero to increase speed .....	B-2
How do I use the Digital I/O port? .....	B-3
Digital I/O port terminals .....	B-3
Controlling the Digital I/O port .....	B-3
How do I trigger other instruments? .....	B-5
Triggering a scanner .....	B-5
Programming triggering .....	B-5
How do I generate a service request? .....	B-6
Setting up a service request .....	B-6
Service request programming example .....	B-6
Polling for SRQs .....	B-6
How do I store measurements in non-volatile memory? .....	B-7
Front panel operation .....	B-7
Remote programming .....	B-7
How do I stack channels to output higher voltage? .....	B-9
How do I parallel channels to output higher current? .....	B-11
How do I make contact check measurements? .....	B-12
Contact check connections .....	B-12
Contact check programming example .....	B-13



# List of Illustrations

---

<b>Section</b>	<b>Figure</b>	<b>Title</b>	<b>Page</b>
<b>1</b>		<b>Front Panel Operation</b>	
	Figure 1-1	Series 2600 front panels	1-3
	Figure 1-2	Series 2600 rear panels .....	1-6
	Figure 1-3	DUT connections to 10k $\Omega$ resistor .....	1-12
	Figure 1-4	Interlock circuit .....	1-13
	Figure 1-5	Display modes.....	1-14
	Figure 1-6	Buffer display format .....	1-17
<b>2</b>		<b>Remote Operation</b>	
	Figure 2-1	GPIB cable .....	2-2
	Figure 2-2	RS-232 cable .....	2-2
	Figure 2-3	Test Script Builder initial startup screen .....	2-6
	Figure 2-4	Instrument console control icons.....	2-7
	Figure 2-5	Select Instrument Resource dialog box .....	2-8
	Figure 2-6	Source-measure command sequence in console window .....	2-11
	Figure 2-7	LabVIEW source-measure example block diagram .....	2-13
	Figure 2-8	Visual Basic example user interface .....	2-14
	Figure 2-9	Example program test results.....	2-17

<b>3</b>	<b>Test Script Processor Interaction</b>	
	Figure 3-1 Pulse-measure cycle for the PulseVMeasureI function.....	3-3
	Figure 3-2 Importing a factory script project from the Series 2600.....	3-7
	Figure 3-3 KIGeneral project imported into the Test Script Builder .....	3-9
	Figure 3-4 Run configuration example - Main tab .....	3-11
	Figure 3-5 Run configuration example - Script Attributes tab .....	3-12
	Figure 3-6 LabVIEW source step example.....	3-15
	Figure 3-7 GUI after loading the non-function script (GPIB).....	3-18
	Figure 3-8 GUI after running the non-function script (GPIB) .....	3-19
	Figure 3-9 GUI after loading and running the function script (GPIB).....	3-21
	Figure 3-10 GUI after calling the function (GPIB).....	3-23
<b>4</b>	<b>Controlling Multiple SourceMeters (TSP-Link)</b>	
	Figure 4-1 TSP-Link connections .....	4-2

<b>Appendix Figure</b>	<b>Title</b>	<b>Page</b>
------------------------	--------------	-------------

---

<b>B</b>	<b>Frequently Asked Questions</b>	
	Figure B-1 Digital I/O port terminals.....	B-3
	Figure B-2 Triggering a scanner .....	B-5
	Figure B-3 Stacking channels for higher voltage .....	B-10
	Figure B-4 Connecting channels in parallel for higher current.....	B-11
	Figure B-5 Contact check connections .....	B-12

# List of Tables

---

<b>Section</b>	<b>Table</b>	<b>Title</b>	<b>Page</b>
<b>1</b>		<b>Front Panel Operation</b>	
	Table 1-1	Model 2601 and 2602 source-measure capabilities.....	1-8
	Table 1-2	Model 2611 and 2612 source-measure capabilities .....	1-8
<b>3</b>		<b>Test Script Processor Interaction</b>	
<b>4</b>		<b>Controlling Multiple SourceMeters (TSP-Link)</b>	
	Table 4-1	Assigning a node number to an instrument from the front panel....	4-3
	Table 4-2	Resetting the TSP-Link from the front panel .....	4-3
<b>Appendix</b>	<b>Table</b>	<b>Title</b>	<b>Page</b>
<b>B</b>		<b>Frequently Asked Questions</b>	
	Table B-1	Commands for basic I/O port .....	B-4

This page left blank intentionally.

# Section 1

---

## Front Panel Operation

### In this section:

<b>Topic</b>	<b>Page</b>
<b>Safety symbols and terms</b>	1-2
<b>Front and rear panel familiarization</b>	1-2
Front panel overview	1-2
Rear panel overview	1-6
<b>What are the source-measure capabilities?</b>	1-8
Models 2601 and 2602	1-8
Models 2611 and 2612	1-8
<b>How do I power-up the instrument?</b>	1-8
Connect to line power	1-9
Turn on power	1-9
Set line frequency	1-9
<b>How do I make measurements?</b>	1-10
Connect the DUT	1-10
Select source and set source level	1-10
Set compliance limit	1-11
Select measurement function and range	1-11
Turn output on	1-11
Make measurements	1-11
Turn output off	1-12
<b>How do I use the buffer?</b>	1-15
Connect the DUT	1-15

Set up source and measure functions	1-15
Configure the buffer	1-16
Turn on the output	1-16
Store readings	1-16
Turn off the output	1-16
Recall readings	1-16

## Safety symbols and terms

The following symbols and terms may be found on the instrument or used in this manual:

The  symbol on an instrument indicates that the user should refer to the operating instructions located in the manual.

The  symbol on the instrument shows that high voltage may be present on the terminal(s). Use standard safety precautions to avoid personal contact with these voltages.

The  symbol on an instrument shows that the surface may be hot. Avoid personal contact to prevent burns.

The **WARNING** heading used in this manual explains dangers that might result in personal injury or death. Always read the associated information very carefully before performing the indicated procedure.

The **CAUTION** heading used in this manual explains hazards that could damage the instrument. Such damage may invalidate the warranty.

## Front and rear panel familiarization

### Front panel overview

The front panels of the Series 2600 are shown in [Figure 1-1](#) and [Figure 1-2](#). Summaries of the front panel controls follow these figures.

Figure 1-1  
Series 2600 front panels

**Model 2601 and Model 2611**

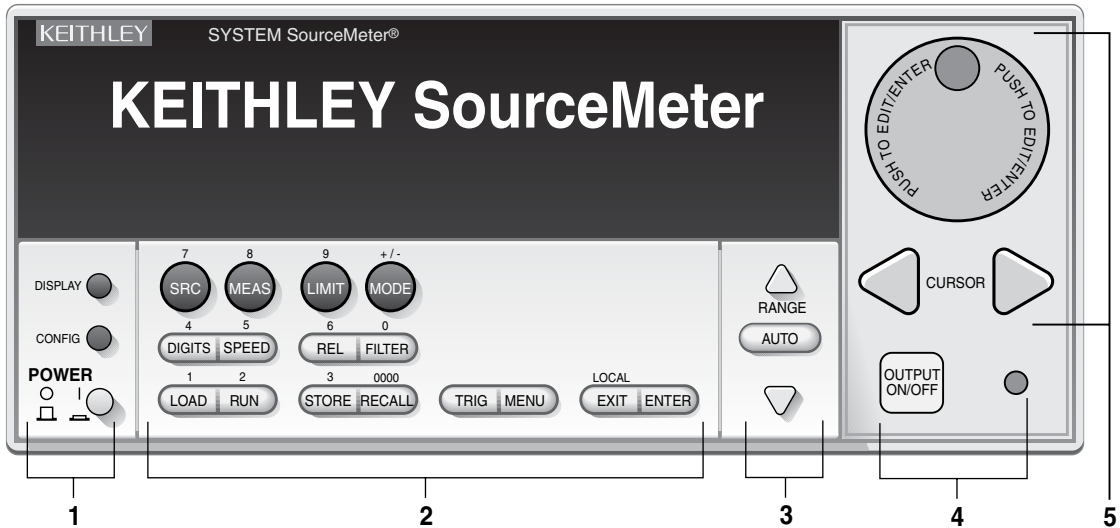

**Model 2602 and Model 2612**

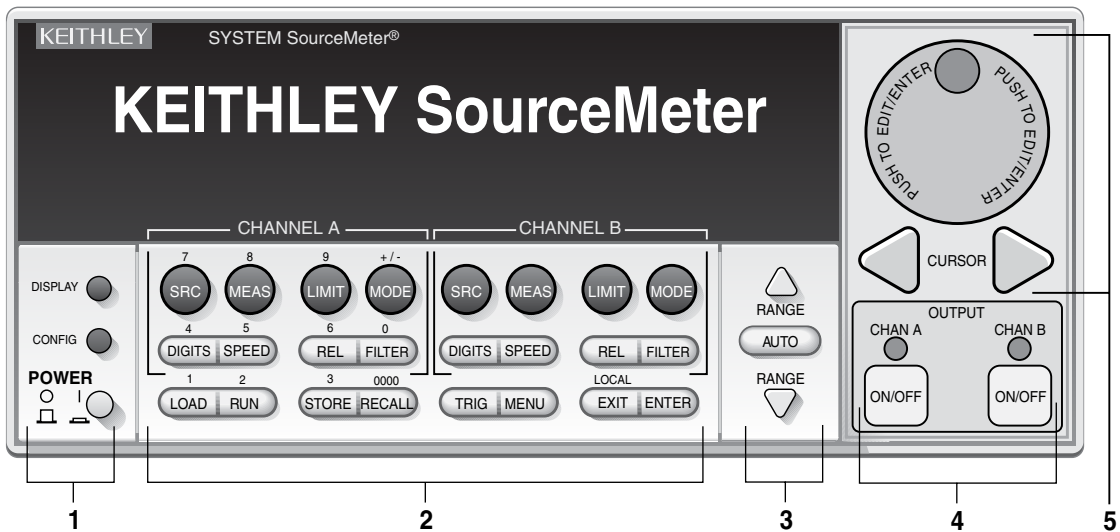

**NOTE** The Models 2601 and 2611 have one SourceMeter channel (Channel A) and the Models 2602 and 2612 have two SourceMeter channels (Channel A and Channel B).

### 1. Special keys and power switch:

DISPLAY	Toggles between the various source-measure displays and the user message mode. Selects Model 2602/2612 single or dual-channel display.
CONFIG	Used to configure a function or operation.
POWER	Power switch – In position turns SourceMeter on (I), out position turns SourceMeter off (O).
Number Keys	The Number Keys (0-9, +/-, 0000) allow direct numeric entry in the EDIT mode.

### 2. Source measure setup, performance control and special operation:

#### Top Row – Source measure setup Models 2601/2611 and Models 2602/2612:

SRC	Channel A – Selects the source function (V or A) and places cursor in the source field for editing.
MEAS	Channel A – Cycles through measure functions (V, A, $\Omega$ or W).
LIMIT	Channel A – Places the cursor in the compliance limit field for editing.
MODE	Channel A – Directly chooses the measurement function (V, A, $\Omega$ or W).

#### Top Row – Source measure setup Models 2602/2612 only:

SRC	Channel B – Selects the source function (V or A) and places cursor in the source field.
MEAS	Channel B – Cycles through measure functions (V,A, $\Omega$ or W).
LIMIT	Channel B – Places the cursor in the compliance limit field for editing.
MODE	Channel B – Directly chooses the measurement function (V, A, $\Omega$ or W).

#### Middle Row – Source measure setup Model 2601/2611 and Models 2602/2612:

DIGITS	Channel A – Changes resolution display to 4-1/2, 5-1/2, or 6-1/2 digits.
SPEED	Channel A – Sets the measurement speed by controlling the A/D converter measurement aperture.
REL	Channel A – Controls relative, which allows a baseline value to be subtracted from a reading.
FILTER	Channel A – Controls the digital filter, which can be used to reduce reading noise.

#### Middle Row – Source measure setup Models 2602/2612 only:

DIGITS	Channel B – Changes resolution display to 4-1/2, 5-1/2, or 6-1/2 digits.
SPEED	Channel B – Sets the measurement speed by controlling the A/D converter measurement aperture.
REL	Channel B – Controls relative, which allows a baseline value to be subtracted from a reading.
FILTER	Channel B – Controls the digital filter, which can be used to reduce reading noise.



**Bottom Row – Source measure setup Models 2601/2611 2602/2612:**

LOAD	Loads factory or user-defined scripts for execution.
RUN	Runs last selected factory or user-defined scripts.
STORE	Stores readings, source values, and timestamp values in one of two internal buffers for later recall.
RECALL	Recalls stored readings, source values, and timestamp values from either of the two buffers.
TRIG	Triggers readings.
MENU	Accesses the Main Menu for saving and recalling setups, selecting remote interface, line frequency, self-tests, serial number and beeper control.
EXIT	Cancels selection, and backs out of menu structure. Used as a LOCAL key to take the unit out of remote.
ENTER	Accepts selection, moves to next choice or exits menu.

**3. Range keys:**

$\Delta$ and $\nabla$	Selects the next higher or lower source or measure range.
AUTO	Enables or disables source or measure auto range.

**4. Output control and LED status indicator:**

OUTPUT ON/OFF	Turns source output on or off.
LED indicator	Lights up when output is on.

**5. Rotary Knob and CURSOR keys:**

When in source edit, use CURSOR keys for cursor control and then turn the Rotary Knob to change a source or compliance value. The Rotary Knob can also be used to enable or disable the source edit mode.

When in a menu, use the CURSOR keys or Rotary Knob for menu item cursor control. When displaying a menu value, use the CURSOR keys for cursor control and turn the Rotary Knob to change the value. Pressing the Rotary Knob opens a menu item, or selects a menu option or value.

**6. Display annunciators (not shown):**

EDIT	Unit is in the source editing mode.
ERR	Questionable reading or invalid cal step.
REM	Unit in remote mode.
TALK	Unit addressed to talk.
LSTN	Unit addressed to listen.
SRQ	Service request.
REL	Relative mode enabled.
FILT	Analog filter or Averaging filter is enabled.
AUTO	Auto source or measure range selected.
ARM	Unit armed and ready to run.
TRIG	External triggering selected.
* (asterisk)	Readings being stored in buffer.

## Rear panel overview

The rear panels of the Series 2600 are shown in Figure 1-2. Summaries of the rear panel components follow Figure 1-2.

Figure 1-2  
Series 2600 rear panels

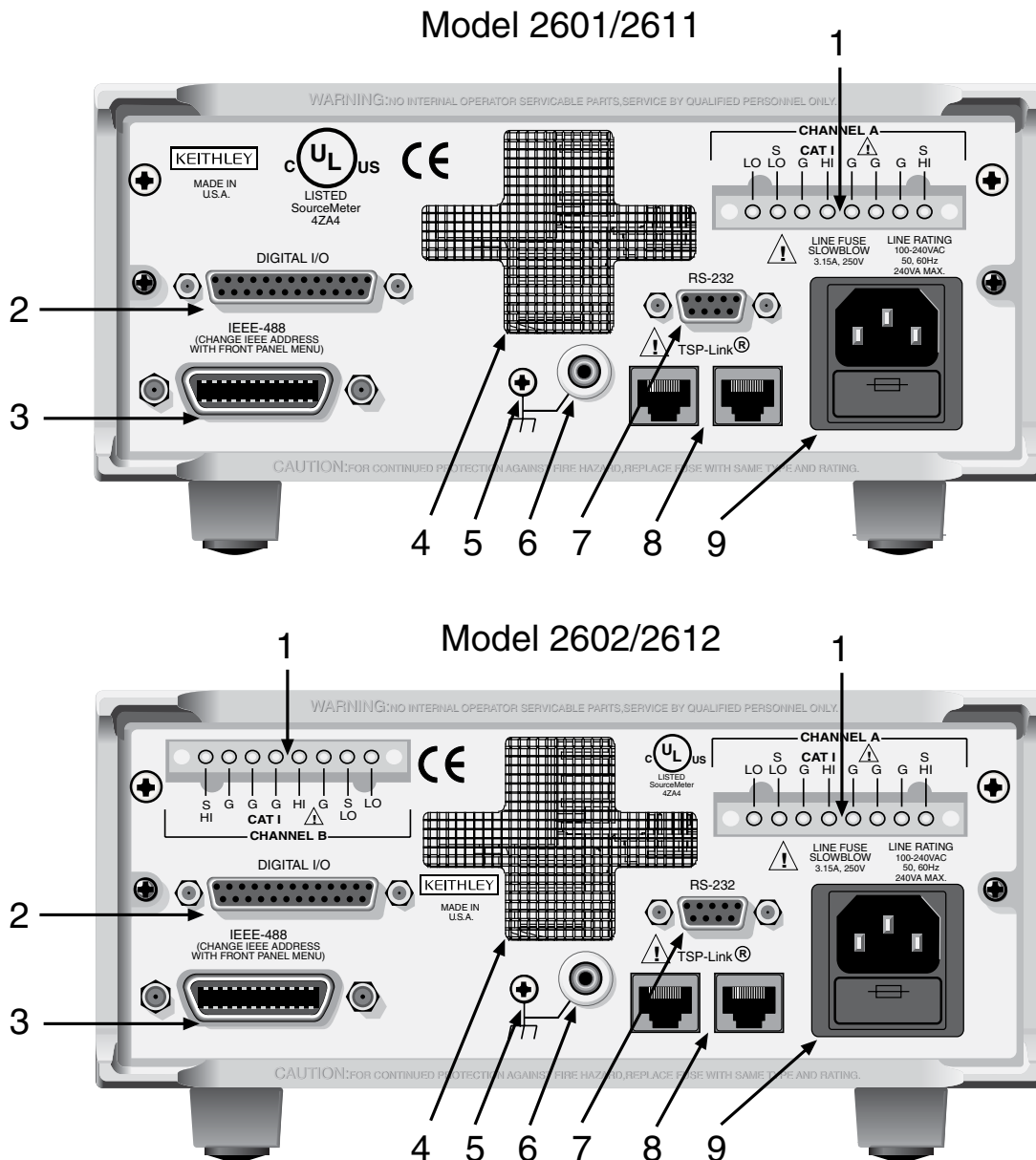

## **1. CHANNEL A and CHANNEL B (Channel B on Models 2602/2612 only)**

Input/output connections for source, sense, and guard.

## **2. DIGITAL I/O**

Female DB-25 connector. Fourteen pins for digital input or output, one pin for Output Enable. Use a cable equipped with a male DB-25 connector (Keithley Instruments part number CA-126-1CA).

## **3. IEEE-488**

Connector for IEEE-488 (GPIB) operation. Use a shielded cable, such as the Model 7007-1 or Model 7007-2.

## **4. Cooling exhaust vent**

Exhaust vent for internal cooling fan. Keep vent free of obstructions to prevent overheating.

## **5. Chassis ground**

Ground screw for connections to chassis ground.

## **6. Low noise chassis ground**

Ground jack for connecting Output HI or LO to chassis.

## **7. RS-232**

Female DB-9 connector. For RS-232 operation, use a straight-through (not null modem) DB-9 shielded cable for connection to the PC (Keithley Instruments Model 7009-5).

## **8. TSP-Link**

Expansion interface that allows a Series 2600 and other TSP-enabled instruments to trigger and communicate with each other. Use a category 5e or higher LAN crossover cable (Keithley Instruments part number CA-180-3A).

## **9. Power module**

Contains the AC line receptacle and power line fuse. The instrument can operate on line voltages of 100V to 240VAC at line frequencies of 50Hz or 60Hz. Refer to Section 17 of the Series 2600 Reference Manual for line fuse replacement instructions.

## What are the source-measure capabilities?

**Reference** Refer to the specifications in Appendix A of this manual as well as Sections 4 and 8 of the Series 2600 Reference Manual for more detailed information.

### Models 2601 and 2602

Basic DC source-measure capabilities for the Models 2601 and 2602 are listed in [Table 1-1](#).

Table 1-1

#### Models 2601 and 2602 source-measure capabilities

Function	Capabilities
Source $\pm$ DC voltage Source $\pm$ DC current	1 $\mu$ V to 40.4V 1pA to 3.03A
Measure $\pm$ DC voltage Measure $\pm$ DC current	1 $\mu$ V to 40.8V 1pA to 3.06A

### Models 2611 and 2612

Basic DC source-measure capabilities for the Models 2611 and 2612 are listed in [Table 1-2](#).

Table 1-2

#### Models 2611 and 2612 source-measure capabilities

Function	Capabilities
Source $\pm$ DC voltage Source $\pm$ DC current	1 $\mu$ V to 202V 1pA to 1.515A <sup>1</sup>
Measure $\pm$ DC voltage Measure $\pm$ DC current	1 $\mu$ V to 204V 1pA to 1.53 <sup>1</sup>

1. 10A maximum available in pulse mode only.

# How do I power-up the instrument?

**Reference** Refer to “Power-up” in Section 1 of the Series 2600 Reference Manual for more information on line power.

## Step 1: Connect to line power

**CAUTION** Operating the instrument on an incorrect line voltage may cause damage to the instrument, possibly voiding the warranty.

1. Before plugging in the power cord, make sure that the front panel power switch is in the off (O) position.
2. Connect the female end of the supplied power cord to the AC receptacle on the rear panel. Connect the other end of the power cord to a grounded AC outlet.

**WARNING** Failure to use a grounded outlet may result in personal injury or death due to electric shock.

## Step 2: Turn on power

Turn on the instrument by pressing the front panel power switch to the on (I) position. Assuming no errors occur, the Series 2600 will power-up as follows:

- After a few seconds with the OUTPUT indicators and display pixels on, the instrument model number and firmware revision levels are briefly displayed.
- The node and the GPIB address are displayed briefly as follows:  
KEITHLEY MODEL 26xx<sup>1</sup>  
NODE = 1                      GPIB = 26
- The TSP-Link node and serial port parameters are displayed briefly:  
KEITHLEY MODEL 26xx<sup>1</sup>  
NODE = 1                      SERIAL = 9600,8,N,1,NONE

## Step 3: Set line frequency

The Series 2600 will operate at line frequencies of either 50Hz or 60Hz. For best measurement noise performance, the unit should be configured to match the actual line frequency used by selecting MENU > LINE-FREQ > 50Hz, 60Hz, or AUTO (When set to AUTO, the SourceMeter will automatically detect the power line frequency at power-up.).

---

1. Instrument will display actual model number: 2601, 2602, 2611, or 2612.

# How do I make measurements?

**Reference** Refer to the following information in Section 4 of the Series 2600 Reference Manual:

- “Basic-source-measure procedure”
- “Ohms measurements”
- “Power measurements”

The measurement procedure below demonstrates how to set up the Series 2600 to source 10V and measure current through a 10k $\Omega$  resistor.

**WARNING** **Hazardous voltages may be present on the output and guard terminals. To prevent electrical shock that could cause injury or death, NEVER make or break connections to the Series 2600 while the output is on. Power off the equipment from the front panel or disconnect the main power cord from the rear of the SourceMeter before handling cables connected to the outputs. Putting the equipment into standby does not guarantee the outputs are not powered if a hardware or software fault occurs.**

## Step 1: Connect the DUT

Connect a 10k $\Omega$  resistor to the SourceMeter Channel A HI and LO terminals as shown in [Figure 1-3](#). Connect the resistor to the supplied screw terminal block, then plug the terminal block into the Channel A connector. Refer to Section 3 of the Series 2600 Reference Manual for complete information.

## Step 2: Select source and set source level

Perform the following steps to select the voltage source and set the source value to 10V:

1. Press Channel A SRC to select the V-Source as indicated by the “V” units in the source field on the display. The flashing cursor indicates which value is presently selected for editing.
2. Press the up RANGE key, and select the 20V source range (Models 2611/2612) or 40V source range (Models 2601/2602). Use the lowest possible source range for best accuracy.
3. Use the CURSOR keys to move the cursor to the 10s digit, then press the Rotary Knob to enter the EDIT mode (EDIT annunciator on).
4. Using either the numeric keys or the Rotary Knob, set the source value to 10.0000V, then press ENTER or the Rotary Knob.

### Step 3: Set compliance limit

Perform the following steps to set the current compliance limit value to 10mA:

1. Put the Model 2602/2612 in the single-channel display mode with the DISPLAY key.
2. Press the LIMIT key, then press ENTER or the Rotary Knob.
3. Move the cursor to the 10s digit, then press the Rotary Knob to enter the EDIT mode.
4. Using the numeric keys or the Rotary Knob, set the limit value to 10.000mA, then press ENTER or the Rotary Knob.

### Step 4: Select measurement function and range

1. Put the Model 2602/2612 in the single-channel display mode with the DISPLAY key, then select the current measurement function by pressing MEAS or MODE.
2. Select the measurement range with the RANGE keys. For the purposes of this example, press AUTO RANGE, and note the AUTO annunciator turns on. The instrument will automatically select the best range based on the measured value. You can also use manual ranging by pressing the up or down RANGE key, but be sure to use the lowest possible range for best accuracy.

### Step 5: Turn output on

Turn the output on by pressing the appropriate OUTPUT ON/OFF key. The ON/OFF indicator LED will light when the channel output is on.

<b>NOTE</b>	<b>The Models 2611 and 2612 are equipped with a safety interlock circuit that prevents operation on the 200V range if the circuit is not energized. This circuit is illustrated in <a href="#">Figure 1-4</a>. Refer to Section 10 of the Series 2600 Reference manual for more information.</b>
-------------	--

### Step 6: Make measurements

1. Observe the readings on the display (Press TRIG if necessary to trigger the unit to begin taking readings.). For the single-channel display mode, the readings will appear on the top line, while source and limit values are on the bottom line. For the 10k $\Omega$  resistor under test, typical display values are:  
1.00000mA  
SrcA: +10.0000 V LimA:010.0000mA

2. Use the DISPLAY key to cycle through the various display modes shown in [Figure 1-5](#) (The User State display messages are defined with specific display commands; refer to Section 14 of the Series 2600 Reference manual.).
3. Press the MEAS key several times to display measured voltage, resistance, and power. Typical values for the 10k $\Omega$  resistor are: 10.0000V, 10.0000k $\Omega$ , and 10.0000mW.

## Step 7: Turn output off

When finished making measurements, turn the output off by pressing the OUTPUT ON/OFF key. The OUTPUT indicator light will turn off.

Figure 1-3

### DUT connections to 10k $\Omega$ resistor

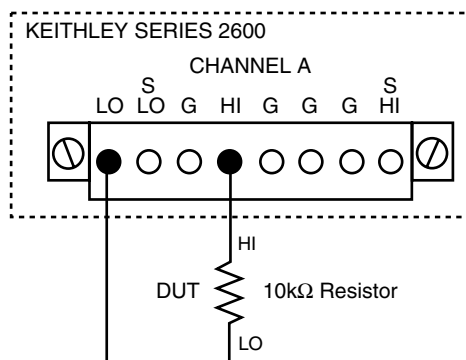



Figure 1-4  
Interlock circuit

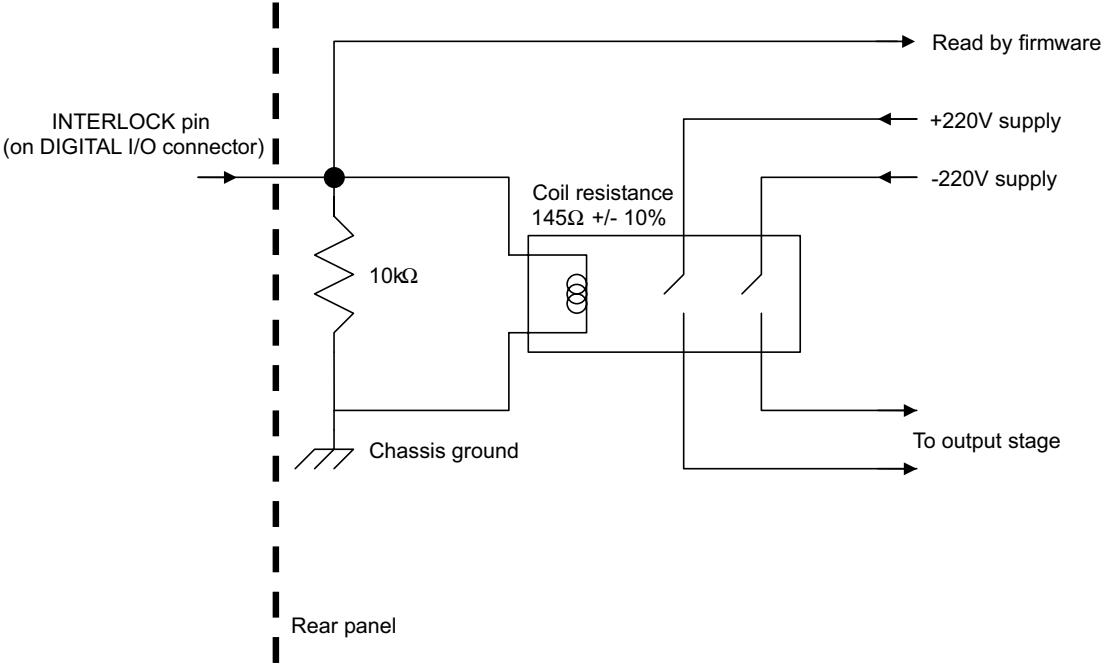
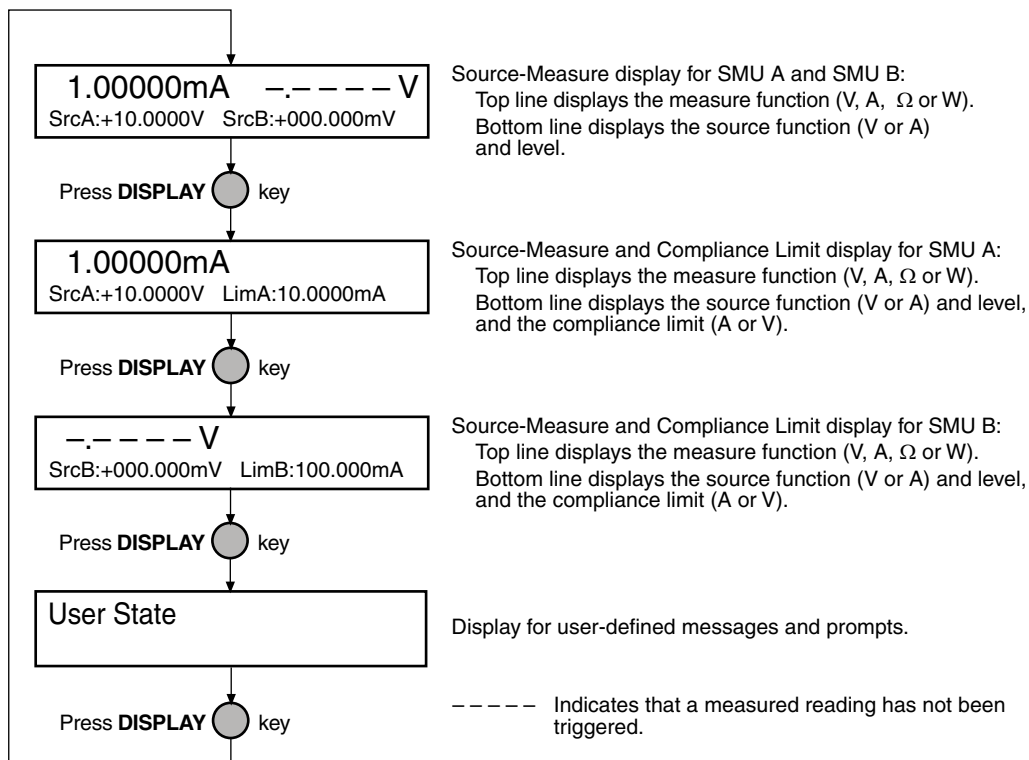

Figure 1-5  
Display modes



# How do I use the buffer?

**Reference** Refer to Section 7 of the Series 2600 Reference Manual for more detailed information on using the buffer.

The SourceMeter has two buffers per channel that can store from 1 to more than 100,000 readings. Each buffer reading is numbered and can also include the source value and a timestamp.

The following example shows how to store 100 readings, source values, and timestamps in Channel A, Buffer 1 and recall them from the front panel.

## Step 1: Connect the DUT

Connect a 10k $\Omega$  resistor to the Channel A HI and LO terminals (Refer to [Figure 1-3](#)).

## Step 2: Set up source and measure functions

Using the procedure described in "[How do I make measurements?](#)" earlier in this section, set-up source and measure functions:

- Source function: volts
- Source range: 20V (2611/2612) or 40V (2601/2602)
- Source value: 10V
- Measure function: current
- Measure range: auto

## Step 3: Configure the buffer

1. Press the CONFIG key followed by the STORE key.
2. Choose COUNT, then set the number of readings to store to 100 using the Rotary Knob, and press ENTER or the Rotary Knob.
3. Select CHANA\_BUFF, then press ENTER or the Rotary Knob to select Channel A.
4. Choose DEST, then CHANA\_BUFFER1, and press ENTER or the Rotary Knob.
5. Choose BUFFER1, then press ENTER or the Rotary Knob to set up Buffer 1.
6. Select CLEAR, then YES to clear the buffer.
7. Choose ELEMENTS, then enable (ON) both SRC-VAL (source value) and TSTAMP (timestamp) storage.
8. Press EXIT several times to return to normal display.

## Step 4: Turn on the output

Press the CHAN A (Models 2602/2612) OUTPUT ON/OFF key to turn on the source output.

## Step 5: Store readings

1. Press the STORE key to store readings. The asterisk (\*) annunciator turns on to indicate data storage operation is enabled.
2. Press EXIT to stop data storage before it finishes.

## Step 6: Turn off the output

Press the OUTPUT ON/OFF key to turn off the output after storage has completed.

## Step 7: Recall readings

1. Press the RECALL key to access buffer readings (repeatedly pressing RECALL will cycle through Buffer 1 then Buffer 2 for Channel A and then Channel B). A message will be displayed if a buffer is empty.
2. Note the buffer display data (Refer to [Figure 1-6](#)):
  - The reading is on the top display at the left.
  - The buffer location number is on the right. For example, location #000001 indicates that the displayed reading is stored at the first memory location.
  - The source value is positioned at the lower left side of the display.
  - The timestamp is positioned at the lower right side. The first source-measure reading stored in the buffer (#000001) is timestamped at 00000000.001 seconds. Subsequent readings are timestamped relative to when the time storage was started. The interval between readings will depend on the reading rate.
3. To display the other readings stored in the buffer, choose the desired memory location number:
  - Use the Rotary Knob to increment and decrement the selected digit of the location number.
  - Set the cursor position with the Rotary Knob or CURSOR keys.
4. To exit from the data store recall mode, press EXIT.

Figure 1-6  
**Buffer display format**

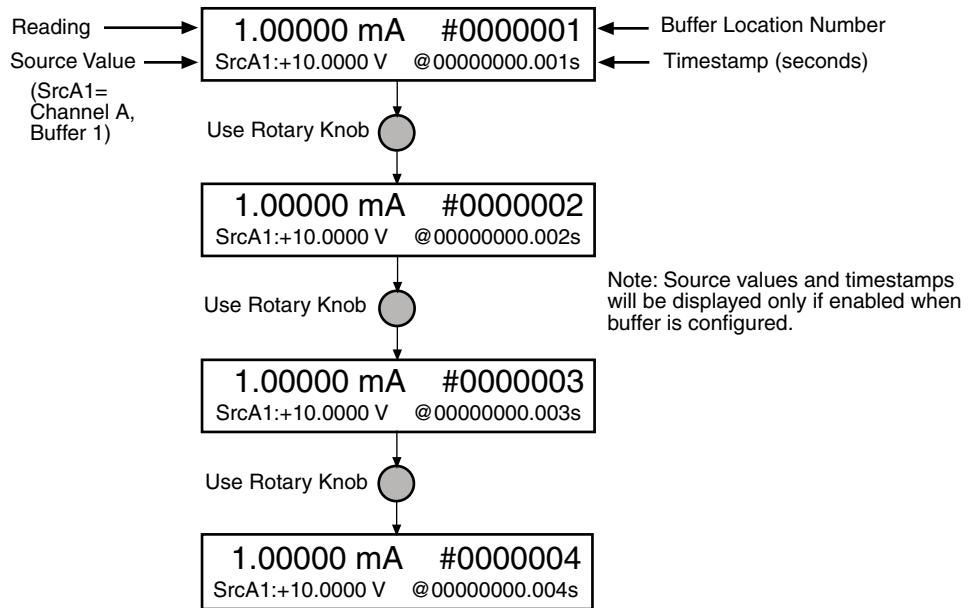

This page left blank intentionally.

### In this Section:

<b>Topic</b>	<b>Page</b>
<b>How do I use the remote interface?</b>	2-2
Connect to the interface	2-2
Select the interface	2-3
Configure the interface	2-3
<b>How do I use Test Script Builder?</b>	2-4
Run Test Script Builder	2-4
Open and close an instrument resource	2-7
Save and clear console window	2-8
Select command and language reference views	2-8
<b>How do I use TSB to make measurements?</b>	2-9
Reset instrument	2-10
Select source function and set output value	2-10
Set compliance value and measure range	2-10
Turn on output	2-11
Make a measurement	2-11
Print the result	2-11
Turn off output	2-11
<b>How do I use other programs?</b>	2-12
Using LabVIEW	2-12
Using Visual Basic	2-14

# How do I use the remote interface?

**Reference** Refer to Section 11 of the Series 2600 Reference Manual for detailed information on communications interfaces.

## Step 1: Connect to the interface

Refer to [Figure 1-2](#) in Section 1 of this document for the locations of the GPIB (IEEE-488) and RS-232 connectors, and make connections as follows:

- GPIB – Use a shielded IEEE-488 cable such as the Keithley Instruments Model 7007 to connect the Series 2600 IEEE-488 connector to the GPIB connector on the computer (Refer to [Figure 2-1](#)).
- RS-232 – Use a shielded 9-pin RS-232 cable like the Keithley Instruments Model 7009-5 to connect the SourceMeter RS-232 connector to the serial port of the computer (Refer to [Figure 2-2](#)).

Figure 2-1

### GPIB cable

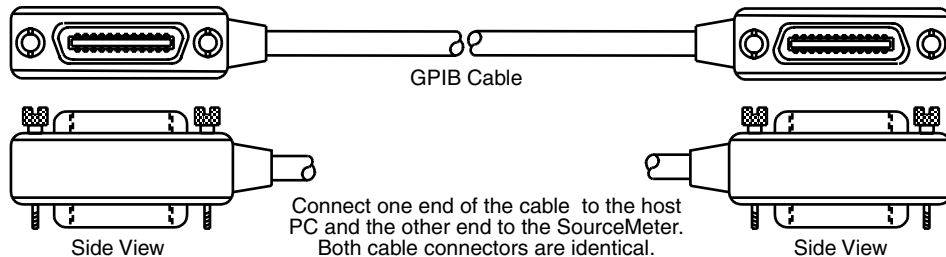
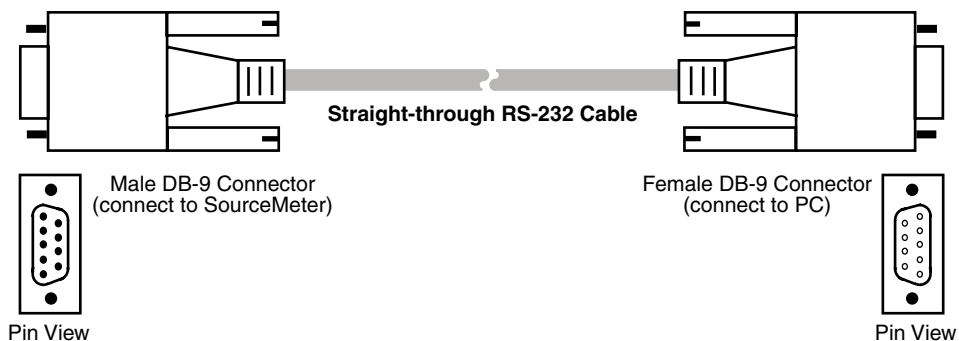

Figure 2-2

### RS-232 cable





## Step 2: Select the interface

1. Press MENU to open up the Main Menu.
2. Select COMMUNICATION, then press ENTER.
3. Select INTERFACE\_SEL, then press ENTER.
4. Choose GPIB for the IEEE-488 interface, RS-232 for the serial interface, or AUTO to have the instrument automatically select the interface.

## Step 3: Configure the interface

### GPIB interface configuration

Set the primary address using the following procedure. The SourceMeter's primary address must be the same as that specified in your program, or the two devices will not be able to communicate.

1. Press MENU to open up the Main Menu.
2. Select COMMUNICATION, then press ENTER.
3. Select INTERFACE\_CFG, then press ENTER.
4. Choose GPIB, then press ENTER.
5. Set the GPIB address (0 to 30), and press ENTER.
6. Press EXIT to back out of the menu structure.

### RS-232 interface configuration

Set RS-232 parameters as covered below. The Series 2600 RS-232 parameters must agree with those of the computer serial port, or the two devices will not be able to communicate.

1. Press MENU to open up the Main Menu.
2. Select COMMUNICATION, then press ENTER.
3. Select INTERFACE\_CFG, then press ENTER.
4. Choose RS-232, then press ENTER.
5. Configure the RS-232 interface as follows:
  - Set the BAUD rate: 300, 600, 1200, 2400, 4800, 9600, 19200, 38400, 57600 or 115200.
  - Set BITS: 7 or 8.
  - Set PARITY: NONE, ODD, or EVEN.
  - Set the FLOW-CTRL: NONE or HARDWARE.
6. Press EXIT to back out of the menu structure.

# How do I use Test Script Builder?

**Reference** Refer to Section 2 of the Series 2600 Reference Manual for complete details on using the Test Script Builder.

## Step 1: Run Test Script Builder

Run the **Test Script Builder** program in the **Keithley Instruments** folder in the usual manner. The initial startup screen shown in [Figure 2-3](#) will be displayed. The main sections of the screen are briefly described below.

### Menu Bar

Main menu items include:

**File** – Allows you to control projects and files.

**Edit** – Performs a number of editing functions on script files.

**Navigate** – Navigates through projects.

**Project** – Opens, closes, and builds projects.

**Run** – Runs scripts.

**Window** – Selects which window to display.

**Help** – Provides access to online help files.

### Project Navigator pane

The window pane on the left side is where the Project Navigator resides. The navigator consists of created project folders and the script files (.tsp) created for each project. Each project folder can have one or more script files.

### Script Development pane

The script chunk is written in the upper window pane. It is in this area that scripts are written and/or modified. Notice that there is a tab available for each opened script file. A script project is then downloaded to the SourceMeter and run.

### SourceMeter/Script Interaction pane

A number of tabs in the lower window pane provide additional interaction between the Test Script Builder, the SourceMeter and the opened script (the tabs displayed will depend on those selected in the menu).

Key tabs include:

**Instrument Console** – The Instrument Console is used to send commands to the connected SourceMeter. Retrieved data (e.g., readings) from commands and scripts appear in the console.

**Problems** – When a script is saved, error checking is performed. If a script error is detected, an “X” will appear in the script at or near the corrupt line of code. The Problems tab in the lower window pane will open automatically and provide a description of the error.

**Tasks** – When writing a script, a double dash (--) is used to designate that the text that follows is a comment and not script code. When using the “--TODO” comment in a script, it will also appear in the Tasks tab, where additional information can be added.

**Command Help** – Provides online help to the Instrument Command Library (ICL).

**Language Help** – Provides online help to the TSL programming language.

## Control icons

Control icons (shown in [Figure 2-4](#)) include:









- 1. Open/Close Instrument**  – Opens instrument resource if closed. Closes instrument resource if open.
- 2. Clear Console Window**  – Clears instrument console window.
- 3. Abort Execution**  – Halts execution of commands or scripts.
- 4. Reset**  – Aborts whatever the unit is doing and resets everything to the default state with the output off.
- 5. Send Software Trigger**  – Sends a software trigger to take readings.
- 6. Delete a Script From NVRAM**  – Brings up a window that lists the scripts stored in the unit's non-volatile memory, and allows you to remove scripts.
- 7. Menu**  – Accesses the console menu.
- 8. Minimize/Maximize**  – Minimizes or maximizes the console window.

Figure 2-3  
Test Script Builder initial startup screen

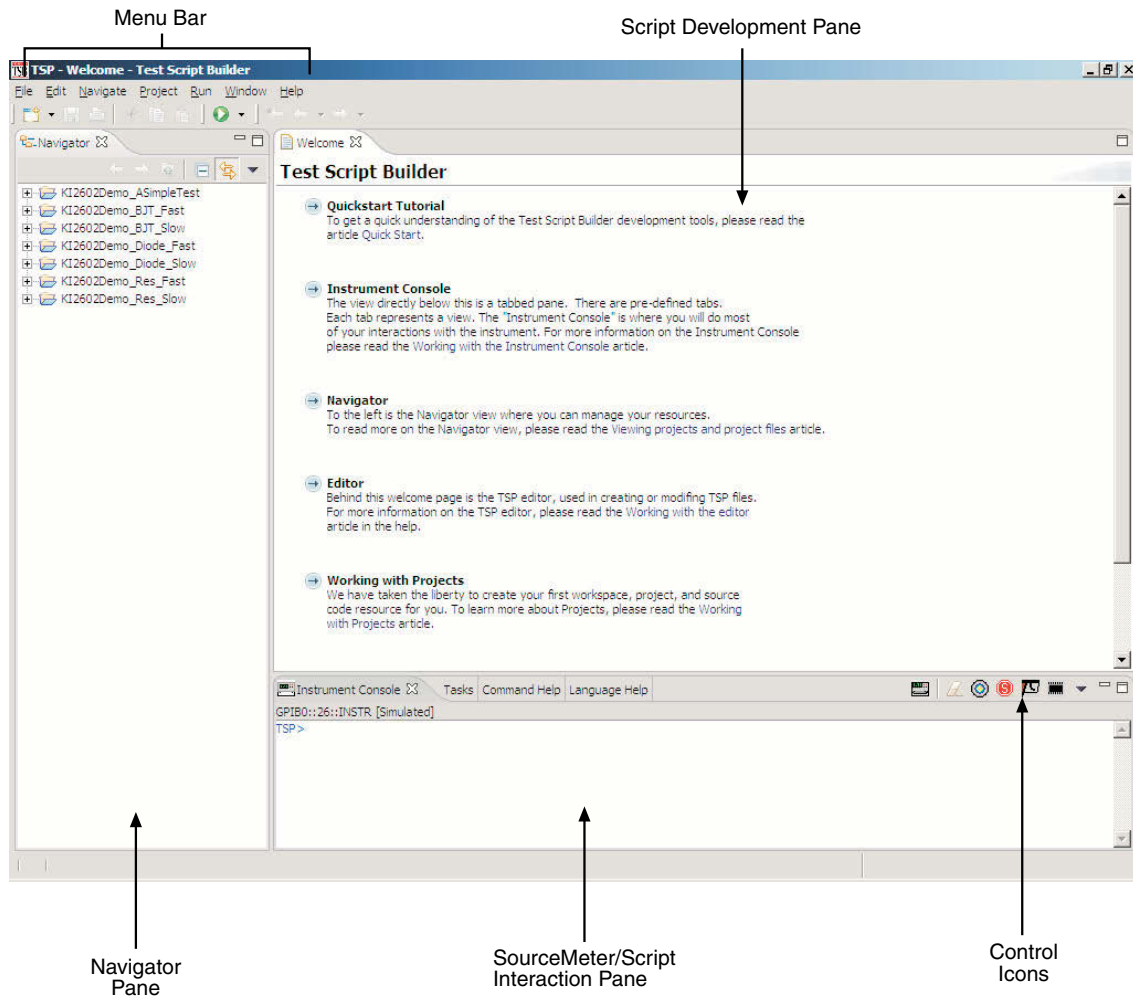
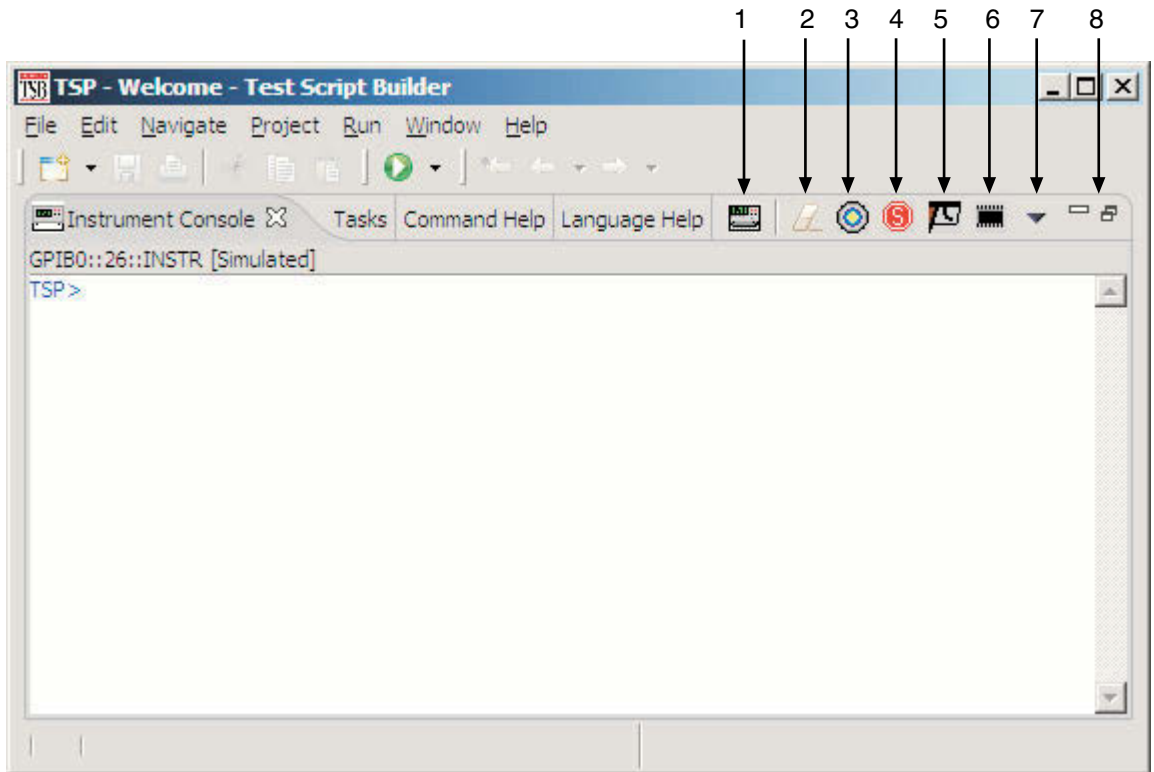

Figure 2-4  
Instrument console control icons



## Step 2: Open and close an instrument resource

Before you can send commands or run scripts to control the SourceMeter, you must first open the instrument resource as follows:

1. Click on the **Open Instrument** icon (Refer to [Figure 2-4](#)).
2. Choose the desired instrument from the dialog box (Refer to [Figure 2-5](#)) drop-down menu to select a communications resource:
  - **GPIB** – At the factory, the GPIB address for the SourceMeter is set to 26. If using the GPIB interface board 0 and address 26, the resource setting should be **GPIB0::26::INSTR**. Resource settings for other GPIB board numbers and primary addresses are available from the dialog box.
  - **RS-232** – Typically, the COM1 serial port of the PC is used for RS-232 communications. For COM1, use the **ASRL1::INSTR** resource setting. Resource settings for other COM ports are available from the dialog box.

3. If you select the **Simulate** option, the Instrument Console will become active even though there will be no actual communication with the SourceMeter. You can simulate running a script or sending a command, but the SourceMeter will not respond.
4. To close the resource, click on the **Instrument** icon again. The resource will close, and the console window will become inactive.

Figure 2-5  
**Select Instrument Resource dialog box**

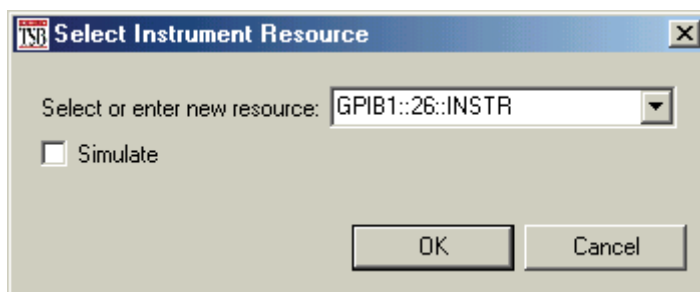

### Step 3: Save and clear console window

You can save and clear the console window as follows:

- **Save console** – Click on the **Menu** arrow (Figure 2-3), choose **Save Console**, then choose the folder and filename desired.
- **Clear console** – Click on the **Clear Console** icon (Figure 2-3) to clear the console window.

### Step 4: Select command and language reference views

You can access online help for the ICL (Instrument Control Library) and TSL (Test Script Language) as follows:

- **ICL:** Click on the **Command Help** tab at the top, then click the **Maximize** icon. You can then quickly get information on all commands in the library.
- **TSL:** Click on the **Language Help** tab at the top, then click the **Maximize** icon to quickly access details on the script language.

## How do I use TSB to make measurements?

**Reference** Refer to “Remote source-measure procedure” in Sections 4 and 12 of the Series 2600 Reference Manual for details on instrument commands.

The following procedure uses the TSB Instrument Console to send commands to source voltage and measure current on Channel A using a 10k $\Omega$  resistor as the DUT. The complete command sequence as it would appear in the console window is shown in [Figure 2-6](#), along with instrument responses.

Figure 2-6

**Source-measure command sequence in console window (2601/2602 version shown)**

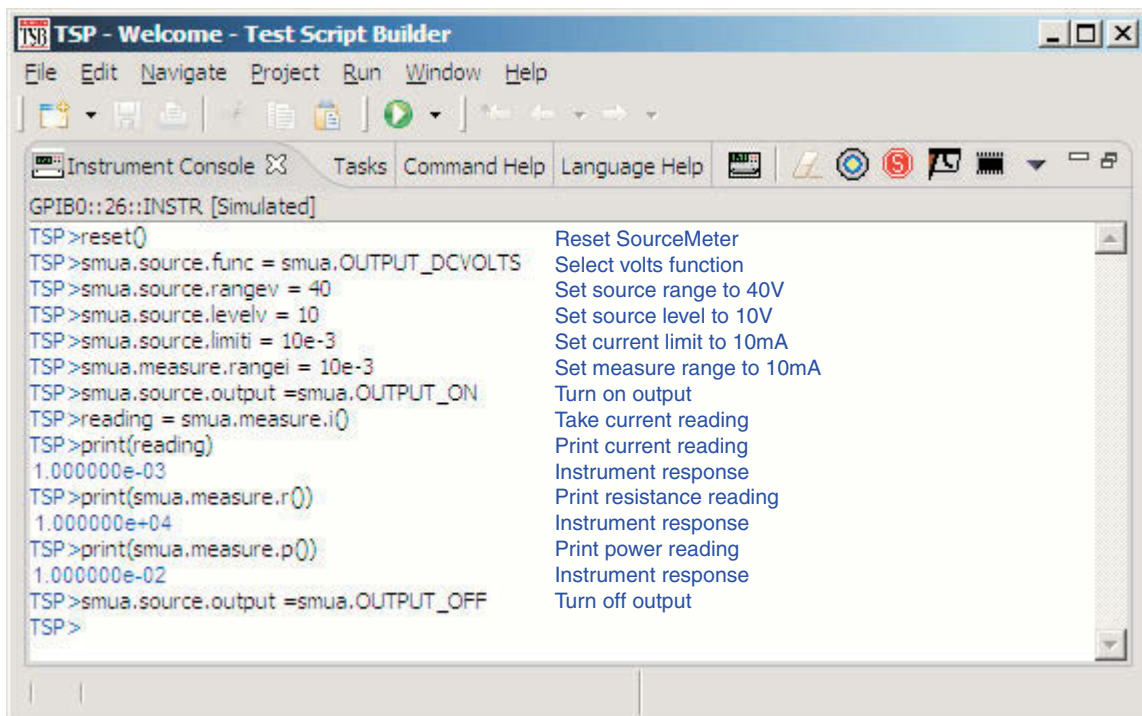

```
TSB TSP - Welcome - Test Script Builder
File Edit Navigate Project Run Window Help
Instrument Console Tasks Command Help Language Help
GPIB0::26::INSTR [Simulated]
TSP>reset() Reset SourceMeter
TSP>smua.source.func = smua.OUTPUT_DCVOLTS Select volts function
TSP>smua.source.rangev = 40 Set source range to 40V
TSP>smua.source.levelv = 10 Set source level to 10V
TSP>smua.source.limits = 10e-3 Set current limit to 10mA
TSP>smua.measure.rangei = 10e-3 Set measure range to 10mA
TSP>smua.source.output =smua.OUTPUT_ON Turn on output
TSP>reading = smua.measure.i() Take current reading
TSP>print(reading) Print current reading
1.000000e-03 Instrument response
TSP>print(smua.measure.r()) Print resistance reading
1.000000e+04 Instrument response
TSP>print(smua.measure.p()) Print power reading
1.000000e-02 Instrument response
TSP>smua.source.output =smua.OUTPUT_OFF Turn off output
TSP>
```

The procedure assumes the DUT (10k $\Omega$  resistor) is already connected to the SourceMeter (Figure 1-3 in Section 1 of this manual), and that the instrument resource has already been opened (“Open and close an instrument resource” earlier in this section).

**WARNING** Hazardous voltages may be present on the output and guard terminals. To prevent electrical shock that could cause injury or death, NEVER make or break connections to the Series 2600 while the output is on. Power off the equipment from the front panel or disconnect the main power cord from the rear of the SourceMeter before handling cables connected to the outputs. Putting the equipment into standby does not guarantee the outputs are not powered if a hardware or software fault occurs.

## Step 1: Reset instrument

A good practice is to reset the instrument to its default settings before the start of a test. To reset the SourceMeter, type the following command into the console window, then press the **Return** key:

```
reset()
```

For Model 2602 or 2612, you can restore defaults of Channel A or Channel B respectively as follows:

```
smua.reset()  
smub.reset()
```

## Step 2: Select source function and set output value

Enter the following commands to select the source voltage function, set the source range to 20V (Models 2611/2612) or 40V Models 2601/2602), and set the source value to 10V:

```
smua.source.func = smua.OUTPUT_DCVOLTS  
smua.source.rangev = 40 (use for Models 2601/2602)  
smua.source.rangev = 20 (use for Models 2611/2612)  
smua.source.levelv = 10
```

## Step 3: Set compliance value and measure range

Enter the following commands to set the compliance limit and measure range to 10mA:

```
smua.source.limiti = 10e-3  
smua.measure.rangei = 10e-3
```



## Step 4: Turn on output

Send the following command to turn on the output:

```
smua.source.output =smua.OUTPUT_ON
```

## Step 5: Make a measurement

Enter the following command to take a current measurement:

```
reading = smua.measure.i()
```

## Step 6: Print the result

Print the result in the console window with the following command:

```
print(reading)
```

Note that the reading response will appear in the console window (refer to [Figure 2-6](#)).

Alternatively, you can take and print readings by including the appropriate `measure` command as the argument in the `print` command. For example, the following commands will take and print ohms and power readings respectively:

```
print(smua.measure.r())  
print(smua.measure.p())
```

Again, readings will be displayed in the console window.

## Step 7: Turn off output

Send the following command to turn off the output when measurements are complete:

```
smua.source.output =smua.OUTPUT_OFF
```

# How do I use other programs?

**Reference** Refer to the LabVIEW and Visual Basic documentation for details on using those programs.

Basic source-measure examples using LabVIEW and Visual Basic are shown below. Refer also to also Section 3 for more examples of how to load and run scripts.

## Using LabVIEW

The source-measure example using LabVIEW is shown in [Figure 2-7](#). The test steps are:

1. Reset instrument.
2. Select source voltage function.
3. Set source output voltage.
4. Turn on output.
5. Take current measurement.
6. Reset instrument.

The command sequence for this source-measure example is shown below:

```
localnode.prompts = 0           --Disable prompts.
reset()                         --Reset Series 2600.
smua.source.func =             --Select voltage source function.
smua.OUTPUT_DCVOLTS
smua.source.levelv = volts     --Set voltage source level.
smua.source.output = smua.OUTPUT_ON --Turn on source output.
print(smua.measurei())        --Take and return current reading.
reset()                         --Reset Series 2600.
```

Figure 2-7  
LabVIEW source-measure example block diagram

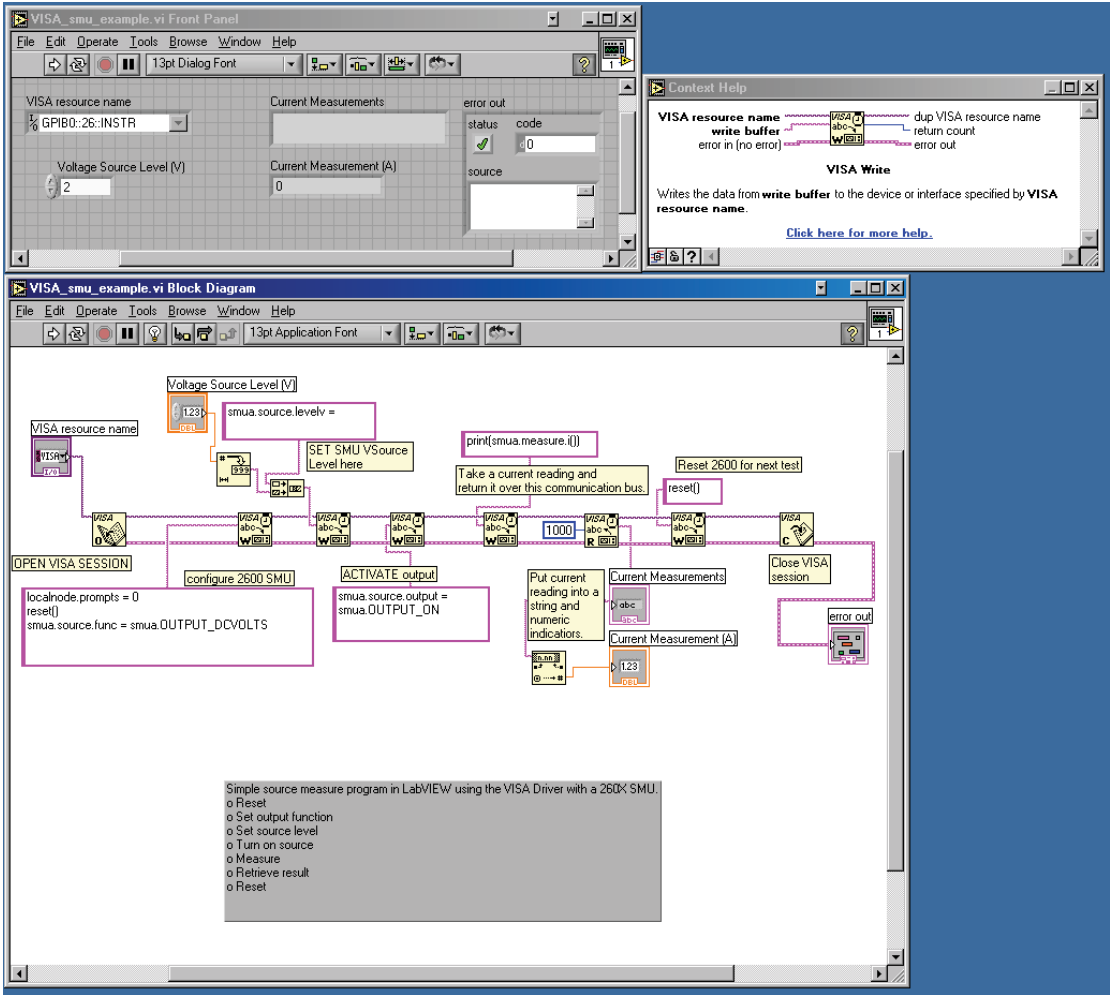

## Using Visual Basic

### User interface

Figure 2-8  
Visual Basic example user interface

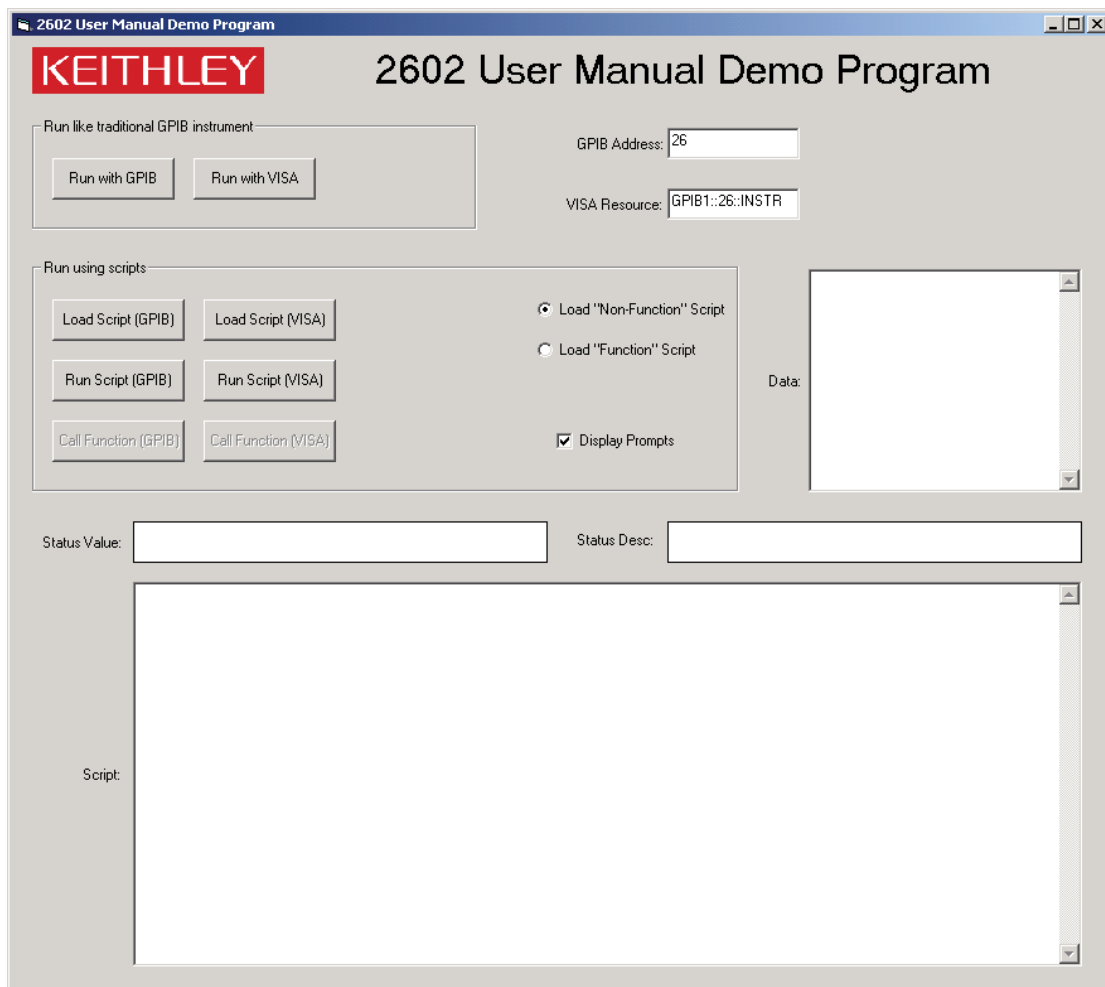

## Using the Series 2600 as a traditional GPIB instrument

The following pseudocode describes how the Series 2600 will be configured and controlled to source voltage and measure current for this example. Some of the settings are default values restored by resetting the instrument, but they are included to show a typical setup and measure sequence that might be used for such a test.

1. Reset SourceMeter to default settings.
2. Set display to show SMU A source and limit settings.
3. Set display to show current measurement.
4. Set source function to DCV.
5. Enable source autorange.
6. Set source level to 5V.
7. Set current compliance to 100mA.
8. Set current measurement range to 100mA.
9. Set integration time to 1PLC.
10. Turn on SMU A output.
11. Measure the current and put reading in instrument output queue. This step is similar to using a SCPI "READ?" query to take a single reading.
12. Turn off SMU A output.

### Command sequence

The commands that implement the pseudocode are listed below. The syntax for the "send" and "enter" commands is for a Keithley Instruments GPIB card. To use a Keithley Instruments GPIB card in Visual Basic, you must include the "ieeevb.bas" module in your project. This module is included on the CD that comes with your GPIB card.

When you click the "Run with GPIB" button on the GUI, the commands are sent to the Series 2600 and executed. The single reading returned by these commands is displayed in the Data text box as shown in [Figure 2-9](#).

Note: Addr% is the GPIB address of the instrument and is assigned the value of 26

```

Call send(Addr%, "localnode.prompts = 0", intStatus)
Call send(Addr%, "reset()", intStatus)
Call send(Addr%, "display.screen = display.SMUA", intStatus)
Call send(Addr%, "display.smua.measure.func = display.MEASURE_DCAMPS", intStatus)
Call send(Addr%, "smua.source.func = smua.OUTPUT_DCVOLTS", intStatus)
Call send(Addr%, "smua.source.autorangev = smua.AUTORANGE_ON", intStatus)
Call send(Addr%, "smua.source.levelv = 5", intStatus)
Call send(Addr%, "smua.source.limiti = 0.1", intStatus)
Call send(Addr%, "smua.measure.rangei = 0.1", intStatus)
Call send(Addr%, "smua.measure.nplc = 1", intStatus)
Call send(Addr%, "smua.source.output = smua.OUTPUT_ON", intStatus)
Call send(Addr%, "print(smua.measure.i())", intStatus)
Call send(Addr%, "smua.source.output = smua.OUTPUT_OFF", intStatus)
Call enter(strBuffer, 256, intNbytes, Addr%, intStatus)
txtData.Text = strBuffer

```

Figure 2-9  
Example program test results

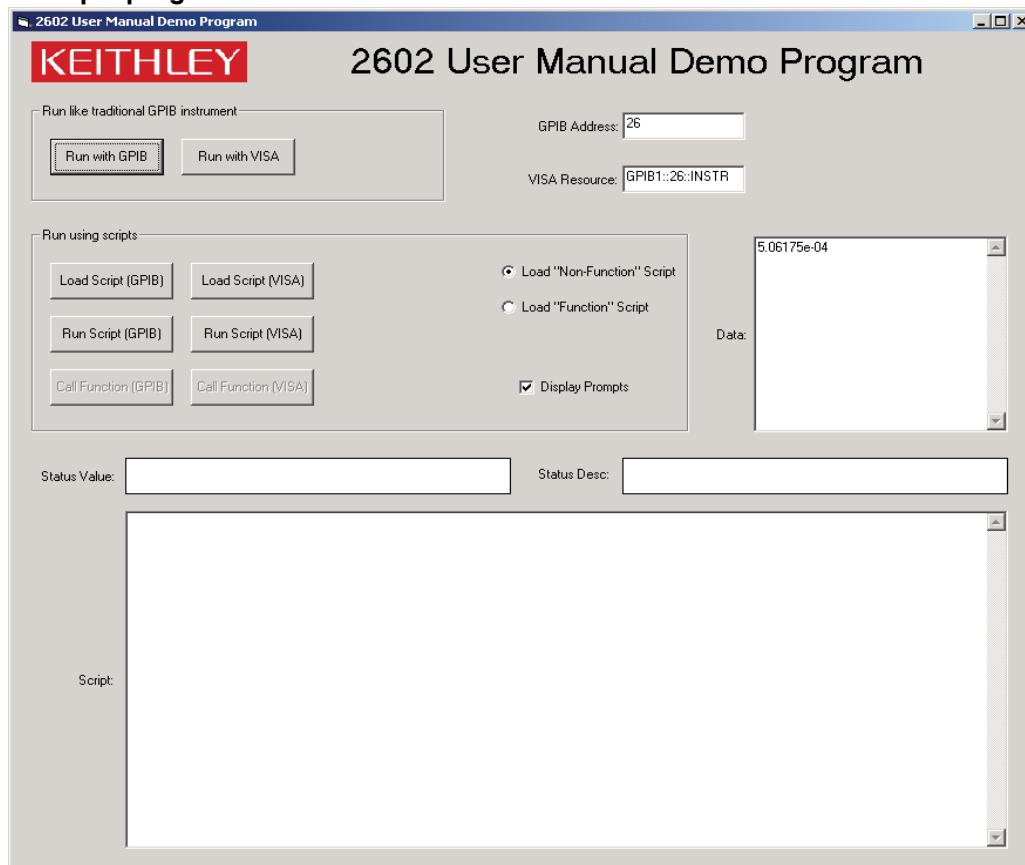

### Using VISA

Clicking on the “Run with VISA” button will send the same commands to the Series 2600 using NI VISA. The VISA resource is for an instrument at address 26 connected to GPIB interface #1. Once again, a Keithley Instruments GPIB card was used for this example. However, VISA allows the same code to be used with GPIB cards made by other manufacturers, or with altogether different interfaces such as the RS-232 or the Ethernet.

This page left blank intentionally.



# Section 3

---

## Test Script Processor Interaction

### In this section:

<b>Topic</b>	<b>Page</b>
<b>What is a script?</b>	3-2
Factory scripts	3-2
User scripts	3-2
<b>How do I run a script from the front panel?</b>	3-2
<b>How do I interact with scripts using Test Script Builder?</b>	3-3
Running a factory script	3-4
Modifying a factory script	3-6
Running the user script	3-12
Deleting a user script and user tests	3-13
<b>How do I use other programs?</b>	3-14
Using LabVIEW	3-14
Using Visual Basic	3-16

## What is a script?

**Reference** Refer to “Programming overview” in Section 2 of the Reference Manual for more information on script fundamentals.

A script is a collection of instrument control commands and programming statements to perform one or more operations or tasks. A script is stored in a Series 2600 and is run by its Test Script Processor (TSP).

### Factory scripts

The Series 2600 is shipped from the factory with at least one factory script stored in its non-volatile memory. Each factory script is made up of a series of functions to perform specific tests. A factory script function can be called (run) from the front panel or called using remote programming. A factory script cannot be deleted from non-volatile memory.

### User scripts

A user script is a script created by a user using the Test Script Builder or an external program. The user script is loaded in the Series 2600 and stored in volatile or non-volatile memory. If stored in non-volatile memory, the script will not be lost when the instrument is turned off.

Keithley Instruments will be posting approved user scripts donated by registered users on its web site.

## How do I run a script from the front panel?

**Reference** Refer to “Factory scripts” and “User Scripts” in Section 2 of the Series 2600 Reference Manual for details on running scripts.

From the front panel, all factory script functions are interactive. That is, when the test is started, the operator will be prompted to enter test parameters. A user script may, or may not be interactive. A non-interactive script requires no operator input and will run to completion when it is started.

<b>NOTE</b>	<b>If the Series 2600 is in remote operation, press the LOCAL key to return control to the front panel.</b>
-------------	---

1. Press the LOAD key to display the LOAD TEST menu.

2. Position the blinking cursor on the FACTORY or USER menu item and press ENTER (or the Rotary Knob). Keep in mind that the Series 2600 is shipped with no user scripts loaded.
3. Position the blinking cursor on the test to be run, and then press ENTER.
4. Press the RUN key to start the test.
5. Enter required test parameters using the front panel controls.

**Reading the buffer** – Test data is stored in a buffer. Refer to in Section 1 of this manual, “[How do I use the buffer?](#)” for details on recalling test data.

## How do I interact with scripts using Test Script Builder?

**Reference** Refer to “Using the Test Script Builder” in Section 2 of the Series 2600 Reference Manual for details on the Test Script Builder.

The following function for factory script “KIGeneral” is stored in the non-volatile memory of the Series 2600:

```
PulseVMeasureI(smu, bias, level, ton, toff, points)
```

The above function performs a specified number of pulse V, measure I cycles:

- Sets the smu to output `bias` volts and dwell for `ton` seconds.
- Sets the smu to output `level` volts and dwell for `ton` seconds.
- Performs current measurement with the source at `level` volts.
- Sets the smu to output `bias` volts for `toff` seconds.
- Repeats the above sequence for `points` pulse-measure cycles.

Figure 3-1 shows one pulse-measure cycle for the function.

Figure 3-1

### Pulse-measure cycle for the `PulseVMeasureI` function

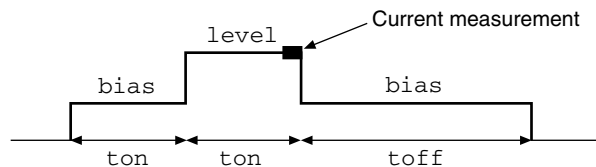

## Running a factory script

**Reference** Refer to “Factory scripts” in Section 2 of the Series 2600 Reference Manual for details on running factory scripts.

**NOTE** All commands to run a factory script are to be executed from the Instrument Console of the Test Script Builder.

The following steps explain how to run the `PulseVMeasureI` function and read the data stored in the buffer.

**NOTE** The “KIGeneral” factory script is an autorun script. The script runs automatically when the Series 2600 is turned on. The functions of the script are ready to be called.

### Step 1: Call the function

The following are example parameters for the `PulseVMeasureI` function which will perform three pulse voltage, measure current cycles:

```
smu = SMU A          level = 1V          toff = 2ms
bias = -1V           ton = 1ms           points = 3
```

The following command will execute the `PulseVMeasureI` function using the above parameters:

```
PulseVMeasureI(smua, -1, 1, 1E-3, 2E-3, 3)
```

### Step 2: Read the buffer

**Reference** Refer to Section 7 of the Series 2600 Reference Manual for details on the reading buffers.

The above function stores the three current measurements in the reading buffer (`smua.nvbuffer1`). Also stored in the buffer are the voltage source settings and timestamps for the measurements. The timestamps (in seconds) are referenced to the start of the test. The timer for the timestamps starts at zero seconds when the test is started.

The `printbuffer` function is used to print (output) measured readings, timestamps and/or source values stored in the buffers.

**Print readings** – The following code will return the three measured current readings stored in `nvbuffer1`:

```
rb1 = smua.nvbuffer1
printbuffer(1, rb1.n, rb1)
```

**Example output:** 1.234567e-03, 2.362360e-03, 2.362368e-03

For the above `printbuffer` function, 1 is the starting index for values to print, `rb1.n` is the ending index (for this function, `n = 3`), and `rb1` is the reading buffer (`smua.nvbuffer1`).

**Print timestamps** – The following command will print the timestamps for the three measured current readings:

```
printbuffer(1, rb1.n, rb1.timestamps)
```

Example output: 5.555555e-02, 8.888888e-02, 1.111111e-01

**Print source values** – The following command will print the voltage source values for the three measured current readings:

```
printbuffer(1, rb1.n, rb1.sourcevalues)
```

Output: 1.000000e+00, 1.000000e+00, 1.000000e+00

**Print readings, timestamps and source values** – The following command will return the three sets of data (nine values) in the same message:

```
printbuffer(1, rb1.n, rb1, rb1.timestamps, rb1.sourcevalues)
```

Example output:

```
1.234567e-03, 5.555555e-02, 1.000000e+00, 2.362360e-03,  
8.888888e-02, 1.000000e+00, 2.362368e-03, 1.111111e-01,  
1.000000e+00
```

The above output is returned in the following order:

```
reading1, timestamp1, sourcevalue1, reading2, timestamp2, sourcevalue2,  
reading3, timestamp3, sourcevalue3
```

## Calling a function without parameters

When the command to call a script function is sent without parameters, input value fields and messages will appear on the display to prompt the operator to input the parameters using the front panel controls.

The following command will call the `SourceVMeasureI` function and then require operator interaction:

```
PulseVMeasureI()
```

After sending the above command, the Series 2600 display will prompt the operator to input the following parameters from the front panel:

- Enter BIAS voltage.
- Enter PULSE (level) voltage.
- Enter pulse ON time.
- Enter pulse OFF time.
- Enter number of pulses (points).

After the operator keys in each parameter and presses the **ENTER** key (or the Rotary Knob), the display will proceed to the next input prompt. After the last parameter (number of pulses) is entered, the test will continue.

The following message will be displayed when the test is finished:

```
PulseVMeasureI
```

```
Test complete.
```

## Modifying a factory script

**Reference** Refer to “Factory scripts” in Section 2 of the Series 2600 Reference Manual for more information on modifying a factory script.

A factory script can be imported from the Series 2600 into the Test Script Builder where it can be modified. The modified script can then be loaded back into the Series 2600 and saved as a user script.

The following procedure will import the KIGeneral factory script into the Test Script Builder, modify code for the SourceVMMeasureI function, load the script in the Series 2600 as a user script under a different name, and then configure the test to call the SourceVMMeasureI function.

### Step 1: Importing a factory script project

A factory script project is made of many executable functions. The `SourceVMMeasureI` function is one of the functions that make up the KIGeneral factory script that is stored in the Series 2600.

[Figure 3-2](#) shows how to import the KIGeneral factory script project from the Series 2600 into the Test Script Builder. After importing the script, the project will appear as a folder in the Project Navigator with a script file named “main.tst” (Refer to [Figure 3-3](#)).

Figure 3-2  
**Importing a factory script project from the Series 2600**

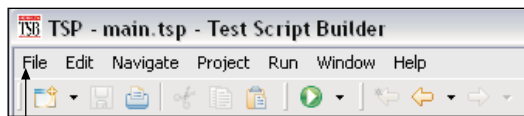

A) Click **File** to display the drop-down file menu and click **Import** to open the Import wizard.

B) In the **Import Select** box, click **Existing Project From Instrument** and then click **Next**.

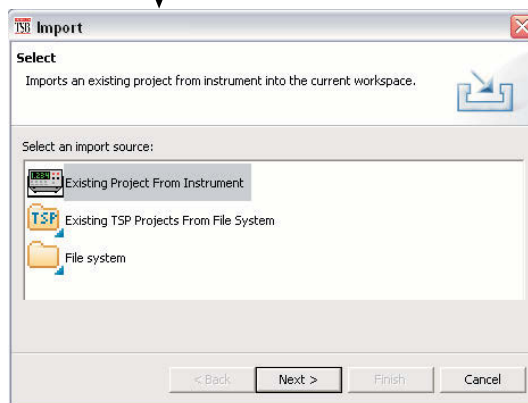

C) In the **Import Project From Instrument** box, click the **KIGeneral** project, and then click **Finish**.

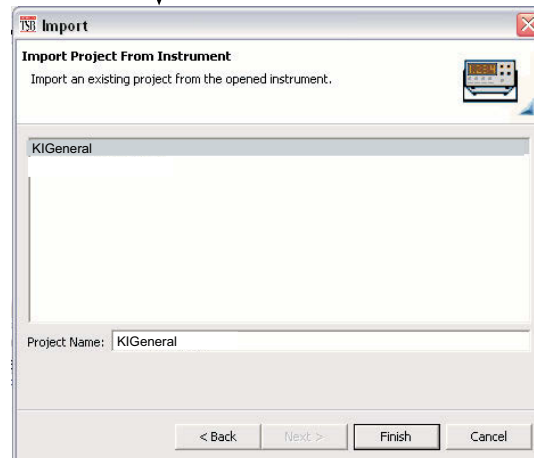
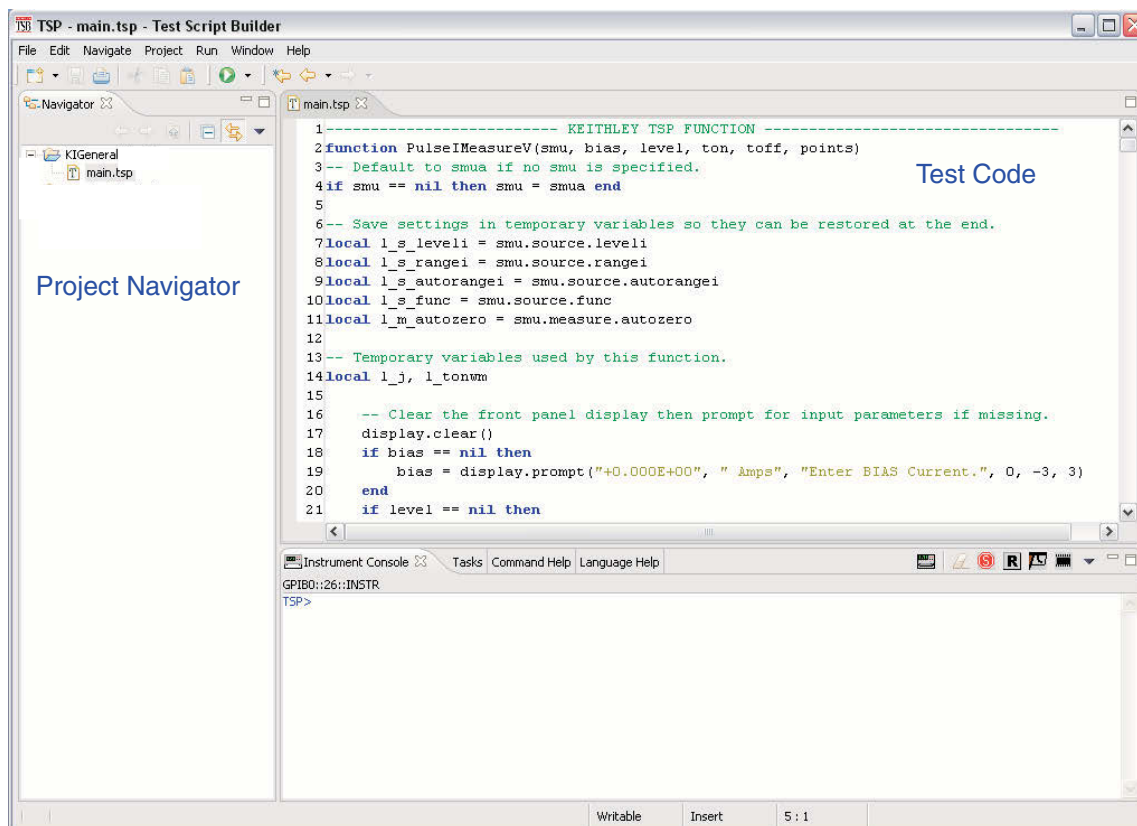

Figure 3-3  
**KIGeneral project imported into the Test Script Builder**



## Step 2: Modifying the test code for the SourceVMeasureI function

As shown in Figure 3-3, the test code for the script functions is contained in the tab for the "main.tsp" script file. The test code for all of the functions of the KIGeneral factory script are in this tab. Use the scroll buttons on the right side of the tab to view more code.

### Editing example

The following line of code in the "main.tsp" script file applies to the SourceVMeasureI function:

```
92    bias = display.prompt("+00.000", " Seconds", "Enter
    BIAS Voltage.", 0, -40, 40)
```

The above command defines a display input field and message prompt for entering the bias voltage. The -40 parameter sets the minimum voltage that can be entered, and the 40 parameter sets the maximum voltage that can be entered.



Now assume you wish to change the bias input limits to  $\pm 10V$ . Edit the line of code to the following:

```
92      bias = display.prompt("+00.000", " Seconds", "Enter
      BIAS Voltage.", 0, -10, 10)
```

**Saving the script** – After modifying the script file, it must be saved by clicking the save icon on the toolbar of the Test Script Builder as follows:

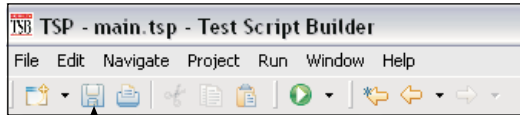

Click to save the "main.tsp" script file

### Step 3: Storing the script in non-volatile memory of the Series 2600

**Reference** Refer to "User scripts" in Section 2 of the Series 2600 Reference Manual for more information on storing user scripts in non-volatile memory.

After modifying a factory script, it can be loaded back into the Series 2600 and saved in non-volatile memory as a user script.

1. The **Run** configuration box is used to launch (load) a user script into the Series 2600 and save it in non-volatile memory. As shown below, open the **Run** box and then click **Run** in the drop-down menu:

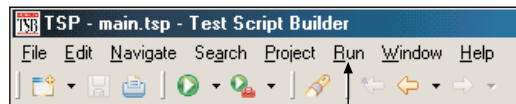

Click Run and then click Run in the drop-down menu.

**NOTE** **Figure 3-4 and 7.** show how the Run box will look after the launch is configured.

Figure 3-4  
Run configuration example - Main tab shown

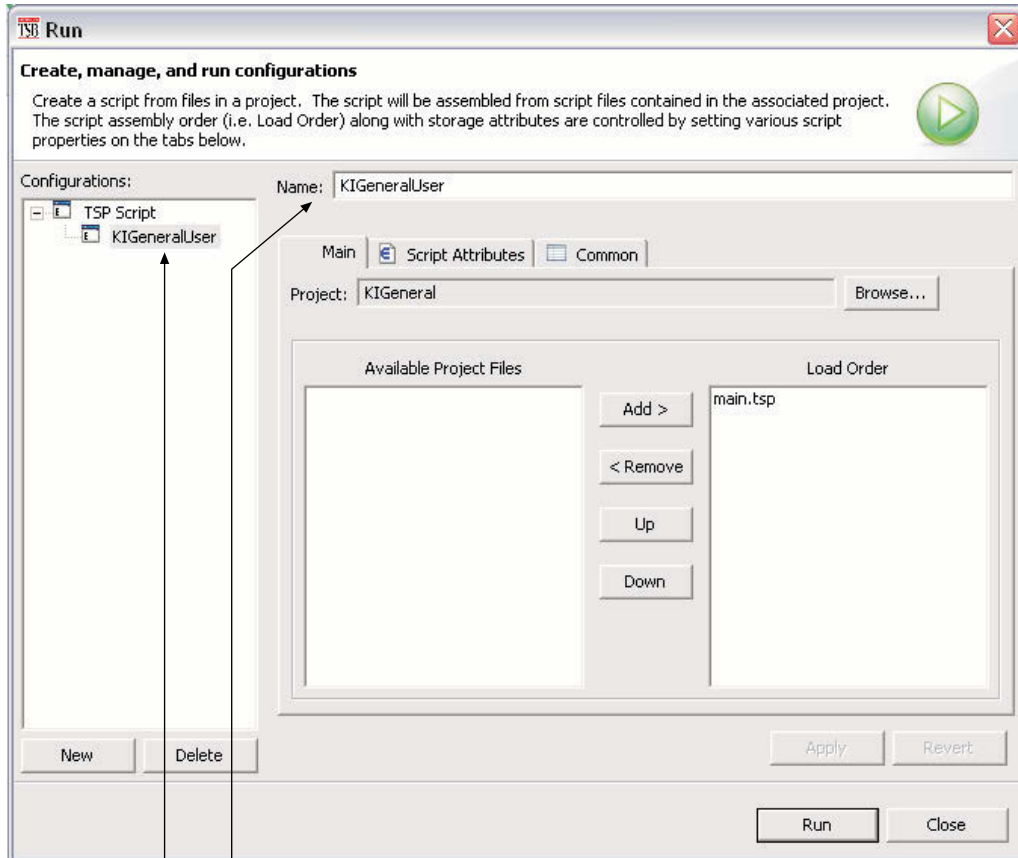

Changing the script **Name** from **KIGeneral** to **KIGeneralUser** also changes the name in the **Configurations** area.

2. In the Configurations area of the Run box, select the KIGeneral script. The launch configuration tabs for that script will appear in the Run box.
3. Presently, the Name of the script is KIGeneral. You should change the name so the script is not confused with the factory script of the same name that resides in the Series 2600. Change the script Name to KIGeneralUser and click the Apply button.

4. As shown in [Figure 3-4](#), the main.tsp file must be in the Load Order area of the Run box. If it is in the Available Project Files area, double-click main.tsp to move the file over.

Figure 3-5

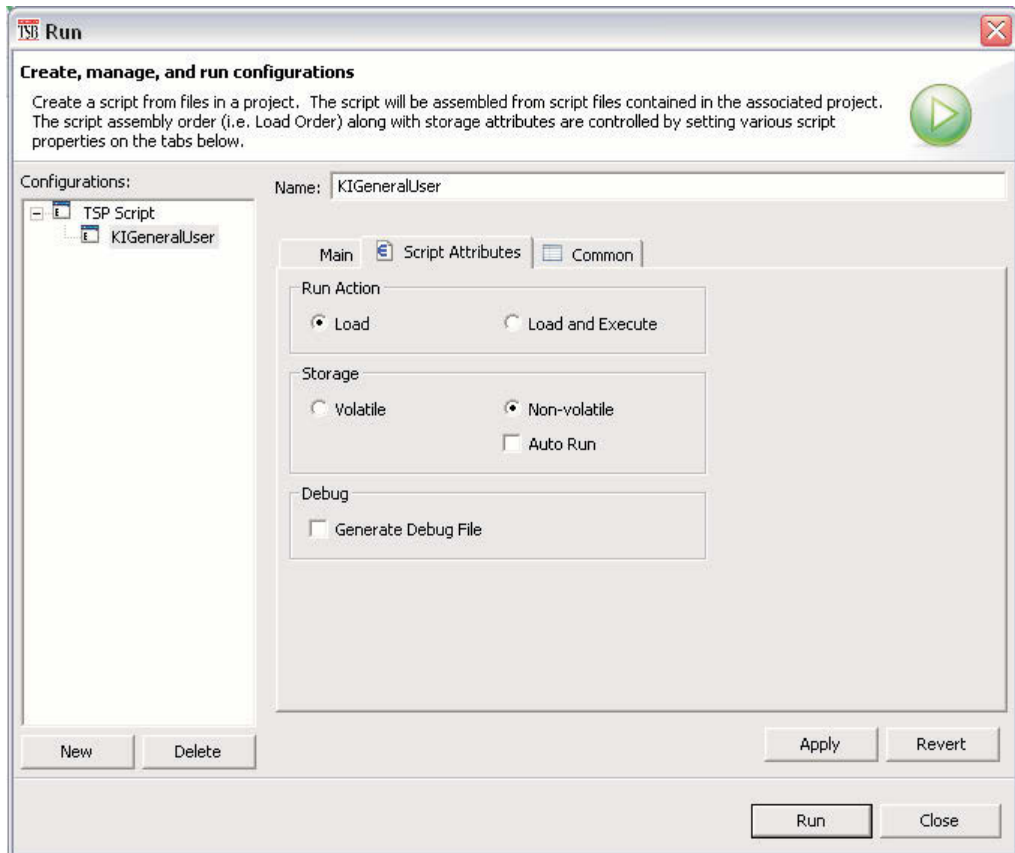
**Run configuration example - Script Attributes tab shown**

5. Click the Script Attributes tab to display the load and store options and select the LoadOnly run action and Non-volatile storage as shown in 7..
6. Click the Apply button to set the run configuration.
7. Click the Run key to load the user script into non-volatile memory of the Series 2600.

**NOTE**

There is small bar graph at the bottom-right of the Test Script Builder that will appear while a script is loading. The bar graph will continuously sequence through its segments while the script is loading.

## Running the user script

**Reference** Refer to “User scripts” in Section 2 of the Series 2600 Reference Manual for details on running a user script.

### Remote programming

The functions for the KIGeneralUser user script can be called after the script is run as follows:

```
KIGeneralUser()
```

After the above command is executed, any of the functions that make up the user script can be called in the same manner that factory script functions are called (refer to “[Step 1: Call the function](#)”).

### Front panel operation

To run the script from the front panel, a test name has to be added to the **USER TESTS** submenu of the **LOAD TEST** menu. Since the KIGeneralUser script is made up of eight functions, a front panel user test must run the script and also call a function. The following command will add the test name “PulseVMeasI” to the menu. It will also configure the test to run the KIGeneralUser script and call the PulseVMeasureI function:

```
display.loadmenu.add("PulseVMeasI", "KIGeneralUser()  
PulseVMeasureI()", display.SAVE)
```

Since no parameters are used in the function (PulseVMeasureI()), the test will be interactive and require the operator to input the test parameters using the front panel controls. Refer to “[How do I run a script from the front panel?](#)” described on earlier in this section for details on running a user script from the front panel.

The command `display.loadmenu.add` can be used to configure front panel user tests for the other functions of the script. Make sure to use a different menu name for each function. For example, the following command will add the name “PulseI MeasV” for a test to call the PulseI MeasureV function.

```
display.loadmenu.add("PulseI MeasV", "KIGeneralUser()  
PulseI MeasureV()", display.SAVE)
```

**Reference** Refer to “Load test menu” in Section 14 of the Series 2600 Reference Manual for details on the `display.loadmenu.add` function.

## Deleting a user script and user tests

### Deleting a user script

A user script can be deleted from non-volatile memory of the Series 2600. The following command will delete the `KIGeneralUser` user script:

```
script.delete("KIGeneralUser")
```

### Deleting a user test

After deleting a script, you should also delete the test from the **USER TESTS** menu since it no longer exists. The following command deletes the "PulseVMeasI" test from the menu:

```
display.loadmenu.delete("PulseVMeasI")
```

**Reference** Refer to "User scripts" in Section 2 of the Series 2600 Reference Manual for more information on deleting a user script. Refer to "Load test menu" in Section 14 of the Reference Manual for details on deleting user tests from the front panel **USER TESTS** menu.

## How do I use other programs?

**Reference** Refer to the LabVIEW and Visual Basic documentation for details on using those programs.

### Using LabVIEW

#### Source step example

The source step example is shown in [Figure 3-6](#). The example steps the source voltage from 1V to 10V in 1V steps, measures the current at each step, and stores the result in a table. Once all steps are completed, the stored table current values are printed.

The Series 2600 command sequence:

```
localnode.prompts = 0           -- Disable prompts.
data_table = {}                 -- Clear table.
reset()                          -- Reset Series 2600.
smua.source.output = 1         -- Turn on source output.
for i=1,10 do                   -- Loop for 10 steps.
    smua.source.levelv = i      -- Set source level.
    mi = smua.measure.i()       -- Take a current measurement.
    table.insert(data_table,mi) -- Store measurement in table.
end                               -- End of loop.
smua.source.output = 0         -- Turn off output.
print(table.concat(data_table,',')) -- Print table of current values.
reset()                          -- Reset instrument.
```

Figure 3-6  
LabVIEW source step example

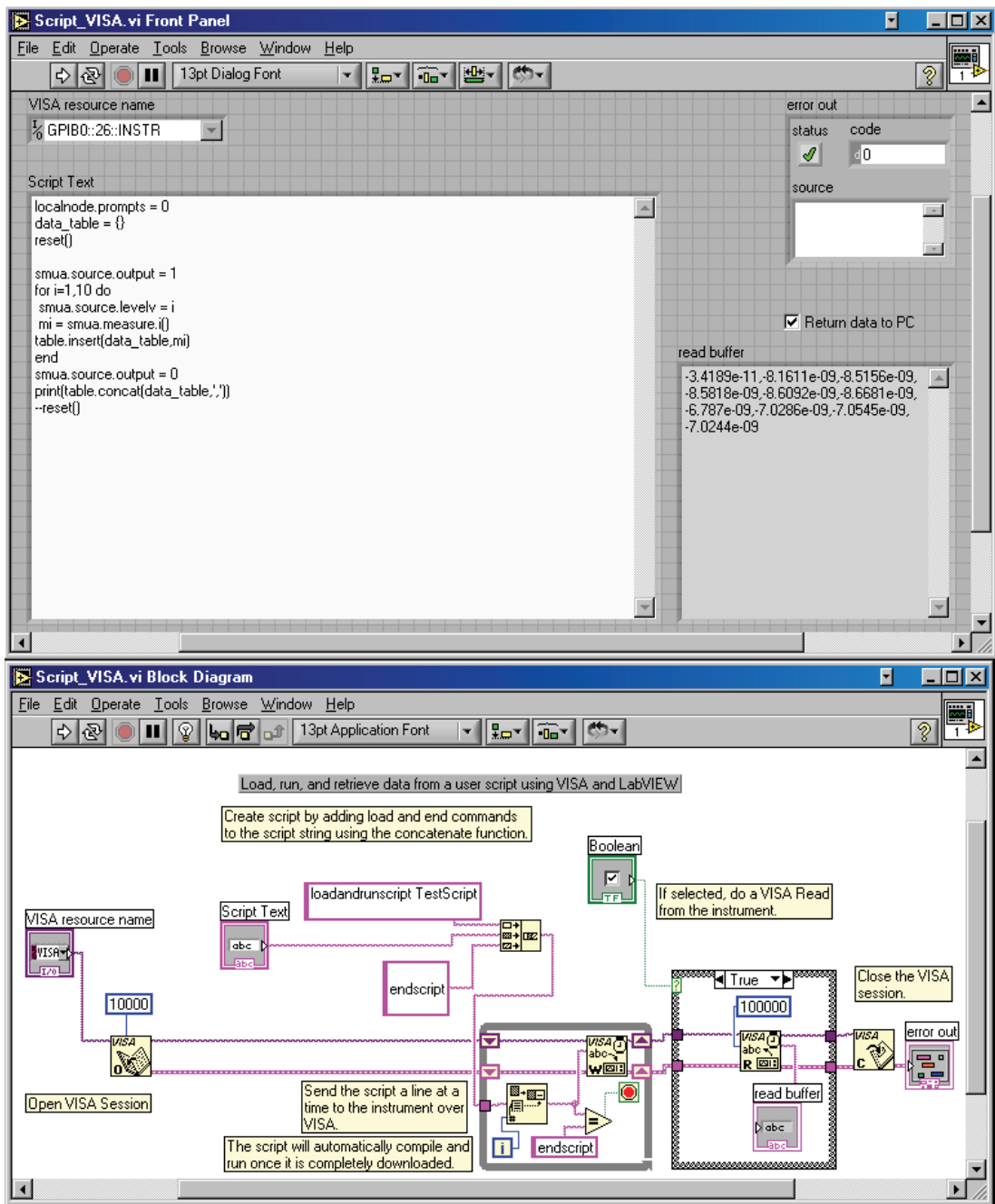

## Using Visual Basic

**NOTE**      **The form file (UserManualExample.frm) can be opened using any text editor to view the code executed by the various command buttons.**

The following examples look at how you can download and run Model 2600 Series scripts using Visual Basic. Two scripts were created for these examples. Both scripts are based on the pseudocode and instrument commands presented in [Section 2](#) on using the Series 2600 as a traditional GPIB instrument while multiple measurements are performed.

### Example script 1 – script that does not use functions

The following script is in the file named “MeasCurrScript.tsp.” Note that the actual script contains additional comments, which have not been included here. Comments are identified by double dashes (--).

```

reset()
display.screen = display.SMUA
display.smua.measure.func = display.MEASURE_DCAMPS
smua.source.func = smua.OUTPUT_DCVOLTS
smua.source.autorangev = smua.AUTORANGE_ON
smua.source.levelv = 5
smua.source.limiti = 0.1
smua.measure.rangei = 0.1
smua.measure.nplc = 1
smua.source.output = smua.OUTPUT_ON
ntimes = 10
for i = 1, ntimes do
    print(smua.measure.i())
end --for
smua.source.output = smua.OUTPUT_OFF

```

-- Perform following command(s) ntimes.  
-- Measure current and put reading in output queue.

The primary code that reads the file and downloads the script to the Series 2600 is listed below. This code is executed when you select the **Load “Non-Function” Script** option, and then click the **Load Script (GPIB)** command button. Although not required, TSP prompts are enabled for this example because they provide useful test script processor status information when loading and running scripts. Refer to the Series 2600 System SourceMeter Instruments Reference Manual for more information about using prompts. As the script is being downloaded, it is displayed in the **Script** text box of the GUI (Graphical User Interface), as shown in [Figure 3-7](#).



Figure 3-7  
 GUI after loading the non-function script (GPIB)

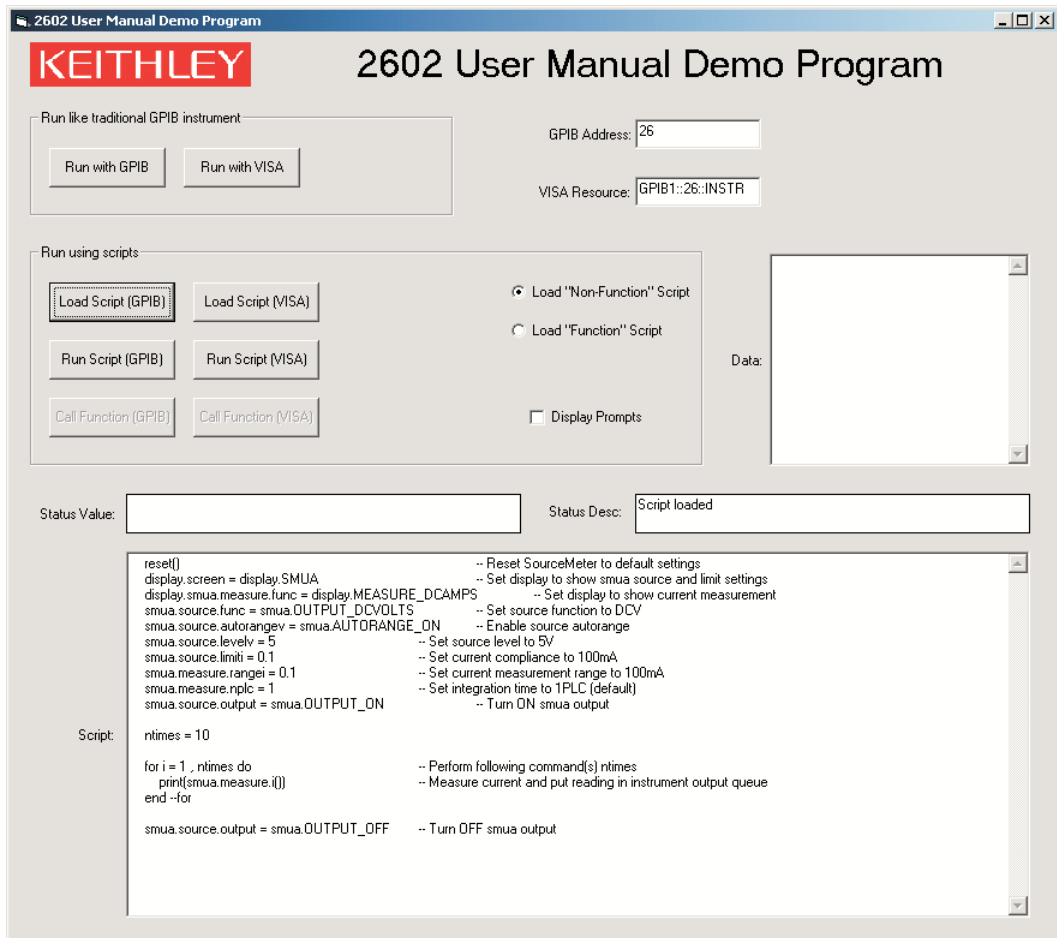

```

Call send(Addr%, "localnode.showerrors =
0", intStatus)

Call send(Addr%, "localnode.prompts = 1",
intStatus)
strReturnMessage = udfGetTspResponse()
Open App.Path & "\" & "MeasCurr-
Script.tsp" For Input As #1
Call send(Addr%, "loadscript MeasCurr-
Script", intStatus)
strReturnMessage = udfGetTspResponse()

Do While Not EOF(1)

Line Input #1, strScriptline
Call send(Addr%, strScriptline, intSta-
tus)
strReturnMessage = udfGetTspResponse()
strReturnMessage = Left(strReturnMessage,
4)
Select Case strReturnMessage
  Case ">>>>"

      Case "TSP>"

Exit Do
Case "TSP?"

Case Else

End Select
Loop
Close #1
Call send(Addr%, "endscript", intStatus)
strReturnMessage = udfGetTspResponse()

```

--Disable automatic display of errors - leave error messages in queue and enable Error Prompt. The "localnode" unit is being communicated with via GPIB or RS-232.

--Turn on prompts; need to start handling the prompts as soon as this command is sent.

--Open the script file for sequential input.

---"loadscript" identifies the beginning of the script. "MeasCurrScript" is the name assigned to the script.

--Read the file.

--Loop until the end of the script file.

--Read a line from the script file

--Send script line to Series 2600

--Continuation prompt. TSP received script line successfully; waiting for next line.

--Ready prompt. TSP received script successfully; ready for next command.

--Error prompt. Error occurred; handle as desired. Use "errorqueue" commands to read and clear errors.

--No prompt received. Response other than shell prompt was received; handle as desired.

--Close the script file.

--Tell TSP complete script has been downloaded.

```
Call send(Addr%, "localnode.prompts = 0", --Disable prompts.
intStatus)
```

The primary code that runs the script and retrieves the measurement results is listed below. This code is executed when you click the **Run Script (GPIB)** command button. When you run this script it will perform ten measurements and send the readings to the PC. The results are displayed in the **Data** text box of the GUI as shown in [Figure 3-8](#). TSP prompts are enabled prior to running the script

The following command runs the script; can also use "MeasCurrScript()" form of the command

```
Call send(Addr%, "MeasCurrScript.run()", --Get output from script.
intStatus)
```

```
Do
strReturnMessage = udfGetTspResponse()
txtData.Text = txtData.Text & strReturnMessage
Loop Until Left(strReturnMessage, 3) = "TSP"
If strReturnMessage = "TSP?" Then
txtStatusDesc.Text = "Error Occurred"
Call send(Addr%, "print(errorqueue.next())",
intStatus)
strReturnMessage = udfGetTspResponse()
txtStatusDesc.Text = txtStatusDesc.Text & str-
ReturnMessage &
vbCrLf
End If
```

Figure 3-8  
GUI after running the non-function script (GPIB)

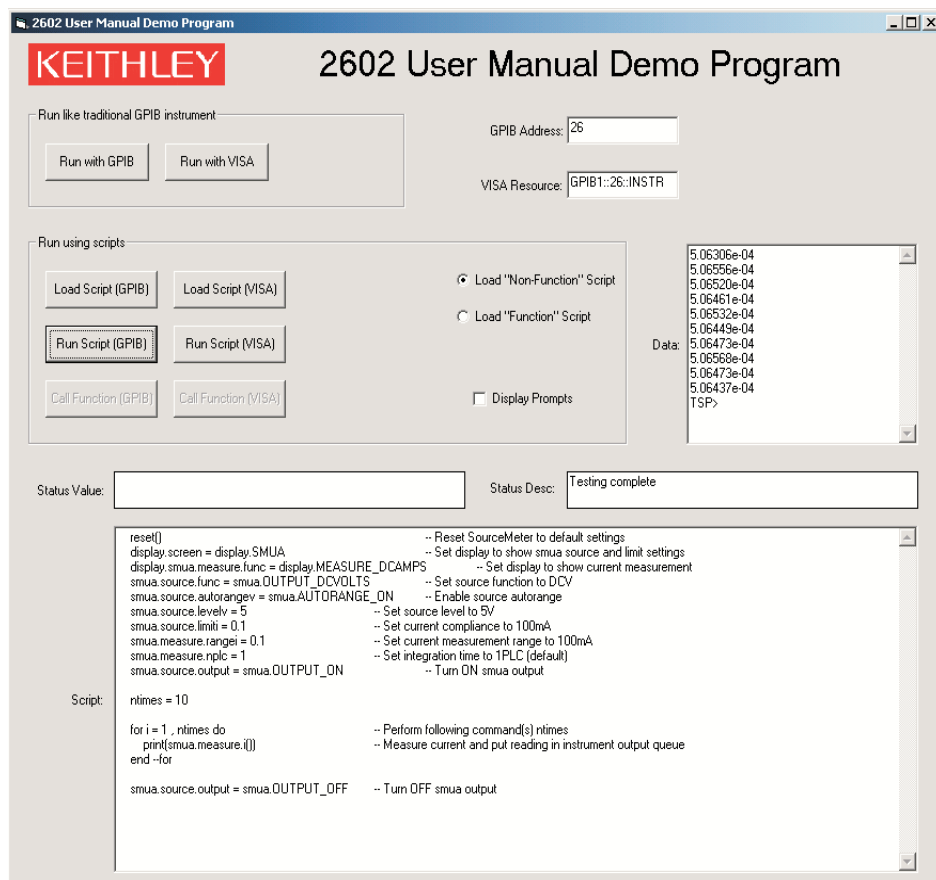

### Example script 2 – script that uses functions

The script used in this example is in the file named “MeasCurrFunctionScript.tsp.” This script is downloaded to the Series 2600 by selecting the **Load “Function” Script** option, and then clicking the **Load Script (GPIB)** command button. The script is downloaded exactly as shown in the previous example, except the “open file” and “loadscript” commands reflect the different script name, as shown below.

```
Open App.Path & "\" & "MeasCurrFunctionScript.tsp" For Input As #1
Call send(Addr%, "loadscript MeasCurrFunctionScript", intStatus)
```

The other difference is in the script itself, which is listed below. This script does not perform multiple current measurements, but rather it creates a function named “MeasCurr,” which performs one or more current measurements when it is called. The number of measurements depends on the value of “nimes,” which is passed

to the function when it is called. [Figure 3-9](#) shows the GUI (Graphical User Interface) after loading and running the script. Note that the **Data** text box does not contain any readings as in the previous example; it simply indicates that the "MeasCurr(ntimes)" function has been created.

```
function MeasCurr(ntimes)
    local l_i -- Local counter variable

    reset()
    display.screen = display.SMUA
    display.smua.measure.func = display.MEASURE_DCAMPS
    smua.source.func = smua.OUTPUT_DCVOLTS
    smua.source.autorangev = smua.AUTORANGE_ON
    smua.source.levelv = 5
    smua.source.limiti = 0.1
    smua.measure.rangei = 0.1
    smua.measure.nplc = 1
    smua.source.output = smua.OUTPUT_ON

    for l_i = 1, ntimes do
        print(smua.measure.i())
    end --for

    smua.source.output = smua.OUTPUT_OFF
end --function

print("Function 'MeasCurr(ntimes)' created")
```

Figure 3-9  
GUI after loading and running the function script (GPIB)

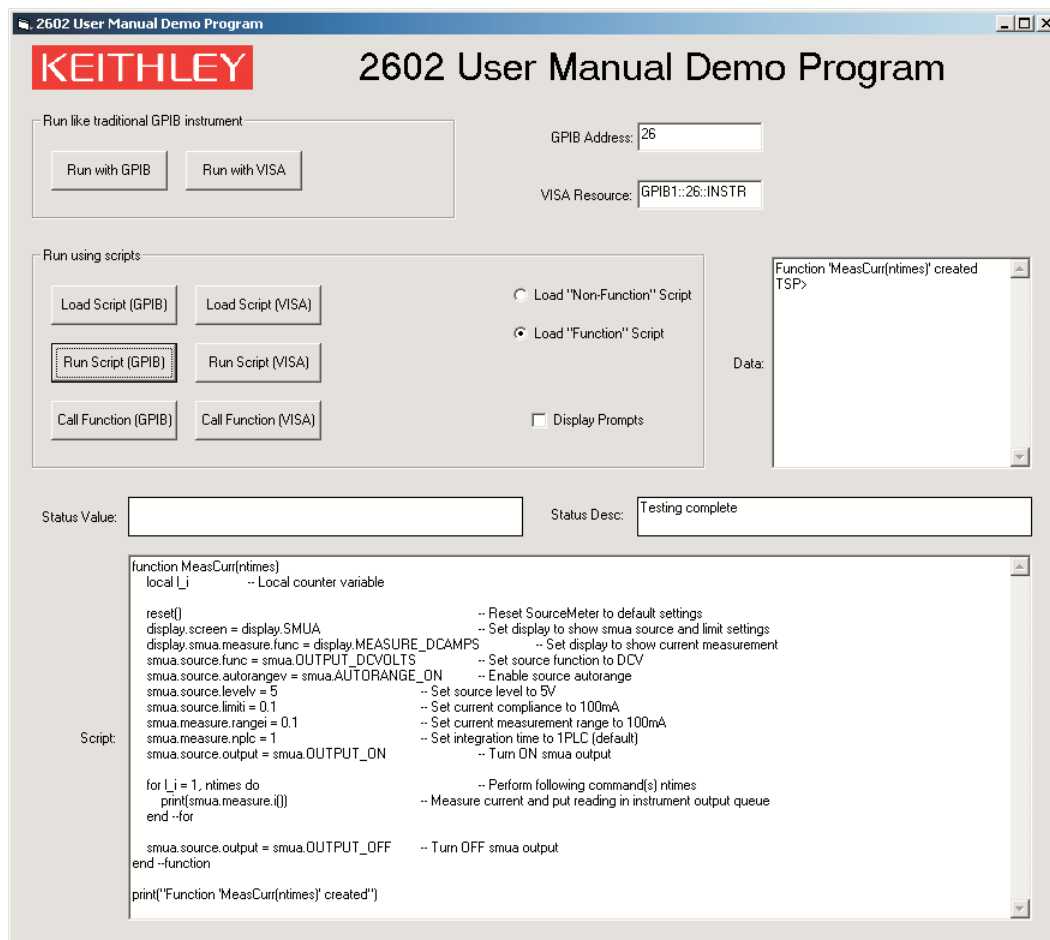

The primary code that calls the function and retrieves the measurement results is listed below. TSP prompts are enabled prior to calling the function. This code is executed when you click the Call Function (GPIB) command button. In this example, the function performs ten current measurements and sends the readings to the PC because "ntimes" is set to 10 when the function is called. The results are displayed in the **Data** text box as shown in [Figure 3-10](#). Note that it would be just as easy to take one or 100 readings simply by calling the function with a different value for "ntimes," for example, MeasCurr(100). You can pass parameters to a function, but not to a script. However, you must initially run a script to create a function. Refer to the Series 2600 Reference Manual for more information about scripts and functions.

```
Call send(Addr%, "MeasCurr(10)", intStatus)           --Call function with ntimes=10
                                                       and then enter data.
Do                                                     --Get output from function.
  strReturnMessage = udfGetTspResponse()
  txtData.Text = txtData.Text & strReturnMessage &
vbCrLf
Loop Until Left(strReturnMessage, 3) = "TSP"
If strReturnMessage = "TSP?" Then
  txtStatusDesc.Text = "Error Occurred"
  Call send(Addr%, "print(errorqueue.next())",
intStatus)
  strReturnMessage = udfGetTspResponse()
  txtStatusDesc.Text = txtStatusDesc.Text & strRe-
turnMessage & vbCrLf
End If                                               --Take appropriate action
                                                       based on error message.
```

Figure 3-10  
GUI after calling the function (GPIB)

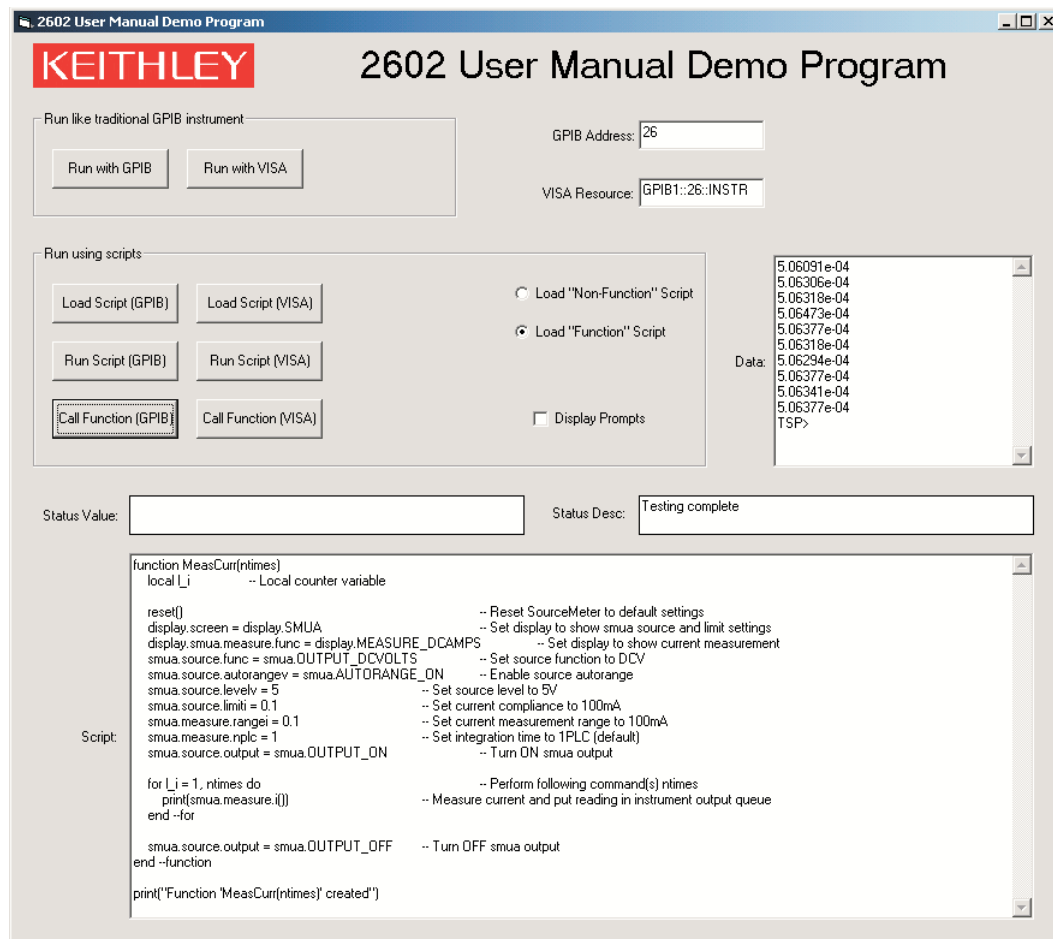



---

## Controlling Multiple SourceMeters (TSP-Link)

### In this section:

Topic	Page
<b>How do I set up the TSP-Link system?</b>	4-2
Connect the TSP-Link system	4-2
Assign node numbers	4-2
Reset the TSP-Link	4-3
Check the state of the TSP-Link system	4-4
<b>How do I use the expanded system?</b>	4-4
Accessing resources of TSP-Link nodes	4-4
Using node[N]	4-4
Using the alias (localnode)	4-4
Running scripts in a TSP-Link system	4-5

## How do I set up the TSP-Link system?

Up to 64 TSP-Link-enabled instruments (e.g., Series 2600 SourceMeters) can be connected together to form a TSP-Link system.

### Step 1: Connect the TSP-Link system

**Reference** Refer to “Connections” in Section 9 of the Series 2600 Reference Manual for more information on TSP-Link connections.

A connection example for an expanded system is shown in [Figure 4-1](#). All the TSP-Link-enabled instruments in the system are daisy-chained together using LAN crossover cables. In this example, the unit connected to the PC is the Master and the other units are its Slaves. Note that the Master does not have to be assigned as Node 1, nor does it have to be at the end of the node chain.

Figure 4-1  
TSP-Link connections

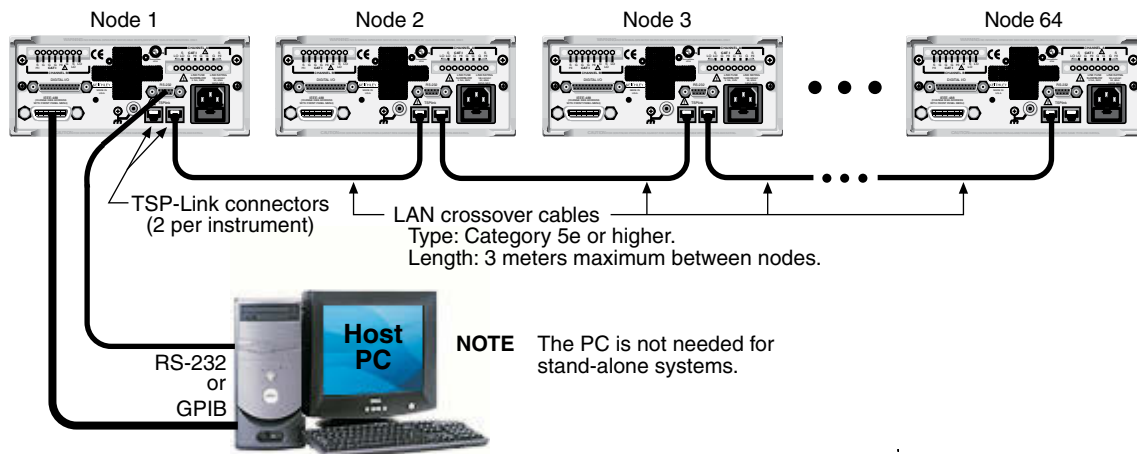

### Step 2: Assign node numbers

**Reference** Refer to “Initialization” in Section 9 of the Series 2600 Reference Manual for more information on assigning node numbers.

Each instrument in the TSP-Link system must have a unique node number assigned to it. The node number for each instrument is stored in its non-volatile memory and will not be lost when the instrument is turned off.

The TSP-Link node number is set from the **MAIN MENU** of each instrument and is summarized in [Table 4-1](#).

Table 4-1

**Assigning a node number to an instrument from the front panel**

Series 2600 MAIN MENU
1) Press the <b>MENU</b> key to access <b>MAIN MENU</b> .
2) Select <b>COMMUNICATION</b> menu.
3) Select <b>TSPLINK_CFG</b> menu.
4) Select <b>NODE</b> menu.
5) Set the <b>NODE</b> number ( <b>01</b> to <b>64</b> ) for the instrument.

For remote programming, the `tsplink.node` attribute is used to set the node number for an instrument:

```
tsplink.node = N
  where: N = 1 to 64
```

The node number of an instrument can be determined by reading the `tsplink.node` attribute as follows:

```
nodenumber = tsplink.node
print(nodenumber)
```

The above `print` command will return the node number. For example, if the node number is 1, the value `1.000000e00` will be returned.

**Step 3: Reset the TSP-Link**

**Reference** Refer to “Initialization” in Section 9 of the Series 2600 Reference Manual for more information on resetting the TSP-Link.

After all the node numbers are set, you must reset (initialize) the TSP-Link interface system. For initialization to succeed, all units must be powered on when the TSP-Link reset is performed.

The TSP-Link reset can be performed from the **MAIN MENU** of any instrument in the system; this process is summarized in [Table 4-2](#).

Table 4-2

**Resetting the TSP-Link from the front panel**

Series 2600 MAIN MENU
1) Press the <b>MENU</b> key to access <b>MAIN MENU</b> .
2) Select <b>COMMUNICATION</b> menu.
3) Select <b>TSPLINK-CFG</b> menu.
4) Select <b>RESET</b> to initialize the TSP-Link.

For remote programming, the following command initializes the TSP-Link:

```
tsplink.reset()
```

## Step 4: Check the state of the TSP-Link system

**Reference** Refer to “Initialization” in Section 9 of the Series 2600 Reference Manual for more information on checking the state of the TSP-Link.

The `tsplink.state` read-only attribute is used to determine whether or not the TSP-Link reset routine was completed successfully. The returned value `online` indicates that the reset was successful for all instruments (nodes) in the system. The value `offline` indicates that the reset has failed.

A few typical reasons for a reset failure include the following:

- Two or more instruments in the system have the same node number.
- There are no other instruments connected to the unit performing the reset.
- One of the units in a properly connected system isn't powered on.

**Programming example** – After assigning node numbers to the instruments in the system, the following command checks the state of the TSP-Link:

```
print(tsplink.state)
```

If the reset is successful, `online` will be the output to indicate that communication to all nodes is established.

## How do I use the expanded system?

**Reference** Refer to “Using the expanded system” in Section 9 of the Series 2600 Reference Manual for more information on using the system.

### Accessing resources of TSP-Link nodes

After a successful TSP-Link reset, the `node` and `localnode` variables can be used to access resources of any node in the system.

#### Using `node[N]`

The `node[N]` variable (where  $N = 1$  to  $64$ ) is used to send a command to any node in the system. The node can be the Master or a Slave. Examples:

```
node[4].smua.reset()    -- Resets SMU A of Node 4.  
node[1].smua.reset()    -- Resets SMU A of Node 1.
```

#### Using the alias (`localnode`)

The variable `localnode` is an alias for `node[N]`, where  $N$  is the node number of the Master.

For example, assume that Node 1 is the Master in a TSP-Link system. To send a command to Node 1, you can use `node[1]` or `localnode` as follows:

```
node[1].smua.reset()    -- Resets SMU A of the Master (Node 1).  
localnode.smua.reset()  -- Resets SMU A of the Master (Node 1).
```

## Running scripts in a TSP-Link system

For remote programming, only a script stored in the Master can be run. Scripts in the Slaves cannot be accessed. Refer to [“How do I interact with scripts using Test Script Builder?”](#) in [Section 3](#).

For front panel operation, a script in any node can be run from its front panel. For details, refer to [“How do I run a script from the front panel?”](#) in [Section 3](#).

This page left blank intentionally.

# Appendix A

---

## Specifications

**In this Appendix:**

[Model 2600S Specifications](#), page A-2

# 2601 2602

# System SourceMeter® Multi-Channel I-V Test Solutions

## SPECIFICATION CONDITIONS

This document contains specifications and supplemental information for the Models 2601 and 2602. Specifications are the standards against which the Models 2601 and 2602 are tested. Upon leaving the factory the 2601 and 2602 meet these specifications. Supplemental and typical values are non-warranted, apply at 23°C, and are provided solely as useful information.

The source and measurement accuracies are specified at the SourceMeter CHANNEL A (2601 and 2602) or SourceMeter CHANNEL B (2602) terminals under the following conditions:

1. 23°C ± 5°C, <70% relative humidity.
2. After 2 hour warm-up.
3. Speed normal (1 NPLC).
4. A/D auto-zero enabled.
5. Remote sense operation or properly zeroed local operation.
6. Calibration period = 1 year.

## SOURCE SPECIFICATIONS

### VOLTAGE PROGRAMMING ACCURACY<sup>1</sup>

RANGE	PROGRAMMING RESOLUTION	ACCURACY (1 Year) 23°C ± 5°C ±(% rdg. + volts)	TYPICAL NOISE (peak-peak) 0.1Hz–10Hz
100.000 mV	5 μV	0.02% + 250 μV	20 μV
1.00000 V	50 μV	0.02% + 400 μV	50 μV
6.00000 V	50 μV	0.02% + 1.8 mV	100 μV
40.0000 V	500 μV	0.02% + 12 mV	500 μV

TEMPERATURE COEFFICIENT (0°–18°C & 28°–50°C): ±(0.15 × accuracy specification)/°C.

MAXIMUM OUTPUT POWER AND SOURCE/SINK LIMITS<sup>2</sup>: 40.4W per channel maximum. ±40.4V @ ±1.0A, ±6.06V @ ±3.0A, four quadrant source or sink operation.

VOLTAGE REGULATION: Line: 0.01% of range. Load: ±(0.01% of range + 100μV).

NOISE 10Hz–20MHz (peak-peak): 25mV typical into a resistive load.

CURRENT LIMIT/COMPLIANCE<sup>3</sup>: Bipolar current limit (compliance) set with single value. Minimum value is 10nA. Accuracy same as current source.

OVERSHOOT: <±(0.1% + 10mV) typical (step size = 10% to 90% of range, resistive load, maximum current limit/compliance).

GUARD OFFSET VOLTAGE: <10mV typical (Iout ≤ 100mA).

### CURRENT PROGRAMMING ACCURACY

RANGE	PROGRAMMING RESOLUTION	ACCURACY (1 Year) 23°C ± 5°C ±(% rdg. + amps)	TYPICAL NOISE (peak-peak) 0.1Hz–10Hz
100.000 nA	1 pA	0.06% + 100 pA	5 pA
1.00000 μA	10 pA	0.03% + 600 pA	25 pA
10.0000 μA	100 pA	0.03% + 2 nA	50 pA
100.000 μA	1 nA	0.03% + 30 nA	3 nA
1.00000 mA	10 nA	0.03% + 200 nA	5 nA
10.0000 mA	100 nA	0.03% + 3 μA	200 nA
100.000 mA	1 μA	0.03% + 20 μA	500 nA
1.00000 A <sup>2</sup>	10 μA	0.05% + 900 μA	60 μA
3.00000 A <sup>2</sup>	10 μA	0.06% + 1.5 mA	150 μA

TEMPERATURE COEFFICIENT (0°–18°C & 28°–50°C): ±(0.15 × accuracy specification)/°C.

MAXIMUM OUTPUT POWER AND SOURCE/SINK LIMITS<sup>2</sup>: 40.4W per channel maximum. ±1.01A @ ±40.0V, ±3.03A @ ±6.0V, four quadrant source or sink operation.

CURRENT REGULATION: Line: 0.01% of range. Load: ±(0.01% of range + 100pA).

VOLTAGE LIMIT/COMPLIANCE<sup>4</sup>: Bipolar voltage limit (compliance) set with a single value. Minimum value is 10mV. Accuracy same as voltage source.

OVERSHOOT: <0.1% typical (step size = 10% to 90% of range, resistive load; see CURRENT SOURCE OUTPUT SETTLING TIME for additional test conditions).

## ADDITIONAL SOURCE SPECIFICATIONS

TRANSIENT RESPONSE TIME: <70μs for the output to recover to 0.1% for a 10% to 90% step change in load.

VOLTAGE SOURCE OUTPUT SETTLING TIME: Time required to reach 0.1% of final value, when changing from 10% to 90% of range, after source level command is processed on a fixed range.

100mV, 1V Ranges: <50μs typical.

6V Range: <100μs typical.

40V Range: <150μs typical.<sup>5</sup>

CURRENT SOURCE OUTPUT SETTLING TIME: Time required to reach 0.1% of final value, when changing from 10% to 90% of range, after source level command is processed on a fixed range. Values below for Iout · Rload = 2V unless noted.

3A–10mA Ranges: <80μs typical (current less than 2.5A, Rload >1.5Ω).

1mA Range: <100μs typical.

100μA Range: <150μs typical.

10μA Range: <500μs typical.

1μA Range: <2.5ms typical.

100nA Range: <25ms typical.

DC FLOATING VOLTAGE: Output can be floated up to ±250VDC from chassis ground.

REMOTE SENSE OPERATING RANGE<sup>1</sup>:

Maximum voltage between HI and SENSE HI = 3V.

Maximum voltage between LO and SENSE LO = 3V.

VOLTAGE OUTPUT HEADROOM:

40V Range: Max. output voltage = 42V – total voltage drop across source leads (maximum 1Ω per source lead).

6V Range: Max. output voltage = 8V – total voltage drop across source leads.

OVER TEMPERATURE PROTECTION: Internally sensed temperature overload puts unit in standby mode.

VOLTAGE SOURCE RANGE CHANGE OVERSHOOT: Overshoot into a 100kΩ load, 20MHz BW, 300mV typical.

CURRENT SOURCE RANGE CHANGE OVERSHOOT: <5% + 300mV/Rload of larger range typical. (See CURRENT SOURCE OUTPUT SETTLING TIME for additional test conditions.)

## NOTES

1. Add 50μV to source accuracy specifications per volt of HI lead drop.
2. Full power source operation regardless of load to 30°C ambient. Above 30°C and/or power sink operation, refer to Section 8 – Operating Boundaries in the Series 2600 Reference Manual for additional power derating information.
3. For sink mode operation (quadrants II and IV), add 12% of limit range and ±0.02% of limit setting to corresponding current limit accuracy specifications. For 1A range add an additional 40mA of uncertainty.
4. For sink mode operation (quadrants II and IV), add 10% of compliance range and ±0.02% of limit setting to corresponding voltage source specification. For 100mV range add an additional 60mV of uncertainty.
5. Add 150μs when measuring on the 1A range.



# 2601 2602

# System SourceMeter® Multi-Channel I-V Test Solutions

## METER SPECIFICATIONS

### VOLTAGE MEASUREMENT ACCURACY<sup>1</sup>

RANGE	DISPLAY RESOLUTION <sup>3</sup>	INPUT RESISTANCE	ACCURACY (1 Year) 23°C ±5°C ±(% rdg. + volts)
100.000 mV	1 μV	>10 GΩ	0.015% + 150 μV
1.00000 V	10 μV	>10 GΩ	0.015% + 200 μV
6.00000 V	10 μV	>10 GΩ	0.015% + 1 mV
40.0000 V	100 μV	>10 GΩ	0.015% + 8 mV

TEMPERATURE COEFFICIENT (0°–18°C & 28°–50°C): ±(0.15 × accuracy specification)/°C.

### CURRENT MEASUREMENT ACCURACY

RANGE	DISPLAY RESOLUTION <sup>3</sup>	VOLTAGE BURDEN <sup>2</sup>	ACCURACY (1 Year) 23°C ±5°C ±(% rdg. + amps)
100.000 nA	1 pA	<1 mV	0.05 % + 100 pA
1.00000 μA	10 pA	<1 mV	0.025% + 300 pA
10.0000 μA	100 pA	<1 mV	0.025% + 1.5 nA
100.000 μA	1 nA	<1 mV	0.02 % + 25 nA
1.00000 mA	10 nA	<1 mV	0.02 % + 200 nA
10.0000 mA	100 nA	<1 mV	0.02 % + 2.5 μA
100.000 mA	1 μA	<1 mV	0.02 % + 20 μA
1.00000 A	10 μA	<1 mV	0.03 % + 1.5 mA
3.00000 A	10 μA	<1 mV	0.05 % + 3.5 mA

TEMPERATURE COEFFICIENT (0°–18°C & 28°–50°C): ±(0.15 × accuracy specification)/°C.

### CONTACT CHECK<sup>4</sup>

SPEED	MAXIMUM MEASUREMENT TIME TO MEMORY FOR 60Hz (50Hz) <sup>4</sup>	ACCURACY (1 Year) 23°C ±5°C ±(%rdg. + ohms)
FAST	1 (1.2) ms	5% + 10
MEDIUM	4 (5) ms	5% + 1
SLOW	36 (42) ms	5% + 0.3

### ADDITIONAL METER SPECIFICATIONS

LOAD IMPEDANCE: Stable into 10,000pF typical.

COMMON MODE VOLTAGE: 250VDC.

COMMON MODE ISOLATION: >1GΩ, <4500pF

OVERRANGE: 101% of source range, 102% of measure range.

MAXIMUM SENSE LEAD RESISTANCE: 1kΩ for rated accuracy.

SENSE INPUT IMPEDANCE: >10GΩ.

### NOTES

1. Add 50μV to source accuracy specifications per volt of HI lead drop.
2. Four-wire remote sense only.
3. Applies when in single channel display mode.
4. Includes measurement of SENSE HI to HI and SENSE LO to LO contact resistances.

## GENERAL

HOST INTERFACES: Computer control interfaces.

IEEE-488: IEEE-488.1 compliant. Supports IEEE-488.2 common commands and status model topology.

RS-232: Baud rates from 300 bps to 115200 bps. Programmable number of data bits, parity type, and flow control (RTS/CTS hardware or none). When not programmed as the active host interface, the SourceMeter can use the RS-232 interface to control other instrumentation.

EXPANSION INTERFACE: The TSP-Link expansion interface allows TSP enabled instruments to trigger and communicate with each other.

Connector: Category 5e or higher LAN crossover cable.

Length: 3 meters maximum between each TSP enabled instrument.

DIGITAL I/O INTERFACE:

Connector: 25-pin female D.

Input/Output Pins: 14 open drain I/O bits.

Absolute Maximum Input Voltage: 5.25V

Absolute Minimum Input Voltage: –0.25V

Maximum Logic Low Input Voltage: 0.7V + 850μA max.

Minimum Logic High Input Voltage: 2.1V + 570μA.

Maximum Source Current (flowing out of Digital I/O bit): +960μA.

Maximum Sink Current @ Maximum Logic Low Voltage (0.7V): –5.0mA.

Absolute Maximum Sink Current (flowing into Digital I/O pin): –11mA.

5V Power Supply Pin: Limited to 600mA, solid state fuse protected.

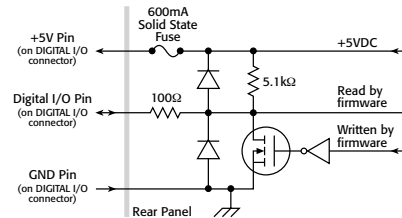

**Output Enable Pin:** Active high input pulled down internally to ground with 10kΩ resistor. When the Output Enable input function has been activated, each SourceMeter channel will not turn on unless the Output Enable pin is driven to >2.1V (nominal current = 2.1V / 10kΩ = 210μA).

POWER SUPPLY: 100V to 240VAC, 50–60Hz (manual setting), 240VA max.

COOLING: Forced air. Side intake and rear exhaust. One side must be unobstructed when rack mounted.

WARRANTY: 1 year.

EMC: Conforms to European Union Directive 89/336/EEC, EN 61326-1.

SAFETY: Conforms to European Union Directive 73/23/EEC, EN 61010-1, and UL 61010-1.

DIMENSIONS: 89mm high × 213mm wide × 460mm deep (3½ in × 8½ in × 17½ in). Bench Configuration (with handle & feet): 104mm high × 238mm wide × 460mm deep (4½ in × 9½ in × 17½ in).

WEIGHT: 2601: 4.75kg (10.4 lbs). 2602: 5.50kg (12.0 lbs).

ENVIRONMENT: For indoor use only.

Altitude: Maximum 2000 meters above sea level.

Operating: 0°–50°C, 70% R.H. up to 35°C. Derate 3% R.H./°C, 35°–50°C.

Storage: –25°C to 65°C.

# 2611 2612

# System SourceMeter® Multi-Channel I-V Test Solutions

## SPECIFICATION CONDITIONS

This document contains specifications and supplemental information for the Models 2611 and 2612. Specifications are the standards against which the Models 2611 and 2612 are tested. Upon leaving the factory the 2611 and 2612 meet these specifications. Supplemental and typical values are non-warranted, apply at 23°C, and are provided solely as useful information.

The source and measurement accuracies are specified at the SourceMeter CHANNEL A (2611 and 2612) or SourceMeter CHANNEL B (2612) terminals under the following conditions:

1. 23°C ± 5°C, <70% relative humidity.
2. After 2 hour warm-up.
3. Speed normal (1 NPLC).
4. A/D auto-zero enabled.
5. Remote sense operation or properly zeroed local sense operation.
6. Calibration period = 1 year.

## SOURCE SPECIFICATIONS

### VOLTAGE PROGRAMMING ACCURACY<sup>1</sup>

RANGE	PROGRAMMING RESOLUTION	ACCURACY (1 Year) 23°C ± 5°C ±(% rdg. + volts)	NOISE (peak-peak) 0.1Hz–10Hz
200.000 mV	5 μV	0.02% + 375 μV	20 μV
2.00000 V	50 μV	0.02% + 600 μV	50 μV
20.0000 V	500 μV	0.02% + 5 mV	300 μV
200.000 V	5 mV	0.02% + 50 mV	2 mV

TEMPERATURE COEFFICIENT (0°–18°C & 28°–50°C): ±(0.15 × accuracy specification)/°C.

MAXIMUM OUTPUT POWER AND SOURCE/SINK LIMITS<sup>2</sup>: 30.603W per channel maximum. ±20.2V @ ±1.515A, ±202V @ ±101mA, four quadrant source or sink operation.

VOLTAGE REGULATION: Line: 0.01% of range. Load: ±(0.01% of range + 100μV).

NOISE 10Hz–20MHz: <5mV RMS typical, 20V range, 1A limit.

CURRENT LIMIT/COMPLIANCE<sup>3</sup>: Bipolar current limit (compliance) set with single value. Minimum value is 10nA. Accuracy same as current source.

OVERSHOOT: <±(0.1% + 10mV) typical (step size = 10% to 90% of range, resistive load, maximum current limit/compliance).

GUARD OFFSET VOLTAGE: <4mV (current ≤10mA).

### CURRENT PROGRAMMING ACCURACY<sup>4</sup>

RANGE	PROGRAMMING RESOLUTION	ACCURACY (1 Year) 23°C ± 5°C ±(% rdg. + amps)	NOISE (peak-peak) 0.1Hz–10Hz
100.000 nA	2 pA	0.06% + 100 pA	5 pA
1.00000 μA	20 pA	0.03% + 800 pA	25 pA
10.0000 μA	200 pA	0.03% + 5 nA	60 pA
100.000 μA	2 nA	0.03% + 60 nA	3 nA
1.00000 mA	20 nA	0.03% + 300 nA	6 nA
10.0000 mA	200 nA	0.03% + 6 μA	200 nA
100.000 mA	2 μA	0.03% + 30 μA	600 nA
1.00000 A <sup>2</sup>	20 μA	0.05% + 1.8 mA	70 μA
1.50000 A <sup>2</sup>	50 μA	0.06% + 4 mA	150 μA
10.0000 A <sup>±5</sup>	200 μA	0.5 % + 40 mA	

TEMPERATURE COEFFICIENT (0°–18°C & 28°–50°C): ±(0.15 × accuracy specification)/°C.

MAXIMUM OUTPUT POWER AND SOURCE/SINK LIMITS<sup>2</sup>: 30.603W per channel maximum. ±1.515A @ ±20.2V, ±101mA @ ±202V, four quadrant source or sink operation.

CURRENT REGULATION: Line: 0.01% of range. Load: ±(0.01% of range + 100pA).

VOLTAGE LIMIT/COMPLIANCE<sup>3</sup>: Bipolar voltage limit (compliance) set with a single value. Minimum value is 10mV. Accuracy same as voltage source.

OVERSHOOT: <0.1% typical (step size = 10% to 90% of range, resistive load; see CURRENT SOURCE OUTPUT SETTLING TIME for additional test conditions).

## ADDITIONAL SOURCE SPECIFICATIONS

TRANSIENT RESPONSE TIME: <70μs for the output to recover to 0.1% for a 10% to 90% step change in load.

VOLTAGE SOURCE OUTPUT SETTLING TIME: Time required to reach 0.1% of final value after source level command is processed on a fixed range.

200mV, 2V Ranges: <50μs typical. 20V Range: <100μs typical. 200V Range: <700μs typical.

CURRENT SOURCE OUTPUT SETTLING TIME: Time required to reach 0.1% of final value after source level command is processed on a fixed range. Values below for Iout · Rload = 2V unless noted.

1.5A–1A Ranges: <120μs typical (Rload >6Ω). 10μA Range: <500μs typical.

100mA–10mA Ranges: <80μs typical. 1μA Range: <2ms typical.

1mA Range: <100μs typical. 100nA Range: <20ms typical.

100μA Range: <150μs typical.

DC FLOATING VOLTAGE: Output can be floated up to ±250VDC from chassis ground.

REMOTE SENSE OPERATING RANGE<sup>5</sup>: Maximum voltage between HI and SENSE HI = 3V. Maximum voltage between LO and SENSE LO = 3V.

VOLTAGE OUTPUT HEADROOM:

200V Range: Max. output voltage = 202.3V – total voltage drop across source leads (maximum 1Ω per source lead).

20V Range: Max. output voltage = 23.3V – total voltage drop across source leads (maximum 1Ω per source lead).

OVER TEMPERATURE PROTECTION: Internally sensed temperature overload puts unit in standby mode.

VOLTAGE SOURCE RANGE CHANGE OVERSHOOT: Overshoot into a 100kΩ load, 20MHz BW, 300mV typical.

CURRENT SOURCE RANGE CHANGE OVERSHOOT: <5% + 300mV/Rload + 60nA of larger range typical. (See CURRENT SOURCE OUTPUT SETTLING TIME for additional test conditions.)

## PULSE SPECIFICATIONS

REGION	MAXIMUM CURRENT LIMIT	MAXIMUM PULSE WIDTH <sup>6</sup>	MAXIMUM DUTY CYCLE <sup>9</sup>
1	100 mA @ 200 V	DC, no limit	100%
1	1.5 A @ 20 V	DC, no limit	100%
2	1 A @ 180 V	8.5 ms	1%
3 <sup>10</sup>	1 A @ 200 V	2.2 ms	1%
4	10 A @ 5 V	1 ms	2.2%

MINIMUM PROGRAMMABLE PULSE WIDTH<sup>8</sup>: 200μs. NOTE: Minimum pulse width for settled source at a given I/V output and load can be longer than 200μs. See note 11 for typical settling times.

PULSE WIDTH PROGRAMMING RESOLUTION: 1μs.

PULSE WIDTH PROGRAMMING ACCURACY<sup>8</sup>: ±25μs.

TYPICAL PULSE WIDTH JITTER: 50μs.

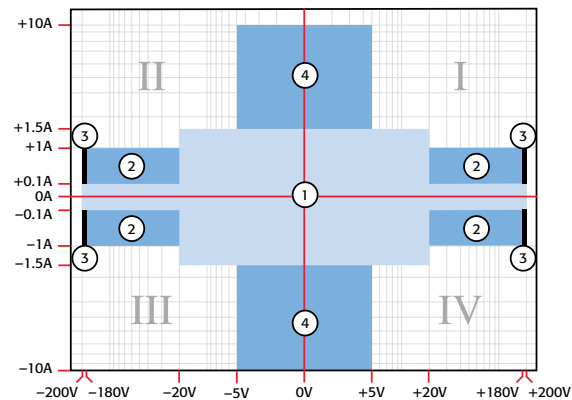

## SOURCE SPECIFICATIONS (continued)

### PULSE SPECIFICATIONS (continued)

#### NOTES

1. Add 50 $\mu$ V to source accuracy specifications per volt of HI lead drop.
2. Full power source operation regardless of load to 50°C ambient. Above 30°C and/or power sink operation, refer to Section 8 – Operating Boundaries in the Series 2600 Reference Manual for additional power derating information.
3. For sink mode operation (quadrants II and IV), add 12% of limit range and  $\pm 0.02\%$  of limit setting to corresponding current limit accuracy specifications. For 1A range add an additional 40mA of uncertainty.
4. For sink mode operation (quadrants II and IV), add 10% of compliance range and  $\pm 0.02\%$  of limit setting to corresponding voltage source specification. For 200mV range add an additional 120mV of uncertainty.
5. 10A range accessible only in pulse mode.
6. Accuracy specifications do not include connector leakage. Derate accuracy by  $V_{out}/2E11$  per °C when operating between 18°–28°C. Derate accuracy by  $V_{out}/2E11 + (0.15 \times V_{out}/2E11)$  per °C when operating <18°C and >28°C.
7. 150mV under pulse conditions with compliance set to 1A.
8. Times measured from the start of pulse to the start of off-time; see figure below.

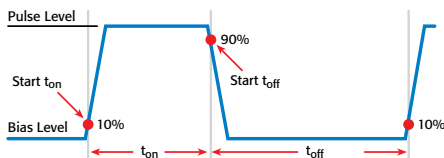

9. Thermally limited in sink mode (quadrants 2 and 4) and ambient temperatures above 30°C. See power equations in the reference manual for more information.
10. Voltage source operation with 1.5A current limit.
11. Typical performance for minimum settled pulse widths:

Source Value	Load	Source Settling (% of range)	Min. Pulse Width
5 V	0.5 $\Omega$	1%	300 $\mu$ s
20 V	200 $\Omega$	0.2%	200 $\mu$ s
180 V	180 $\Omega$	0.2%	5 ms
200V (1.5A limit)	200 $\Omega$	0.2%	1.5 ms
100 mA	200 $\Omega$	1%	200 $\mu$ s
1 A	20 $\Omega$	1%	500 $\mu$ s
1 A	180 $\Omega$	0.2%	5 ms
10 A	0.5 $\Omega$	0.5%	300 $\mu$ s

Typical tests were performed using remote operation, 4W sense, Keithley 2600-BAN cables and best, fixed measurement range. For more information on pulse scripts, see the Series 2600 Reference Manual.

## METER SPECIFICATIONS

### VOLTAGE MEASUREMENT ACCURACY 1, 7

RANGE	DISPLAY RESOLUTION <sup>3</sup>	INPUT RESISTANCE	ACCURACY (1 Year) 23°C $\pm 5^\circ$ C $\pm$ (% rdg. + volts)
200.000 mV	1 $\mu$ V	>10 G $\Omega$	0.015% + 225 $\mu$ V
2.00000 V	10 $\mu$ V	>10 G $\Omega$	0.02 % + 350 $\mu$ V
20.0000 V	100 $\mu$ V	>10 G $\Omega$	0.015% + 5 mV
200.000 V	1 mV	>10 G $\Omega$	0.015% + 50 mV

TEMPERATURE COEFFICIENT (0°–18°C & 28°–50°C):  $\pm(0.15 \times$  accuracy specification) $^\circ$ C.

### CURRENT MEASUREMENT ACCURACY 6, 7

RANGE	DISPLAY RESOLUTION <sup>3</sup>	VOLTAGE BURDEN <sup>2</sup>	ACCURACY (1 Year) 23°C $\pm 5^\circ$ C $\pm$ (% rdg. + amps)
100.000 nA	1 pA	<1 mV	0.05 % + 100 pA
1.00000 $\mu$ A	10 pA	<1 mV	0.025% + 500 pA
10.0000 $\mu$ A	100 pA	<1 mV	0.025% + 1.5 nA
100.000 $\mu$ A	1 nA	<1 mV	0.02 % + 25 nA
1.00000 mA	10 nA	<1 mV	0.02 % + 200 nA
10.0000 mA	100 nA	<1 mV	0.02 % + 2.5 $\mu$ A
100.000 mA	1 $\mu$ A	<1 mV	0.02 % + 20 $\mu$ A
1.00000 A	10 $\mu$ A	<1 mV	0.03 % + 1.5 mA
1.50000 A	10 $\mu$ A	<1 mV	0.05 % + 3.5 mA
10.0000 A <sup>5</sup>	100 $\mu$ A	<1 mV	0.4 % + 25 mA

TEMPERATURE COEFFICIENT (0°–18°C & 28°–50°C):  $\pm(0.15 \times$  accuracy specification) $^\circ$ C.

### CONTACT CHECK<sup>4</sup>

SPEED	MAXIMUM MEASUREMENT TIME TO MEMORY FOR 60Hz (50Hz) <sup>4</sup>	ACCURACY (1 Year) 23°C $\pm 5^\circ$ C $\pm$ (%rdg. + ohms)
FAST	1 (1.2) ms	5% + 10
MEDIUM	4 (5) ms	5% + 1
SLOW	36 (42) ms	5% + 0.3

### ADDITIONAL METER SPECIFICATIONS

LOAD IMPEDANCE: Stable into 10,000pF typical.

COMMON MODE VOLTAGE: 250VDC.

COMMON MODE ISOLATION: >1G $\Omega$ , <4500pF

OVERRRANGE: 101% of source range, 102% of measure range.

MAXIMUM SENSE LEAD RESISTANCE: 1k $\Omega$  for rated accuracy.

SENSE INPUT IMPEDANCE: >10G $\Omega$ .

#### NOTES

1. Add 50 $\mu$ V to source accuracy specifications per volt of HI lead drop.
2. Four-wire remote sense only.
3. Applies when in single channel display mode.
4. Includes measurement of SENSE HI to HI and SENSE LO to LO contact resistances.
5. 10A range accessible only in pulse mode.
6. De-rate accuracy by  $V_{out}/2E11$  per °C when operating between 18°–28°C. Derate accuracy by  $V_{out}/2E11 + (0.15 \times V_{out}/2E11)$  per °C when operating <18°C and >28°C.
7. De-rate accuracy specifications for NPLC setting <1 by increasing error term. Add appropriate % of range term using table below:

NPLC Setting	200mV Range	2V–200V Ranges	100nA Range	1 $\mu$ A–100mA Ranges	1A–1.5A Ranges
0.1	0.01%	0.01%	0.01%	0.01%	0.01%
0.01	0.08%	0.07%	0.1 %	0.05%	0.05%
0.001	0.8 %	0.6 %	1 %	0.5 %	1.1 %

2611  
2612

# System SourceMeter® Multi-Channel I-V Test Solutions

## GENERAL

**HOST INTERFACES:** Computer control interfaces.

**IEEE-488:** IEEE-488.1 compliant. Supports IEEE-488.2 common commands and status model topology.

**RS-232:** Baud rates from 300 bps to 115200 bps. Programmable number of data bits, parity type, and flow control (RTS/CTS hardware or none). When not programmed as the active host interface, the SourceMeter can use the RS-232 interface to control other instrumentation.

**EXPANSION INTERFACE:** The TSP-Link expansion interface allows TSP enabled instruments to trigger and communicate with each other.

**Cable Type:** Category 5e or higher LAN crossover cable.

**Length:** 3 meters maximum between each TSP enabled instrument.

**DIGITAL I/O INTERFACE** (see 2601/02 GENERAL specifications for circuit diagram):

**Connector:** 25-pin female D.

**Input/Output Pins:** 14 open drain I/O bits.

**Absolute Maximum Input Voltage:** 5.25V

**Absolute Minimum Input Voltage:** -0.25V

**Maximum Logic Low Input Voltage:** 0.7V +850 $\mu$ A max.

**Minimum Logic High Input Voltage:** 2.1V +570 $\mu$ A.

**Maximum Source Current (flowing out of Digital I/O bit):** +960 $\mu$ A.

**Maximum Sink Current @ Maximum Logic Low Voltage (0.7V):** -5.0mA.

**Absolute Maximum Sink Current (flowing into Digital I/O pin):** -11mA.

**5V Power Supply Pin:** Limited to 600mA, solid state fuse protected.

**Safety Interlock Pin:** Active high input. >3.4V @ 24mA (absolute maximum of 6V) must be externally applied to this pin to insure 200V operation. This signal is pulled down to chassis ground with a 10k $\Omega$  resistor. 200V operation will be blocked when the INTERLOCK signal is <0.4V (absolute minimum of -0.4V). See figure below:

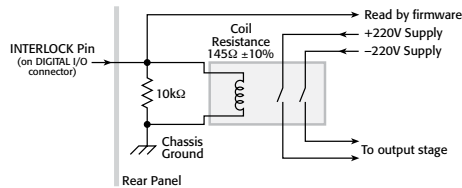

**POWER SUPPLY:** 100V to 240VAC, 50–60Hz (manual setting), 240VA max.

**COOLING:** Forced air. Side intake and rear exhaust. One side must be unobstructed when rack mounted.

**WARRANTY:** 1 year.

**EMC:** Conforms to European Union Directive 89/336/EEC, EN 61326-1.

**SAFETY:** Conforms to European Union Directive 73/23/EEC, EN 61010-1, and UL 61010-1.

**DIMENSIONS:** 89mm high  $\times$  213mm wide  $\times$  460mm deep (3½ in  $\times$  8½ in  $\times$  17½ in). Bench Configuration (with handle & feet): 104mm high  $\times$  238mm wide  $\times$  460mm deep (4¼ in  $\times$  9½ in  $\times$  17½ in).

**WEIGHT:** 2611: 4.75kg (10.4 lbs). 2612: 5.50kg (12.0 lbs).

**ENVIRONMENT:** For indoor use only.

**Altitude:** Maximum 2000 meters above sea level.

**Operating:** 0°–50°C, 70% R.H. up to 35°C. Derate 3% R.H./°C, 35°–50°C.

**Storage:** -25°C to 65°C.

# Series 2600

# System SourceMeter® Multi-Channel I-V Test Solutions

## SPEED SPECIFICATIONS 1

### MAXIMUM SWEEP OPERATION RATES (operations per second) FOR 60Hz (50Hz):

A/D CONVERTER SPEED	TRIGGER ORIGIN	MEASURE TO MEMORY	MEASURE TO GPIB	SOURCE MEASURE TO MEMORY	SOURCE MEASURE TO GPIB	SOURCE MEASURE PASS/FAIL TO MEMORY	SOURCE MEASURE PASS/FAIL TO GPIB
0.001 NPLC	Internal	10000 (10000)	8000 (8000)	5500 (5500)	3600 (3600)	4900 (4900)	3100 (3100)
0.001 NPLC	Digital I/O	2700 (2650)	2100 (2100)	2300 (2300)	1900 (1875)	2200 (2150)	1800 (1775)
0.01 NPLC	Internal	4000 (3500)	3600 (3200)	2750 (2700)	2300 (2100)	2800 (2500)	2100 (1975)
0.01 NPLC	Digital I/O	1900 (1775)	1600 (1500)	1700 (1600)	1450 (1400)	1600 (1500)	1400 (1325)
0.1 NPLC	Internal	565 (475)	555 (470)	540 (450)	510 (440)	535 (455)	505 (430)
0.1 NPLC	Digital I/O	490 (420)	470 (405)	470 (410)	450 (390)	470 (400)	450 (390)
1.0 NPLC	Internal	59 (49)	59 (49)	58 (49)	58 (48)	58 (49)	58 (48)
1.0 NPLC	Digital I/O	58 (48)	58 (48)	58 (48)	57 (48)	57 (48)	57 (48)

### MAXIMUM SINGLE MEASUREMENT RATES (operations per second) FOR 60Hz (50Hz):

A/D CONVERTER SPEED	TRIGGER ORIGIN	MEASURE TO GPIB	SOURCE MEASURE TO GPIB	SOURCE MEASURE PASS/FAIL TO GPIB
0.001 NPLC	Internal	1110 (1000)	880 (880)	840 (840)
0.01 NPLC	Internal	950 (900)	780 (760)	730 (710)
0.1 NPLC	Internal	390 (345)	355 (320)	340 (305)
1.0 NPLC	Internal	57 (48)	56 (47)	56 (47)

**MAXIMUM MEASUREMENT RANGE CHANGE RATE:** >4500/second typical. When changing to or from a range  $\geq 1A$ , maximum rate is >2000/second typical.

**MAXIMUM SOURCE RANGE CHANGE RATE:** >400/second, typical.

**MAXIMUM SOURCE FUNCTION CHANGE RATE:** >500/second, typical.

**EXTERNAL TRIGGER INPUT:** The Digital I/O interface signals can be configured to behave as trigger inputs.

**Input Latency (time from trigger input to start of measurement or source change):**  
<150 $\mu$ s, typical.

**Input Jitter:** <100 $\mu$ s, typical.

**COMMAND PROCESSING TIME:** Maximum time required for the output to begin to change following the receipt of the smux.source.levelv or smux.source.leveli command. <1ms typical.

## NOTES

1. See the Speed Specifications Test Conditions Appendix in the Series 2600 Reference Manual for more information regarding test conditions.

Specifications are subject to change without notice. Rev. B

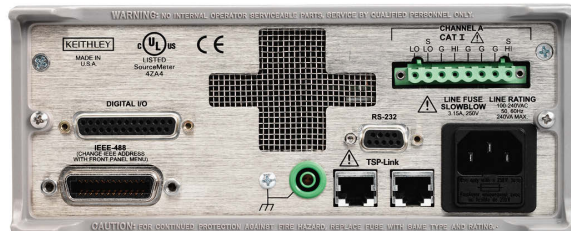

Model 2601/2611 Rear Panel

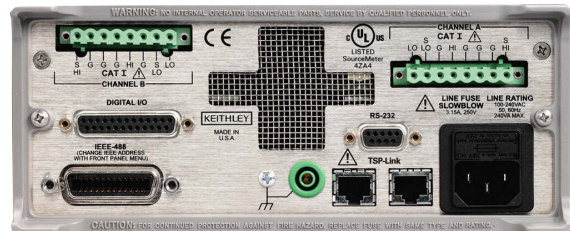

Model 2602/2612 Rear Panel

## SUPPLEMENTAL INFORMATION

**FRONT PANEL INTERFACE:** 2-line vacuum fluorescent display (VFD) with keypad and rotary knob.

**Display:**

- Show error messages and user defined messages
- Display source and limit settings
- Show current and voltage measurements
- View measurements stored in non-volatile reading buffers

**Keypad Operations:**

- Change host interface settings
- Save and restore instrument setups
- Load and run factory and user defined test scripts (i.e. sequences) that prompt for input and send results to the display
- Store measurements into non-volatile reading buffers

**PROGRAMMING:** Embedded Test Script Processor (TSP) accessible from any host interface. Responds to individual instrument control commands. Responds to high-speed test scripts comprised of instrument control commands and Test Script Language (TSL) statements (e.g. branching, looping, math, etc.). Able to execute high-speed test scripts stored in memory without host intervention.

**Minimum Memory Available:** 3 Mbytes (approximately 50,000 lines of TSL code).

**Test Script Builder:** Integrated Development Environment for building, running, and managing TSP scripts. Includes an Instrument Console for communicating with any TSP enabled instrument in an interactive manner. Requires:

- VISA (NI-VISA included on CD)
- Microsoft .NET Framework (included on CD)
- Keithley I/O Layer (included on CD)
- Pentium III 800MHz or faster personal computer
- Microsoft Windows 98, NT, 2000, or XP

**Drivers:** IVI/VISA drivers for VB, VC/C++, LabVIEW, TestPoint, and LabWindows/CVI

**READING BUFFERS:** Non-volatile storage area(s) reserved for measurement data. Reading buffers are arrays of measurement elements. Each element can hold the following items:

- Measurement
- Measurement status
- Timestamp
- Source setting (at the time the measurement was taken)
- Range information

Two reading buffers are reserved for each SourceMeter channel. Reading buffers can be filled using the front panel STORE key and retrieved using the RECALL key or host interface.

**Buffer Size, with timestamp and source setting:** >50,000 samples.

**Buffer Size, without timestamp and source setting:** >100,000 samples.

**Battery Backup:** Lithium-ion battery backup. 30 days of non-volatile storage @ 23°C, and >4 hours of charge time. 3 year battery life @ 25°C. 1.5 year battery life @ 50°C.

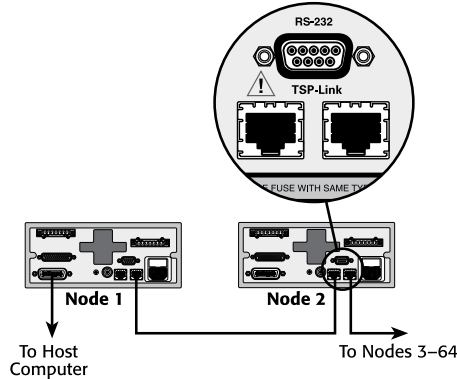

Each SourceMeter has two TSP-Link connectors to facilitate chaining instruments together.

- Once SourceMeter instruments are interconnected via TSP-Link, a computer can access all of the resources of each SourceMeter via the host interface of any SourceMeter.
- A maximum of 64 TSP-Link nodes can be interconnected. Each SourceMeter consumes one TSP-Link node.

**TIMER:** Free running 47 bit counter with 1MHz clock input. Reset each time instrument powers up. Rolls over every 4 years.

**Timestamp:** TIMER value automatically saved when each measurement is triggered.

**Resolution:** 1µs.

**Accuracy:** 50ppm.

# Appendix B

## Frequently Asked Questions

---

### In this Appendix:

<b>How do I optimize performance?</b>	B-2
Setting speed	B-2
Disabling auto zero to increase speed	B-2
<b>How do I use the Digital I/O port?</b>	B-3
Controlling the Digital I/O port	B-3
<b>How do I trigger other instruments?</b>	B-5
Triggering a scanner	B-5
Programming triggering	B-5
<b>How do I generate a service request?</b>	B-6
Setting up a service request	B-6
Service request programming example	B-6
Polling for SRQs	B-6
<b>How do I store measurements in non-volatile memory?</b>	B-7
Front panel operation	B-7
Remote programming	B-7
<b>How do I stack channels to output higher voltage?</b>	B-9
<b>How do I parallel channels to output higher current?</b>	B-11
<b>How do I make contact check measurements?</b>	B-12
Contact check connections	B-12
Contact check programming example	B-13

## How do I optimize performance?

**Reference** Refer to “Operation considerations” in Section 4 and “Speed” in Section 6 of the Series 2600 Reference Manual for detailed information on performance factors that affect measurement speed and accuracy.

There are three primary factors that affect measurement accuracy and speed:

- Warm-up – For rated measurement accuracy, allow the Series 2600 to warm up for at least one hour before use.
- Speed setting – The Speed setting affects both speed and accuracy.
- Auto zero – Auto zero can be disabled to increase speed at the expense of accuracy.

### Setting speed

Press the **SPEED** key, then choose the setting based on your requirements:

- Choose the **FAST** setting for the fastest measurements, but measurement accuracy will be reduced.
- For best accuracy, use the **HI ACCURACY** setting, but speed will be reduced.
- To compromise between accuracy and speed, use the **MED** or **NORMAL** setting.

### Disabling auto zero to increase speed

In certain measuring situations, disabling auto zero can increase measurement speed, but accuracy will drift with time. To disable auto zero, select **CONFIG > MEAS > AUTO-ZERO**, then set to **OFF**. To minimize drift with auto zero disabled, use the **ONCE** selection just before measuring.



# How do I use the Digital I/O port?

**Reference** Refer to Section 10 of the Series 2600 Reference Manual for complete details on the Digital I/O port.

## Digital I/O port terminals

The Digital I/O port, located on the rear panel (Figure 1-2 in Section 1), provides 14 digital I/O lines (Figure B-1). Each output can be set high (+5V) or low (0V), read high or low logic levels, and can be set up for triggering. Make connections using a cable with a Male DB-25 connector (Keithley Instruments part number CA-126-1).

Figure B-1  
Digital I/O port terminals

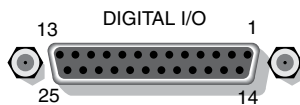

1 = Digital I/O #1	11 = Digital I/O #11
2 = Digital I/O #2	12 = Digital I/O #12
3 = Digital I/O #3	13 = Digital I/O #13
4 = Digital I/O #4	14 = Digital I/O #14
5 = Digital I/O #5	15-21 = Ground
6 = Digital I/O #6	22 = +5V
7 = Digital I/O #7	23 = +5V
8 = Digital I/O #8	24 = Output Enable (OE); 2601/2602
9 = Digital I/O #9	24 = Interlock (INT); 2611/2612
10 = Digital I/O #10	25 = +5V

## Controlling the Digital I/O port

From the front panel, select **MENU > GENERAL > DIGOUT > DIG\_IO\_OUTPUT**, then enter the decimal value to set I/O lines high or low (16,383 maximum).

Commands for basic I/O are summarized in Table B-1. For example, to set all 14 lines high, send:

```
digiowriteport(16383).
```

Table B-1  
**Commands for basic I/O port**

<b>Command</b>	<b>Description</b>
digio.readbit(bit) digio.readport() digio.writebit(bit, data) digio.writeport(data)	Read one digital I/O input line. Read digital I/O port. Write data to one digital I/O output line. Write data to digital I/O port.

# How do I trigger other instruments?

**Reference** Refer to “Triggering” in Section 4, “Remote digital I/O commands” in Section 11, and Section 12 of the Series 2600 Reference Manual for triggering and Digital I/O port command details.

## Triggering a scanner

A typical test scenario might call for using the SourceMeter with a scanner to test a number of DUTs in sequence. A basic example that uses the Series 2600 Digital I/O port to trigger a scanner is shown in [Figure B-2](#). In this case, line 1 of the I/O port is used as a trigger output and connected to the scanner mainframe trigger input, while line 2 of the I/O port is used as a trigger input.

Figure B-2  
**Triggering a scanner**

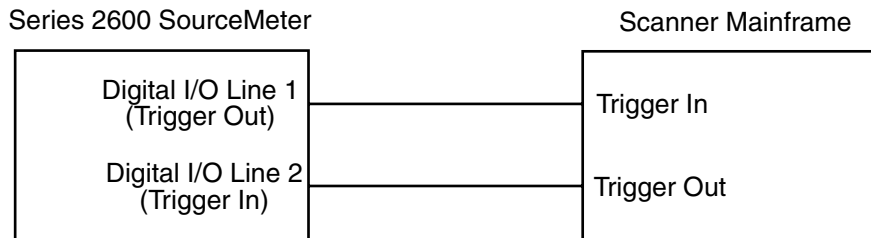

## Programming triggering

A simple command sequence that sets up triggering is shown below. The first two commands set the output pulse width on line 1 and program line 2 for falling edge input triggers. The second two commands assert and then wait for a trigger on lines 1 and 2 respectively.

```
digio.trigger[1].pulsewidth = 1e-5--Set line 1 pulse width to 10µs.
digio.trigger[2].mode =          --Set line 2 mode to falling edge.
digio.TRIG_FALLING
digio.trigger[1].assert()        --Assert trigger on line 1.
digio.trigger[2].wait(timeout)  --Wait for trigger on line 2.
```

# How do I generate a service request?

**Reference** Refer to “Status byte and service request (SRQ)” and additional information in Appendix D of the Series 2600 Reference Manual for status model and service request details.

## Setting up a service request

The exact programming steps necessary to generate a GPIB service request (SRQ) will vary somewhat depending on the event(s) intended to generate the SRQ. In general, the steps used will be as follows:

- Clear all status registers to prevent anomalous events from generating an SRQ.
- Set bits in the appropriate operation: questionable, measurement enable, or transition register(s).
- Set the proper summary bit in the service request enable register. At least one bit in this register must always be set, but the exact bit(s) to be set will depend on the desired SRQ event(s).

## Service request programming example

The example below shows how to program the SourceMeter to generate an SRQ when the current limit on Channel A is exceeded.

```
status.reset()                --Clear all registers.
status.measurement.current_limit.enable --Enable current limit bit in
= status.measurement.current_limit.SMUA  current limit register.
status.measurement.enable =          --Enable status measure
status.measurement.ILMT              current limit bit.
status.request_enable = status.MSB    --Enable status SRQ MSB.
```

## Polling for SRQs

To determine if the SourceMeter is the GPIB device that generated the SRQ, simply serial poll the unit for the status byte, and test to see if the corresponding summary bit or bits are set. For example, the following commands request the status byte and prints the result:

```
status_byte = status.condition
print(status_byte)
```

# How do I store measurements in non-volatile memory?

A Series 2600 SourceMeter has two non-volatile buffers for measured readings, source values, and timestamps: NV Buffer 1 (`nvbuffer1`) and NV Buffer 2 (`nvbuffer2`). Data stored in these buffers will not be lost when the Series 2600 is turned off.

**Reference** Refer to Section 7 of the Series 2600 Reference Manual for details on the buffer (data store).

## Front panel operation

Refer to “[How do I use the buffer?](#)” in [Section 1](#) of this manual for details on storing data from the front panel of the Series 2600.

## Remote programming

The following example demonstrates a typical way to use a reading buffer. The commands in the following steps will perform three SMU A voltage measurements, store them in `nvbuffer1`, and then read the buffer:

### Step 1: Clear and configure the buffer

The following command sequence will clear the buffer of all readings, and configure the buffer to store timestamps and source values:

```
smua.nvbuffer1.clear()
smua.nvbuffer1.collecttimestamps = 1
smua.nvbuffer1.collectsourcevalues = 1
```

<b>NOTE</b>	<b>Setting <code>collecttimestamps</code> to 0 and <code>collectsourcevalues</code> to 0 will disable the storage of timestamps and source values.</b>
-------------	--

### Step 2: Perform measurements

The following command sequence sets the measure count to three, turns on the output, performs the three measurements, and then turns off the output:

```
smua.measure.count = 3
smua.source.output = smua.OUTPUT_ON
smua.measure.v(smua.nvbuffer1)
smua.source.output = smua.OUTPUT_OFF
```

The three measure readings, timestamps, and source values will be stored in the buffer.

### Step 3: Read the buffer

The following code will output the three sets of data (nine values) in the same message:

```
rb1 = smua.nvbuffer1  
printbuffer(1, rb1.n, rb1, rb1.timestamps, rb1.sourcevalues)
```

For the above `printbuffer` function, 1 is the starting index for values to output; `rb1.n` is the ending index (`n` = the number of readings in the buffer, which in this case is 3); `rb1` includes the measured readings; `rb1.timestamps` includes the timestamps; and `rb1.sourcevalues` includes the source values.

Example output:

```
1.234567e-03, 5.555555e-02, 1.000000e+00, 2.362360e-03,  
8.888888e-02, 1.000000e+00, 2.362368e-03, 1.111111e-01,  
1.000000e+00
```

The above output is returned in the following order:

```
reading1, timestamp1, sourcevalue1, reading2, timestamp2, sourcevalue2,  
reading3, timestamp3, sourcevalue3
```

Refer to Step 3 of “[Running a factory script](#)” in [Section 3](#) for more examples on reading the buffer.

## How do I stack channels to output higher voltage?

The maximum output voltage of a Model 2601 or 2602 channel is 40.4V, and the maximum output voltage of a Model 2611 or 2612 channel is 202V. Higher voltage can be output by stacking (connecting in series) channels.

Stacking channels requires that all SMU channels (except one) float off earth ground. [Figure B-3](#) shows two Model 2602s configured with the four channels connected in series to output up to 161.6V (40.4V per channel). Additional channels can be added (stacked), but the LO terminal of any SMU channel in the stack must never exceed 250V with respect to earth ground.

**WARNING** The maximum floating (common mode) voltage for a SMU is  $\pm 250\text{V}$ . Exceeding this level may cause damage to the instrument and create a shock hazard.

Whenever hazardous voltage ( $>30\text{V}_{\text{rms}}$ ,  $42\text{V}_{\text{peak}}$ ) will be output, a safety shield must completely surround the DUT test circuit. When using a metal safety shield, it must be connected to a known safety earth ground and chassis ground.

**Reference** Refer to “Floating a SMU” in Section 3 of the Reference Manual for details on floating SMU channels.

Figure B-3  
Stacking channels for higher voltage

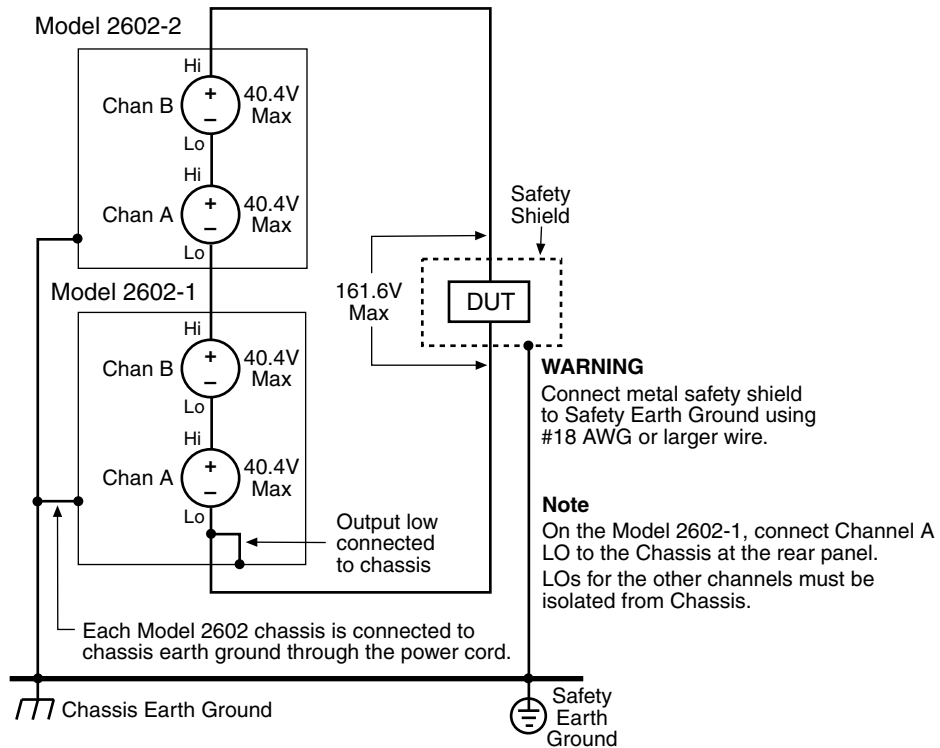

**NOTE** Each stacked channel adds approximately  $100\mu\text{A}$  of common mode current that is seen by the channels below it. Therefore, in the example above, Model 2602-1 Chan A will measure approximately  $100\mu\text{A} \times 3 = 300\mu\text{A}$  higher than Model 2602-2 Chan B. Similarly, Model 2602-1 Chan B will measure approximately  $100\mu\text{A} \times 2 = 200\mu\text{A}$  higher than Model 2602-2 Chan B. The most accurate measurement of actual current flowing through the DUT will be obtained from Model 2602-2 Chan B.



## How do I parallel channels to output higher current?

**Reference** Refer to Section 3 of the Series 2600 Reference Manual for details on SMU connections.

The maximum DC output current of a Model 2601 or 2602 channel is as follows:

- 1.01A @ up to 40.4V
- 3.03A @ up to 6.06V

The maximum DC output current of a Model 2611 or 2612 channel is as follows:

- 101mA @ up to 202V
- 1.515A @ up to 20.2V

Higher current can be output by connecting channels in parallel. [Figure B-4](#) shows four channels of two Model 2602s or 2612s connected in parallel. Two Model 2602s can output up to 4.04A at up to 40.4V and 12.12A at up to 6.06V, while two Model 2612s can output up to 404mA at up to 202V and 6.06A at up to 20.2V. The current delivered to the DUT is the sum of currents output by the four SMU channels. More current can be output by connecting additional channels in parallel.

Figure B-4

### Connecting channels in parallel for higher current

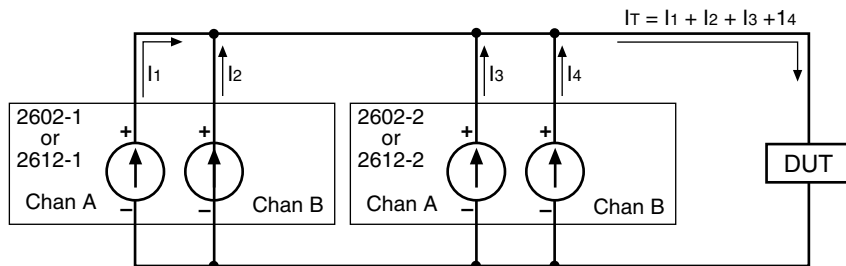

# How do I make contact check measurements?

**Reference** Refer to “Contact check measurements” in Section 4 and command information in Section 12 of the Series 2600 Reference Manual for contact check details.

## Contact check connections

The contact check function<sup>1</sup> prevents measurement errors due to excessive resistance in the force or sense leads caused by poor contact at the DUT, failing relay contacts on a switching card, or wires that are too long or thin. The contact check function will also detect an open circuit that may occur when a four-point probe is misplaced or misaligned. Figure B-5 shows contact check connections.  $R_C$  is the resistance of the mechanical contact at the DUT, and  $R_S$  is the series resistance of relays and cables.

Figure B-5

### Contact check connections

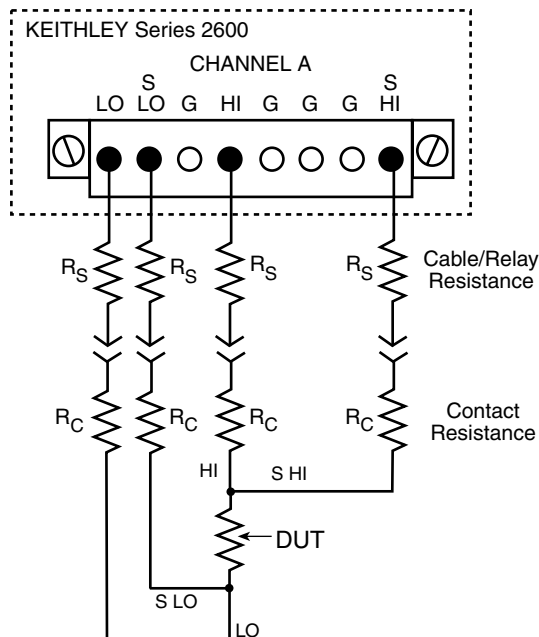

1. All Model 2611/2612s manufactured by Keithley Instruments support the contact check function. Only Model 2601/2602s with firmware revision 1.1.0 or later and SMU hardware revision E or later support the contact check function. To determine the firmware and SMU hardware revisions, inspect the data returned by the `print(localnode.info())` command. The `InstFwRev` and `SMUBrdRev` keys contain the necessary information.

## Contact check programming example

The command sequence for a typical contact measurement is shown below. These commands set the contact check speed to fast and the threshold to 10 $\Omega$ . A contact check measurement against the threshold is then made. If it fails, a more accurate contact check measurement is made, and the test is aborted. Otherwise, the output is turned on, and the test continues.

```
smua.reset()                --Restore defaults.
smua.contact.speed = smua.CONTACT_FAST --Set speed to fast.
smua.contact.threshold = 10    --Set threshold to 10 $\Omega$ .
if (not smua.contact.check()) then --Check contacts against threshold.
    --One/both contact resistances are not
    --below the programmed threshold.
    smua.contact.speed = smua.CONTACT_SLOW --Set speed to slow.
    rhi, rlo = smua.contact.r()           --Get resistance readings.
    print(rhi, rlo)                       --Return contact resistances to the host.
    exit()                                 --Terminate execution.
end
smua.source.output = smua.OUTPUT_ON      --Turn on output and continue.
```

This page left blank intentionally.

---

# Index

## A

- Auto zero
  - Disabling B-2

## B

- Basic measurements 1-9
- Buffer
  - Configuration 1-15
  - Configuring 1-15
  - Overview 1-15
  - Recalling readings 1-16
  - Storing readings 1-16
  - Using 1-15

## C

- Calling a function 3-4
  - Operator interaction 3-5
- Chassis ground 1-7
- Clearing a buffer B-7
- Command help 2-8
- Compliance
  - Setting limit 1-11
- Configuring a buffer B-7
- Connections
  - DUT 1-10, 1-15
- Connectors
  - Digital I/O 1-7
  - IEEE-488 1-7
  - Output 1-7
  - Power module 1-7
  - RS-232 1-7
  - TSP-Link 1-7
- Console window
  - Clearing 2-8
  - Saving 2-8
- Contact check
  - Connections B-12
  - Measurements B-12
  - Programming example B-13
- Control icons 2-5

## D

- Digital I/O port
  - Controlling B-3
  - Terminals B-3
- Display
  - Annunciators 1-5

- Display modes 1-12
- DUT connections 1-10

## F

- Factory scripts 3-2
- Front panel summaries 1-2

## G

- GPIO interface 2-2, B-2

## H

- How do I interact with scripts using Test Script Builder? 3-3
- How do I parallel channels to output higher current? B-11
- How do I run a script from the front panel? 3-2
- How do I set up the TSP-Link system? 4-2
- How do I stack channels to output higher voltage? B-9
- How do I store measurements in non-volatile memory? B-7
- How do I use other programs? 3-14
- How do I use the expanded system? 4-4

## I

- IEEE-488 interface 2-2, B-2
- Importing a factory script project 3-6
- Input/output connections 1-7
- Instrument resource
  - Closing 2-7
  - Opening 2-7
- Interface configuration
  - GPIO 2-3
  - RS-232 2-3

## K

- Keys
  - Function 1-4
  - Output control 1-5
  - Range 1-5
  - Special 1-3

## L

- LabVIEW 2-12, 3-14
- Language help 2-8
- Line frequency 1-9
- Line power
  - Connecting to 1-9
  - Setting line frequency 1-9

---

Turning on 1-9

## M

### Measurement

Function 1-11

Making 1-11

Range 1-11

Setting functions 1-15

### Measurements

Basic 1-10

Using Test Script Builder 2-9

### Menu Bar 2-4

Modifying a factory script 3-6

Modifying the test code 3-8

## O

Optimizing performance B-2

### Output

Turning off 1-12

Turning on 1-11, 1-16

## P

Performing measurements B-7

Power module 1-7

Power switch 1-3

### Programs

Using 2-12

Using LabVIEW 2-12, 3-14

Using Visual Basic 2-14, 3-16

Project Navigator pane 2-4

PulseVMeasureI function 3-3

## R

Reading a buffer 3-4, B-8

### Readings

Recalling 1-16

Storing 1-16

Rear panel summaries 1-2

Recalling readings 1-16

### Remote interface

Configuring 2-3

Connections 2-2

Selecting 2-3

Using 2-2, B-2

Rotary knob 1-5

RS-232 interface 2-2, B-2

Running a factory script 3-4

Running a user script 3-12

## S

Safety symbols and terms 1-2

Saving a script 3-8

Script Development pane 2-4

### Service request

Generating B-6

Polling for B-6

Programming example B-6

Setting up B-6

### Source

Selecting 1-10

Setting functions 1-15

Setting level 1-10

Source-measure capabilities 1-8

Model 2601/2602 1-8

Model 2611/2612 1-8

SourceMeter/Script Interaction pane 2-4

### Speed

Setting B-2

SRQ (Service request) B-6

Storing a script in non-volatile memory 3-9

Storing readings 1-16

## T

### Test Script Builder

Running 2-4

Using 2-4

Timestamp 1-16

### Triggering

Other instruments B-5

Programming B-5

Scanner B-5

### TSP-Link

Accessing node resources 4-4

Connections 4-2

Initialization (reset) 4-3

localnode variable (alias) 4-4

Node number assignments 4-2

node variable 4-4

Running scripts 4-5

Setup 4-2

System check 4-4

## U

User scripts 3-2

## V

### Vents

Cooling 1-7

Visual Basic 2-14

---

## W

What is a script? [3-2](#)

---





# Service Form

**Model No.** \_\_\_\_\_ **Serial No.** \_\_\_\_\_ **Date** \_\_\_\_\_

**Name and Telephone No.** \_\_\_\_\_

**Company** \_\_\_\_\_

List all control settings, describe problem and check boxes that apply to problem. \_\_\_\_\_

Intermittent                       Analog output follows display                       Particular range or function bad; specify \_\_\_\_\_

IEEE failure                       Obvious problem on power-up                       Batteries and fuses are OK

Front panel operational     All ranges or functions are bad                       Checked all cables

Display or output (check one)

Drifts                                       Unable to zero                                       Unstable

Overload                                       Will not read applied input

Calibration only                       Certificate of calibration required                       Data required

(attach any additional sheets as necessary)

Show a block diagram of your measurement including all instruments connected (whether power is turned on or not). Also, describe signal source.

Where is the measurement being performed? (factory, controlled laboratory, out-of-doors, etc.) \_\_\_\_\_

What power line voltage is used? \_\_\_\_\_ Ambient temperature? \_\_\_\_\_ °F

Relative humidity? \_\_\_\_\_ Other? \_\_\_\_\_

Any additional information. (If special modifications have been made by the user, please describe.)

Be sure to include your name and phone number on this service form.

---



Specifications are subject to change without notice.  
All Keithley trademarks and trade names are the property of Keithley Instruments, Inc.  
All other trademarks and trade names are the property of their respective companies.

---

**KEITHLEY**

A G R E A T E R M E A S U R E O F C O N F I D E N C E