

**FLUKE**<sup>®</sup>

# 302+/303

Clamp Meter

## Users Manual

PN 4045130

September 2011, Rev.1, 12/13

© 2011, 2013 Fluke Corporation. All rights reserved. Specifications are subject to change without notice.  
All product names are trademarks of their respective companies.

## **LIMITED WARRANTY AND LIMITATION OF LIABILITY**

This Fluke product will be free from defects in material and workmanship for two years from the date of purchase. This warranty does not cover fuses, disposable batteries, or damage from accident, neglect, misuse, alteration, contamination, or abnormal conditions of operation or handling. Resellers are not authorized to extend any other warranty on Fluke's behalf. To obtain service during the warranty period, contact your nearest Fluke authorized service center to obtain return authorization information, then send the product to that Service Center with a description of the problem.

**THIS WARRANTY IS YOUR ONLY REMEDY. NO OTHER WARRANTIES, SUCH AS FITNESS FOR A PARTICULAR PURPOSE, ARE EXPRESSED OR IMPLIED. FLUKE IS NOT LIABLE FOR ANY SPECIAL, INDIRECT, INCIDENTAL OR CONSEQUENTIAL DAMAGES OR LOSSES, ARISING FROM ANY CAUSE OR THEORY.** Since some states or countries do not allow the exclusion or limitation of an implied warranty or of incidental or consequential damages, this limitation of liability may not apply to you.

Fluke Corporation  
P.O. Box 9090  
Everett, WA 98206-9090  
U.S.A.

Fluke Europe B.V.  
P.O. Box 1186  
5602 BD Eindhoven  
The Netherlands

# Table of Contents

Title	Page
Introduction.....	1
How to Contact Fluke .....	1
Safety Information .....	2
Jaw Maintenance.....	8
How to Clean the Product .....	8
Specifications .....	8
Electrical Specifications.....	8
Mechanical Specifications .....	10
Environmental Specifications .....	10
The Clamp Meter.....	12



## ***Introduction***

The Fluke 302+/303 Clamp Meter (the Product) measures ac and dc voltage, ac current, resistance, and continuity.

### **Warning**

**Read "Safety Information" before you use the Product.**

## ***How to Contact Fluke***

To contact Fluke, call one of the following telephone numbers:

- Technical Support USA: 1-800-44-FLUKE (1-800-443-5853)
- Calibration/Repair USA: 1-888-99-FLUKE (1-888-993-5853)
- Canada: 1-800-36-FLUKE (1-800-363-5853)
- Europe: +31 402-675-200
- Mainland China: +86-400-810-3435
- Japan: +81-3-6714-3114
- Singapore: +65-738-5655
- Anywhere in the world: +1-425-446-5500

## **Safety Information**

A **Warning** identifies conditions and procedures that are dangerous to the user. A **Caution** identifies conditions and procedures that could cause damage to the Product or the equipment under test.

International electrical symbols used on the Product and in this manual are explained in Table 1.

### **Warning**

**To prevent possible electrical shock, fire, or personal injury:**

- Carefully read all instructions.
- Use the Product only as specified, or the protection supplied by the Product can be compromised.
- Use only correct measurement category (CAT), voltage, and amperage rated probes, test leads, and adapters for the measurement.
- Do not touch voltages > 30 V ac rms, 42 V ac peak, or 60 V dc.











- **Hold the Product behind the tactile barrier. See The Clamp Meter, item ①.**
- **Do not exceed the Measurement Category (CAT) rating of the lowest rated individual component of a Product, probe, or accessory.**
- **Do not measure current while the test leads are in the input jacks.**
- **Do not use the Product around explosive gas, vapor, or in damp or wet environments.**
- **Limit operation to the specified measurement category, voltage, or amperage ratings.**
- **Do not work alone.**
- **Do not apply more than the rated voltage, between the terminals or between each terminal and earth ground.**
- **Comply with local and national safety codes. Use personal protective equipment (approved rubber gloves, face protection, and flame-resistant clothes) to prevent shock and arc blast injury where hazardous live conductors are exposed.**
- **Replace the batteries when the low battery indicator shows to prevent incorrect measurements.**

- **The battery door must be closed and locked before you operate the Product.**
- **Measure a known voltage first to make sure that the Product operates correctly.**
- **Remove all probes, test leads, and accessories that are not necessary for the measurement.**
- **Use only current probes, test leads, and adapters supplied with the Product.**
- **Keep fingers behind the finger guards on the probes.**
- **Connect the common test lead before the live test lead and remove the live test lead before the common test lead.**
- **Remove all probes, test leads, and accessories before the battery door is opened.**





- **Do not use the Product if it is damaged.**
- **Do not use the Product if it operates incorrectly.**
- **Do not use test leads if they are damaged. Examine the test leads for damaged insulation, exposed metal. Check test lead continuity.**
- **Before each use, examine the Product. Look for cracks or missing pieces of the clamp housing. Also look for loose or weakened components. Carefully examine the insulation around the jaws. See The Clamp Meter, item ①.**
- **Examine the case before you use the Product. Look for cracks or missing plastic. Carefully look at the insulation around the terminals.**
- **Read all safety Information before you use the Product.**
- **Remove batteries to prevent battery leakage and damage to the Product if it is not used for an extended period.**
- **Remove batteries to prevent battery leakage and damage to the Product if the Product is to be stored above its operating temperature.**
- **Do not use the Product with pulse width modulated motor controllers.**
- **Do not use a current measurement as an indication that a circuit is safe to touch. A voltage measurement is necessary to know if a circuit is hazardous.**

Table 1. Symbols

Symbol	Meaning	Symbol	Meaning
	AC (Alternating Current)		Earth ground
	Hazardous voltage. Risk of electric shock.		Risk of Danger. Important information. See Manual.
	Double insulated		Conforms to European Union directives.
	DC (Direct Current)		Conforms to relevant South Korean EMC Standards.
	This product has been tested to the requirements of CAN/CSA-C22.2 No. 61010-1, second edition, including Amendment 1, or a later version of the standard incorporating the same level of test requirements.		This product complies with the WEEE Directive (2002/96/EC) marking requirements. The affixed label indicates that you must not discard this electrical/electronic product in domestic household waste. Product Category: With reference to the equipment types in the WEEE Directive Annex I, this product is classed as category 9 "Monitoring and Control Instrumentation" product. Do not dispose of this product as unsorted municipal waste. Go to Fluke's website for recycling information.

**Table 1. Symbols (cont)**

<b>Symbol</b>	<b>Meaning</b>	<b>Symbol</b>	<b>Meaning</b>
	Battery		Application around and removal from HAZARDOUS LIVE conductors is permitted.
CAT II	MEASUREMENT CATEGORY II is applicable to test and measuring circuits connected directly to utilization points (socket outlets and similar points) of the low voltage MAINS installation.	CAT III	MEASUREMENT CATEGORY III is applicable to test and measuring circuits connected to the distribution part of the building's low-voltage MAINS installation.
CAT IV	MEASUREMENT CATEGORY IV is applicable to test and measuring circuits connected at the source of the building's low voltage MAINS installation.		

## ***Jaw Maintenance***

If the Product does not work properly:

1. Inspect the jaw matting surface for cleanliness. If any foreign material (including rust) is present, the jaw will not close properly and measurement errors will result.
2. Open the jaws and wipe the clamp metal ends with a lightly oiled cloth.

## ***How to Clean the Product***

Regularly wipe the case with a damp cloth and mild detergent.



**To prevent damage to the Product, do not use abrasives or solvents to clean the Product case.**

## ***Specifications***

### ***Electrical Specifications***

#### ***AC Current (Jaw)***

Range

302+ .....400.0 A

303 .....600.0 A

Resolution .....	0.1 A
Accuracy .....	1.8 % $\pm$ 5 digits (45 Hz to 65 Hz)
	2.5 % $\pm$ 5 digits (65 Hz to 400 Hz)

**AC Voltage**

Range .....	600.0 V
Resolution .....	0.1 V
Accuracy .....	1.5 % $\pm$ 5 digits (45 Hz to 400 Hz)

**DC Voltage**

Range .....	600.0 V
Resolution .....	0.1 V
Accuracy .....	1 % $\pm$ 5 digits

**Resistance**

Range .....	400.0 $\Omega$ /4000 $\Omega$
Resolution .....	0.1 $\Omega$ /1 $\Omega$
Accuracy .....	1 % $\pm$ 5 digits
Continuity Beeper .....	$\leq$ 70 $\Omega$

***Mechanical Specifications***

Size (L x W x H) .....(207 x 75 x 34) mm

Weight.....265 g

***Environmental Specifications***

Operating Temperature..... 0 °C to +40 °C

Storage Temp .....-30 °C to +60 °C

Operating Humidity ..... Non condensing (<10 °C)  
≤90 % RH (at 10 °C to 30 °C)  
≤75 % RH (at 30 °C to 40 °C)  
(Without Condensation)

Operating Altitude .....2000 meters

Storage Altitude ..... 12,000 meters

EMI, EMC.....Meets all applicable requirements in EN/IEC 61326-1

Electromagnetic Compatibility.....Applies to use in Korea only. Class A Equipment  
(Industrial Broadcasting & Communication Equipment) <sup>[1]</sup>

[1] This product meets requirements for industrial (Class A) electromagnetic wave equipment and the seller or user should take notice of it. This equipment is intended for use in business environments and is not to be used in homes.

Temperature Coefficients.....	Add 0.1 x specified accuracy for each °C above 28 °C or below 18 °C
Measurement Category .....	CAT IV 300 V, CAT III 600 V
Safety Compliance.....	EN/IEC 61010-1, Pollution Degree 2 EN/IEC 61010-2-032 EN/IEC 61010-031
	<b>CE</b>
IP Rating .....	IP 30 Per IEC 60529; Non-operating
Batteries.....	2 AAA, NEDA 24A, IEC LR03

# The Clamp Meter

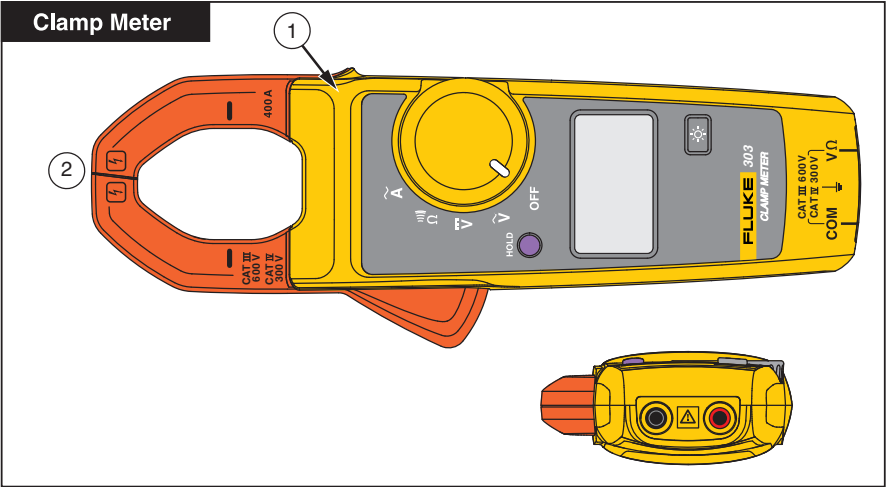

gqf008.eps



# Clamp Meter

## The Clamp Meter

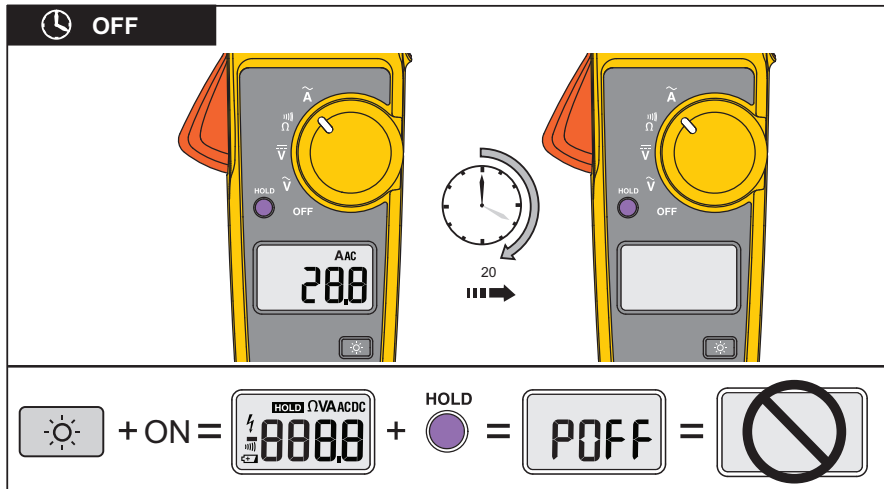

ggf001.eps

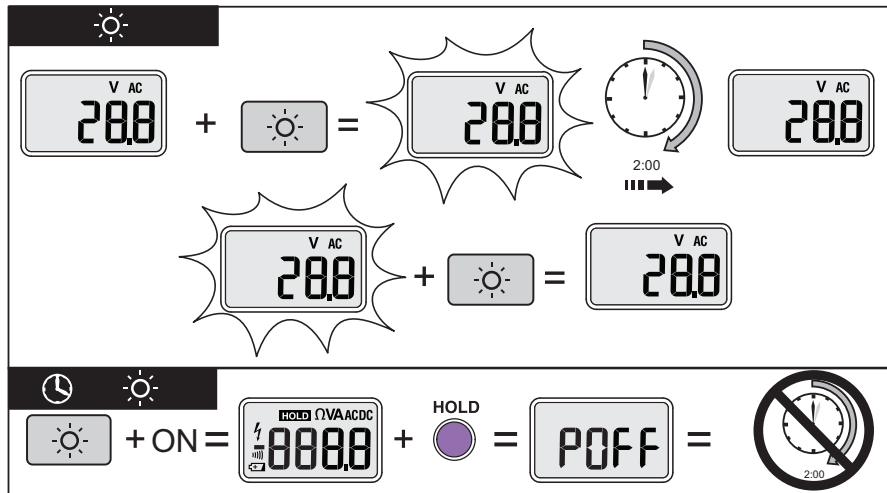

gqf002.eps

## Clamp Meter The Clamp Meter

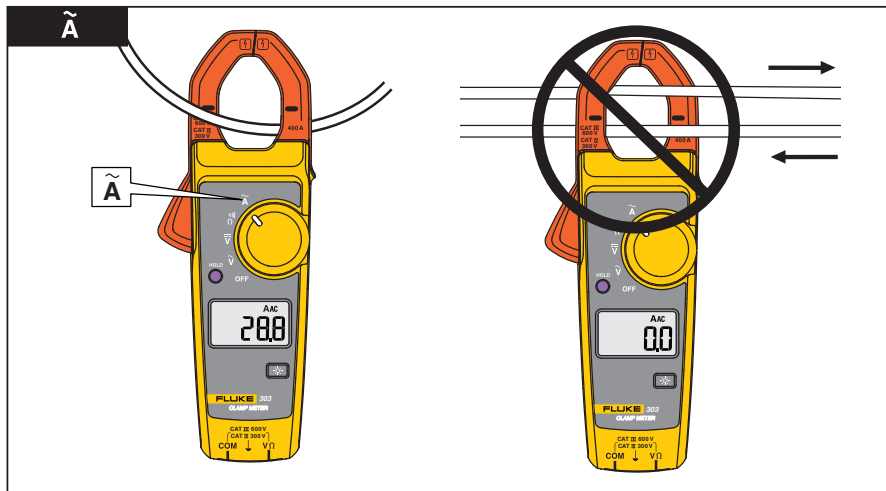

gqf003.eps

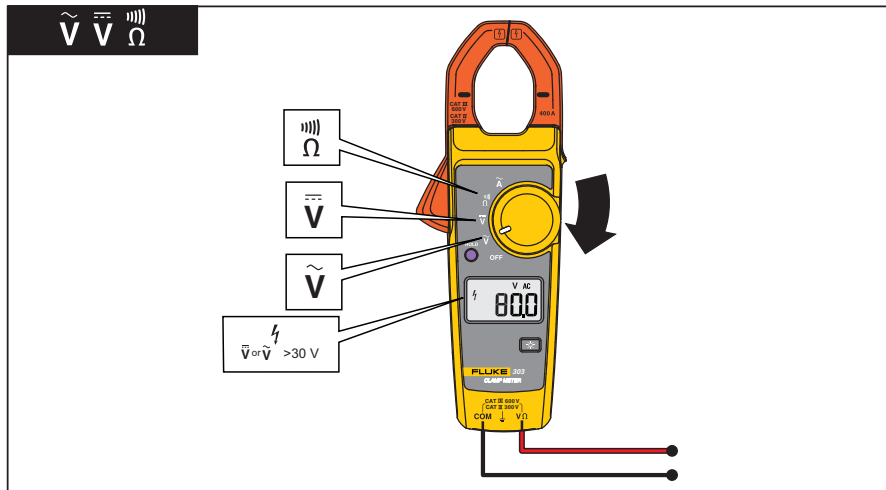

gqf004.eps

# Clamp Meter

## The Clamp Meter

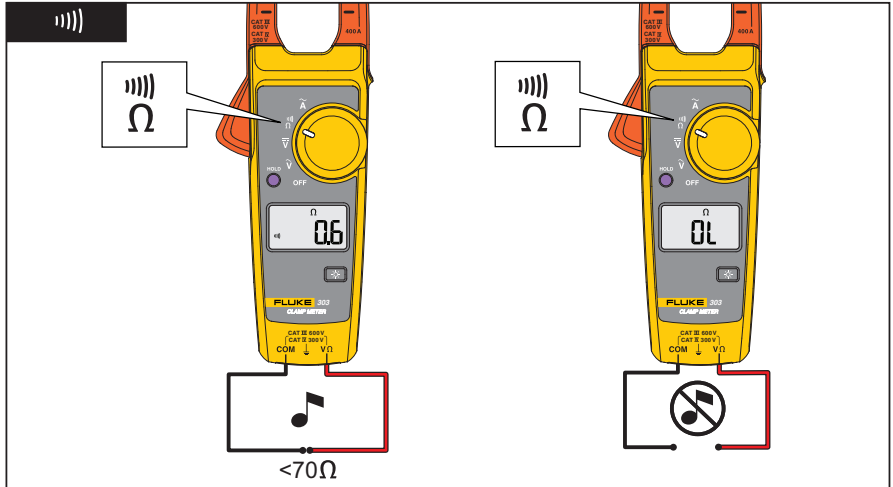

gqf005.eps

**HOLD**

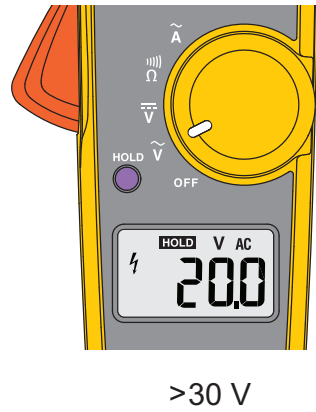
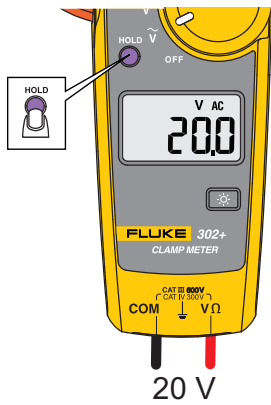

gqf006.eps

# Clamp Meter

## The Clamp Meter

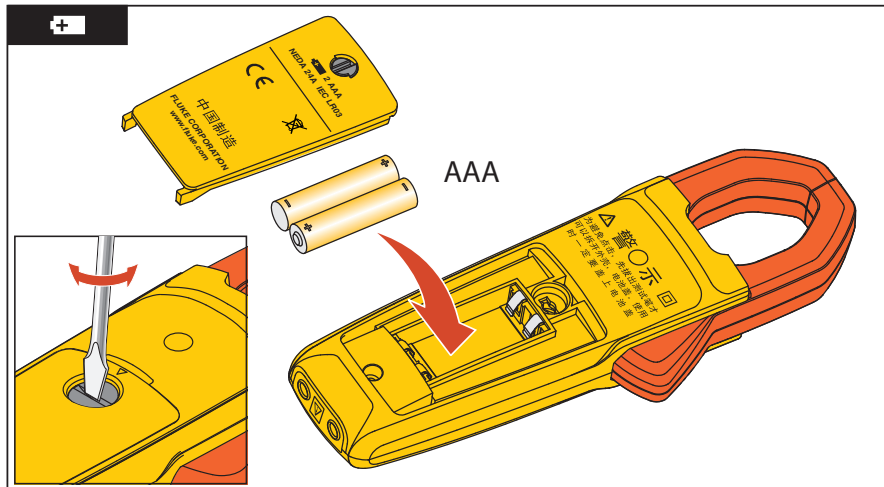

gqf007.eps

