

BK PRECISION® 316

Instruction Manual Test Equipment Depot

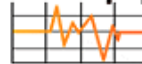

1-800-517-8431

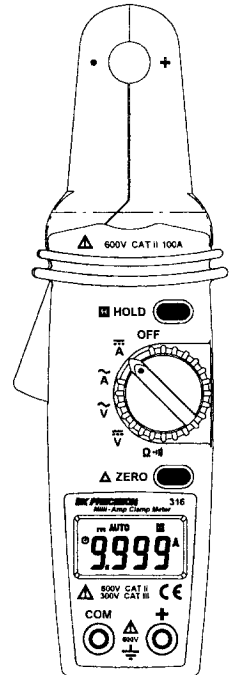

B&K Precision Corp.
22820 Savi Ranch Parkway
Yorba Linda, CA. 92887
TEL: 714- 921-9095
FAX: 714-921-6422
www.bkprecision.com

PN: 481-422-9-001
Printed In Taiwan
©2003 B&K Precision Corp.



Milli-Amp Clamp Meter

CONTENTS

TITLE	PAGE
I. Safety Information	1
Environmental Conditions.....	1
Explanation of Symbols.....	1
II. Specification	2
General Specification.....	2
Electrical Specification.....	3
III. Instrument Familiarization	4
Symbol Definition.....	4
Instrument Familiarization.....	4
Button Instruction.....	5
IV. Measuring Instruction	6
4.1 ACA measurement.....	6
4.2 DCA measurement.....	7
4.3 ACV measurement.....	8
4.4 DCV measurement.....	9
4.5 Resistance measurement.....	10
4.6 Continuity Test.....	11
4.7 Analog Signal Output.....	12
V. Battery Changing	13
VI. Maintenance	13

I. Safety Information

Do not operate the unit if the casing or the test Leads are or look damaged.

Check the main function dial to ensure it is set at the correct position before each measurement.

Do not perform resistance and continuity test on a live "powered" system.

Do not apply voltage between the test terminals and test terminal to ground that exceed the maximum limit referred to in this manual.

Exercise extreme caution when measuring live systems with voltage greater than 60V DC or 30V AC.

Keep fingers behind the protection ring when measuring with test leads.

Replace batteries when the  symbol appears to avoid incorrect data.

Environmental Conditions:



Altitude up to 2000 meters.

Operating temperature: 0°C ~ 40°C, <80% RH, non-condensing

Storage temperature: -10°C ~ 60°C, <70% RH, battery removed

Pollution Degree: 2

Explanation of Symbols:

-  Attention refer to operation Instructions.
-  Dangerous voltage may be present at terminals.
-  This instrument has double insulation.

Approvals:  EN61010 600V CAT II 300V CAT III

II. Specification

General Specification:

Digital Display:

4 digits LCD display with maximum reading 9999

Over Load:

When the signal input exceeds the maximum limit "OL" will be display.

Sample Rate:

2 times/sec

Peak Hold Sample Rate:

10ms at DCV, DCA

Low Power Indication:

When the battery is below the proper operation range,  symbol will appear on the LCD display.

Auto Power Off:

The meter will power it self OFF after 30 minutes of inactivity.

Electromagnetic Compatibility:

Vac and Aac only: RF field = 3V/m

Total accuracy = specified accuracy + 5.0% of range

Power Source: UM-4 or AAA 1.5V battery x 2.

Battery Life: 45 hr approx. (alkaline battery)

Clamp opening size: 12.5mm(1/2 inch)

Dimension (L x W x H) :

202x70x34mm, 7.95x2.76x1.33 inch

Weight: 180g(include battery)

Accessory:

Instruction Manual, Carrying Case, Test lead, Battery 1.5Vx2

Electrical Specification:

(I) The accuracy specification is defined as $\pm (\dots \% \text{reading} + \dots \text{count})$ At $23 \pm 5^\circ\text{C}$, $\leq 80 \% \text{RH}$

ACA (Autorange)

Range	Resolution	Accuracy (50Hz-500Hz)	Overload Protection
10A	1mA	2%+10	150Arms
80A	10mA		
80-100A	10mA	3.5%+10	

Accuracies are specified from 5% to 100% of range

DCA (Autorange)

Range	Resolution	Accuracy	Overload Protection
10A	1mA	2.5%+10	150Arms
80A	10mA		
80-100A	10mA	4.5%+10	

Accuracies are specified from 5% to 100% of range

ACV

Range	Resolution	Accuracy (50Hz-500Hz)	Overload Protection
600V	0.1V	1.5%+5	660Vrms

DCV

Range	Resolution	Accuracy	Overload Protection
600V	0.1V	1%+2	660Vrms

Ohm (Ω)

Range	Resolution	Accuracy	MAX Test Voltage	Overload Protection
10K Ω	1 Ω	1%+3	3Vdc	600Vrms

Continuity ($\cdot \cdot \cdot \cdot$)

Range	Active Region	MAX Test Voltage	Overload Protection
$\cdot \cdot \cdot \cdot$	<100 Ohm	3Vdc	600Vrms

(II) Analog output: (for ACA & DCA range)
 10 mV/Amp (20KHz at $\pm 3\text{dB}$)
 Accuracy: $\pm (4.5\% \text{ reading} + 0.5\text{mV})$
 Output impedance: approx 3K Ω
 Overload protection: 600 Vrms

3

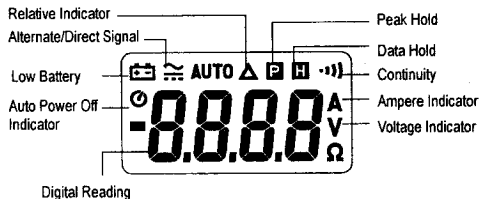
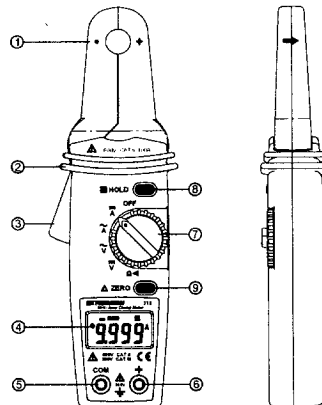
III. Instrument Familiarization:**Symbol Definition:****Instrument Familiarization:**

4

- | | |
|--------------------------|---------------------------|
| ① Current Sensing Clamp | ⑥ Positive input terminal |
| ② Safety protection ring | ⑦ Function select dial |
| ③ Clamp opening handle | ⑧ Peak / Data hold button |
| ④ LCD display | ⑨ Zero button |
| ⑤ COM input terminal | |

Button Instruction:

▪ Zero Button

Press Zero button to enter the Zero mode, "Δ" Annunciate will appear and Zero the display. The reading is stored as reference value for subsequent measurement.
Press the Zero button again, to exit the zero mode.

▪ Data Hold & Peak Hold Button

To activate the Data Hold feature, press and hold the "Hold" button.

To de-activate the Data Hold feature, press and hold the "Hold" button again.

To activate the Peak Hold feature, press and hold the "Peak" button until the symbol displays.

To deactivate the Peak feature, press and hold the "Peak" button for 2 seconds.

The meter will return to normal mode operation.

Note: This meter is built with peak hold function at ACA, DCA, ACV, DCV ranges.

▪ Disable Auto power off

Press and hold "ZERO" button and then the power on the meter, the  symbol will disappear.

IV. Measuring Instruction:

4.1 ACA measurement:

Switch the function selector to A~ range.

Open the clamp by pressing the jaw-opening handle and insert the cable to be measured into the jaw.

Close the clamp and get the reading from the LCD panel.

Note:

Before this measurement, disconnect any test lead with the meter for safety.

In some cases where reading is difficult, press the HOLD button and read the result later.

CORRECT

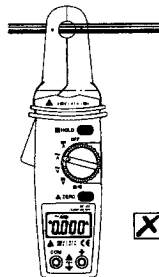
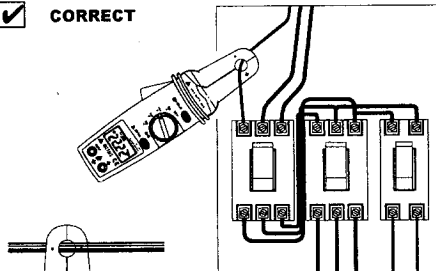

INCORRECT

4.2 DCA measurement:

Switch the function selector to A $\overline{\text{---}}$ range.
 Press ZERO button to enter the zero reading.
 Open the clamp by pressing the jaw-opening handle and insert the cable to be measured into the jaw.
 Close the clamp and get the reading from the LCD panel.

Note:

Before this measurement, disconnect any test lead from the meter for safety.

In some cases where reading is difficult, press the HOLD button and read the result later.

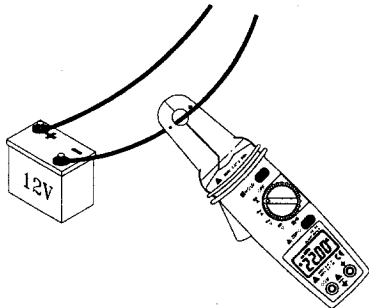

7

4.3 ACV Measurement:

⚠ WARNING!

Maximum Input Voltage is 600V AC/DC. Do not attempt to Take any voltage measurement that may exceed this maximum to avoid Electrical shock hazard and/or damage to this instrument.

Switch the function selector to V \sim range.

Connect red test lead to "+" terminal and black one to the "COM" terminal.

Measure the voltage by touching the test lead tips to the test circuit where the value of voltage is needed.

Read the result from the LCD panel.

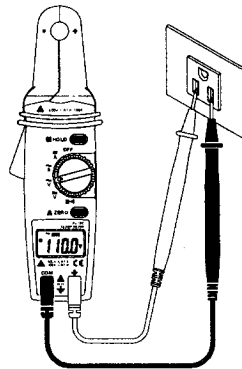

8

4.4 DCV measurement:

Switch the function selector to $V \text{ ---}$ range.

Connect red test lead to "+" terminal and black one to the "COM" terminal.

Measure the voltage by touching the test lead tips to the test circuit where the value of voltage is needed.

Read the result from the LCD panel.

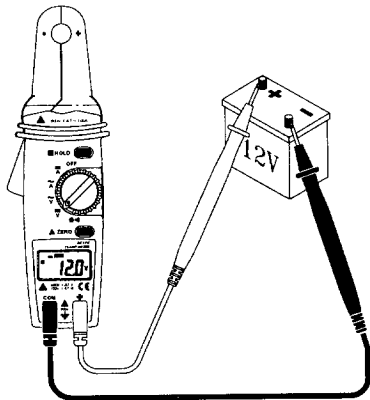

4.5 Resistance measurement:

Switch the function selector to Ω range.

Connect red test lead to "+" terminal and black one to the "COM" terminal.

Connect tip of the test leads to the points where the value of the resistance is needed.

Read the Ohm value from the LCD panel.

Note:

When measuring resistance value from a circuit, make sure the power is cut off and all capacitors are discharged.

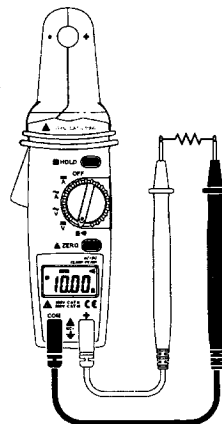

4.6 Continuity Test:

Switch the function selector to Ω or Ω range.

Connect red test lead to "+" terminal and black one to the "COM" terminal.

Connect tip of the test leads to the points where continuity is to be tested.

If the resistance is under 100Ω , the beeper will sound continuously.

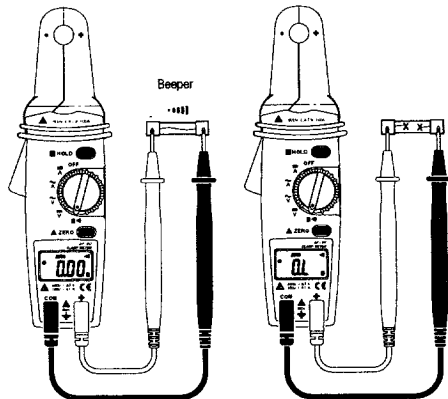

4.7 Analog Signal Output:

Switch the function selector to A $\overline{\text{---}}$ or A \sim range.

Connect red test lead to "+" terminal and black one to the "COM" terminal.

Connect tip of the test leads to the meter or oscilloscope input terminal.

Open the clamp by pressing the jaw-opening handle and insert the cable to be measured into the jaw.

Close the clamp and get the analog voltage signal from the meter.

Note:

If measuring DC via clamp, signal output will be DC voltage. If measuring AC via clamp, signal output will be AC voltage.

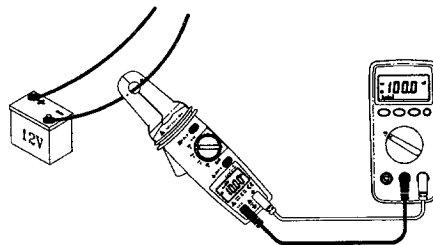

V. Battery Changing:

1. When the battery voltage drops below proper operation range the  symbol will appear on the LCD display and the battery will need to be changed.
2. Before changing the battery, switch the function selector to "OFF" and disconnect test leads.
Open the back cover using a screw driver. Replace the old batteries with two UM-4 or AAA size batteries.
3. Close the back cover and fasten the screw.

VI. Maintenance:**CAUTION**

To avoid contamination or static damage, do not touch the circuit board without proper static protection.

REMARK

- * Remove the batteries, if the meter is not used for extended periods of time. Do not store the meter in a high temperature/humidity environment.
- * When measuring current, keep the cable at the center of the clamp to get more accurate readings.

CLEANING

Periodically wipe the case with a dry cloth and without detergent. Do not use abrasives or solvents on this instrument.

Warranty Service: Please return the product in the original packaging with proof of purchase to the below address. Clearly state in writing the performance problem and return any leads, connectors and accessories that you are using with the device.

Non-Warranty Service: Return the product in the original packaging to the below address. Clearly state in writing the performance problem and return any leads, connectors and accessories that you are using with the device. Customers not on open account must include payment in the form of a money order or credit card. For the most current repair charges contact the factory before shipping the product.

Return all merchandise to B&K Precision Corp. with pre-paid shipping. The flat-rate repair charge includes return shipping to locations in North America. For overnight shipments and non-North America shipping fees contact B&K Precision Corp..

B&K Precision Corp.
22820 Savi Ranch Parkway
Yorba Linda, CA. 92887
Phone: 714- 921-9095
Facsimile: 714-921-6422
Email: service@bkprecision.com

Include with the instrument your complete return shipping address, contact name, phone number and description of problem.

Limited one-Year Warranty

B&K Precision Corp. warrants to the original purchaser that its product and the component parts thereof, will be free from defects in workmanship and materials for a period of one years from the data of purchase.

B&K Precision Corp. will, without charge, repair or replace, at its' option, defective product or component parts. Returned product must be accompanied by proof of the purchase date in the form a sales receipt.

To obtain warranty coverage in the U.S.A., this product must be registered by completing and mailing the enclosed warranty card to B&K Precision Corp., 22820 Savi Ranch Parkway, Yorba Linda, CA. 92887 within fifteen (15) days from proof of purchase.

Exclusions:

This warranty does not apply in the event of misuse or abuse of the product or as a result of unauthorized alternations or repairs. It is void if the serial number is alternated, defaced or removed.

B&K Precision Corp. shall not be liable for any consequential damages, including without limitation damages resulting from loss of use. Some states do not allow limitation of incidental or consequential damages, so the above limitation or exclusion may not apply to you.

This warranty gives you specific rights and you may have other rights, which vary from state-to-state.

Model Number: _____ Date Purchased: _____