

User Manual

Fotric 320M/320F Series

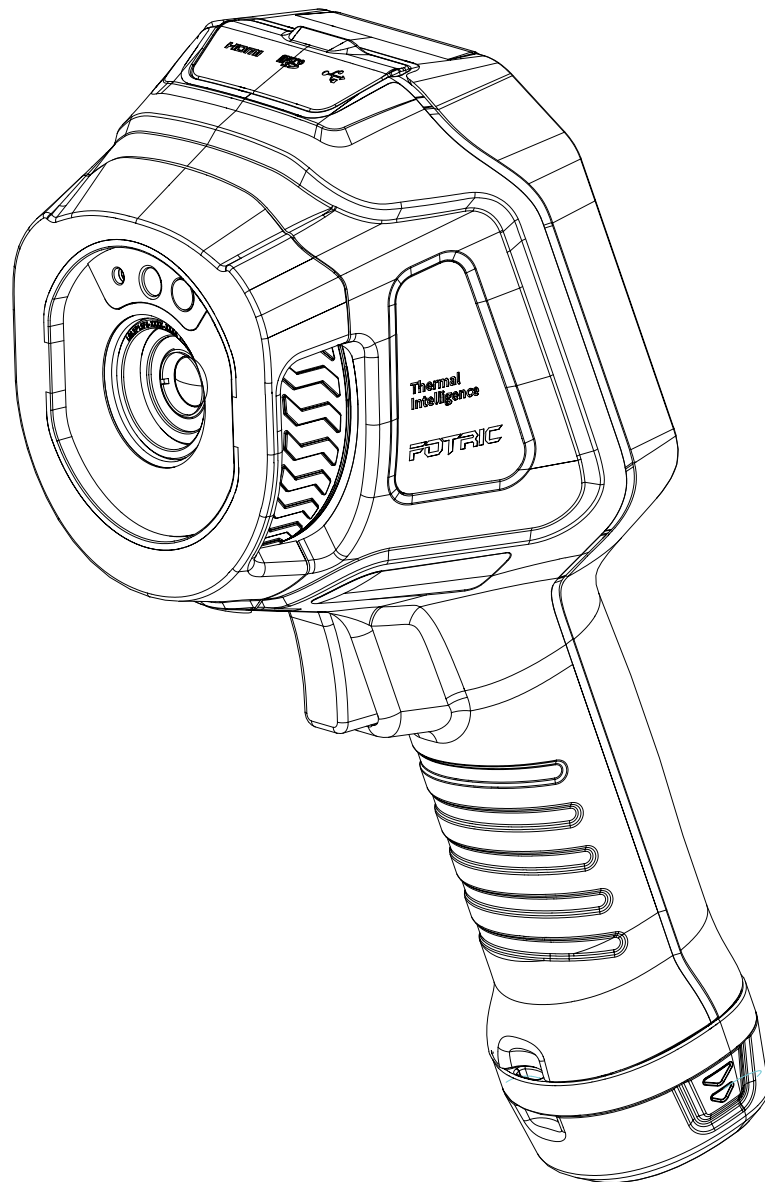

Contents

Legal Disclaimer

1.1 Legal Disclaimer	1
1.2 Usage Statistics	2
1.3 Copyright	2
1.4 Quality Assurance	2
1.5 Export Control	2

Safety Information

Definition	4
Please read before using:	4

Product Configuration

1.1 Standard Configuration	6
----------------------------------	---

Hardware

2.1 Front View	7
2.2 Rear View	8
2.3 Top View	9
2.4 Right View	10

Operation guide

3.1 battery	11
3.2 Turning on and off the thermal camera	13
3.3 Adjusting the Infrared Lens Manually	14
3.4 Copying the TF card's data to computer Via TF card reader	15
3.5 Copying the TF card's data to computer Via USB cable	15
3.6 The Laser Ranger as a pointer	16
3.7 AI programmable key	17

3.8 Gallery	20
3.9 NUC	21

Main interface

4.1 Overview	22
4.2 Swipe-down menu	24
4.3 Digital zoom of real-time imaging	25
4.4 System Menu	26
4.5 Temperature Scale Mode	28
4.6 Measurement Parameter Settings	34
4.7 Image mode	41
4.8 ROI measurement tools	46
4.9 Setting Sound Alarm	60
4.10 Palette	62
4.11 Color alarm(isotherms)	64

SYSTEM SETTINGS

5.1 Capture mode	69
5.2 Video recording	69
5.3 Time-lapse mode	70
5.4 Connection	71
5.5 Setting Temperature Range	74
5.6 Storage & Save options	75
5.7 Device set	76

Image freeze interface

6.1 Favorite	89
6.2 Voice annotation	90
6.3 Text annotation	91
6.4 Tag	93

Video freeze interface

7.1 Play.....	98
7.2 Save.....	98

Gallery

8.1 Favorite Filter	101
8.2 Tags filter.....	101
8.3 Open image and video files	102
8.4 Thermal files analysis.....	103
8.5 Deleting image or video file.....	106
8.6 Deleting multiple files	107

Thermal imager maintenance

9.1 Cleaning casing/ wires and other components	108
9.2 Cleaning lenses	108
9.3 Cleaning uncooled infrared focal-plane detector	109
9.4 Lithium battery maintenance.....	110

Vocabulary

Emissivity Table

Legal Disclaimer

1.1 Legal Disclaimer

Uncooled thermal imager manufactured by FOTRIC are entitled to 1 to 2 years warranty service (depending on the specific model) from the date of initial purchase and delivery. Warranty covers defects caused by materials and production processes, provided that such products are handled under normal storage, use, and repair conditions and in accordance with FOTRIC instructions.

Products not manufactured by FOTRIC but included in the system that FOTRIC sells to the original purchaser are covered by the specific supplier's warranty terms (if any) and FOTRIC is not liable for those products. This warranty is provided to the original purchaser and is not transferable. This warranty does not apply to any product that has been damaged by misuse, neglect, accident, or abnormal operating conditions. Consumable parts are not covered by this warranty.

Any defects in the products covered by this warranty must be reported and the product must not be used after, to prevent further damage. The purchaser must report any defects to FOTRIC immediately, otherwise this warranty will not apply.

If the product is proven defective in relation to materials or manufacturing after FOTRIC's inspection, it is up to the user whether it is to be repaired or replaced (refer to FOTRIC warranty policy), provided that the product must be returned to FOTRIC within 3 Months from abovementioned report date. FOTRIC has no obligation or liability for any defects other than those mentioned above. This product is exempt from any other warranties, expressed or implied. FOTRIC hereby disclaims any implied warranties of merchantability and applicability for a particular purpose. FOTRIC is not responsible for any direct, indirect, special, incidental or consequential loss or damage based on contract, civil, or any other legal theory. This warranty clause shall apply the relevant provisions of the laws of the People's Republic of China. Any dispute or claim arising out of or relate to this warranty shall be finally settled through arbitration in accordance with the rules

of the Shanghai Pudong New District People's Court of the People's Republic of China. The place of arbitration shall be Shanghai.

1.2 Usage Statistics

FOTRIC reserves the right to collect anonymous usage statistics to help maintain and improve the quality of the products and services provided.

1.3 Copyright

No parts of this software (including source code) may be reproduced, transmitted, transcribed, or translated into any kind of language or computer language in any form or by electronic, electromagnetic, optical, manual ways, or any other means without the prior written permission of FOTRIC.

No parts of this document may be reproduced, photocopied, reprinted, translated, or transmitted to any readable electronic medium or machine without the prior written consent of FOTRIC.

The names and logos shown on the products herein are either registered trademarks or trademarks of FOTRIC and/or its affiliates. All other trademarks, trade names or company names referenced herein are for identification purposes only and are the property of respective owners.

1.4 Quality Assurance

The quality management system for the development and production of these products in FOTRIC has been certified in accordance with the ISO 9001 standard.

FOTRIC is committed to a policy of continuous development, as we reserve the right to modify or upgrade any product without prior notice.

1.5 Export Control

Thermal imaging products are listed as export-controlled products by U.S. Department of Commerce, United Nations Security Council (UNSC), and European Union (EU). This product contains a focal plane array and cannot be

used in controlled countries (such as North Korea, Iran, Syria, Cuba, Sudan, Russia, etc.). Please do not bring this product into or used in controlled countries. Any loss or liability arising from the above actions will be borne by the purchaser.

Safety Information

This product complies with the restrictions for Class A digital equipment in Chapter 15 of the FCC Rules. These restrictions are designed to prevent harmful interference to civilian installations. If not installed and used in strict accordance with the instructions, this device will generate, use and emit radio frequency energy, which may cause harmful interference to radio communications.

Definition

! Warning> Represents a hazardous situation or behavior that could result in personal injury or death.

! Caution > Represents conditions or actions that could result in damage to the device or permanent loss of data.

! Notice> Represents useful information for users.

Please read before using:

! Warning > This is class A product. In a domestic environment, this product may cause radio interference in which cause the user may be required to take adequate measures.

! Warning > Do not disassemble or do modifications to the battery of the thermal imager. The battery contains safety and protection devices, which, if damage occurs, can cause the battery to become hot, or cause an explosion or an ignition. If there is a leak from the battery and you get the fluid in your eyes, do not rub your eyes. Flush well with water and immediately get medical care. The battery fluid can cause injury to your eyes if you do not do this.

! Warning > The thermal imager is equipped with a laser pointer. Do not look directly into the laser beam. The laser beam can cause eye irritation.

!Caution> The thermal imager uses a very sensitive thermal sensor, so do

not point the infrared camera (with or without the lens cover) at strong energy sources, for example, devices that cause laser radiation, or the sun. This can have an unwanted effect on the accuracy of the camera. It can also cause damage to the detector in the camera.

!Caution> Original packing box must be used during transportation. Please do not strongly hit the thermal imager during use and transportation.

! Caution > When storing the thermal imager, it is recommended to use the original packing box and place it in a cool and dry place, away from a strong electromagnetic field.

!Caution> Please avoid oil and various chemical substances from contaminating or damaging the surface of the lens. Please cover the lens with caps after use.

!Caution> Do not use the camera in temperatures higher than +50° C (+122° F), unless other information is specified in the user documentation or technical data. High temperatures can cause damage to the camera.

!Caution> To prevent the potential risk of data loss, please copy (back up) the data to a computer or server as period.

! Caution > Please do not open the thermal imager's shell or modify it without permission. Repair services can only be performed by authorized FOTRIC personnel.

! Notice> After the thermal imager is turned on, it may take about 10~15 minutes to warm up before accurate measurement.

!Notice> Every thermal imager's temperature correction has been performed before delivered from factory.

Product Configuration

1.1 Standard Configuration



FOTRIC 320 series Infrared Thermal Imager (included lens)

- A handheld thermal camera(Lens included),
- 2 pieces of batteries
- One set of USB-Type C cable
- One set of Micro-HDMI to HDMI cable
- TF card & TF card reader
- Documentations & Quick-start user manual
- One set of Power adaptor
- Portable soft bag (for specific models)
- Portable hard case (for specific models)

Hardware

2.1 Front View

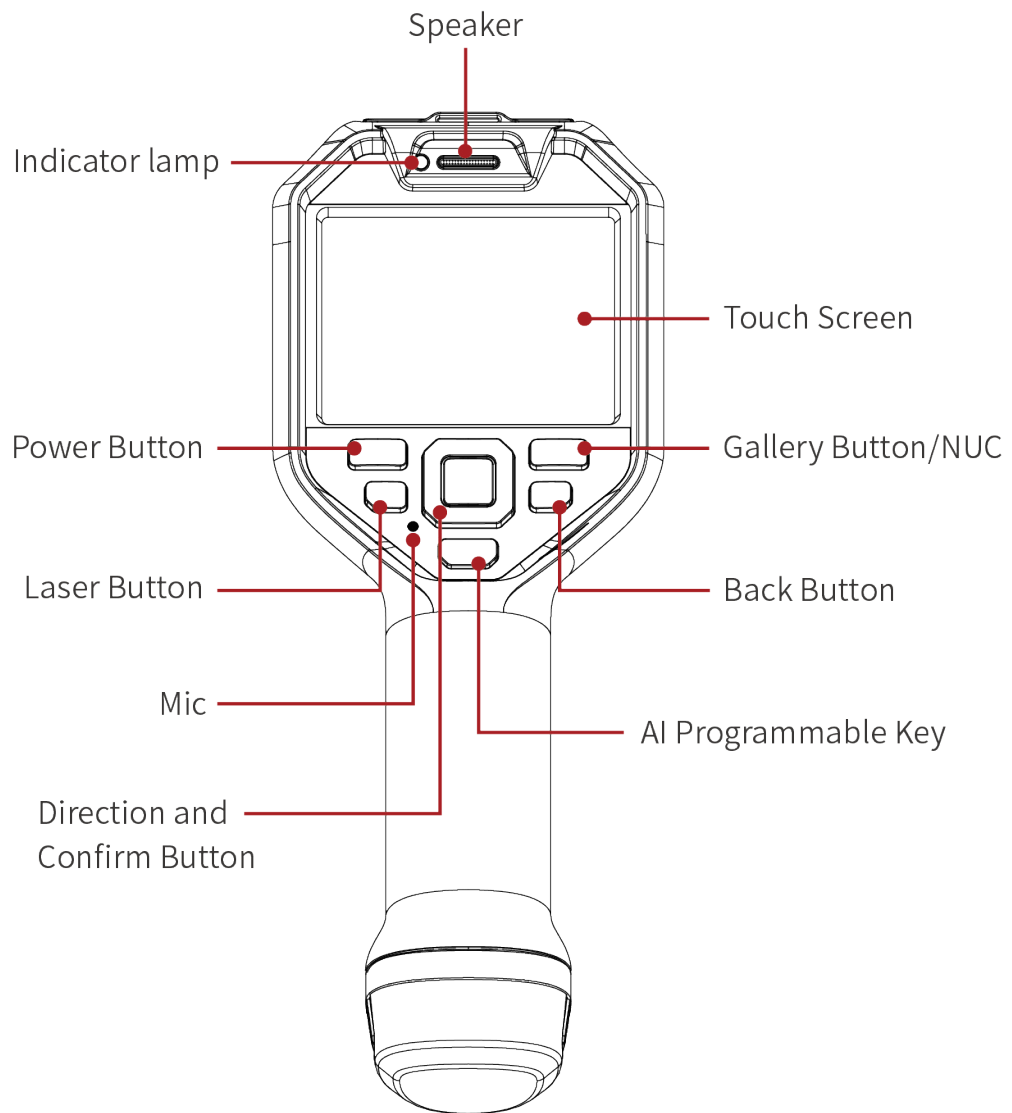

2.2 Rear View

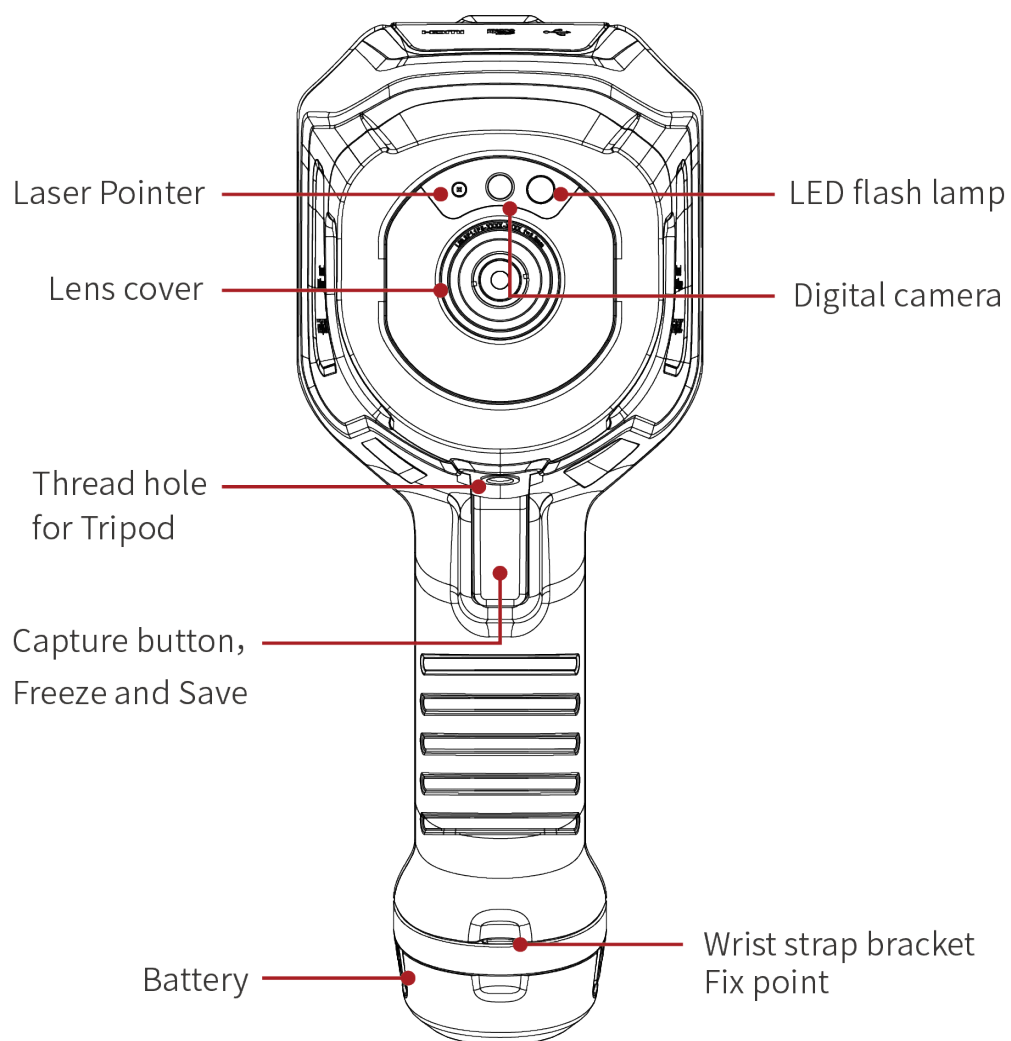

2.3 Top View

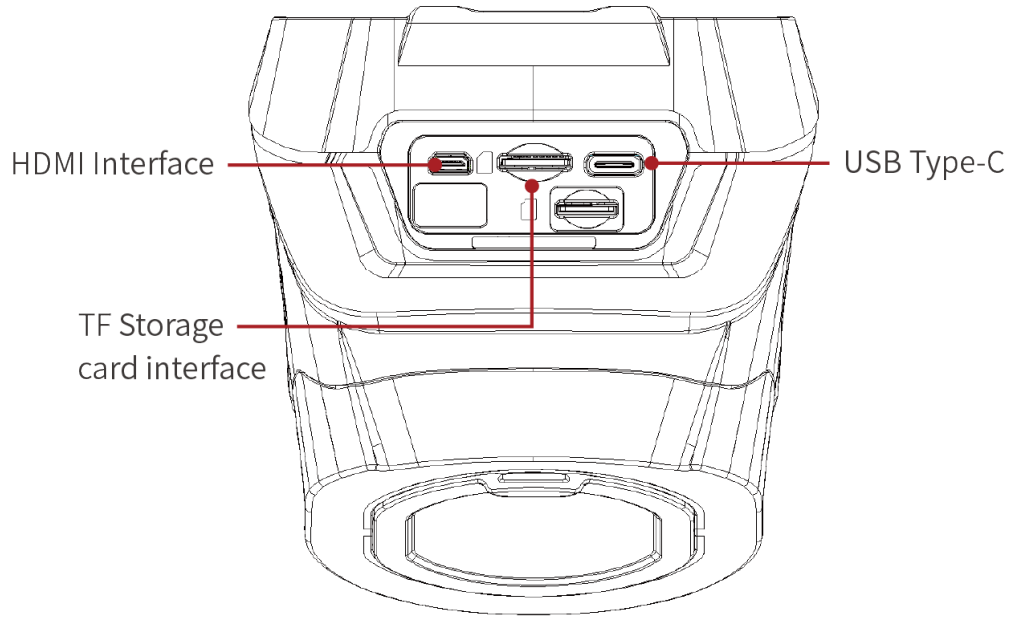

2.4 Right View

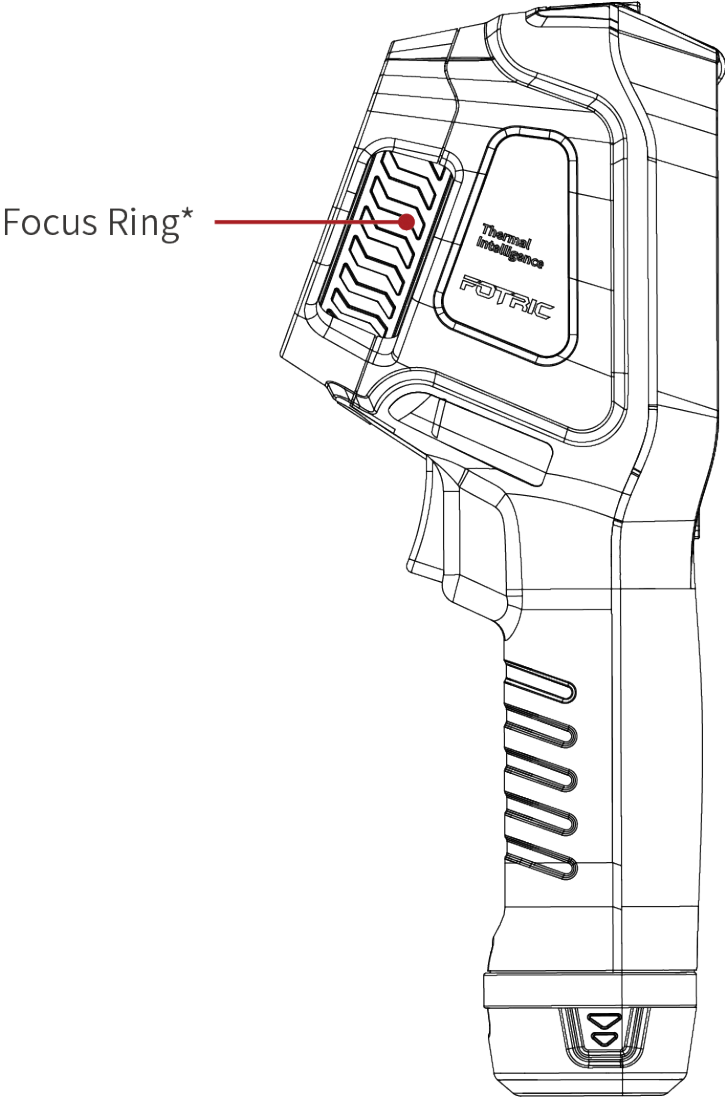

Operation guide

3.1 battery

3.1.1 battery charging

1. Use a battery charging dock to charge the battery by connecting to a USB Type-C cable and power adaptor.
2. Or charge the battery from the USB interface of the thermal camera when it is plugged in.

The LED indicator lamp on the front view of thermal imager:

Signal Type	Explanation
The LED indicator flashes in Green	When the power charger is plugged in, and the battery is not fully charged.
The LED indicator glows continuously Green	When the charger is plugged in, and the battery has been fully charged.

The LED indicator lamp on the independent accompanying battery charger

Signal Type	Explanation
The LED indicator glows continuously in red	The battery is being charged
The LED indicator glows continuously in green	The battery is fully charged

3.1.2 Low battery warning

1. If the thermal camera's battery level is below 20% when turned on, the battery-warning window will pop up.
2. If the thermal camera's battery level is below 20% during operation, the

battery-warning window will pop up; If the operation continues, the battery-warning window will pop up again when the battery level is below 10%.

3. If the thermal camera's battery level is below 20% during use, the battery-warning window will pop up; if plugged in the power charging adaptor, the battery warning window will disappear.

3.1.3 Plugging out the battery when the camera is on charging

1. When the camera is turned off, and no battery inside:

If connected to a power adaptor or computer via USB cable, the camera will not be turned on.

2. When the camera is turned on, and the battery is inside;

if the battery is plugged out when the camera is being charged, a prompt window will pop up: "Battery not detected, auto shutdown in 10 seconds", and start 10 seconds countdown.

If plugged battery within 10 seconds, the camera will not shutdown

3.1.4 USB interface functions

The thermal camera's USB Type-C interface to support 3 functions:

- 1) Support MTP connection to computers, for reading and quickly transfer data from the TF card.
- 2) Support real-time communication with PC and camera, for full-radiation video streaming and analysis. When the camera is on video streaming, the camera's screen will be locked from touch-screen or panel operations.
- 3) Support battery charging in the camera. When the camera is turned off with the battery in, the USB cable can still support charging, but no data transfer or video streaming.
- 4) When connect the camera to a computer via USB cable, the default mode

is MTP mode, for data transfer and video streaming. Users can change settings mode to charging mode, which supports charging and video streaming at the same time.

3.1.5 Screen-off settings

- 1) When the screen is on, it supports manual screen-off, Auto screen-off with timer, and Never screen-off option.
- 2) When the screen is on, press the power button to turn off the screen manually.
- 3) When the screen is off press the power button to wake up the screen.
- 4) In Auto screen-off mode, the camera can automatically turn off the screen after a certain time of non-operation, such as 5, 10, 30 minutes, or never off. When selecting 'Never-screen off', users can only use the power button to turn the screen off and on.
- 5) when the screen is off, plugging in the USB cable to a computer or a power adaptor will wake up the screen.

3.2 Turning on and off the thermal camera

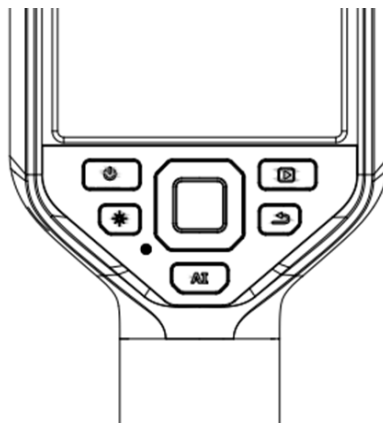

To turn on the thermal imager, long-press the Power Button 

To power off or restart the thermal imager, long-press the Power Button 

(for about 5 seconds), and select "Power-off" or "Reboot" from the pop-up window.

3.3 Adjusting the Infrared Lens Manually

Operation Figure



- For far focus, rotate the focus ring clockwise (align the LCD facing towards you).
- For near focus, rotate the focus ring counterclockwise (align the LCD facing towards you).

3.4 Copying the TF card's data to computer Via TF card reader.

Operation procedures

After capturing photos and videos, the files are saved in the TF card.

The image and video files can be copied to a computer via TF card and TF card reader.

- Pull out the TF card in the thermal imager
- Insert the TF card into a card reader, and insert the card reader into a computer's USB port
- In the file explorer, open the '/Gallery' file of the TF card disk, and copy desired files to the computer
- Import the data to the PC software for further analysis and reporting

3.5 Copying the TF card's data to computer Via USB cable.

After capturing images or videos, the files are stored in the TF card.

The image and video files can be copied to a computer from the TF card, via USB cable.

Operation procedures



1. Open the lid on the top of the thermal camera, and find the USB Type-C interface.
2. Use a USB- Type-C to USB cable to connect the thermal imager to a computer.

3. Turn on the thermal imager
4. In the file explorer, open the '/Gallery' file of the camera disk, and copy desired files to the computer
5. Import the data to the PC software for further analysis and reporting

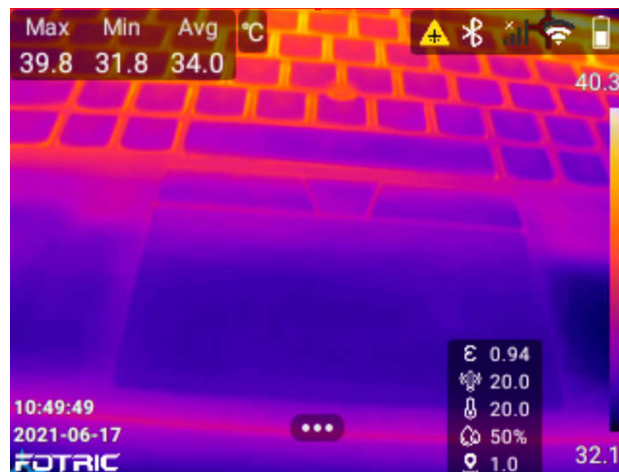
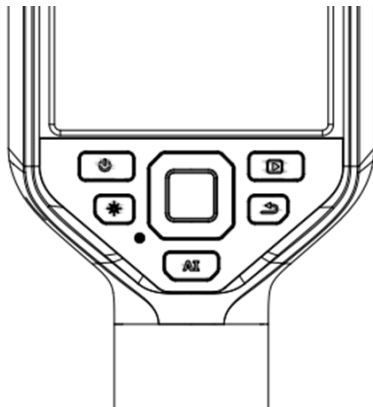
3.6 The Laser Ranger as a pointer



The laser ranger can serve as a laser pointer. When turned on, a laser dot is visible on the target object

1. To turn on the laser, press the laser button .
2. When the laser is activated, there will be a visible " " symbol on the top-right corner of the screen and the laser dot will be approximately on the center of the screen.
3. To turn off the laser, release the laser button .

3.7 AI programmable key

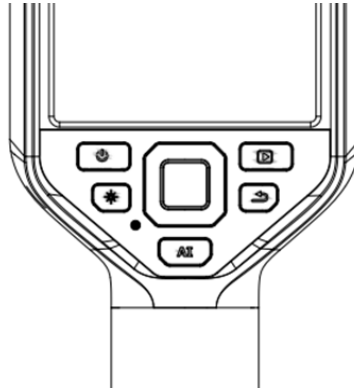

The AI programmable key can call upon different functions according to the user's need. It is available on the main interface, image freeze interface, and gallery's image analysis interface.

Long press on the 'AI' key (>2s) to enter the AI programmable interface, to link different functions onto the button.

Press the 'OK' button to finalize the option, and press the 'Return' button to abort the selection process.

Tap on the 'AI' key to activate the linked function.

- Available programmable key functions on the main interface

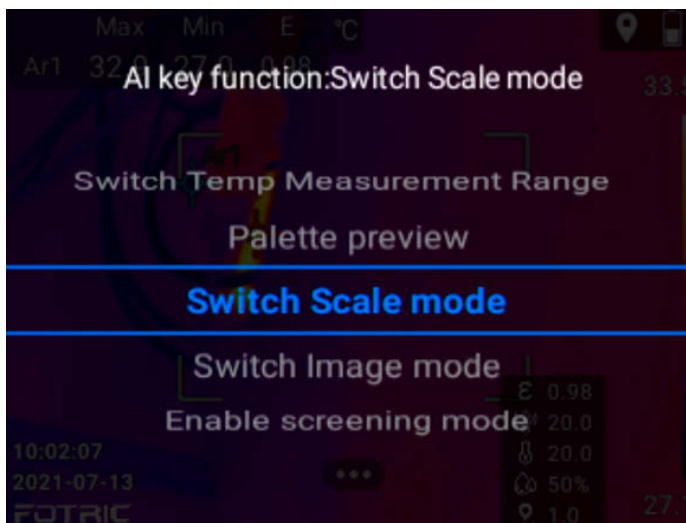

- Switch temperature measurement range
- Palette preview
- Switch scale mode
- Switch image mode
- Available programmable key functions on image freeze interface

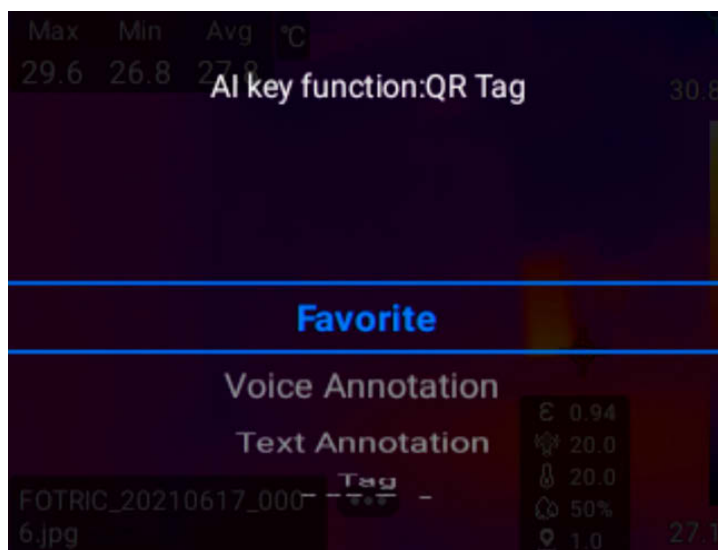

- Favorite,
- Voice annotation,
- Text annotation,
- Tag,
- QR tag.
- Available AI programmable key functions on Gallery's image analysis interface

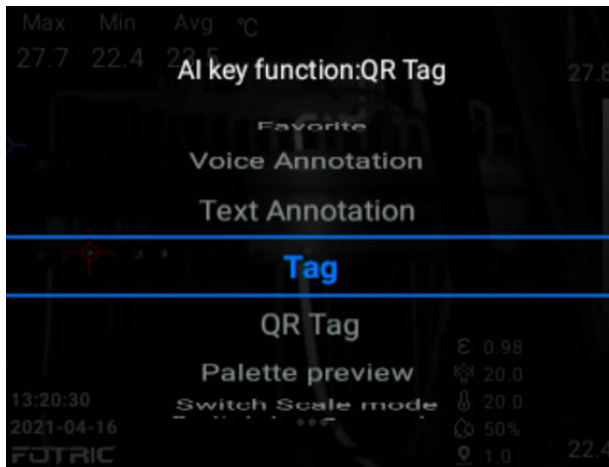

- Favorite,
- Voice annotation,
- Text annotation,
- Tag,
- QR tag,
- Switch palette,
- Switch scale mode,
- Switch image mode.

Note: On the video analyzing interface, the 'AI' programmable key is not available

3.8 Gallery

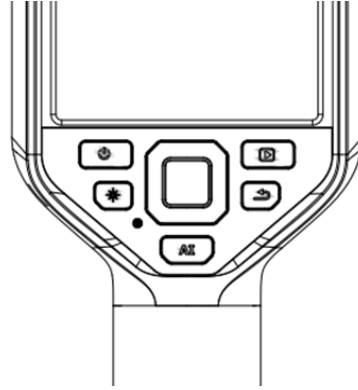

Press the 'Gallery' button  to get access to the gallery, like the image shown below. For specific instructions, please refer to chapter 8 on the menu

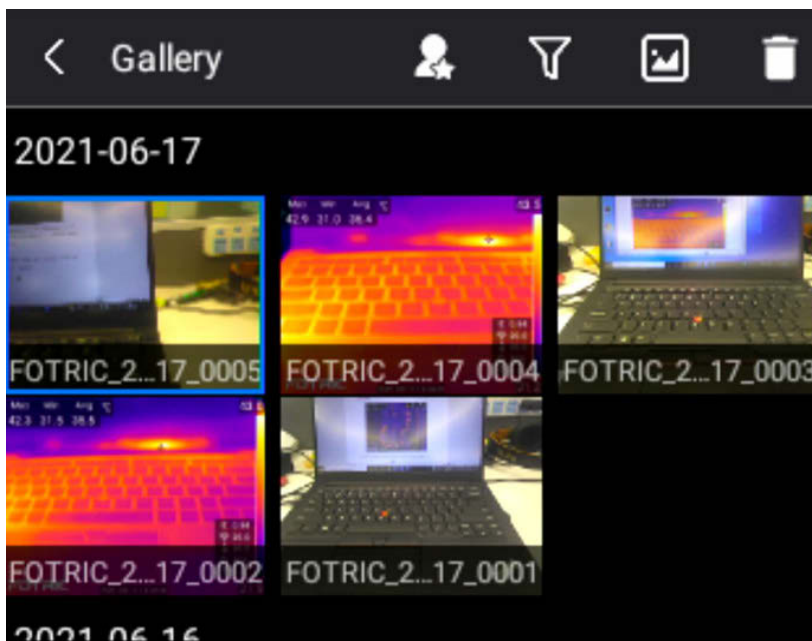

3.9 NUC

When it shows "calibration..." on the top of the screen, 'Non-Uniform-Calibration' (NUC) is on proceeding.

NUC is proceeded automatically, for example, when the device is starting, changing measurement range, and every few minutes.

Manually operate NUC

Users can manually operate NUC, by long-press the 'gallery' button for more than 2 seconds

Main interface

4.1 Overview

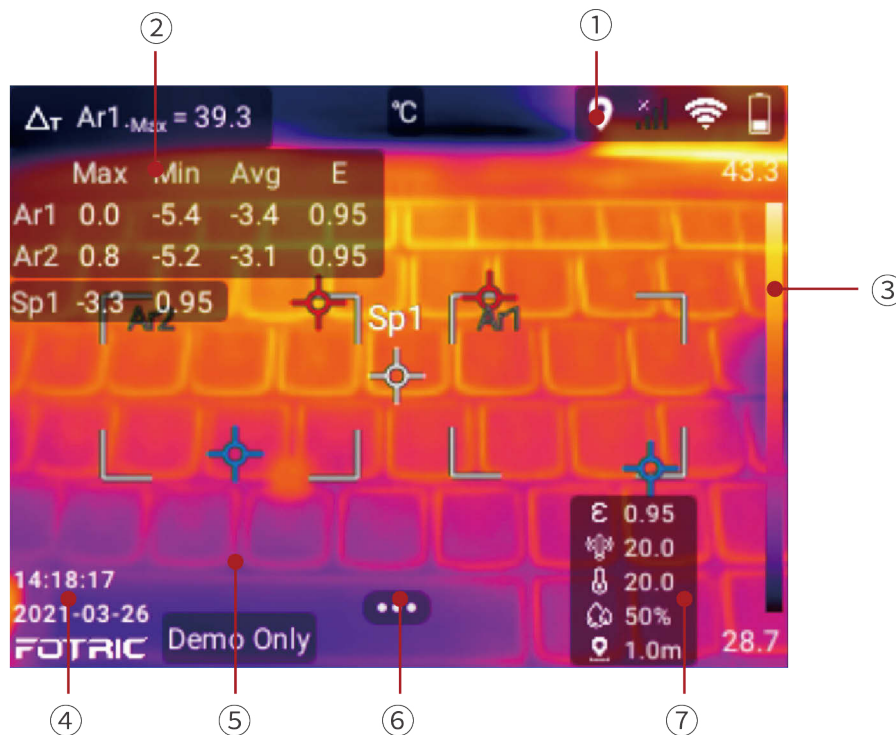

1. Status bar

On the right top corner is the status bar. It contains status information about: battery, TF card low storage room alarm, Bluetooth, Wi-Fi, Wi-Fi hotspot, geographical location, and laser-on indicator.

Introduction:

- Battery icon: indication of battery's power level and charging status
- TF card low storage room alarm: when the TF card's storage room is lower than 100MB, it will be displayed.
- Laser-on indicator: when the laser is activated, the icon will be displayed

- Bluetooth icon: when Bluetooth is activated and connected, the icon will be displayed
- Wi-Fi icon: When the Wi-Fi is on and properly connected, the icon will be displayed.
- Geographical location icon: When the GPS is turned on, the icon will be displayed.

2. Measurement results

On the left top part of the screen is the Measurement results

- It can display the maximum, minimum, and average temperature on the screen and overall emissivity
- It can display the ROI's maximum, minimum, and average temperature, and ROI emissivity. For specific instructions, refer to section 4.8.6

3. Palette and temperature scale display

On the right side is the temperature scale displays: currently used palette color, the upper and lower limits of the temperature scale, temperature span. For specific instructions, please refer to Section 4.5 Temperature Scale Mode and 4.10 Palette.

4. LOGO & System Date/Time

On the left bottom side of the screen are the brand logo and system time. The time display is refined to seconds. The time format can be defined as 24 hours.

5. Image Display

Displays: Thermal, Digital camera, Picture in Picture, Thermal & Visual light digital camera Image Fusion, and measurement tools. For specific instructions, please refer to Section 4.7 Image Mode

6. System menu

On the bottom of the screen  is the system menu button. For specific instructions, please refer to section 4.4

7. Measurement parameter

On the bottom-right corner of the screen are the measurement parameters: emissivity, reflected temperature, environment temperature, humidity, and measuring distance. For specific instructions, please refer to section 4.6 'Measurement Parameters Settings'

4.2 Swipe-down menu

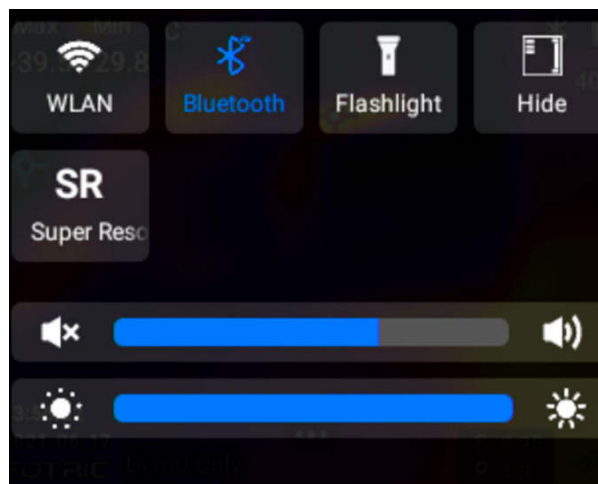

This menu can be displayed by swiping from up to down on the screen.

The menu contains system functions like WLAN, Bluetooth, flashlight, Hide overlays, SR(super resolution), volume, and brightness

1. To open: Swipe down from the top of the screen
2. Button control can be set by click.
3. To close: Swipe up from the bottom, or click any button on the operation panel.

Hide All Overlays

Image overlay information includes measurement result table, temperature, measurement parameters, ROI settings, and system menu button. Overlay information can be Hide by the "Hide" function in the swipe-down menu.

When the 'Hide' function is activated, users can not enter the main menu, but can still get access to functions like gallery browsing, focusing, and taking images.

As shown below:

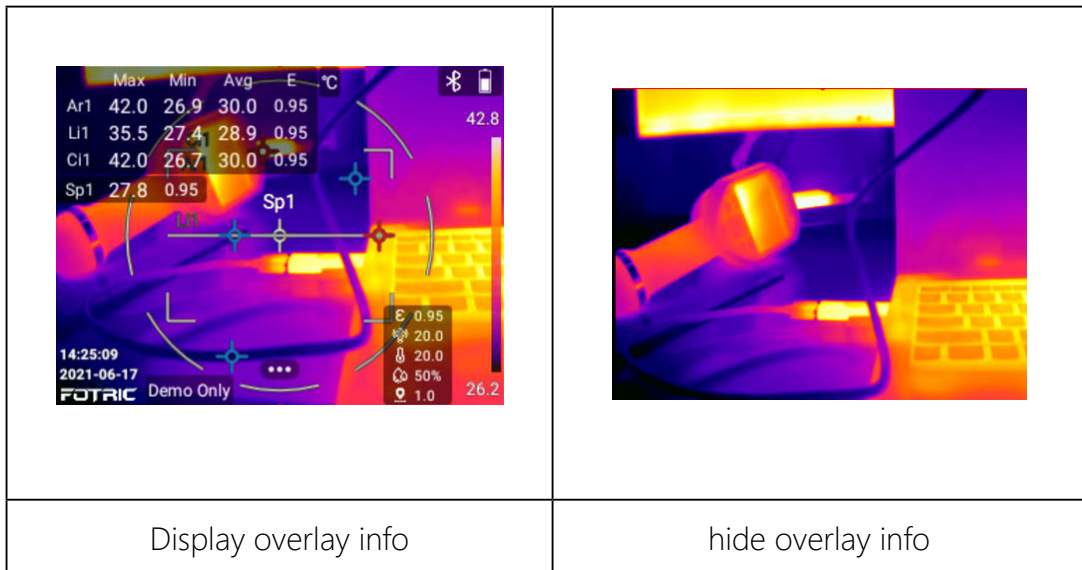

4.3 Digital zoom of real-time imaging

The Real-time thermal image and video can be scaled using the 'digital zoom' function of the thermal imager.

The digital zoom function is only available in thermal image mode.

Operating Procedures:

- Zoom in: Touch the screen with two fingers and spread the fingers apart.
- Zoom out: Touch the screen with two fingers and pinch the fingers together

Use of digital zoom:

- Capture image: zoomed photo will serve as cover view, but all the raw data in the original image will be kept.
- Freeze image: Not support for digital zoom
- Gallery image: Support for digital zoom

1. Hide the adjusting scroll:

Pressing the 'OK' or 'return' button. When magnification is greater than 1.0, it will display the zoomed value; when magnification is 1.0, it will hide the zoomed value;

2. The magnifying capability is determined by the device model. The minimal magnification increment is 0.1

4.4 System Menu



Click System Menu button  to set:

Temperature scale mode,







Measurement parameters,

Image mode,

ROI,



Palette,

Settings.

1.  Temperature scale mode: auto-scale, manual scale, touch scale.
2.  Measurement parameters: emissivity, reflection temperature, ambient temperature, relative humidity, temperature measurement distance, IR window compensation.
3.  Image mode: thermal image, digital camera image, picture-in-picture, thermal& digital image fusion mode settings.
4.  ROI temperature measurement tools: points, rectangles, circles, lines, etc., settings for sound alarm, temperature rise, delete, display settings for temperature measurement masks.
5.  Palette: Iron、Grey、Rainbow、Rain、Medical、GreyRed, etc.
above the alarm temperature, below the alarm temperature, the interval alarm temperature.
6.  Settings: capture mode, Connection, temperature measurement range, storage and save options, device set.

4.5 Temperature Scale Mode



The thermal imager supports  auto scale,  manual scale and  touch scale modes.

4.5.1 Auto Scale Mode

 In Auto Scale Mode, the upper and lower temperature scale limits are automatically adjusted to achieve the best image color display effect according to the histogram of overall temperature distribution. On the right side of the screen, it displays the temperature scale with the max and min temperature values, which are also calculated according to the Histogram.

4.5.2 Manual Scale Mode

 In Manual Scale Mode, the upper and lower limits of temperature scale limits can be set manually. The manual scale has two span options, which can be set in "Settings- Device Set- manual mode"

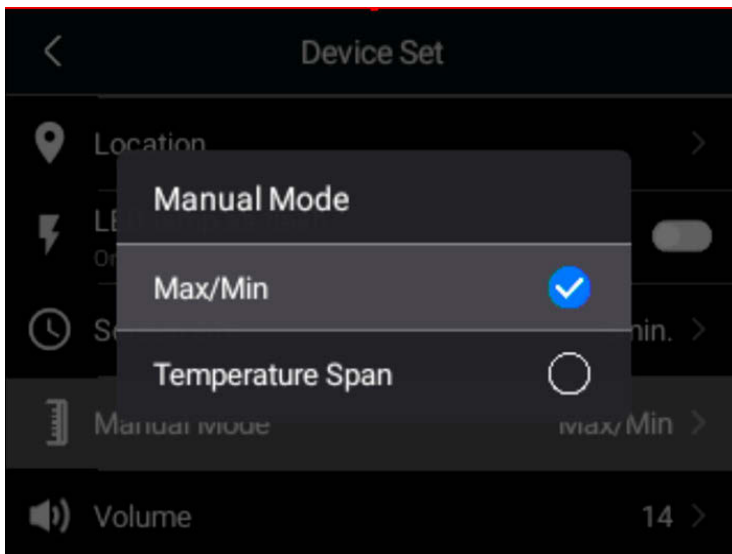

4.5.2.1 Max / Min Mode

In Maximum/Minimum mode, the upper and lower limits of the temperature scale can be adjusted.

1. After selecting the MAX/MIN manual temperature scale mode, the upper and lower limits of the temperature scale can be selected. And the grey icon represents the selected state.

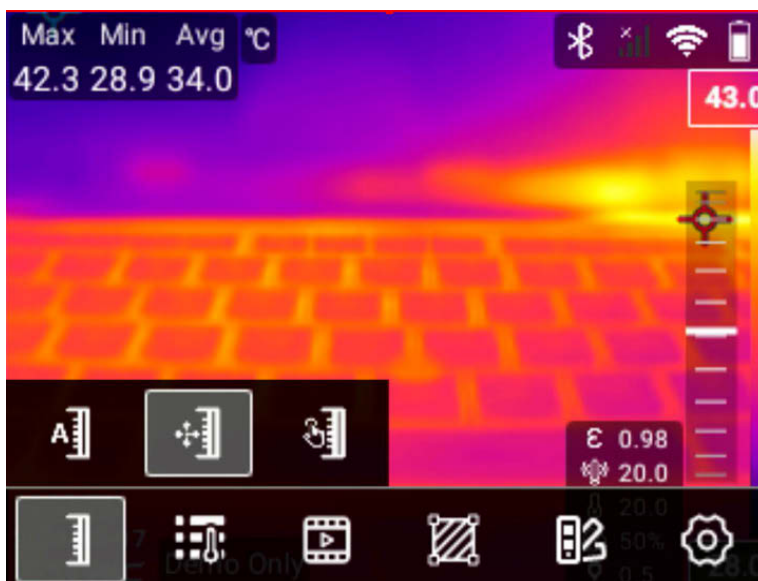

2. The upper and lower limits of the temperature scale in the selected state can

be adjusted by using the slider or pressing the up and down direction keys.
As shown in the figure below, the upper and lower limits of the temperature scale can be adjusted at the same time by using the slider:



As shown in the figure below, the lower limit of the temperature scale can be adjusted separately by using the slider



As shown in the figure below, the upper limit of the temperature scale can be adjusted separately by using the slider:



As shown in the figure below, both upper and lower limits of the temperature scale are locked and cannot be adjusted:



Users can adjust the upper or lower limit by pressing the left and right direction keys. The selected limit is displayed in gray.

As shown in the image below, the upper limit is selected.

And the upper limit of temperature scale can be adjusted by up and down

direction key

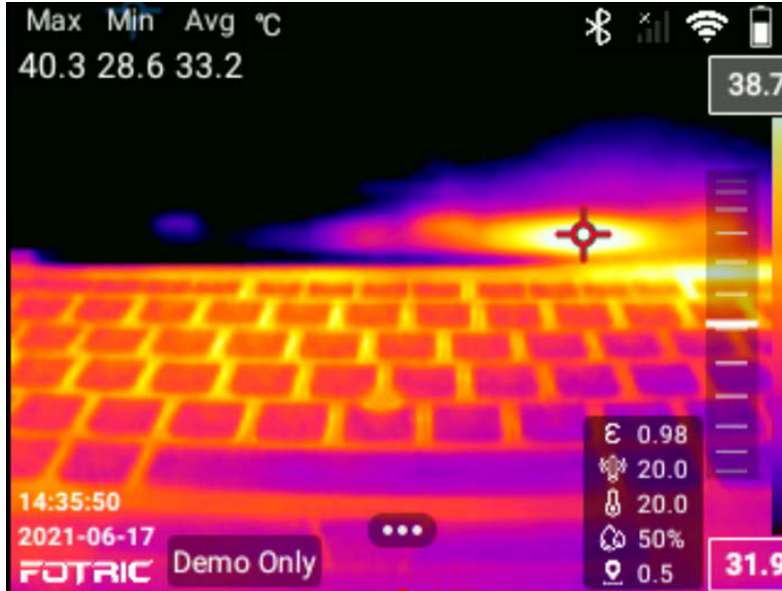

As shown in the image below, the lower limit is selected. And the lower limit of the temperature scale can be adjusted by up and down direction key



As shown in the image below, the upper and lower limits are selected. And the range of temperature scale can be adjusted by up and down direction key



A short press on the direction key will increment the span by 0.1 degree. When held on, the increment will gradually increase

4.5.2.2 Temperature span mode

In temperature span mode, the temperature scale span (difference between upper and lower limits) value can be adjusted independently.

The upper and lower limits of the temperature scale can only be adjusted at the same time, not separately. As shown below:

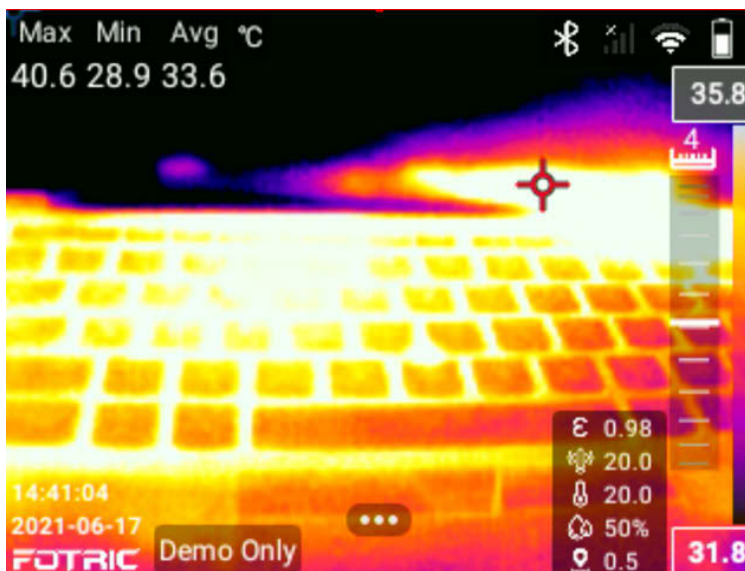

- Scroll or press the up/down direction key to simultaneously adjust temperature upper and lower limit
- Temperature scale span can be adjusted by pressing the left/right direction key

4.5.1 Touch scale mode

 In Touch scale mode, the upper and lower temperature scale limits can be adjusted automatically by touching the screen based on temperature range of the touch area (about 10 x 10 pixels in size).

Touch scale mode has two options like manual scale mode.

1. In Maximum/Minimum value mode, the temperature scale can be adjusted by selecting the upper and lower limits of the temperature scale. (If the gray base is selected, refer to manual mode).
2. In Temperature span mode, the upper and lower limits of the temperature scale can only be adjusted at the same time, not separately. Press the left and right direction keys to adjust the temperature scale range

!Note: aside from touching the screen, the scale can also be changed by pressing buttons and scrolling on the screen. For more specific instructions, please see the manual scale mode.

4.6 Measurement Parameter Settings

 is the temperature parameter set button, which can be used to adjust the temperature parameters of the thermal imager. For accurate measurement, it is important to set the measurement parameters.

The adjusted parameters are saved and loaded in the system, whenever the device reboots. If you need to reset the temperature measurement parameters, you can refer to the "recommended values" or reset to the factory defaults.

! Note: There is usually no need to change the default measurement parameters. Please make necessary adjustments according to practical needs. The parameters will directly affect temperature measurement results.



4.6.1 Setting Emissivity

Emissivity is the rate of the measured object's outward radiation energy to a black body's, at the same temperature and wavelength. The value is between 0 and 1.0

! Note: Emissivity is one of the most important parameters for accurate temperature measurement

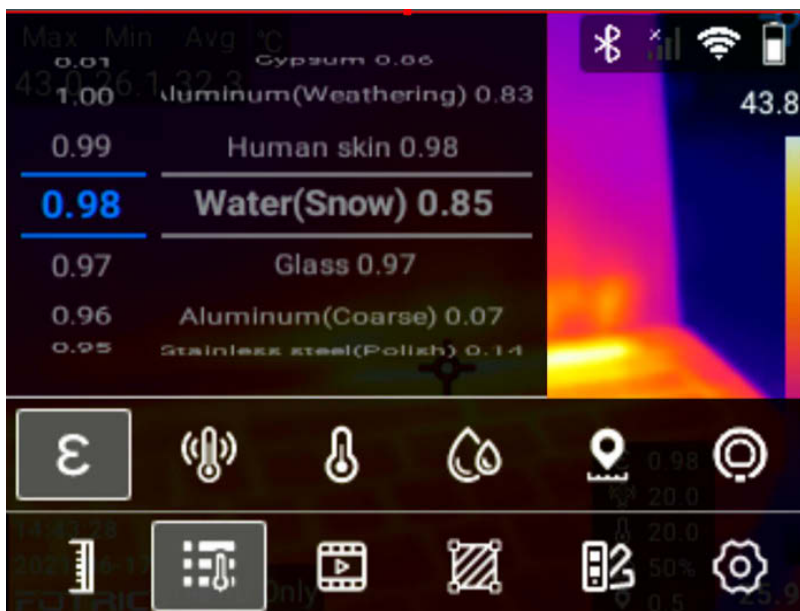

ε The emissivity settings of the FOTRIC thermal imager have 2 options: Fullscreen emissivity correction and partial emissivity correction.

To set full-screen emissivity, please perform the following procedures:

1. Click the emissivity set button.
2. Slide up and down to set the emissivity value (0.01 – 1.0), or choose the material type.
3. If the type of the material is not found on the table, please refer to the material Emissivity Table at the end of this manual. If the material type is not in the material emissivity table or unknown, please contact Fotric for professional support.
4. Click on other areas of the thermal image screen, or click the back button to complete the setting.

!Note: For partial emissivity, please refer to ROI partial emissivity setting.

4.6.2 Setting Reflected Temperature

The reflected temperature set compensates for the radiation from the surroundings reflected by the measured object. Range:(-40 to700 Celsius)

If the target's emissivity is low and the ambient temperature is much lower than the target's reflected light source, it becomes important to correctly set this parameter for accurate temperature measurement.

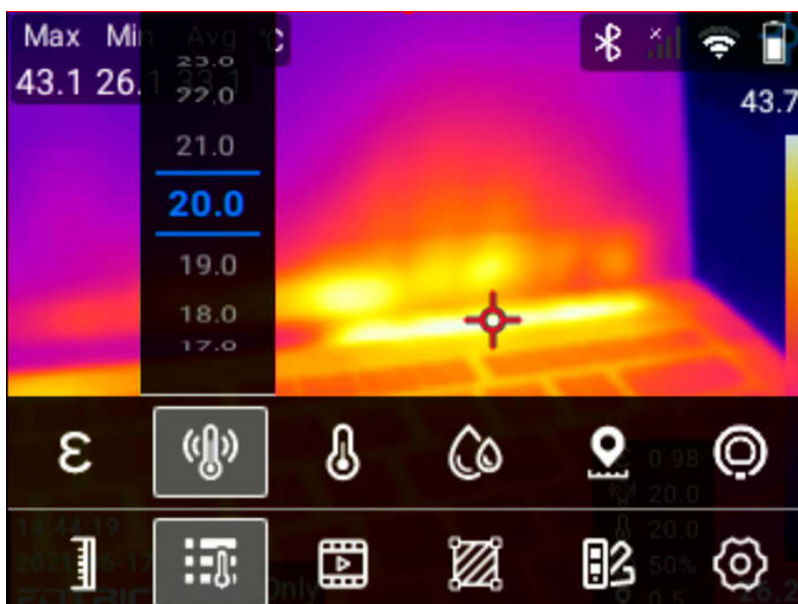

-  To set the reflection temperature, please follow the following procedures:
1. Measure the actual temperature of the reflection source near the target with a thermal imager.
 2. Click the reflected temperature set button.
 3. Slide up and down to set the reflection temperature value as the result measured by the thermal imager.
 4. Click on other areas of the thermal image screen, or click the back button to complete the settings.

!Note: Try to avoid reflection interference if possible. It can greatly improve measurement accuracy

4.6.3 Setting Ambient Temperature

Ambient temperature is the air temperature between the measured object and the Lens of the thermal imager. Available setting range: -20~70 Celsius



-  To set the ambient temperature, please perform the following procedures:
1. Click the ambient temperature set button.
 2. Slide up and down to set the ambient temperature value.
 3. Click on other areas of the thermal image screen, or click the back button to complete the setting.

!Note: The ambient temperature value is set by default in the system. This parameter should be set only if the ambient temperature is higher than that of the measured object.

4.6.4 Setting Relative humidity

Relative humidity set is used to compensate for the thermal radiation by atmosphere moisture between the measured object and the Lens of the thermal imager. Therefore, when the measured target is far, it is important to set the appropriate value for this parameter.

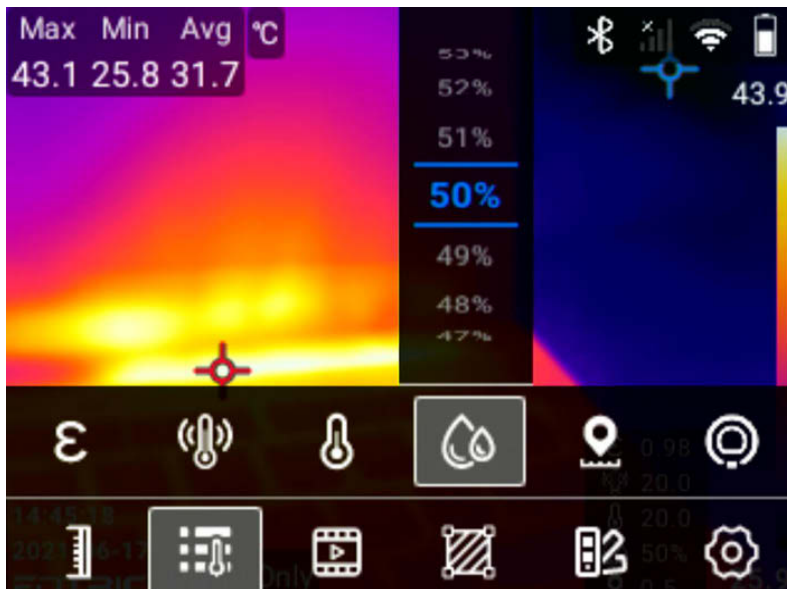

To set the relative humidity, please perform the following procedures:

1. Click the relative humidity set button.
2. Slide up and down to set the relative humidity value.
3. Click on other areas of the thermal image screen, or click the back button to complete setting.

! Note: For short distances and under normal humidity conditions, the default RH value of the thermal imager is usually okay.

4.6.5 Setting Measurement Distance

Measurement distance is the distance between the measured object and the lens of the thermal imager. The value is between 0.5 ~ 100 meters. This parameter is used to compensate for the following two elements:

- the thermal radiation, which the atmosphere air absorb between the object and the thermal imager lens.
- the thermal radiation from the atmosphere air itself.

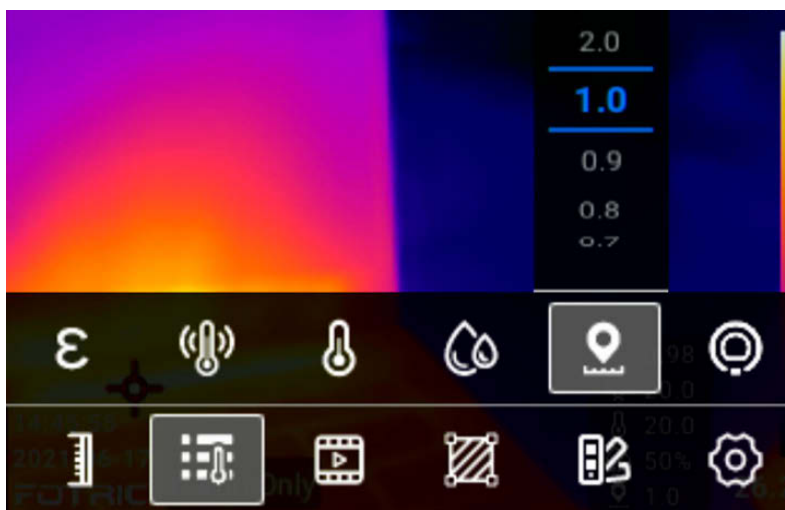

To set the measurement distance, please perform the following procedures:

1. Click the measure distance set button.
2. According to the actual distance between the measured target and the infrared thermal imager lens, slide the distance value on the screen up and down, and set the distance value to the actual value.
3. Click on other areas of the thermal image screen, or click the back button to complete the setting.

4.6.6 Setting IR Window Compensation

IR window compensation compensates for the transmittance and temperature of the external optics between the measured object and the lens of the thermal imager. External optics' temperature range: (-40-700 Celsius); Transmittance range:(0.01-1.00).

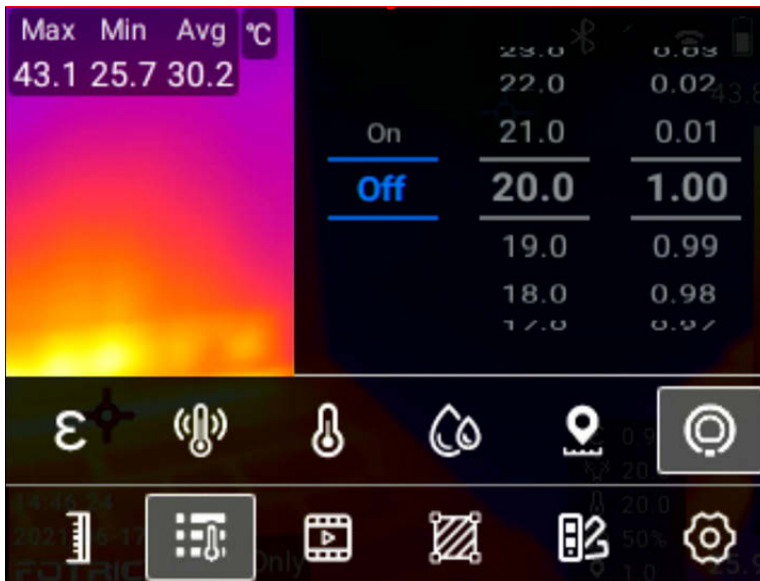

 To set the IR window compensation, please perform the following procedures:

1. Measure the actual transmittance of the external lens or external infrared window (usually tested by the FOTRIC after-sales service department or by a qualified partner licensed, with standard measurement master for precise test).
2. Click the IR window compensation set button.
3. Slide up and down to select the temperature of the external optical window/lens.
4. Slide up and down (0.01 – 1.0) and set the transmittance value.
5. Click on other areas of the thermal image screen, or click the back button to complete IR window compensation setting.

! Note: If the selected external optical lens has been calibrated at the factory, or there is no external infrared window, the IR window compensation is usually set to off.

4.6.7 Recommended Values

Under normal operation, the followings are the recommended values:

Emissivity	0.95
Reflected temperature	20°C
Ambient temperature	20°C
Relative humidity	50%
Distance from target	1.0 m
IR window compensation	off

4.7 Image mode

Image modes includes thermal image, visible light image, PIP and image fusion mode.

Click the  icon, the submenu for image mode will pop up

4.7.1 Thermal image mode

 Displays infrared thermal image.

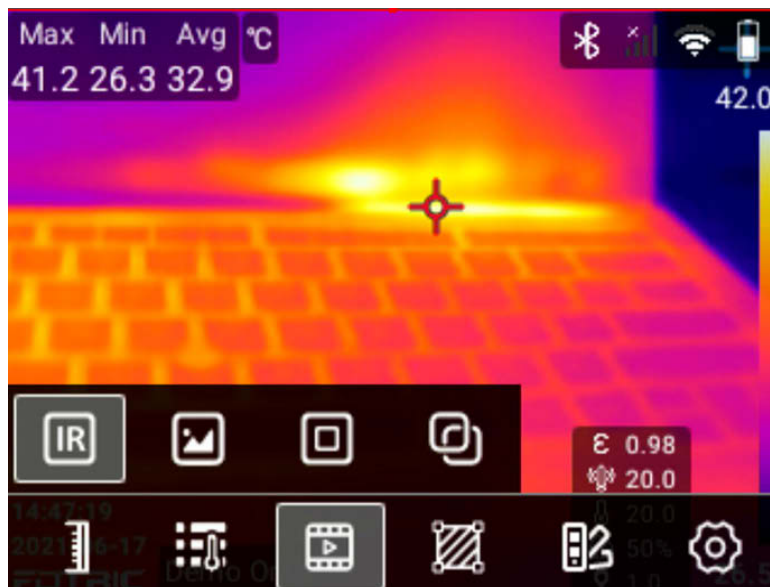

- It is the default mode when turn on the thermal camera.
- When no ROI is added, the 'measurement result' bar will display the maximum and minimum temperature of the entire screen, and there will be two cursors indicating their position.

In the setting, users can choose to display max, min, and average temperature. The default is displaying both max and min.

- After ROIs are added, the 'measurement result' bar will no longer display the temperature of the entire screen

! Note: under thermal image mode, please make sure the image is properly focused. If the image is out of focus, it will affect both image quality and the accuracy of temperature measurement.

4.7.2 Digital camera mode



Displays visual light digital camera image.

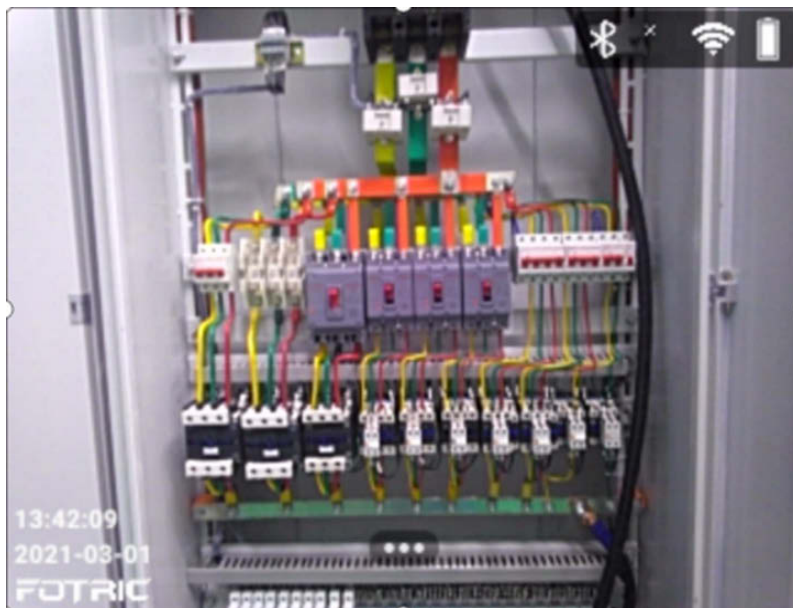

Under digital camera mode, the following functions are not available:

Temperature scale;

Measurement parameters;

ROI;

Palettes;

4.7.3 Picture in picture (PIP)

 Displays Infrared thermal image superimposed on the visual light digital image.



By default, the thermal display area is 1/4 of the entire screen. Users can adjust the thermal image areas and position by touch-screen, as the below following images:

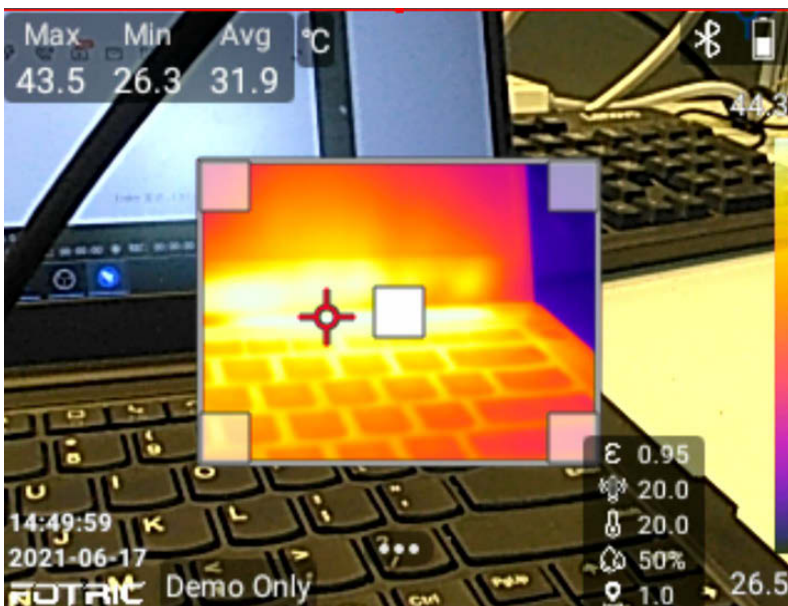

1. Resize the PIP: Click and drag on the corner of the thermal image

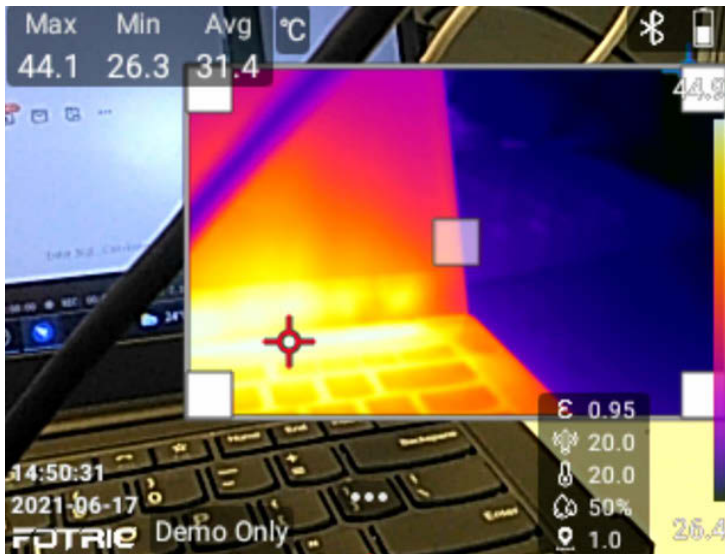

2. Reposition: Click and drag on the center of the thermal image

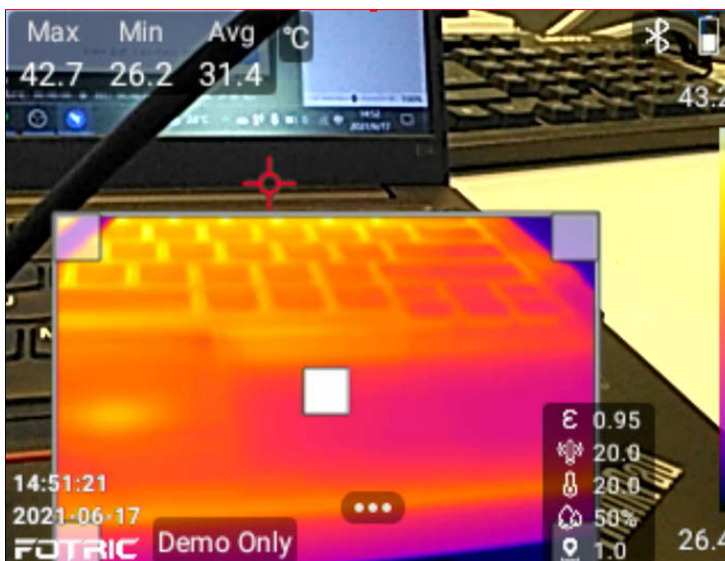

3. When specific ROI is selected, 'Resize' and 'reposition' mode can alternate by pressing the 'OK' button. Pressing the 'Return' button can exit editing mode.

4. After reboot, the size and position of the PIP window will return to default(in the middle and ¼ size).

! Note: In Picture-in-Picture Mode, please make sure the infrared thermal

imager is properly focused. If the infrared thermal image is not in focus, the temperature measurement may not be accurate, and the visual light image will not match the thermal image.

4.7.4 Image Fusion Mode



Thermal & Visual light Image Fusion Mode: Fusion of thermal image and visual light digital camera image to enhance the display of image visible contrasts.



- In image fusion mode, by default, a transparency scroll will appear, as shown below

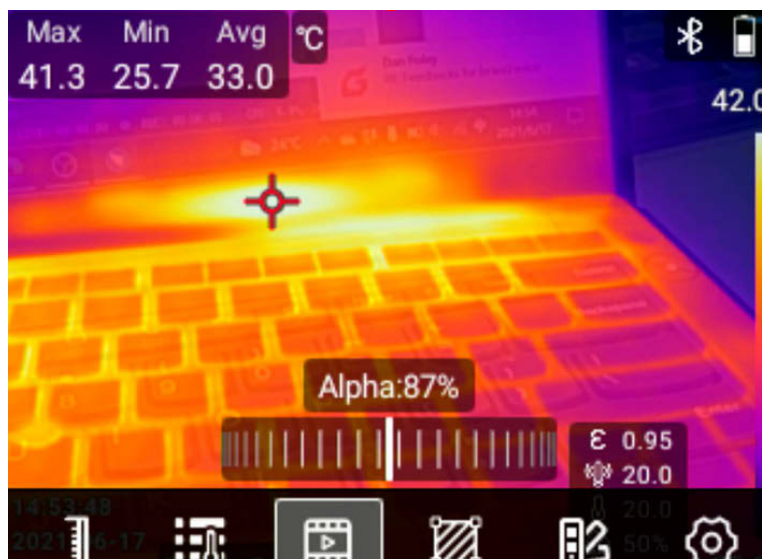

- Adjusting transparency

1. Transparency ranges from 0% to 100%, minimal increment being 1%
2. Press the 'OK' button or touch screen on the menu interface, to hide the menu and display the scrolling wheel; while the transparency percentage is still visible on the screen. Press the 'OK' again or the 'Return' button to hide the scrolling wheel.
3. When the transparency scrolling wheel is on screen, users can adjust its percentage by swiping on the wheel or pressing the left/right direction button.

! Note: In image fusion Mode, please ensure the accurate focus of the thermal imager. If the infrared thermal image is not in focus, the temperature measurement may not be accurate, and the visual light image will not match the thermal image.

4.8 ROI measurement tools



Click the ROI measurement tool button to enter its sub-menu. ROI is the abbreviation for Region of Interest. ROI can be set up as circular, rectangular, line, and point measurement areas.





Click to add a movable measurement point.



Click to add a movable rectangle measurement area.



Click to set the temperature rise between the ROI and a reference temperature value, or the temperature difference between the temperature measurement ROIs.



Click to clear all ROIs.



Display settings button for ROIs.



Click to display more function buttons.



Click to add a movable measurement line.



Click to add a movable circle measurement area.



Click to select the ROIs.

- ROI is the abbreviation for 'Region of Interest'
- ROI could be rectangle, circle, line, or spot.
- 'Ci' represents circle ROI; 'Ar' represents Area/Rectangle ROI
- 'Li' represents line ROI, 'Sp' represents spot ROI
- ROI can be added through touch-screen or on-button operation. To add ROI, please follow the instructions below:

1. Touch-screen operation

1. Click on the screen to display the main menu
2. Click  and display the ROI submenu
3. Select one among spot, line, rectangle, circle ROI, and it will appear on the center of the screen

2. On-button operation

1. Press the 'OK' button and display the main menu
2. Press the direction keys to select the  and display the main menu
3. Select the desired ROI form by pressing the left/right direction key. Press 'OK' to add it to the center of the screen

4.8.2 ROI Selection/Cancel Selection



ROI can be selected through touch-screen or on-button operation. To select ROI, please follow the instructions below:

1. Touch-screen operation

- 1) Click on the spot, line's middle/two ends, rectangle's four corners and center to select the current ROI
- 2) 。 Clicking on a region outside of the ROI to cancel the selection

2. On-Panel operation





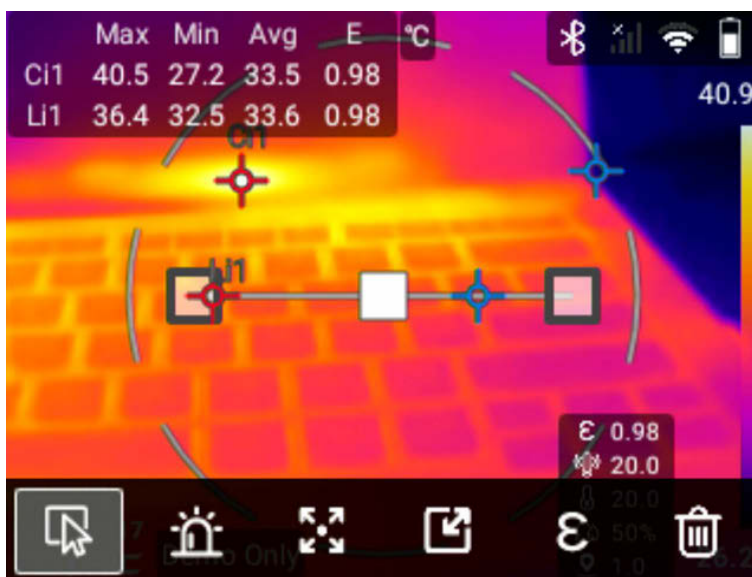

- 1) choose the ROI with click on 'OK' and direction keys.

- 2) Press on direction keys to select ROIs
- 3) Press on the 'back' key consecutively to exit menus when the selection is made.
- 4) Press on the 'Back' key to undo selection of ROI

4.8.3 Adjusting ROI



It is possible to move, resize ROI and adjust their emissivity if needed

-  Click to select ROI.
-  Click to set the sound/silent alarm.
-  Click to move the ROI position.
-  Click to resize the ROI area.
-  Click to set ROI partition emissivity.
-  Click to delete selected ROI.

You can move the ROIs by touch-screen or On-panel operations. To move the selected ROIs, please follow the procedures as below:

1. Touch-screen operation

- 1) Following the instruction of 4.8.1, select the desired ROI
- 2) Drag the ROI with your finger and move it to the position. For points, you can drag them directly; For line/rectangle/circle, press and drag on the central point.

2. On-panel operation

- 1) Following the instruction of 4.8.1, select the desired ROI
- 2) Move the ROI by pressing direction keys. For each press, the ROI will move a pixel.
- 3) Long-press direction key will enable continuous movement, but the step length will not increase.

ROI's size is editable by touch-screen and On-panel operation. To move the selected ROIs, please follow the procedures as below:

1. touch-screen operation

- 1) Following the instruction of 4.8.1, select the desired ROI
- 2) Press the corner of ROI and drag your finger. The ROI's size will change according to your movement.

- Point: Do not support resizing
- Line: drag the endpoints
- Rectangle、 circle: drag on the corners

2. On-panel operation

- 1) Following the instruction of 4.8.1, select the desired ROI
- 2) Press on Left and right direction keys, to change the width of ROI (length for line, point N/A)

- 3) Press on Up and down direction keys, to change the height of ROI
- 4) Long-press on direction keys, to change continuously.

4.8.4 Deleting ROI

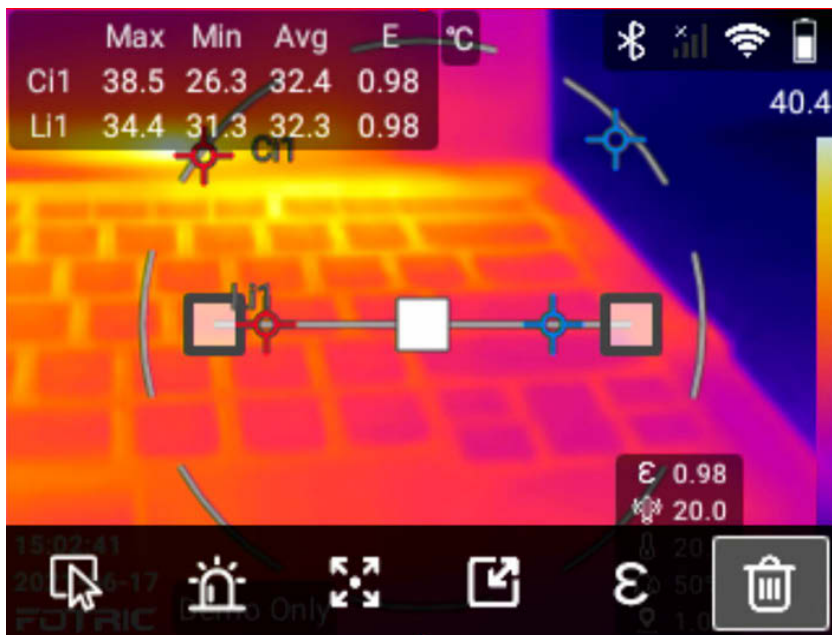

There are two ways of delete ROI: delete the selected one, and clear all

Delete selected ROI



Users can delete ROI by touch-screen and On-panel operation. To delete the selected ROIs, please follow the procedures as below:

1.Touch-screen operation

- 1) Following the instruction of 4.8.1, select the ROI you want to delete (ex. Ci1)
- 2) Click the menu button , and the deleting ROI  icon will appear

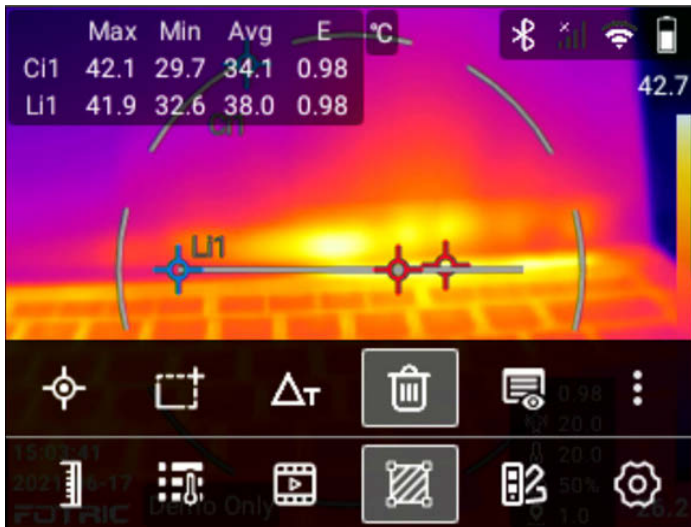

3) Click the icon , and the selected ROI(ex. Ci1) will be deleted

4) The selected ROI has been deleted successfully.

2. On-panel operation

1) Following the instruction of 4.8.1, select the ROI you want to delete (ex. Ci1)

2) Press the 'OK' button, the deleting ROI  icon will appear.

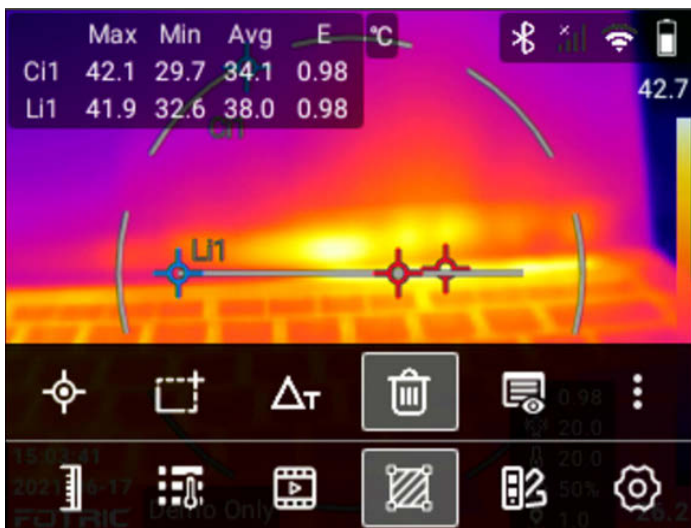



3) Selecting the 'Delete' icon by pressing the left/right direction key, then press 'OK' to delete

4) The selected ROI has been deleted.

ROI Clear all ROIs

The 'Clear all ROIs' feature is available through touch-screen and press-button. To clear all the ROIs, please follow the procedures as below:

1. Touch-screen operation

1. Click the system menu button .
2. Click the ROI measurement tool button .
3. Click the Clear ROI button to clear all ROI information on the screen, as the following image indicates.



2. On-Panel operation

- 1) Press the 'OK' button, the 'Clear-all-ROIs'  icon will appear.
- 2) Select the clear ROIs icon by pressing the left/right direction key, then press 'OK' to clear all the ROIs on the screen

3) All ROIs have been cleared successfully.



4.8.5 Setting ROI Partial Emissivity

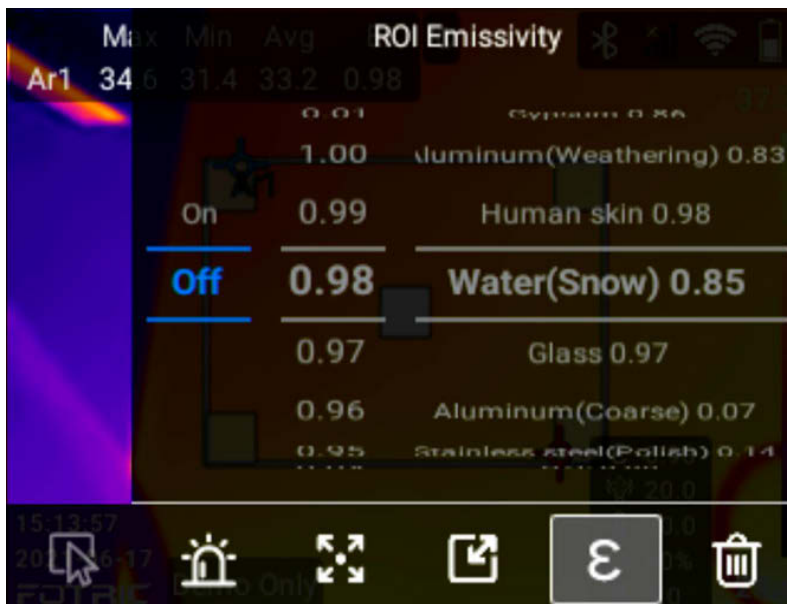

E ROI Partial Emissivity Set button



For the emissivity of material that is not included in the chart, you may find it in the emissivity table at the end of this manual.

The 'Partial emissivity setting' feature is available through touch-screen and press-button. If you need to set specific emissivity for different ROIs, please follow the procedures as below:

1. touch-screen operation

- 1) Click on the ROI you want to set emissivity on
- 2) Click '' on the bottom of the screen, the emissivity button '' will appear.

Click to display the emissivity interface:

On the left side is 'on/off';

On middle, is the emissivity customizing page, the value ranging from 0.01 to 1.0;

On the right side is the emissivity material table.

- 3) Click on the left side to turn it on
- 4) If the emissivity of the material is known, you can set it by scrolling in the middle section of the screen
- 5) You can also find the matching material by scrolling on the right side of the screen
- 6) After setting the ROI partial emissivity, click on the blank part on the screen and finalize the setting.

2. On-Panel Operation

- 1) Click on the ROI you want to set emissivity on
- 2) Click the 'OK' button, then the emissivity button '' will appear.

Click to display the emissivity interface:

On the left side is 'on/off';

On middle, is the emissivity customizing page, the value ranging from 0.01 to 1.0;

On the right side is the emissivity material table.

- 3) Select the left side of the interface using direction key to turn it on
- 4) Use left/right direction keys to get to the middle lane of the interface, then using up/down direction keys to select the right emissivity.
- 5) Use left/right direction keys to get to the right lane of the interface, then use up/down direction keys to select the matching material.
- 6) After setting the ROI partial emissivity, press the 'return' key to complete the setting.

4.8.6 Setting ROI Display

 is the ROI display setting button.



The available options for display are maximum, minimum, average temperature and emissivity. The default display is the maximum temperature.

The 'ROI display setting' feature is available through touch-screen and press-

button. If you need to set specific displaying content, please follow the procedures as below:

1. touch-screen operation

1) Click '...' on the bottom of the screen, to display the emissivity display icon '☰'.

2) Click to set features display or hide. After the display setting, click on other areas of the screen to complete the setting.

2. On-panel operation

1) Press the 'OK' button, to display the emissivity display icon "☰".

2) Selecting the display options by pressing the up/down direction key, then press 'OK' to display/hide the selected feature. After the display setting, press on 'back' button on the screen to complete the setting.

4.8.7 Temperature Rise Calculation

 This icon is for temperature rise calculation.

The temperature rise feature chooses a reference value, and all temperature display values on the screen will be the difference between the actual temperature and the reference value;

The reference value could be any ROI's maximum, minimum and average value. Alternatively, users can set up a fixed temperature value for reference.

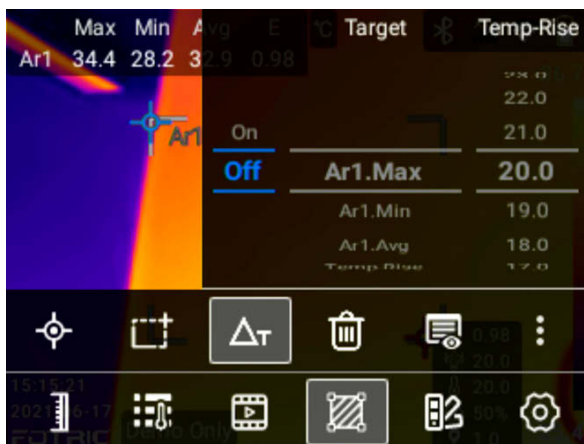

1. Calculating temperature difference between ROIs.

If the reference target is set to: "minimum of Ar1", then all the temperature display values on the screen will be the actual temperature minus the minimum temperature on Ar1.

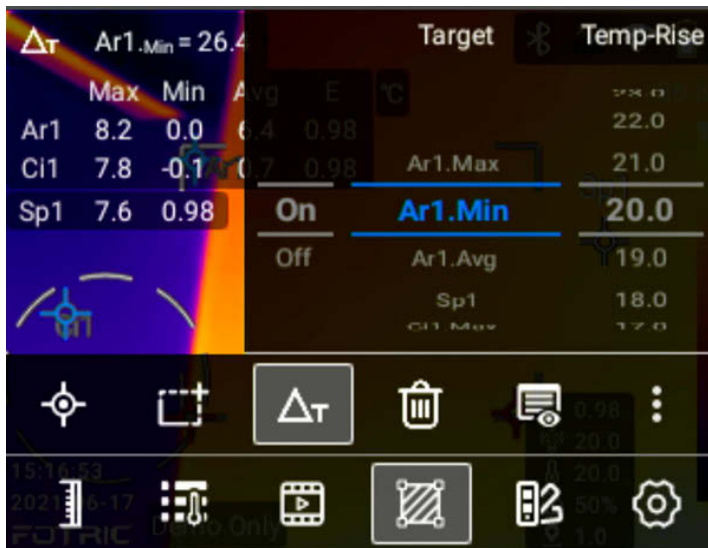

2. Temp-rise: Calculating temperature difference between all ROIs and a fixed value.

if you want to lower all temperature display values by 20 °C , you can set the 'Temp-rise' value to 20. This function can effectively eliminate environmental interference.

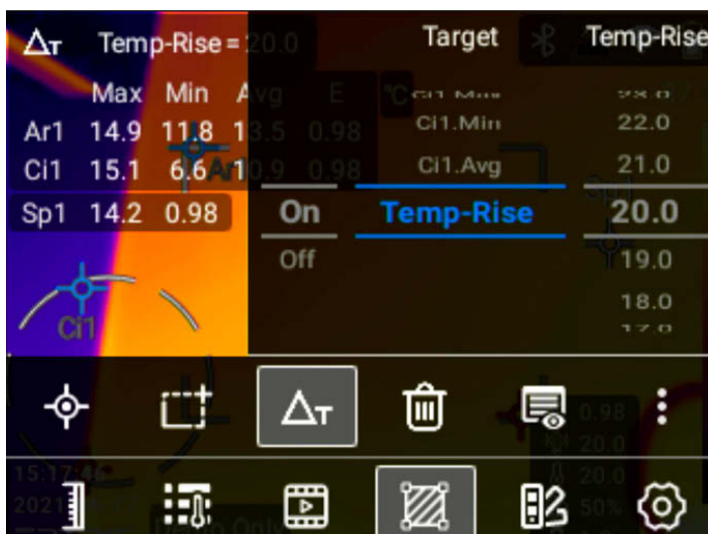

The 'Temperature difference' feature is available through touch-screen and press-button. If you need to activate 'Temperature difference', please perform the following procedures:

1. Touch-screen operation

1) Click on the system menu button , then the temperature rise  button will appear.

Click to display the temperature rise interface:

On the left side is 'on/off';

On the middle is the reference target;

On the right side is reference temperature values.

2) Click on the left side of the interface to turn it on. In the middle of the interface, you can set the correct target by scrolling.

3) If the reference temperature is a constant value, users can scroll up and down to adjust the reference temp on the right side of the temp-rise interface.

4) After ROI temp-rise set, click on the blank area on the screen to finalize the setting

2. On-panel operation

1) Click the 'OK' button, then the emissivity button  will appear. Clicking on that will display the temp-difference interface:

the left side is 'on/off';

the middle lane is the reference target;

The right side is the reference temperature.

2) Use left/right direction keys to get to the middle lane of the interface, then using the up/down direction key to select the ROIs.

3) To set reference temperature, use left/right direction keys to get to the right lane of the interface, then use up/down direction keys to select the right target temperature.

4) After ROI temp rise set, press on the 'return' button to complete the setting.

4.9 Setting Sound Alarm



This is the icon for sound alarm.

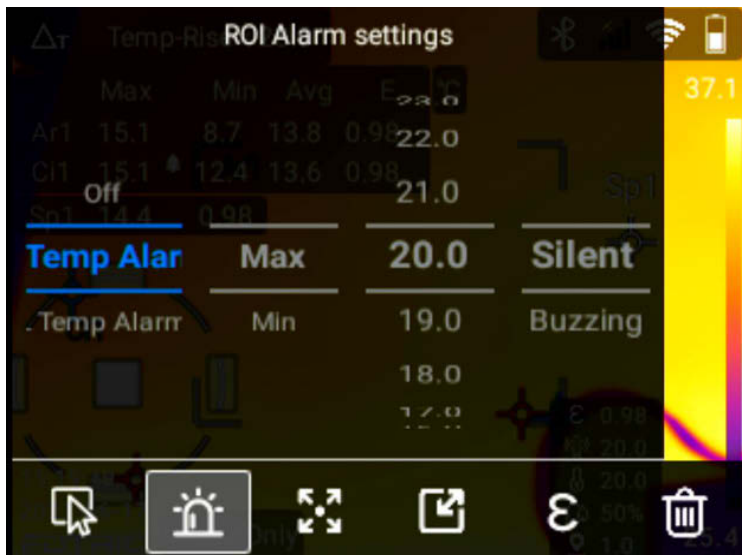

Alarm off: no alarm icon on the screen.

The alarm is activated but not triggered: the alarm icon is white and not blinking;
No special color on temperature values; No alarm sound.

High-temperature alarm: When the detected temperature is higher than the preset high-temperature threshold, the temperature value will turn red, and a sharp rapid beep sound can be set triggered to alert.

Low-temperature alarm: When the detected temperature is lower than the preset low-temperature threshold, the temperature value will turn blue, and a sharp and intermittent beep sound can be set triggered to alert.

Highest temperature: alarm will trigger for the maximum temperature of ROI ;

Lowest temperature: alarm will trigger for the minimum temperature of ROI ;

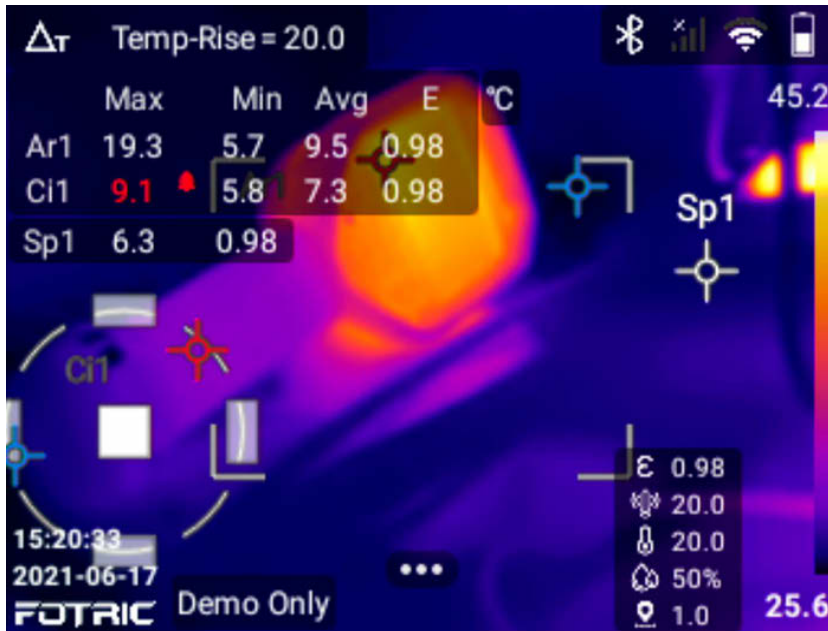

The 'sound alarm' feature is available through touch-screen and press-button. If you need to set up sound alarms, please follow the procedures as below:

touch-screen operation

- 1) Select the alarm area; (different alarms can be set for different ROIs).
- 2) Click  button at the bottom of the screen and select the sound alarm button. Open the sound alarm interface: left lane displays options: Turn off/high-temperature alarm/low-temperature alarm; On second lane you can choose your interested attribute: maximum temperature/minimum temperature of the region; The third lane displays threshold for triggering alarm; The Right lane displays sound effect options for when the alarm is triggered: silence/buzzing
- 3) Choose high-temperature alarm or low-temperature alarm based on your need
- 4) Set maximum or minimum temperature in the region.
- 5) In the temperature alarm bar on the screen, slide up and down to adjust the temperature threshold.

6) Click on the other areas of the screen to complete the sound alarms setting;

2. On-panel operation

- 1) Select the alarm area; (different alarms can be set for different ROIs).
- 2) Press the 'OK' button to select the sound alarm button. Open the sound alarm interface: left lane displays options: Turn off/high-temperature alarm/low-temperature alarm; On second lane you can choose your interested attribute: maximum temperature/minimum temperature of the region; The third lane displays threshold for triggering alarm; Right lane displays sound effect options for when the alarm is triggered: silence/buzzing
- 3) Use up/down direction keys to select high/low-temperature alarm in the left lane of the interface
- 4) Use left/right direction keys to switch to the second lane of sound alarm interface, and use up/down direction keys to select max/min temperature of ROI
- 5) Use left/right direction keys to switch to the third lane of the sound alarm interface, and use up/down direction keys to select the appropriate threshold.
- 6) Press the 'back' button to complete the settings.

4.10 Palette

Click the palette set button  and enter the palettes sub-menu. You can select the palette and set the color alarm (isotherm).

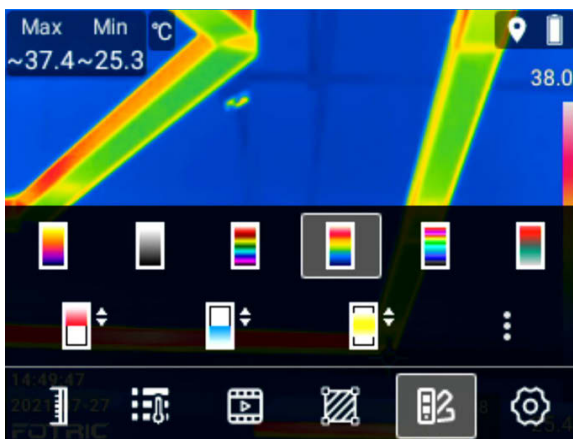

 Iron Palette.

 Grey Palette.

 Rainbow Palette.

 Rain Palette.

 Medical palette

 GreyRed palette

 color alarm (isotherm): above temperature alarm, for quickly finding the high temperature abnormal area of target object.

 color alarm (isotherm): below temperature alarm, for quickly finding the low-temperature abnormal area of the target object.

 color alarm (isotherm) interval temperature alarm, for quickly finding the temperature abnormal area of the target object.

 : This button reveals more palette options, as shown below:

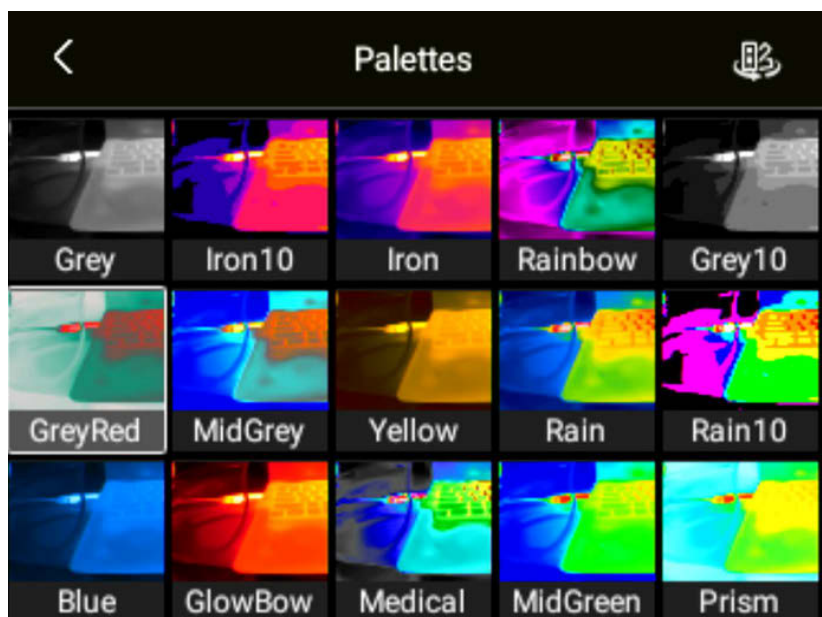

 Click to invert the color for all palettes.

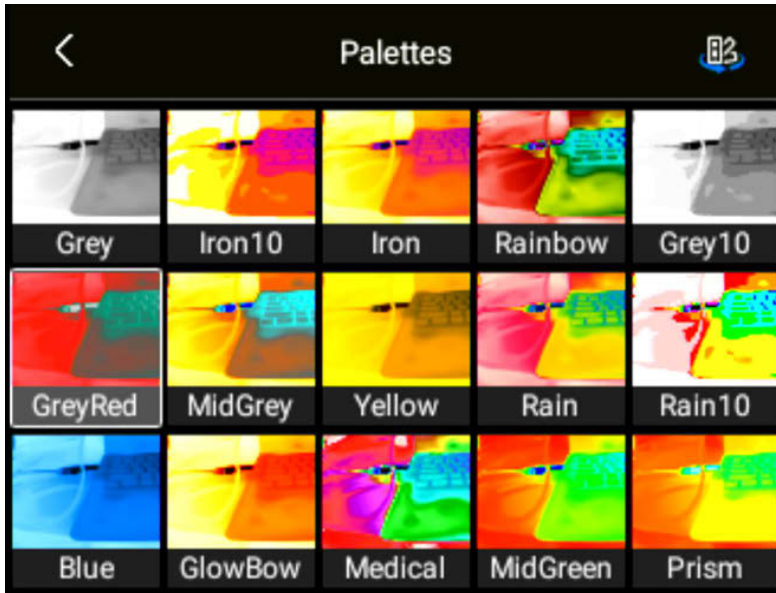

4.11 Color alarm(isotherms)

Color Alarms (Isotherms) are used for rapid screening of temperature anomalies. This thermal imager supports three kinds of isotherms: above temperature, below temperature, and interval (in-between) temperatures.



 color alarm (isotherm): above temperature alarm, for quickly finding the high-temperature abnormal area of the target object.

 color alarm (isotherm) below temperature alarm, for quickly finding the low-temperature abnormal area of the target object.

 color alarm (isotherm) interval temperature alarm, for quickly finding the temperature abnormal area of the target object.

4.11.1 High-temperature color alarm

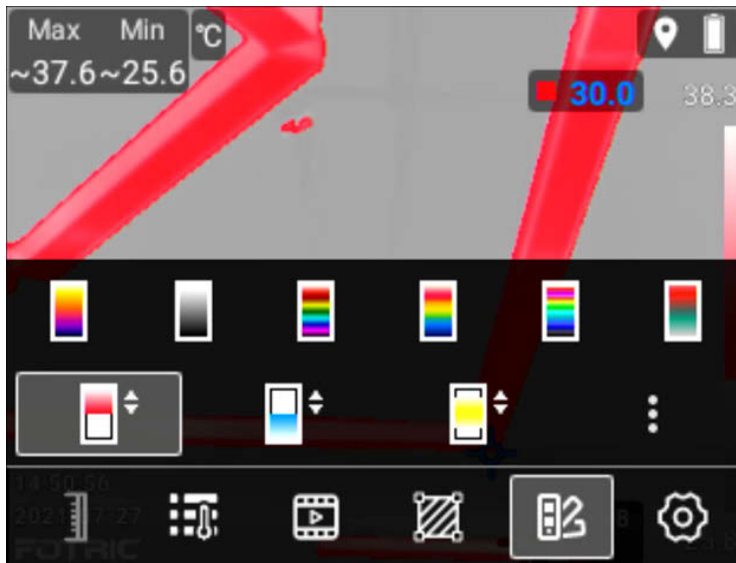

Choose  for 'above-temperature' color alarm

1. The temperature areas that exceed a certain threshold are displayed with red color, emphasizing regions that are hotter than the set threshold. Under this palette, temperature scale change mode is not available.
2. The value in the upper right corner indicates the current alarming threshold. The alarm area is adjustable by touching the screen (which will turn it blue) and by pressing up and down keys. The overall image areas display will change according to the dynamic palette on the right side.
3. Touch the number icon's value on the top-right corner to turn it blue, and press up or lower direction keys to adjust temperature values. Pressing left or right direction keys/touching on the other part of the screen/pressing 'return' key to turn it white. After turning white, pressing on the up/down direction keys cannot adjust the value.

4.11.2 Low-temperature alarm

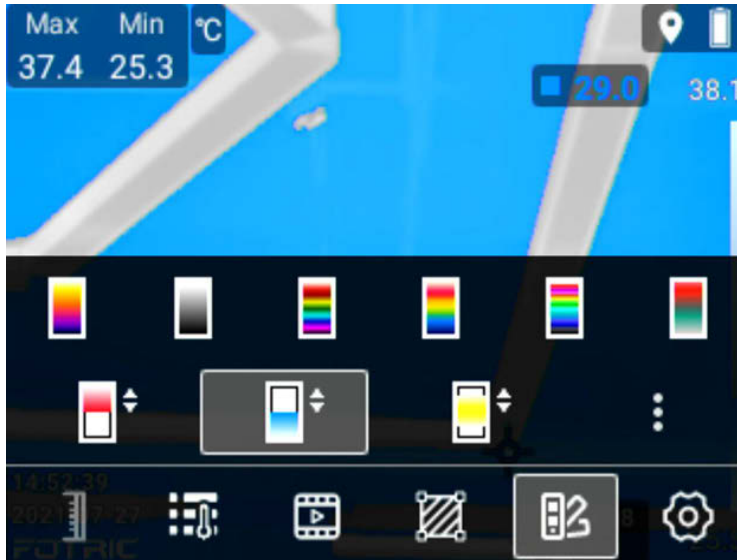

Choose  for 'below-temperature' color alarm

1. The temperature areas that exceed a certain threshold are displayed with blue color, emphasizing regions that are colder than the set threshold. Under this palette, temperature scale change mode is not available.
2. The value in the upper right corner indicates the current alarming threshold. The alarm area is adjustable by touching the screen (which will turn it blue) and by pressing up and down keys. The overall image areas display will change according to the dynamic palette on the right side.
3. Touch the number icon's value on the top-right corner to turn it blue, and press up or lower direction keys to adjust temperature values.
 - o Pressing left or right direction keys/touching on the other part of the screen/pressing 'return' key to turn it white. After turning white, pressing on the up/down direction keys cannot adjust the value.

4.11.3 Interval-temperature alarm



Choose "  " for 'interval-temperature' color alarm

1. The temperature areas that exceed a certain threshold are displayed with yellow color, emphasizing regions that are between set thresholds. Under this palette, temperature scale change mode is not available.
2. The value in the upper right corner indicates the current alarming threshold. The alarm area is adjustable by touching the screen (which will turn it blue) and by pressing up and down keys. The overall image areas display will change according to the dynamic palette on the right side.
3. Touch the number icon's value on the top-right corner to turn it blue, and press up or lower direction keys to adjust temperature values. Pressing left or right direction keys/touching on the other part of the screen/pressing 'return' key to turn it white. After turning white, pressing on the up/down direction keys cannot adjust the value.

4.11.4 System settings

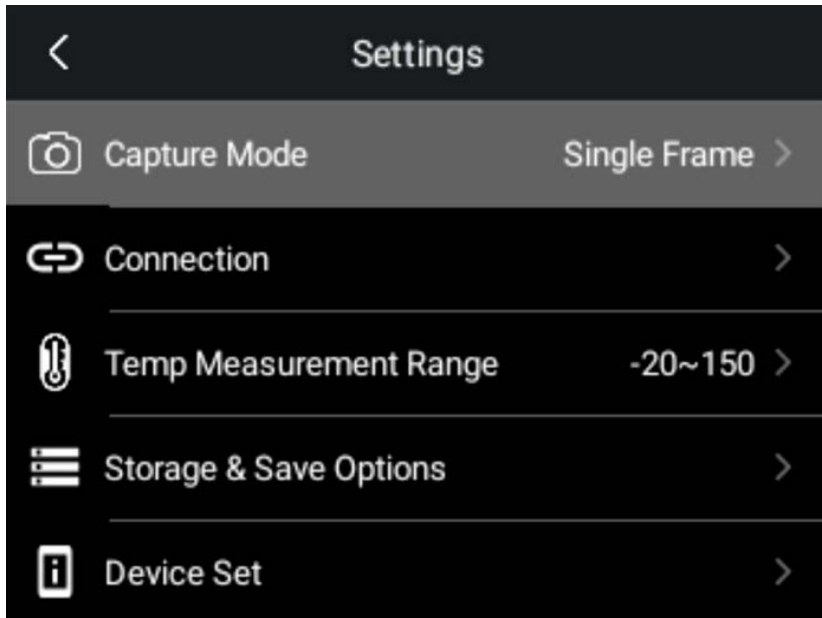

: The system settings menu includes the following options:

- Capture Mode
- Connection
- Temperature Measurement Range
- Storage & Save Options
- Device Set

SYSTEM SETTINGS

5.1 Capture mode

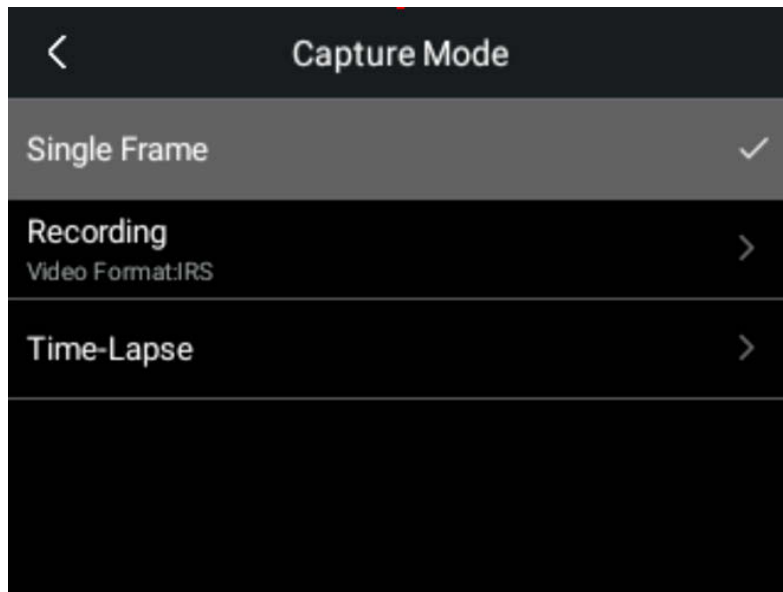

The device can be set to take single frame picture, record IRS radiometric /MP4 videos or time-lapse pictures.

5.2 Video recording

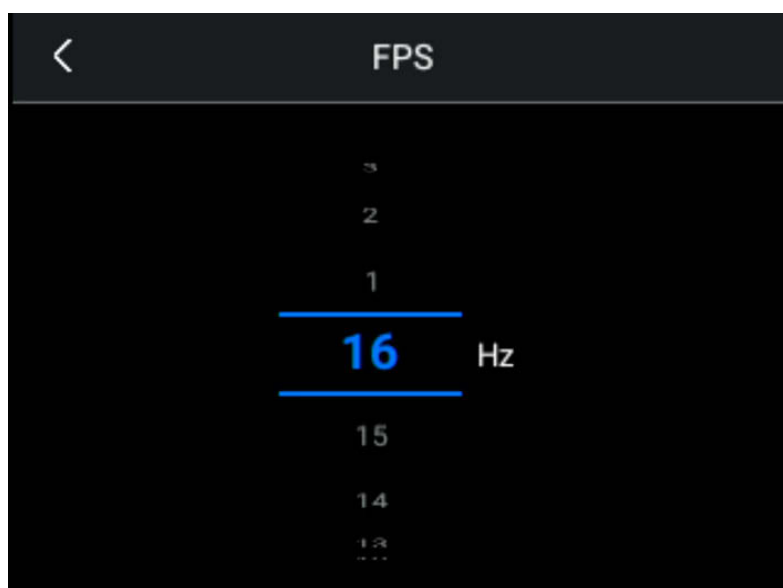

1. In video recording mode support FPS(1~16Hz) full-radiometric thermal video recording.
2. Pressing the trigger in video recording mode will start recording, pressing it again will enter the image freeze interface.
3. Support IRS and MP4 files. IRS is the full-radiometric thermal video for temperature analysis. MP4 is a plain video without temperature data.
4. In 'Setting->Storage and save options->Video format', users can alternate between IRS and MP4 files
5. Full-radiometric video recording is only available in thermal mode. MP4 recording supports all modes

! Note: After the MP4 video is saved, it can no longer be edited.

5.3 Time-lapse mode

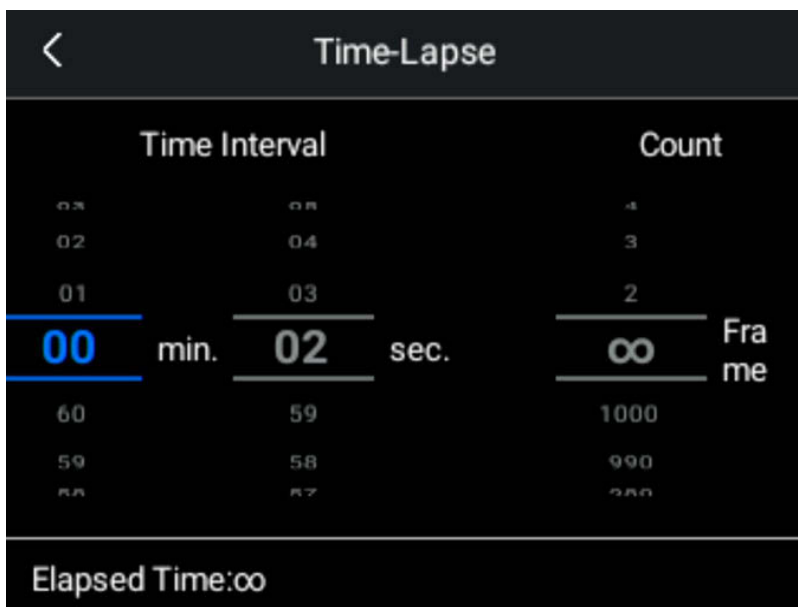

1. Users can set intervals between taken photos, shortest being 2 seconds and longest being 60 minutes 59 seconds.
2. Users can also set the Stop time, after a certain number of pictures have

been taken. The maximum set number being 1000; or unlimited.

3. In time-lapse mode, the camera will keep taking photos until the trigger is pressed again, or the previously set number of photos has been met

!Note: During time-lapse shooting, image mode changing is not available; and only the thermal image mode is available.

No operations aside from manual changing focus are available.

5.4 Connection

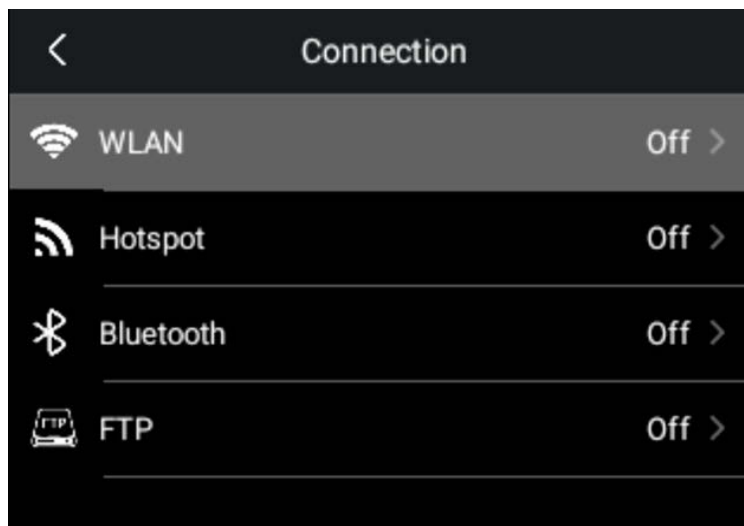

In connection set, users can set up Wi-Fi, Hotspot, Bluetooth, and FTP data transferring.

5.4.1 Wi-Fi

The thermal imager can be connected to WLAN via Wi-Fi.

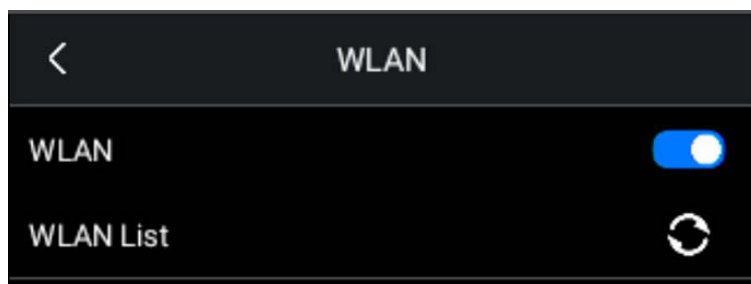

1. Click on **【...】** on the screen or the confirm button on the operation panel.
2. Click on "Settings"
3. Click on "Connection"- "WLAN"
4. Turn on "WLAN".
5. Choose an available Wi-Fi network. Enter password if required.

5.4.2 Hotspot



1. Click **【...】** on the Main interface, to display the menu bar.
2. Click on settings.
3. Click on "Connectivity" -> "Hotspot"
4. Turn on the "Hotspot" function
5. Enter Hotspot's username and password.
6. Hotspot can be used to transfer data from thermal imager to computer, via FTP protocols.

5.4.3 Bluetooth device pairing

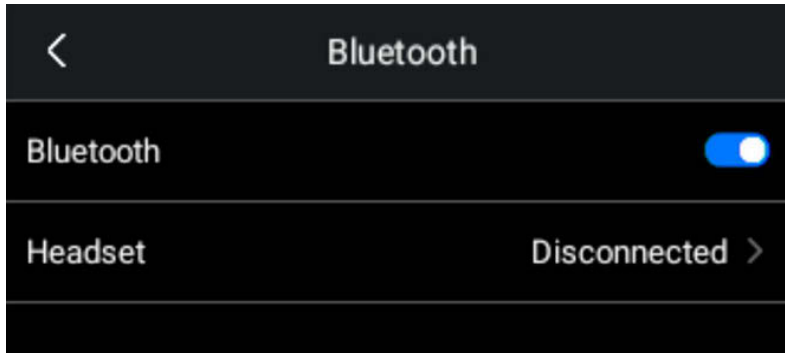

The thermal camera can be paired with Bluetooth devices, such as a Bluetooth headset, which can be used for voice annotation and sound alarms.

When paired with Bluetooth, the thermal camera's Mic and Speaker will be deactivated.

5.4.4 WLAN-FTP data transfer

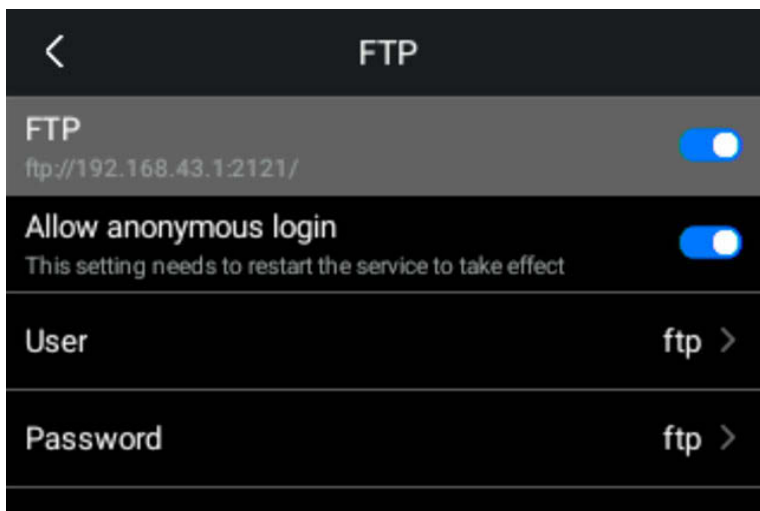

When the FTP Transfer function is turned on, the thermal camera's storage data (TF card) can be transferred to a computer via FTP protocols.

Click on – "Settings" – "Connection" – "FTP Transfer"

1. Connect a computer and thermal cameras to the same WLAN network, or

connect the computer to a hotspot, and then turn on FTP Transfer.

2. When successfully connected, an address will be generated: ftp://IP:+port. Users can access the address from a web browser, file explorer, or FTP tools to transfer data.
3. Users can choose to turn on/off anonymous access. If it's turned on, the client can access the FTP service and file system without extra validation.
4. If anonymous access is turned off, the clients must have pre-set user name and password to access the file system

!Note: When using FTP Transfer, the computer and thermal imager must be connected to the same WLAN Network, or via hotspot function.

5.5 Setting Temperature Range

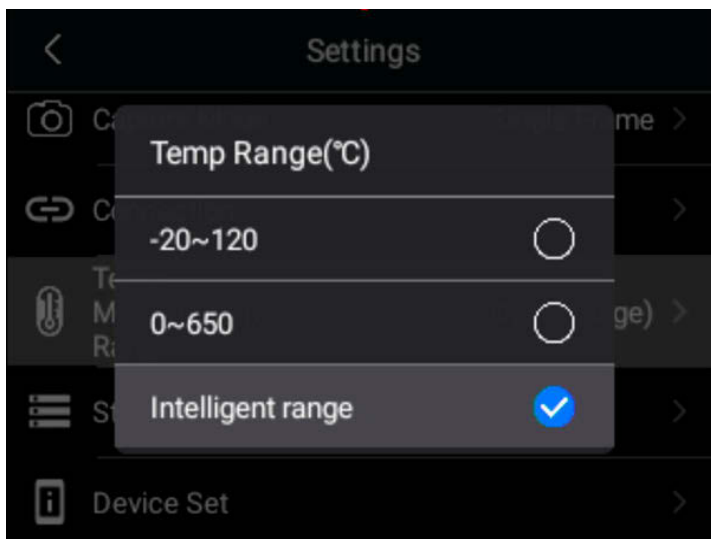

"Settings->Temp Range"

1. Choose the appropriate temperature range for measurement.
2. There are two rules when choosing temp range:
 - The object's temperature must be within the range;
 - 2. The range should be as small as possible.

- The 'Intelligent range' option will automatically choose the appropriate range based on the measured object's temperature.

! Note: Temp range is one of the functions that could be accessed by the AI programmable button.

5.6 Storage & Save options

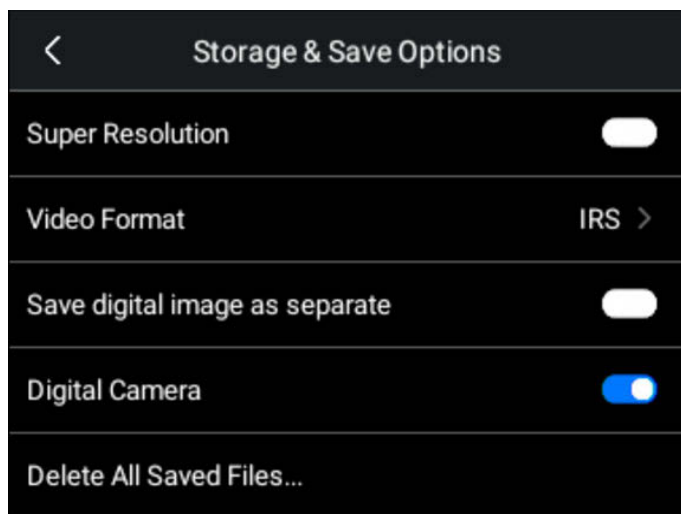

- Super resolution: when turned on, the digital resolution of thermal images will double. This function is not available under video recording and time-lapse mode.
- Video format: this setting defines the storage format of videos. Available options are:

IRS file: full radiometric files, support temp analysis and editing

MP4: after the video is saved, it can no longer be edited. The recorded content would include the user's screen operation.

- Save digital image as separate: Thermal image, PIP image, Fusion image, and digital image are saved in one JPEG file. When this option is selected, the system will save an extra High-resolution JPEG file of a digital image.
- Digital Camera: If the digital camera is turned off, the thermal imager can no

longer enter visible light /PIP /Image Fusion mode, neither can it capture a digital image.

- Delete all saved files: It will pop up prompt asking whether to permanently delete all the files saved in the storage card. Users can either confirm or cancel this action.

5.7 Device set



Under 'Device set', there are the following Options:

- language & date & region
- Display settings
- Location
- LED lamp as flash
- Screen off
- Manual mode
- Volume
- Reset
- USB connect mode
- About

5.7.1 Language & Date & Region

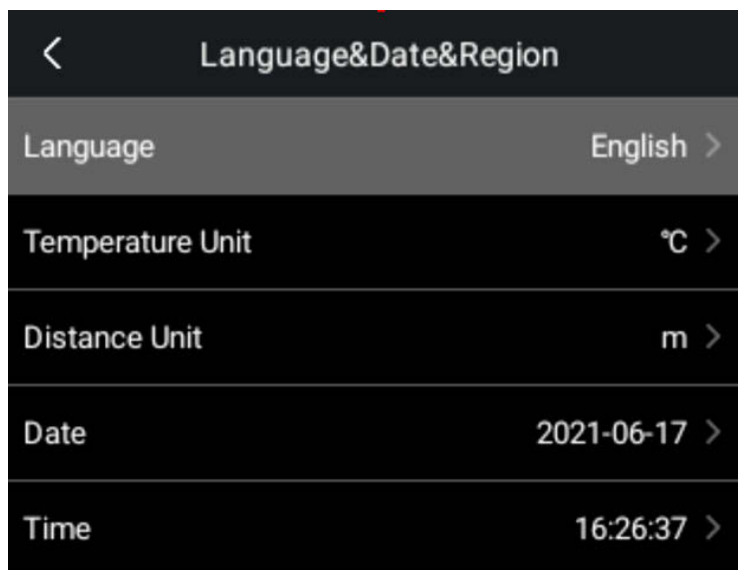

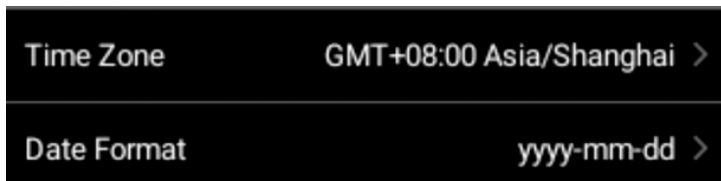

- Language&Date&Region: this submenu contains settings for language, temperature unit, distance unit, date, time, and time zone
- Languages include English, traditional Chinese, Spanish, Korean. More will be made available in the future.

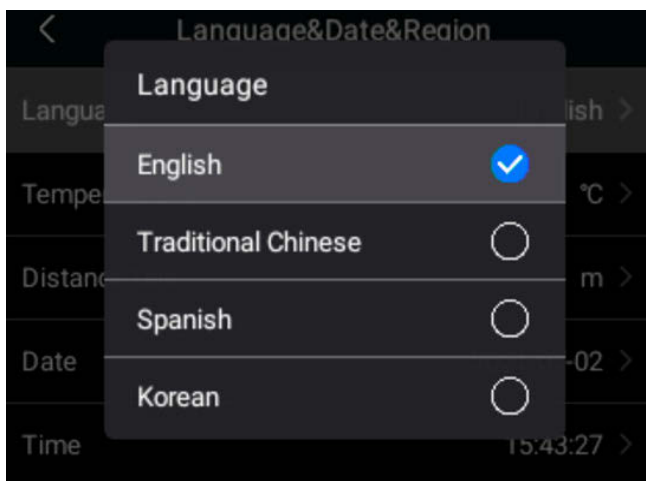

Temperature units: °C、K、°F

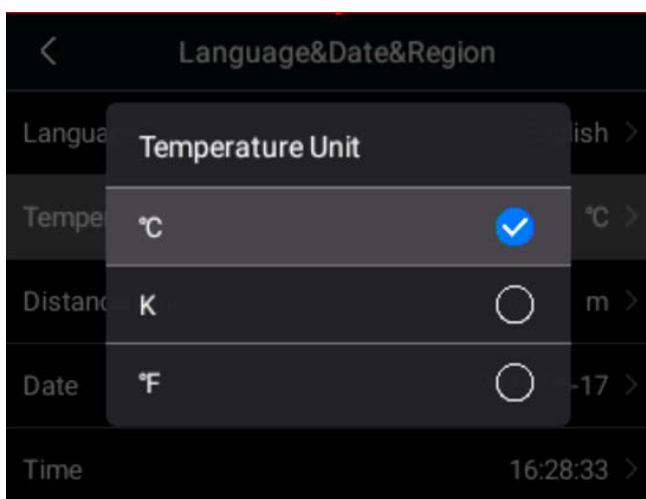

Distance unit: meters, feet

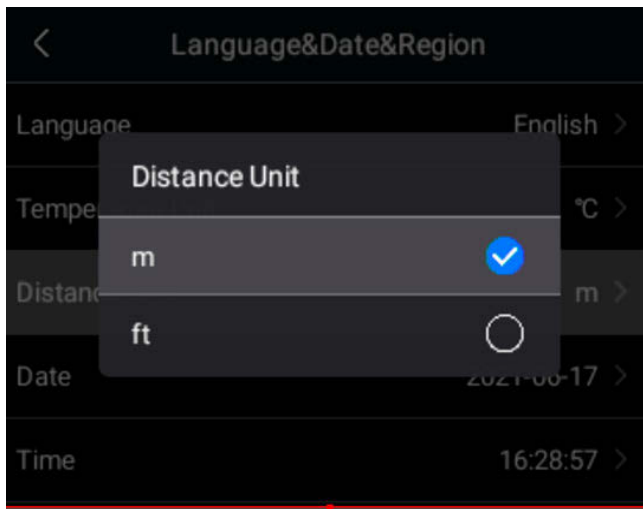

Date

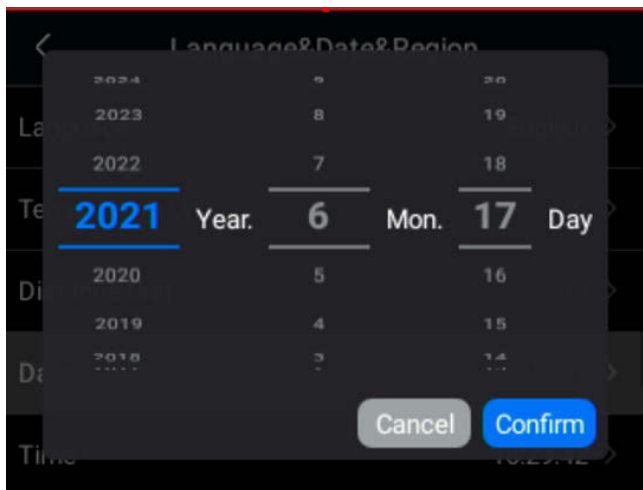

time

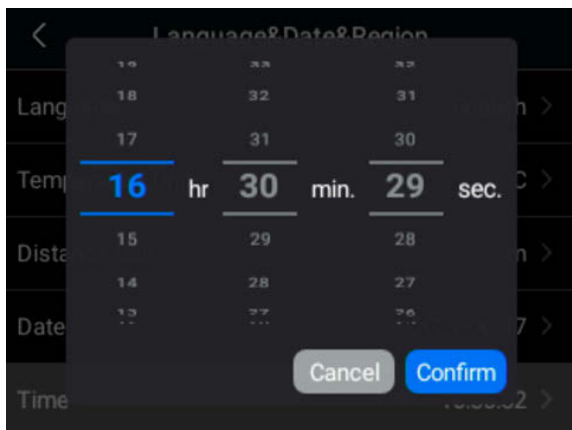

time zone

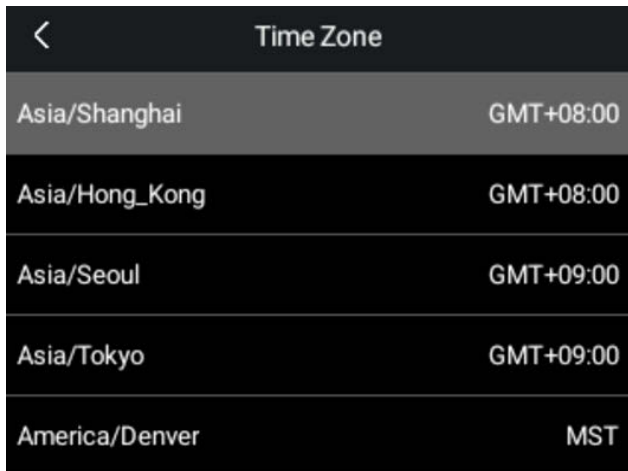

Date format

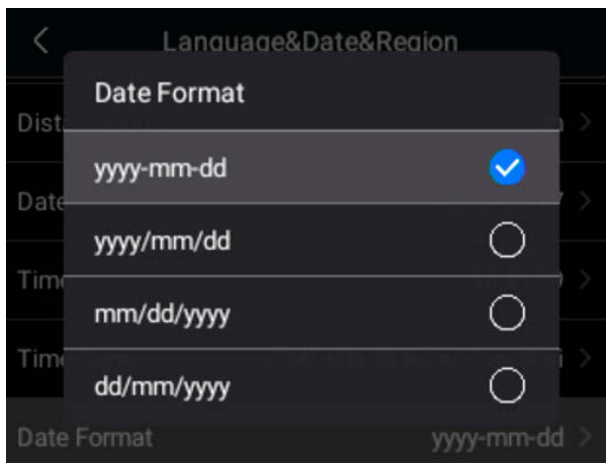

5.7.2 TWB

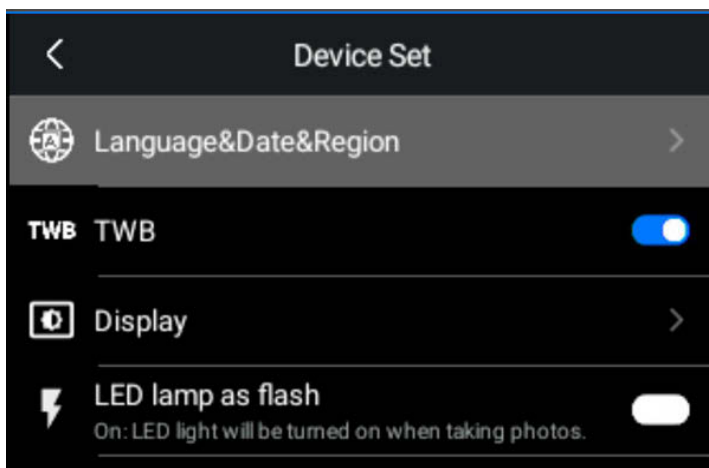

TWB mode: TWB is named Thermal White Balance. It balances color distribution on the entire temperature span of the image.

When the TWB function is turned on, the overall image color display will be balanced non-linearly according to the histogram of overall temperature.

It makes the extreme hot/cold area's color display weaken, while other areas are enhanced with more gradients.

Before TWB:



After TWB:

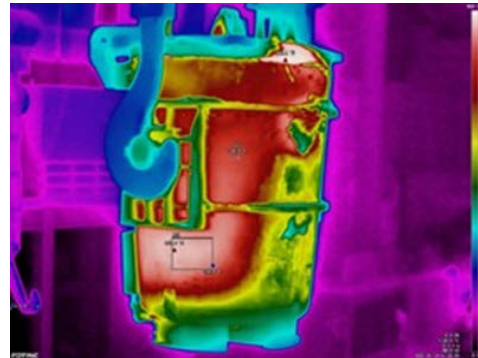

5.7.3 Display setting

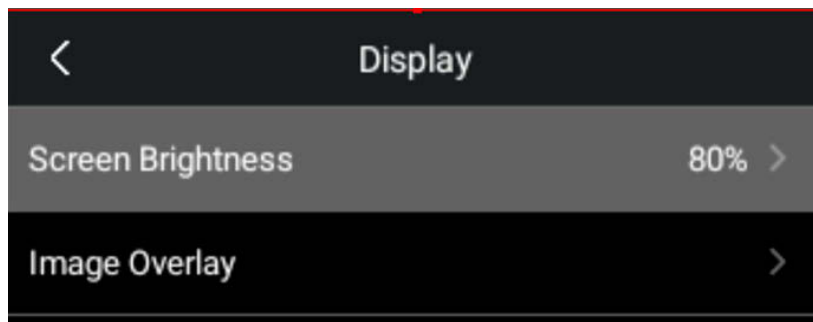

Display setting: brightness of the screen, and image overlay information

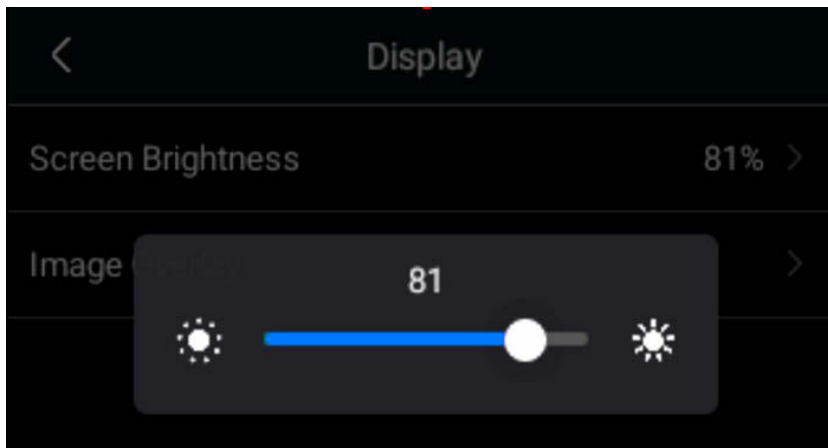

Slide to change the brightness of the screen

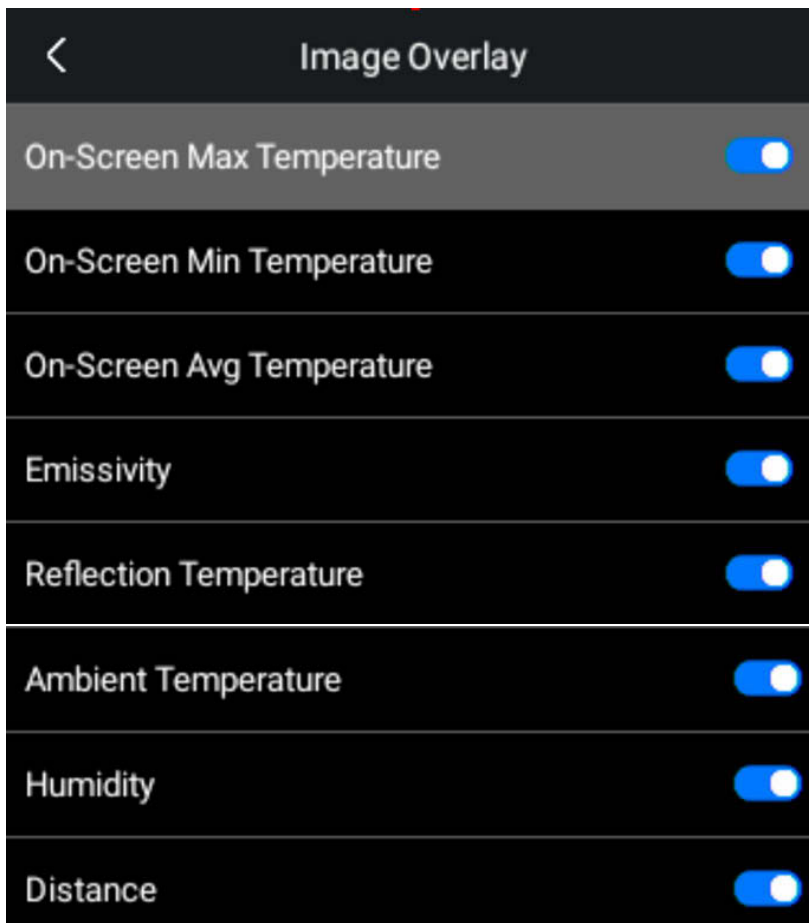

The information image overlay contains are all displayed in the images above

5.7.4 Geographic Location

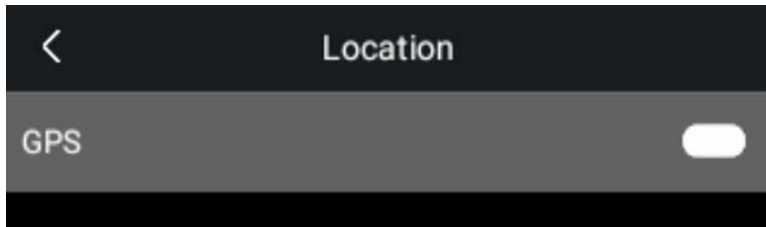

Turning GPS on/off: Turn GPS on, to save geographic information in the thermal images.

5.7.5 LED lamp as flash

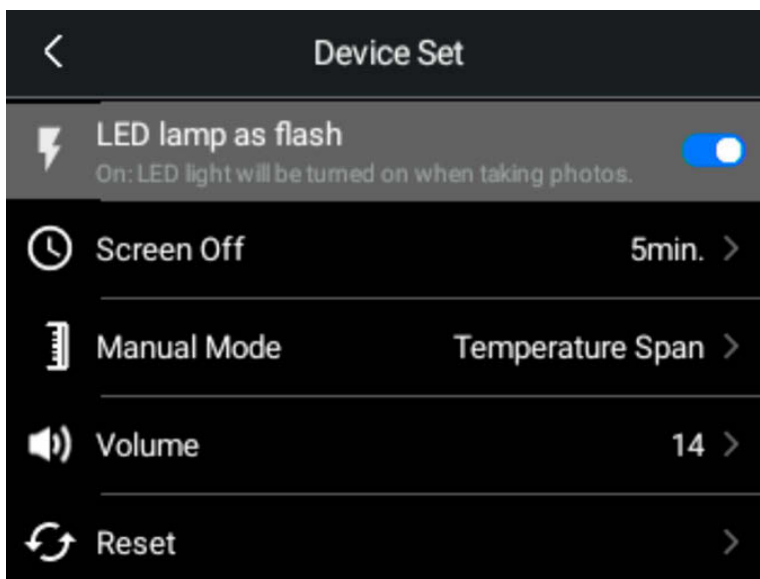

The LED lamp on the thermal imager can serve as a flash for the digital camera. When this function is turned on, the thermal imager will activate an LED flash lamp when capturing images. The LED can also be turned on permanently on the Swipe-down menu.

5.7.6 Screen off time

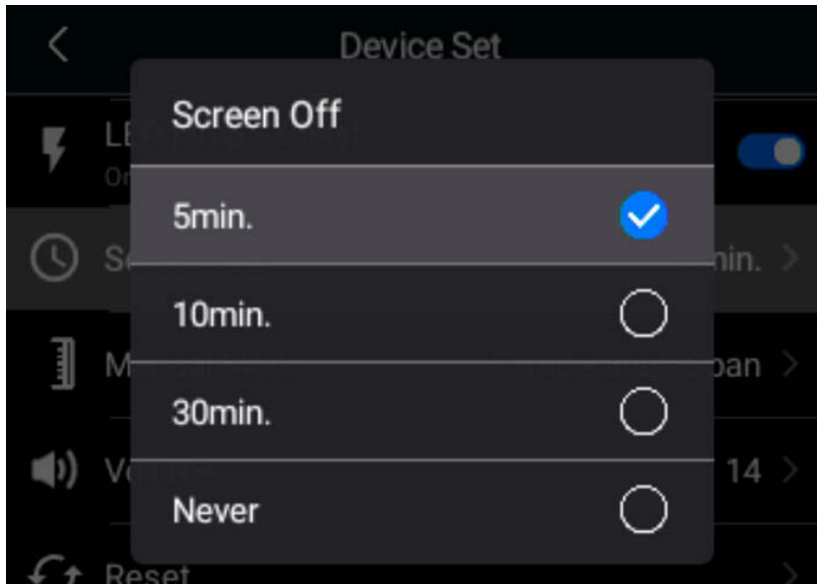

- This function determines how long the screen stays on when there is no operation. Options are: 5 mins, 10 mins, 30 mins, and never.
- When the screen is off, pressing the power button can wake it.

The screen can be turned off manually by pressing the power button.

5.7.7 Manual mode settings

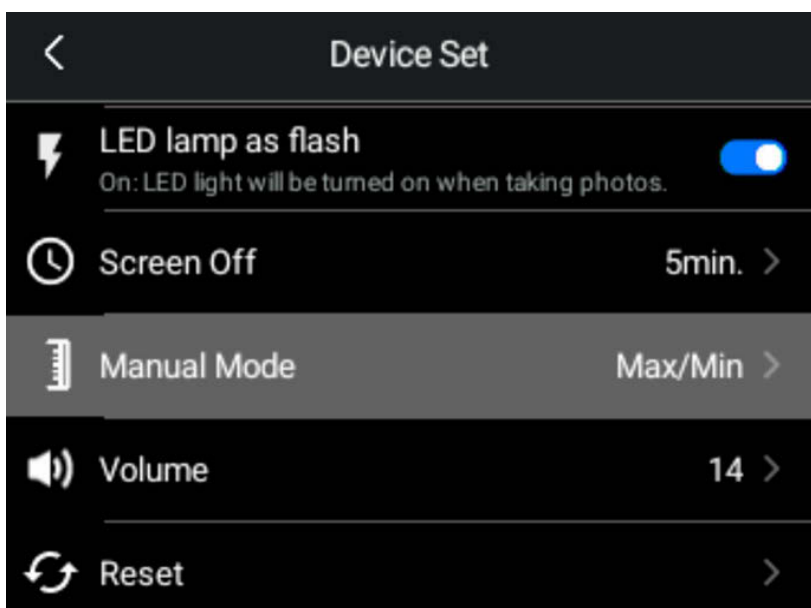

- It offers two alternatives for manual scale mode
- Max/min: under this mode, users can adjust the max and min temperature of the manual scale range, separately or together.
- Temperature span: the max and min temperature of the manual scale range can only be adjusted simultaneously, and the smallest span is 2°C . For more information, please see 'Temperature span mode'

5.7.8 Volume

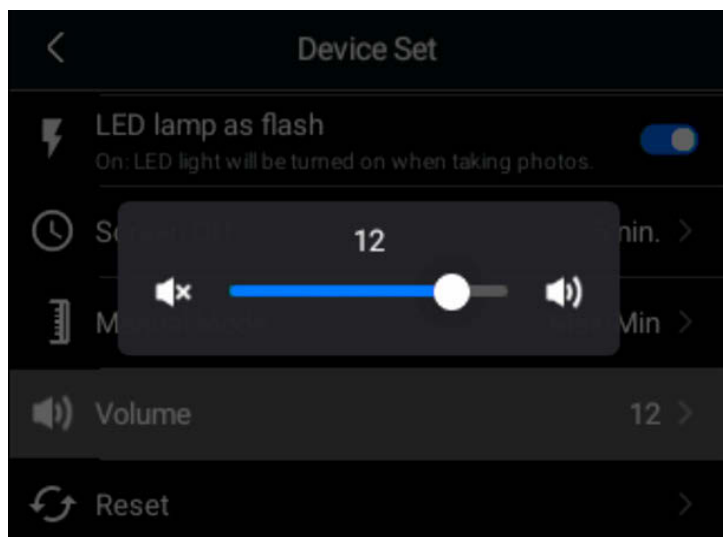

Swipe to adjust the volume of the device

5.7.9 Reset

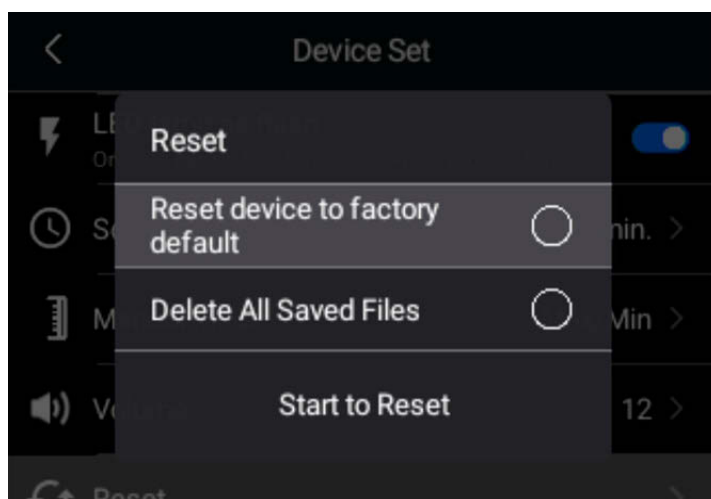

As the image above indicates

5.7.10 USB Connect Mode

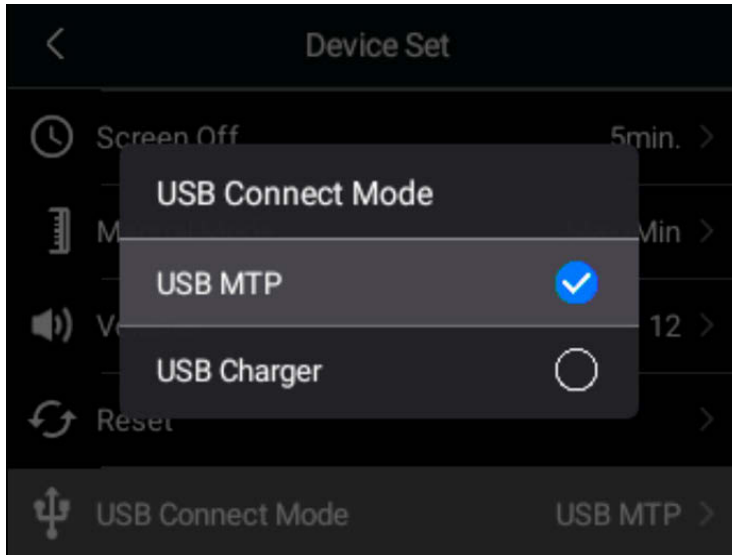

- USB Connect Mode: USB MTP and USB Charger modes
- USB MTP: The USB interface can be used for data transfer between the camera's SD card and computer; Or be used for thermal video streaming. Power charging also works in this mode.
- USB Charger: The USB interface can be used for power charging only.

5.7.11 About

About	
Model	326M
Serial Number	0102007371
Software Version	V1.0.8
System Version	5.0.7.15
Operation System Version	1.0.0.23

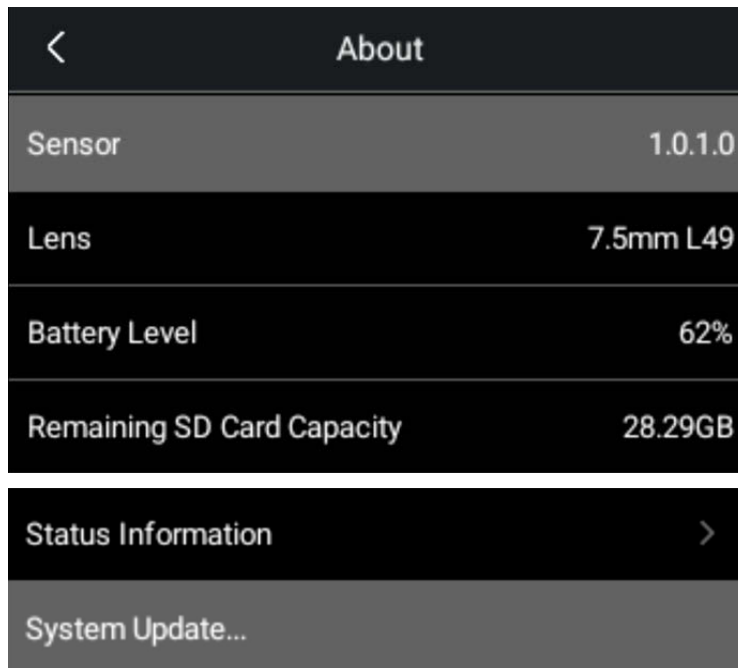

The 'About' section contains information as below:

Camera model type, Camera serial number, Camera software version, Camera system version, Camera sensor resolution & info, camera Lens type, Battery Level, Remaining SD Card storage Capacity, Camera Status info(IP Address, MAC, Bluetooth), and Systems update function.

Image freeze interface

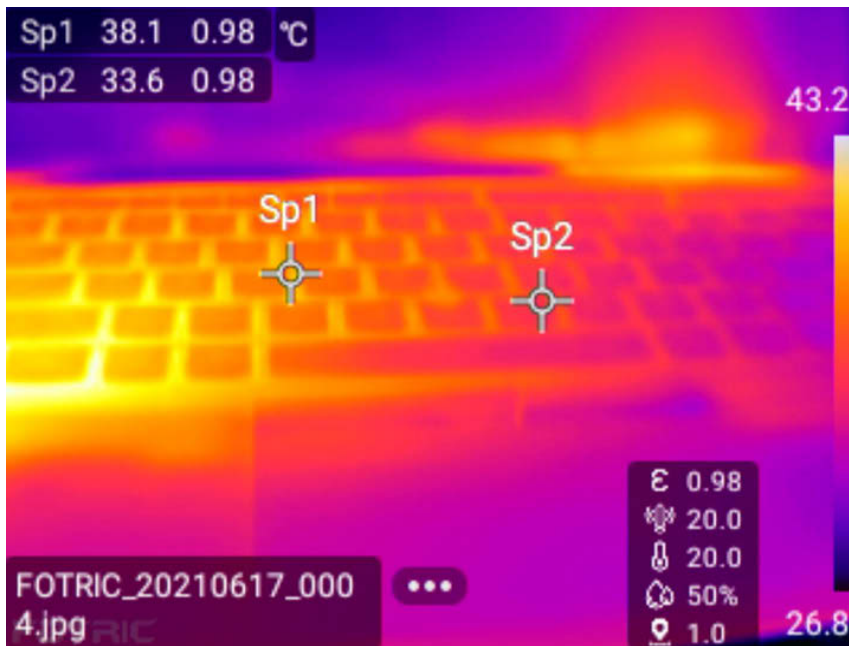

On the Image Freeze Interface, the image can be edited or analyzed before save. Press the capture button again to save the image.

Press "Back" twice to exit the Image Freeze Interface without saving the image.

The Image Freeze Interface function in single frame capture of thermal, PIP, and image fusion modes.

The Image Freeze Interface function is not available in Visual light digital camera image mode.

The thermal image's file name will appear on the bottom-left corner of the freeze image

Click on  to display the image analysis menu for freeze image.

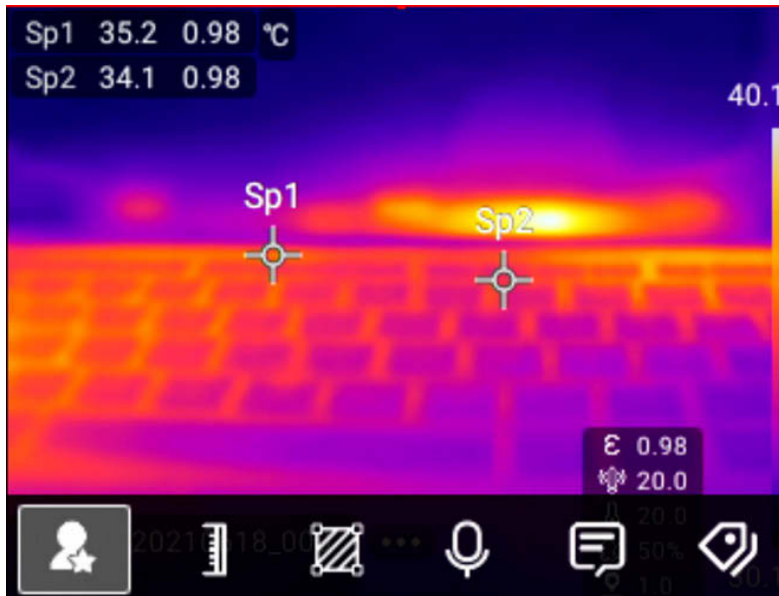

 Favorite button. The favorite files can be screened by the Favorite button in the gallery;

 Temperature scale set button. For details, see 4.5 Temperature Scale Mode.

 ROI measurement tool. For details, see 4.8 ROI Measurement Tool.

 Voice annotation.

 Text annotation.

 Tag.

6.1 Favorite

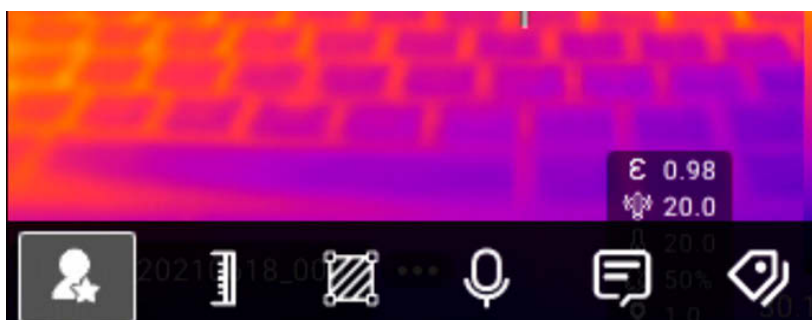

1. On the  and a favorite icon will be displayed on the upper right corner of the image. Click it again will cancel the 'favorite' status and icon
2. In the gallery, you can click on the favorite button to screen all the favorite image files.

6.2 Voice annotation

Click on  to enter voice annotation

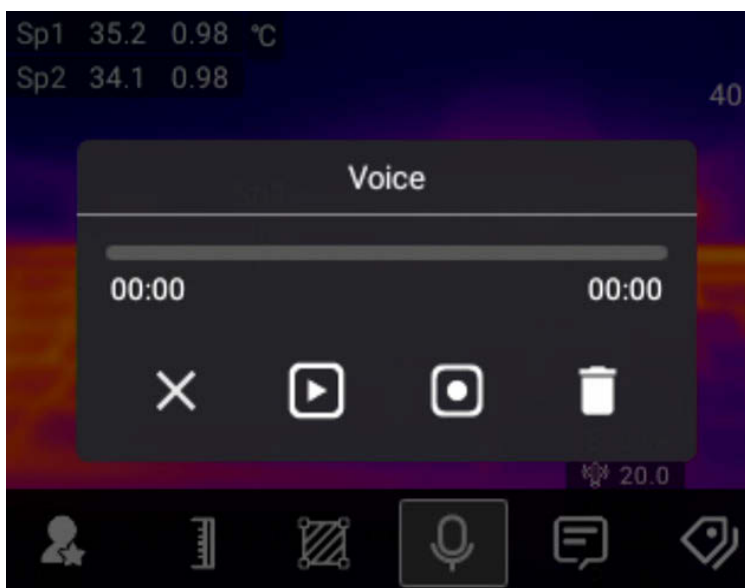

The voice annotation supports 120 seconds of voice recording annotation in the image file. It can be played in the gallery or on PC analysis and reporting software.

 Close

 Play

 Record

 Delete

When the voice recording is completed, close the voice annotation window and a voice icon will appear on the top-right corner of the image freeze interface.

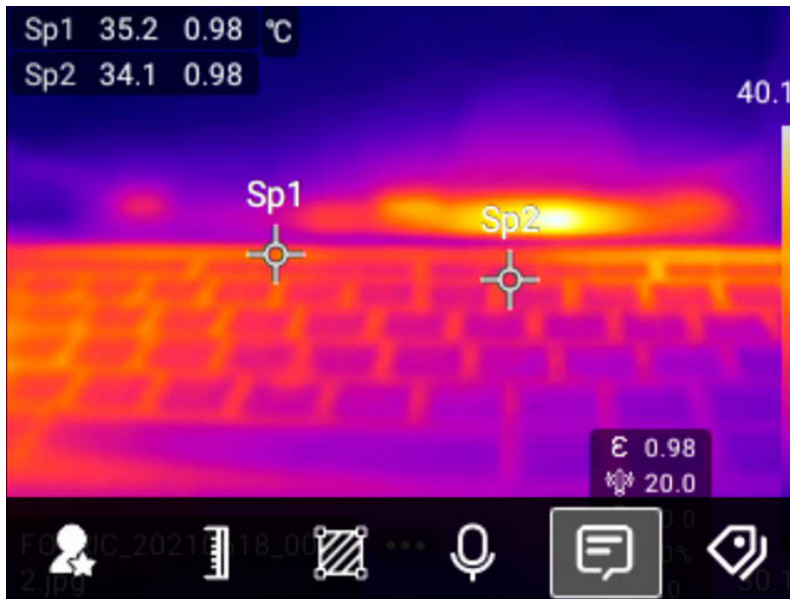

6.3 Text annotation

Click on  to enter text annotation

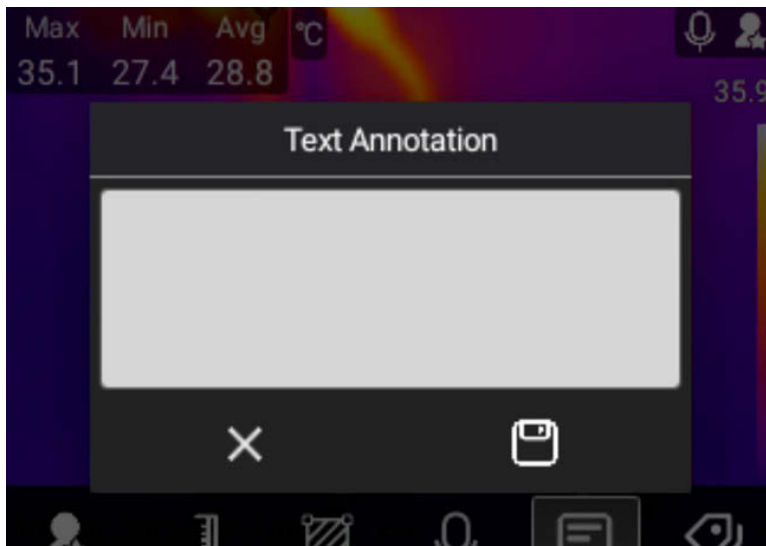

Text annotation can be added to the thermal image file by the virtual keyboard on the screen.

 Close



Save

6.3.1 Keyboard input

1. Click on the text input block, and a virtual keyboard will pop up.

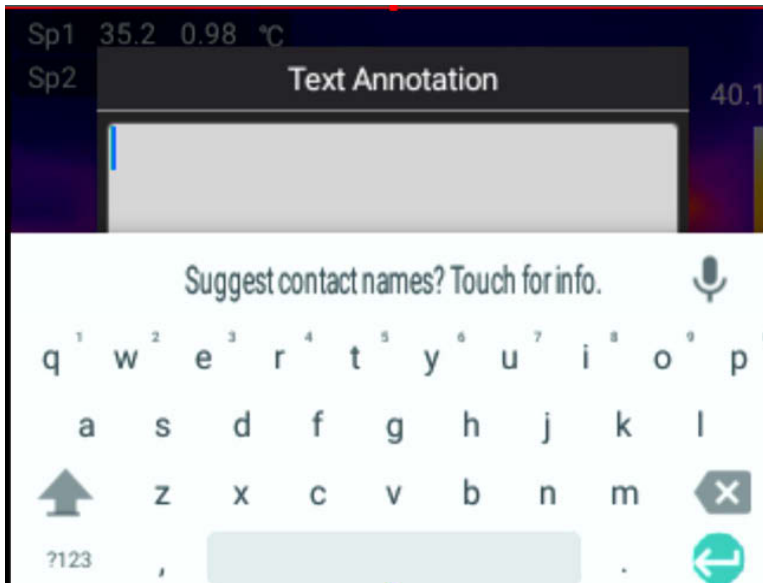

2. After typing the text contents in, press the 'return' button to exit the virtual keyboard
3. Click the save button to save the text information in the thermal image. And a text annotation icon will appear on the top-right corner of the image freeze interface

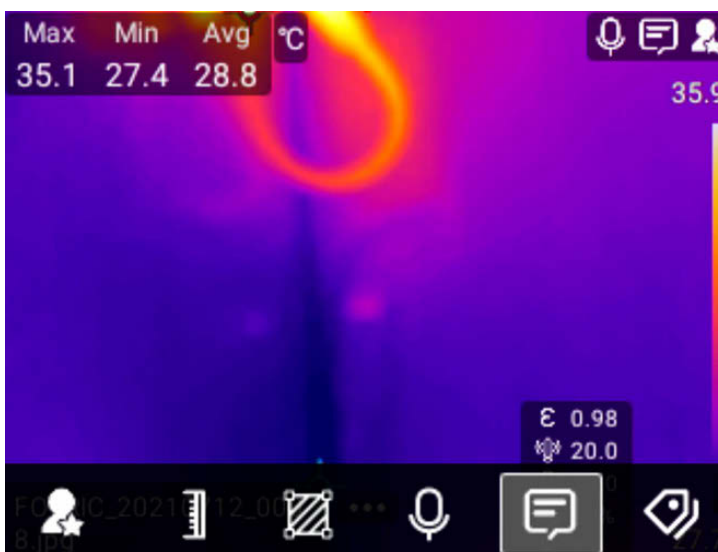

6.4 Tag

Click  to add a tag

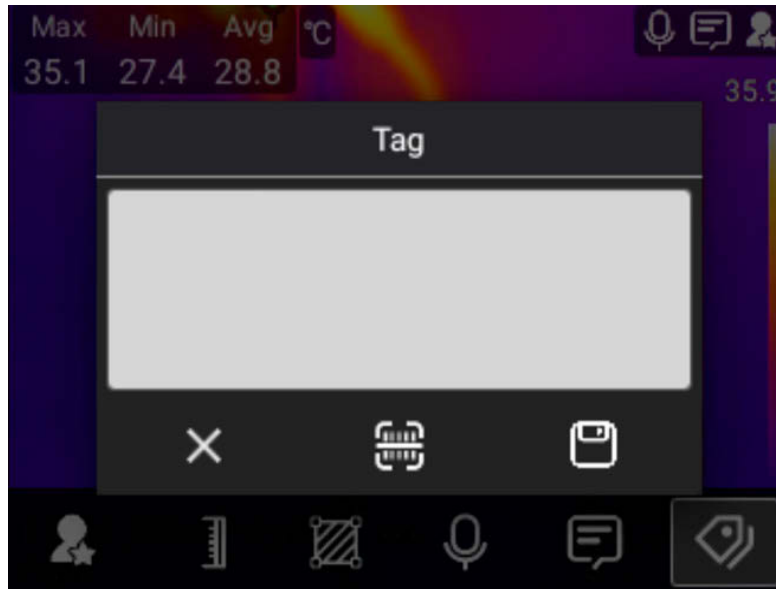

In the image freeze interface, Tag information can be inputted by QR code scanning and virtual keyboard



Close



QR code scanning



Save

6.4.1 Input by the virtual keyboard

1. Click on text input block, and a virtual keyboard will appear

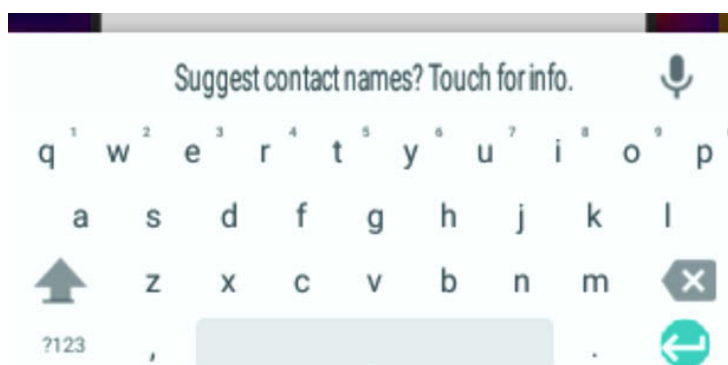

2. After typing the text contents in, press the 'return' button to exit the virtual keyboard and save.
3. A tag icon will appear on the top-right corner of the screen



6.4.2 QR code scanning

1. Click  to display the QR scan interface and aim towards the desired QR code

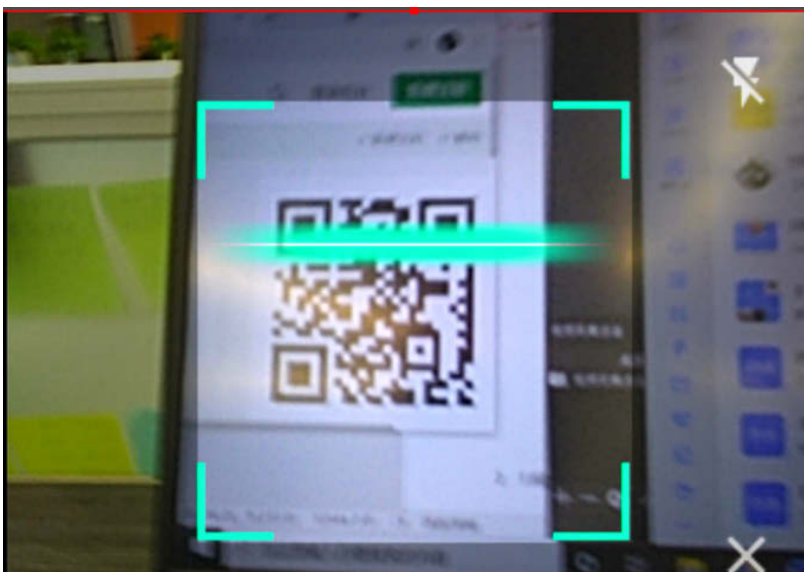

2. After successfully scanned, the text content from the QR code will appear in the text input block

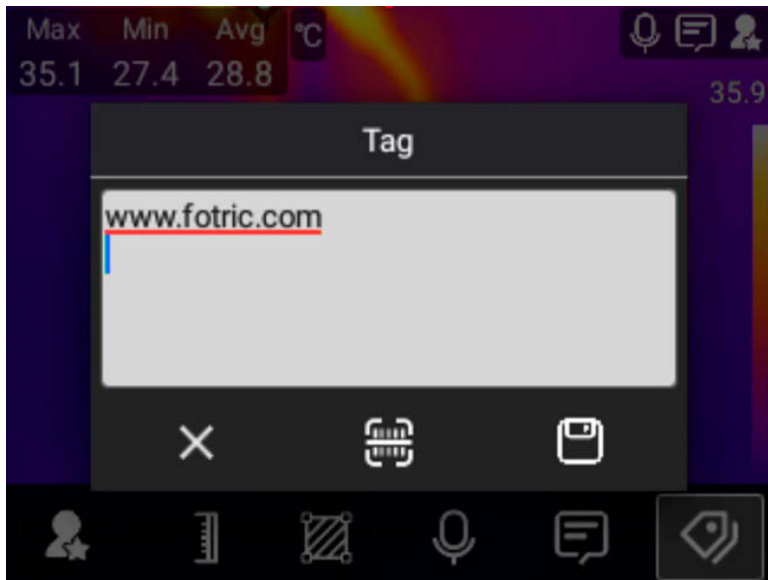

3. Click save and the tag icon will appear on the top-right corner of the image freeze interface

Video freeze interface

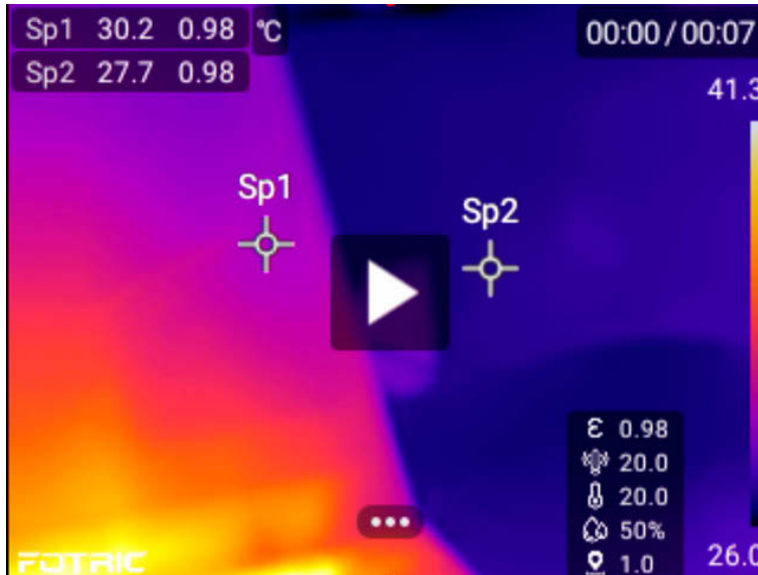

Users can preview the radiometric image before saving it. On the freeze interface, videos can be analyzed. Pressing the trigger button again to save the video.





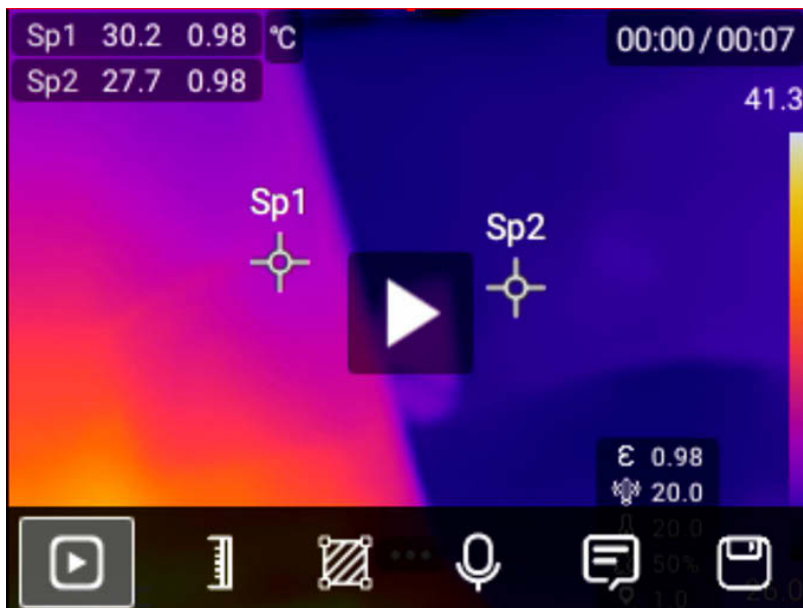

Pressing the 'back' button twice on the video freeze interface will exit it without saving the video.

Image freeze interface only exists in IRS format mode, not MP4 format mode.

In IRS format mode, Played time/total recording time will appear on the top-right corner of the video freeze interface

In the video freeze interface, click  to display the analysis menu



-  Play button
-  Temperature scale setting; See 4.5 of this manual
-  ROI measurement tools, see 4.8 of this manual
-  Voice annotation, see 6.2 of this manual
-  Text annotation, see 6.3 of this manual
-  Save button

7.1 Play

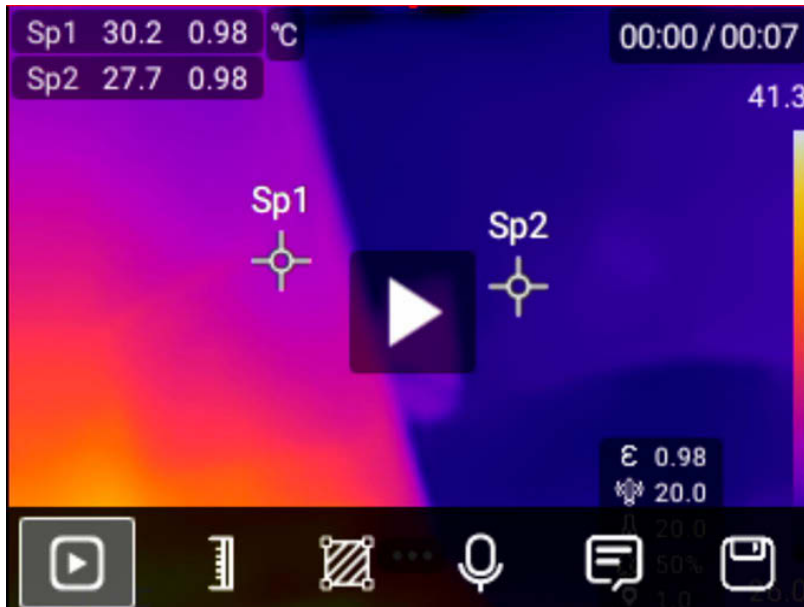

Videos can be played in freeze interface, or from Gallery. Click  either on the menu or on the center of the screen to play/pause/resume.

7.2 Save

1. Click  on the menu to save the radiometric video and exit the video freeze interface.
2. Press the trigger button will also save the radiometric video and exit the video freeze interface.





Gallery

The images and videos are saved in the SD memory card, which can be viewed in the gallery. Click the Gallery button to open the gallery.

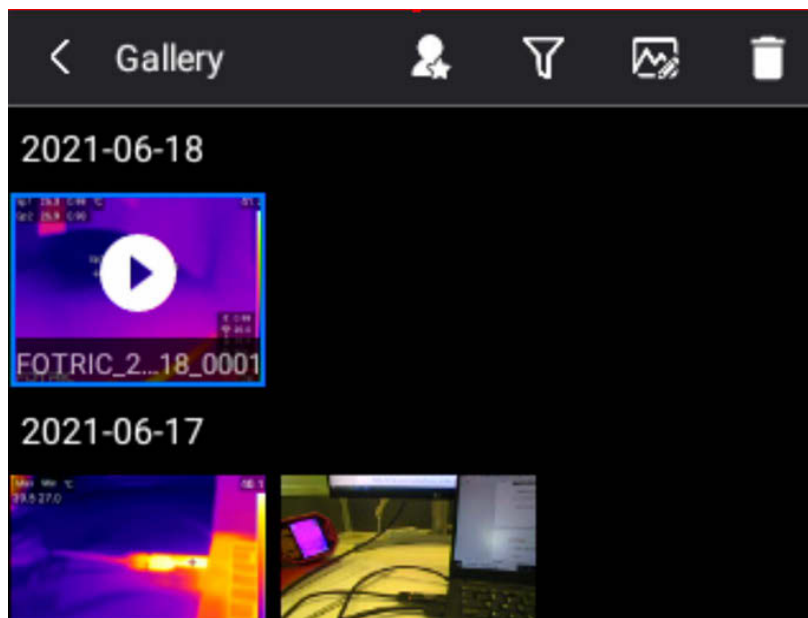
Image files are grouped by date, as shown in the figure below. The images can be switched by clicking on the direction keys or by touch screen and be selected to analyze or display. To return to the live interface, click on the "Back" button

In the Gallery interface, touch the images to select.



-  Filter favorite files
-  Filter tag files
-  File analysis (only available for a thermal image or IRS radiometric video)
-  View the digital image
-  Play the MP4 video (when an MP4 video is selected)

 View the time-lapse images (when time-lapse images are selected)

 Delete

The gallery contains files of the thermal image, digital image, IRS radiometric video, MP4 video, and time-lapse images. Time-lapse images portray the consecutively taken images as a group.

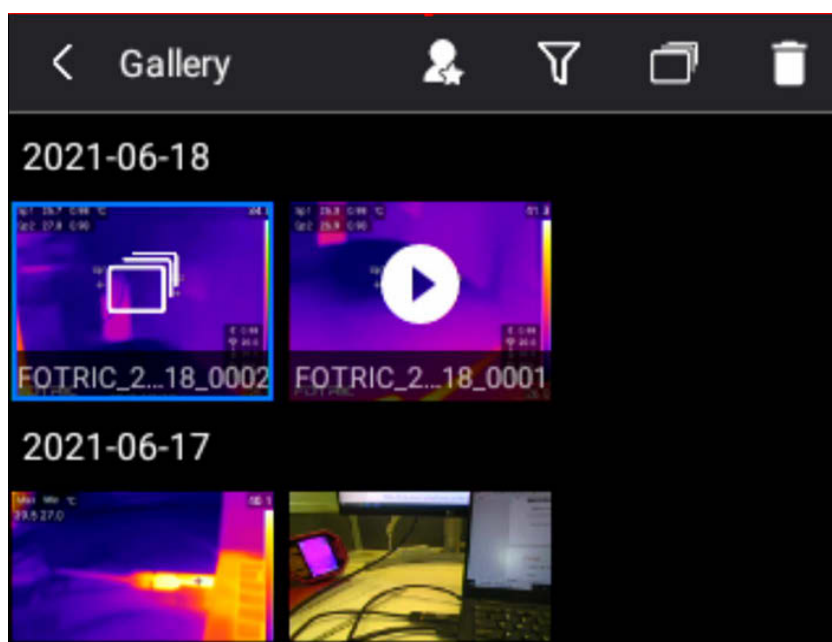

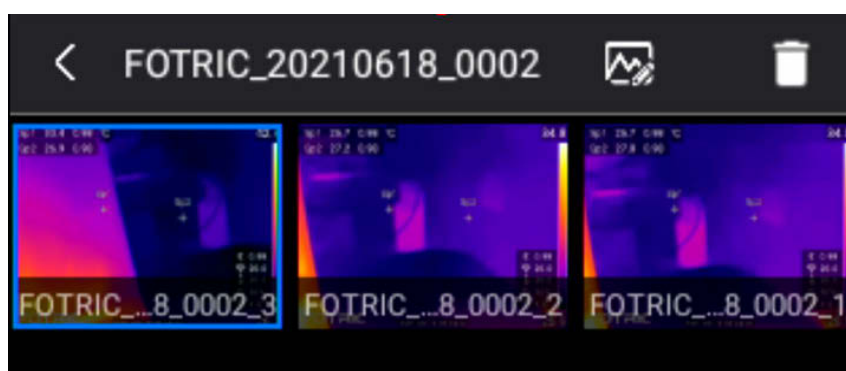

When selecting the time-lapse group, click on it again to enter the group menu, which displays all the taken images.

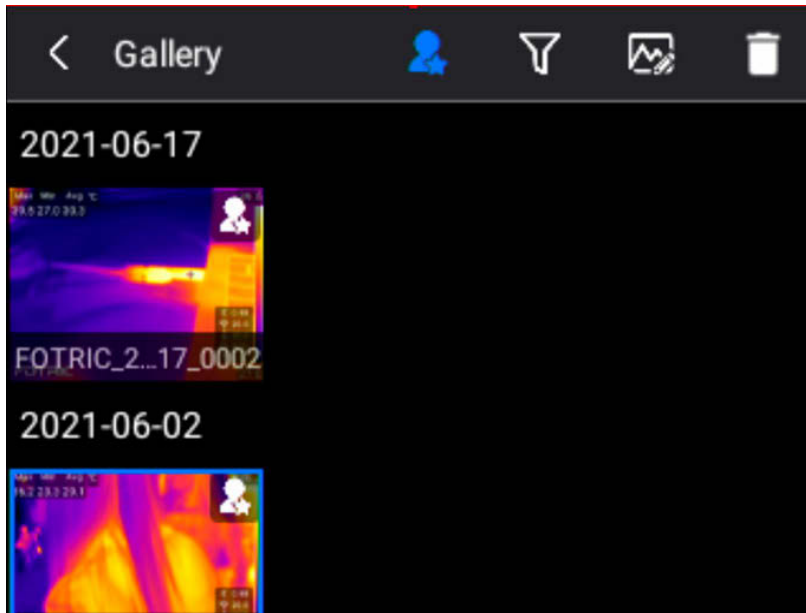

8.1 Favorite Filter

Click on the  to filter all the "Favorite" file



Click  it again to undo the filter. For more information, see section 6.1 of this manual

8.2 Tags filter

Click  to enter the Tags filter interface

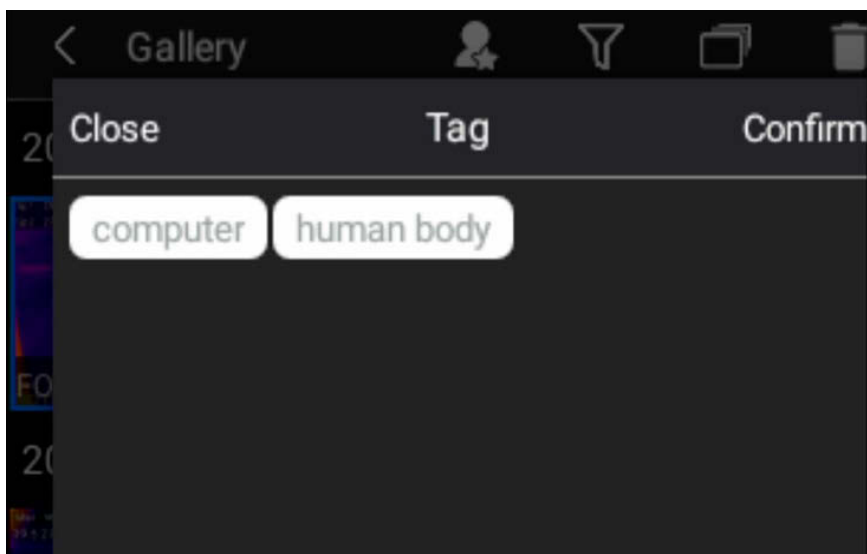





Click on the desired tag contents, then click 'confirm' to filter all the files that contain the tag. Click the  icon again to undo the filtering. For more information, see section 6.4 of this manual

8.3 Open image and video files

Thermal images can be analyzed after save, such as measurement parameters editing and saving.

IRS radiometric videos support on-device analysis; while visible images and MP4 files only support viewing and deleting, not any sort of editing.

For all the files, click once to select, and click again to analyze or view/play.

1. Thermal image, PIP, fusion images can all be selected and analyzed by clicking the  icon or pressing the 'OK' button
2. Digital images can be viewed by clicking the  icon or pressing the 'OK' button.
3. IRS radiometric videos can be selected and analyzed by clicking the  icon or pressing the 'OK' button
4. MP4 files can be viewed by clicking the  icon or pressing the 'OK' button.
5. Clicking  icon after selecting a time-lapse image group will display its menu, on which all the images the camera took during the time-lapse period will be accessible. Every image is susceptible to analysis or delete. They can also be viewed by pressing the 'OK' button

8.4 Thermal files analysis





8.4.1 Thermal image analysis

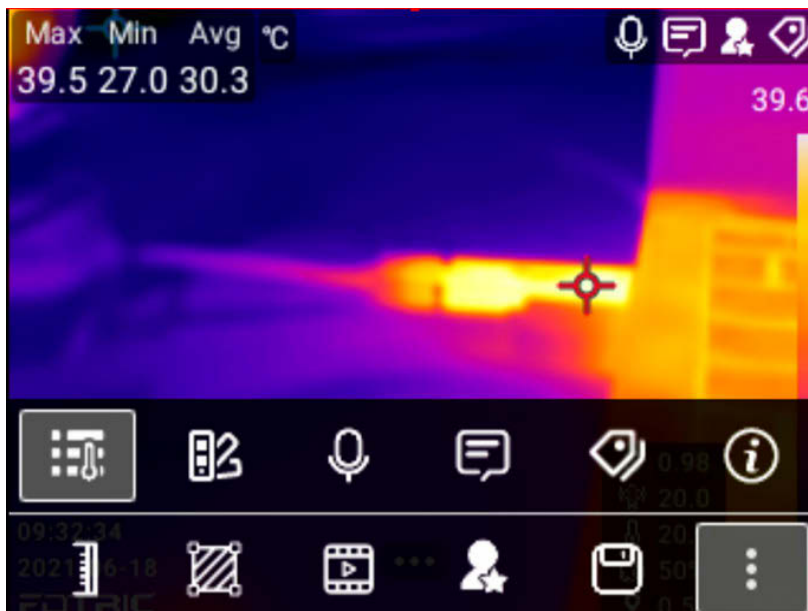

Thermal images can be reviewed and analyzed. Click  to display the menu



 Temperature scale mode; see section 4.5

-  ROI measurement tool; see section 4.8
-  Image mode, can switch to thermal image/PIP/image fusion
-  Favorite, see section 6.1
-  Save
-  More
-  Measurement parameters. see section 4.6
-  Palette, see section 4.10
-  Voice annotation, see section 6.2
-  Text annotation, see section 6.3
-  Tags, see section 6.4
-  Detailed info of the file

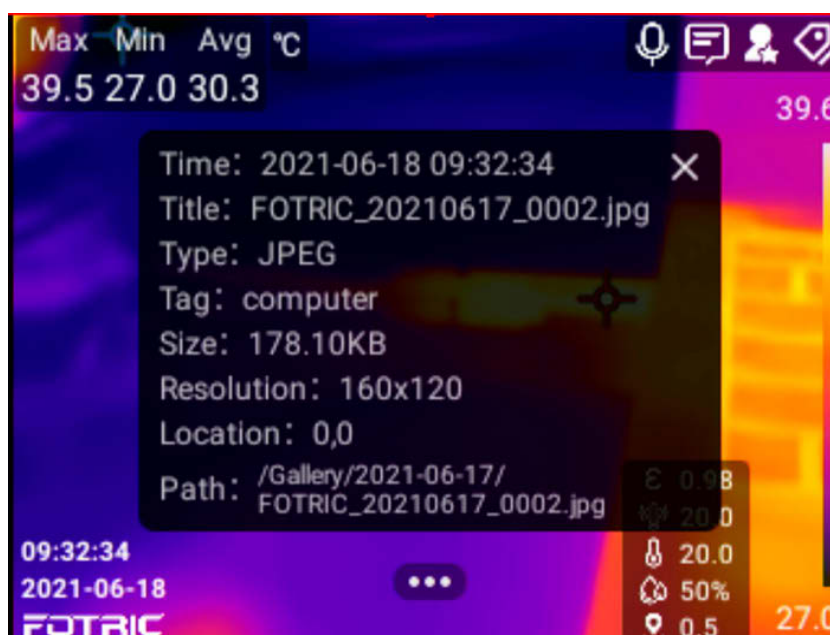

8.4.2 Thermal videos

MP4 videos only support the 'Play' function.

IRS radiometric videos are not only playable but also analyzable, as shown below:

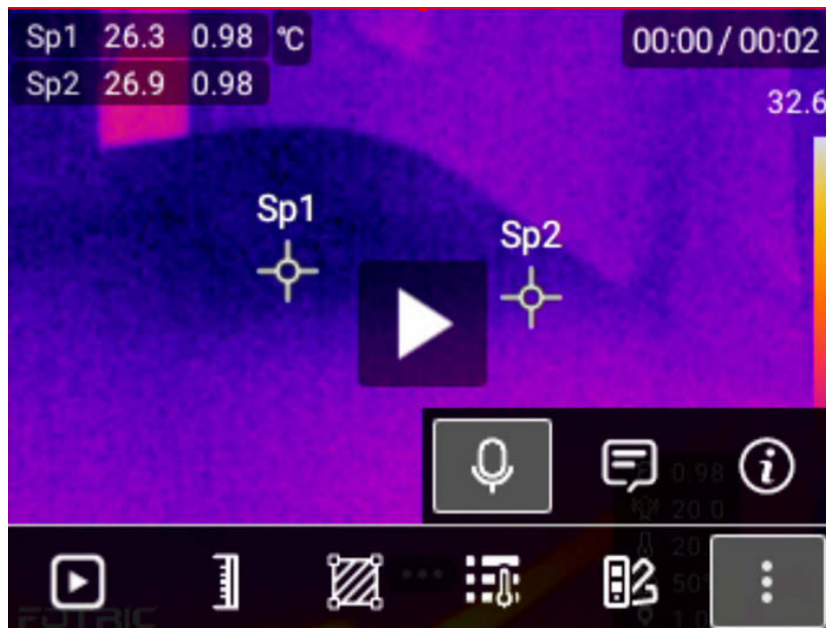

Play



Temperature scale mode; see section 4.5



ROI measurement tools; see section 4.8



Measurement parameters; see section 4.6



Palette; see section 4.10



More



Voice annotation; see section 6.2



Text annotation; see section 6.3



Detailed info of the file

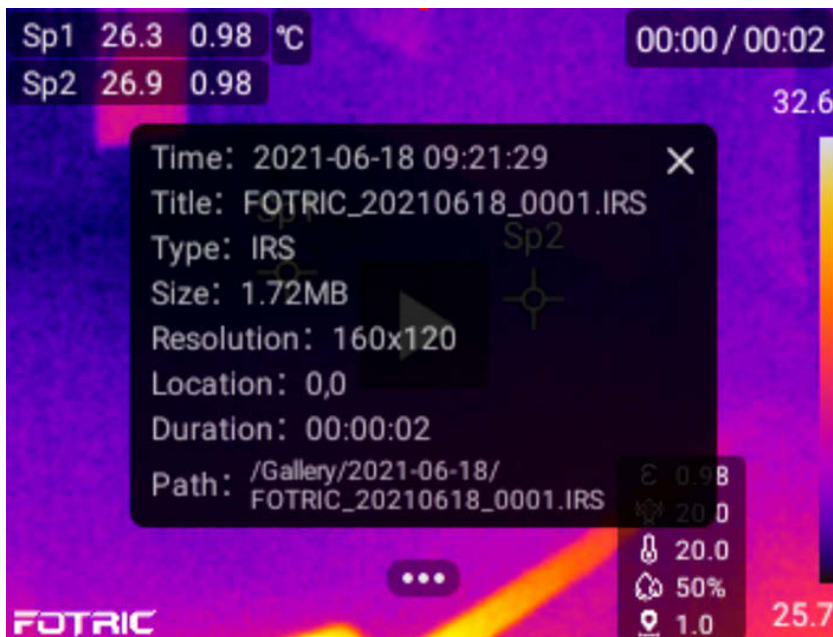

8.5 Deleting image or video file

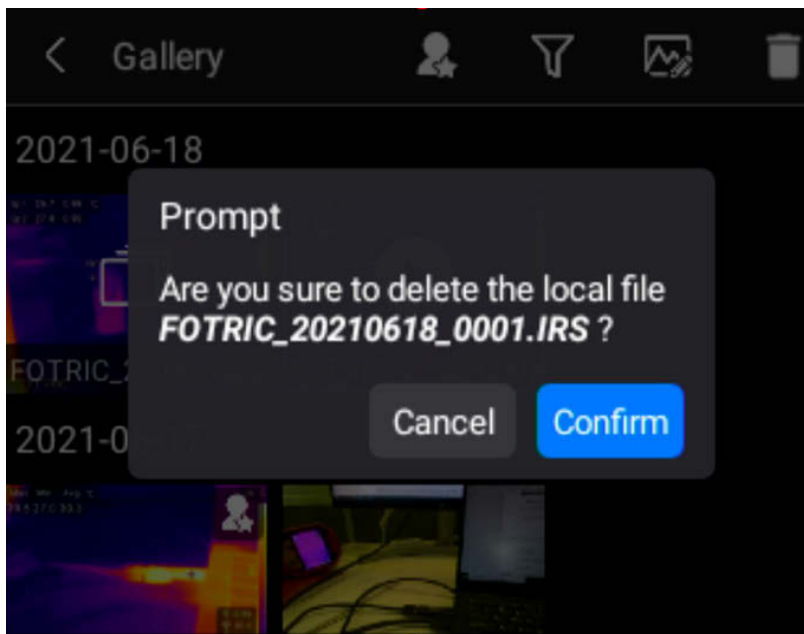

1. Open the gallery by pressing the gallery button.
2. All the files are displayed in the gallery, grouped by captured date.
3. Select an image, click the 'Delete' button, or press the 'OK' button to display the 'Delete' prompt window.

4. Delete imaging files by clicking on 'Confirm'.

8.6 Deleting multiple files

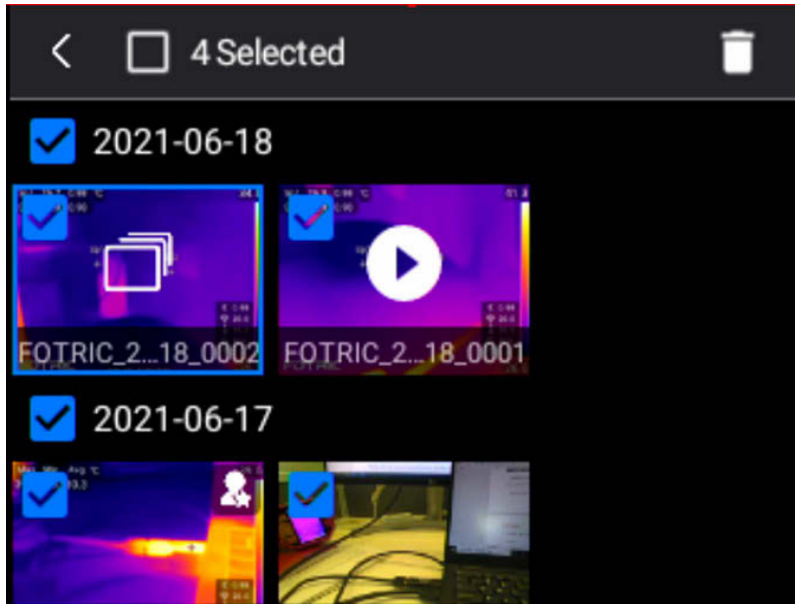

1. Long-press on one of the files to enter multi-selection mode;
2. Or, click on a certain date to select all the files on that date
3. Click on the selection box on top of the screen to select all files in the gallery
4. Click on 'Delete', and it will display a 'Delete' prompt window.

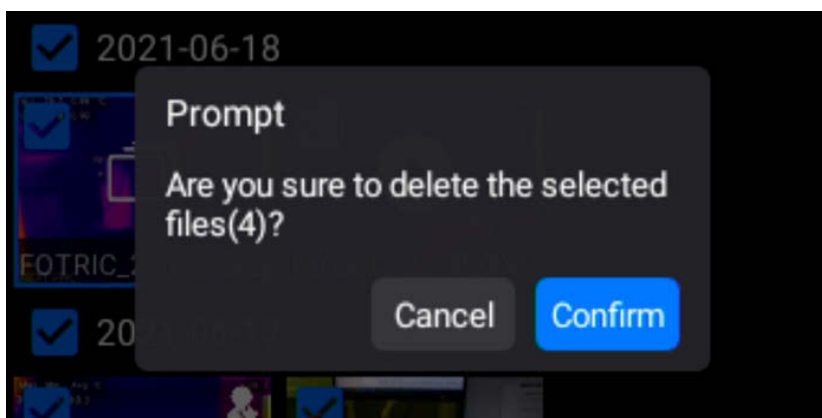

5. Delete imaging files by clicking on 'Confirm'.

Thermal imager maintenance

9.1 Cleaning casing/ wires and other components

9.1.1 Cleaning fluid

Choose from the following options

1. Tepid water
2. Mild cleaning fluid

9.1.2 Tool

A piece of soft cloth

9.1.3 Cleaning steps

Please follow the instructions below

1. Dip the cloth with an appropriate amount of fluid
2. Clean the components with the cloth

! Note: Please don't apply any corrosive liquid onto any part of the thermal imager

9.2 Cleaning lenses

9.2.1 Fluid

Please apply the following fluid

1. Commercial lens liquid cleanser containing at least 30% isopropanol

2. 96% alcohol liquid

9.2.2 Cleaning procedures

Please perform the follow the instructions below

1. Dip medical cotton in alcohol
2. Wipe the lenses with soaked medical cotton

!Caution:

1. **Medical cotton is a disposable item. Please don't use it repeatedly**
2. **Clean carefully. The lenses are coated with a delicate anti-reflection layer.**
3. **To avoid damaging the layer, please don't apply excessive force.**

9.3 Cleaning uncooled infrared focal-plane detector

A tiny trace of dust on the IR detector could cause a massive blemish on thermal images. If you were to clean the dust off the detector, please follow below procedures as below:

!Caution

1. **This section is only applicable for thermal imagers with an exposable uncooled infrared focal plane detector;**
2. **Under certain circumstances, uncooled infrared focal plane detector surface must be cleaned by mechanical method, which must be performed by the FOTRIC after-sales department, or FOTRIC-authorized collaborators**

Cleaning procedures:

Please follow the cleaning steps below

1. Take off the lens from the thermal imager

2. Use an air blower to blow away the dust on the detector's surface

! Note: in upon procedure 2, Please do not use any untainted compressed air, such as a high-pressure air source from the workshop.

9.4 Lithium battery maintenance

1. Please do not leave the batteries near a heat source or fire. Avoid direct sunlight
2. Please don't disassembly or squish the batteries
3. If the product is not going to be used for a long time, please take out the battery to prevent possible leakage from the battery damaging the product.
4. Please only use the FOTRIC-authorized power adaptor and charger to charge the batteries.
5. Please keep the batteries in a clean and dry environment.

! Note: to avoid accidents, please do not expose the batteries to a heat source or in a high-temperature environment (ex. In unmonitored cars parked under direct sunlight)

Vocabulary

Absolute zero

Absolute zero refers to the temperature of -273.15°C ($0\text{ Kelvin} = -459.69^{\circ}\text{F}$). Absolute zero is an ideal state, in which all material's atomic movement completely stopped. At this temperature, objects have no thermal energy.

Kelvin [K]

Kelvin is a general temperature unit; an Object of 0 K temperature reaches absolute zero (-273.15°C).

$$273.15\text{ K} = 0^{\circ}\text{C} = 32^{\circ}\text{F} \quad \text{K} = ^{\circ}\text{C} + 273.15$$

Celsius [$^{\circ}\text{C}$]

Celsius is a temperature unit that is widely accepted globally. Under standard atmospheric pressure, water's boiling temperature is defined 100°C , and its melting point is defined 0°C .

$$^{\circ}\text{C} = (^{\circ}\text{F} - 32)/1.8 \quad \text{or} \quad ^{\circ}\text{C} = \text{K} - 273.15$$

Fahrenheit [$^{\circ}\text{F}$]

Fahrenheit is a temperature unit that is widely accepted in North America.

$$^{\circ}\text{F} = (^{\circ}\text{C} \times 1.8) + 32$$

Infrared radiation

Infrared radiation is a form of electromagnetic radiation. Any object with a temperature above absolute zero emits infrared radiation

Absorptivity

Any object can absorb infrared radiation, and the direct result of infrared absorption is temperature rise. Objects with a higher temperature usually emit

more energy than objects with a lower temperature. Infrared radiation an object absorbs is usually transformed into thermal energy of its own and gets re-emitted. Therefore, an object's emissivity is linked to its absorptivity.

Radiation

Any object with a temperature higher than absolute zero is continuously radiating heat in the form of an electromagnetic wave. The capacity of emitting energy is called emissivity.

Conduction

Heat is always transferring from objects with higher temperatures to objects with lower temperatures. Conduction is the primary way of heat transfer in solids.

Convection

The process of transferring heat due to the movement of fluid is called convection and is usually caused by an imbalance of temperature.

Atmospheric windows

A range of wavelengths over which there is relatively little absorption of radiation by atmospheric gases is called 'atmospheric window'. The atmospheric window of the infrared band locates between 7~14 μm , where the atmospheric transmittance is most stable. Therefore, thermal measurement on this window is particularly accurate.

Blackbody radiator

Black body radiator refers to objects that absorb all incident radiation and convert them into their energy to emit outwards, during which process there is no occurrence of either reflection or transmission. A blackbody's emissivity $\epsilon = 1$. A blackbody is an ideal object that does not exist in the real world. Blackbodies used for research and calibration are close approximations with emissivity close to 1 (usually greater than 0.95)

Colored body radiator

A colored body radiator refers to materials whose emissivity changes based on wavelength and temperature difference. An object could have a few different emissivities. Most metals are colored body radiators. (Ex: Aluminum's emissivity rises when heated)

Thermal Imager

Thermal imager refers to devices that can detect radiations of infrared-band wavelength and convert the invisible infrared radiation into visible pictures. Thermal imagers are widely used for temperature measurement and infrared thermal imaging.

IR Detector

An infrared thermal imager's detector can detect thermal radiation and transform it into an electrical signal. The minimum unit of a detector is called 'pixel'

Uncooled Infrared Focal Plane Array (FPA)

In the earlier stage of development, FPA detectors require cryogenic cooling, and their sizes are massive; Nowadays, FPA detectors don't necessarily require cooling and can take on high accuracy measurements. There are two types of FPA sensors: optical readout uncooled focal plane array and electrical readout uncooled focal plane array.

Frame Rate

The unit for frame rate is 'Hertz'. It refers to frequency image refreshes on the thermal imager. Ex: if a thermal imager's refreshing rate is 30 Hz. It means the imager will update 30 complete thermal images in one second

Resolution

Resolution is a parameter for measuring the amount of data in an image. It refers to the number of pixels in a unit length.

Lens

The lens determines the thermal imager's range of field view. A wide-angle

lens can measure the temperature distribution of a larger field, and a telephoto lens can observe finer detail in distance. Germanium, silicon, and zinc selenide are good materials for making camera lenses because they have high infrared transmittance.

Field of View (FOV)

Field of view refers to the vertical and horizontal angle objects project themselves in the thermal imager

MFOV

The MFOV is the minimum pixel range in which a thermal detector can accurately measure temperature. There are two types: MFOV=1, and MFOV=3×3=9。

Thermal Image

Thermal Image displays surface temperature distribution of an object.

By receiving the object's radiation energy, the thermal imager converts pixels' temperature values into visible colors on the matrix coordinates. Each pixel represents a temperature measuring point on the object's surface.

Measurement Range

Measurement Range refers to the temperature range that a thermal imager can accurately measure and record. Outside of the measuring range, the device will neither be able to properly display the information nor guarantee the accuracy of the measurement.

NETD

NETD stands for sensitivity (also known as Noise Equivalent Temperature Difference). It describes the minimal temperature difference the thermal imager can detect. The smaller the NETD, the more sensitive the thermal imager, and the image will be clearer.

Accuracy

It refers to how close the measured result is to the reference. Ex: if the actual temperature of an object surface is 100°C , and the accuracy is $\pm 2^{\circ}\text{C}$, then the measured temperature would be $98^{\circ}\text{C} \text{ --- } 102^{\circ}\text{C}$

Verification

Verification is a process, which compares the measurement result and the object's standard value. Verification is not calibration; Verification records the deviation while calibration corrects the result.

Color Palette

Color Palette determines how an image's color is displayed. Based on different measurement assignments, the thermal imaging display uses different color contrast.

Color Isotherms

This function marks every point of the same temperature with the same color in a certain range. It aids real-time analysis.

Cold spot and Hot spot

The point with the highest temperature in a certain region is called a 'hot spot'. Conversely, the point with the lowest temperature in a certain region is called a 'cold spot'.

Emissivity (ϵ)

Emissivity is a measure of how much radiation is emitted from the object, compared to that from a perfect blackbody of the same temperature. Emissivity is a physical property of a measured object, which determines by its surface characteristics, temperature, and wavelength.

RTC

RTC stands for Reflected Temperature Compensation. Some objects have high reflectivity, which could induce false readings from reflecting thermal radiation of higher temperature objects nearby. In short, when the observed object has

relatively low emissivity, and there are heat sources nearby, it's a good idea to turn on RTC.

Condensation

It refers to the process of gas turning liquid. When an object's surface temperature is lower than the ambient temperature, the moisture in the air will condense into water droplets on the surface.

Dew point

When the temperature reaches a certain point, the unsaturated water vapor in the air will become 100% saturated. The temperature point is called the dew point.

Relative humidity

It is the percentage of absolute humidity of air at a certain temperature, and saturated vapor pressure of water at the same temperature.

Specular reflection

Specular reflection usually occurs on an object surface of high reflectivity or low emissivity. However, the occurrence of specular reflection does not guarantee high reflectivity.

Reflectance (ρ)

It refers to an object's ability to reflect radiant energy. It depends on the material's type, surface characteristics, temperature, and incident wavelength. Generally speaking, smooth and polished surfaces have larger reflectance.

Transmittance (τ)

It refers to a material's ability to transmit radiation. It depends on the material's type and thickness

Heat Transfer Coefficient

It reflects an object's ability to convey heat by convection. Definition: when the temperature difference between fluid and solid surface is 1 k, the amount of energy been conveyed by convection of 1 unit area in a second

Kirchhoff's radiation law

Kirchhoff's radiation law describes the relationship between an object's emissivity and absorptivity of a certain wavelength: at thermal equilibrium, an object's absorptivity of thermal radiation is equal to its emissivity at the same temperature.

Planck's radiation law

Planck's radiation law indicates that energy emitted by a blackbody is dependent on the frequency of the radiation. $E=hf$, 'h' being the Planck's constant and 'f' being the frequency of the radiation.

Stefan-Boltzmann-law

The Stefan-Boltzmann law indicates the total power emitted by a blackbody is proportional to its temperature's fourth power. $W_b = \sigma \cdot e \cdot T^4$.

σ (sigma) = $5.67 \times 10^{-8} \text{W}/(\text{m}^2 \cdot \text{K}^4)$

Emissivity Table

(For reference only)

Material Name	Surface Condition	Temperature (°C)	Emissivity (ϵ)
Aluminum	Non-oxidized	100	0.20
	Oxidized	100	0.55
Brass	Polished brown	20	0.40
	Unpolished	38	0.22
	Oxidized	100	0.61
Copper	Severely oxidized	20	0.78
Iron	Oxidized	100	0.74
	Rusty	25	0.65
Cast iron	Oxidized	200	0.64
	Non-oxidized	100	0.21
Wrought iron	Roughened	25	0.94
	Polished	38	0.28
Nickel	Oxidized	200	0.37
Stainless steel	Oxidized	60	0.85
Steel	Oxidized at 800 C	200	0.79
Common brick	Surface	20	0.93
Concrete	Surface	20	0.92
Glass	Polished plate	20	0.94
Lacquer	White	100	0.92
	Natural color black	100	0.97
Carbon	Smoke black	25	0.95
	Candle soot	20	0.95
	Graphite rough surface	20	0.98
Paint	Average of 16 colors	100	0.94
Paper	White	20	0.93
Sand	Surface	20	0.90
Wood	Polished	20	0.90
Water	Distilled water	20	0.96
Skin	Human	32	0.98
Pottery	Fine	21	0.90
	Abrasive	21	0.93

**Innovation
Excellence
Integrity**

Contact FOTRIC

FOTRIC INC.