

Test Equipment Depot - 800.517.8431 - 99 Washington Street Melrose, MA 02176 - TestEquipmentDepot.com

DATA SHEET

Digital Multimeters

34460A, 34461A, 34465A (6½ digit), 34470A (7½ digit)

Truevolt DMMs for your next generation of insights



 **KEYSIGHT**
TECHNOLOGIES

Table of Contents

Measure with Unquestioned Truevolt Confidence	4
BenchVue Software	5
Measure with Unquestioned Truevolt Confidence	6
Move to The Next-Generation 34401A DMM with 100% Assurance.....	7
Specifications 34460A.....	8
Specifications 34461A.....	10
Specifications 34465A.....	12
Specifications 34470A.....	15
Measurement Characteristics	18
Operating Characteristics.....	19
System Speeds (Nom)	21
General Characteristics	22
Options, Upgrades and Accessories	23
Accessories	24

Keysight's NEW Truevolt Digital Multimeters (DMMs) offer a full range of measurement capabilities and price points with higher levels of accuracy, speed, and resolution.

Get more insight quickly

Truevolt DMM's graphical capabilities such as trend and histogram charts offer more insights quickly. Both models also provide a data logging mode for easier trend analysis and a digitizing mode for capturing transients.

Measure low-power devices

The ability to measure very low current, 1 μ A range with pA resolution, allows you to make measurements on very low power devices.

Maintain calibrated measurements

Auto calibration allows you to compensate for temperature drift so you can maintain measurement accuracy throughout your workday.

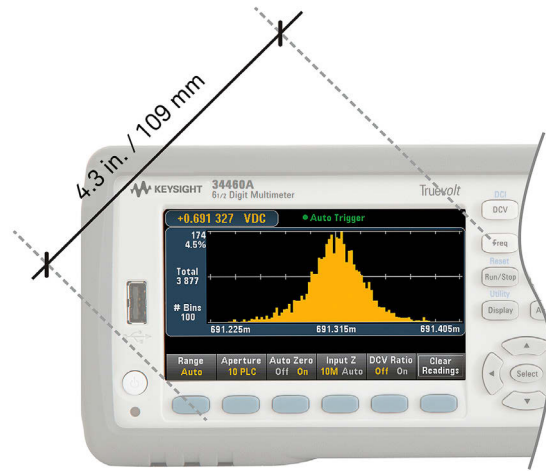

The bright, 4.3" high-resolution monitor is a prominent feature of Keysight's Truevolt DMM family.

Overview of Keysight Truevolt Digital Multimeters

Key specifications	34460A	34461A	34465A	34470A
Digits of resolution	6½	6½	6½	7½
Basic DCV accuracy	75 ppm	35 ppm	30 ppm	16 ppm
Max reading rate	300 rdgs/s	1,000 rdgs/s	50,000 rdgs/s	50,000 rdgs/s
Memory	1,000 rdgs	10,000 rdgs	50,000 rdgs std 2 million rdgs opt	50,000 rdgs std 2 million rdgs opt
Measurements				
DCV	100 mV to 1,000 V	100 mV to 1,000 V	100 mV to 1,000 V	100 mV to 1,000 V
ACV (RMS)	100 mV to 750 V	100 mV to 750 V	100 mV to 750 V	100 mV to 750 V
DCI	100 μ A to 3 A	100 μ A to 10 A	1 μ A to 10 A	1 μ A to 10 A
ACI	100 μ A to 3 A	100 μ A to 10 A	100 μ A to 10 A	100 μ A to 10 A
2- and 4-wire resistance	100 Ω to 100 M Ω	100 Ω to 100 M Ω	100 Ω to 1,000 M Ω	100 Ω to 1,000 M Ω
Continuity, diode	Y, 5 V	Y, 5 V	Y, 5 V	Y, 5 V
Frequency, period	3 Hz to 300 kHz	3 Hz to 300 kHz	3 Hz to 300 kHz	3 Hz to 300 kHz
Temperature	RTD/PT100, thermistor	RTD/PT100, thermistor	RTD/PT100, thermistor, thermocouples	RTD/PT100, thermistor, thermocouples
Capacitance	1.0 nF to 100.0 μ F	1.0 nF to 100.0 μ F	1.0 nF to 100.0 μ F	1.0 nF to 100.0 μ F
Dual line display	Yes	Yes	Yes	Yes
Display	Color, graphical	Color, graphical	Color, graphical	Color, graphical
Statistical graphics	Histogram, bar chart	Histogram, bar chart, trend chart	Histogram, bar chart, trend chart	Histogram, bar chart, trend chart
Rear input terminals	No	Yes	Yes	Yes
IO interface				
USB	Yes	Yes	Yes	Yes
LAN/LXI Core	Optional	Yes	Yes	Yes
GPIB	Optional	Optional	Optional	Optional

Bar meter mode provides the number display along with an analog meter to provide a visual view of your measurements.

Histogram mode gives you a statistical view of your measurements.

Number mode provides the traditional “digits” view of measurements.

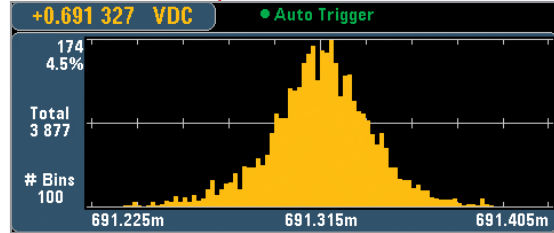
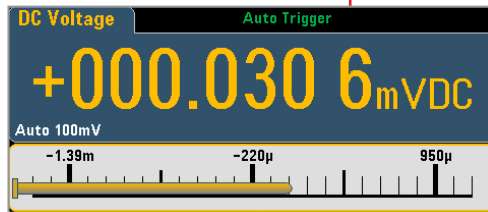
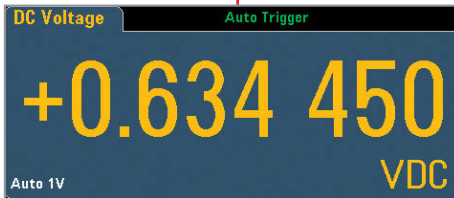

Truevolt

D I S P L A Y

Measure with Unquestioned Truevolt Confidence

Worry about the quality of your design, not the quality of your measurements

In a rack or on a bench real-world signals are never flat. They have some level of AC signal riding on top from power line noise, other environmental noise, or injected current from the meter itself. How well your meter deals with these extraneous factors and eliminates them from the true measurement makes a big difference to your accuracy. Behind the scenes, Keysight's Truevolt technology accounts for measurement errors created by these real-world factors so you can be confident in your measurements and it is only available on Keysight DMMs.

Truevolt technology starts with an analog-to-digital converter that enables a patented metrology-grade architecture. Using this architecture, Keysight delivers a good balance of measurement resolution, linearity, accuracy, and speed at a value price, all derived and guaranteed per ISO/IEC 17025 industry standards.





BenchVue Software

Data capture simplified. Click. Capture. Done.

BenchVue software for the PC makes it simple to connect, control, capture and view Keysight's DMMs simultaneously with other Keysight bench instruments with no additional programming.

- Visualize multiple measurements simultaneously
- Easily log data, screen shots and system state
- Rapidly prototype custom test sequences
- Recall past state of your bench to replicate results
- Export measurement data in desired format fast
- Quickly access manuals, drivers, FAQs and videos
- Monitor and control bench from mobile devices

The Digital Multimeter App within BenchVue enables control of digital multimeters to visualize measurements, perform unrestricted data logging and statistical analysis.

Benefit from a new perspective by visualizing multiple DMM's at the same time

Display single measurements, charts, tables, or histograms from a single instrument or multiple DMMs simultaneously to correlate trends you might otherwise miss.

Record measurements and export results in a few clicks

Log and export data quickly to popular tools such as Microsoft Excel, Microsoft Word and MATLAB for documentation or further analysis.

Access and control tests on your DMM remotely

With the companion BenchVue Mobile app, monitor and respond to long-running tests from anywhere.

1. One hour limit in no-cost version.



Figure 1. See your measurements across instruments in one place to quickly correlate measurement activities and obtain actionable insights.

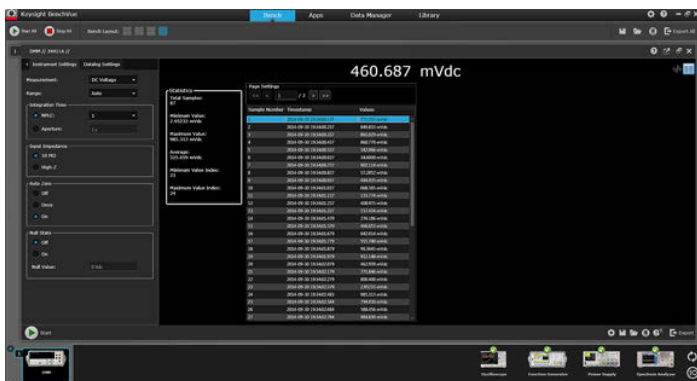
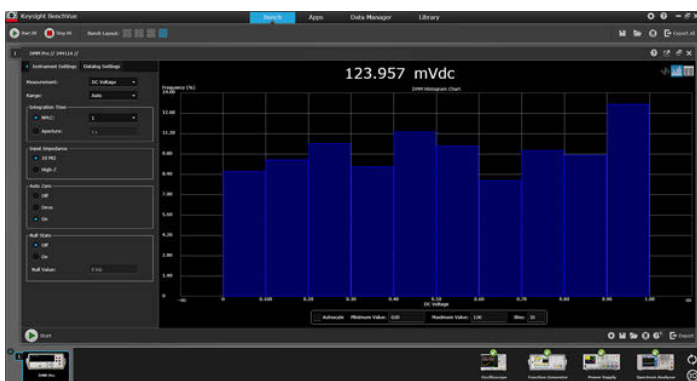
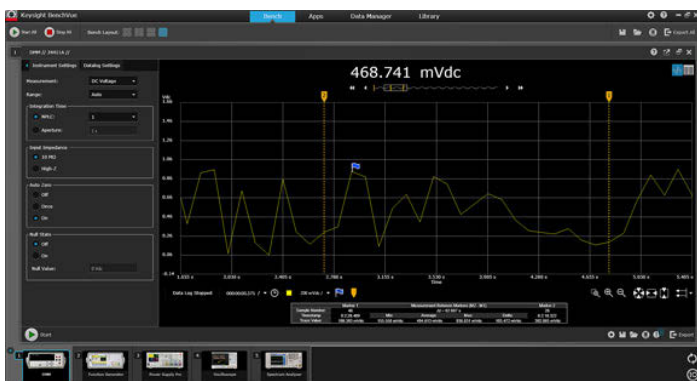

Figure 2. BenchVue enables control of your DMM to data log and visualize measurements in a wide array of display options.

Measure with Unquestioned Truevolt Confidence

What Truevolt technology means to you:

You can measure your real-world signals, not instrument error

Noise and injected current: Keysight Truevolt DMMs contribute less than 30% of the injected current than alternatives. Compared to some lower cost alternatives, Truevolt DMMs offer almost 100% less noise.

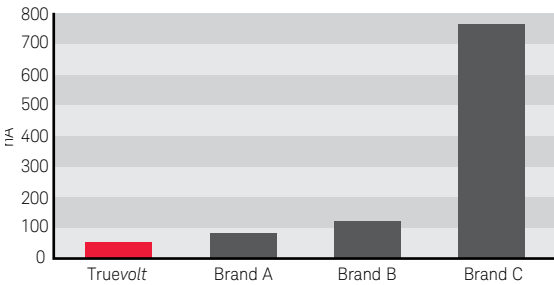

Input bias current: Ideally, no current flows into the measurement terminals of your DMM. In real measurement situations, there are always input currents creating additional measurement errors. Truevolt DMMs take care of input bias current. Some alternative DMMs offer 20% to infinitely poorer performance (some are too noisy to measure).

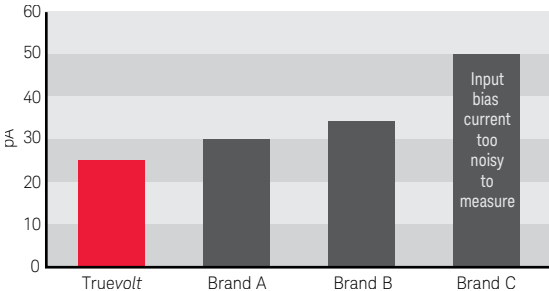

Digital AC rms measurements: For meters in this class, only Keysight uses digital direct sampling techniques to make AC rms measurements. This results in a true rms calculation technique that avoids the slower response of analog RMS converters used in all other vendor's 6½ digit DMMs. This allows for crest factors up to 10 without additional error terms. This is a unique, patented technique – only used by Keysight.

Crest factor: the ratio of the peak value to the RMS value of a waveform

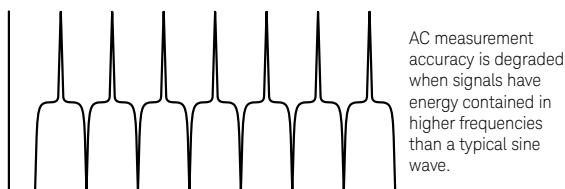
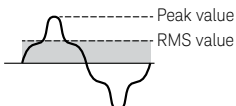

You can measure your real-world signals with confidence

All Truevolt DMM specifications are tested and guaranteed for compliance with ISO/IEC 17025 standards so you can prove the effectiveness of your lab or production line's quality management system. Many lower-cost DMMs in this class do not carry a guarantee of their measurement specifications.



You can take advantage of expanded measurement functionality

Compared to the 34401A DMM, Truevolt DMMs offer expanded current ranges from 100 µA to 10 A. We have also added a temperature measurement function (RTD/PT100, 5 kΩ thermistor). Additionally, diode measurement capability has been expanded to allow a larger full-scale voltage to be measured (5 V) to enable the measurement of more diode types such as LEDs.



Move to The Next-Generation 34401A DMM with 100% ¹ Assurance

Migrate with confidence:
Everything you depend on with
the 34401A and more

Like most 34401A DMM owners, you rely on your DMM and you trust the answers it gives you. Now, with the Keysight Truevolt 34461A DMM, you can get all of the advantages of the 34401A and more. Now you can get faster answers and have even more confidence in your results. The best news of all? You can migrate from the 34401A to the 34461A without a hassle. No need to rewrite your software programs or spend hours learning a brand-new, complicated interface.

Use your existing programs: The 34461A DMM is the industry's only 100% drop-in, SCPI-compatible replacement for the 34401A DMM. Other DMMs may claim 34401A SCPI compatibility, but only a subset of SCPI commands are implemented.

No long learning curve: The Truevolt DMMs were designed by the same team that created the 34401A. The team kept 34401A measurements, reliability and familiarity in mind as they created the Truevolt family of DMMs. So you can use it without spending hours learning how.

The 34461A represents everything you have known and trusted with your Keysight DMM measurements for decades – it just keeps getting stronger.

1. Refer to migration guide 5991-2367EN for compatibility and key programming differences between 34461A and 34401A.

Migration Q&A	Question	Answer
Program compatibility	Will my existing programs still work if I switch to the 34461A?	YES ¹
Measurements	Will I have the same performance so it doesn't affect the results on my line?	YES
Cost	Will it cost the same to buy, use, maintain, and repair?	YES
Reliability	My 34401A never breaks. Are the Truevolt DMMs going to be as good?	YES
Use	Will we be able to use it easily? Quickly?	YES



34461A: The industry's only 100% drop-in, SCPI-compatible replacement for the 34401A DMM.

Specifications 34460A

34460A accuracy specifications: \pm (% of reading + % of range) ¹.
 These specification are compliant to ISO/IEC 17025 for K = 2.



Range ² /frequency	24 hours ³ T _{CAL} \pm 1 °C	90 days T _{CAL} \pm 5 °C	1 year T _{CAL} \pm 5 °C	2 years T _{CAL} \pm 5 °C	Temperature coefficient/°C ⁴	
DC voltage						
100 mV	0.0040 + 0.0060	0.0070 + 0.0065	0.0090 + 0.0065	0.0115 + 0.0065	0.0005 + 0.0005	
1 V	0.0030 + 0.0009	0.0060 + 0.0010	0.0080 + 0.0010	0.0105 + 0.0010	0.0005 + 0.0001	
10 V	0.0025 + 0.0004	0.0050 + 0.0005	0.0075 + 0.0005	0.0100 + 0.0005	0.0005 + 0.0001	
100 V	0.0030 + 0.0006	0.0065 + 0.0006	0.0085 + 0.0006	0.0110 + 0.0006	0.0005 + 0.0001	
1000 V	0.0030 + 0.0006	0.0065 + 0.0010	0.0085 + 0.0010	0.0110 + 0.0010	0.0005 + 0.0001	
True RMS AC voltage ^{2,5,6}						
100 mV, 1 V, 10 V, 100 V, and 750 V ranges						
3 Hz to 5 Hz	1.00 + 0.02	1.00 + 0.03	1.00 + 0.03	1.00 + 0.03	0.100 + 0.003	
5 Hz to 10 Hz	0.38 + 0.02	0.38 + 0.03	0.38 + 0.03	0.38 + 0.03	0.035 + 0.003	
10 Hz to 20 kHz	0.07 + 0.02	0.08 + 0.03	0.09 + 0.03	0.10 + 0.03	0.005 + 0.003	
20 kHz to 50 kHz	0.13 + 0.04	0.14 + 0.05	0.15 + 0.05	0.16 + 0.05	0.011 + 0.005	
50 kHz to 100 kHz	0.58 + 0.08	0.63 + 0.08	0.63 + 0.08	0.63 + 0.08	0.060 + 0.008	
100 kHz to 300 kHz	4.00 + 0.50	4.00 + 0.50	4.00 + 0.50	4.00 + 0.50	0.200 + 0.020	
Resistance ⁷ Test current						
100 Ω	1 mA	0.0040 + 0.0060	0.011 + 0.007	0.014 + 0.007	0.017 + 0.007	0.0006 + 0.0005
1 k Ω	1 mA	0.0030 + 0.0008	0.011 + 0.001	0.014 + 0.001	0.017 + 0.001	0.0006 + 0.0001
10 k Ω	100 μ A	0.0030 + 0.0005	0.011 + 0.001	0.014 + 0.001	0.017 + 0.001	0.0006 + 0.0001
100 k Ω	10 μ A	0.0030 + 0.0005	0.011 + 0.001	0.014 + 0.001	0.017 + 0.001	0.0006 + 0.0001
1 M Ω	5 μ A	0.0030 + 0.0010	0.011 + 0.001	0.014 + 0.001	0.017 + 0.001	0.0010 + 0.0002
10 M Ω	500 nA	0.015 + 0.001	0.020 + 0.001	0.040 + 0.001	0.060 + 0.001	0.0030 + 0.0004
100 M Ω	500 nA 10 M Ω	0.300 + 0.010	0.800 + 0.010	0.800 + 0.010	0.800 + 0.010	0.1500 + 0.0002
DC current Burden voltage						
100 μ A	< 0.011 V	0.010 + 0.020	0.040 + 0.025	0.050 + 0.025	0.060 + 0.025	0.0020 + 0.0030
1 mA	< 0.11 V	0.007 + 0.006	0.030 + 0.006	0.050 + 0.006	0.060 + 0.006	0.0020 + 0.0005
10 mA	< 0.05 V	0.007 + 0.020	0.030 + 0.020	0.050 + 0.020	0.060 + 0.020	0.0020 + 0.0020
100 mA	< 0.5 V	0.010 + 0.004	0.030 + 0.005	0.050 + 0.005	0.060 + 0.005	0.0020 + 0.0005
1 A	< 0.7 V	0.050 + 0.006	0.080 + 0.010	0.100 + 0.010	0.120 + 0.010	0.0050 + 0.0010
3 A	< 2.0 V	0.180 + 0.020	0.200 + 0.020	0.200 + 0.020	0.230 + 0.020	0.0050 + 0.0020
Capacitance ¹⁵						
1.0000 nF		0.50 + 0.50	0.50 + 0.50	0.50 + 0.50	0.50 + 0.50	0.05 + 0.05
10.000 nF		0.40 + 0.10	0.40 + 0.10	0.40 + 0.10	0.40 + 0.10	0.05 + 0.01
100.00 nF		0.40 + 0.10	0.40 + 0.10	0.40 + 0.10	0.40 + 0.10	0.05 + 0.01
1.0000 μ F		0.40 + 0.10	0.40 + 0.10	0.40 + 0.10	0.40 + 0.10	0.05 + 0.01
10.000 μ F		0.40 + 0.10	0.40 + 0.10	0.40 + 0.10	0.40 + 0.10	0.05 + 0.01
100.00 μ F		0.40 + 0.10	0.40 + 0.10	0.40 + 0.10	0.40 + 0.10	0.05 + 0.01

Specifications 34460A (Continued)

Range ² /frequency		24 hours ³ T _{CAL} ± 1 °C	90 days T _{CAL} ± 5 °C	1 year T _{CAL} ± 5 °C	2 years T _{CAL} ± 5 °C	Temperature coefficient/°C ⁴
True RMS AC current^{2, 6, 8}						
Burden voltage						
100 µA, 1 mA, 10 mA, and 100 mA ranges	< 0.011, < 0.11, < 0.05, < 0.5 V					
3 Hz to 5 kHz		0.10 + 0.04	0.10 + 0.04	0.10 + 0.04	0.10 + 0.04	0.015 + 0.006
5 to 10 kHz (typ)		0.10 + 0.04	0.10 + 0.04	0.10 + 0.04	0.10 + 0.04	0.030 + 0.006
1 A range < 0.7 V						
3 Hz to 5 kHz		0.10 + 0.04	0.10 + 0.04	0.10 + 0.04	0.10 + 0.04	0.015 + 0.006
5 to 10 kHz (typ)		0.10 + 0.04	0.10 + 0.04	0.10 + 0.04	0.10 + 0.04	0.030 + 0.006
3 A range < 2.0 V						
3 Hz to 5 kHz		0.23 + 0.04	0.23 + 0.04	0.23 + 0.04	0.23 + 0.04	0.015 + 0.006
5 to 10 kHz (typ)		0.23 + 0.04	0.23 + 0.04	0.23 + 0.04	0.23 + 0.04	0.030 + 0.006
Continuity						
1 kΩ		0.002 + 0.030	0.008 + 0.030	0.010 + 0.030	0.012 + 0.030	0.0010 + 0.0020
Diode test⁹						
5 V		0.002 + 0.030	0.008 + 0.030	0.010 + 0.030	0.012 + 0.030	0.0010 + 0.0020
DC ratio (typ)		(normalized input accuracy) + (normalized reference accuracy)				
Temperature¹⁰						
PT100 (DIN/IEC 751)		Probe accuracy + 0.05 °C				
5 kΩ thermistor		Probe accuracy + 0.1 °C				
Frequency: specification ± (% of reading)^{11, 12}						
100 mV, 1 V, 10 V, 100 V, and 750 V ranges¹³						
3 Hz to 10 Hz		0.100	0.100	0.100	0.100	0.0002
10 Hz to 100 Hz		0.030	0.030	0.030	0.035	0.0002
100 Hz to 1 kHz		0.030	0.010	0.012	0.017	0.0002
1 Hz to 300 kHz		0.002	0.008	0.012	0.017	0.0002
Square wave ¹⁴		0.001	0.008	0.012	0.017	0.0002
Additional gate time errors ± (% of reading)^{12, 10}						
Frequency		1 second	0.1 second	0.01 second		
3 Hz to 40 Hz		0	0.200	0.200		
40 Hz to 100 Hz		0	0.060	0.200		
100 Hz to 1 kHz		0	0.020	0.200		
1 Hz to 300 kHz		0	0.004	0.030		
Square wave ¹⁴		0	0	0		

- For DC: Specifications are for 60-minute warm-up, aperture of 10 or 100 NPLC, and auto zero on. For AC: Specifications are for 60-minute warm-up, slow AC filter, sine wave.
- 20% overrange on all ranges, except 1,000 V DCV, 750 ACV, 3 A AC, and diode test.
- Relative to calibration standards.
- Add this for each °C outside T_{CAL} ± 5 °C.
- Specifications are for sine wave input > 0.3% of range and > 1 mVrms. 750 ACV range limited to 8 × 10⁷ Volt-Hz.
- Low-frequency performance: three filter settings are available: 3 Hz, 20 Hz, 200 Hz. Frequencies greater than these filter settings are specified with no additional errors.
- Specifications are for 4-wire ohms function or 2-wire ohms using math null for offset. Without math null, add 0.2 Ω additional error in 2-wire ohms function.
- Specifications are for sinewave input > 1% of range and > 10 µA AC.
- Specifications are for the voltage measured at the input terminals. The 1 mA test current is typical. Variation in the current source will create some variation in the voltage drop across a diode junction.
- Actual measurement range and probe errors will be limited by the selected probe. Probe accuracy adder includes all measurement and ITS-90 temperature conversion errors PT100 R_o settable to 100 Ω ± 5 Ω to remove the initial probe error.
- Specifications are for 60-minute warm-up and sine wave input unless stated otherwise. Specifications are for 1-second gate time (7 digits).
- Applies to sine and square inputs ≥ 100 mV. For 10 mV to < 100 mV inputs, multiply % of reading error x10.
- Amplitude 10% to 120% of range and less than 750 ACV.
- Square wave input specified for 10 to 300 kHz.
- Specifications are for using Math Null zeroing. High dissipation factor capacitors may show different results than a single frequency measurement. Film capacitors usually have lower dissipation factors than other dielectrics.

Specifications 34461A

34461A accuracy specifications: \pm (% of reading + % of range) ¹.
 These specification are compliant to ISO/IEC 17025 for K = 2.



Range ² /frequency	24 hours ³ $T_{CAL} \pm 1^\circ C$	90 days $T_{CAL} \pm 5^\circ C$	1 year $T_{CAL} \pm 5^\circ C$	2 years $T_{CAL} \pm 5^\circ C$	Temperature coefficient/ $^\circ C$ ⁴	
DC voltage						
100 mV	0.0030 + 0.0030	0.0040 + 0.0035	0.0050 + 0.0035	0.0065 + 0.0035	0.0005 + 0.0005	
1 V	0.0020 + 0.0006	0.0030 + 0.0007	0.0040 + 0.0007	0.0055 + 0.0007	0.0005 + 0.0001	
10 V	0.0015 + 0.0004	0.0020 + 0.0005	0.0035 + 0.0005	0.0050 + 0.0005	0.0005 + 0.0001	
100 V	0.0020 + 0.0006	0.0035 + 0.0006	0.0045 + 0.0006	0.0060 + 0.0006	0.0005 + 0.0001	
1000 V	0.0020 + 0.0006	0.0035 + 0.0010	0.0045 + 0.0010	0.0060 + 0.0010	0.0005 + 0.0001	
True RMS AC voltage ^{2, 5, 6}						
100 mV, 1 V, 10 V, 100 V, and 750 V ranges						
3 Hz to 5 Hz	1.00 + 0.02	1.00 + 0.03	1.00 + 0.03	1.00 + 0.03	0.100 + 0.003	
5 Hz to 10 Hz	0.35 + 0.02	0.35 + 0.03	0.35 + 0.03	0.35 + 0.03	0.035 + 0.003	
10 Hz to 20 kHz	0.04 + 0.02	0.05 + 0.03	0.06 + 0.03	0.07 + 0.03	0.005 + 0.003	
20 kHz to 50 kHz	0.10 + 0.04	0.11 + 0.05	0.12 + 0.05	0.13 + 0.05	0.011 + 0.005	
50 kHz to 100 kHz	0.55 + 0.08	0.60 + 0.08	0.60 + 0.08	0.60 + 0.08	0.060 + 0.008	
100 kHz to 300 kHz	4.00 + 0.50	4.00 + 0.50	4.00 + 0.50	4.00 + 0.50	0.200 + 0.020	
Resistance ⁷ Test current						
100 Ω	1 mA	0.0030 + 0.0030	0.008 + 0.004	0.010 + 0.004	0.012 + 0.004	0.0006 + 0.0005
1 k Ω	1 mA	0.0020 + 0.0005	0.008 + 0.001	0.010 + 0.001	0.012 + 0.001	0.0006 + 0.0001
10 k Ω	100 μA	0.0020 + 0.0005	0.008 + 0.001	0.010 + 0.001	0.012 + 0.001	0.0006 + 0.0001
100 k Ω	10 μA	0.0020 + 0.0005	0.008 + 0.001	0.010 + 0.001	0.012 + 0.001	0.0006 + 0.0001
1 M Ω	5 μA	0.002 + 0.001	0.008 + 0.001	0.010 + 0.001	0.012 + 0.001	0.0010 + 0.0002
10 M Ω	500 nA	0.015 + 0.001	0.020 + 0.001	0.040 + 0.001	0.060 + 0.001	0.0030 + 0.0004
100 M Ω	500 nA 10 M Ω	0.300 + 0.010	0.800 + 0.010	0.800 + 0.010	0.800 + 0.010	0.1500 + 0.0002
DC current Burden voltage						
100 μA	< 0.011 V	0.010 + 0.020	0.040 + 0.025	0.050 + 0.025	0.060 + 0.025	0.0020 + 0.0030
1 mA	< 0.11 V	0.007 + 0.006	0.030 + 0.006	0.050 + 0.006	0.060 + 0.006	0.0020 + 0.0005
10 mA	< 0.05 V	0.007 + 0.020	0.030 + 0.020	0.050 + 0.020	0.060 + 0.020	0.0020 + 0.0020
100 mA	< 0.5 V	0.010 + 0.004	0.030 + 0.005	0.050 + 0.005	0.060 + 0.005	0.0020 + 0.0005
1 A	< 0.7 V	0.050 + 0.006	0.080 + 0.010	0.100 + 0.010	0.120 + 0.010	0.0050 + 0.0010
3 A	< 2.0 V	0.180 + 0.020	0.200 + 0.020	0.200 + 0.020	0.230 + 0.020	0.0050 + 0.0020
10 A ⁸	< 0.5 V	0.050 + 0.010	0.120 + 0.010	0.120 + 0.010	0.150 + 0.010	0.0050 + 0.0010
Capacitance ¹⁵						
1.0000 nF		0.50 + 0.50	0.50 + 0.50	0.50 + 0.50	0.50 + 0.50	0.05 + 0.05
10.000 nF		0.40 + 0.10	0.40 + 0.10	0.40 + 0.10	0.40 + 0.10	0.05 + 0.01
100.00 nF		0.40 + 0.10	0.40 + 0.10	0.40 + 0.10	0.40 + 0.10	0.05 + 0.01
1.0000 μF		0.40 + 0.10	0.40 + 0.10	0.40 + 0.10	0.40 + 0.10	0.05 + 0.01
10.000 μF		0.40 + 0.10	0.40 + 0.10	0.40 + 0.10	0.40 + 0.10	0.05 + 0.01
100.00 μF		0.40 + 0.10	0.40 + 0.10	0.40 + 0.10	0.40 + 0.10	0.05 + 0.01

Specifications 34461A (Continued)

Range ² /frequency	24 hours ³ T _{CAL} ± 1 °C	90 days T _{CAL} ± 5 °C	1 year T _{CAL} ± 5 °C	2 years T _{CAL} ± 5 °C	Temperature coefficient/°C ⁴
True RMS AC current ^{2, 6, 9}	Burden voltage				
100 µA, 1 mA, 10 mA, and 100 mA ranges	< 0.011, < 0.11, < 0.05, < 0.5 V				
3 Hz to 5 kHz	0.10 + 0.04	0.10 + 0.04	0.10 + 0.04	0.10 + 0.04	0.015 + 0.006
5 to 10 kHz (typ)	0.10 + 0.04	0.10 + 0.04	0.10 + 0.04	0.10 + 0.04	0.030 + 0.006
1 A range	< 0.7 V				
3 Hz to 5 kHz	0.10 + 0.04	0.10 + 0.04	0.10 + 0.04	0.10 + 0.04	0.015 + 0.006
5 to 10 kHz (typ)	0.10 + 0.04	0.10 + 0.04	0.10 + 0.04	0.10 + 0.04	0.030 + 0.006
3 A range	< 2.0 V				
3 Hz to 5 kHz	0.23 + 0.04	0.23 + 0.04	0.23 + 0.04	0.23 + 0.04	0.015 + 0.006
5 to 10 kHz (typ)	0.23 + 0.04	0.23 + 0.04	0.23 + 0.04	0.23 + 0.04	0.030 + 0.006
10 A range ⁸	< 0.5 V				
3 Hz to 5 kHz	0.15 + 0.04	0.15 + 0.04	0.15 + 0.04	0.15 + 0.04	0.015 + 0.006
5 to 10 kHz (typ)	0.15 + 0.04	0.15 + 0.04	0.15 + 0.04	0.15 + 0.04	0.030 + 0.006
Continuity					
1 kΩ	0.002 + 0.030	0.008 + 0.030	0.010 + 0.030	0.012 + 0.030	0.0010 + 0.0020
Diode test ¹⁰					
5 V	0.002 + 0.030	0.008 + 0.030	0.010 + 0.030	0.012 + 0.030	0.0010 + 0.0020
DC ratio (typ)					
(normalized input accuracy) + (normalized reference accuracy)					
Temperature ¹¹					
PT100 (DIN/ IEC 751)	Probe accuracy + 0.05 °C				
5 kΩ thermistor	Probe accuracy + 0.1 °C				
Frequency: specification ± (% of reading) ^{12, 13}					
100 mV, 1 V, 10 V, 100 V, and 750 V ranges ¹⁴					
3 to 10 Hz	0.100	0.100	0.100	0.100	0.100
10 to 100 Hz	0.030	0.030	0.030	0.030	0.035
100 Hz to 1 kHz	0.003	0.008	0.010	0.010	0.015
1 to 300 kHz	0.002	0.006	0.010	0.010	0.015
Square wave ¹⁵	0.001	0.006	0.010	0.010	0.015
Additional gate time errors ±(% of reading) ¹³					
Frequency	1 second	0.1 second	0.01 second		
3 Hz to 40 Hz	0	0.200	0.200		
40 Hz to 100 Hz	0	0.060	0.200		
100 Hz to 1 kHz	0	0.020	0.200		
1 kHz to 300 kHz	0	0.004	0.030		
Square wave ¹⁵	0	0	0		

- For DC: Specifications are for 60-minute warm-up, aperture of 10 or 100 NPLC, and auto zero on. For AC: Specifications are for 60-minute warm-up, slow AC filter, sine wave.
- 20% over range on all ranges, except 1,000 V DCV, 750 ACV, 10 A DC, 3 A AC, 10 A AC, and diode test.
- Relative to calibration standards.
- Add this for each °C outside TCAL ± 5 °C.
- Specifications are for sinewave input > 0.3% of range and > 1 mVrms. 750 ACV range limited to 8 x 10⁷ Volt-Hz.
- Low-frequency performance: three filter settings are available: 3 Hz, 20 Hz, 200 Hz. Frequencies greater than these filter settings are specified with no additional errors.
- Specifications are for 4-wire ohms function or 2-wire ohms using math null for offset. Without math null, add 0.2 Ω additional error in 2-wire ohms function.
- The 10 A range is only available on a separate front-panel connector. Add 2 mA base per amp or inputs > 5 A rms.
- Specifications are for sinewave input > 1% of range and > 10 µA AC.
- Specifications are for the voltage measured at the input terminals. The 1 mA test current is typical. Variation in the current source will create some variation in the voltage drop across a diode junction.
- Actual measurement range and probe errors will be limited by the selected probe. Probe accuracy adder includes all measurement and ITS-90 temperature conversion errors. PT100 Ro settable to 100 Ω ± 5 Ω to remove the initial probe error.
- Specifications are for 60-minute warm-up and sine wave input unless stated otherwise. Specifications are for 1-second gate time (7-digits).
- Applies to sine and square inputs ≥ 100 mV. For 10 mV to < 100 mV inputs, multiply % of reading error x10.
- Amplitude 10% to 120% of range and less than 750 ACV.
- Square wave input specified for 10 to 300 kHz.

Specifications 34465A

34465A accuracy specifications: $\pm(\% \text{ of reading} + \% \text{ of range})^1$.
DC voltage and resistance. Automatic calibration (ACAL) capable.

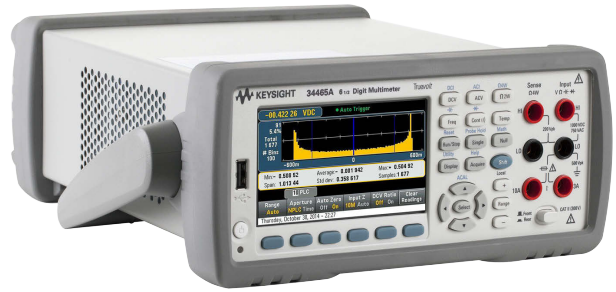

Range ²	24 hours ³ $T_{ACAL} \pm 1^\circ C$	90 days $T_{ACAL} \pm 2^\circ C$	1 year $T_{ACAL} \pm 2^\circ C$	2 years $T_{ACAL} \pm 2^\circ C$	Non ACAL ⁶ Temperature coefficient/ $^\circ C$	With ACAL ⁷ Temperature coefficient/ $^\circ C$
DC voltage						
100 mV	0.0030 + 0.0030	0.0040 + 0.0035	0.0050 + 0.0035	0.0065 + 0.0035	0.0005 + 0.0005	0.0002 + 0.0005
1 V	0.0015 + 0.0004	0.0025 + 0.0004	0.0035 + 0.0004	0.0050 + 0.0004	0.0005 + 0.0001	0.0002 + 0.0001
10 V	0.0010 + 0.0003	0.0020 + 0.0004	0.0030 + 0.0004	0.0045 + 0.0004	0.0005 + 0.0001	0.0002 + 0.0001
100 V	0.0020 + 0.0006	0.0035 + 0.0006	0.0040 + 0.0006	0.0055 + 0.0006	0.0005 + 0.0001	0.0002 + 0.0001
1000 V ⁹	0.0020 + 0.0006	0.0035 + 0.0006	0.0040 + 0.0006	0.0055 + 0.0006	0.0005 + 0.0001	0.0002 + 0.0001
Resistance ⁸						
100 Ω	0.0030 + 0.0030	0.0050 + 0.0040	0.0060 + 0.0040	0.0070 + 0.0040	0.0006 + 0.0005	0.0002 + 0.0005
1 K Ω	0.0020 + 0.0005	0.0030 + 0.0005	0.0040 + 0.0005	0.0050 + 0.0005	0.0006 + 0.0001	0.0002 + 0.0001
10 K Ω	0.0020 + 0.0005	0.0030 + 0.0005	0.0040 + 0.0005	0.0050 + 0.0005	0.0006 + 0.0001	0.0002 + 0.0001
100 K Ω	0.0020 + 0.0005	0.0030 + 0.0005	0.0040 + 0.0005	0.0050 + 0.0005	0.0006 + 0.0001	0.0002 + 0.0001
1 M Ω	0.0020 + 0.0005	0.0060 + 0.0005	0.0070 + 0.0005	0.0080 + 0.0005	0.0010 + 0.0002	0.0002 + 0.0002
10 M Ω	0.010 + 0.001	0.020 + 0.001	0.025 + 0.001	0.030 + 0.001	0.0030 + 0.0004	0.0030 + 0.0004
100 M Ω	0.100 + 0.001	0.200 + 0.001	0.300 + 0.001	0.400 + 0.001	0.1000 + 0.0001	0.0100 + 0.0001
1000 M Ω	2.000 + 0.001	2.000 + 0.001	3.000 + 0.001	4.000 + 0.001	1.0000 + 0.0001	0.1000 + 0.0001
Range ²	24 hours ³ $T_{CAL} \pm 1^\circ C$	90 days $T_{CAL} \pm 5^\circ C$	1 year $T_{CAL} \pm 5^\circ C$	2 years $T_{CAL} \pm 5^\circ C$	Temperature coefficient/ $^\circ C$ ⁵	
DC current						
1 μA (typ)		0.007 + 0.005	0.030 + 0.005	0.050 + 0.005	0.060 + 0.005	0.0020 + 0.0010
10 μA (typ)		0.007 + 0.002	0.030 + 0.002	0.050 + 0.002	0.060 + 0.002	0.0015 + 0.0006
100 μA (typ)		0.007 + 0.001	0.030 + 0.001	0.050 + 0.001	0.060 + 0.001	0.0015 + 0.0004
1 mA		0.007 + 0.003	0.030 + 0.005	0.050 + 0.005	0.060 + 0.005	0.0015 + 0.0005
10 mA		0.007 + 0.020	0.030 + 0.020	0.050 + 0.020	0.060 + 0.020	0.0020 + 0.0020
100 mA		0.010 + 0.004	0.030 + 0.005	0.050 + 0.005	0.060 + 0.005	0.0020 + 0.0005
1 A		0.050 + 0.006	0.070 + 0.010	0.080 + 0.010	0.100 + 0.010	0.0050 + 0.0010
3 A		0.180 + 0.020	0.200 + 0.020	0.200 + 0.020	0.230 + 0.020	0.0050 + 0.0020
10 A ⁴		0.050 + 0.010	0.120 + 0.010	0.120 + 0.010	0.150 + 0.010	0.0050 + 0.0010
Continuity						
1 K Ω		0.002 + 0.010	0.008 + 0.020	0.010 + 0.020	0.012 + 0.020	0.0010 + 0.0020
Diode test ¹⁰						
5 V		0.002 + 0.010	0.008 + 0.010	0.010 + 0.010	0.012 + 0.020	0.0010 + 0.0010
DC:DC ratio (typ) ¹²						
(normalized input accuracy) + (normalized reference accuracy)						

Specifications 34465A (Continued)

Temperature					
PT100 (DIN/ IEC 751) ¹³	Probe accuracy + 0.05 °C				
5 kΩ thermistor	Probe accuracy + 0.1 °C				
K, J, T, E, N thermocouples ¹⁴	Probe accuracy + reference junction accuracy + 0.3 °C				
R thermocouples ¹⁴ (250 to 1760°C)	Probe accuracy + reference junction accuracy + 0.5 °C				
True RMS AC voltage ^{15, 16}	24 hours ³ T_{CAL} ± 1 °C	90 days T_{CAL} ± 5 °C	1 year T_{CAL} ± 5 °C	2 years T_{CAL} ± 5 °C	Temperature coefficient/°C ⁵
100 mV, 1 V, 10 V, 100 V, and 750 V ranges					
3 Hz to 5 Hz	0.50 + 0.02	0.50 + 0.02	0.50 + 0.02	0.50 + 0.02	0.010 + 0.003
5 Hz to 10 Hz	0.10 + 0.02	0.10 + 0.02	0.10 + 0.02	0.11 + 0.02	0.008 + 0.003
10 Hz to 20 kHz	0.02 + 0.02	0.04 + 0.02	0.05 + 0.02	0.06 + 0.02	0.007 + 0.003
20 kHz to 50 kHz	0.05 + 0.03	0.06 + 0.03	0.07 + 0.03	0.08 + 0.03	0.010 + 0.005
50 kHz to 100 kHz	0.15 + 0.05	0.15 + 0.05	0.15 + 0.05	0.15 + 0.05	0.060 + 0.008
100 kHz to 300 kHz	1.00 + 0.1	1.00 + 0.1	1.00 + 0.1	1.00 + 0.1	0.200 + 0.020
True RMS AC current ^{16, 17}					
100 μA, 1 mA, 10 mA, 100 mA, 1 A ranges					
3 Hz to 5 kHz	0.07 + 0.04	0.09 + 0.04	0.10 + 0.04	0.10 + 0.04	0.015 + 0.006
5 kHz to 10 kHz (typ)	0.10 + 0.04	0.10 + 0.04	0.10 + 0.04	0.10 + 0.04	0.030 + 0.006
3 A range					
3 Hz to 5 kHz	0.23 + 0.04	0.23 + 0.04	0.23 + 0.04	0.23 + 0.04	0.015 + 0.006
5 kHz to 10 kHz (typ)	0.23 + 0.04	0.23 + 0.04	0.23 + 0.04	0.23 + 0.04	0.030 + 0.006
10 A range ⁴					
3 Hz to 5 kHz	0.10 + 0.04	0.15 + 0.04	0.15 + 0.04	0.15 + 0.04	0.015 + 0.006
5 kHz to 10 kHz (typ)	0.15 + 0.04	0.15 + 0.04	0.15 + 0.04	0.15 + 0.04	0.030 + 0.006
Capacitance ²¹					
1.0000 nF	0.50 + 0.50	0.50 + 0.50	0.50 + 0.50	0.50 + 0.50	0.05 + 0.05
10.000 nF	0.40 + 0.10	0.40 + 0.10	0.40 + 0.10	0.40 + 0.10	0.05 + 0.01
100.00 nF	0.40 + 0.10	0.40 + 0.10	0.40 + 0.10	0.40 + 0.10	0.05 + 0.01
1.0000 μF	0.40 + 0.10	0.40 + 0.10	0.40 + 0.10	0.40 + 0.10	0.05 + 0.01
10.000 μF	0.40 + 0.10	0.40 + 0.10	0.40 + 0.10	0.40 + 0.10	0.05 + 0.01
100.00 μF	0.40 + 0.10	0.40 + 0.10	0.40 + 0.10	0.40 + 0.10	0.05 + 0.01
Frequency ^{18, 20}					
100 mV, 1 V, 10 V, 100 V, and 750 V ranges ²⁰					
3 Hz to 10 Hz	0.070	0.070	0.070	0.070	0.0002
10 Hz to 100 Hz	0.030	0.030	0.030	0.030	0.0002
100 Hz to 1 kHz	0.003	0.006	0.007	0.010	0.0002
1 kHz to 300 kHz	0.002	0.005	0.007	0.009	0.0002
Square wave ¹⁸	0.001	0.004	0.006	0.008	0.0002
Additional frequency errors ± (% of reading) ¹⁸					
Aperture (resolution/range)	1 second (0.1 ppm)	0.1 second (1 ppm)	0.01 second (10 ppm)	0.001 second (100 ppm)	
3 Hz to 40 Hz	0	0.100	0.160	0.160	
40 Hz to 100 Hz	0	0.030	0.160	0.160	
100 Hz to 1 kHz	0	0.020	0.200	0.200	
1 kHz to 300 kHz	0	0.004	0.030	0.240	
Square wave ¹⁸	0	0.000	0.000	0.003	

Specifications 34465A (Continued)

DC and AC current burden voltage at full scale	
DC current range	Burden voltage
1 μ A	< 0.0011 V
10 μ A	< 0.011 V
100 μ A	< 0.11 V
1 mA	< 0.11 V
10 mA	< 0.027 V
100 mA	< 0.27 V
1 A	< 0.7 V/0.05 V ²¹
3 A	< 2.0 V/0.15 V ²¹
10 A	< 0.5 V

Digitizing²²

Typical performance for these conditions: Sample rate: 50 kHz (Aperture = 20 μ S); Sine wave input: V_{peak} = Full scale of range; Input frequency: 1 kHz/10 kHz

Function: Range	Spur-free range SFDR	THD + noise SNDR	BW (-3 db)
DCV: 0.1, 1 V	79/60	75/57	15 kHz
DCV: 10 V	86/59	82/58	15 kHz
DCV: 100, 1000 V	64/42	60/42	15 kHz
DCI: 0.1, 1 mA	78/62	75/60	10 kHz
DCI: 10, 100 mA	78/62	67/60	10 kHz
DCI: 1 to 10 A	65/49	63/48	10 kHz

- Specifications are for 60-minute warm-up, integration setting of 10 or 100 NPLC, auto-zero on, AC slow filter. ACAL run within the last 2 days.
- 20% over range on all ranges, except 1000 DCV, 750 ACV, 10 DCA, 3 DCA, 10 ACA, 3 ACA, and diode test have 0%.
- Relative to calibration standards.
- The 10 A range is only available on a separate front panel connector. Add 2 mA per amp for inputs greater than 5 Arms.
- Add this for each °C outside TCAL $\pm 5^{\circ}$ C.
- Add this for each °C outside the last ACAL $\pm 2^{\circ}$ C.
- Add this for each °C outside ACAL $\pm 2^{\circ}$ C.
- Specifications are for 4-wire ohms function or 2-wire ohms using math null for offset. Without math null, add 0.2 Ω additional error in 2-wire ohms function. The 100 M and 1 G ohm ranges are 2-wire only. See the manual for low power ohms specification and measurement currents
- For each additional volt over ± 500 V add 0.02 mV of error.
- Specifications are for the voltage measured at the input terminals. The 1 mA test current is typical. Variation in the current source will create some variation in the voltage drop across a diode junction.
- See user manual for details.
- Actual measurement range and probe errors will be limited by the selected probe. Probe accuracy adder includes all measurement and ITS-90 temperature conversion errors. PT100 Ro settable to 100 $\Omega \pm 5 \Omega$ to remove the initial probe error.
- The internal reference junction uses the U1180A or equivalent adapter. This has a typical performance of $\pm 1.0^{\circ}$ C. This internal reference junction can be adjusted for better accuracy. An external reference junction can also be used.
- Specifications are for sinewave input > 0.3% of range and > 1 mVrms. 750 ACV range limited to 8 x 10⁷ Volt-Hz. For each additional volt over 300 Vrms add 1 mVrms of error.
- Low-frequency performance: three filter settings are available: 3 Hz, 20 Hz, 200 Hz. Frequencies greater than these filter settings are specified with no additional errors.
- Specifications are for sinewave input > 1% of range and > 10 μ Arms.
- Specifications are for sine wave input unless stated otherwise.
- Square wave input specified for 10 Hz– 300 kHz for 1 second aperture. For shorter apertures the minimum frequency requires > 2 cycles.
- Input > 100 mV. For 10 mV to 100 mV inputs, multiply % of reading error x10. Amplitude 10 – 120% of range except 14 – 100% for the 750 ACV range. Specifications are for 1-second gate time (7-digits).
- Specifications are for using Math Null zeroing. High dissipation factor capacitors may show different results than a single frequency measurement. Film capacitors usually have lower dissipation factors than other dielectrics.
- The second burden voltage can be obtained by using the 10 A input range.
- Sample rate (actual): 50.118 kHz (Aperture = 19.953 μ s).

Specifications 34470A

34470A accuracy specifications: \pm (% of reading + % of range) ¹.
DC voltage and resistance. Automatic calibration (ACAL) capable.



Range ²	24 hours ³ $T_{ACAL} \pm 1^\circ C$	90 days $T_{ACAL} \pm 5^\circ C$	1 year $T_{ACAL} \pm 5^\circ C$	2 years $T_{ACAL} \pm 5^\circ C$	Non ACAL ⁶ Temperature coefficient/ $^\circ C$	With ACAL ⁷ Temperature coefficient/ $^\circ C$
DC voltage						
100 mV	0.0030 + 0.0030	0.0040 + 0.0035	0.0040 + 0.0035	0.0045 + 0.0035	0.0005 + 0.0005	0.0001 + 0.0005
1 V	0.0010 + 0.0004	0.0015 + 0.0004	0.0020 + 0.0004	0.0025 + 0.0004	0.0005 + 0.0001	0.0001 + 0.0001
10 V	0.0008 + 0.0002	0.0013 + 0.0002	0.0016 + 0.0002	0.0020 + 0.0002	0.0005 + 0.0001	0.0001 + 0.0001
100 V	0.0020 + 0.0006	0.0032 + 0.0006	0.0038 + 0.0006	0.0040 + 0.0006	0.0005 + 0.0001	0.0001 + 0.0001
1000 V ⁹	0.0020 + 0.0006	0.0032 + 0.0006	0.0038 + 0.0006	0.0040 + 0.0006	0.0005 + 0.0001	0.0001 + 0.0001
Resistance ⁸						
100 Ω	0.0030 + 0.0030	0.0050 + 0.0040	0.0060 + 0.0040	0.0070 + 0.0040	0.0006 + 0.0005	0.0002 + 0.0005
1 K Ω	0.0020 + 0.0005	0.0030 + 0.0005	0.0040 + 0.0005	0.0050 + 0.0005	0.0006 + 0.0001	0.0002 + 0.0001
10 K Ω	0.0020 + 0.0005	0.0030 + 0.0005	0.0040 + 0.0005	0.0050 + 0.0005	0.0006 + 0.0001	0.0002 + 0.0001
100 K Ω	0.0020 + 0.0005	0.0030 + 0.0005	0.0040 + 0.0005	0.0050 + 0.0005	0.0006 + 0.0001	0.0002 + 0.0001
1 M Ω	0.0020 + 0.0005	0.0060 + 0.0005	0.0070 + 0.0005	0.0080 + 0.0005	0.0010 + 0.0002	0.0002 + 0.0002
10 M Ω	0.010 + 0.001	0.020 + 0.001	0.025 + 0.001	0.030 + 0.001	0.0030 + 0.0004	0.0030 + 0.0004
100 M Ω	0.100 + 0.001	0.200 + 0.001	0.300 + 0.001	0.400 + 0.001	0.1000 + 0.0001	0.0100 + 0.0001
1000 M Ω	2.000 + 0.001	2.000 + 0.001	3.000 + 0.001	4.000 + 0.001	1.0000 + 0.0001	0.1000 + 0.0001
Range ²		24 hours ³ $T_{CAL} \pm 1^\circ C$	90 days $T_{CAL} \pm 5^\circ C$	1 year $T_{CAL} \pm 5^\circ C$	2 years $T_{CAL} \pm 5^\circ C$	Temperature coefficient/ $^\circ C$ ⁵
DC current						
1 μA (typ)		0.007 + 0.005	0.030 + 0.005	0.050 + 0.005	0.060 + 0.005	0.0020 + 0.0010
10 μA (typ)		0.007 + 0.002	0.030 + 0.002	0.050 + 0.002	0.060 + 0.002	0.0015 + 0.0006
100 μA (typ)		0.007 + 0.001	0.030 + 0.001	0.050 + 0.001	0.060 + 0.001	0.0015 + 0.0004
1 mA		0.007 + 0.003	0.030 + 0.005	0.050 + 0.005	0.060 + 0.005	0.0015 + 0.0005
10 mA		0.007 + 0.020	0.030 + 0.020	0.050 + 0.020	0.060 + 0.020	0.0020 + 0.0020
100 mA		0.010 + 0.004	0.030 + 0.005	0.050 + 0.005	0.060 + 0.005	0.0020 + 0.0005
1 A		0.050 + 0.006	0.070 + 0.010	0.080 + 0.010	0.100 + 0.010	0.0050 + 0.0010
3 A		0.180 + 0.020	0.200 + 0.020	0.200 + 0.020	0.230 + 0.020	0.0050 + 0.0020
10 A ⁴		0.050 + 0.010	0.120 + 0.010	0.120 + 0.010	0.150 + 0.010	0.0050 + 0.0010
Continuity						
1 K Ω		0.002 + 0.010	0.008 + 0.020	0.010 + 0.020	0.012 + 0.020	0.0010 + 0.0020
Diode test ¹⁰						
5 V		0.002 + 0.010	0.008 + 0.010	0.010 + 0.010	0.012 + 0.020	0.0010 + 0.0010
DC:DC ratio (typ) ¹²						
(normalized input accuracy) + (normalized reference accuracy)						

Specifications 34470A (Continued)

Temperature					
PT100 (DIN/IEC 751) ¹³	Probe accuracy + 0.05 °C				
5 kΩ thermistor	Probe accuracy + 0.1 °C				
K, J, T, E, N thermocouples ¹⁴	Probe accuracy + reference junction accuracy + 0.3 °C				
R thermocouples ¹⁴ (250 to 1760 °C)	Probe accuracy + reference junction accuracy + 0.5 °C				
True RMS AC voltage ^{15, 16}	24 hours ³ T_{CAL} ± 1 °C	90 days T_{CAL} ± 5 °C	1 year T_{CAL} ± 5 °C	2 years T_{CAL} ± 5 °C	Temperature coefficient/°C ⁵
100 mV, 1 V, 10 V, 100 V, and 750 V ranges					
3 Hz to 5 Hz	0.50 + 0.02	0.50 + 0.02	0.50 + 0.02	0.50 + 0.02	0.010 + 0.003
5 Hz to 10 Hz	0.10 + 0.02	0.10 + 0.02	0.10 + 0.02	0.11 + 0.02	0.008 + 0.003
10 Hz to 20 kHz	0.02 + 0.02	0.04 + 0.02	0.05 + 0.02	0.06 + 0.02	0.007 + 0.003
20 kHz to 50 kHz	0.05 + 0.03	0.06 + 0.03	0.07 + 0.03	0.08 + 0.03	0.010 + 0.005
50 kHz to 100 kHz	0.15 + 0.05	0.15 + 0.05	0.15 + 0.05	0.15 + 0.05	0.060 + 0.008
100 kHz to 300 kHz	1.00 + 0.1	1.00 + 0.1	1.00 + 0.1	1.00 + 0.1	0.200 + 0.020
True RMS AC current ^{16, 17}					
100 μA, 1 mA, 10 mA, 100 mA, 1 A ranges					
3 Hz to 5 kHz	0.07 + 0.04	0.09 + 0.04	0.10 + 0.04	0.10 + 0.04	0.015 + 0.006
5 to 10 kHz (typ)	0.10 + 0.04	0.10 + 0.04	0.10 + 0.04	0.10 + 0.04	0.030 + 0.006
3 A range					
3 Hz to 5 kHz	0.23 + 0.04	0.23 + 0.04	0.23 + 0.04	0.23 + 0.04	0.015 + 0.006
5 to 10 kHz (typ)	0.23 + 0.04	0.23 + 0.04	0.23 + 0.04	0.23 + 0.04	0.030 + 0.006
10 A range ⁵					
3 Hz to 5 kHz	0.10 + 0.04	0.15 + 0.04	0.15 + 0.04	0.15 + 0.04	0.015 + 0.006
5 to 10 kHz (typ)	0.15 + 0.04	0.15 + 0.04	0.15 + 0.04	0.15 + 0.04	0.030 + 0.006
Capacitance ²¹					
1.0000 nF	0.50 + 0.50	0.50 + 0.50	0.50 + 0.50	0.50 + 0.50	0.05 + 0.05
10.000 nF	0.40 + 0.10	0.40 + 0.10	0.40 + 0.10	0.40 + 0.10	0.05 + 0.01
100.00 nF	0.40 + 0.10	0.40 + 0.10	0.40 + 0.10	0.40 + 0.10	0.05 + 0.01
1.0000 μF	0.40 + 0.10	0.40 + 0.10	0.40 + 0.10	0.40 + 0.10	0.05 + 0.01
10.000 μF	0.40 + 0.10	0.40 + 0.10	0.40 + 0.10	0.40 + 0.10	0.05 + 0.01
100.00 μF	0.40 + 0.10	0.40 + 0.10	0.40 + 0.10	0.40 + 0.10	0.05 + 0.01
Frequency ^{18, 20}					
100 mV, 1 V, 10 V, 100 V, and 750 V ranges ²⁰					
3 Hz to 10 Hz	0.070	0.070	0.070	0.070	0.0002
10 Hz to 100 Hz	0.030	0.030	0.030	0.030	0.0002
100 Hz to 1 kHz	0.003	0.006	0.007	0.010	0.0002
1 kHz to 300 kHz	0.002	0.005	0.007	0.009	0.0002
Square wave ¹⁸	0.001	0.004	0.006	0.008	0.0002
Additional frequency errors ± (% of reading) ¹⁸					
Aperture (resolution/range)	1 second (0.1 ppm)	0.1 second (1 ppm)	0.01 second (10 ppm)	0.001 second (100 ppm)	
3 Hz to 40 Hz	0	0.100	0.160	0.160	
40 Hz to 100 Hz	0	0.030	0.160	0.160	
100 Hz to 1 kHz	0	0.020	0.200	0.200	
1 kHz to 300 kHz	0	0.004	0.030	0.240	
Square wave ¹⁸	0	0.000	0.000	0.003	

Specifications 34470A (Continued)

DC and AC current burden voltage at full scale	
DC current range	Burden voltage
1 μ A	< 0.0011 V
10 μ A	< 0.011 V
100 μ A	< 0.11 V
1 mA	< 0.11 V
10 mA	< 0.027 V
100 mA	< 0.27 V
1 A	< 0.7 V/0.05 V ²¹
3A	< 2.0 V/0.15 V ²¹
10 A	< 0.5 V

Digitizing²²

Typical performance for these conditions: Sample rate: 50 kHz (Aperture = 20 μ S); Sine wave input: V_{peak} = Full scale of range; Input frequency: 1 kHz/10 kHz

Function: Range	Spur-free range SFDR	THD + noise SNDR	BW (-3 db)
DCV: 0.1, 1 V	79/60	75/57	15 kHz
DCV: 10 V	86/59	82/58	15 kHz
DCV: 100, 1000 V	64/42	60/42	15 kHz
DCI: 0.1, 1 mA	78/62	75/60	10 kHz
DCI: 10, 100 mA	78/62	67/60	10 kHz
DCI: 1-10 A	65/49	63/48	10 kHz

- Specifications are for 60-minute warm-up, integration setting of 10 or 100 NPLC, auto-zero on, AC slow filter. ACAL run within the last 2 days.
- 20% over range on all ranges, except 1000 DCV, 750 ACV, 10 DCA, 3 DCA, 10 ACA, 3 ACA, and diode test have 0%.
- Relative to calibration standards.
- The 10 A range is only available on a separate front panel connector. Add 2 mA per amp for inputs greater than 5 Arms.
- Add this for each $^{\circ}$ C outside TCAL \pm 5 $^{\circ}$ C.
- Add this for each $^{\circ}$ C outside the last ACAL \pm 2 $^{\circ}$ C.
- Add this for each $^{\circ}$ C outside ACAL \pm 2 $^{\circ}$ C.
- Specifications are for 4-wire ohms function or 2-wire ohms using math null for offset. Without math null, add 0.2 Ω additional error in 2-wire ohms function. The 100 M and 1 G ohm ranges are 2-wire only. See the manual for low power ohms specification and measurement currents.
- For each additional volt over \pm 500 V add 0.02 mV of error.
- Specifications are for the voltage measured at the input terminals. The 1 mA test current is typical. Variation in the current source will create some variation in the voltage drop across a diode junction.
- See user manual for details.
- Actual measurement range and probe errors will be limited by the selected probe. Probe accuracy adder includes all measurement and ITS-90 temperature conversion errors. PT100 Ro settable to 100 Ω \pm 5 Ω to remove the initial probe error.
- The internal reference junction uses the U1180A or equivalent adapter. This has a typical performance of \pm 1.0 $^{\circ}$ C. This internal reference junction can be adjusted for better accuracy. An external reference junction can also be used.
- Specifications are for sinewave input > 0.3% of range and > 1 mVrms. 750 ACV range limited to 8 x 10⁷ Volt-Hz. For each additional volt over 300 Vrms add 1 mVrms of error.
- Low-frequency performance: three filter settings are available: 3 Hz, 20 Hz, 200 Hz. Frequencies greater than these filter settings are specified with no additional errors.
- Specifications are for sinewave input > 1% of range and > 10 μ Arms.
- Specifications are for sine wave input unless stated otherwise.
- Square wave input specified for 10 Hz to 300 kHz for 1 second aperture. For shorter apertures the minimum frequency requires > 2 cycles.
- Input > 100 mV. For 10 mV to 100 mV inputs, multiply % of reading error x10. Amplitude 10 to 120% of range except 14 to 100% for the 750 ACV range. Specifications are for 1-second gate time (7-digits).
- Specifications are for using Math Null zeroing. High dissipation factor capacitors may show different results than a single frequency measurement. Film capacitors usually have lower dissipation factors than other dielectrics.
- The second burden voltage can be obtained by using the 10 A input range.
- Sample rate (actual): 50.118 kHz (Aperture = 19.953 μ s).

Measurement Characteristics

(for all models except where noted)

DC voltage	
Measurement method:	Keysight patented continuously integrating multi-slope IV A/D converter
A/D Linearity	
- 34460/61A	0.0002% of reading + 0.0001% of range
- 34465A	0.0001% of reading + 0.0001% of range
- 34470A	0.00005% of reading + 0.0001% of range
Input resistance	
- 0.1 V, 1 V, 10 V range	Selectable 10 M Ω or >10 G Ω
- 100 V, 1,000 V range	10 M Ω \pm 1%
Input bias current	< 30 pA at 25 $^{\circ}$ C
Input terminals	Copper alloy
Input protection	1,000 V on all ranges
True RMS AC voltage	
Measurement type	AC-coupled True RMS. Measures the AC component of the input.
Measurement method	Digital sampling with anti-alias filter
Maximum input	400 DCV, 1,100 V _{peak}
Input impedance	1 M Ω \pm 1%, in parallel with < 100 pF
Input protection	750 V _{rms} all ranges
DC and True RMS AC current	
AC measurement type	Directly coupled to the fuse and shunt. AC True RMS measurement (measures the AC component only).
AC measurement method	Digital sampling with anti-alias filter
Input protection 3 A	Externally accessible 3.15 A, 500 V fuse (Replacement part number 2110-1547 3.15 A external fuse) Internal 11 A, 1,000 V fuse (Replacement part number 2110-1402 11 A external fuse)
Input protection 10 A (34461/65/70A only)	Internal 11 A, 1,000 V fuse (Replacement part number 2110-1402 11 A external fuse)
AC crest factor and peak input	
Crest factor	10:1 maximum crest factor, (3:1 at full-scale). Measurement bandwidth limited to 300 kHz for signal plus harmonics.
Peak input	300% of range or maximum input
Overload ranging	Will select higher range if peak input overload is detected during auto range. Overload is reported in manual ranging.
Resistance	
Measurement method	Selectable 4-wire or 2-wire ohms. Current source referenced to LO input.
Maximum lead resistance (4-wire ohms)	10% of range per lead for 100 Ω , 1 k Ω ranges. 1 k Ω per lead on all other ranges.
Input protection	1,000 V on all ranges
Continuity/diode test	
Response time	300 samples/s with audible tone
Continuity threshold	Fixed at 10 Ω

DC ratio	
Measurement method	Input HI-LO/reference (sense) HI-LO
Input HI-LO	100 mV to 1000 V ranges
Reference (sense)	HI-Input LO: 100 mV to 10 V ranges (autoranged)
Input to reference (sense)	HI and LO reference (sense) terminals reference to LO input < 12 V
Temperature	
PT100 platinum RTD sensor, α = 0.00385 Ω / $^{\circ}$ C; DIN/IEC 751. Measurement conversions limited to -200 to 600 $^{\circ}$ C.	
5 k Ω thermistor β = 3891; YSI 44007 or equivalent. Measurement conversions limited to -80 to 150 $^{\circ}$ C.	
Measurement noise rejection	
60 Hz (50 Hz) for 1 k Ω LO lead unbalance (\pm 500 V peak maximum)	
- DCV CMRR:	140 dB
- ACV CMRR:	70 dB
Integration time	Normal mode rejection ¹
\geq to 1 PLC	60 dB ²
< 1 PLC	0 db
Frequency and period	
Measurement method	Reciprocal-counting technique. Measurement is AC-coupled using AC measurement functions.
Voltage ranges	100 mV _{rms} full scale to 750 V _{rms} . Auto or manual ranging.
Gate time	1 ms (34465/70A), 10 ms, 100 ms, or 1 s
Measurement considerations	All frequency counters are susceptible to error when measuring low-voltage, low-frequency signals. Shielding inputs from external noise pickup is critical for minimizing measurement errors.
Autozero OFF operation	
Following instrument warm-up at a stable ambient temperature \pm 1 $^{\circ}$ C and < 10 minutes.	
Add 0.0002% of range + 5 μ V for DCV or + 5 m Ω for resistance.	
Measurement settling considerations	
High-power settling.	
Applying high-power signals (more than 300 V _{rms} , 500 VDC, 1 A DC or 1 Arms) can cause self-heating in the signal-conditioning components. These errors are included in the instrument specifications. Internal temperature changes due to self-heating may cause additional error on other functions or ranges. The additional error will generally dissipate within a few minutes.	
DC blocking capacitor	
Errors will occur in ACV and Frequency functions when attempting to measure an input following a DC offset voltage change. The input blocking RC time constant must be allowed to fully settle (up to 1 second) before the most accurate measurements are possible.	
External connections.	
Reading settling times are affected by source impedance, cable dielectric characteristics, and thermal EMF of connections. Keysight recommends the use of PTFE or other high-impedance, low-dielectric absorption wire insulation for these measurements. To maintain low thermal EMF, connectors and wires made of copper are recommended.	

1. For power-line frequency \pm 0.1%

2. For power-line frequency \pm 1%, the NMR is 40 dB. For \pm 3%, use 30 dB.

Operating Characteristics

(for all models except where noted)

Performance versus measurement speed

For DC voltage, DC current, and resistance ¹ (34460A and 34461A)

	34460A		34461A		Additional noise error
	Digits	Readings/s	Digits	Readings/s	
Integration time					
100 PLC/1.67 s (2 s)	6½	0.6 (0.5)	6½	0.6 (0.5)	0% of range
10 PLC/167 ms (200 ms)	6½	6 (5)	6½	6 (5)	0% of range
1 PLC/16.7 ms (20 ms)	5½	60 (50)	5½	60 (50)	0.001% of range ²
0.2 PLC/3 ms (3 ms)	5½	100	5½	300	0.001% of range ³
0.02 PLC/300 µs (300 µs)	3½	300	4½	1000	0.01% of range ³
AC voltage, AC current ^{4, 5}	Digits	ACV	ACI	AC filter	
34460A, 34461A, 34465A, 34470A	6½	0.4/s	0.6/s	Slow	
	6½	1.6/s	4/s	Medium	
	6½	40/s	40/s	Fast	
	6½	50/s ⁶	50/s ⁶	Fast	
Frequency, period	Aperture	Digits	Readings		
34460A, 34461A, 34465A, 34470A	1 second	7	1		
	0.1 second	6	10		
	0.01 second	5	80		
Frequency, period	Aperture	Digits	Readings		
34465A, 34470A	1 second	8	1		
	0.1 second	7	10		
	0.01 second	6	100		
	0.001 second	5	1000		

1. Reading speeds for 60 Hz (and 50 Hz) operation, autozero off, fixed range.
2. Add 5 nA for the 100 µA range, add 0.2 µA for the 10 mA range.
3. Add 20 µV for DCV and 20 mΩ for resistance. Add 0.2 µA for DC current + 10x the above range error for the 10 mA range. For 0.2 PLC multiply the above range error by 5x on the 1 A and 10 A ranges, and by 10x for the 10 mA range.
4. Maximum reading rates for 0.01% of AC step additional error. Additional settling delay required when input DC level varies.
5. For external trigger or remote operation using default settling delay (Delay Auto).
6. Maximum useful limit with default settling delays defeated.

Operating Characteristics (Continued)

(for all models except where noted)

Noise performance for DC voltage, DC current, and resistance (34465A and 34470A)

Integration time	Digits ¹ 34465/34470	Readings/s	RMS noise adder (% of range + fixed base) ²		
			DC volts	Ohms	DC current ³
100 PLC/1.67 s (2 s)	6½ / 7½	0.06 (0.5)	0	0	0
10 PLC/167 ms (200 ms)	6½ / 7½	6 (5)	0	0	0
1 PLC/16.7 ms (20 ms)	6½ / 7	60/50	0.0001 + 0.5 µV	0.0001 + 0.5 mΩ	0.0006 + 0.01 nA
0.2 PLC/3 ms (3 ms)	6½ / 6½	333	0.0005 + 3 µV	0.0010 + 10 mΩ	0.0050 + 5 nA
0.06 PLC/1 ms (1 ms)	6/6	1,000	0.0020 + 3 µV	0.0020 + 10 mΩ	0.0070 + 10 nA
0.02 PLC/300 µs (300 µs)	6/6	3,333	0.0020 + 3 µV	0.0020 + 10 mΩ	0.0070 + 10 nA
0.006 PLC/100 µs (100 µs)	5/5	10,000	0.0050 + 4 µV	0.0050 + 10 mΩ	0.0100 + 15 nA
0.002 PLC/40 µs (40 µs)	5/5	25,000	0.0050 + 4 µV	0.0050 + 10 mΩ	0.0100 + 15 nA
0.0001 PLC/20 µs (20 µs) ⁴	4½ / 4½	50,000	0.0100 + 4 µV	0.0150 + 10 mΩ	0.0150 + 30 nA

1. For DCV on the 10 V range with zero volts input and auto zero on.

2. RMS noise adder for both the 34465 and the 34470. Measured with zero volts input and auto zero on.

3. The following DCI ranges have these additional multipliers: The 10 mA by 5x, the 100 mA by 2x, and the 10 A by 1.6x.

4. Actual integration time is 19.953 µs.

System Speeds (Nom)

DC voltage, DC current, resistance ^{1,2}	34460A	34461A	34465A/34470A
Autorange time ³	< 30 ms	< 30 ms	< 5 ms
Maximum internal trigger rate	300/s	1000/s	50,000/s
Maximum external trigger rate	300/s	1000/s	5,000/s
ASCII readings to bus	300/s	1000/s	40,000/s (GPIB 8,000/s)
Single reading transaction rate ⁴	50/s	150/s	250/s
AC voltage, AC current ⁵			
Autorange time ³	10/s	10/s	< 5 ms
Maximum internal trigger rate	50/s	50/s	250/s
Maximum external trigger rate	50/s	50/s	250/s
ASCII readings to bus	50/s	50/s	250/s
Single reading transaction rate ⁴	50/s	50/s ⁵	200/s
Frequency, period ⁶			
Autorange time ³	10/s	10/s	< 5 ms
Maximum internal trigger rate	80/s	80/s	800/s
Maximum external trigger rate	80/s	80/s	800/s
ASCII readings to bus	80/s	80/s	900/s
Single reading transaction rate ⁴	50/s	50/s	200/s

- 0.02 NPLC, delay 0, autozero off, math off, and display off.
- These rates apply to all I/O interfaces.
- Time to automatically change one range and be ready for new measurement, ≤ 10 V, ≤ 10 M Ω .
- Includes measurement and IO time (assumes connection via SOCKETS. VXI-11 connections may be slower).
- Fast AC filter, delay 0, math off, and display off.
- 10 ms aperture, fast AC filter, delay 0, math off, and display off.



34460A DMM rear panel with GPIB option installed.



34461/65/70A DMM rear panel with GPIB option installed.

General Characteristics

(for all models except where noted)

Line power	
Power supply	100/120 (127)/220 (230)/240 ACV \pm 10%, CAT II
Power line frequency	50/60/400 Hz \pm 10%
Power consumption	25 VA
Environment	
Operating environment	Full accuracy for 0 °C to 55 °C Full accuracy to 80% RH at 40 °C (non condensing) Full accuracy to 40% RH for 41 °C to 55 °C (non-condensing)
Operating altitude	Up to 3,000 m
Storage temperature	-40 to 70 °C
Mechanical	
Rack dimensions	(W x H x D): 212.8 mm x 88.3 mm x 272.3 mm
Bench dimensions	(W x H x D): 261.2 mm x 103.8 mm x 303.2 mm
Weight	34460A: 3.68 kg (8.1 lb) 34461/65/70A: 3.76 kg (8.3 lb)
Regulatory	
Safety	EN 61010-1:2010 (3rd Edition) ANSI/ISA-61010-1 (82.02.01) Third Edition ANSI/UL 61010-1 Third Edition CAN/CSA-C22.2 No. 61010-1 Third Edition EN 61010-2-030:2010 (1st Edition) ANSI/ISA-61010-2-030 (82.02.03) First Edition ANSI/UL 61010-2-030 First Edition CAN/CSA-C22.2 No. 61010-2-030 First Edition Refer to Declaration of Conformity for current revisions Measurement Category II to 300 V Other non MAINS circuits to 1,000 Vpk Pollution Degree 2
EMC	IEC 61326 EN 61326 CISPR ICES-001 AS/NZS 2064.1 Refer to Declaration of Conformity for current revisions
Acoustic noise (nominal)	35 dBA



Triggering conditions	
External input	Low-power TTL compatible input programmable edge triggered
- Delay	< 1 μ s
- Jitter	< 1 μ s
- Minimum pulse width	1 μ s
- Maximum rate	Up to 1 kHz (34461A), up to 300 Hz (34460A)
Voltmeter complete output	3.3 V logic output
- Polarity	Programmable edge pulse
- Pulse width	Approximately 2 μ s

General Characteristics (Continued)

(for all models except where noted)

Computer interfaces

LXI (rev 1.4)	10/100Base-T Ethernet (Sockets, VXI-11 protocol, Web user interface) (Optional on 34460A)
USB	USB 2.0 (USB-TMC488 & MTP protocol)
GPIO	Optional GPIO IEEE-488
Language	SCPI-1999, IEEE-488.2, 34401A compatible

Front-panel USB host port (FAT32)

Supports USB 2.0 high-speed mass storage (MSC) class devices
Capability: Import/export instrument configuration files, save volatile readings and screen captures

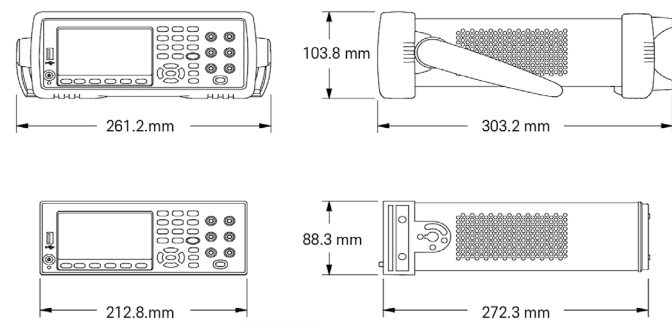

System speeds (nom)

Benchmark	GPIO	USB 2.0	VXI-11	Sockets
Function change ¹	50/s	50/s	50/s	50/s
Range change ²	100/s	100/s	100/s	100/s

1. Rate to change from 2-wire resistance to any other function.
2. Rate to change from one range to the next higher range, $\leq 10\text{ V}$, $\leq 10\text{ M}\Omega$.

Triggering and memory

Samples per trigger	1 to 1,000,000
Trigger delay	0 to 3600 sec (~1 μs step size)
External trigger delay	< 10 μs
External trigger jitter	< 1 μs (DC fixed range)
Volatile reading memory	10,000 (34461A), 1,000 (34460A)

Probe hold

Capture and navigate stable list of readings

Internal flash file system

80 MB total capacity
Save reading memory to non-volatile memory in CSV format
Store and recall user-defined states, power-off state, ¹ and preference files
Save screen captures in BMP or PNG formats

Math functions

Per function null, min/max/avg/Sdev, dB, dBm, span, count, limit test, histogram

Display

4.3" color TFT WQVGA (480x272) with LED backlight
Supports: Basic number, bar meter, trend chart (34461A only), histogram views. User-defined power-on message, display label, and selectable screen colors Integrated, context-sensitive system help through press-and-hold buttons

Real-time clock/calendar

Set and read, year, month, day, hour, minute, seconds (Note: Seconds not settable). Battery CR-2032 coin-type, replaceable, > 10-year life (typ)
Software available

1. Power-off state only when power-down is initiated via front-panel power switch.

Options, Upgrades and Accessories

Options and upgrades

Option (at purchase)	Upgrades (post purchase)	Applicable models	Description	Upgrade process
GPB	3446GPBU	All	Add GPIO interface, user-installable	Customer installable hardware
SEC	3446SECU	All	Enable NISPOM and file security	Software license
LAN	3446LANU	34460A	Enable LAN interface and external triggering	Software license
ACC	3446ACCU	34460A	Add 34138A accessory kit, includes test leads, USB cable	Accessory kit
MEM	3446MEMU	34465/70A	Enable 2 million readings memory	Software license
Z54	N/A	All	Certificate of calibration: ANSI/NCSL Z540.3-2006	Calibration certificate

Note: High speed digitizing and advanced triggering (DIG) now included with latest firmware update.

Options, Upgrades and Accessories (Continued)

Accessories

Accessories included	
34460A	Power cord
	Calibration certificate
34461A,	34138A test lead set with probes, fine tip probes
34465A,	SMT grabbers and mini grabber attachments
34470A	Power cord
	IO Libraries CD
	USB cable
	Calibration certificate
Accessories available	
11059A	Kelvin probe set
11060A	Surface-mount device probe
11062A	Kelvin clip set
34131A	Transit case
34133A	Precision electronic test leads
34134A	DC-coupled current probe
34136A	High-voltage probe
34138A	Test lead set
34151A	Three signal wedge probe kit
34152A	PT100/RTD 4-wire class A sensor kit
34153A	PT100/RTD 4-wire class sensor elements
34162A	Accessory pouch
34171B	Input terminal block
34172B	Calibration short
34330A	30-A current shunt
E2308A	Thermistor temperature probe
Y1133A	Low-thermal external digital multimeter scanning kit

Definitions

Specification (spec)

The warranted performance of a calibrated instrument that has been stored for a minimum of 2 hours within the operating temperature range of 0 to 55 °C and after a 60-minute warm up period. All specifications include measurement uncertainty and were created in compliance with ISO-17025 methods. Data published in this document are specifications (spec) only where specifically indicated.

Typical (typ)

The characteristic performance, which 80% or more of manufactured instruments will meet. This data is not warranted, does not include measurement uncertainty, and is valid only at room temperature (approximately 23 °C).

Nominal (nom)

The mean or average characteristic performance, or the value of an attribute that is determined by design such as a connector type, physical dimension, or operating speed. This data is not warranted and is measured at room temperature (approximately 23 °C).

Measured (meas)

An attribute measured during development for purposes of communicating the expected performance. This data is not warranted and is measured at room temperature (approximately 23 °C).

T_{CAL}

The temperature at which the instrument was calibrated.