

FLUKE®

3540 FC

3 Phase Power Monitor

Users Manual

July 2016 Rev. 1, 1/20

© 2016-2020 Fluke Corporation. All rights reserved. Specifications are subject to change without notice.

All product names are trademarks of their respective companies.

LIMITED WARRANTY AND LIMITATION OF LIABILITY

Each Fluke product is warranted to be free from defects in material and workmanship under normal use and service. The warranty period is two years and begins on the date of shipment. Parts, product repairs, and services are warranted for 90 days. This warranty extends only to the original buyer or end-user customer of a Fluke authorized reseller, and does not apply to fuses, disposable batteries, or to any product which, in Fluke's opinion, has been misused, altered, neglected, contaminated, or damaged by accident or abnormal conditions of operation or handling. Fluke warrants that software will operate substantially in accordance with its functional specifications for 90 days and that it has been properly recorded on non-defective media. Fluke does not warrant that software will be error free or operate without interruption.

Fluke authorized resellers shall extend this warranty on new and unused products to end-user customers only but have no authority to extend a greater or different warranty on behalf of Fluke. Warranty support is available only if product is purchased through a Fluke authorized sales outlet or Buyer has paid the applicable international price. Fluke reserves the right to invoice Buyer for importation costs of repair/replacement parts when product purchased in one country is submitted for repair in another country.

Fluke's warranty obligation is limited, at Fluke's option, to refund of the purchase price, free of charge repair, or replacement of a defective product which is returned to a Fluke authorized service center within the warranty period.

To obtain warranty service, contact your nearest Fluke authorized service center to obtain return authorization information, then send the product to that service center, with a description of the difficulty, postage and insurance prepaid (FOB Destination). Fluke assumes no risk for damage in transit. Following warranty repair, the product will be returned to Buyer, transportation prepaid (FOB Destination). If Fluke determines that failure was caused by neglect, misuse, contamination, alteration, accident, or abnormal condition of operation or handling, including overvoltage failures caused by use outside the product's specified rating, or normal wear and tear of mechanical components, Fluke will provide an estimate of repair costs and obtain authorization before commencing the work. Following repair, the product will be returned to the Buyer transportation prepaid and the Buyer will be billed for the repair and return transportation charges (FOB Shipping Point).

THIS WARRANTY IS BUYER'S SOLE AND EXCLUSIVE REMEDY AND IS IN LIEU OF ALL OTHER WARRANTIES, EXPRESS OR IMPLIED, INCLUDING BUT NOT LIMITED TO ANY IMPLIED WARRANTY OF MERCHANTABILITY OR FITNESS FOR A PARTICULAR PURPOSE. FLUKE SHALL NOT BE LIABLE FOR ANY SPECIAL, INDIRECT, INCIDENTAL OR CONSEQUENTIAL DAMAGES OR LOSSES, INCLUDING LOSS OF DATA, ARISING FROM ANY CAUSE OR THEORY.

Since some countries or states do not allow limitation of the term of an implied warranty, or exclusion or limitation of incidental or consequential damages, the limitations and exclusions of this warranty may not apply to every buyer. If any provision of this Warranty is held invalid or unenforceable by a court or other decision-maker of competent jurisdiction, such holding will not affect the validity or enforceability of any other provision.

Fluke Corporation
P.O. Box 9090
Everett, WA 98206-9090
U.S.A.

Fluke Europe B.V.
P.O. Box 1186
5602 BD Eindhoven
The Netherlands

Table of Contents

Title	Page
Introduction	1
How to Contact Fluke	2
Safety Information.....	2
Before You Start	3
Magnet Hanger Kit	5
Voltage Test Leads	6
iFlex Current Probe.....	6
Kensington Lock	7
Accessories	8
Storage	10
Storage	10
Tilt Stand	10
Power Supply	10
How to Charge Battery	11
Navigation and User Interface	12
Power ON/OFF	14
Mains Power Source	14
Measurement Line Power Source	14
Power from Battery	16
Touch Screen.....	17
Brightness Button.....	17
Calibration	17
Basic Navigation	17
Function Selection Buttons	17

Meter	17
Live Trend	18
Measurement Configuration	18
Connection Verification and Correction	25
Power	26
Monitor/Logger	27
Set Up a Session.....	27
Start Remote Monitoring	28
Start Local Logging	29
View Data	30
Alarm Notifications	30
Memory/Settings Button.....	31
Logging Sessions.....	31
Screen Capture	31
Instrument Settings	31
Firmware Version	33
Touch Screen Calibration.....	34
Copy Service Data to USB	34
Reset to Factory Defaults	34
Firmware Update.....	34
First-time Use/Setup Wizard	35
First Measurements	36
Maintenance	37
How to Clean	38
Battery Replacement.....	38
Service and Parts.....	39
Wiring Configurations.....	41
V, A, Hz, +.....	41
Power	42
General Specifications	43
Environmental Specifications	43
Electrical Specifications	45

Introduction

The 3540 FC 3 Phase Power Monitor (the Monitor or Product) is a compact device to monitor 3 phase systems and stream data to the Fluke Connect® Cloud. The measurement data from the Fluke Connect Cloud is available on any connected device using the Fluke Connect mobile app or web interface. Graphs are available to show the trends and fluctuations of the measurements during the monitoring period. Optional alarm settings can notify users immediately when measurement values are outside specified thresholds.

The Monitor includes a mode to log measurements when no connection to the Fluke Connect Cloud is available. You can sync Logged data with the Fluke Connect mobile app to the Fluke Connect Cloud.

The Monitor makes these measurements:

- Voltage (V)
- Current (A)
- Frequency (Hz)
- Power (W)
- Apparent Power (VA)
- Non-active Power (var)
- Power Factor (-)
- Total Harmonic Distortion Voltage (%)
- Total Harmonic Distortion Current (%)
- Harmonic Content Current (A)
- Harmonic Content Voltage (V)

The total number of measurements depends on the selected topology (wiring configurations), like Wye, Delta, or Split Phase.

Safety Information

General Safety Information is in the printed Safety Information document that ships with the Product and at www.fluke.com. More specific safety information is listed where applicable.

Before You Start

Below is a list of the items included with your purchase. Carefully unpack and inspect each of the items:

- 3540 3 Phase Power Monitor/Power Supply
- Voltage Test Lead, 3-phase + N
- 2x Alligator Clips, Blue
- 4x Alligator Clips, Black
- 3x i173x-flex1500 iFlex Current Probe, 30.5 cm (12 in)
- Cable Marker Set
- Mains Power Cable (see Table 1)
- Set of 2 test leads, stack and non-stackable, blue, 18 cm (7 in)
- Set of 2 test leads, non-stackable, blue, 2 m (79 in)
- DC Power Cable
- Documentation Info Pack (Quick Reference Card, Safety Information, Battery Pack Safety Information, iFlex Probe Safety Information)
- WiFi to USB Adapter
- Magnet Hanger Kit

Note

The power cord and input connector decal are country specific and vary according to the order destination.

Table 1. Country-Specific Mains Power Cable

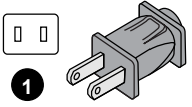
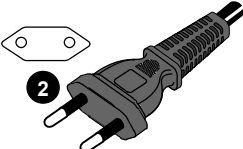
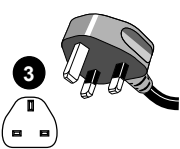
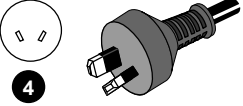
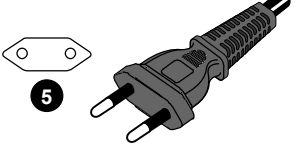
		
		
<small>hcf059.emf</small>		
Item	Location	Part Number
1	North America/Japan	1552374
2	Universal Euro	1552388
3	United Kingdom	1552342
4	Australia/China	1552339
5	Brazil	4322049

The USB adapter enables wireless connection in the Monitor to:

- Stream all data to the Fluke Connect® Cloud
- Manage assets and share data with the Fluke Connect® smartphone app

To install the adapter in the Monitor:

1. Remove the Power Supply. See Figure 1.
2. Unscrew the four screws.
3. Remove the battery door.
4. Remove the battery.
5. Insert the WiFi adapter in the compartment.
6. Insert the battery.
7. Fasten the battery door.

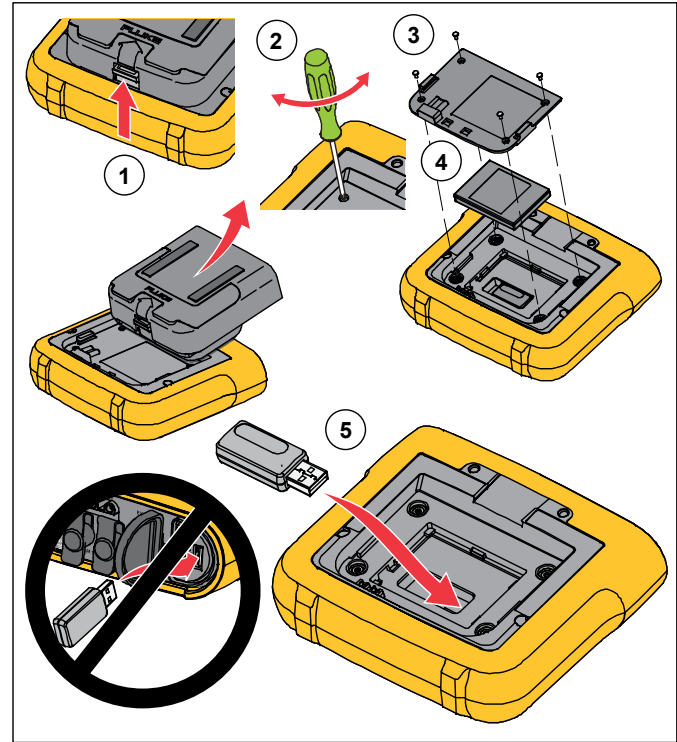

hcf069.emf

Figure 1. Adapter Installation

Magnet Hanger Kit

The accessory shown in Figure 2 is used to:

- Hang the Monitor with power supply attached (use two magnets)
- Hang the Monitor separately (use two magnets)
- Hang the power supply separately (use one magnet)

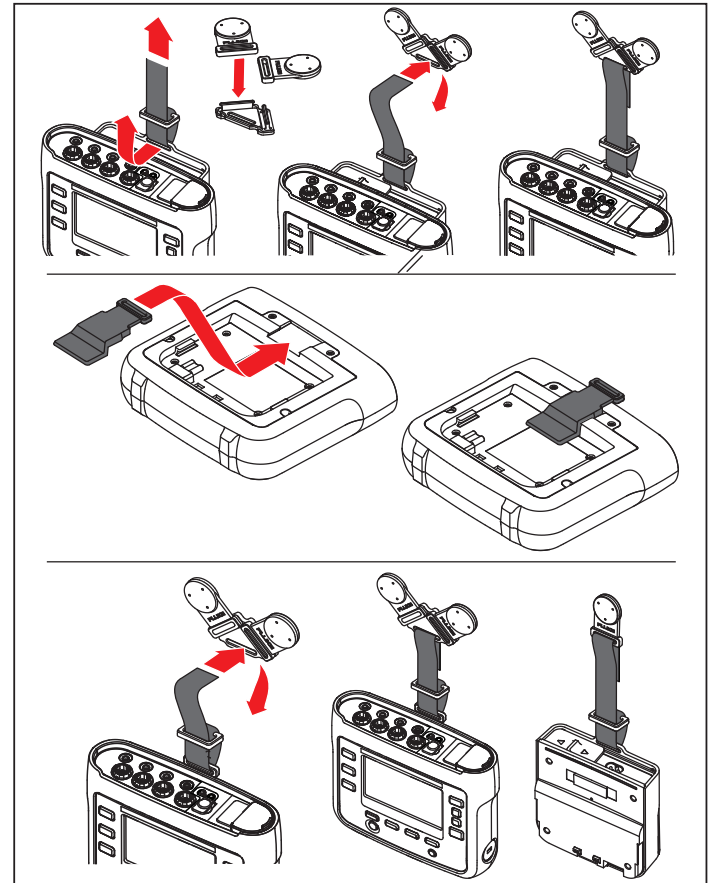

hcf058.eps

Figure 2. Magnet Hanger Kit

Voltage Test Leads

Voltage test leads are four-core, flat, test leads that do not tangle and can be installed in tight spaces. On installations where the access to Neutral is out of reach with the three-phase test lead, use the black test lead to extend the Neutral lead.

For single phase measurements use the red and black test leads.

iFlex Current Probe

The iFlex Current Probe works on the Rogowski coil (R-coil) principle that is a toroid of wire used to measure an alternating current through a wire encircled by the toroid. See Figure 3.

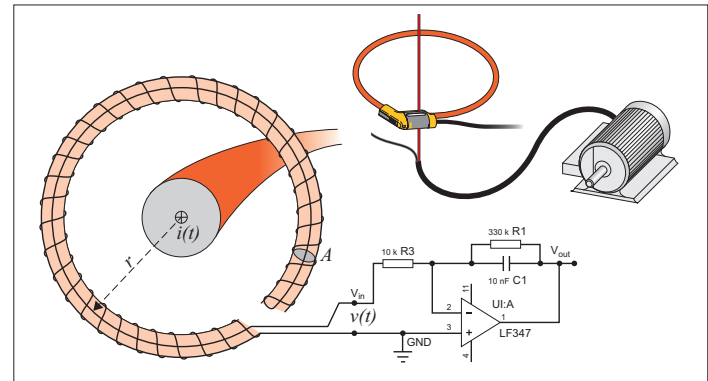

hcf028.eps

Figure 3. R-Coil Operation Principle

The R-coil has many advantages over other types of current transformers:

- It is not a closed loop. The second terminal is passed back through the center of the toroid core (commonly a plastic or rubber tube) and connected along the first terminal. This allows the coil to be open-ended, flexible, and able to be wrapped around a live conductor without disturbing it.
- It has an air core rather than an iron core. It has a low inductance and can respond to fast-changing currents.
- Because it has no iron core to saturate, it is highly linear even when subjected to large currents, such as those used in electric power transmission or pulsed-power applications.

A correctly formed R-coil, with equally spaced windings, is largely immune to electromagnetic interference.

Use the cable markers for easy identification of the current probes. Apply the markers on both ends of the current probe cable. See Figure 4.

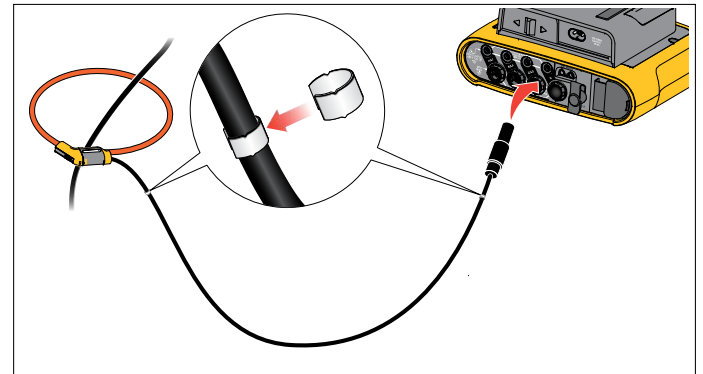

hcf025.emf

Figure 4. Test Leads with Cable Markers

Kensington Lock

A Kensington Security Slot (also called a K-Slot or Kensington lock) is part of a built-in anti-theft system. It is a small, metal-reinforced, oval hole found on the right side of the Monitor (see item 6 in Table 3). It is used for attaching a lock-and-cable apparatus. The lock is secured in place with a key or combination lock attached to a plastic-cover metal cable. The end of the cable has a small loop that allows the cable to be looped around a permanent object, such as a cabinet door, to secure it in place. This lock is available from most electronics and computer suppliers.

Accessories

Table 2 is a list of the accessories that are available and sold separately for the Monitor. The warranty on included accessories is 1 year.

Table 2. Accessories

Part ID	Description	Part Number
i17xx-flexi 1500	Thin-Flexi Current Probe (single) 1500 A, 30.5 cm (12 in.)	4637328
i17xx-flexi 1500/3PK	Set of 3 Thin-Flexi Current Probes	4637337
i17xx-flexi 3000	Thin-Flexi Current Probe (single) 3000 A, 61 cm (24 in.)	4637343
i17xx-flexi 3000/3PK	Set of 3 Thin-Flexi Current Probes	4637355
i17xx-flexi 6000	Thin-Flexi Current Probe (single) 6000 A, 90.5 cm (36 in.)	4637362
i17xx-flexi 6000/3PK	Set of 3 Thin-Flexi Current Probes	4637370
i17xx flexi extension cable	Thin-Flexi extension cable (single), 5 m (16.4 ft.)	4921116
i17xx flexi extension cable/3PK	Set of 3 Thin-Flexi extension cable, 5 m (16.4 ft.)	4983772
C17xx	Soft Case	4637381
Test Leads 0.18m	0.18 m (7 in.) Test Lead Set, blue	5016873
Test Leads 2m with alligator clips	2.0 m (79 in.) Test Lead Set plus 2x alligator clips, blue	5020006
Voltage Test Lead 3-phase+N, 2m (79 in.)	3PHVL-17xx Voltage Test Lead 3-phase + N, 2 m (79 in.)	5014802
Voltage Test Lead 3-phase+N, 5m (197 in.)	3PHVL-17xx Voltage Test Lead 3-phase + N, 5 m (197 in.)	5014816

Table 2. Accessories (cont.)

Part ID	Description	Part Number
i40s-EL Current Clamp	40 A (single) Current Clamp	4637396
i40s-EL/3PK	Set of 3 Current Clamps, 40 A	4637409
i400S-EL	400 A (single) Current Clamp	4637396
i400S-EL/3PK	Set of 3 Current Clamps, 400 A	4637409
17xx AUX Input Adapter	Auxiliary Input Adapter for up to 2DC voltages (0 V to 10 V and 0 V to 1000 V)	4717827
Fused Test Probe Set	Set of 4 Test Probes, three phase, AC285, 1x black, 3x red	4954311
MP1-3R Magnet Probe Set	Set of 4 Magnet Probes for 4 mm banana plugs, 1x black, 3x red	4944790
BP1730	Battery Pack	4389436
Fluke-PQ-Marker	Cable marker set 3 phase + N + PE	5046009
Fluke-1730-Hanger Kit	Hanger Kit	4358028
FLK-WIFI/BLE	WiFi/BLE to USB Adapter (check with your sales representative for availability)	4591273

Storage

When not in use, keep the Monitor in a protected storage space. If the Monitor is stored for an extended period of time or is not in use for a long time, you must charge the battery at least once every six months.

Tilt Stand

The power supply includes a tilt stand. When used, the tilt stand positions the display at a good angle for use on a tabletop surface. To use, attach the power supply to the Monitor and open the tilt stand.

Power Supply

The Monitor includes a power supply, see Figure 5. Connect the power supply externally in locations where the Monitor with the power supply attached is too big to fit in a cabinet between the door and panel.

When the power supply is connected to the Monitor and line power, it:

- converts line power to dc power and is used directly by the Monitor
- automatically turns on the Monitor and continuously powers the Monitor from the external source (after initial power on, the power button turns on and turns off the Monitor)
- recharges the battery

The power cord/measurement line cover slides to select the input source.

⚠⚠ Warning

To prevent possible electrical shock, fire, or personal injury, do not use the power supply if the mains power cable/measurement line slide-cover is missing.

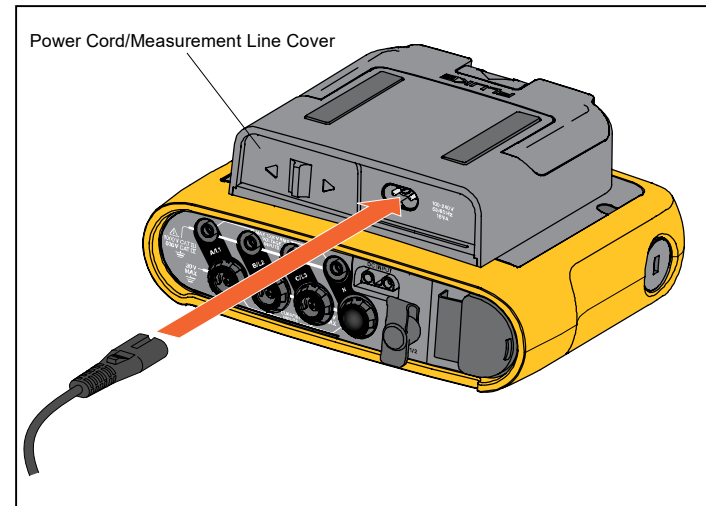

hcf031.emf

Figure 5. Power Supply and Battery

How to Charge Battery

The Monitor also operates on an internal rechargeable Lithium-ion battery. After you unpack and inspect the Monitor, fully charge the battery before first use. Afterwards, charge the battery when the battery icon on the screen indicates that power is low. The battery automatically charges when the Monitor is connected to the mains power. The battery continues to charge when turned off and connected to mains power.

Note

The battery charge is faster when the Monitor is turned off.

To charge the battery:

1. Connect the mains cord to the ac input socket on the power supply.
2. Fit the power supply to the Monitor or use the dc power cord to connect the power supply to the Monitor.
3. Connect to mains power.

⚠ Caution

To prevent damage to the Product:

- **Do not leave batteries unused for extended periods of time, either in the product or in storage.**
- **When a battery has not been used for six months, check the charge status and charge the battery as appropriate.**
- **Clean battery packs and contacts with a clean, dry cloth.**
- **Battery packs must be charged before use.**
- **After extended storage, it can be necessary to charge and discharge a battery pack to obtain maximum performance.**
- **Dispose properly.**

Note





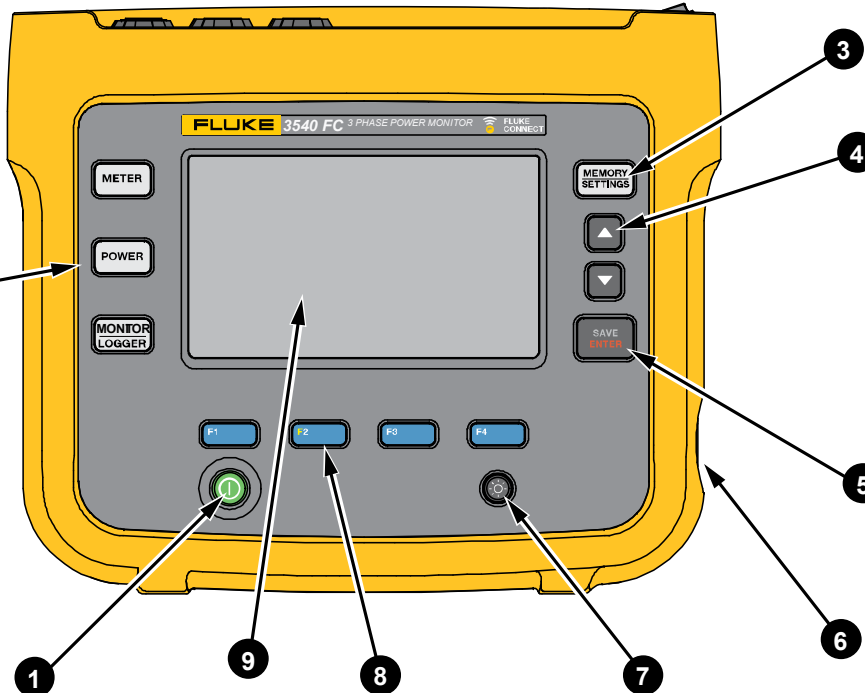

- *Li-ion batteries keep a charge longer if stored at room temperature.*
- *When the Monitor shuts off because of low battery, enough battery capacity is available to back up the real-time clock for up to 2 months.*
- *The clock resets when the battery is completely discharged.*

Navigation and User Interface

See Table 3 for a list of the front panel controls and their functions. See Table 4 for a list of the connectors and their functions.

Table 3. Front Panel



Item	Control	Description
1		Power on/off and status
2		Meter, Power, or Monitor/Logger function selection
3		Memory/Setup selection
4		Cursor control
5		Selection control
6		Kensington lock
7		Backlight on/off
8		Softkey selection
9		Touch screen display

hcf023.eps

Table 4. Connector Panel

Item	Description
1	Current measurement inputs (3 phases)
2	Voltage measurement inputs (3 phases)
3	Power Cord/Measurement Line Slide-Cover
4	Power Cord AC Input 100 V to 240 V 50/60 Hz 15 VA
5	Measurement Line AC Input 100 V to 500 V 50/60 Hz 50 VA
6	USB connector
7	Mini-USB connector
8	Aux 1/2 Connector (not used)
9	DC Power Input

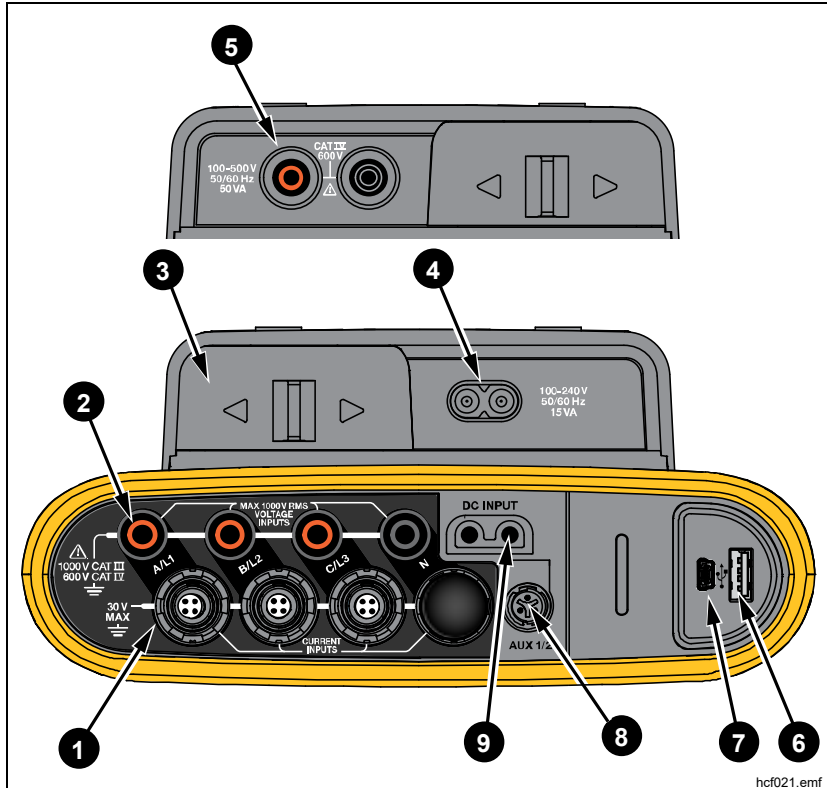

Power ON/OFF

The Monitor has several options for power: mains, measurement line, and battery. The front panel LED shows the status. See Table 5 for more information.

Mains Power Source

1. Attach the power supply to the Monitor or use the dc power cord to connect the power supply to the Monitor.
2. Move the slide-cover on the power supply to access the mains socket and connect the power cord into the Monitor.

The Monitor automatically turns on and is ready to use in <30 seconds.
3. Push  to turn on and turn off the Monitor.

Measurement Line Power Source

Caution

To prevent damage to the Product, make sure the measured voltage does not exceed the input rating of the power supply.

Warning

To prevent injury, do not touch the metal parts of one test lead when the other is still connected to hazardous voltage.

1. Attach the Power Supply to the Monitor.
2. Move the slide-cover on the power supply to access the safety sockets.

3. Connect the non-stackable plugs (see Figure 6 and Figure 7) with the power supply inputs and the stackable plugs to the Monitor. The test leads are rated for measurement/overvoltage CAT III 1000 V and CAT IV 600 V.

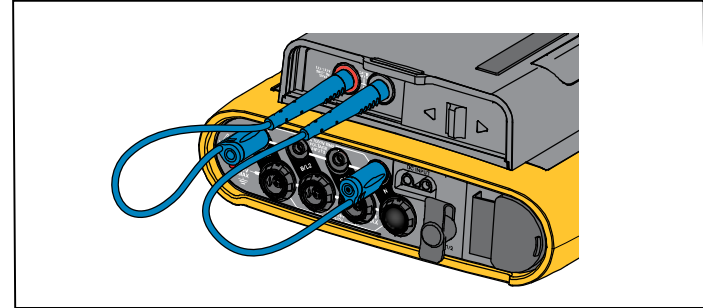

hcf077.emf

Figure 6. Measurement with Neutral Voltage and Instrument Power Supply

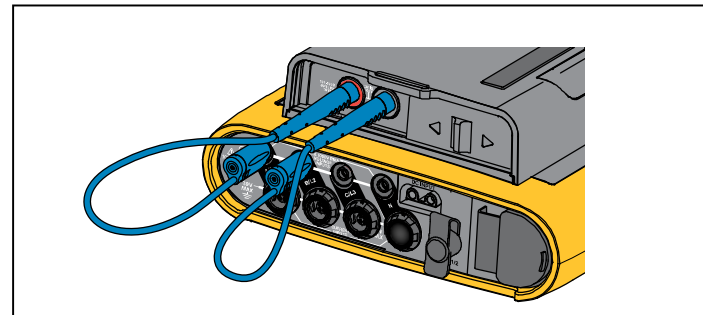

hcf078.emf

Figure 7. Measurement without Neutral Voltage and Instrument Power Supply

4. Connect the test leads with the voltage measurement inputs:
 - Connect A/L1 with one input of the power supply.
 - Connect N with the second input of the power supply.

OR

 - Connect A/L1 with one input of the power supply.
 - Connect B/L2 with the second input of the power supply.

5. Use the short fan out of the Voltage Test Lead, 3-phase + N. Plug the connector A/L1 into the socket A/L1 of the voltage measurement inputs of the Monitor. Repeat this with B/L2, C/L3 and N. See Figure 8 and Figure 9.

Note

You must locate and connect an alternate power source to the instrument if the voltage to measure is <100 V or >500 V. Use the set of 2 m test leads (item 8, Figure 10) or the supplied power cord.

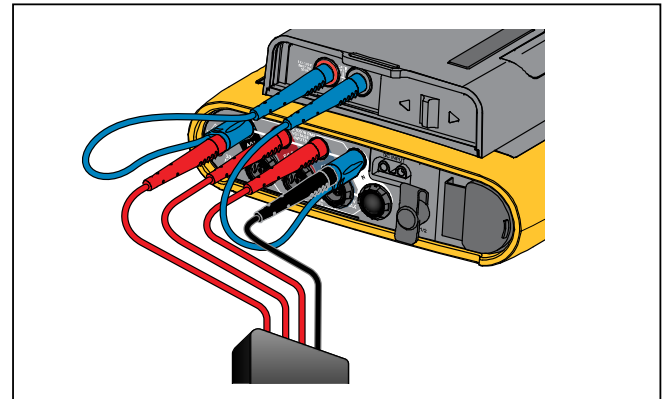

Figure 8. Measurement with Neutral Voltage and Instrument Power Supply

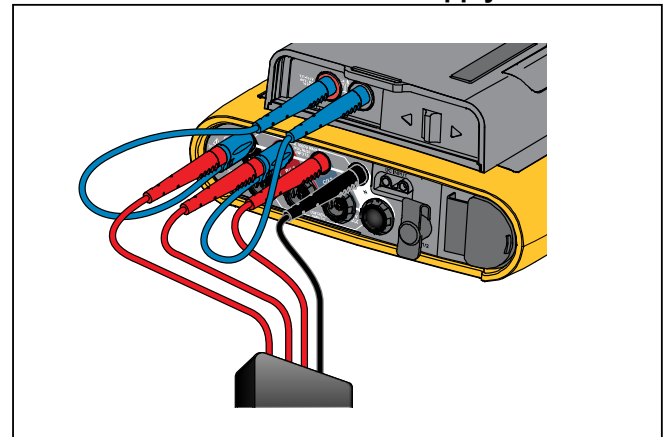

Figure 9. Measurement without Neutral Voltage and Instrument Power Supply

6. Connect the voltage inputs to the test points.

The Monitor automatically turns on and is ready to use in <30 seconds.

Note

You must locate and connect an alternate power source to the instrument if the voltage to measure is <100 V or >500 V. Use the set of 2 m test leads (item 8, Figure 10) or the supplied power cord.

7. Connect the voltage inputs to the test points.







The Monitor automatically turns on and is ready to use in <30 seconds.

Power from Battery

The Monitor can operate on battery power without a connection to the power supply or dc power cord. Push ①. The Monitor turns on and is ready to use in <30 seconds.

The battery symbol in the status bar and the power LED indicate the battery status. See Table 5.

Table 5. Power/Battery Status

Monitor On		
Power Source	Battery Symbol	Power LED Color
Mains		green
Battery		yellow
Battery		yellow
Battery		yellow
Battery		yellow
Battery		red
Monitor OFF		
Power Source	Battery Status	Power LED Color
Mains	Charging	blue
Mains	off	off
Monitor Status		
not logging		steady
logging		flashing

Touch Screen

The touch screen lets you interact directly with what is on the display. To change parameters, touch a target on the display. Touch targets are easy to recognize, such as large buttons, items in menus, or keys of the virtual keyboard. The Product can be operated with insulating gloves on (resistive touch).

Brightness Button

The touch screen has a backlight for work in dimly-lit spaces. See Table 3 for the location of the Brightness (⚙️) button. Push ⚙️ to adjust the brightness in two levels and to turn on and turn off the display.



The brightness is set to 100 % when the Monitor is powered from mains. When powered from battery, the default brightness is set to the power-save level of 30 %. Push ⚙️ to toggle between the two brightness levels.



Push and hold ⚙️ for 3 seconds to turn off the display. Push ⚙️ to turn on the display.





Calibration

The touch screen is pre-calibrated in the factory. If you notice that the targets do not align with your touch on the display, you can calibrate the display. Calibration of the touch screen is available in the  menu. See page 34 for more information about the touch screen calibration.

Basic Navigation

When an option menu shows on the display, use   to move within the menu.

The  button has a dual use. In the Configuration and Setup screens, push  to confirm the selection. On all screens, push  for 2 seconds to take a screen shot. The camera symbol on the display confirms the action. See *Screen Capture* for more information about how to review, manage, and copy the screen shots.

Along the bottom of the display, a row of labels, or softkeys, shows the available functions. Push    or  below the display label to start that function. These labels also work as touch targets.

Function Selection Buttons

The Monitor has three buttons to change the function modes between Meter, Power, and Monitor/Logger. The current mode shows in the upper left corner of the display.

Meter

 – The Meter mode shows measurement readings for:

- Voltage (V RMS)
- Current (A RMS)
- Frequency (Hz)
- Wave Shape of Voltage and Current
- THD (%) and Harmonics of Voltage (% , V RMS)
- THD (%) and Harmonics of Current (% , A RMS)

Push  to show the additional values.

Live Trend

You can determine the values or display a trend chart of the last 7 minutes. In the chart:

1. Push **F1** to select Live Trend.
2. Push **F4** or the cursor keys to show the list of available parameters.
3. Push **F2** (Reset) to clear the graph and restart.

Measurement Configuration

Use the **Change Configuration** touch button to access the measurement configuration screen. The configuration screen allows you to change the parameters for:

- Study type
- Topology
- Nominal voltage (Load study)
- Current range
- Scale factors for external PTs or CTs

Use **F4** to navigate between the sub-screens.

Study Type

Depending on the application, select the type of study:

- **Energy Study:** Select this study type when voltage measurements for power values that include active power (W) and PF are required.
- **Load Study (no voltage measurement):** Select this study type that uses current only for a basic measurement of energy consumption.

Typical applications are:

- Verify the circuit capacity before adding additional load.
- Identify situations where the allowable load can be exceeded.

Optionally, configure a nominal voltage to get pseudo-apparent power readings.

Topology (Distribution System)

Select the appropriate system. A connection diagram for the voltage test leads and current sensors is shown on the Monitor.

A diagram is also available with **F1** (Connection diagram) from the **Change Configuration** menu. Examples of these diagrams are shown on the following pages.

Single Phase

Example: Branch circuit at an outlet.

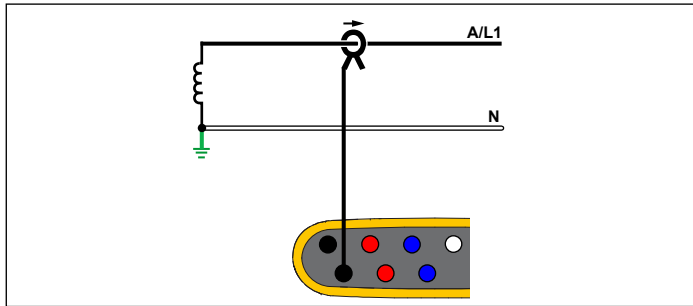

hcf040.eps

Energy Study

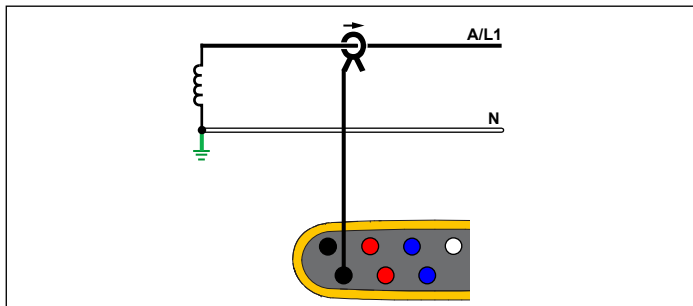

hcf041.eps

Load Study (no voltage measurement)

Single Phase IT

The Monitor has a galvanic isolation between the voltage inputs and ground based signals like USB and mains input.

Example: Used in Norway and in some hospitals. This would be the connection at a branch circuit.

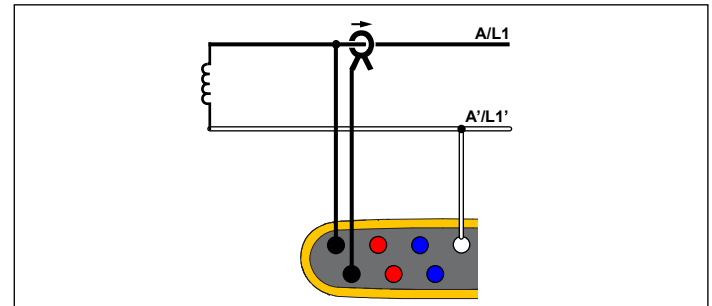

hcf042.eps

Energy Study

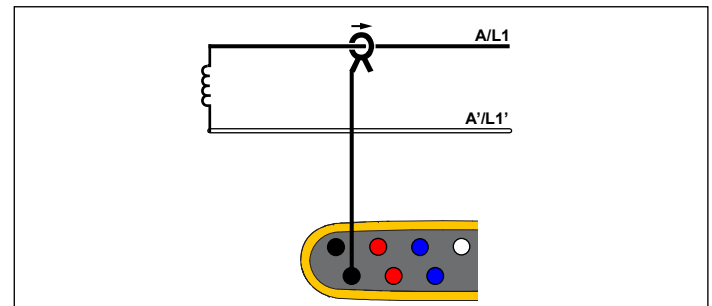

hcf042-2.eps

Load Study (no voltage measurement)

Split Phase

Example: A North American residential installation at the service entrance.

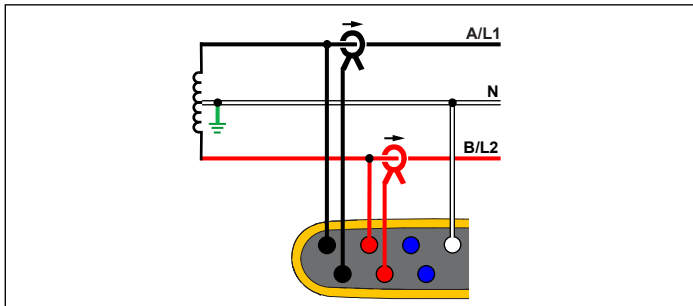

hcf043.eps

Energy Study

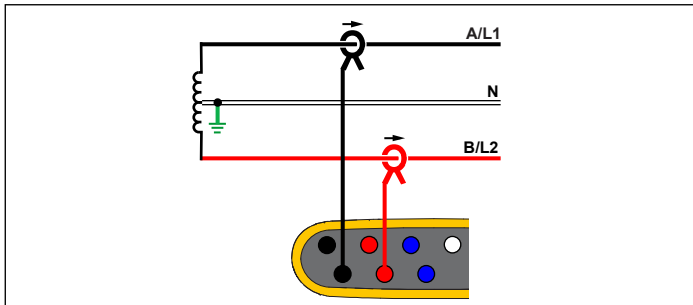

hcf044.eps

Load Study (no voltage measurement)

3- Φ Wye

Example: Also called "Star" or four-wire connection. Typical commercial building power.

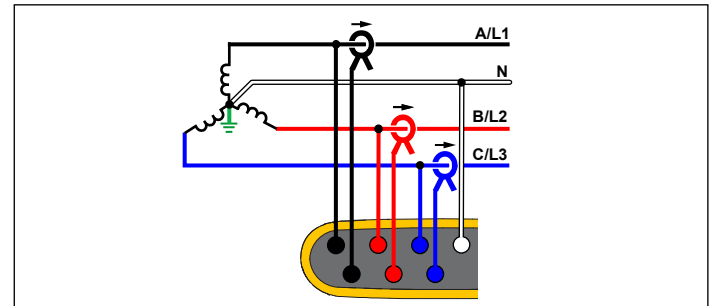

hcf045.eps

Energy Study

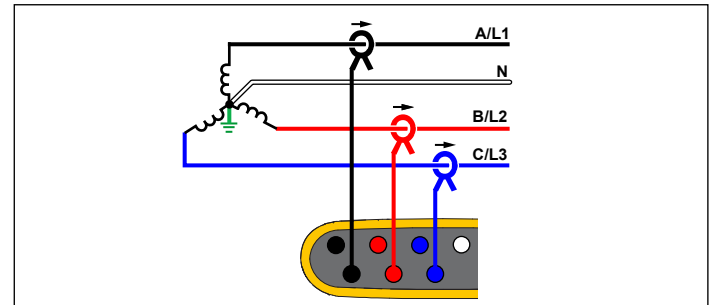

hcf046.eps

Load Study (no voltage measurement)

3- Φ Wye IT

The Monitor has a galvanic isolation between the voltage inputs and ground based signals like USB and mains input.

Example: Industrial power in countries that use the IT (Isolated Terra) system, such as Norway.

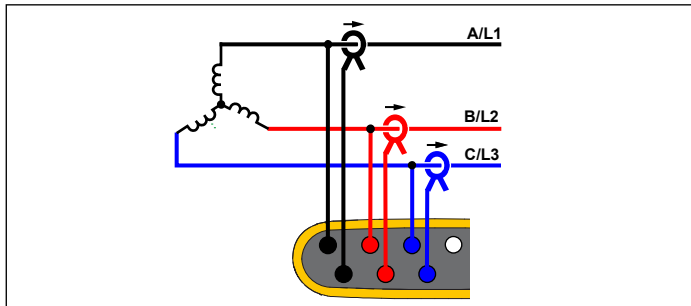

hcf047.eps

Energy Study

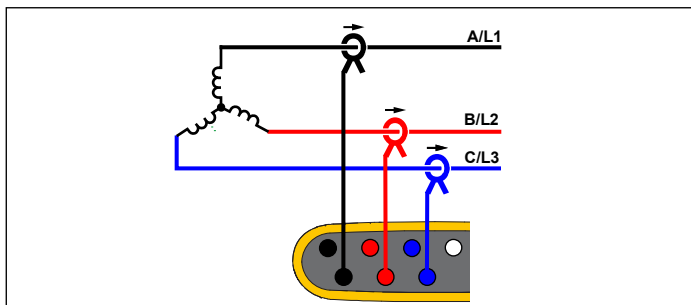

hcf048.eps

Load Study (no voltage measurement)

3- Φ Wye Balanced

Example: For symmetrical loads like motors the connection can be simplified by measuring only one phase and assuming the same voltages/currents on the other phases. As an option, you can measure harmonics with a current probe on the neutral line.

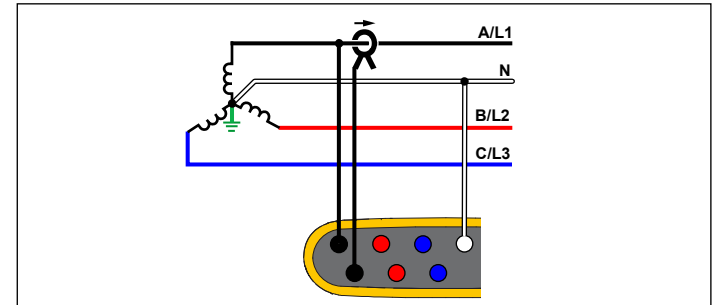

hcf049.eps

Energy Study

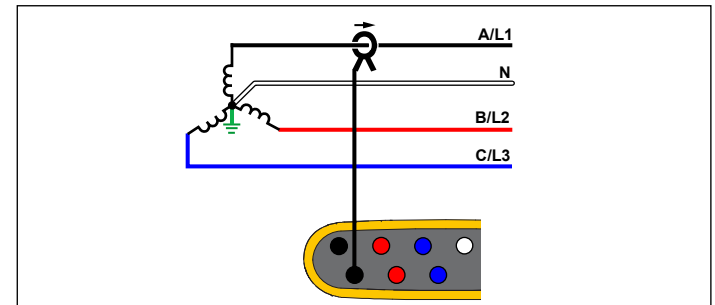

hcf050.eps

Load Study (no voltage measurement)

3- Φ Delta

Example: Often found in industrial settings where electric motors are used.

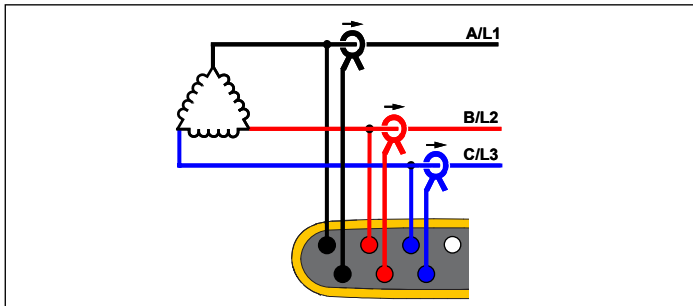

hcf051.eps

Energy Study

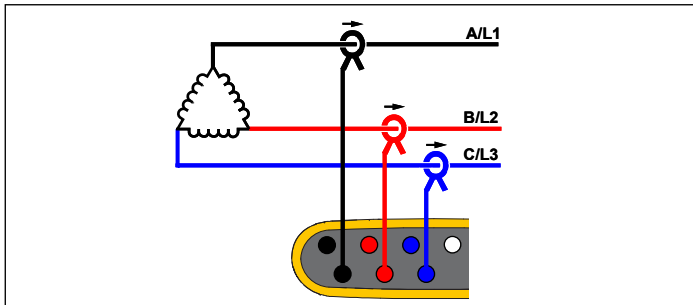

hcf052.eps

Load Study (no voltage measurement)

3- Φ Delta Balanced

Example: For symmetrical loads like motors, the connection is simplified with only one phase measurement and assuming the same voltages/currents on the other phases.

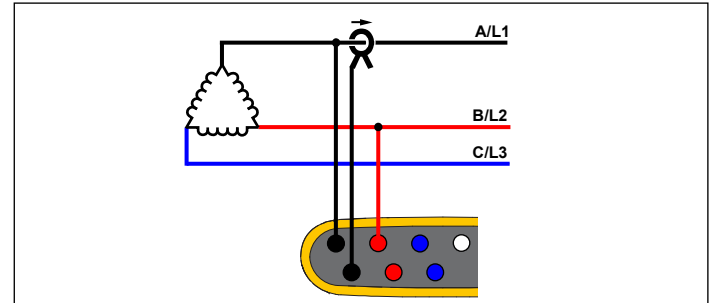

hcf063.eps

Energy Study

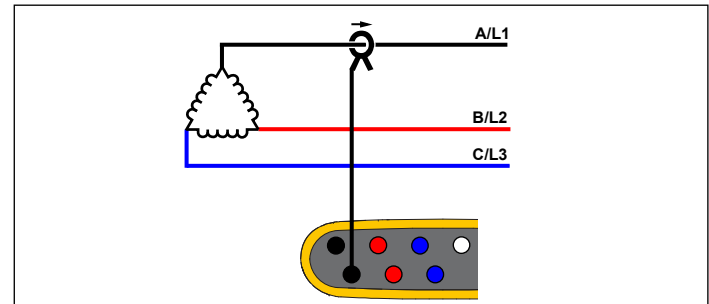

hcf064.eps

Load Study (no voltage measurement)

2 Element Delta (Aron/Blondel)

Example: Blondel or Aron connection, simplifies the connection using only two current sensors.

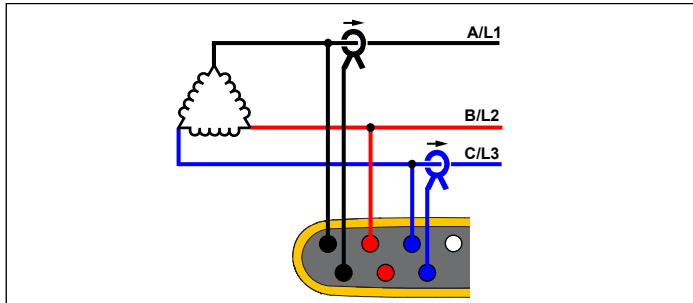

hcf055.eps

Energy Study

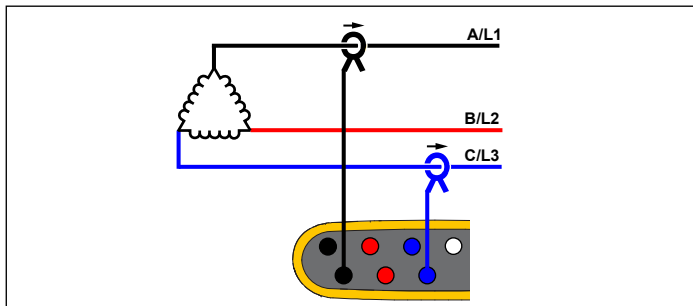

hcf056.eps

Load Study (no voltage measurement)

Note

Make sure that the current arrow on the sensor is directed towards the load to provide positive power values. The current sensor direction can be corrected digitally in the Connection Verification screen.

3- ϕ Delta Open Leg

Example: A variant of power transformer winding type.

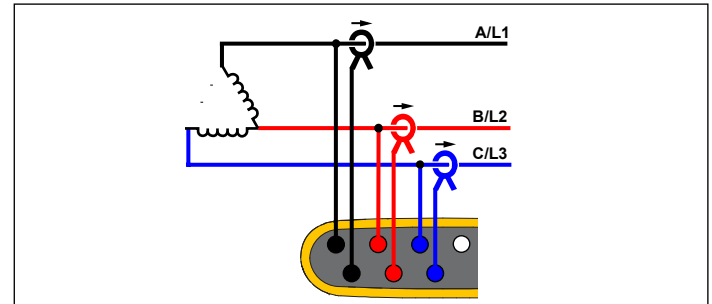

hcf053.eps

Energy Study

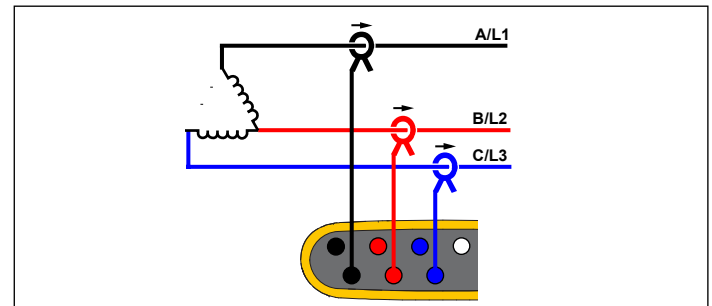

hcf054.eps

Load Study (no voltage measurement)

3- Φ High Leg Delta

Example: This topology is used to provide an additional voltage that is half the phase to phase voltage.

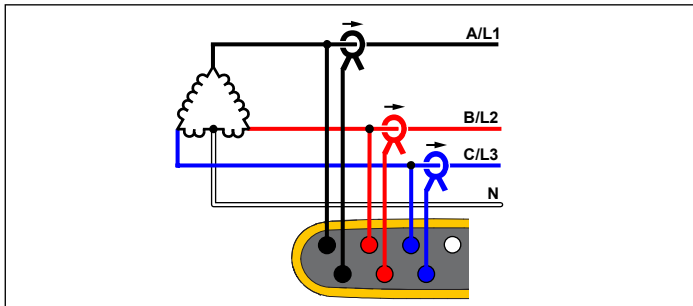

hcf061.eps

Energy Study

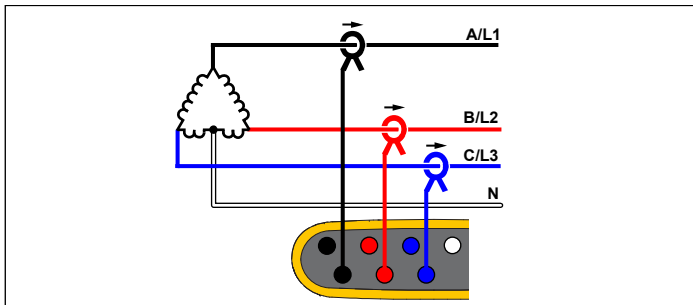

hcf062.eps

Load Study (no voltage measurement)

Note

The Logger provides the data of the 3- Φ Delta system. For details of the tapped leg, configure the topology for Split Phase.

Nominal Voltage (only in load studies)

Select a nominal voltage from the list. If a voltage is not shown in the list, enter a custom voltage. Use the nominal voltage on load studies to calculate the pseudo apparent power:

$$\text{nominal voltage} \times \text{measured current}$$

Set the nominal voltage to off if the apparent power readings are not required.

Voltage Ratio (only in energy studies)

Configure a ratio factor for the voltage inputs when a potential transformer (PT) is in series with the voltage connections such as when you want to monitor a medium-voltage network. The default value is 1:1.

Nominal Frequency

Set the nominal frequency to be the same as the power line frequency, 50 Hz or 60 Hz.

Use **F4** (Show Menu) to navigate between the sub-screens.

Current Range

Configure the current range of the attached sensor. Three ranges are available:

- Auto
- Low Range
- High Range

When set to Auto, the current range is set automatically and depends on the measured current.

Low Range is 1/10 of the nominal range of the attached current sensor. For example, the low range of an iFlex1500-12 is 150 A.

High Range is the nominal range of the attached current sensor. For example, 1500 A is the nominal range on an iFlex1500-12.

Note

Set the current range to Auto when you are not sure about the maximum current during the logging session. A specific application can require you to set the current range to a fixed range rather than Auto. This can occur because the Auto range is not gapless and may lose too much information in the case of a highly fluctuating current.

Current Ratio

Configure a ratio factor for the current sensors when you use a current transducer (CT) to measure the much higher level on the primary side at a substation or step-down transformer that has a built-in metering current transformer.

The current ratio can be used to increase the sensitivity of the iFlex sensor. Wrap the iFlex sensor around the primary conductor, for example 2X, and enter a ratio factor of 1:2 to get correct readings. The default value is 1:1.

Connection Verification and Correction

Once the measurement is configured and the voltage and current inputs are connected to the system under test, go back to the Meter mode and use the **Verify Connection** touch button to confirm the connection.

The verification detects:

- Signal is too low
- Phase rotation for voltage and current
- Inverted current probes
- Wrong phase map

In the connection verification screen:

1. Push **F2** to toggle between Generator Mode and Load Mode.

Usually the current flow direction is toward the load. Use Load Mode for these applications. Use the Generator Mode when the current sensors are connected intentionally to the generator (for example, during the time energy goes into the grid from regenerative braking system of an elevator or on-site wind turbines).

The current flow arrow indicates the correct flow: a normal condition is shown in Load Mode with a black arrow pointing upwards, in Generator Mode the black arrow points downwards. If the arrow is shown in red, the current flow direction is inverted.

2. Push **F4** (Correct Digitally) to access the connection correction screen. Use this screen to virtually swap phases and invert the current inputs instead of a manual correction.
3. If the Monitor is able to determine a better phase map or polarity, push **F1** (Auto Correct) to apply the new settings.

Auto Correct is not available if the algorithm is not able to detect a better phase map or when no errors are detected.

Note

It is impossible to detect all incorrect hook-ups automatically. You must verify the suggested modifications carefully before you apply the digital correction. Applications with single-phase energy generation can deliver the wrong results when you apply the Auto Correct feature.

The algorithm works in a way that creates in three phase systems a sequence with a clockwise phase rotation.

Power

POWER – In the Power mode you can get the values and a live trend chart for each phase (A, B, C or L1, L2, L3) and total as:

- Active Power (P) in W
- Apparent Power (S) in VA
- Non-active Power (N) in var
- Power Factor (PF)

Use **F2** (Fundamental/RMS) to toggle between full bandwidth power values and power of the fundamental.

In the fundamental power screen you see these values:

- Fundamental Active Power (P_{fund+}) in W
- Fundamental Apparent Power (S_{fund}) in VA
- Fundamental Reactive Power (Q_{fund}) in var
- Displacement Power Factor (DPF) / $\cos\phi$

Push **F4** (Show Menu) to open a list of simplified Power screens that show all phases and total of one parameter, all parameters of one phase, or total.

To display a trend chart of the last 7 minutes of Power values:

1. Push **F1** (Live-Trend).
2. Use **F4** or the cursor keys to show the list of available parameters.
3. Push **F2** (Reset) to clear the graph and restart.

Note

In the user interface, the term Fundamental is sometimes shortened to "Fund." or "h01."

Monitor/Logger

 – In the Monitor/Logger mode two methods are available for storing data measurements:

- Monitor mode – all measurement data is transferred in real-time to the Fluke Connect® Cloud.
- Logger mode – a session is started to store all measurement data on the Monitor. This logged measurement data is transferred to the Fluke Connect Cloud with the Fluke Connect App.

Before you start a monitoring or logging session to the Fluke Connect Cloud, you must:

- Set up the session type on the Monitor
- Install the Fluke Connect app on a mobile device
- Access the internet through a WiFi network. (The Monitor uses the SSID of the WiFi network to connect to the internet and stream the measurement data to the Fluke Connect Cloud. A mobile device can use the same WiFi connection to connect to the Fluke Connect Cloud.)

Set Up a Session







To start a session for remote monitoring or data logging:

1. Connect the Monitor to mains power.

The Monitor starts and shows the Monitor screen.

Note

See page 10 for more information about how to power the Monitor from the measurement line.

2. Push  (Configure). Confirm the study type and the wiring configuration is correct. For most applications the current range is set to Auto and the voltage and current ranges are 1:1.
3. Push  (Configuration Diagram) for guidance on the voltage test lead and current probe connections.
 - a. Connect the voltage test leads to the Monitor.
 - b. Connect the iFlex current probe:
 - phase A to the Monitor phase A input jack
 - phase B to the Monitor phase B input jack
 - phase C to the Monitor phase C input jack
 - c. Apply the iFlex probes to the wires in the electrical panel. Make sure the arrow on the probe points to the load.
 - d. Connect the voltage test leads to neutral, phase A, phase B, and phase C.
4. Push  to go back to the Monitor mode.
5. Push  (Verify) to check and correct the phase rotation, phase mapping, and polarity of the current probes. Most installations use a clockwise rotation.
6. Push  to go back to the Monitor mode.
7. Push  (Change Mode).
8. Select **Session Setup** to set up the monitoring or logging session in the Fluke Connect® Cloud.

You configure the Monitor as a WiFi hotspot with the SSID shown on the screen. The WiFi connection uses WPA2-PSK (pre-shared key) with AES encryption. The passphrase shown on the screen is required to make the connection from a mobile device to the Monitor.

8. On the mobile device, go to the list of available WiFi networks and look for a network with the name **FLUKE3540FC<serial-no>**.

Example: **FLUKE3540FC<12345678>**

9. At the prompt, enter the passphrase you see on the Monitor screen on the mobile device.

Note

Depending on the operating system of the mobile device, the passphrase is called a security key, password, or similar phrase.

After you make a connection with this SSID on the mobile device, the Fluke Connect app guides you through the setup. You must set up an Asset (the equipment that is measured) to link the measurement data and set the alarm limits for the Asset. All information in the Fluke Connect Cloud is retrieved by selecting the Asset on the mobile device or through the web interface.

When configuration is complete, Asset information transfers to the Monitor and the name of the Asset shows on the display. The Asset and alarm information also transfers to the Fluke Connect Cloud when you select an internet connection on the mobile device.

Start Remote Monitoring

In Monitor mode, all measurement data is transferred in real-time to the Fluke Connect® Cloud for secure storage. From the cloud, measurement data is accessible anywhere to your team with a supported mobile device or PC web browser. Only users that are part of a Team defined in Fluke Connect can access this data.

To sync data to the Fluke Connect Cloud, the Monitor must be connected to an access point. This connection requires a DHCP service running in the access point that automatically assigns IP addresses.

To connect to a WiFi access point:

1. Push **F3** (Change Mode).
2. Select **Remote Monitoring** and push **SAVE ENTER**.
3. Push **F1** (Select SSID).
 - A list of access points within range show on the display
 - Icons show the field strength
 - Avoid access points with no bars or only one green bar since they are too far away for a reliable connection
4. Push **▲ ▼** to highlight an access point.
5. Push **SAVE ENTER** to confirm.

If the access point requires a passphrase, the Passphrase screen shows on the display.
6. Enter the passphrase (also known as security key or password) and push **SAVE ENTER**. The passphrase has 8 to 63 characters and is configured in the access point.

7. Push **F4** (Back) to return to the main Monitor screen.
8. Touch **Start Monitoring** on the Monitor screen.

Note

At the start of the monitoring session, the Monitor syncs the actual time with an NTP time server on the Internet.

The Monitor sends all measurement values (corresponding with the selected topology) at 1 s intervals to the Fluke Connect Cloud. The display shows:

- active power readings for each phase
- total power
- minimum and maximum values since the start of the monitoring session
- elapsed time in the duration field
- **Connected** in the status field when the connection to the Fluke Connect Cloud is working correctly
- **Disconnected** in the status field when the connection is not available

The Monitor buffers the measurement data for a maximum time span of 1 hour. If the reconnection is successful, the Monitor starts to send the buffered measurement data and continues to send new measurement values so that all data is transferred to the Fluke Connect Cloud.

Start Local Logging

Logger mode starts a session to store all measurement data on the Monitor. The Fluke Connect App syncs this logged measurement data to the Fluke Connect Cloud.

When sync'd to the Fluke Connect Cloud, measurement data is accessible from any location with a supported mobile device or a computer's web browser. Only users that are part of a Team defined in Fluke Connect can access this data.

To start a Local Logging session:

1. Push **F3** (Change Mode).
2. Select **Local Logging** to set up the Monitor for local logging of data.

In Logger mode, the Monitor acts as a WiFi hotspot with the SSID as shown on the screen. This WiFi mode is the same as during Session Setup.

3. Push **F4** (Back) to return to the main Monitor screen.
4. Touch **Start Logging** on the Monitor screen.
The Monitor starts logging all measurements (corresponding with the selected topology) at 1 s intervals. The display shows:
 - active power readings for each phase
 - total power
 - minimum and maximum values since the start of the monitoring session
 - start time and proposed end time until memory is full
 - progress bar until memory is full
5. Touch **Stop Logging** on the Monitor screen.

On a mobile device that supports Fluke Connect the logged data can be downloaded and later sync'd to the Fluke Connect Cloud.

1. On the mobile device, go to the list of available WiFi networks and look for a network with the name **FLUKE3540FC<serial-no>**.
Example: **FLUKE3540FC<12345678>**
2. Enter the passphrase provided on the Monitor screen when you are asked.

Note

Depending on the operating system of the mobile device, the passphrase is also called security key, password, or similar phrase.

After a few seconds the connection is established. You are now ready to use the Fluke Connect app on the mobile device to make a connection with the Monitor.

View Data

When an internet connection is available on the mobile device the data automatically uploads to the Fluke Connect Cloud. The measured data is viewed with the Fluke Connect app on your mobile device or from the Fluke Connect website.

In Fluke Connect the data is accessed by selecting the Asset.

Alarm Notifications

Threshold settings are defined to trigger an alarm notification. The notification informs team members of changes in measurement values that may require immediate attention.

In the Fluke Connect Cloud the settings are available for who receives alarm notifications, the threshold values for each measurement, and how the notifications are received.

Memory/Settings Button

In this menu you can:

- Erase the data from completed logging sessions
- Review and erase screen captures
- Copy screen captures to the USB flash drive
- Make adjustments to the instrument settings

Logging Sessions

The list of stored logging sessions is available with **F1** (Logging Sessions).

1. Push **▲▼** to move the screen highlight to the logging session of interest.

Additional information such as start and end time, duration, asset, and file size are shown.

2. Push **F1** (Delete) to delete the selected logging session. Push **F2** to delete all logging sessions.

Note

An active logging session cannot be deleted. Stop the logging session before you delete.

Screen Capture

In this screen you can review, erase, and copy saved screens to a USB flash drive.

1. Push **MEMORY SETTINGS**.
2. Push **F2** (Screen Capture) to show the list of all screens. See *Basic Navigation* for information about how to capture screens.
3. Push **▲▼** to move the screen highlight to a screen of interest. A thumbnail image of the screen is shown for easy identification.
4. Use **F1** (Delete) to delete the selected screen. Push **F2** to delete all screens.
5. Push **F3** or (Save All to USB) to copy all screens to an attached USB flash drive.

Instrument Settings

The Monitor has settings for date and time, phase information, firmware version and update, WiFi configuration, and touch screen calibration.

To change the settings:







1. Push **MEMORY SETTINGS**.
2. Push **F4** (Instrument Settings).

Phase Color/Phase Labels

The phase colors are configurable to match with the connector panel decal. These schemes are available:

	A/L1	B/L2	C/L3	N
US	black	red	blue	white
Canada	red	black	blue	white
EU	brown	black	grey	blue
UK (old)	red	yellow	blue	black
China	yellow	green	red	blue

To change the phase color/phase labels:





1. Push .
2. Push  (Instrument Settings).
3. Push  to highlight **Phases** and push  or touch **Phases** target.
4. Select one of the available schemes.
5. Push  to toggle the phase label between **A-B-C** and **L1-L2-L3**.
6. Push  to confirm the selection.

Date/Time Zone







The Monitor stores the measurement data in universal time coordinate (UTC) to ensure continuity in time and accounts for time changes due to daylight saving time (DST).

To display the time stamps of the measurement data correctly, it is required to set the time zone. The Monitor adjusts automatically to DST. For example, a 1-week measurement started on 2-Nov-2013 8:00 am ends on 9-Nov-2013 08:00 am even though the clock was set back on 3-Nov-2013 from 02:00 to 01:00.





To set the time zone:

1. Push .
2. Push  (Instrument Settings).
3. Push  to highlight **Time Zone** and push  or touch **Time Zone** target.
4. Select the regions/continents.
5. Push .
6. Continue to select the country/city/time zone until the time zone configuration is done and the Instrument Settings menu shows.

To set the date format:

1. Push .
2. Push  (Instrument Settings).
3. Push   to highlight the **Date Format** target and push  or touch the **Date Format** target.
4. Select one of the available date formats.
5. Push  to toggle between a 12-hour or 24-hour format. A preview of the configured date format shows on the display.
6. Push  to confirm the selection.

To change the time:

1. Push .
2. Push  (Instrument Settings).
3. Push   to highlight the **Time** target and push  or touch the **Time** target.
4. Touch the **+** and **-** targets for each field.

As an alternate option, push  (Clock Synchronization). If the Monitor is connected to the Internet, it connects with the NTP time server and automatically adjusts to the real time.

5. Push  to confirm the change and exit the screen.





Note

When the Monitor is connected to the Internet and a monitoring session is started, the Monitor connects with the NTP time server and automatically adjusts to the real time.

Status Information





The screen provides information and status about the Monitor, such as the serial number, attached current probes, battery status, and installed licenses.

To go to the status information:

1. Push .
2. Push  (Instrument Settings).
3. Push  (Info).
4. Push  to exit the screen.

Firmware Version





To find the firmware version installed on your Monitor:

1. Push .
2. Push  (Instrument Settings).
3. Push  (Info).
4. Push  (Firmware Version). The screen shows the firmware version.
5. Push  to exit the screen.

Touch Screen Calibration

The touch screen has been calibrated at the factory before shipment. In case you do experience misalignment with the touch targets, use the touch screen calibration feature.







To calibrate:

1. Push .
2. Push  (Instrument Settings).
3. Push  (Tools).
4. Push  to highlight **Touch Screen Calibration** and push  or touch the **Touch Screen Calibration** target.
5. Touch the five cross hair targets as exactly as possible.

Copy Service Data to USB

If requested for customer support, use this function to copy all measurement files in raw format and system information to a USB flash drive.





To copy the service data:

1. Attach a USB flash drive with sufficient available memory (depending on the file size of stored logging sessions maximum 500 MByte).
2. Press  to exit the USB-Transfer screen.
3. Push .
4. Push  (Instrument Settings).
5. Push  (Tools).
6. Push  to highlight the **Copy service data to USB** target and push  or touch **Copy service data to USB target** to start the copy process.



Reset to Factory Defaults

The reset function deletes all user data, such as logging sessions and screen captures, and sets the instrument settings to default values. It also enables the first-time use wizard the next time the instrument boots.

To reset:

1. Push .
2. Push  (Instrument Settings).
3. Push  (Tools).
4. Push  to highlight **Reset to Factory Defaults** and push  or touch **Reset to Factory Defaults** target.

A display message prompts you to continue or cancel the reset.

The Monitor is reset to factory defaults also when you simultaneously push and hold the buttons , , and  while the Monitor starts.

Firmware Update



To update:

1. Take a USB flash drive with at least 80 MB of free space available and create a folder called "Fluke354xFC" (no spaces in file name).

Note

Make sure the USB is formatted with FAT or FAT32 file system.

In Windows USB flash drives ≥ 32 GB can be formatted with FAT/FAT32 only by using 3rd party tools.







2. Copy the firmware file (*.bin) into this folder.
3. Make sure the Monitor is powered from mains and operating.
4. Plug the flash drive into the Monitor. The USB Transfer screen pops up and offers the firmware update.
5. Push   to select the firmware update and push .
6. Follow the instructions. When the firmware update is complete the Monitor reboots automatically.

Note

A firmware update deletes all user data such as measurement data and screen captures.

This firmware update works only when the firmware version on the USB flash drive is newer than the installed version.

To install the same version or an older version:



1. Push .
2. Push  (Instrument Settings).
3. Push  (Tools).
4. Push   to select **Firmware Update** and push  or touch the **Firmware Update** target.

Note

If more than one firmware file (.bin) is located in the \Fluke3540xFC folder, the newest version is used for the update.*

First-time Use/Setup Wizard

To start the Monitor:

1. Attach the power supply to the Monitor or use the DC power cable to connect the Power Supply with the Monitor.
2. Connect the power cord into the power supply.
The Monitor starts in <30 seconds and the Setup Wizard starts.
3. Push  (Next) or  to navigate to the next page.
4. Push  (Cancel) to close the setup wizard. If you cancel, the setup wizard starts again on next startup of the Monitor.
5. Pick the work standards for your region. This action selects the color codes and the phase descriptor (A, B, C, N or L1, L2, L3, N).

This is the best time to apply the correlating decal on the connector panel. The decal helps you to quickly identify the appropriate voltage test lead and current probe for the different phases and neutral.

6. Attach the cable markers to the current probe cables.
7. Pick your time zone and date format. Confirm that the correct date and time are shown on the screen.

The Monitor is now ready for the first measurements.

Note

Be aware that for power measurements in 3-phase systems:

- *Total Active Power (W) is the sum of the individual phases.*
- *Total Fundamental Power (W and var) only delivers the sum of each phase when the phase rotation is clockwise. It is zero when the phase rotation is counter-clockwise.*

First Measurements

At the site, look at the information in the panel and the rating plates on the machines. Based on knowledge of the electrical supply in the facility, determine the configuration.

To start measurements:

1. Connect the Monitor to mains power.

Note

See Measurement Line Power Source for information on how to power the Monitor from the measurement line.

The Monitor starts and shows the Monitor/Logger Setup screen.

2. Push **F1** (Configure).

Confirm the study type and the wiring configuration is correct. For most applications the current range is set to Auto and the voltage and current ranges are 1:1. Configure the gain, offset, and engineering unit of measurement for the sensors attached to the Auxiliary inputs.

3. Push **F1** (Configuration Diagram) for guidance on the voltage test lead and current probe connections.
4. Plug the voltage test leads into the Monitor.

5. Use the iFlex current probes and plug the phase A current probe into the phase A/L1 input jack on the Monitor, the phase B/L2 current probe into the phase B/L2 input jack on the Monitor, and the phase C/L3 current probe into the phase C/L3 input jack on the Monitor.
 6. Apply the iFlex Probes to the wires in the electrical panel. Make sure the arrow on the probe points to the load.
 7. Connect the voltage test leads to neutral, phase A/L1, phase B/L2, and phase C/L3.
 8. Push **F2** (Verify) to:
 - check the voltage and current readings
 - correct the phase rotation, phase mapping, and polarity of current probes
- Note*
Most installations use a clockwise rotation.
9. Push **F4** (Back) to return to the MONITOR/LOGGER setup screen.
 10. Push **F3** (Change Mode) and select **Session Setup** to configure the asset with the Fluke Connect app.
 11. Select **Remote Monitoring** and push **F1** (SSID) to connect to an SSID.
 12. Push **F4** (Back) to return to the MONITOR/LOGGER setup screen.

13. Push **Start Monitoring**.

You can review the live data with **METER** or **POWER**. Return to the active monitoring session with **MONITOR/LOGGER**. Data is accessible also from the Fluke Connect Cloud.

Maintenance

If the Monitor is used appropriately it does not require special maintenance or repair. Maintenance work may be executed only by trained and qualified personnel. This work may only be done at a company related service center within the guarantee period.

Warning

To prevent possible electrical shock, fire, or personal injury:

- **Do not operate the Product with covers removed or the case open. Hazardous voltage exposure is possible.**
- **Remove the input signals before you clean the Product.**
- **Use only specified replacement parts.**
- **Have an approved technician repair the Product.**

How to Clean

Caution

To avoid damage, do not use abrasives or solvents on this instrument.

If the Monitor is dirty, wipe it off carefully with a damp cloth (without cleaning agents). Mild soap may be used.

Battery Replacement

Warning

To prevent possible electrical shock, fire, or personal injury:

- Do not short the battery terminals together.
- Do not disassemble or crush battery cells and battery packs.
- Do not put battery cells and battery packs near heat or fire. Do not put in sunlight. Disconnect the battery charger and move the Product or battery to a cool, non-flammable location if the rechargeable battery becomes hot (>50 °C) during the charge period.
- Have an approved technician repair the Product.

Caution

Replace the rechargeable battery after 5 years of moderate use or 2 years of heavy use. Moderate use is defined as recharged twice a week. Heavy use is defined as discharged to cutoff and recharged daily.

The Monitor has an internal rechargeable Lithium-ion battery.

To replace the battery:

1. Remove the Power Supply (see Figure 1).
2. Unscrew the four screws and remove the battery door.
3. Replace the battery.
4. Fasten the battery door.

Caution

To prevent damage to the Product, use only original Fluke batteries.

Service and Parts

Replacement parts and accessories are listed in Table 6 and shown in Figure 10. To order parts and accessories, see *How to Contact Fluke*.

Table 6. Replacement Parts

Ref.	Description	Qty.	Fluke Part or Model Number
①	Power Supply 3540	1	4743446
②	Battery Door	1	4388072
③	Battery Pack, Li ion 3.7 V 2500 mAh	1	4146702
④	USB Cable	1	4704200
⑤	Input Decal	1	varies
⑥	Mains Power Cable	1	see Table 1
⑦	Test Leads 0.18 m blue, 1000 V CAT III	1 set	5016873
⑧	Test Leads 2 m, 2x alligator clips, blue, 1000 V CAT III	1 set	5020006
⑨	Cable Marker	1 set	5046009

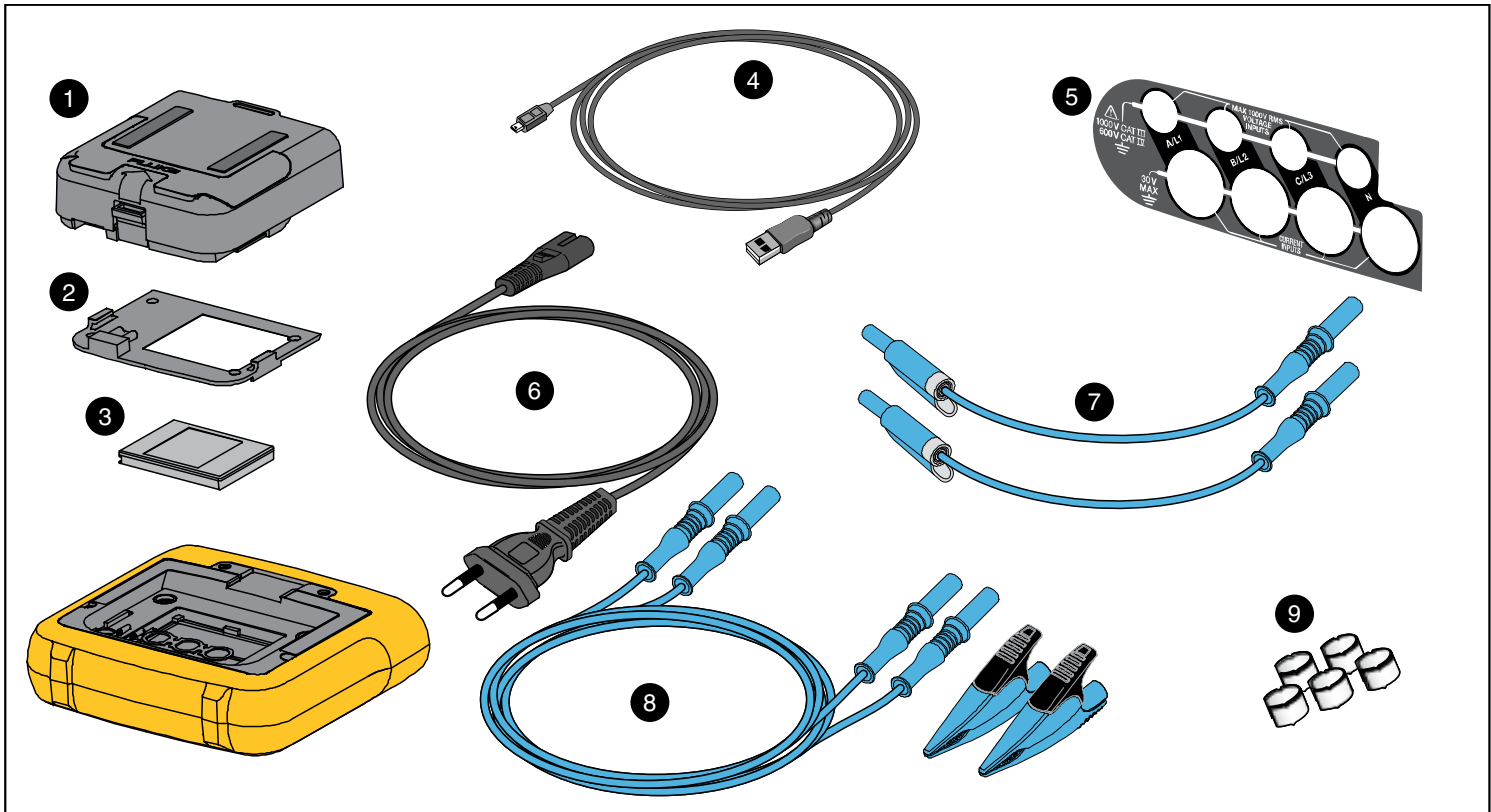

Figure 10. Replacement Parts

hcf060.ernf

Wiring Configurations

V, A, Hz, +

		Single Phase Single Phase IT	Split Phase (2P-3W)	3-Φ Wye 3-Φ Wye IT (3P-4W)	3-Φ Wye Balanced	3-Φ Delta (3P-3W)	2 Element Delta Aron/ Blondel	3-Φ Delta Open Leg (3P-3W)	3-Φ High Leg Delta	Balanced 3-Φ Delta
$V_{AN}^{[1]}$	V	●	●	●	●					
$V_{BN}^{[1]}$	V		●	●	○					
$V_{CN}^{[1]}$	V			●	○					
$V_{AB}^{[1]}$	V		● ^[2]	● ^[2]	○ ^[2]	●	●	●	●	●
$V_{BC}^{[1]}$	V			● ^[2]	○ ^[2]	●	●	●	●	○
$V_{CA}^{[1]}$	V			● ^[2]	○ ^[2]	●	●	●	●	○
unbal	%			●		●	●	●	●	
I_A	A	●	●	●	●	●	●	●	●	●
I_B	A		●	●	○	●	△	●	●	○
I_C	A			●	○	●	●	●	●	○
f	Hz	●	●	●	●	●	●	●	●	●
THD $V_A^{[3]}$	%	●	●	●	●					
THD $V_B^{[3]}$	%		●	●						
THD $V_C^{[3]}$	%			●						
THD $V_{AB}^{[3]}$	%					●	●	●	●	●
THD $V_{BC}^{[3]}$	%					●	●	●	●	
THD $V_{CA}^{[3]}$	V, %					●	●	●	●	
THD I_A	A, %	●	●	●	●	●	●	●	●	●
THD I_B	A, %		●	●		●	●	●	●	
THD I_C	A, %			●		●	●	●	●	

● = Measured values △ = Calculated values ○ = Simulated values (derived from phase 1)
 [1] Simulated in load studies if U_{nom} is specified
 [2] Secondary displayed values
 [3] Not available in load studies

Power

		Single Phase Single Phase IT	Split Phase (2P-3W)	3-Φ Wye 3-Φ Wye IT (3P-4W)	3-Φ Wye Balanced	3-Φ Delta (3P-3W)	2 Element Delta Aron/Blondel	3-Φ Delta Open Leg (3P-3W)	3-Φ High Leg Delta	3-Φ Delta Balanced
$P_A, P_{A \text{ fund}}^{[3]}$	W	●	●	●	●					
$P_B, P_{B \text{ fund}}^{[3]}$	W		●	●	○					
$P_C, P_{C \text{ fund}}^{[3]}$	W			●	○					
$P_{\text{Total}}, P_{\text{Total fund}}^{[3]}$	W		●	●	○	●	●	●	●	●
$Q_A, Q_{A \text{ fund}}^{[3]}$	var	●	●	●	●					
$Q_B, Q_{B \text{ fund}}^{[3]}$	var		●	●	○					
$Q_C, Q_{C \text{ fund}}^{[3]}$	var			●	○					
$Q_{\text{Total}}, Q_{\text{Total fund}}^{[3]}$	var			●	○	●	●	●	●	●
$S_A^{[1]}$	VA	●	●	●	●					
$S_B^{[1]}$	VA		●	●	○					
$S_C^{[1]}$	VA			●	○					
$S_{\text{TOTAL}}^{[1]}$	VA		●	●	○	●	●	●	●	●
$PF_A^{[3]}$		●	●	●	●					
$PF_B^{[3]}$			●	●	○					
$PF_C^{[3]}$				●	○					
$PF_{\text{Total}}^{[3]}$			●	●	○	●	●	●	●	●
<p>● = Measured values [1] Simulated in load studies if U_{nom} is specified [2] Secondary displayed values [3] Not available in load studies ○ = Simulated values (derived from phase 1)</p>										

General Specifications

Maximum Voltage between any Terminal and Earth Ground	1000 V
Color LCD Display	4.3-inch active matrix color TFT, 480 pixels x 272 pixels, resistive touch panel
Power/Charging/LED Indicator	
Warranty	
3540 FC and Power Supply	2 years (battery not included)
Accessories	1 year
Calibration Cycle	2 years
Dimensions	
3540 FC	19.8 cm x 16.7 cm x 5.5 cm (7.8 in x 6.6 in x 2.2 in)
Power Supply	13.0 cm x 13.0 cm x 4.5 cm (5.1 in x 5.1 in x 1.8 in)
3540 FC with power supply attached	19.8 cm x 16.7 cm x 9 cm (7.8 in x 6.6 in x 4.0 in)
Weight	
3540 FC	1.1 kg (2.5 lb)
Power Supply	400 g (0.9 lb)
Tamper Protection	Kensington lock

Environmental Specifications

Operating Temperature	0 °C to 45 °C (32 °F to 113 °F)
Storage Temperature	-20 °C to +60 °C (-4 °F to +140 °F), with battery: -20 °C to +50 °C (-4 °F to +122 °F)
Operating Humidity	<10 °C (<50 °F) non condensing
	10 °C to 30 °C (50 °F to 86 °F) ≤95 %
	30 °C to 40 °C (86 °F to 104 °F) ≤75 %
	40 °C to 45 °C (104 °F to 113 °F) ≤45 %
Operating Altitude	2000 m (up to 4000 m derate to 1000 V CAT II/600 V CAT III/300 V CAT IV)
Storage Altitude	12 000 m
IP Rating	IEC 60529:IP50, in connected condition with protection caps in place
Vibration	MIL-T-28800E, Type 3, Class III, Style B

Safety

General	IEC 61010-1: Pollution Degree 2
Mains Input (IEC C8)	Overvoltage Category II
Mains Input (4 mm test lead)	Overvoltage Category IV
Measurement.....	IEC 61010-2-033: CAT IV 600 V / CAT III 1000 V
Li-ion Battery.....	IEC 62133

Electromagnetic Compatibility (EMC)

International	IEC 61326-1: Industrial CISPR 11: Group 1, Class A
---------------------	---

Group 1: Equipment has intentionally generated and/or uses conductively-coupled radio frequency energy that is necessary for the internal function of the equipment itself.

Class A: Equipment is suitable for use in all establishments other than domestic and those directly connected to a low-voltage power supply network that supplies buildings used for domestic purposes. There may be potential difficulties in ensuring electromagnetic compatibility in other environments due to conducted and radiated disturbances.

Emissions that exceed the levels required by CISPR 11 can occur when the equipment is connected to a test object.

Korea (KCC)	Class A Equipment (Industrial Broadcasting & Communication Equipment)
-------------------	---

Class A: Equipment meets requirements for industrial electromagnetic wave equipment and the seller or user should take notice of it. This equipment is intended for use in business environments and not to be used in homes.

USA (FCC).....	47 CFR 15 subpart B. This product is considered an exempt device per clause 15.103.
----------------	---

Wireless Radio with Adapter

Frequency Range	2412 MHz to 2462 MHz
Output Power.....	<100 mW

Electrical Specifications

Power Supply

Voltage Range	nominal 100 V to 500 V (85 V min to 550 V max) using safety plug input
Mains Power	nominal 100 V to 240 V (85 V min to 265 V max) using IEC 60320 C7 input (figure 8 power cord)
Power consumption	Maximum 50 VA (max. 15 VA when powered using IEC 60320 input)
Standby Power	<0.3 W only when powered using IEC 60320 input
Efficiency	≥68.2 % (in accordance with energy efficiency regulations)
Mains Frequency	50/60 Hz ±15 %

Battery Li-ion 3.7 V, 9.25 Wh, 2500 mAh, customer-replaceable

Operating Temperature	0 °C to 45 °C (32 °F to 113 °F)
Storage temperature.....	-20 °C to +50 °C (-4 °F to +122 °F)
Charge	0 °C to 45 °C (32 °F to 113 °F)
On-Battery Runtime	Up to 4 hr (up to 5.5 hr in energy saving mode)
Charging Time	<6 hr

Voltage Inputs

Number of Inputs	4 (3 phases and neutral)
Maximum Input Voltage.....	1000 V _{rms} (1700 V _{pk}) phase to neutral
Input Impedance	10 MΩ each phase to neutral
Bandwidth	42.5 Hz – 3.5 kHz
Scaling	1:1, variable

Current Inputs

Number of Inputs	3, mode selected automatically for attached sensor
Current Sensor Output Voltage	
Clamp	500 mV _{rms} / 50 mV _{rms} ; CF 2.8
Rogowski Coil.....	150 mV _{rms} / 15 mV _{rms} at 50 Hz, 180 mV _{rms} / 18 mV _{rms} at 60 Hz; CF 4; all at nominal probe range
Range	1 A to 150 A / 10 A to 1500 A with iFlex1500-12 3 A to 300 A / 30 A to 3000 A with iFlex3000-24 6 A to 600 A / 60 A to 6000 A with iFlex6000-36 40 mA to 4 A / 0.4 A to 40 A with 40 A clamp i40s-EL
Bandwidth	42.5 Hz – 3.5 kHz
Scaling	1:1, variable

Data Acquisition

Resolution.....	16-bit synchronous sampling
Sampling Frequency.....	10.24 kHz at 50/60 Hz, synchronized to mains frequency
Input Signal Frequency.....	50/60 Hz (42.5 Hz to 69 Hz)
Wiring Configurations	1- Φ , 1- Φ IT, Split phase, 3- Φ wye, 3- Φ wye IT, 3- Φ wye balanced, 3- Φ delta, 3- Φ Aron/Blondel (2-element delta), 3- Φ delta open leg, 3- Φ high leg delta, 3- Φ delta balanced. Currents only (load studies)
Data Storage.....	Internal flash memory (not user replaceable)
Memory Size.....	Typical is 1 offline logging session of 1 week with 1 s intervals. The number of possible logging sessions and logging period depends on user requirements.

Basic Interval

Measured Parameters	Voltage, Current, Frequency, THD V, THD A, Power, Power Factor, fundamental Power, DPF
Averaging Interval.....	1 s
Total Harmonic Distortion	THD for voltage and current is calculated on 25 harmonics
Averaging time min/max values	
Voltage.....	Full cycle RMS (20 ms at 50 Hz, 16.7 ms at 60 Hz)
Current.....	Half cycle RMS (10 ms at 50 Hz, 8.3 ms at 60 Hz)

Interfaces

USB-A.....	Firmware updates, max. supply current: 120 mA
WiFi	
Supported modes	Direct connection and connection to infrastructure
Security.....	WPA2-AES with pre-shared key

Accuracy at Reference Conditions

Parameter		Range	Max. Resolution	Intrinsic Accuracy at Reference Conditions (% of Reading + % of Range)	
Voltage		1000 V	0.1 V	±(0.2 % + 0.01 %)	
Current	Direct Input	Rogowski Mode	15 mV	0.01 mV	±(0.3 % + 0.02 %)
		Clamp Mode	150 mV	0.1 mV	±(0.3 % + 0.02 %)
			50 mV	0.01 mV	±(0.2 % + 0.02 %)
		1500 A iFlex	500 mV	0.1 mV	±(0.2 % + 0.02 %)
	150 A		0.01 A	±(1 % + 0.02 %)	
	3000 A iFlex	1500 A	0.1 A	±(1 % + 0.02 %)	
		300 A	1 A	±(1 % + 0.03 %)	
	6000 A iFlex	3000 A	10 A	±(1 % + 0.03 %)	
		600 A	1 A	±(1.5 % + 0.03 %)	
	40 A	6000 A	10 A	±(1.5 % + 0.03 %)	
4 A		1 mA	±(0.7 % + 0.02 %)		
		40 A	10 mA	±(0.7 % + 0.02 %)	
Frequency		42.5 Hz to 69 Hz	0.01 Hz	±0.1 %	
Voltage Min/Max		1000 V	0.1 V	±(1 % + 0.1 %)	
Current Min/Max		defined by accessory	defined by accessory	±(5 % + 0.2 %)	
THD on Voltage		1000 %	0.1 %	±(2.5 % + 0.05 %)	
THD on Current		1000 %	0.1 %	±(2.5 % + 0.05 %)	
Power/Energy					
Parameter	Direct Input ^[1]	iFlex1500-12	iFlex3000-24	iFlex6000-36	i40S-EL
	Clamp: 50 mV/500 mV Rogowski: 15 mV/150 mV	150 A/1500 A	300 A/3000 A	600/6000 A	4 A/40 A
Power Range W, VA, var	Clamp: 50 W/500 W Rogowski: 15 W/150 W	150 kW/1.5 MW	300 kW/3 MW	600 kW/6 MW	4 kW/40 kW
Max. Resolution W, VA, var	0.1 W	0.01 kW/0.10 kW	1 kW/10 kW	1 kW/10 kW	1 W/10 W
Max. Resolution PF, DPF	0.01				
Phase (Voltage to Current) ^[1]	±0.2 °	±0.28 °			±1 °
[1] Only for calibration laboratories					

Intrinsic Uncertainty \pm (% of measurement value + % of power range)						
Parameter	Influence Quantity	Direct Input ^[1]	iFlex1500-12	iFlex3000-24	iFlex6000-36	i40S-EL
		Clamp: 50 mV/500 mV Rogowski: 15 mV/150 mV	150 A/1500 A	300 A/3000 A	600/6000 A	4 A/40 A
Active Power P	PF ≥ 0.99	0.5 % + 0.005 %	1.2 % + 0.005 %	1.2 % + 0.0075 %	1.7 % + 0.0075 %	1.2 % + 0.005 %
	0.1 \leq PF < 0.99	see Formula 1	see Formula 2	see Formula 3	see Formula 4	see Formula 5
Apparent Power S	0 \leq PF \leq 1	0.5 % + 0.005 %	1.2 % + 0.005 %	1.2 % + 0.0075 %	1.7 % + 0.0075 %	1.2 % + 0.005 %
Reactive Power Q	0 \leq PF \leq 1	2.5 % of measured apparent power/energy				
Power Factor PF Displacement Power Factor DPF/cos ϕ	-	Reading \pm 0.025				
Additional uncertainty (% of power high-range)	V _{P-N} > 250 V	0.015 %	0.015 %	0.0225 %	0.0225 %	0.015 %
<p>[1] Only for calibration laboratories</p> <p>Reference Conditions: Environmental: 23 °C \pm 5 °C, instrument operating for at least 30 minutes, no external electrical/magnetic field, RH < 65 % Input conditions: CosΦ/PF=1, Sinusoidal signal f=50/60 Hz, power supply 120 V/230 V \pm 10 % Current and power specifications: Input voltage 1ph: 120 V/230 V or 3ph wye/delta: 230 V/400 V Input current > 10 % of current range Primary conductor of clamps or Rogowski coil in center position Temperature Coefficient: Add 0.1 x specified accuracy for each degree C above 28 °C or below 18 °C</p>						

Formula 1: $\left(0.5 + \frac{\sqrt{1 - PF^2}}{3 \times PF}\right) \% + 0.005 \%$

Formula 2: $\left(1.2 + \frac{\sqrt{1 - PF^2}}{2 \times PF}\right) \% + 0.005 \%$

Formula 3: $\left(1.2 + \frac{\sqrt{1 - PF^2}}{2 \times PF}\right) \% + 0.0075 \%$

Formula 4: $\left(1.7 + \frac{\sqrt{1 - PF^2}}{2 \times PF}\right) \% + 0.0075 \%$

Formula 5: $\left(1.2 + 1.7 \times \frac{\sqrt{1 - PF^2}}{PF}\right) \% + 0.005 \%$

Example:

Measurement at 120 V/16 A using an iFlex1500-12 in low range. Power Factor is 0.8

Active power uncertainty σ_P :

$$\sigma_P = \pm \left(\left(1.2 \% + \frac{\sqrt{1 - 0.8^2}}{2 \times 0.8} \right) + 0.005 \% \times P_{\text{Range}} \right) = \pm (1.575 \% + 0.005 \% \times 1000 \text{ V} \times 150 \text{ A}) = \pm (1.575 \% + 7.5 \text{ W})$$

The uncertainty in W is $\pm (1.575 \% \times 120 \text{ V} \times 16 \text{ A} \times 0.8 + 7.5 \text{ W}) = \pm 31.7 \text{ W}$

Apparent power uncertainty σ_S :

$$\sigma_S = \pm (1.2 \% + 0.005 \% \times S_{\text{Range}}) = \pm (1.2 \% + 0.005 \% \times 1000 \text{ V} \times 150 \text{ A}) = \pm (1.2 \% + 7.5 \text{ VA})$$

The uncertainty in VA is $\pm (1.2 \% \times 120 \text{ V} \times 16 \text{ A} + 7.5 \text{ VA}) = \pm 30.54 \text{ VA}$

Reactive/non-active power uncertainty σ_Q :

$$\sigma_Q = \pm (2.5 \% \times S) = \pm (2.5 \% \times 120 \text{ V} \times 16 \text{ A}) = \pm 48 \text{ var}$$

In case of a measured voltage that is >250 V, the additional error is calculated with:

$$\text{Adder} = 0.015 \% \times S_{\text{High Range}} = 0.015 \% \times 1000 \text{ V} \times 1500 \text{ A} = 225 \text{ WVA/var}$$

iFlex Probe Specifications

Measuring range

iFlex 1500-12	1 to 150 A ac / 10 to 1500 A ac
iFlex 3000-24	3 to 300 A ac / 30 to 3000 A ac
iFlex 6000-36	6 to 600 A ac / 60 to 6000 A ac
Nondestructive current.....	100 kA (50/60 Hz)

Intrinsic Error at reference condition^[1]

..... $\pm 0.7\%$ of reading

Accuracy 3540 FC + iFlex

iFlex 1500-12 & iFlex 3000-24	$\pm(1\%$ of reading + 0.02 % of range)
iFlex 6000-36	$\pm(1.5\%$ of reading + 0.03 % of range)

Temperature Coefficient over operating temperature range

iFlex 1500-12 & iFlex 3000-24	0.05 % of reading / °C (0.09 % of reading / °F)
iFlex 6000-36	0.1 % of reading / °C (0.18 % of reading / °F)

Positioning error with position of conductor in the probe window (see Figure 11).

	iFlex1500-12, iFlex3000-24	iFlex6000-36
Probe Window A	$\pm(1\%$ of reading + 0.02 % of range)	$\pm(1.5\%$ of reading + 0.03 % of range)
Probe Window B	$\pm(1.5\%$ of reading + 0.02 % of range)	$\pm(2.0\%$ of reading + 0.03 % of range)
Probe Window C	$\pm(2.5\%$ of reading + 0.02 % of range)	$\pm(4\%$ of reading + 0.03 % of range)

External magnetic field rejection in reference to external current (with cable >100 mm from the head-coupling and r-coil) 40 dB
Phase shift $< \pm 0.5^\circ$

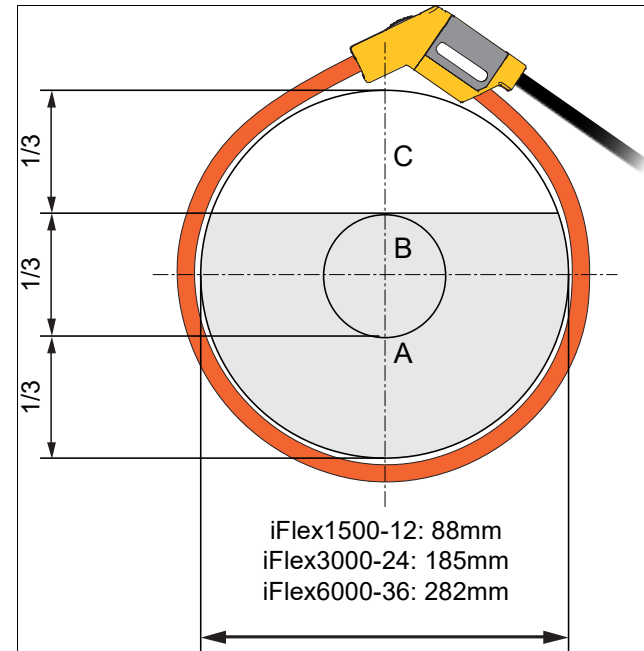

hcf057.eps

Figure 11. iFlex Probe Window

Bandwidth 10 Hz to 23.5 kHz
Frequency derating $I \times f \leq 385 \text{ kA Hz}$
Working Voltage..... 1000 V CAT III, 600 V CAT IV

[1] Reference Condition:

- Environmental: 23 °C ± 5 °C, no external electrical/magnetic field, RH 65 %
- Single primary conductor in center position

Transducer length	
iFlex 1500-12.....	305 mm (12 in)
iFlex 3000-24.....	610 mm (24 in)
iFlex 6000-36.....	915 mm (36 in)
Transducer cable diameter..... 7.5 mm (0.3 in)	
Minimum bending radius..... 38 mm (1.5 in)	
Output cable length	
iFlex 1500-12.....	2 m (6.6 ft)
iFlex 3000-24 & iFlex 6000-36.....	3 m (9.8 ft)
Weight	
iFlex 1500-12.....	115 g
iFlex 3000-24.....	170 g
iFlex 6000-36.....	190 g
Material	
Transducer cable.....	TPR
Coupling.....	POM + ABS/PC
Output cable.....	TPR/PVC
Operating Temperature.....	-20 °C to +70 °C (-4 °F to 158°F) temperature of conductor under test shall not exceed 80°C (176°F)
Storage temperature.....	-40 °C to +80 °C (-40 °F to +176 °F)
Operating relative humidity,.....	15 % to 85 % noncondensing
IP Rating.....	IEC 60529:IP50
Operating Altitude.....	2000 m (6500 ft) up to 4000 m (13 000 ft) derate to 1000 V CAT II/600 V CAT III/ 300 V CAT IV
Storage Altitude.....	12 km (40 000 ft)
Warranty.....	1 year

i40s-EL Current Clamp Specifications

See Table 7 for setup instructions.

Table 7. i40s-EL Setup

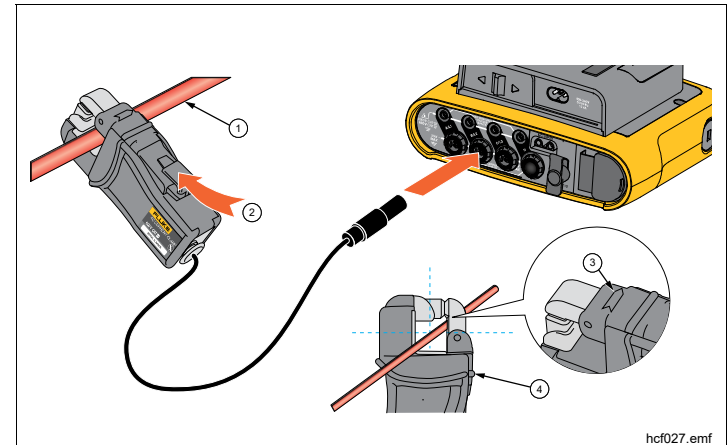

①	Single Insulated current carrying conductor
②	Release button
③	Load direction arrow
④	Tactile barrier

Measuring range.....	40 mA to 4 Aac / 0.4 Aac to 40 Aac
Crest factor.....	≤3
Nondestructive current.....	200 A (50/60Hz)
Intrinsic Error at reference condition.....	±0.5% of reading
Accuracy 173x + clamp.....	±(0.7 % of reading + 0.02% of range)

3540 FC
Users Manual

Phase shift

<40 mA	unspecified
40 mA to 400 mA	$< \pm 1.5^\circ$
400 mA to 40 A	$< \pm 1^\circ$

Temperature Coefficient over

operating temperature range	0.015 % of reading / °C
	0.027 % of reading / °F

Influence of adjacent conductor..... ≤ 15 mA/A (@ 50/60 Hz)

Influence of conductor position

in jaw opening..... ± 0.5 % of reading (@ 50/60 Hz)

Bandwidth..... 10 Hz to 2.5 kHz

Working Voltage..... 600 V CAT III, 300 V CAT IV

[1] Reference Condition:

- Environmental: 23 °C ± 5 °C, no external electrical/magnetic field, RH 65 %
- Primary conductor in center position

Size (H x W x L)..... 110 mm x 50 mm x 26 mm
(4.33 in x 1.97 in x 1.02 in)

Maximum conductor size..... 15 mm (0.59 in)

Output cable length..... 2 m (6.6 ft)

Weight..... 190 g (6.70 oz)

Material..... Case ABS and PC
Output cable: TPR/PVC

Temperature operating..... -10 °C to +55 °C
(-14 °F to 131 °F)

Temperature, non-operating..... -20 °C to +70 °C
(-4 °F to 158 °F)

Relative Humidity, operating..... 15 % to 85 % non-condensing

Max Operating Altitude 2000 m (6,500 ft)
up to 4000 m (13 000 ft) derate
to 600 V CAT II/300 V CAT IV

Max Storage Altitude 12 km (40 000 ft)

Warranty..... 1 year