

User Guide

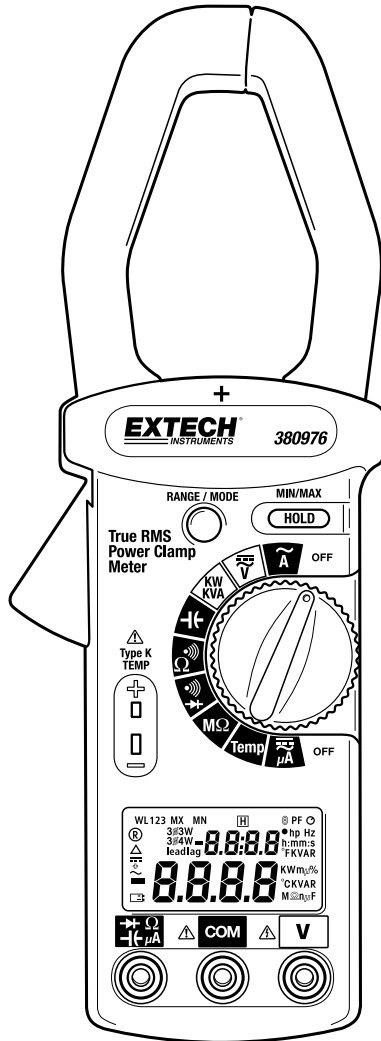

1 Φ /3 Φ 1000 Amp True RMS Power Clamp-On

Model 380976



Introduction

Congratulations on your purchase of the Extech 380976 Power Clamp-On Meter. This device measures 1 Φ /3 Φ Power (True, Apparent, and Reactive), Horsepower, Phase Angle, True RMS Current/Voltage, Resistance, Capacitance, Frequency, & Temperature. Power measurements can be achieved on 3- or 4-wire configurations. Please read the entire manual to get the most from the meter's wide array of capabilities. This meter is shipped fully tested and calibrated and, with proper use, will provide years of reliable service.

Table of Contents

<i>Warranty</i>	3
<i>Safety Information</i>	3
<i>Meter Description</i>	4
AC + DC Voltage Measurements	5
AC Current Measurements	5
1Φ KW, KVA, KVAR, Power Factor & Phase Angle Measurement	6
3Φ 3-Wire KW, HP, KVA, KVAR, Power Factor & Phase Angle Measurement	7
3Φ 4-Wire KW, HP, KVA, KVAR, Power Factor & Phase Angle Measurement	10
Resistance and Audible Continuity Measurements	13
Capacitance Measurements	14
Diode Tests	14
Temperature Measurements	14
AC and DC μA Current Measurements	14
<i>Meter Control Keys</i>	15
<i>Automatic Sleep Mode and Battery Replacement</i>	16
<i>Specifications</i>	17
<i>Calibration, Repair, and Technical Support Services</i>	20

Warranty

EXTECH INSTRUMENTS CORPORATION warrants this instrument to be free of defects in parts and workmanship for **one year** from date of shipment (a six month limited warranty applies to sensors and cables). If it should become necessary to return the instrument for service during or beyond the warranty period, contact the Customer Service Department at (781) 890-7440 ext. 210 for authorization or visit our website www.extech.com for contact information. A Return Authorization (RA) number must be issued before any product is returned to Extech. The sender is responsible for shipping charges, freight, insurance and proper packaging to prevent damage in transit. This warranty does not apply to defects resulting from action of the user such as misuse, improper wiring, operation outside of specification, improper maintenance or repair, or unauthorized modification. Extech specifically disclaims any implied warranties or merchantability or fitness for a specific purpose and will not be liable for any direct, indirect, incidental or consequential damages. Extech's total liability is limited to repair or replacement of the product. The warranty set forth above is inclusive and no other warranty, whether written or oral, is expressed or implied.

Safety Information

- Read the following safety information carefully before attempting to operate or service the meter.
- To avoid damage to the instrument do not exceed the maximum input limits shown in the technical specifications.
- Do not use the meter or test leads if they appear damaged.
- Use extreme caution when working around bare conductors or bus bars. Accidental contact with the conductor could result in electric shock.
- Use the meter only as specified in this manual; otherwise, the protection provided by the meter may be impaired.
- Read the operating instructions before use and follow all safety information.
- Use caution when working with voltages above 60VDC or 30VAC RMS. Such voltages represent a shock hazard.
- Before taking resistance measurements or testing continuity, disconnect the circuit under test from the main power supply and remove all loads from the circuit.

Safety symbols



Caution! Refer to this manual before using the meter.



Dangerous voltages.



Meter is protected throughout by double insulation or reinforced insulation.

When servicing, use only specified replacement parts.



Complies with EN-61010-1, IEC 1010-2-32

Meter Description

1. Transformer Jaws
2. Jaw opening trigger
3. Data Hold & MX/MN button
4. Function Selector
5. Range button
6. Temperature input jack
7. LCD Display
8. 'COM' input jack
9. 'V' input jack
10. Ω \rightarrow μ A input jack

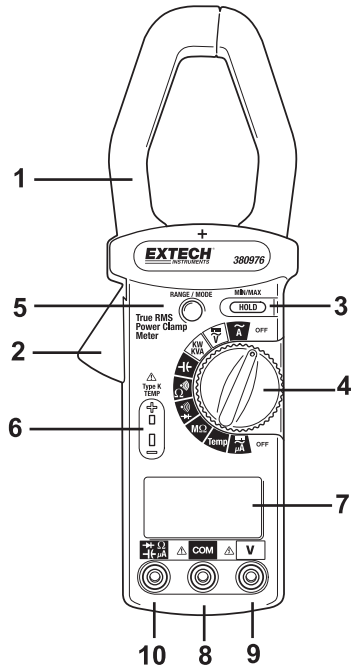

Measurements

AC + DC Voltage Measurements

WARNING

The maximum input is 600V. Do not attempt voltage measurements above this limit. Exceeding this limit could cause electrical shock and damage to the meter.

1. Set the rotary switch to the 'V' position.
2. Insert the test leads into the meter's input jacks. (Black to 'COM' and Red to 'V')
3. Connect the test leads to the measured circuit.
4. The meter will automatically detect and display AC or DC voltage. The meter will also automatically select the appropriate range.
5. Read the voltage (main display) and frequency (upper, smaller display digits) on the LCD.

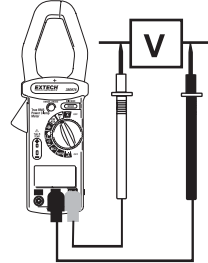

NOTE: The sensitivity for Automatic AC/DC Voltage detection is 1V. Voltage below 1V may indicate DC.

NOTE: The sensitivity for voltage measurements is 1.2V and the frequency range is 40Hz to 1 KHz. If the frequency is less than 40Hz the LCD may display 'Hz'.

AC Current Measurements

1. Set the rotary switch to the "~A" position.
2. Press the Trigger to open the jaw.
3. Fully enclose the conductor that is being measured in the jaw. No gap should exist between the two jaw halves. The conductor under test must be a single wire; if there are multiple wires in a cable the conductor must first be isolated (see diagram below).
4. The meter selects the range automatically.
5. Read the measured current (main display) and frequency (upper display) on the LCD.

NOTE: The sensitivity for current measurements is 6A and the frequency range is 40Hz to 400Hz. If the frequency is less than 40Hz the LCD may display 'Hz'.

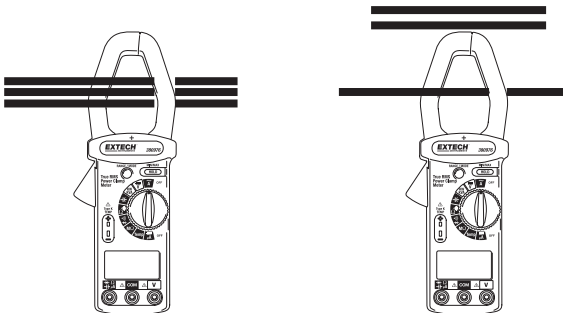

Incorrect

Correct

AC Power Measurements

1 Φ KW, KVA, KVAR, Power Factor & Phase Angle Measurement

1. Set the rotary switch to the 'KW/KVA' position.
2. Insert the test leads to the meter as follows: Black to 'COM' and Red to 'V'.
3. Connect the black lead to the neutral line.
4. Connect the red lead to the power line and clamp onto the same lead to which the red lead is connected.
5. The meter selects the best range automatically.
6. Select the desired display combination using the RANGE key. Press RANGE to scroll through the following combination displays:
 - kW and HP (horsepower)
 - kW and PF (power factor)
 - kW and KVAR (reactive power)
 - KVA and phase angle (θ)
 - V and A

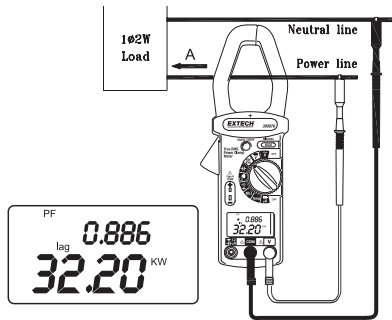

Note that **LEAD** and **LAG** icons are also displayed on the LCD to inform the user that the voltage is leading or lagging the current with regard to phase.

Note: Allow 2 seconds after each RANGE key press for the meter to update the display.

$$1 \text{ HP} = 746 \text{ Watts}$$

$$\text{PF} = \frac{\text{KW}}{\text{KVA}} = \cos\theta$$

$$\text{KVA (Apparent Power)} = (\text{V} \cdot \text{A}) / 1000$$

$$\text{KVAR (Reactive Power)} = \sqrt{(\text{KVA})^2 - (\text{KW})^2} = \text{KVA} \cdot \sin\theta$$

NOTES

1. The '+' sign printed on the meter must face the power source for best accuracy.
2. If the device under test is a switching mode power supply, the KW, PF, and Phase angle measurements may not be accurate.

3Φ 3-Wire KW, HP, KVA, KVAR, Power Factor & Phase Angle Measurement

1. First, measure $W_{RS(L1L2)}$ (refer to the diagram below).
 - a. Set the rotary switch to the “ $\overline{\sim}$ V”.
 - b. Press and hold the “HOLD” key while setting the rotary switch to “KW/KVA”, the 3Φ3W and W_{L12} symbols will appear.
 - c. Insert the test leads into the jacks.
 - d. Select a phase (e.g. S or L2) as COM and connect the test probe of the COM (black) terminal to that phase (e.g. S or L2).
 - e. Connect the test probe of V (red) terminal to the second phase (e.g. R or L1).
 - f. Clamp the same phase as step e. (e.g. R or L1).
 - g. The power clamp will automatically select the proper range.
 - h. Wait until the reading is stable (about 6 seconds). Press the “HOLD” key to store the measured value. The W_{L23} symbol will appear.

WR

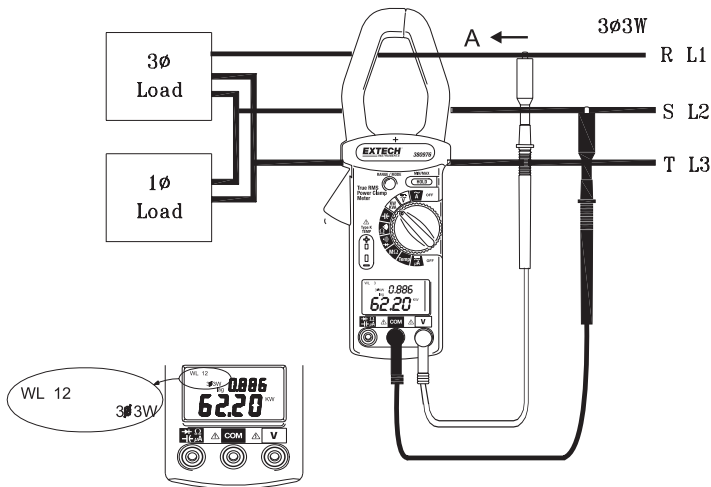

2. Second, measure $W_{TS(L3L2)}$ (refer to the diagram that follows the steps below).
 - a. Disconnect the test probe from the phase where the jaw clamp was set in the previous measurement.
 - b. Connect the test probe to the third phase (e.g. T or L3).
 - c. Clamp the third phase where test probe is connected to (e.g. T or L3)
 - d. The power clamp will automatically select the proper range.
 - e. Wait until the reading is stable (about 6 seconds) and then press the “HOLD” key to store the measured value.

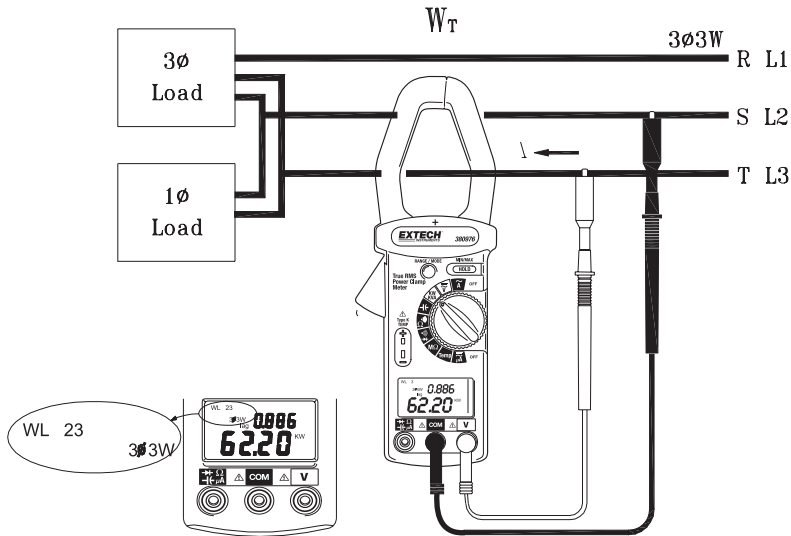

- The power clamp will process these two sets of data (W_{L12} , W_{L23}), and show the result on the LCD. The W_{L123} symbol will be shown to indicate 3 ϕ 3W power. The 3 ϕ 3W power (in watts) is stored in the meter memory.

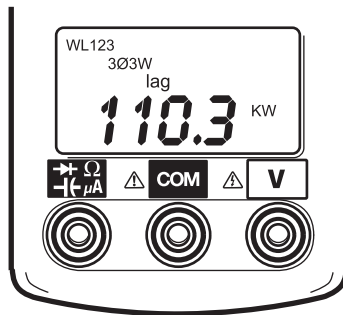

- To read a single data record, press the "HOLD" key to select desired W_{L12} , W_{L23} or W_{L123} display then press the "RANGE" key to select **KW+HP (Horse Power)**, **KW+PF (Power Factor)**, **KW+KVAR**, **KVA+ θ (Phase Angle)** or **A+V**.
- $W_{3\phi 3W} = W_{RS(L1L2)} + W_{TS(L3L2)}$

$$KVA_{3\phi 3W} = \sqrt{KW_{3\phi 3W}^2 + KVAR_{3\phi 3W}^2}$$

$$PF_{3\phi 3W} = \frac{KW_{3\phi 3W}}{KVA_{3\phi 3W}}$$

- Set the rotary switch to another position to exit this mode and clear the stored data.

NOTE

Once a phase is selected as COM, users can not change this selection in the subsequent measurement. For example, if S (or L2) phase is selected, S (or L2) phase is always connected to the COM during measurement of W_{RS} (or W_{L1L2}) and W_{TS} (or W_{L3L2}) in 3 ϕ 3W unbalanced power.

NOTE

1. The "+" sign printed on Panel must face the power source for accurate measurement.
2. If the device under test is a switching power supply, the meter KW, PF and θ reading maybe incorrect.

NOTE

For 3 ϕ 3W unbalanced power measurements, W_{RS} or W_{TS} could be negative. Ensure that all connections are correct before accepting a reading as valid.

3Φ 4-Wire KW, HP, KVA, KVAR, Power Factor & Phase Angle Measurement

1. First, measure $W_{R(L1)}$ (refer to the diagram below).
 - a. Set the rotary switch to the “ $\overline{\sim} V$ ” position.
 - b. Press and hold the “**RANGE**” key while setting the rotary switch to the “KW/KVA” position, the 3Φ4W and W_{L1} symbols should appear.
 - c. Insert the test leads into the input jacks.
 - d. Connect the neutral line to the COM (black) terminal.
 - e. Connect the test probe of the V (red) terminal to the first phase (e.g. R or L1).
 - f. Clamp on to the same phase (e.g. R or L1).
 - g. The power clamp meter will automatically select the proper range.
 - h. Wait until the reading is stable (about 6 seconds) and then press the “**HOLD**” key; the W_{L1} symbol will clear and the W_{L2} symbol will appear in order to instruct users to take the $W_{S(L2)}$ measurement.

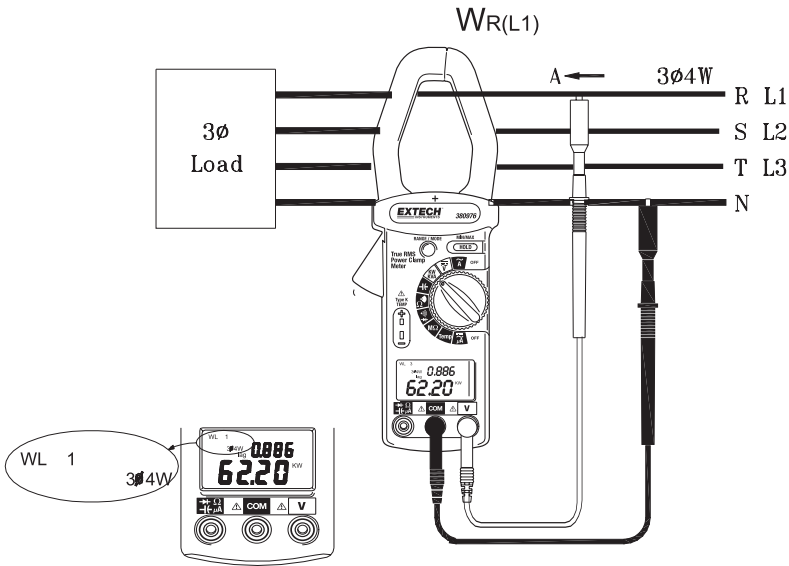

2. Second, measure $W_{S(L2)}$ (refer to the diagram that follows the steps below)
 - a. Disconnect the test probe from the phase where the jaw was clamped in the previous measurement.
 - b. Connect the test probe of the V (red) terminal to the second phase (e.g. S or L2).
 - c. Clamp on to the phase where the test probe is connected (e.g. S or L2 phase)
 - d. The power clamp will automatically select proper range.
 - e. Wait until the reading is stable (about 6 seconds) and then press the “**HOLD**” key; the W_{L2} symbol will disappear. The W_{L3} symbol will appear to instruct users to take the $W_{T(L3)}$ measurement.

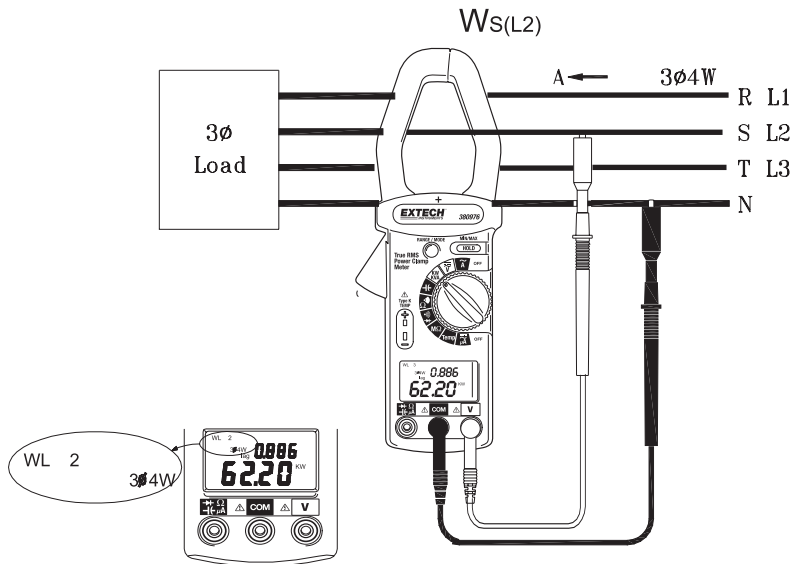

3. Third, measure $W_{T(L3)}$ (refer to the diagram that follows the steps below)

- Disconnect the test probe from the phase where the jaws were clamped in the previous measurement.
- Connect the test probe of the V (red) terminal to the third phase (e.g. T or L3 phase).
- Clamp the phase where the test probe is connected to (e.g. T or L3).
- The power clamp will automatically select the proper range.
- Wait until the reading is stable (about 6 seconds), and then press the **"HOLD"** key; The W_{L3} symbol will disappear.

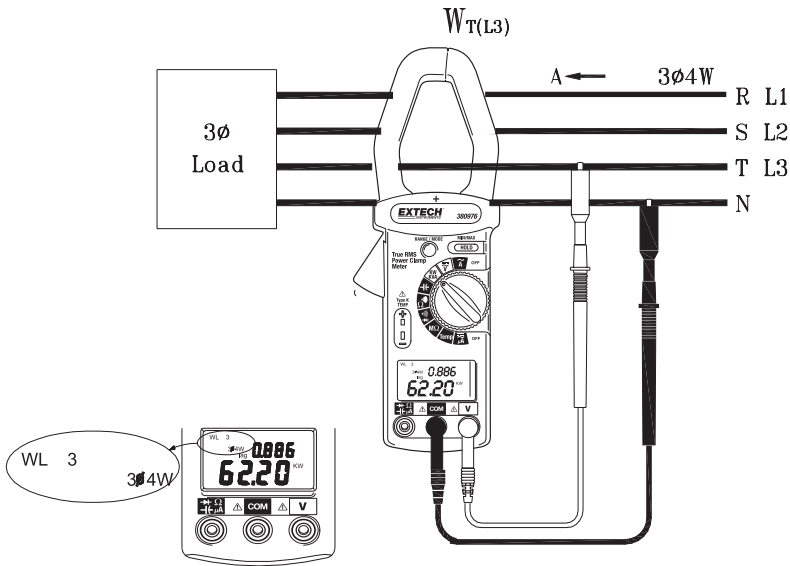

4. The power clamp will process these three sets of data (W_{L1} , W_{L2} , W_{L3}) and show the result on the LCD. The WL_{123} symbol will be shown to indicate the 3Ø4W power (refer to diagram).
 The 3Ø4W power value in watts is now stored in the meter's memory.

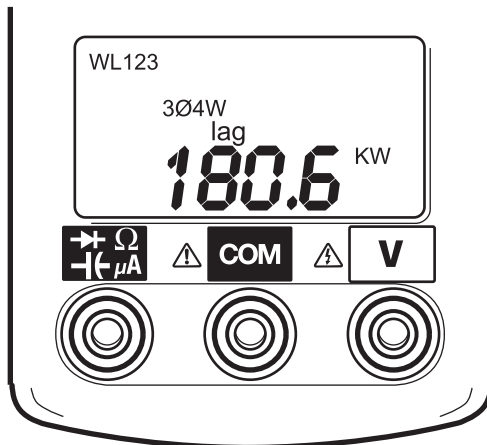

5. To read a single data record, use the "HOLD" key to select WL1, WL2, WL3 or WL123 display then press the "RANGE" key to select KW+HP (Horse Power), KW+PF (Power Factor), KW+KVAR, KVA+ θ (Phase Angle) or A+V displays.

$$6. W_{3\phi 4W} = W_{R(L1)} + W_{S(L2)} + W_{T(L3)}$$

$$KVA_{3\phi 4W} = \sqrt{KW_{3\phi 4W}^2 + KVAR_{3\phi 4W}^2}$$

$$PF_{3\phi 4W} = \frac{KW_{3\phi 4W}}{KVA_{3\phi 4W}}$$

7. Set the rotary switch to another position to exit this mode and clear the stored data.

NOTE

1. The "+" sign printed on meter must face the power source for accurate measurement.
2. If the device under test is switching power supply, the KW, PF and θ readings may not be correct.

NOTE

For 3 ϕ 4W power measurements, W_R or W_S and W_T must be positive. If one shows negative power, check the connections.

Resistance and Audible Continuity Measurements

WARNING

Before taking any in-circuit resistance measurements remove power from the circuit under test and discharge all capacitors.

1. Set the rotary switch to the ' Ω , \bullet ' or ' $M\Omega$ ' position.
2. Insert the test leads into the input jacks. (Black to 'COM' and Red to ' Ω ')
3. Connect the test leads to the circuit or component under test.
4. Read the resistance value on the LCD.
5. For measurements < 40 Ω , the continuity beeper will sound.

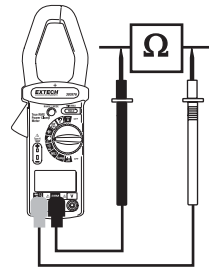

Capacitance Measurements

1. Fully discharge the capacitor under test before proceeding.
2. Insert the test leads into the input jacks. (Black to 'COM' and Red to $\text{---}(\text{---})$).
3. Set the rotary switch to the $\text{---}(\text{---})$ position.
4. Connect the red and black test leads to the capacitor. For Electrolytic (polarized) capacitors, connect the red test lead to the positive side and the black lead to the negative side.
5. Read the capacitance value displayed on the LCD.

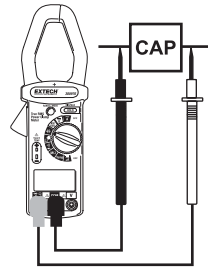

Note: Large valued capacitors will take a long period of time to charge and to auto-range to the correct range. (up to 60 seconds in the worst case). For improved resolution and shortest test time, manually pre-selecting the proper range is recommended.

Diode Tests

1. Set the rotary switch to the " $\text{---}(\text{---})$ " position.
2. Insert the test leads into the input jacks. (Black to 'COM' and Red to $\text{---}(\text{---})$)
3. Touch the test probe tips to the diode or semiconductor junction under test. Note the meter reading.
4. Reverse the test lead polarity by reversing the red and black leads. Note this reading.
5. The diode or junction can be evaluated as follows:
 - a. If one reading shows a value and the other reading shows 'OL' (overload), the diode is good.
 - b. If both readings show 'OL', the device is open.
 - c. If both readings are very small or zero, the device is shorted.
 - d. Note that the audible continuity function is operational in this mode (<40mV).

Temperature Measurements

1. Set the rotary switch to the "TEMP" position.
2. Press the RANGE button to select the desired unit of measure (C or F).
3. Insert the Type K Thermocouple into the subminiature input jacks located to the lower left of the rotary selector switch.
4. Touch the thermocouple sensor to the object under test.
5. Read the temperature value on the LCD.

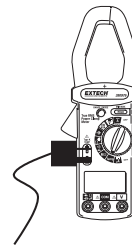

AC and DC μA Measurements

1. Set the rotary switch to the " $\text{---}(\text{---})$ μA " position.
2. Insert the test leads into the input jacks. (Black to 'COM' and Red to μA)
3. Connect the test leads in series with the circuit or device under test.
4. The meter will automatically select AC or DC and the appropriate range.
5. Read the current value on the LCD.

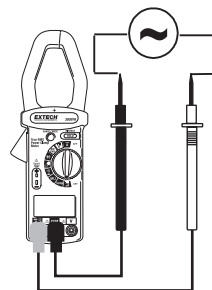

Meter Control Keys

HOLD - MX/MN Key

Data Hold Function

Press this key momentarily to put the meter into Data Hold mode (**HOLD** will appear on the LCD). In this mode, the meter freezes the displayed reading. To exit the Data Hold mode, press the key again (the **HOLD** icon will switch off). Note that the Data Hold mode is not available for Capacitance measurements.

MX/MN (Maximum and Minimum reading mode)

The MX/MN mode permits the user to record and recall the highest and lowest readings. The MX/MN feature is available for ACA, ACV, DCV, TEMP, and μ A functions only. The following steps outline the MX/MN feature:

1. Take an ACA, ACV, DCV, TEMP, or μ A measurement as described earlier.
2. Press and hold the MX/MN key for 2 seconds.
3. The Elapsed Timer (top display) and the **MX/MN** & **@** indicators will appear on the LCD.
4. The Elapsed Timer shows the duration of the measurement session in Minutes and Seconds (the Elapsed Timer switches to Hours and Minutes after 60 minutes). The maximum recording time is 100 hours.
5. The **@** indicator informs the user that the measurement range is being held. Note that the AUTO POWER OFF feature is disabled in the MX/MN mode.
6. Press the MX/MN key again to view the highest reading and the time (shown on the Elapsed Timer) that the reading was taken. The '**MX**' icon will appear on the LCD.
7. Press the MX/MN key again to view the lowest reading and the time (shown on the Elapsed Timer) that the reading was taken. The '**MN**' icon will appear on the LCD.
8. Press again to view the current elapsed time and measurement.
9. To exit this mode, press and hold the MX/MN key until **MX/MN** indicators switch off.

Using the HOLD button for Power Measurements

Refer to the power measurement section of this manual for details.

RANGE Key

The RANGE Key operation varies from mode to mode. Refer to the information below:

In ACA, ACV, DCV, μ A, Capacitance, and Resistance modes:

1. Press RANGE to enter the Manual Range mode (the **@** indicator will appear).
2. Press RANGE again to select the desired range manually.
3. Press and hold the RANGE key to exit this mode (the **@** indicator switches off).

In KW/kVA mode:

As described earlier, use the RANGE key to select the desired display combination: KW & PF, KW & KVAR, KVA & Phase angle, or Current / Voltage.

In TEMP mode:

Use the RANGE key to select the desired unit of measure ($^{\circ}$ C or $^{\circ}$ F).

Automatic Sleep Mode and Battery Replacement

The Meter is powered by a 9V battery. An AUTO SLEEP feature is included to preserve battery life.

Note: The Auto Power OFF feature is disabled when the meter is in the MIN/MAX mode

Note: In the sleep mode the meter continues to draw a small amount of battery current. Always turn the function switch to the OFF position when storing the meter.

Note: To restore operation after the sleep mode has engaged, turn the function switch to the OFF position and then back to the function desired.

Auto Sleep Disable

The meter automatically goes to sleep mode after 30 minutes to conserve battery energy. To defeat this feature:

1. Turn the meter OFF.
2. Press and hold the HOLD key while turning the selector switch to the AC Amps position.
3. Release HOLD when the clock icon appears on the LCD.

Battery Replacement

WARNING

To prevent electrical hazard or shock, turn off the meter and disconnect test leads before removing the back cover.

When the battery power falls low, the LCD will display the battery icon .

To replace the 9V battery:

1. Set the Range switch to the OFF position.
2. Remove the back cover by first removing the rear screws and then prying open the housing.
3. Replace the 9V battery.
4. Reassemble the meter housing.

Specifications

General Specifications

Display	Dual Display; 4-digit, 10,000 count (0 to 9999) LCD
Jaw Opening	1.6" (42mm)
Max. Input limit	Max. voltage between any terminal and ground: 600Vrms
Sampling rate	2.5 times per second (Digital Display); Once every 6 seconds (KW, KVA, and KVAR)
Auto Sleep	After approx. 30 minutes (feature can be defeated)
Low battery indication	Battery symbol appears on the LCD
Power supply	9V Battery
Battery life	Approx. 32 hours with alkaline battery
Operating Temperature	32 to 122°F (0 to 50°C)
Operating Humidity	< 80% RH
Operating Altitude	7000 ft. (2000 meters) maximum.
Storage Temperature	14 to 140°F (-10 to 60°C)
Storage Humidity	< 70% RH
Temperature coefficient	0.1 x (specified accuracy) / °C at < 64°F (18°C), > 82°F (28°C)
Dimensions	9.0 x 3.0 x 1.5" (228 x 76 x 39mm)
Weight	Approx. 1.0 lb. (465g)
Approvals	CE, UL
Safety	This meter is intended for indoor use and protected, against the users, by double insulation per EN61010-1 and IEC61010-1 2nd Edition (2001) to CAT III 600V; Pollution Degree 2. The meter also meets UL 61010A-1, First Edition
UL Listed	The UL mark does not indicate that this product has been evaluated for the accuracy of its readings.

PER IEC1010 OVERVOLTAGE INSTALLATION CATEGORY

OVERVOLTAGE CATEGORY I

Equipment of OVERVOLTAGE CATEGORY I is equipment for connection to circuits in which measures are taken to limit the transient overvoltages to an appropriate low level.

Note – Examples include protected electronic circuits.

OVERVOLTAGE CATEGORY II

Equipment of OVERVOLTAGE CATEGORY II is energy-consuming equipment to be supplied from the fixed installation.

Note – Examples include household, office, and laboratory appliances.

OVERVOLTAGE CATEGORY III

Equipment of OVERVOLTAGE CATEGORY III is equipment in fixed installations.

Note – Examples include switches in the fixed installation and some equipment for industrial use with permanent connection to the fixed installation.

OVERVOLTAGE CATEGORY IV

Equipment of OVERVOLTAGE CATEGORY IV is for use at the origin of the installation.

Note – Examples include electricity meters and primary over-current protection equipment

Measurement Specifications

Accuracy: \pm (% of rdg + number of digits) from 18°C to 28°C (64°F to 82°F) R.H. < 80%

AC Current (50Hz to 400Hz) True RMS

Range	Resolution	Accuracy (% reading)	Sensitivity	Overload Protection
99.99A	10mA	\pm (2% + 20d) (50, 60Hz)	0.10A	1000A
999.9A	100mA	\pm (4% + 20d) (40~400Hz)	1.0A	

μ A True RMS (AC+DC)

Range	Resolution	Accuracy	Sensitivity	Overload Protection
99.99 μ A	10nA	\pm (1% + 20d)	0.20 μ A	600V
999.9 μ A	100nA		2.0 μ A	

Burden Voltage: 5mV/ μ A

AC Voltage (50Hz to 400Hz) True RMS

Range	Resolution	Accuracy	Sensitivity	Overload Protection
999.9mV	0.1mV	\pm (1% + 20d) (50, 60Hz) \pm (2% + 20d) (40~100Hz)	2.0mV	600V
9.999V	1mV	\pm (1% + 20d) (50, 60Hz)	0.020V	
99.99V	10mV		0.20V	
600.0V	100mV	\pm (2% + 20d) (40~400Hz)	2V	

Input impedance: 3M Ω

DC Voltage

Range	Resolution	Accuracy	Sensitivity	Overload Protection
999.9mV	0.1mV	\pm (1.0% + 20d)	2.0mV	600V
9.999V	1mV		0.020V	
99.99V	10mV		0.20V	
600.0V	100mV		2V	

Input resistance: 3M Ω

Resistance (Audible Continuity for readings <40 Ω on the 999.9 Ω range)

Range	Resolution	Accuracy	Overload Protection
999.9 Ω	100m Ω	\pm (1% + 10d)	600V
9.999K Ω	1 Ω		
99.99K Ω	10 Ω		
999.9K Ω	100 Ω		

MΩ (Resistance)

Range	Resolution	Accuracy	Overload Protection
9.999M Ω	1K Ω	±(5% + 10d)	600V
99.99M Ω	10K Ω		

Capacitance

Range	Resolution	Accuracy	Overload Protection
10.000μF	1nF	±(1.5% + 5d)	600V
100.00μF	10nF		
1000.0μF	100nF	±(2.5% + 15d)	
7000μF	1μF		

Diode (Continuity <40mV)

Range	Resolution	Accuracy	Overload Protection
2.000V	1mV	±(2% + 1d)	600V

Temperature (K-Type thermocouple)

Range	Resolution	Accuracy	Overload Protection
-50°C to 900°C	0.1°C	±(1% + 1°C)	30V _{AC} or 60V _{DC}
-58°F to 1000°F	0.1°F	±(1% + 2°F)	

1Φ/3Φ TRUE Power (PF > 0.5 or θ < 60°) (50/60Hz)

Range	Resolution	Accuracy	Overload Protection
60.00KW (<100A)	10W	±(5% + 20d)	600VAC/ 1000AAC
600.0KW (>100A)	100W	±(5% + 20d)	

1Φ/3Φ Horse Power (HP) (PF > 0.5 or θ < 60°) (50/60Hz)

Range	Resolution	Accuracy	Overload Protection
80.00HP (<100A)	0.01 HP	±(5% + 20d)	600VAC/1000AAC
800.0 HP (>100A)	0.1 HP	±(5% + 20d)	

1Φ/3Φ Reactive Power (KVAR) (PF > 0.5 or θ < 60°) (50/60Hz) θ

Range	Resolution	Accuracy	Overload Protection
60.00KVAR (<100A)	10VAR	±(5% + 20d)	600VAC/ 1000AAC
600.0KVAR (>100A)	100VAR	±(5% + 20d)	

1Φ/3Φ Apparent Power (KVA)

Range	Resolution	Accuracy	Overload Protection
60.00KVA (<100A)	10VA	±(2.5% + 20d)	600VAC/1000AAC
600.0KVA (>100A)	100VA		

Phase Angle (50/60Hz)

Range	Resolution	Accuracy	Sensitivity
-60° ~ 0° ~ +60°	0.1°	±6.0°	ACV>100V, ACA>10A

Frequency

Range	Resolution	Accuracy	Sensitivity
40Hz/1KHz	0.1Hz	±(0.5% + 2d)	ACV>5V, ACA>6A

Calibration and Repair Services

Extech offers repair and calibration services for the products we sell. Extech also provides NIST certification for most products. Call the Customer Service Department for information on calibration services available for this product. Extech recommends that annual calibrations be performed to verify meter performance and accuracy.



Support line (781) 890-7440

Technical support: Extension 200; E-mail: support@extech.com

Repair & Returns: Extension 210; E-mail: repair@extech.com

Product specifications subject to change without notice

For the latest version of this User Guide, Software updates, and other up-to-the-minute product information, visit our website: www.extech.com
Extech Instruments Corporation, 285 Bear Hill Road, Waltham, MA 02451

Copyright © 2007 Extech Instruments Corporation

All rights reserved including the right of reproduction in whole or in part in any form.