



PD-151 6" ELECTRONIC CALIPER OPERATING INSTRUCTIONS

● TECHNICAL SPECIFICATIONS

- Measuring range : 0~150mm/0~6".
- Resolution : 0.01mm/0.0005".
- Accuracy : $\pm 0.02\text{mm}/0.001"$ (< 100mm) ,
 $\pm 0.03\text{mm}/0.001"$ (> 100mm).
- Repeatability : 0.01mm/0.0005".
- Max.measuring speed : 1.5m/sec. \cdot 60"/sec.
- Measuring system : Linear capacitive measuring system.
- Display : LCD display.
- Power : 1pc silver oxide battery LR44 (1.5V)
- Capacity : Appr. 165mAh
- Working temperatuer : 5~40 °C/41~104 °F.
- Influence of humidity : Not important under 80% of relative humidity.

● PRODUCT DESCRIPTION

1. Internal measuring jaws
2. Metric/Inch change button(mm/inch)
3. Locking screw
4. LCD display
5. External measuring jaws
6. Power on /off button(ON/OFF)
7. Zero setting(ZERO)
8. Battery cover
9. Depth measuring blade
10. Step-measuring faces
11. Data hold button(HOLD)

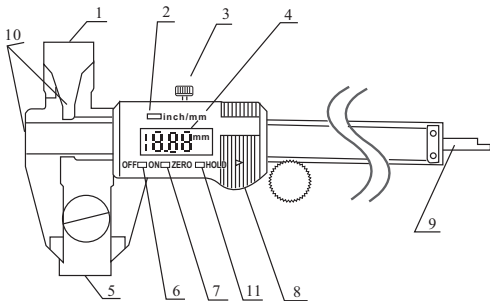

● OPERATION

1. Preparations :

- 1.1. Slider can be moved after the locking screw (No.3 item of the Nomenclature) is loosened.
- 1.2. Wipe clean all the measuring faces and caliper bar.No organic solutions are allowed.
- 1.3. Check to see if all the buttons, switches and LCD display respond well.

2. Basic measuring methods :

- 2.1. Loosen the locking screw.
- 2.2. Switch the unit on by pressing "ON/OFF" button, or move caliper slider for auto power on, then select the unit by pressing "mm/inch" button. (Each time the button is pressed, inch and metric digits will be displayed alternatively.)
- 2.3. Apply normal measuring pressure on slider to close the external.
- 2.4. Press Date hold(HOLD) button to keep measuring data in record.
- 2.5. Press "ON/OFF" button for power off. or the power will auto off when not in use for 5 minutes.

A. Measurements of internal dimensions.

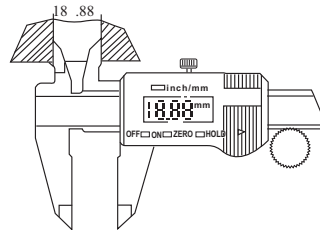

B. Measurements of external dimensions

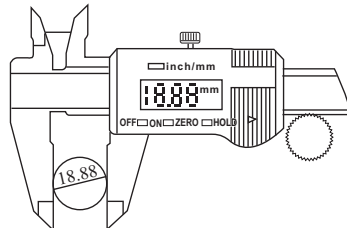

C. Measurements of depth.

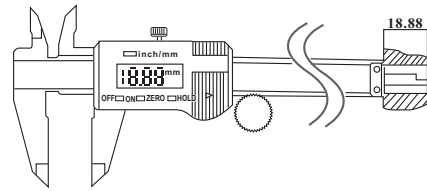

D. Measurement of steps.

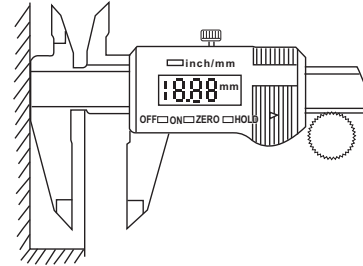

E. Differential method of measurement. (Application of zero setting.)

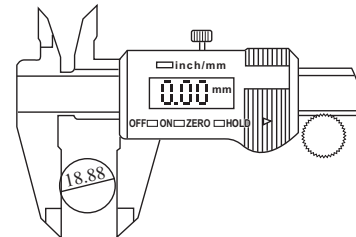
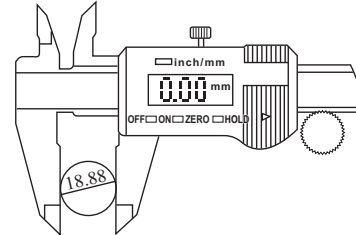

● MAINTENANCE

1. Clean caliper bar with dry cotton fabrics before using in order to avoid mad display of caliper caused by humidity.
2. Keep the caliper clean and dry. (Liquid can damage the slider.)
3. Faces should be cleaned gently with cotton fabrics. Never use petrol, acetone and other organic solutions.

4. In order to save power, turn off the unit when caliper is going to stay idle for some time.
5. Never apply any electric pressure on any part of the caliper and never use an electric pen for the fear of damaging its chip.
6. For other notes please refer to the conventional calipers.
7. Accidental wrong display may happen while replacing the battery Just take out the battery and then put it in again after more than 30 seconds until the display returns to normal.

● BATTERY REPLACEMENT

When the numbers on LCD display are not clear, take off the battery cover in the direction shown by the arrow and replace the battery. (positive side facing out.)

● TROUBLE SHOOTING

Failure	Cause	Solution
The numbers on LCD display are not clear	Battery voltage lower than 1.0V.	Replace the battery.
Display doesn't change when the slider is moved.	Accidental trouble in circuit.	Take out battery and reset it after 30 sec.
Less accurate than specified but with $\pm 0.1\text{mm}$.	Dirt in the sensor.	Remove slider cover and it's assembly, clean face of sensor with clean compressed air ($5\text{kg}/\text{cm}^2$).
No display on LCD.	1. Battery in poor contact. 2. Battery voltage under 1.0V.	1. Remove battery cover and adjust the battery seat, keep good connection. 2. Replace battery.

PD-151 數位游標卡尺 操作說明書

● 技術規格

測量範圍：0~150mm/0~6".
 解析度：0.01mm/0.0005".
 精確度：±0.02mm/0.001"(<100mm),
 ±0.03mm/0.001"(>100mm).
 反復精確度：0.01mm/0.0005".
 最快測量速度：1.5米/每秒, 60英寸/每秒.
 測量系統：線性電容式測量系統.
 顯示器：LCD液晶顯示器.
 電源：1個水銀電池 LR44 (1.5V).
 電池容量：大約 165mAh.
 工作溫度：5~40 °C/41~104 °F.
 溼度的影響：在相對濕度80%以下, 並不重要.

● 各部位名稱

1. 內徑測量爪
2. 公/英制(mm/inch)切換按鈕
3. 鎖緊螺絲
4. LCD液晶顯示器
5. 外徑測量爪
6. 電源開/關(ON/OFF)按鈕
7. 歸零(ZERO)按鈕
8. 電池蓋
9. 深度測量桿
10. 台階測量面
11. 資料保持(HOLD)按鈕

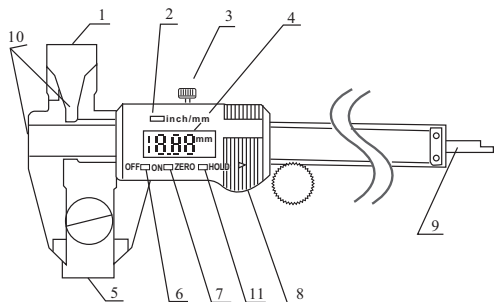

1. 操作前準備：

- 1.1. 旋鬆鎖緊螺絲(如各部位名稱的NO.3), 才能開始滑動游標卡尺。
- 1.2. 清潔擦拭尺面、測量爪和滑桿。不可使用具有腐蝕性的溶劑。
- 1.3. 檢查各按鈕開關和LCD液晶顯示器, 是否反應正常？

2. 基本測量方法：

- 2.1. 旋鬆鎖緊螺絲。
- 2.2. 按壓“電源開關(ON/OFF)”或滑動游標卡尺, 將啟動電源。然後選擇單位, 切換“公/英制(mm/inch)”按鈕; 每按一次“公/英制(mm/inch)”按鈕, 公制和英制數字將交替顯示。
- 2.3. 施以適當的壓力在滾輪上, 使外徑測量爪閉合; 然後按“歸零按鈕(ZERO)”, 使數值顯示“零”。
- 2.4. 按壓“資料保持按鈕(HOLD)”, 使測量數值紀錄。
- 2.5. 按壓“電源開關(ON/OFF)”, 關閉電源。或是未操作, 超過5分鐘後, 自動關閉電源。

A. 內徑測量

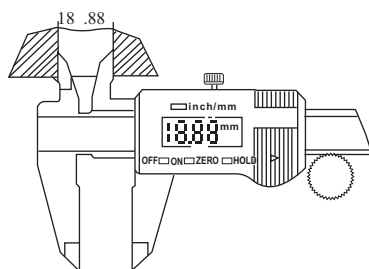

B. 外徑測量

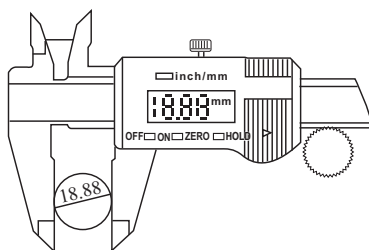

C. 深度測量

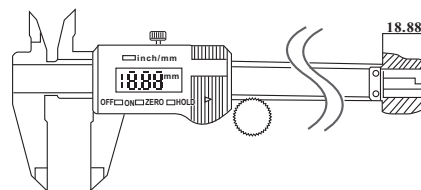

D. 台階測量

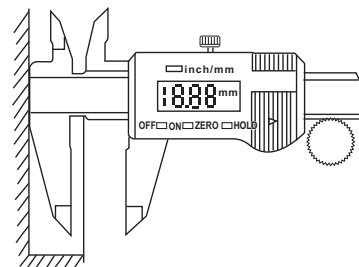

E. 用差分法測量(歸零設定的應用)

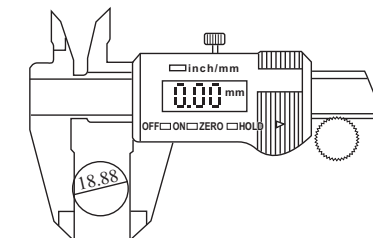
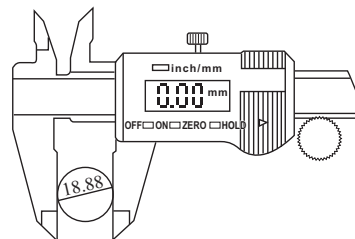

● 產品維護說明

1. 清潔游標卡尺應使用乾燥的棉織品擦拭, 避免溼氣所產生的錯誤顯示。
2. 經常保持游標卡尺清潔和乾燥。(液體會導致滑軌損壞)
3. 尺面可以用棉織物輕輕的進行清潔, 請勿使用汽油、丙酮...等有機溶劑。
4. 當不用時, 請關閉電源, 以節省電力。
5. 不要使用任何的電壓和電筆, 在這游標卡

尺的電子零件上, 避免損壞芯片。

6. 對於其他注意事項, 請同時參閱一般的游標卡尺注意原則。
7. 更換電池時, 可能會產生錯誤的顯示。請取下電池後, 稍待一會兒, 超過30秒以後再裝入電池, 直到正常顯示為止。

● 電池更換

當LCD字體顏色變淡時, 依箭頭指示方向, 取下電池蓋, 更換電池。(正極面朝上, 放入電池)

● 故障排除

故障現象	可能原因	排除方法
當LCD字體顏色變淡時	電池電力低於1.0V。	更換新電池。
當滑動游標卡尺時, 顯示數值不會改變時	可能是電路故障。	取下電池, 在30秒後重新裝入電池。
比技術規格不準確, 但在±0.1mm內時	感測器上有污垢。	取下滑動蓋和相關零件, 用5kg/cm2的氣壓, 清潔感測器的表面。
LCD液晶顯示器, 不顯示時	1. 電池接觸不良。 2. 電池電壓低於1.0V。	1. 取下電池蓋和調整電池座, 使電池接觸良好。 2. 更換新電池。

寶工實業股份有限公司
PROKIT'S INDUSTRIES CO., LTD.



©2013 Prokit's Industries Co., LTD. All rights reserved

2013001(C)