

High Temperature InfraRed Thermometer with Laser Pointer

MODEL 42545

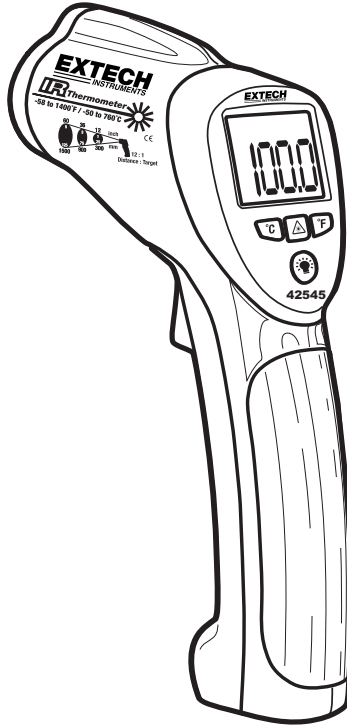

Introduction

Congratulations on your purchase of the Model 42545 IR Thermometer. The 42545 is capable of non-contact (infrared) temperature measurements at the touch of a button. The built-in laser pointer increases target accuracy while the backlit LCD and handy push-buttons combine for convenient, ergonomic operation. Proper use and care of this meter will provide years of reliable service.

Safety

- Use extreme caution when the laser pointer beam is on
- Do not point the beam toward anyone's eye or allow the beam to strike the eye from a reflective surface
- Do not use the laser near explosive gases or in other potentially explosive areas



Specifications

Infrared Thermometer Specifications

Range / Resolution	-58 to 1832°F (-50 to 1000°C)	0.1°C/F to 200°, 1° over 200
Accuracy	-58 to -4°F	±9°F
	-4 to 1000°F	±(2% rdg ± 4°F)
	1001 to 1832°F	±(3% rdg ± 9°F)
	-50 to -20°C	±5°C
	-20 to 538°C	±(2% rdg ± 2°C)
	539 to 1000°C	±(3% rdg ± 5°C)
	Note: Accuracy is specified for the following ambient temperature range: 64 to 82°F (18 to 28°C)	
Emissivity	0.95 fixed value	
Field of View	D/S = Approx. 50:1 ratio (D = distance, S = spot)	
Laser power	Less than 1mW	
Spectral response	6 to 14 μm (wavelength)	
Over range indication	LCD will display "1"	

General Specifications



Display	3½ digit backlit LCD display with function indicators
Display rate	1 second approx.
Operating Temperature	32°F to 122°F (0°C to 50°C)
Operating Humidity	Max. 80% RH.
Power Supply	9V battery
Automatic Power Off	Meter shuts off automatically after 6 seconds
Weight/Dimensions	10.2 oz. / 290g 3.9 x 2.2 x 9.0" (100 x 56 x 230mm)

Meter Description

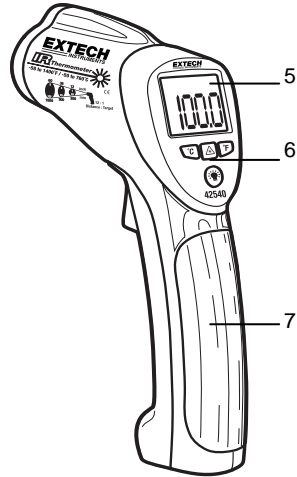
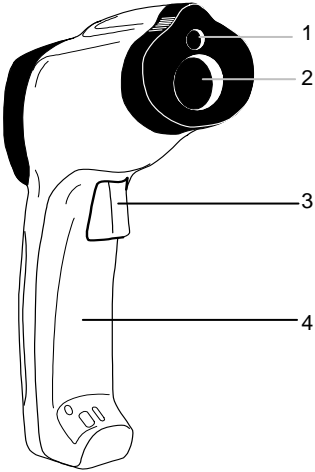
1. Laser pointer beam
2. IR Sensor
3. Measurement Trigger
4. Battery Compartment
5. LCD Display
6. Push-buttons
7. Handle Grip



Operating Instructions

1. Hold the meter by its Handle Grip and point it toward the surface to be measured.
2. Pull and hold the Trigger to turn the meter on and begin testing. The display will light if the battery is fresh. Replace the battery if the display does not light.
3. While continuing to pull the Trigger:
 - a. Push the laser button  to turn on the laser pointer. When the laser is on, the laser icon  will appear on the LCD over the temperature reading. Aim the red beam at the point of test (pressing the laser button again turns the laser off).
 - b. Select the temperature units using the °C or °F button.
 - c. Push the backlight button  to turn on the LCD backlight function.
4. Release the Trigger (the reading will hold for approximately 6 seconds) and the meter will automatically shut off.

Measurement Notes

1. The object under test should be larger than the spot (target) size calculated by the field of view diagram.
2. If the surface of the object under test is covered with frost, oil, grime, etc., clean before taking measurements.
3. If an object's surface is highly reflective, apply masking tape or flat black paint to the surface before measuring.
4. The meter may not make accurate measurements through transparent surfaces such as glass.
5. Steam, dust, smoke, etc. can obscure measurements.
6. The meter compensates for deviations in ambient temperature. It can, however, take up to 30 minutes for the meter to adjust to extremely wide ambient temperature changes.
7. To find a hot spot, aim the meter outside the area of interest then scan across (in an up and down motion) until the hot spot is located.

Field of View

The meter's field of view is 50:1. For example, if the meter is 12 inches from the target (spot), the diameter of the target must be at least .24 inches. Other distance ratios are shown in the field of view diagram.

The target should always be larger than the spot size. The smaller the target the closer you should be to take measurements. In instances where accuracy is critical make sure your target is at least twice the spot size.

Note that measurements should normally be made less than 3 feet from the target. The meter can measure from further distances but the measurement may be affected by external sources of light. In addition, the spot size may be so large that it encompasses surface areas not intended to be measured.

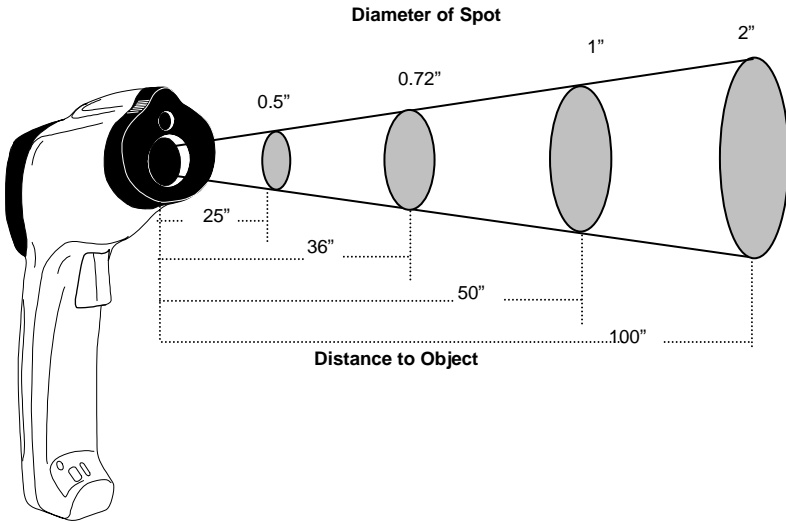

Battery Replacement

When the low battery symbol  appears on the LCD, replace the meter's 9V battery. The battery compartment is located behind the panel that surrounds the meter's trigger. The panel can be pulled open by the two indentations near the trigger and folded down as shown in the diagram.

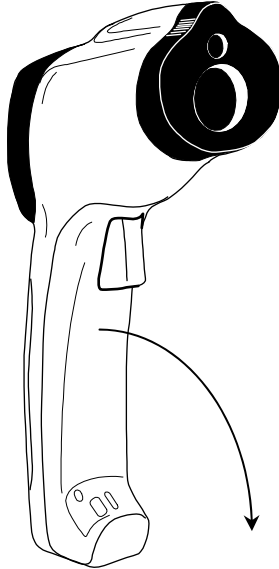

Warranty

EXTECH INSTRUMENTS CORPORATION warrants this instrument to be free of defects in parts and workmanship for **one year** from date of shipment (a six month limited warranty applies to sensors and cables). If it should become necessary to return the instrument for service during or beyond the warranty period, contact the Customer Service Department at (781) 890-7440 ext. 210 for authorization or visit our website www.extech.com for contact information. A Return Authorization (RA) number must be issued before any product is returned to Extech. The sender is responsible for shipping charges, freight, insurance and proper packaging to prevent damage in transit. This warranty does not apply to defects resulting from action of the user such as misuse, improper wiring, operation outside of specification, improper maintenance or repair, or unauthorized modification. Extech specifically disclaims any implied warranties or merchantability or fitness for a specific purpose and will not be liable for any direct, indirect, incidental or consequential damages. Extech's total liability is limited to repair or replacement of the product. The warranty set forth above is inclusive and no other warranty, whether written or oral, is expressed or implied.

Calibration and Repair Services

Extech offers repair and calibration services for the products we sell. Extech also provides NIST certification for most products. Call the Customer Service Department for information on calibration services available for this product. Extech recommends that annual calibrations be performed to verify meter performance and accuracy.



Support line (781) 890-7440

Technical support: Extension 200; E-mail: support@extech.com

Repair & Returns: Extension 210; E-mail: repair@extech.com

Product specifications subject to change without notice

For the latest version of this User's Guide, Software updates, and other up-to-the-minute product information, visit our website: www.extech.com

Copyright © 2004 Extech Instruments Corporation

All rights reserved including the right of reproduction in whole or in part in any form.