



5335C

Power Meter



Safety Summary

The following safety precautions apply to both operating and maintenance personnel and must be followed during all phases of operation, service, and repair of this instrument.

WARNING

Before applying power to this instrument:

- Read and understand the safety and operational information in this manual.
- Apply all the listed safety precautions.
- Verify that the voltage selector at the line power cord input is set to the correct line voltage. Operating the instrument at an incorrect line voltage will void the warranty.
- Make all connections to the instrument before applying power.
- Do not operate the instrument in ways not specified by this manual or by B&K Precision.

Failure to comply with these precautions or with warnings elsewhere in this manual violates the safety standards of design, manufacture, and intended use of the instrument. B&K Precision assumes no liability for a customer's failure to comply with these requirements.

Category rating

The IEC 61010 standard defines safety category ratings that specify the amount of electrical energy available and the voltage impulses that may occur on electrical conductors associated with these category ratings. The category rating is a Roman numeral of I, II, III, or IV. This rating is also accompanied by a maximum voltage of the circuit to be tested, which defines the voltage impulses expected and required insulation clearances. These categories are:

Category I (CAT I): Measurement instruments whose measurement inputs are not intended to be connected to the mains supply. The voltages in the environment are typically derived from a limited-energy transformer or a battery.

Category II (CAT II): Measurement instruments whose measurement inputs are meant to be connected to the mains supply at a standard wall outlet or similar sources. Example measurement environments are portable tools and household appliances.

Category III (CAT III): Measurement instruments whose measurement inputs are meant to be connected to the mains installation of a building. Examples are measurements inside a building's circuit breaker panel or the wiring of permanently-installed motors.

Category IV (CAT IV): Measurement instruments whose measurement inputs are meant to be connected to the primary power entering a building or other outdoor wiring.

WARNING

Do not use this instrument in an electrical environment with a higher category rating than what is specified in this manual for this instrument.

WARNING

You must ensure that each accessory you use with this instrument has a category rating equal to or higher than the instrument's category rating to maintain the instrument's category rating. Failure to do so will lower the category rating of the measuring system.

Electrical Power

This instrument is intended to be powered from a CATEGORY II mains power environment. The mains power should be 115 V RMS or 230 V RMS. Use only the power cord supplied with the instrument and ensure it is appropriate for your country of use.

Ground the Instrument

WARNING

To minimize shock hazard, the instrument chassis and cabinet must be connected to an electrical safety ground. This instrument is grounded through the ground conductor of the supplied, three-conductor AC line power cable. The power cable must be plugged into an approved three-conductor electrical outlet. The power jack and mating plug of the power cable meet IEC safety standards.

WARNING

Do not alter or defeat the ground connection. Without the safety ground connection, all accessible conductive parts (including control knobs) may provide an electric shock. Failure to use a properly-grounded approved outlet and the recommended three-conductor AC line power cable may result in injury or death.

WARNING

Unless otherwise stated, a ground connection on the instrument's front or rear panel is for a reference of potential only and is not to be used as a safety ground. Do not operate in an explosive or flammable atmosphere.

WARNING

Do not operate the instrument in the presence of flammable gases or vapors, fumes, or finely-divided particulates.

WARNING

The instrument is designed to be used in office-type indoor environments. Do not operate the instrument

- In the presence of noxious, corrosive, or flammable fumes, gases, vapors, chemicals, or finely-divided particulates.
- In relative humidity conditions outside the instrument's specifications.
- In environments where there is a danger of any liquid being spilled on the instrument or where any liquid can condense on the instrument.
- In air temperatures exceeding the specified operating temperatures.
- In atmospheric pressures outside the specified altitude limits or where the surrounding gas is not air.
- In environments with restricted cooling air flow, even if the air temperatures are within specifications.
- In direct sunlight.

This instrument is intended to be used in an indoor pollution degree 2 environment. The operating temperature range is 0°C to 40°C and 20% to 80% relative humidity, with no condensation allowed. Measurements made by this instrument may be outside specifications if the instrument is used in non-office-type environments. Such environments may include rapid temperature or humidity changes, sunlight, vibration and/or mechanical shocks, acoustic noise, electrical noise, strong electric fields, or strong magnetic fields.

Do not operate instrument if damaged

WARNING

If the instrument is damaged, appears to be damaged, or if any liquid, chemical, or other material gets on or inside the instrument, remove the instrument's power cord, remove the instrument from service, label it as not to be operated, and return the instrument to B&K Precision for repair. Notify B&K Precision of the nature of any contamination of the instrument.

Clean the instrument only as instructed

WARNING

Do not clean the instrument, its switches, or its terminals with contact cleaners, abrasives, lubricants, solvents, acids/bases, or other such chemicals. Clean the instrument only with a clean dry lint-free cloth or as instructed in this manual. Not for critical applications

WARNING

This instrument is not authorized for use in contact with the human body or for use as a component in a life-support device or system.

Do not touch live circuits

WARNING

Instrument covers must not be removed by operating personnel. Component replacement and internal adjustments must be made by qualified service-trained maintenance personnel who are aware of the hazards involved when the instrument's covers and shields are removed. Under certain conditions, even with the power cord removed, dangerous voltages may exist when the covers are removed. To avoid injuries, always disconnect the power cord from the instrument, disconnect all other connections (for example, test leads, computer interface cables, etc.), discharge all circuits, and verify there are no hazardous voltages present on any conductors by measurements with a properly-operating voltage-sensing device

before touching any internal parts. Verify the voltage-sensing device is working properly before and after making the measurements by testing with known-operating voltage sources and test for both DC and AC voltages. Do not attempt any service or adjustment unless another person capable of rendering first aid and resuscitation is present. Do not insert any object into an instrument's ventilation openings or other openings.

WARNING

Hazardous voltages may be present in unexpected locations in circuitry being tested when a fault condition in the circuit exists.

WARNING

Fuse replacement must be done by qualified service-trained maintenance personnel who are aware of the instrument's fuse requirements and safe replacement procedures. Disconnect the instrument from the power line before replacing fuses. Replace fuses only with new fuses of the fuse types, voltage ratings, and current ratings specified in this manual or on the back of the instrument. Failure to do so may damage the instrument, lead to a safety hazard, or cause a fire. Failure to use the specified fuses will void the warranty.

Servicing

WARNING

Do not substitute parts that are not approved by B&K Precision or modify this instrument. Return the instrument to B&K Precision for service and repair to ensure that safety and performance features are maintained.

For continued safe use of the instrument

- Do not place heavy objects on the instrument.
- Do not obstruct cooling air flow to the instrument.
- Do not place a hot soldering iron on the instrument.
- Do not pull the instrument with the power cord, connected probe, or connected test lead.
- Do not move the instrument when a probe is connected to a circuit being tested.

Compliance Statements

Disposal of Old Electrical & Electronic Equipment (Applicable in the European Union and other European countries with separate collection systems)

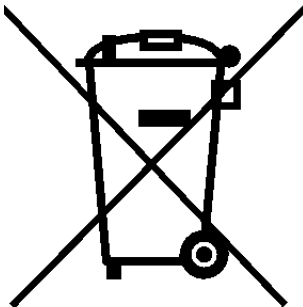

This product is subject to Directive 2002/96/EC of the European Parliament and the Council of the European Union on waste electrical and electronic equipment (WEEE), and in jurisdictions adopting that Directive, is marked as being put on the market after August 13, 2005, and should not be disposed of as unsorted municipal waste. Please utilize your local WEEE collection facilities in the disposition of this product and otherwise observe all applicable requirements.



Safety Symbols









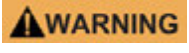

Symbol	Description
	Indicates a hazardous situation which, if not avoided, will result in death or serious injury.
	Indicates a hazardous situation which, if not avoided, could result in death or serious injury.
	Indicates a hazardous situation which, if not avoided, will result in minor or moderate injury.
	Refer to the text near the symbol.
	Electric Shock hazard
	Alternating current (AC)
	Chassis ground
	Earth ground
	Indicates the In position of the power switch when instrument is ON.
	Indicates the Out position of the power switch when instrument is OFF.
	Indicates practices not related to physical injury.

Table 1 Safety Symbols

Contents

Contents

Safety Summary	2
Compliance Statements	5
Contents	7
1.1 Features	9
1.2 Front Panel	10
1.3 Rear Panel	11
1.4 Input Power and Fuse Requirements	12
1.5 Power-up Sequence	12
Menu	13
2.1 System Softkey	13
2.2 System Menu	13
2.3 System Information Menu	13
2.4 Communication Configuration Menu	13
2.5 System Configuration Menu	15
2.6 Self Test	16
2.7 System Initialization Menu	16
2.8 Setup Menu	16
2.9 External Sensor Setup	19
2.10 Other settings: Filter and Crest Factor	19
2.11 Inrush Measurement Setup	22
2.12 Cal Zero	22
2.13 Ratio Setup	23
2.14 External Current Sensor	23
Measurement Setup	24
3.1 Crest factor	24
3.2 Set Measurement Range	24
3.3 Fixed Voltage and Current range	24
3.4 Auto Voltage and Current range	24
3.5 Measurement interval	24
3.6 Filter and Crest Factor Setting	25
3.7 Frequency Filter	25
3.8 Line filter	25
3.9 Averaging Function	25
3.10 Index averaging	27
3.11 Linear averaging	27
3.12 Harmonic measurement averaging	27
Meter Display	28
4.1 Operation steps	28
Waveform Display Function	30
5.1 Trigger Status	30
5.2 Trigger Setup	31
5.3 External trigger input (Ext)	31
Harmonic Measurement Function	33
6.1 Bar Graph Mode	33
6.2 List Mode	34
6.3 Setup Menu	34
Integral Operation Function	37
7.1 Integral measurement display information	38
7.2 Specification	39

7.3	Setting of Integral Measurement Configuration	40
7.4	Integration.....	41
Remote Operation	42
8.1	RS-232 Interface	42
8.2	USB interface.....	43
8.3	LAN interface.....	43
Specifications	45
Specifications	46
Specifications (cont.)	48
Specifications (cont.)	50
Routine Maintenance	52
10.1	Self-inspection	52
10.2	Error Information References.....	52
10.3	Daily maintenance.....	49
10.4	Troubleshooting	49
Service Information	50

General Information

The BK5335C power meter measures AC and DC inputs up to 600Vrms and 20Arms from DC to 100kHz. It measures voltage, current, power, frequency, power factor, phase and harmonic parameters up to the 50th order. Remote control is available over USB, RS232 and LAN communication interfaces. Voltage and current measurement precision is nominally 0.1%. See [Figure 1.1](#) for a view and details of the front panel.

1.1 Features

- 4.3-inch color LCD
- Configurable display of measurements in 3 formats
- Input range: 600Vrms/20Arms from DC to 100kHz
- Voltage, current, power, harmonics and other parameters are measured at the same time simultaneously
- Up to 0.1% voltage and current measurement accuracy
- Harmonic measurement up to the 50th-order harmonic
- Screen captures are saved to USB via the front panel connector
- Integration measurement of power produced or consumed
- Frequency measurement
- Remote control via USB, RS232 and LAN communication interfaces

1.2 Front Panel

Figure 1.1 illustrates and describes the front panel of the 5335C. Table 1.1 lists the functions available from the front panel buttons.



Item	Description	Item	Description
1	Power Button	6	Rotary Knob
2	4.3" LCD	7	Arrow Keys
3	USB	8	Soft-keys
4	Main Functions	9	Soft-keys
5	Menu, Enter, ESC	10	Print (Screen Capture)

Figure 1.1 Front Panel





Button	Name and function
	Waveform Display key: press to view waveforms. See Chapter 5
	Harmonic Measurement key: For viewing harmonic measurements. See Chapter 6
	Basic Measurement key: The normal measurement screen. See Chapter 3
	Integral Measurement key: Measurements over time. See Chapter 7
	Menu key, Press to view and configure settings. See Chapter 2
	Enter key: Press to commit a setting or value.
	Image Save key: press to save a hardcopy of the screen to the USB host port on the front panel.

Table 1.1 Front Panel Button Functions

1.3 Rear Panel

The rear panel includes the connections for current and voltage. The internal shunt is here and should be connected in series with the load. See **Figure 1.2**.

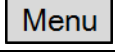
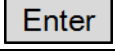
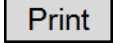

Item	Description	Item	Description
1	LAN Connector	5	AC Line
2	USB Connector	6	External Current Sensor
3	RS-232 Connector	8	Voltage Input
4	Synchronization BNC	7	Current Shunt Input

Figure 1.2 Rear Panel

1.4 Input Power and Fuse Requirements

AC Voltage 110V \pm 10% or 220V \pm 10%

Frequency 47Hz – 63Hz

An AC input fuse is necessary when powering the instrument. See **Table 1.2**.

5335C Fuse Specification
1.25 A, 250 V

Table 1.2 Required Fuses

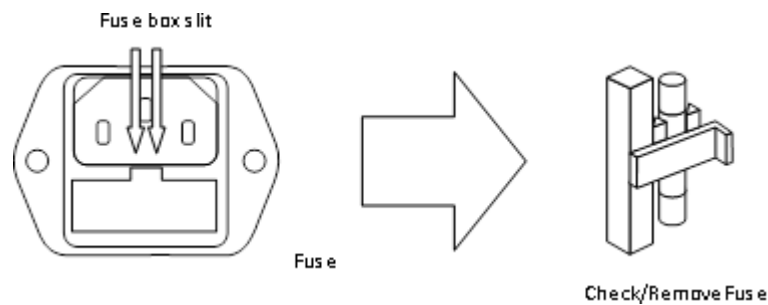

Figure 1.3 Fuse Holder

1.4.1 Fuse Replacement

1. Disconnect the power cord.
2. Locate the fuse box in the rear panel, beneath the AC power socket. **Figure 1.3**
3. With a small flat blade screwdriver, insert the blade into the fuse box slit to pull and slide out the fuse box.
4. Pull out the fuse inside to check and/or replace with the appropriate fuse for the line voltage used.
5. Insert the fuse in the same location.

1.5 Power-up Sequence

Connect AC power cord to the AC receptacle in the rear panel and press the power switch to the (ON) position to turn ON the instrument. It will display the BIOS version then run through a self-test procedure.

Menu

Configuration of system-wide settings is done from the "Menu". Pressing the **Menu** button enters the configuration/system menu. From the main menu, the soft-keys at the bottom of the screen provide access to the configuration screens. See **Figure 2.1**.

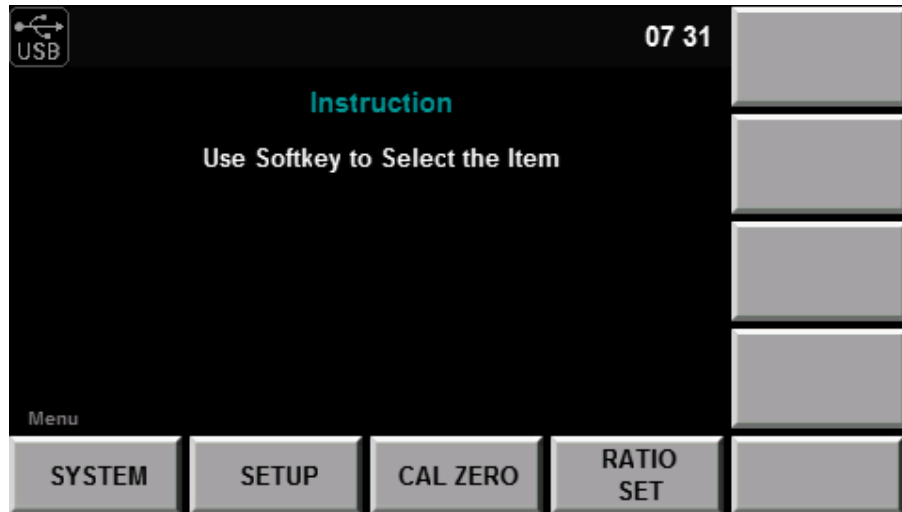

Item	Description
System	View and change overall system information and parameters
Setup	Device measurement and measurement configuration settings
Cal Zero	Zero the meter
Ratio Set	Change the overall scaling factor for measurements

Figure 2.1 Configuration/System Menu and Functions

2.1 System Softkey

The first softkey is the "System" menu. Within this part of the menu tree information about the system, communication settings, system settings like time and date, self test and setting the machine to the default state are available.

2.2 System Menu

From the system menu, system-wide functions are set and viewed. **Figure 2.2**, details such as the LAN MAC address, date, screen brightness, system initialization (settings reset), and self test are accessed here. See **Table 2.2**

2.3 System Information Menu

Information about the device is listed in this menu. See **Figure 2.2**.

Note: When contacting B&K, use the serial number on the label.

2.4 Communication Configuration Menu

Available remote interfaces are RS-232, USBTMC, and LAN. For details about commands and use of the remote interfaces, see the programming manual. The manual is found on the product page of the 5335C.



Item	Description
SYSTEM INFO	System details, Model, Serial, etc...
COMM CONFIG	Setup the communication interfaces
SYSTEM CONFIG	Set date, time, beep and brightness
SELF TEST	Perform a self diagnostic
INITIAL	Reset device settings

Figure 2.2 System Info Screen

2.4.1 RS-232

This interface support 6 common baudrates: 4800, 9600, 19200, 38400, 57600, 115200. Use the arrow keys to navigate the menu screen and the soft-keys to select the desired baudrate. The number of data bits, parity and stop bits are preset and unchangeable. (8 bits, no parity, and 1 stop bit, so called N-8-1). See [Figure 2.3](#).



Figure 2.3 COMM Configuration - RS-232

2.4.2 USB

This unit operates as a USBTMC (USB Test and Measurement Class) device. There are no configuration options for this interface. [Figure 2.4](#)

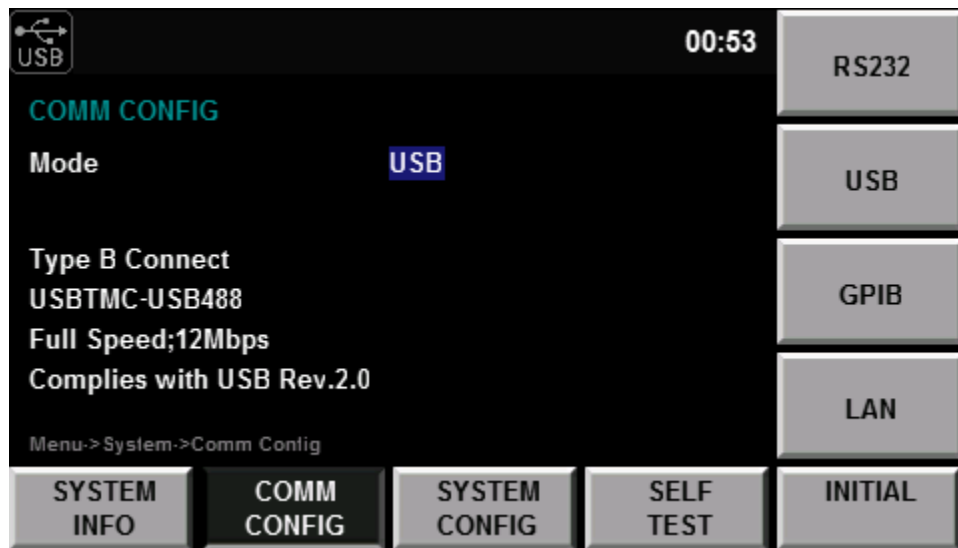

Figure 2.4 COMM Configuration - USB

2.4.3 LAN

The LAN (Ethernet) interface may be configured as either DHCP or static. Use the arrow keys to select the IP Mode field. When DHCP is selected, the current IP, subnet, and gateway are shown on screen (Figure 2.6). When "MANU" is selected (static mode) (Figure 2.7), the screen shows fields for setting the IP, subnet, and gateway. Using the arrow keys and the rotary knob allows the user to move between fields and digits, and use the rotary knob to change the value.

2.5 System Configuration Menu

From this menu, setting the date, time, brightness, and the state of the beep function is set. Use the arrow keys to navigate the fields, and the rotary knob to change the value. For the beep function, the soft keys are used to change the value. When settings are changed, press the **Enter** key to commit the changes. See Figure 2.8.



Figure 2.6 COMM Configuration - LAN (DHCP)

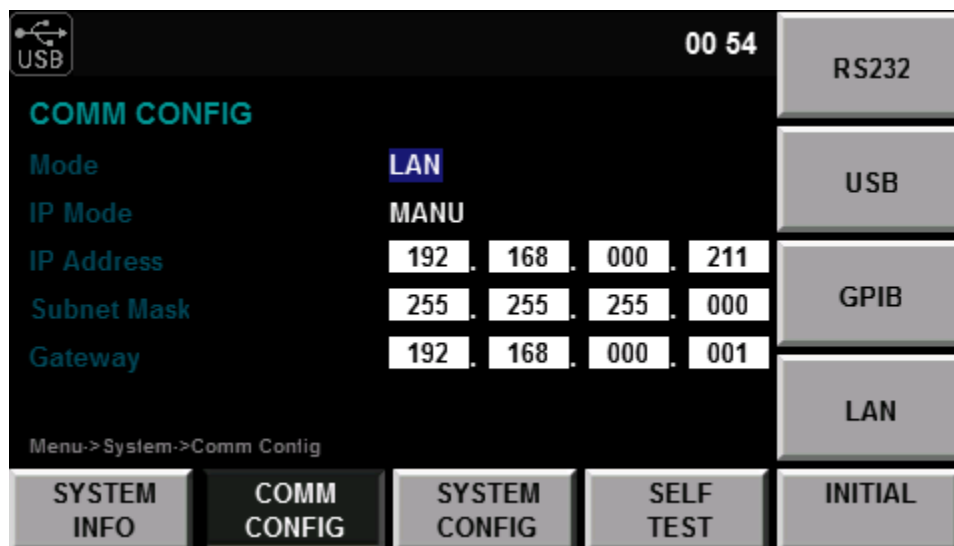

Figure 2.7 COMM Configuration - LAN (Manual (static))

2.6 Self Test

The unit has a built in self test. This function tests the LEDs, the screen and some of the internal electronics, [Figure 2.9](#). When the test is running, it cycles through colors on the LCD, and lights up the individual LEDs that illuminate the front panel buttons. When complete, the results are displayed on screen, DONE for the LCD and LEDs, and OK for the internal electronic tests.

From this screen, a test of each button is also available. A representation of all the buttons appears on screen after selecting the "KEY TEST" key, pressing the individual keys will highlight the text on screen indicating the button is working. Press the **Esc** to exit the test.

2.7 System Initialization Menu

System initialization will bring the manifold functions to their initial states. By navigating the functions listed on-screen and either selecting the check mark or "x" via the soft-keys, sets whether the function is initialized. See [Figure 2.10](#).

2.8 Setup Menu

The next set of menus available from the "Menu" key is the "Setup" menu. Pressing the "Setup" soft-key opens the "System Info" menu shown in [Section 2.8.1](#).

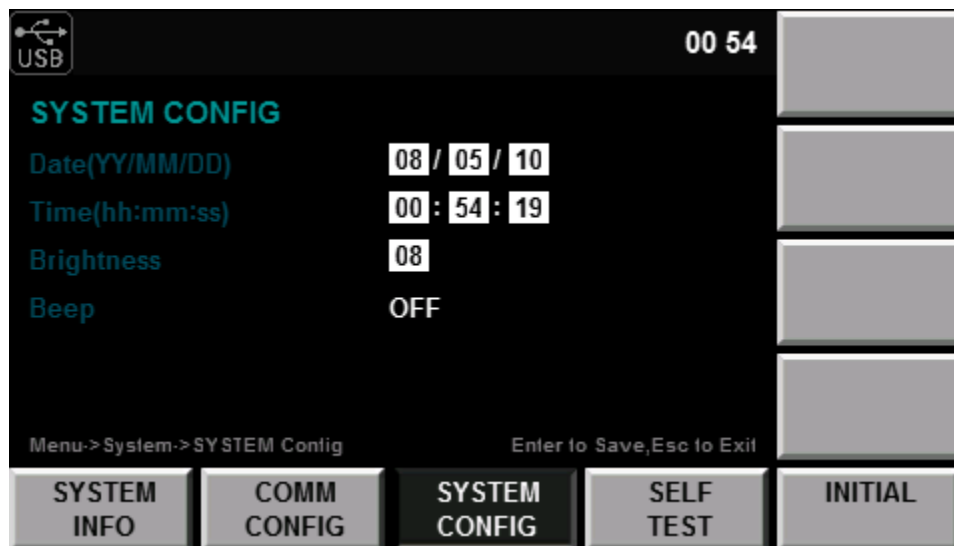

Figure 2.8 System Config Menu



Figure 2.9 System Self Test

2.8.1 Setup Info Menu

From the top level after pressing the “Menu” key, the second soft-key is “Setup”. This menu contains settings for configuring the measurement system of the meter. Setting such as averaging, external sensors, update speed and similar are configured under this menu. See [Figure 2.11](#).

2.8.2 Averaging Setup

When measuring low frequency signals where measurements begin to become unstable, averaging may be useful. To enable averaging enter the “Average Setup” menu (Menu>Setup>Average Set). See [Figure 2.12](#).

2.8.2.1 EXP - Index averaging

$$D_n = D_{n-1} + \frac{M_n - D_{n-1}}{k}$$

D_n The value displayed after the nth index averaging (D1, the value displayed after the first averaging, is equal to M1)

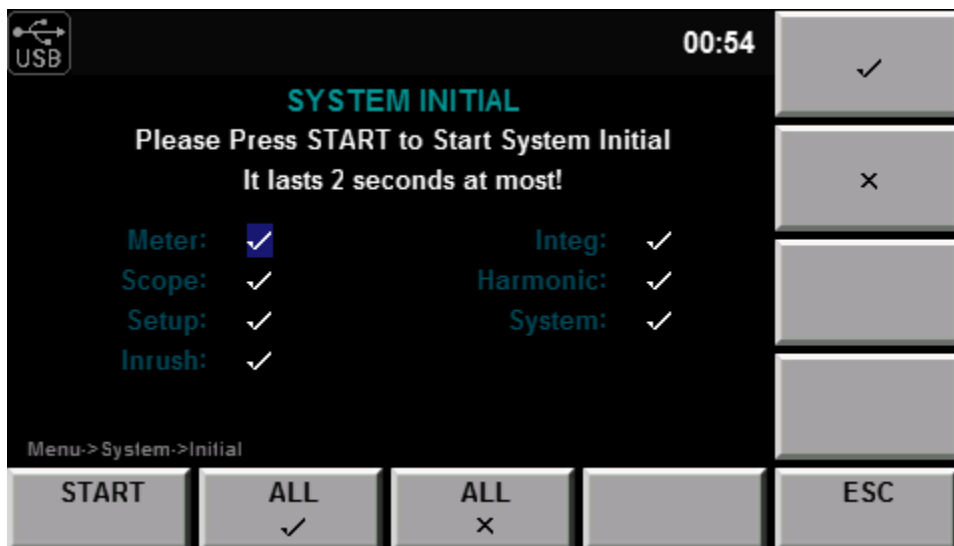
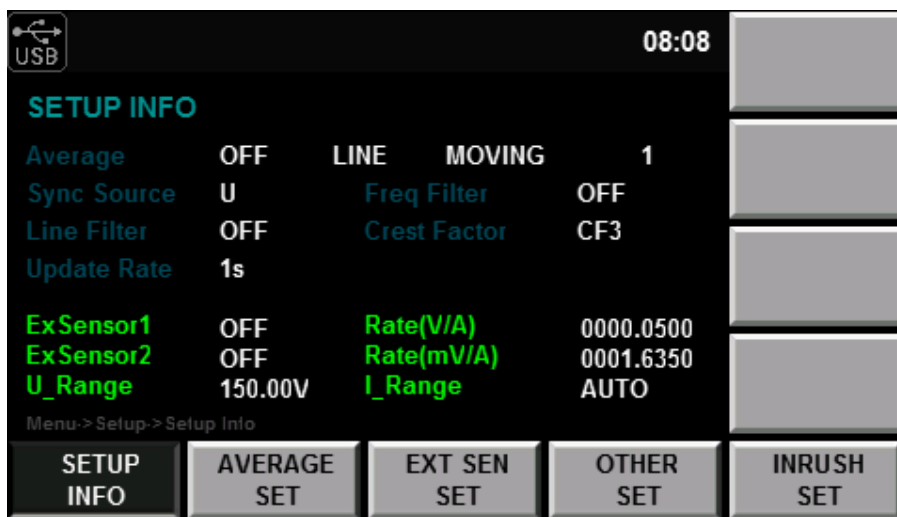

Figure 2.10 System Init Menu



Item	Description
Setup Info	Setup information: Averaging, Sync Source, Filters and sensor config
Average Set	Setup averaging
External Sensor	Enable and setup the external sensor inputs
Other Set	Setup the remaining settings
Inrush Set	Set the timing and trigger levels for measuring inrush

Figure 2.11 Setup Info Menu

D_{n-1} the value displayed after the (n-1)th index averaging

M_n the nth measured data.

K attenuation constant (1-64)

2.8.2.2 LINE - Linear averaging

$$D_n = \frac{M_{n-(M-1)} + \dots + M_{n-2} + M_{n-1} + M_n}{m}$$

D_n The value displayed after linear averaging of m values from the n - (m - 1)th to nth value



Item	Description
State	The state of the average function, On or Off.
Type	Exp or Line. Exp enables index averaging, and Line enables linear averaging.
Tcontrol	Sets averaging to being either a rolling or repeating average.
Count	EXP averaging attenuation constant, or LINE average count.

Figure 2.12

- M** Measured value
- m** The number of values in the average set (1-64)

When m is divisible by n , the calculated value is the moving average; otherwise calculated value is the repeated average.

NOTE: When index averaging is set, averaging is implemented under the harmonic measurement function. When linear averaging is set, averaging can only be implemented in the conventional measurement function and this mode is not applicable to the harmonic measurement function.

2.9 External Sensor Setup

Figure 2.13 is accessed via Menu>Setup>Ext Sen Set, and contains settings for external sensors. The state (on/off) and gain (V/A (mA)) are set here.

2.10 Other settings: Filter and Crest Factor

Configure the measurement filter, synchronization signal source and crest factor from the "Other Set" menu. Access this menu via Menu>SET UP>OTHER SET. The "Other Set" menu is shown in Figure 2.14.

2.10.1 Filter

Frequency filter it is inserted in the frequency measurement circuit and may affect frequency measurement. It can be used for filtering high-frequency components of interference to make the measured frequency parameter more accurate. When the frequency filter is switched on, the voltage or current of no more than 200Hz can be measured. The cutoff frequency is 500HZ.

Line filter it is inserted in the voltage and current measurement circuit and has direct influence on measurement of the voltage, current and power. When the line filter is switched on, noise and high-frequency components from the inverter or distortion waveform can be filtered. The cutoff frequency is 500HZ.



Figure 2.13 Ratio Set Menu



Item	Description
Sync Source	Select the synchronization source: U/I/OFF. The overall interval of the signal voltage, current or data updating cycle can be selected as the synchronization source for measurement.
Freq Filter	Set the status of the frequency filter. When "ON" is selected, the frequency filter is turned on. When "OFF" is selected, the frequency filter is turned off.
Line Filter	Set the status of the line filter. When "ON" is selected, the line filter is turned on. When "OFF" is selected, the line filter is turned off.
Crest Factor	Set the crest factor: CF3/CF6
Update Rate	Data Updating Rate Setting key: when this key is pressed, the capture interval of the voltage, current, power and other data, i.e. data updating rate, can be set. When the data updating rate is increased, rapid load changes of the power system can be obtained. When the data updating rate is decreased, relative low-frequency signals can be measured. Options of the data updating rate: 0.1s/0.25s/0.5s/1s/2s/5s

Figure 2.14

2.10.2 Crest factor

The crest factor is the ratio of the waveform peak to the effective value. The Measurement Conditions crest factor of

5335C is specified as the times of the crest value which can be input under the rated input conditions. The crest factor

CF3 or CF6 can be selected in the interface "Menu > SETUP > OTHER SET". See [Chapter 3](#) for more details.

2.11 Inrush Measurement Setup

Feature not currently implemented.



Setting	Description
State	ON/OFF - Enable or disable inrush measurement.
Trig Level(A)	The current level to trigger inrush measurement
Delay Time(ms)	The hold off time following a trigger to start measurement
Measure Time(s)	The duration of the measurement following trigger and delay

Figure 2.15 Inrush Measurement Setup Menu

2.12 Cal Zero

Next in the "Menu" functions is the "Zero Calibration" menu. From here a zero calibration of the unit is available. Enter this menu via "Menu>Cal Zero". See [Figure 2.16](#).

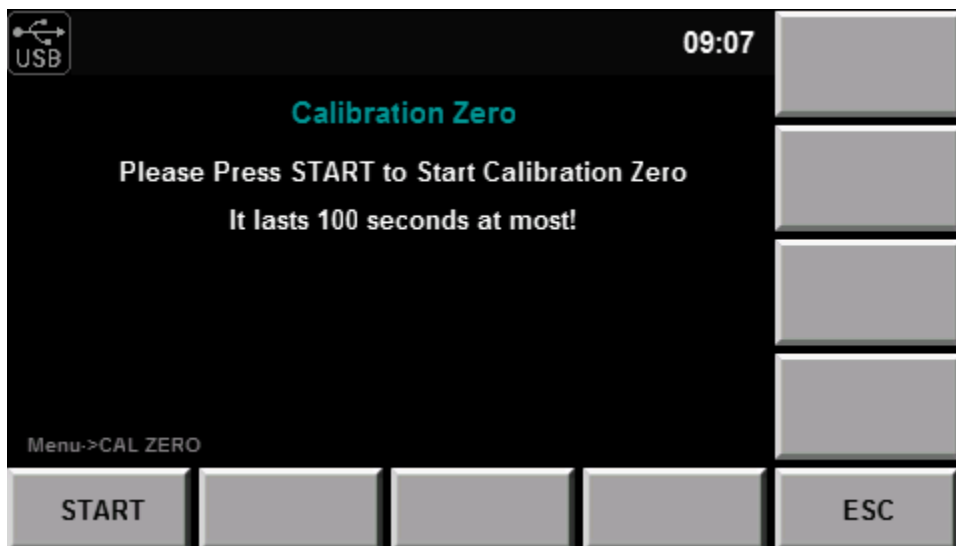

Figure 2.16 Calibration Zeroing

2.13 Ratio Setup

This setting has the effect of scaling the measured value of the current and voltage. For example, a 116V signal becomes 232V when the "Voltage Ratio" is set to 2. The Ranges are not effected by this setting, so the 150V range is still shown and used. Use the arrow keys to move between parameters and digits. Use the knob to change the value of the selected digit. To commit the setting change, press the **Enter** button. See **Figure 2.17**

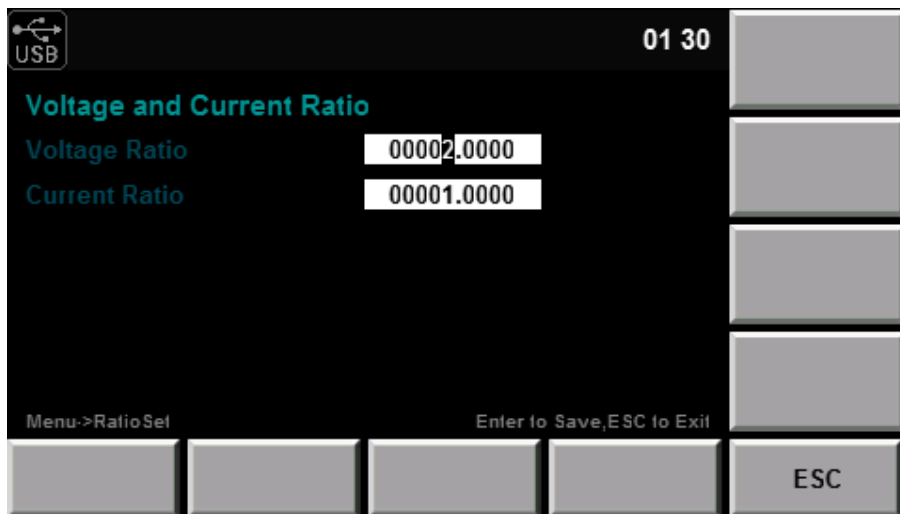

Figure 2.17 Ratio Setup Menu

2.14 External Current Sensor

More information to be added in future versions of this documentation.

When using an external current sensor, the power meter has more current range options.

	Crest Factor	Ranges
EXT1	Crest Factor 3 (CF=3)	2.5 V, 5 V, 10 V
EXT1	Crest Factor 6 (CF=6)	1.25 V, 2.5 V, 5 V
EXT2	Crest Factor 3 (CF=3)	50 mV, 100 mV, 200 mV, 500 mV, 1 V, 2 V
EXT2	Crest Factor 6 (CF=6)	25 mV, 50 mV, 100 mV, 250 mV, 0.5 V, 1 V

Table 2.1 External Sensor Ranges

Measurement Setup

Central to setting the proper range of the instrument is the Crest Factor. Crest factor is the ratio of the peak value of a waveform to the RMS value of the waveform. For example, a perfect sine wave crest factor RMS value is $0.707 \times \text{Peak}$. The crest factor is the inverse of the normalized RMS value, $0.707^{-1} = 1.414$. In many cases, like the current waveform of a AC-DC power supply, the crest factor is a larger value. For accurate measurement, the signal measured should stay within the measurement range of the instrument. For example, a 100V RMS signal with a crest factor of 5 has peaks of 500V. If the range selected is smaller than 500V than inaccuracy will occur as the signal will be clipped.

3.1 Crest factor

The Crest Factor, the ratio of the peak to the RMS value, has two settings, 6 or 3. This setting applies to both current and voltage simultaneously, and modifies the available ranges listed in [Section 3.2](#). Essentially, by knowing the RMS signal level and the peak value, the setting of this parameter is determined. For an 117V RMS AC line signal with little distortion and a purely real load (power factor = 1), the peak value is $1.414 \times 117V = 165V$. 1.414 is the approximate Crest Factor of a Sine wave. So, the appropriate setting will be 3 (CF3).

$$\text{Crest Factor}(CF) = \frac{\text{Peak}}{\text{RMS}}$$

As this meter also measures the DC level of the signal, this must also be accounted for when choosing the Crest Factor. If the the signal will exceed the range of the unit (crest factor * range) then the measurement value will be clipped and the value inaccurate. Conversely, by choosing a Crest Factor and Range combination that accommodates the peak value of the signal, a larger crest factor than set may be measured. The trade-off is then the accuracy, and is listed in the specifications, [Chapter 9](#).

3.1.1 Example - Range=150 V, CF = 6

The maximum input signal and crest factor are as follows:

$$V_{rms} = 100 \quad \text{Range} = 150V \quad V_{maxrange} = 900V$$

So, a signal with a peak that is 9 times that of the RMS value (Crest Factor 9) is measurable using these settings.

3.2 Set Measurement Range

The appropriate measurement range (voltage and current range) must be set for accurate measurement.

1. In the "Meter" interface Press the soft key corresponding to either "U-RANGE" or "A-RANGE", and use the knob or the arrow keys to select the voltage or current range desired. See [Table 3.1](#)
2. Press the "Enter" key to confirm the setting. Otherwise the instrument will automatically confirm and exit the setting after 5 seconds of no activity.

Parameter	CF 3	CF6
Voltage	15, 30, 60, 150, 300, 600V	7.5, 15, 30, 75, 150, 300V
Current	5, 10, 20, 50, 100, 200, 500mA, 1, 2, 5, 10, 20A	2.5, 5, 10, 25, 50, 100, 250mA, 0.5, 1, 2.5, 5, 10A

Table 3.1 Current and Voltage Ranges per Crest Factor setting

3.3 Fixed Voltage and Current range

Select the required range from a number of options. For the voltage range, when the crest factor is 3, the maximum option is 600V and the minimum option is 15V. When the crest factor is 6, the maximum option is 300V and the minimum option is 7.5V. See [Table 3.1](#)

Note: Measurement accuracy is improved by minimizing the range for a given input signal.

3.4 Auto Voltage and Current range

The measurement range adjusts automatically according to the input signal, and uses same ranges as in Fixed range mode. See [Table 3.1](#).

Adjustment of the range occurs when the following conditions occur:

3.4.1 Increasing range

- Urms or Irms exceeds 110% of the current range setting.
- When the crest factor is 3, and the peak voltage or current exceeds 330% of the range currently set.
- When the crest factor is 6, and the peak voltage or current exceeds 660% of the range currently set.

3.4.2 Decreasing range

- Urms or Irms is less than or equal to 30% of the current measurement range.
- The crest factor is 3. The value Upk or Ipk of the input signal is less than 300% of the range at the following level.
- The crest factor is 6. The value Upk or Ipk of the input signal is less than 600 % of the range at the following level.

Note: The selected automatic range may change when the input is a random pulse. In this case, a fixed range should be used.

3.5 Measurement interval

The measurement interval is the time during which data is taken. The fundamental frequency of the measured signals restricts the measurement intervals that yield meaningful results. For example, measuring 10Hz with an interval of less than the 0.5s setting will not yield stable results. The unit needs a number of cycles to be present to determine the frequency, and measurement intervals are not synchronized to the input.

Note: The scope timing parameters do not control the measurement interval.

- A cycle is determined by detecting zero crossings.
- Either positive, or negative going transitions of the synchronization source determine the measurement timing. If the zero crossings do not occur within the set update interval, the entire interval is used for calculating the various measurements. See [Figure 3.1](#).
The choice of rising or falling transition is determined as that which gives the greatest amount of time.
- For peak value measurements (Ipk+, Upk-, etc...), the entire update interval is used. Measurements of Crest Factor, as it is the Peak to RMS ratio, are also determined using the entire measurement update interval.
- The input signal used as the synchronization source is configurable, and determines the synchronization with the zero point of that input signal. The overall interval of the voltage, current or data updating cycle may be selected as the synchronization source.

Note: The data updating cycle refers to the cycle used for calculating sampling data of the measurement function. It is identical to the set value of the data updating rate. The slope refers to signal changes from low level to high level (rising edge) or from high level to low level (descending edge).

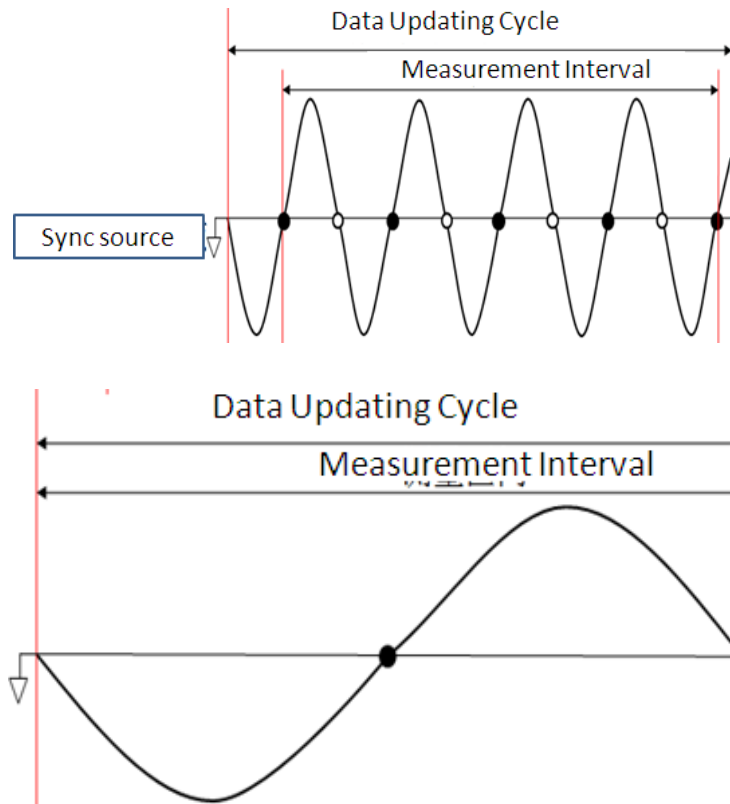

Figure 3.1 Measurement Timing

3.6 Filter and Crest Factor Setting

1. Select Menu → SET UP → OTHER SET and enter the OTHER configuration page.
2. Press ▲ ▼ to select the parameter to be configured (blue font background), and then press the soft key corresponding to the parameter on the right to set the required value, as shown in the [Figure 3.2](#).
3. Press the Enter key to save the settings.

3.7 Frequency Filter

It is inserted in the frequency measurement circuit and may affect frequency measurement. It can be used for filtering high-frequency components of interference to make the measured frequency parameter more accurate. When the frequency filter is switched on, the voltage or current of no more than 200Hz can be measured. The cutoff frequency is 500Hz.

3.8 Line filter

It is inserted in the voltage and current measurement circuit and has direct influence on measurement of the voltage, current and power. When the line filter is switched on, noise and high-frequency components from the inverter or distortion waveform can be filtered. The cutoff frequency is 500Hz.

3.9 Averaging Function

1. Select Menu ⇒ SET UP ⇒ AVERAG SET to enter the configuration page of the averaging function.
2. Press ▲ ▼ to select the parameter to be configured (blue background), and press the soft key corresponding to the required value. See [Figure 3.3](#).
3. Press the Enter button to confirm the setting.

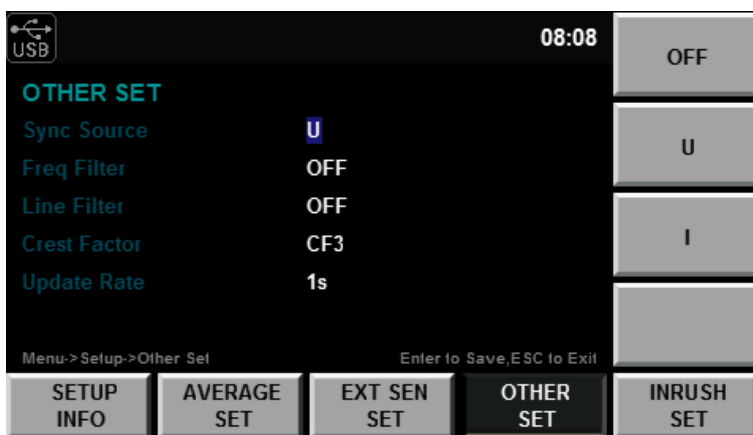

Setting	Description
Sync Source	Synchronization Source, the source used to determine the measurement interval. May be set to voltage (U), current (I) or turned off.
Freq Filter	Enable or disable the Frequency Filter.
Line Filter	Enable or disable the Line Filter.
Crest Factor	Set the crest factor to 3(CF3), or 6 (CF6) (See Section 3.1)
Update Rate	Data Update Rate: the capture interval of the voltage, current, power and other data can be set. When the data updating rate is increased, rapid load changes of the power system can be measured. Conversely, when decreased, relative low-frequency signals can be measured. Values = 0.1, 0.25, 0.5, 1, 2, and 5 seconds

Figure 3.2 Other Settings Menu

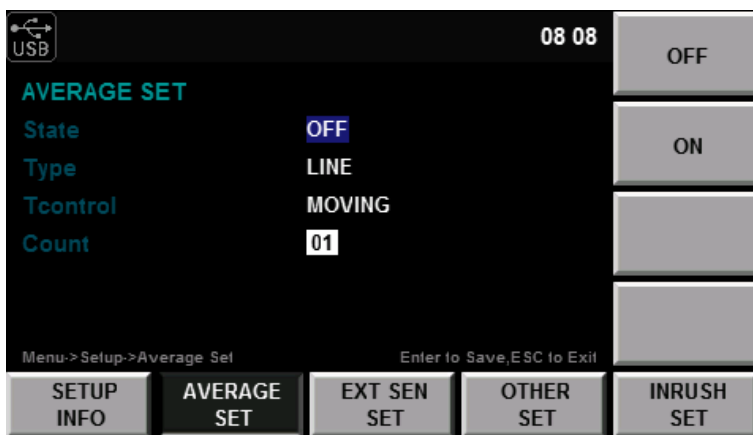

Function	Description
State	Enable or disable averaging.
Mode	Average mode Line=linear or Exp=cumulative moving average
Type	Averaging type. MOVING: moving averaging REPEAT: repeated averaging
Count	Set the times of the averaging function.

Figure 3.3 Averaging Settings

Note: If the mode of the averaging function is set as EXP (index averaging), the attenuation constant can be set. If the mode of the averaging function is set as LINE (linear averaging), the averaging times can be set.

3.10 Index averaging

$$D_n = D_{n-1} + \frac{M_n - D_{n-1}}{k}$$

D_n	The value displayed after the nth index averaging, (D_1 , the value displayed after the first averaging, is equal to M1)
D_{n-1}	The value displayed after the (n-1)th index averaging
M_n	the nth measured data.
k	attenuation constant (1-64)

Table 3.2

3.11 Linear averaging

$$D_n = \frac{M_{n-(m-1)} + \dots + M_{n-2} + M_{n-1} + M_n}{m}$$

D_n	linear average of m values from the $(n - (m - 1))^{th}$ to n^{th} value
$M_{n-(m-1)}$	$(n - (m - 1))^{th}$ measured data
M_{n-2}	$(n - 2)^{th}$ measured data
M_{n-1}	$(n - 1)^{th}$ measured data
M_n	n^{th} measured data
M	the number of average values (1-64)

Table 3.3

When m can be divided exactly by n, the calculated value is the moving average; when there is no particular relationship between m and n, the calculated value is the repeated average.

Note: When index averaging is set, averaging is implemented under the harmonic measurement function. When linear averaging is set, averaging can only be implemented in the conventional measurement function and this mode is not applicable to the harmonic measurement function.

The following measurements are subject to direct averaging:

1. Urms, Umn, Udc, Urmn, Uac, Irms, Imn, Idc, Irmn, Iac, P, S and Q.
2. Ucf, Icf, λ and WPAV are calculated by operation of the averaged Urms, Irms, P and S.

3.12 Harmonic measurement averaging

The following measurement functions are subject to direct averaging:

1. U(k), A(k), W(k), S(k) and Q(k).
2. $\lambda(k)$ is calculated via operation of the averaged W(k) and Q(k).
3. U(%r), A(%r), W(%r), U(%f), A(%f) and W(%f) are calculated via operation of the averaged U(k), A(k) and W(k). (k indicates the harmonic times.)

Meter Display

The 5335C has 3 configurable display formats. Each format also allows for 5 different configured sets of measurement. 1 large and 6 small, 4 large and 6 small, or 12 small measurements may be displayed. See [Figures 4.1,4.2,4.3](#).

4.1 Operation steps

1. Press **Menu**
2. The "View" soft-keys select the display format (1,4,12). Repeated press of the soft-key cycles through the different configurations, up to 5 of them.
3. The "CONFIG" soft-key enters the configuration mode for that set of pages.
4. The "FUNC" soft-key cycles through the sets of measurements available for Power (P), Current (I), and Voltage (U).
5. To change the measurements shown on a page, use the arrow keys and move the cursor to an on-screen parameter, and select the desired measurement from the soft-keys on the right of the display.
6. To add or remove a page press the "INSERT PAGE" or "DELETE PAGE" respectively. 1 to 5 pages are supported.

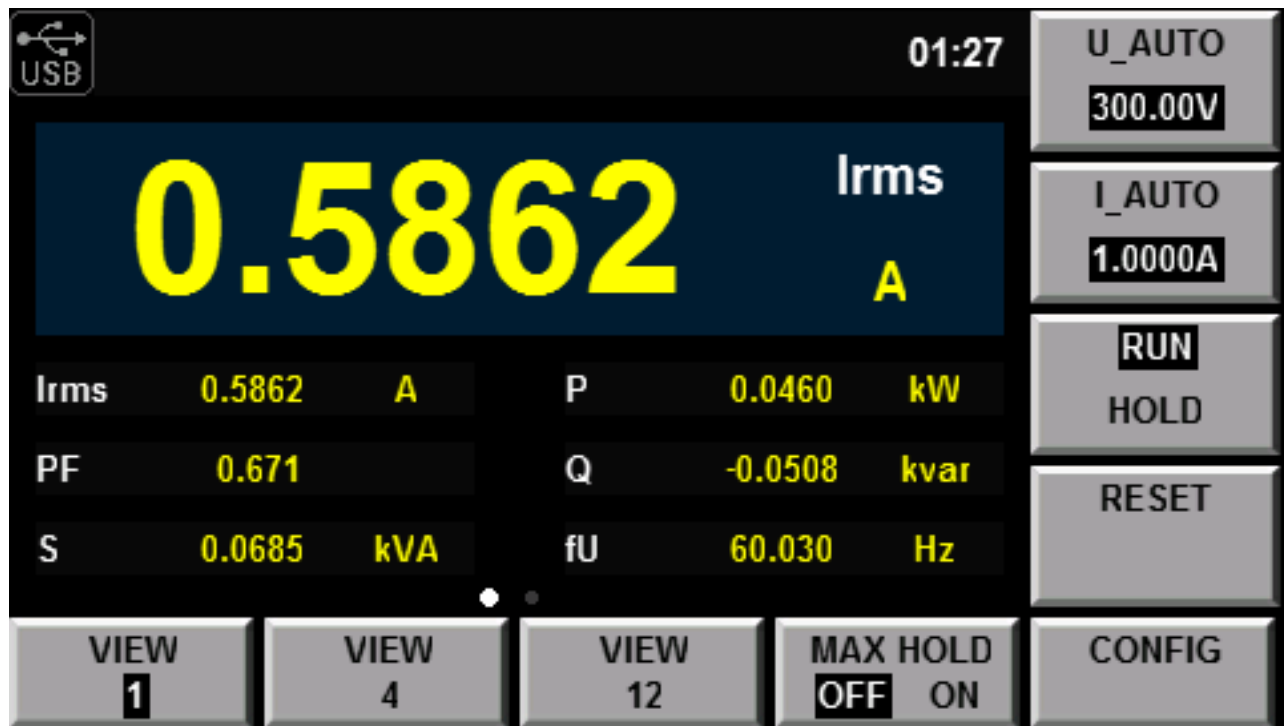

Figure 4.1 1 main measurement

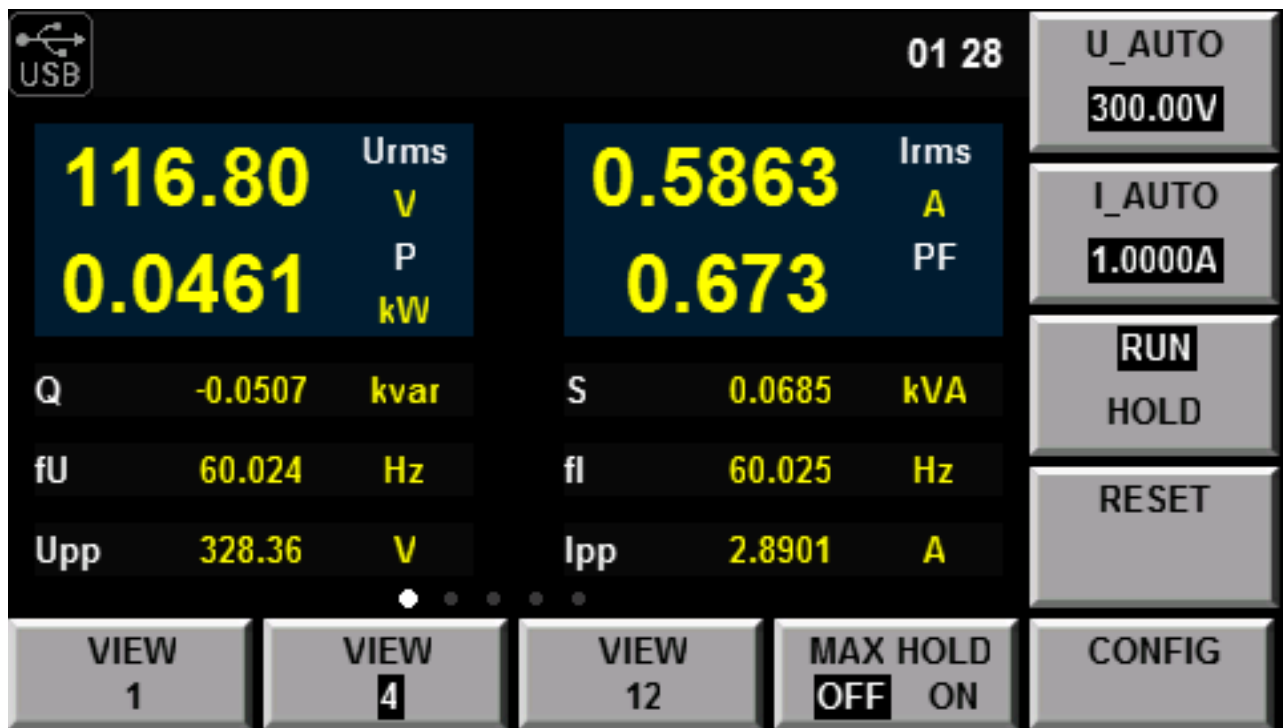

Figure 4.2 4 main measurements



Figure 4.3 12 main measurements

Waveform Display Function

The 5335C power meter displays waveform representations of the sampled data measured. This function is designed to be similar to an oscilloscope with many of the typical functions of oscilloscopes available, like trigger, run/stop and single trigger. The capture of data is not limited to that displayed onscreen, the measurement interval is also involved. For example, measuring a 15Hz signal with the interval set to 0.1s does not allow for stable measurement of the frequency. The waveform is however still viewable at 100ms/div.

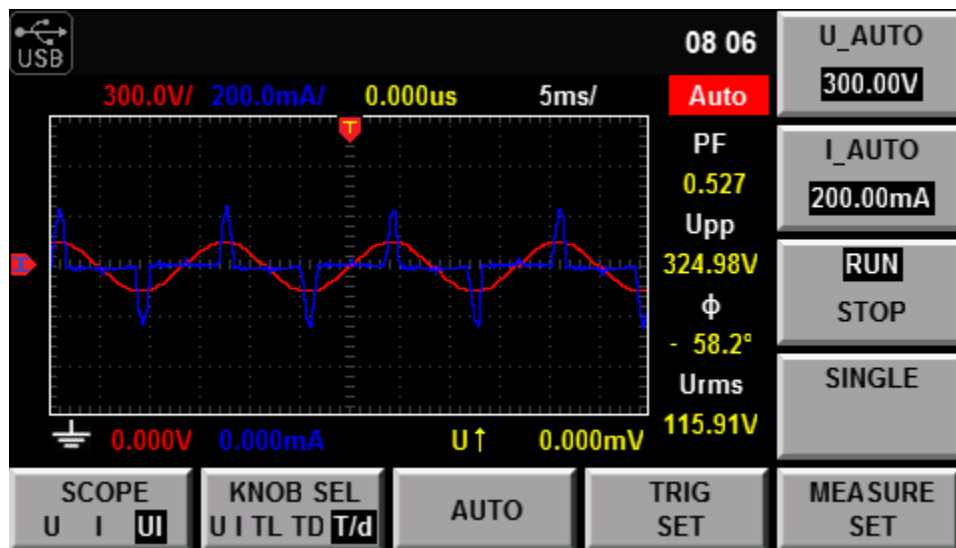

Figure 5.1 Waveform Display Details

To enter the waveform function press the  button.

Parameter	Description
V_RANGE	Voltage range setting: press to set the voltage range
A_RANGE	Current range setting: press to set the current range
RUN/STOP	Run/stop: press to run or stop waveform capture
SINGLE	Single measurement: pressing this stops capture and proceeds with a single capture of data following a trigger event.
SCOPE(U/A/UA)	Select the waveform(s) to display on screen (voltage/current/voltage and current)
KNOB SEL (U/A/TL/TD/Td)	Knob selection, the parameter adjusted by turning the knob. voltage waveform position (U), current waveform position (I), trigger level (TL), trigger delay (TD), time/division (T/d)
AUTO	Automatic mode: the power meter will automatically set the waveform display configuration
TRIG SET	Trigger setup menu. See Section 5.2
MEASURE SET	Measurement setup menu.

Table 5.1 Waveform Display Parameters

5.1 Trigger Status

The Auto/Stop field in the upper right corner of the display, below the time shows the trigger status. The meanings are as follows:

Auto Auto mode and a trigger has occurred

Auto? Auto mode waiting for a trigger

Trig? Single mode waiting for a trigger

Stop Capture stopped. Reached either by pressing "stop" or completing a single mode capture

5.2 Trigger Setup

When you need to enable the trigger function, you should select the trigger source, trigger mode, trigger slope and other trigger-related configuration. Detailed steps are as follows:

Operation steps

1. Press  to enter the waveform display interface.
2. In the waveform display interface Press the soft key corresponding to the "TIRG SET" parameter to enter the trigger setting interface, as shown below.

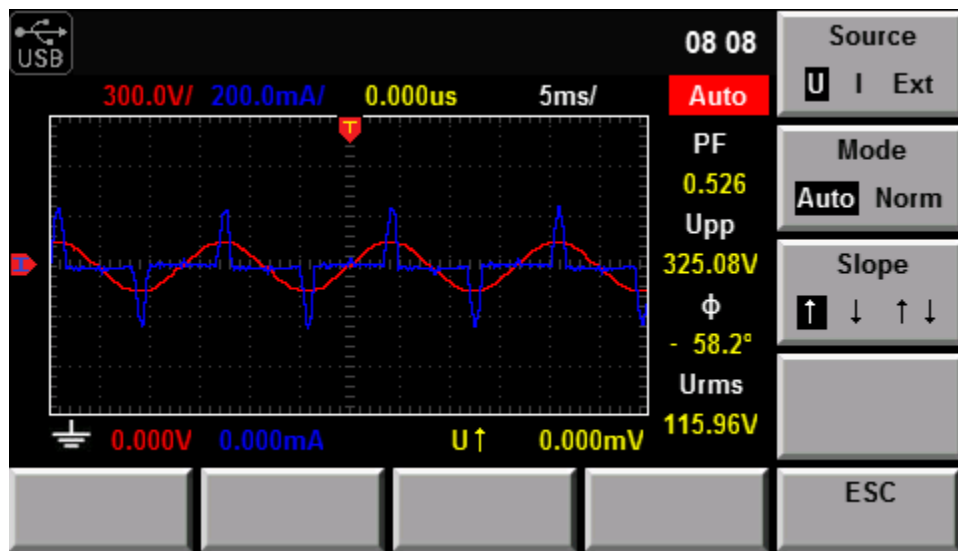

Figure 5.2 Trigger Setup Screen

3. Press the right soft key corresponding to the parameter to select the required trigger configuration.

Source trigger source

Mode trigger mode

Slope trigger slope

5.3 External trigger input (Ext)

When the trigger source is set as Ext, input the trigger signal into the external signal input interface (Synchronous) of the rear panel according to the following specifications.

Parameter	Specification
Interface type	BNC interface
Input level	TTL
Minimum pulse width	1 μ s
Trigger delay time	Within (1 μ s + 3 sampling cycles)

Table 5.2

NOTE: When the voltage higher than 0-3.3V is applied on the external signal input interface (Synchronous), the instrument may be damaged.

Minimum pulse width refers to the width of the high or low trigger level, at least $1\mu s$.

Trigger delay time refers to the delay between the appearance of the trigger level and the response of CPU, within ($1\mu s + 3$ sampling cycles).

Harmonic Measurement Function

With the 100kHz bandwidth, the 5335C power meter can realize harmonic measurement of high speed and wide dynamic range. The voltage, current, active power, reactive power, phase of harmonics and total harmonic distortion (THD) factor can be tested in harmonic measurement mode. Display of harmonic parameters is either in list or bar chart form for clear analysis of test results.

To enter this mode, select the  button, and the initial harmonic measurement interface starts.

Parameter	Description
V_RANGE	Voltage range setting
A_RANGE	Current range setting
RUN/HOLD	Set the instrument to either "run" and continue measuring, or "hold" to freeze the measurements
RESET	Clear measured values
FUNC(W/A/V)	When in bar mode, rotate between viewing power, current, and voltage harmonic measurements
BAR	Display the bar chart mode
LIST	Display the list mode
SETUP	Enter the setup menu. See Section 6.3

Table 6.1 Harmonic Measurement Parameters

6.1 Bar Graph Mode

The bar chart, [Figure 6.1](#), is used for displaying the percentage of different harmonics. Enter this mode by pressing the  button (if not in the harmonic mode already), then select "BAR" from the on-screen soft-keys. Harmonics from 1 to 50 may be displayed at once. From the list of harmonics, Odd, Even or All harmonic subsets may be displayed. The bar graph shows either the Power, Current, or Voltage harmonic components. Select the function by repeatedly pressing the "FUNC" soft-key.

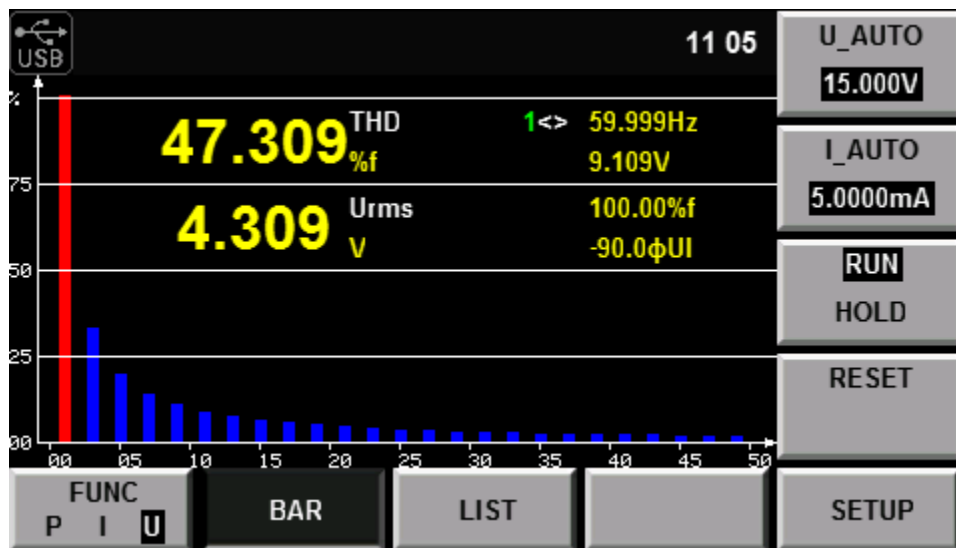

Figure 6.1 Bar Graph

On the bar graph display, individual harmonics may be selected by using the arrow keys or the rotary knob. [Figure 6.2](#) shows the 9th harmonic of 62Hz. Also shown highlighted in cyan is the bar and measurements associated with that particular harmonic (frequency, harmonic content, harmonic distortion factor and phase).

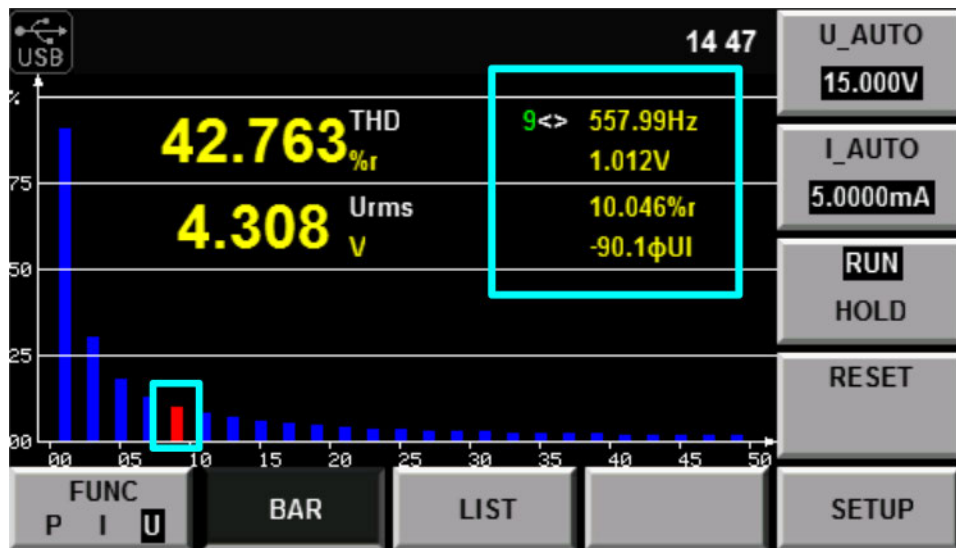

Figure 6.2 Bar Graph Data

6.2 List Mode

Enter this mode by pressing the **LIST** button (if not in the harmonic mode already), then select "LIST" from the on-screen soft-keys. This list is used for showing the voltage, current, active power, reactive power, phase and total harmonic distortion (THD) factor of different harmonics. Harmonic lists can be displayed as a complete, odd, or even set. See **Figure 6.3**. From the "SETUP" menu, the list of harmonics is defined. The 1st through the 50th, odd, even, or all harmonics to display is configured here.

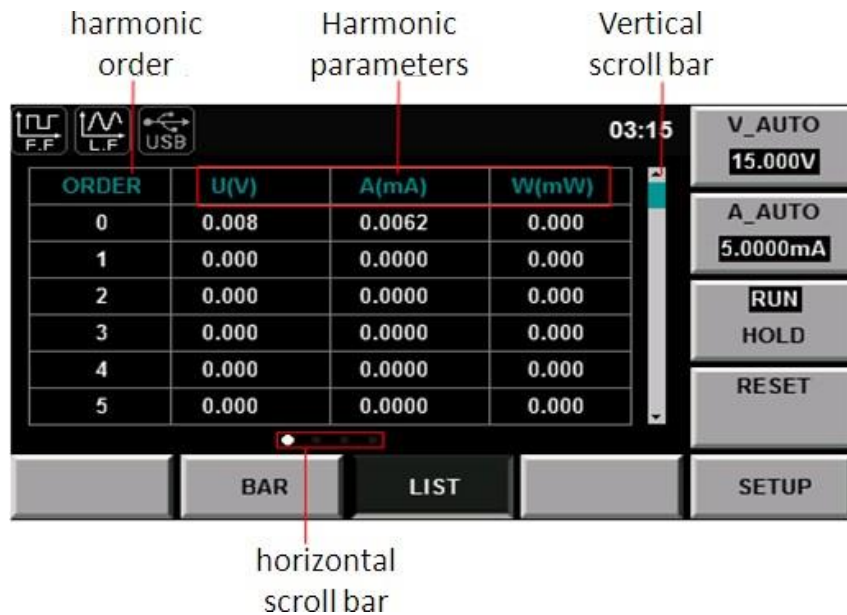

Figure 6.3 List mode - Harmonics

The list is composed 4 pages. Navigate to each page using the right and left arrow keys. The table columns are listed in **Table 6.2**

6.3 Setup Menu

The setup menu allows the user to set the distortion factor calculation formula, PLL source, and set of harmonics to analyse and display. From the Harmonic Measurement function **LIST**, press the "MENU" soft-key, **Figure 6.4**.

Function	Description
U(V)	Voltage
I(mA)	Current
P(mW)	Power
Q(mvar)	Reactive Power
S(mVA)	Apparent Power
PF()	Power Factor
$\phi_{UI}(\circ)$	Phase difference of k-order harmonic voltage and harmonic current
$\phi_{UU}(\circ)$	Phase difference of harmonic voltage U(k) and fundamental U(1)
$\phi_{II}(\circ)$	Phase difference of harmonic current I(k) and fundamental I(1)
U(%r) or U(%f)	Voltage harmonic distortion
I(%r) or I(%f)	Current harmonic distortion
P(%r) or P(%f)	Power harmonic distortion

Table 6.2 Measurement Parameters



Figure 6.4 Harmonic Measurement Setup Menu

6.3.1 Parameters

Use the arrow keys to select the different parameters, and if numeric, the rotary knob to set the value, or the soft-keys.

THD Formal Distortion factor calculation formula.

% r displaying harmonics in the form of percentage to the overall current (voltage, power) amplitude of all harmonics.

% f displaying harmonics in the form of percentage to the fundamental wave current (voltage, power).

PLL Source Select the PLL (Phase Locked Loop) source: U/I/OFF. Used for determining the fundamental wave cycle as the reference for analysis of harmonic orders.

Serial Harmonic sequence: whole sequence/odd sequence/even sequences

Order Max Set the harmonic analysis orders (1-50). You can specify the harmonic measurement range. These specified analysis orders are used for calculating the value of the distortion factor.

6.3.2 Distortion factor

Distortion is either calculated relative to the fundamental (%f) or to the total signal (%r). Internally, the 5335C calculates according to the following equations:

Measurement function	%r	%f
Harmonic distortion factor of voltage	$\frac{U(k)}{U(total)}$	$\frac{U(k)}{U(1)}$
Harmonic distortion factor of current	$\frac{I(k)}{I(total)}$	$\frac{I(k)}{I(1)}$
Harmonic distortion factor of active power	$\frac{P(k)}{P(total)}$	$\frac{P(k)}{P(1)}$
Total harmonic distortion rate of voltage	$\frac{\sqrt{\sum_{k=2}^{max} U(k)^2}}{U(total)}$	$\frac{\sqrt{\sum_{k=2}^{max} U(k)^2}}{U(1)}$
Total harmonic distortion rate of current	$\frac{\sqrt{\sum_{k=2}^{max} I(k)^2}}{I(total)}$	$\frac{\sqrt{\sum_{k=2}^{max} I(k)^2}}{I(1)}$
Total harmonic distortion rate of active power	$\frac{\sqrt{\sum_{k=2}^{max} P(k)^2}}{P(total)}$	$\frac{\sqrt{\sum_{k=2}^{max} P(k)^2}}{P(1)}$

Table 6.3

NOTE Total harmonics are calculated as follows: $U(total) = \sqrt{\sum_{k=0}^{max} U(k)^2}$, $I(total) = \sqrt{\sum_{k=0}^{max} I(k)^2}$, $P(total) = \sqrt{\sum_{k=0}^{max} P(k)^2}$. "k" indicates the harmonic order, and max indicates the upper limit of analysis orders, and the max is determined by the frequency of the PLL source automatically, at most 50.

6.3.3 PLL source

In the harmonic mode, 5335C uses a PLL to multiply the input signal fundamental. The frequency multiplication is used as the A/D sampling clock in the instrument in order to achieve ideally synchronous sampling. The range of the PLL source is from 10Hz to 1.2kHz. To maximize accuracy, select the cleanest signal source available, either the voltage or the current. This improves measurement consistency and stability, especially in relation to harmonic analysis.

If the amplitude level of the signal input into the unit as the PLL source is small relative to the range, PLL synchronization might fail. If the crest factor is set as 3, the amplitude level of the PLL source should be greater than 50% of the range. If the crest factor is set as 6, the amplitude level of the PLL source should be greater than 100% of the range.

When the fundamental wave frequency is less than 200Hz, the frequency filter should be turned on. When lower than 440Hz and containing high-frequency components, it is also best to turn on the frequency filter. This filter only applies to the frequency measurement circuit.

If the frequency of the PLL source changes, the correct measured value will be displayed after data are updated several times. The frequency of the PLL source needs to be tested again via the PLL circuit in the instrument in case of changes of the PLL source or its frequency, the correct measured value will be determined afterward.

NOTE If the analysis window determined by the fundamental frequency of the PLL source is longer than the data updating cycle, no harmonic data will be detected. In this case, the data update cycle should be lengthened. For example, when the fundamental wave frequency of the PLL source is 10Hz (cycle: 100ms), the analysis window is one-wave long, and the data measurement interval is 100ms. In this case, the harmonic measurement time is approximately more than or equal to 150ms (data measurement interval and data processing time). Therefore, select the data update rate of 250ms or more for measurement and display of harmonic data.

Integral Operation Function

Access the integration function by pressing the "Integ" button. This function integrates power and current measurements over time to generate measurements in producing (sold) or consuming (buying) directions.

The 5335C power meter can be used for integral operation of the current and power of the input unit. Technical indicators can be calculated. In addition, the range can be switched automatically in the Buy and Sell modes according to the input level so as to accurately complete integrate measurement.

During operation of the air-conditioner, refrigerator, induction cook and other household appliances, the working status will change frequently, resulting in changes of the working current in a large scale. The current may decrease of dozens of amperes to a few milliamperes. Ordinary power measuring instruments can only be used for integral measurement within one range. If the measured value exceeds the current maximum range, the measurement result is inaccurate. You need to manually switch the range before integral measurement. Integral measurement of equipment subject to large current changes cannot be performed continuously. The BK5335C power meter can automatically switch the range in the integral mode. Therefore, errors of integral measurement caused by manual range switching can be eliminated, and the power consumption of household appliances can be measured more accurately. See the schematic diagram below.

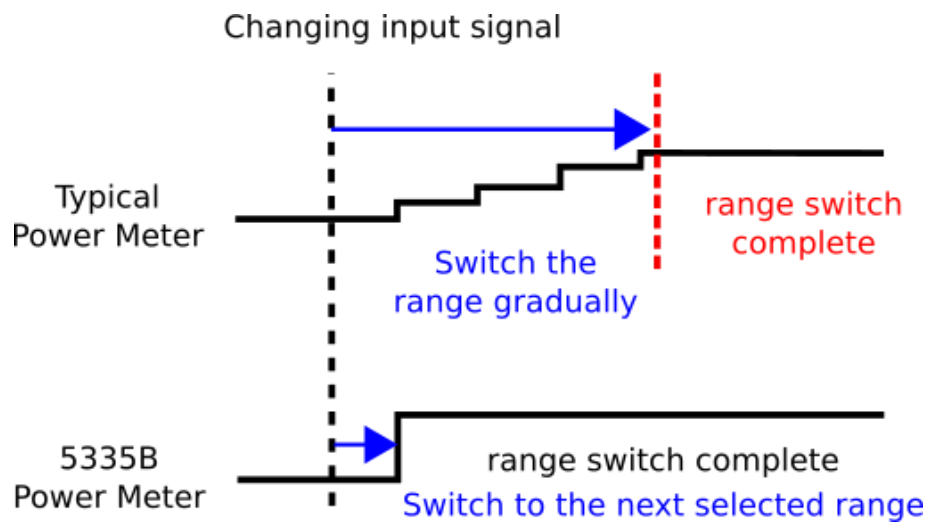

Figure 7.1 Range Switching

When the "Integ" button is pressed, the initial integral measurement interface below will appear.

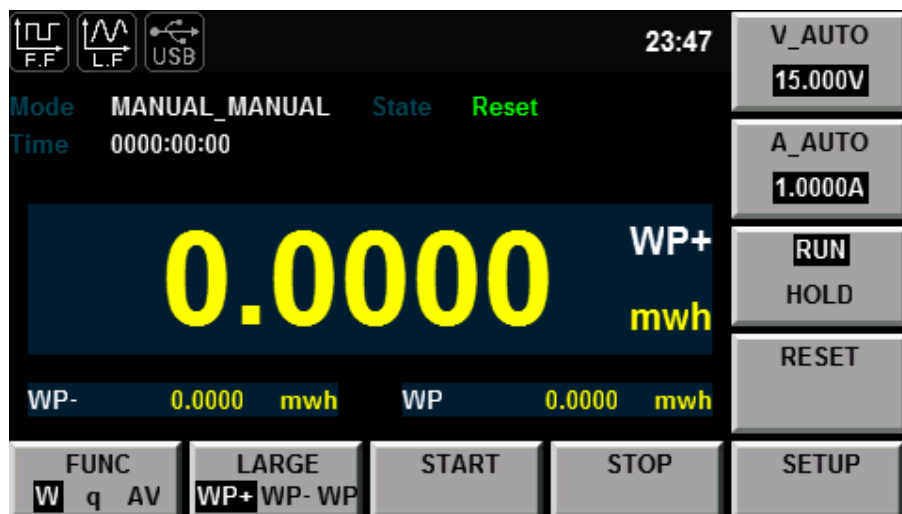

Figure 7.2 Meter Display

Description of information of integral measurement interface:

Parameter	Description
V_RANGE	Voltage range setting: press the soft key corresponding to this parameter to set the voltage range.
A_RANGE	Current range setting: press the soft key corresponding to this parameter to set the current range.
RUN/HOLD	Run/hold: press the soft key corresponding to this parameter to run or hold the integral function.
RESET	Reset.
FUNC(w/q/AV)	Selection of the integral function: active power integral (W), current integral (q) and average active power integral (AV).
LARGE (WP/WP+/WP-, q/q+/q-, WPAV)	Selection of the item to be displayed in a amplified manner: WP (watt hour, the sum of positive and minus watt hours), WP+ (the consumption of positive watt hours), WP- (the negative watt hours of feedback power), q (ampere hour, the sum of positive and negative Ampere hours), q+ (the consumption of positive Ampere hours), q- (the negative ampere hours of feedback power) and WPAV (average active powerintegral).
START	Integral Start button In the manual start mode, the integral function can be enabled by pressing the soft key corresponding to this parameter.
STOP	Integral Stop button In the manual stop mode, the integral function can be disabled by pressing the soft key corresponding to this parameter.
SETUP	Set relevant parameters of integral measurement.

Table 7.1 Integral Measurement Soft Keys

7.1 Integral measurement display information

Description of measurement information:

Function	Description
Mode	Display the integral start and stop mode. Start mode: MANUAL and TIMEStop mode: MANUAL, TIME and TINTERval.
State	Display the current status of the integral function.
Start	displayed when the integral function is working.
Stop	displayed when the integral function is interrupted, canceled or stopped.
Ready	displayed in the ready state of the real-time start mode.
Time Up	displayed when it reaches the specified time of the integral timer.
Reset	displayed when the integral value and integral time are reset via integral resetting.
Error	when the power supply is recovered, the integral function is stopped and the integral result before power failure is displayed. This integral state is called Error state.
Time	Display the integral time.
St	Display the set integral time.
Et	Display the set integral ending time.
Timer	Display the fixed integral time.

Table 7.2 Measurement Information

7.1.1 Integral operation

- Active power integral In watt hour, displayed as WP (watt hours, the sum of positive and negative watt hours), WP+ (the consumption of positive watt hours) and WP- (the negative watt hours of feedback power).
- Current integral In q, displayed as q (ampere hours, the sum of positive and negative ampere hours), q+ (the consumption of positive ampere hours) and q- (the negative ampere hours of feedback power)
- Average active power integral In watt, displayed as WPAV (average active power integral)
- Integration time Displayed as Time, in the format of hhhh:mm:ss.

7.2 Specification

- Save in case of power failure The integral result can be kept in the memory even in case of power failure during operation of the integral function. When the power supply is recovered and the integral function is disabled, the integral result before power failure is displayed. When the power supply is recovered and the integral is rest, the integral function is enabled again.
- Display resolution The maximum display resolution of the integral value is 99999. When the integral value reaches 100000, the decimal point will move automatically. For example, when 0.01mWh is added to 999.99mWh, 1.0000Wh will be displayed.
- Display in case of overflow When the integral value meets the following overflow conditions, the integral function will be disabled, and the integral time and integral value at this point will be kept.
 - The integral time reaches the maximum value (10000hours).
 - The integral values of WP, q and WPAV reach the maximum/minimum display integral values.
- Maximum/minimum display integral value
 - Active power integral (WP): ± 99999 Mwh
 - Current integral (q): ± 99999 MAh
 - Average power integral (WPAV): ± 99999 Mw
- Restricted implementation Settings of the following functions cannot be changed during integral operation.

Setting	Integral resetting	Current integral status	Integral interruption
Wiring	Executable	Unenforceable	Unenforceable
Measurement range	Executable	Unenforceable	Unenforceable
Filter	Executable	Unenforceable	Unenforceable
Averaging function	Executable	Unenforceable	Unenforceable
Synchronization	Executable	Unenforceable	Unenforceable
Data updating rate	Executable	Unenforceable	Unenforceable
Integral mode	Executable	Unenforceable	Unenforceable
Integral timer	Executable	Unenforceable	Unenforceable
Integral start	Executable	Unenforceable	Executable
Integral stop	Unenforceable	Executable	Unenforceable
Integral resetting	Executable	Unenforceable	Executable
Save operation	Executable	Executable	Executable
Hold operation	Executable	Executable	Executable
Single measurement operation	Executable	Executable	Executable

Table 7.3 Settings configurability per mode

NOTE: In addition to the above items, other settings (such as self-testing and date/time setting) or operations with influence on the integral cannot be executed; otherwise, errors may be caused.

7.3 Setting of Integral Measurement Configuration

You can set the start mode, stop mode, automatic zero setting, automatic calibration, watt-hour integration, current integration and other parameters of integral measurement. Specific steps are as follows:

1. Press "Integ" to enter the integral measurement interface.
2. Press the soft key corresponding to the "SETUP" parameter in the integral measurement interface to enter the integral parameter configuration interface.

7.3.1 Parameter descriptions

Start set in the MANUAL mode or TIME mode via the right soft key.

MANUAL press the "START" soft key in the integral measurement interface in the manual start mode to trigger the manual start of the integral function.

TIME the date on which the integral mode is started can be set in the real-time start mode. Integration will be started on the set date. When the time/date combination is set in the real-time start mode, integration will not be started before the current time and date. Integration will be started when the screen is updated once at least before the start time.

Stop set in the MANUAL mode, TIME mode and TINTERval mode via the right soft key.

MANUAL press the "STOP" soft key in the integral measurement interface in the manual stop mode to manually stop integration. When the integration time reaches the maximum integration time (10,000 hours) or the integral value reaches the maximum/minimum display value, integration will be stopped, and the current integral time and integral value will be kept.

TIME The date for stop of the integral mode can be set in the real-time stop mode. Integration will be stopped on the set date. When it reaches the set time or the integral value reaches the maximum/minimum display integral value, integration will be stopped, and the current integral time and integral value will be kept.

TINTERval the integral measurement time can be set in the set-time stop mode. When it reaches the set ending date and time or the integral value reaches the maximum/minimum display integral value, integration will be stopped, and the current integral time and integral value will be kept.

Auto Clear used for enabling (ON) or disabling (OFF) the function of automatic zero clearing of the integral. On: integration is restarted when the START button is pressed to start integration. OFF: integration is restarted based on the integral value at the end of previous integration when the START button is pressed to start integration.

Auto Cal used for enabling (ON) or disabling (OFF) the function of automatic integral calibration. When automatic integral calibration is enabled, zero setting is implemented. In this case, the power and current measured just now are subject to integration.

WP type used for selecting the integral mode for positive and negative watt hours. There are four integral modes:

Charge/Discharge used for measuring the DC positive and negative watt hours (integration of sampling data).

Sold/Bought used for measuring the AC positive and negative watt hours (value integration in each data updating cycle).

q type used for selecting the current integration mode. Options of the current integration mode are as follows:

rms Effective value;

mn Calibration to the average rectified value of the effective value.

dc Simple averaging;

rmn Average rectified value;

ac AC component

7.4 Integration

When the integral measurement function is enabled, you can keep the current integral information and carry out the following operations: exit, start and stop. Specific steps are as follows:

Operation steps

1. Press "Integ" to enter the integral display interface.
2. In the integral measurement display interface Press the soft key corresponding to the "START" parameter to start or recover integral operation. The Start status and integral operation value are displayed in the interface.
3. When you need to keep the current integral status and integral result, you can press the soft key corresponding to the "RUN HOLD" parameter. Then the current status of the integral result display and communication output will be kept no matter whether integral operation is running.
4. When you need to continue to implement integral operation, double-press the soft key corresponding to the "RUN HOLD" parameter to exit the HOLD status. The power meter will display the integral result after exiting the HOLD status. The schematic diagram of display of the HOLD/RUN integral result is shown below.
5. When you need to suspend integral operation, press the soft key corresponding to the "Stop" parameter to suspend integral operation.
6. Press the soft key corresponding to the "RESET" parameter to reset the integral value and integral time. The relationship diagram of start, suspension and resetting of the integral operation status is shown below.

Auto Clear when ON is selected.

Auto Clear when OFF is selected.

Remote Operation

There are four types of communication interfaces available: USB, Ethernet, and RS232. You can choose any one of them to communicate with a PC.

8.1 RS-232 Interface

RS232 interface: use a cable with two COM interface (DB9) to connect power meter and PC. It can be activated by menu key on the front panel. All SCPI commands are available through RS-232 programming.

- RS-232 data is a 10-bit word with one start bit and one stop bit. The number of start and stop bits is not programmable.
- Baudrate Available baudrate: 4800 9600 19200 38400 57600 115200
- RS-232 connection The RS-232 serial port can be connected to the serial port of a controller (i.e., personal computer) using a straight through RS-232 cable terminated with DB-9 connectors. Do not use a null modem cable. Table [tab:rs232pinout] shows the pinout for the connector.

If your computer uses a DB-25 connector for the RS-232 interface, you will need a cable or adapter with a DB-25 connector on one end and a DB-9 connector on the other, wired straight through (not null modem).

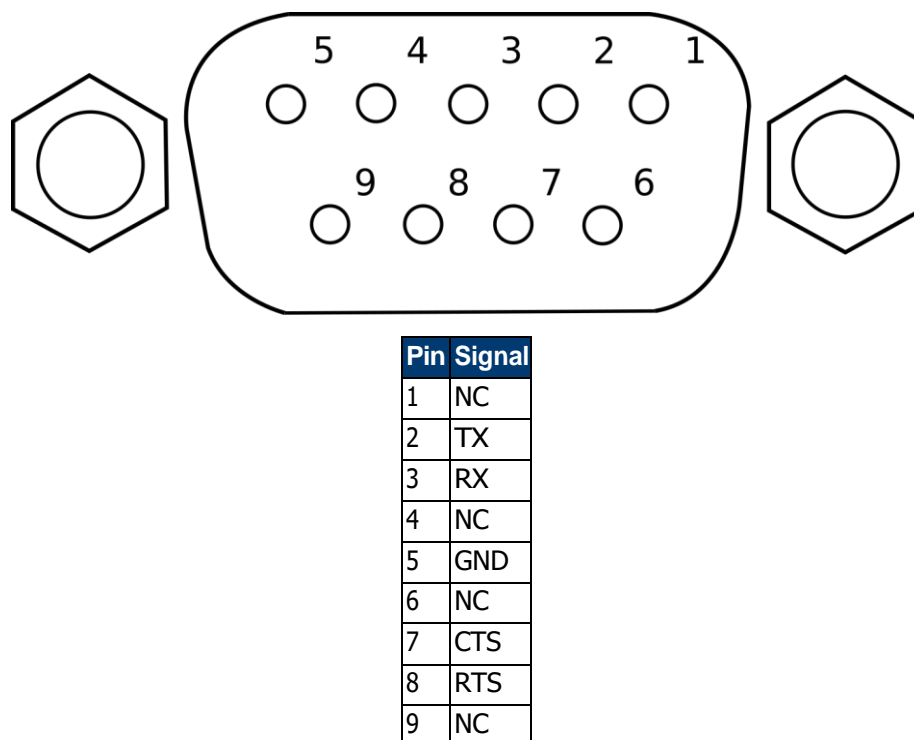

Figure 8.1 RS-232 DE-9 Connector

8.1.1 RS-232 troubleshooting

If you are having trouble communicating over the RS-232 interface, check the following: The computer and the power meter must be configured for the same baudrate, parity, number of data bits, and flow control options. Note that the electronic load is configured for 1 start bit and 1 stop bit (these values are fixed). The correct interface cables or adapters must be used, as described under RS-232 connector. Note that even if the cable has the proper connectors for your system, the internal wiring may be incorrect. The interface cable must be connected to the correct serial port on your computer (COM1, COM2, etc.).

8.1.2 RS-232 Communication settings

Before communication operation, please make sure that the following parameters of electronic load match that of PC.

Baud rate 9600(4800, 9600, 19200, 38400, 57600, 115200). You can enter system menu through panel to set communication baud rate.

Data bit 8

Stop bit 1

Parity (none, even, odd)

EVEN 8 data bits with even parity

ODD eight data bits with odd parity

NONE eight data bits without parity

Recommended settings Start Bit, 8 Data Bits, Parity=None, 1 Stop Bit

8.2 USB interface

Use Type A to Type B USB cables to connect the power meter.
The USB interface capabilities of the power meter are described below:

- The interface is IEEE488.2 standard USB488 interface
- The interface accepts REN_CONTROL, GO_TO_LOCAL , LOCAL_LOCKOUT request.
- The interface accepts MsgID = TRIGGER USBTMC command message and forwards TRIGGER requests to the function layer.

The USB488 device capabilities of the power meter are described below:

- The device understands all mandatory SCPI commands.
- The device is SR1 capable.
- The device is RL1 capable.
- The device is DT1 capable.

8.3 LAN interface

Use a network cable to connect PC through LAN interface of the power meter.

- IP mode:

MANU manually set IP address, subnet mask, default gateway, etc.

DHCP (Dynamic Host Configuration Protocol) Refers to a protocol that temporarily assigns necessary information to PCs connected to the Internet. If the network is provided with an available DHCP server, the server will automatically assign information (IP address, subnet mask and default gateway) to PCs and other equipment connected to the network. 5335C cannot

use DHCP unless the network is provided with a DHCP server. Please ask your network administrator DHCP if DHCP is available.

- IP Address: IP addresses assigned to 5335C can be set. Default address is 192.168.000.000.
- IP address refers to ID assigned by the network to each equipment (Internet or enterprise Intranet).
- IP address refers to four 32-bit values within 0 - 255 which are separated by decimal points, such as [192.168.111.24].
- Please ask the network administrator to provide an IP address.
- Use DHCP network to automatically set the IP address.
- Subnet masksetting: The mask used when subnet website is determined from an IP address may be set. Default address is 255.255.255.255.
- Vast TCP/IP networks like Internet are often divided into several small networks, i.e. subnets. The subnet mask is used to identify how many digits of the 32-digit values in the IP address belong to the subnet address. The part beyond the network address is used to identify the host number of each PC connected to the network.
- Ask your network administrator about values of subnet mask.
- Use DHCP network to automatically set the subnet mask.
- Gatewaysetting: IP address of gateway may be set to communicate with equipment in other network (default gateway). Default address is 192.168.000.000.
- The default gateway controls data exchange between networks and protocols to ensure smooth data transmission.
- Ask your network administrator about values of default gateway. It is possible that the setting is unnecessary. Use DHCP network to automatically set the default gateway.

Specifications

The specifications listed below are valid and specified for the following conditions:

- Warm up time of 30 minutes
- Ambient temperature - $23 \pm 5^\circ$
- Relative humidity 30 to 75%

Specifications

Specifications are subject to the following conditions
 Temperature: 23±5° C, humidity: 30 to 75% RH.
 Warm-up time: 30 minutes

Model		5335C	
General Measurement Specifications			
Basic measurements	Voltage, Current	Peak to peak, Maximum, Minimum, Average_rms, Average_rectified, DC, Crest factor (current), Inrush (current)	
	Power	Real, Apparent, Reactive, DC, Power factor	
	Time	Frequency, Phase	
	Integration	Total power, Total current, Maximum power, Minimum power	
Harmonic measurements	Type	Current, Voltage, Real power, Apparent power, Reactive power, Power factor, Phase, Percentage of total (Current, Voltage, Power)	
	Range	DC up to 50 th order	
	Max. Frequency	100 kHz	
Input bandwidth	DC, 0.5 Hz to 100 kHz		
Measurement method	Digital sampling		
A/D Converter	Simultaneous conversion of voltage and current inputs, Resolution: 18-bit, Maximum conversion rate: 10 μ s		
Line filter	Select OFF or ON (cutoff frequency at 500 Hz)		
Peak (max,min)	Voltage, current, or power		
Input voltage continuous max.	1.5 kV-peak or 1 kV-RMS, whichever is less		
Input voltage transient (<1s) max.	2 kV-peak or 1.5 kV-RMS, whichever is less		
Input voltage common-mode max.	600 Vrms		
Voltage input impedance	2 M Ω + 13 pF in parallel (typical)		
Current input impedance (typical)	5 mA to 200 mA range	505 m Ω + 0.1 μ H	
	0.5 A to 20 A range	5 m Ω + 0.1 μ H	
	Sensor input	20 k Ω (50 mV to 2 V) 100 k Ω (2.5 V to 10 V)	
Input current continuous max.	5 mA to 200 mA range	30 A-peak or 20 A-RMS, whichever is less	
	0.5 A to 20 A range	100 A-peak or 30 A-RMS, whichever is less	
	Sensor input	Peak value less than or equal to 5 times the rated range	
Input current transient (<1s) max.	5 mA to 200 mA range	30 A-peak or 20 A-RMS, whichever is less	
	0.5 A to 20 A range	150 A-peak or 40 A-RMS, whichever is less	
	Sensor input	Peak value less than or equal to 10 times the rated range	
Voltage Measurement Accuracy and Ranges			
Ranges	CF=3: 15 V, 30 V, 60 V, 150 V, 300 V, 600 V CF=6: 7.5 V, 15 V, 30 V, 75 V, 150 V, 300 V		
Accuracy ² (line, frequency, & digital filter set to off)	DC to 1 kHz	$\pm(0.1\% + 0.2\% \text{ F.S.})$	
	1 kHz < f \leq 10 kHz	$\pm((0.07 f^1)\% + 0.3\% \text{ F.S.})$	
	10 kHz < f \leq 100 kHz	$\pm(0.5\% + 0.5\% \text{ F.S.}) \pm [(0.04 \times (f^1 - 10))\%]$	
Temperature coefficient	For temperature changes after zero-level compensation or range change	+ 0.02% F.S. /C to the DC voltage accuracy	
	Influence of self-generated heat caused by voltage input (U is the voltage reading (V))	+ 0.0000001 \times U ² % to the AC voltage accuracy + 0.0000001 \times U ² % + 0.0000001 \times U ² % F.S. to DC current accuracy	

¹ Input signal frequency in kHz

² Input waveform: Sine wave crest factor: 3, common-mode voltage: 0 V, power factor: 1
 Frequency filter: Turn on when measuring \leq 200 Hz

Power Meter
5335C

m

Specifications (cont.)

Current Measurement Accuracy and Ranges							
Direct input range		CF= 3: 3 mA, 10 mA, 20 mA, 50 mA, 100 mA, 200 mA, 0.5 A, 1 A, 2 A, 5 A, 10 A, 20 A					
		CF= 6: 2.5 mA, 5 mA, 10 mA, 25 mA, 50 mA, 100 mA, 250 mA, 0.5 A, 1 A, 2.5 A, 5 A, 10 A					
Sensor input range	External 1	CF= 3: 2.5 V, 5 V, 10 V CF= 6: 1.25 V, 2.5 V, 5 V					
	External 2	CF= 3: 50 mV, 100 mV, 200 mV, 500 mV, 1 V, 2 V CF= 6: 25 mV, 50 mV, 100 mV, 250 mV, 500 mV, 1 V					
Accuracy ² (line, frequency, & digital filter set to off)	DC to 1 kHz	$\pm(0.1\% + 0.2\% \text{ F.S.})$					
	1 kHz < f ≤ 10 kHz	$\pm\{(0.07 f^1)\% + 0.3\% \text{ F.S.}\}$					
	10 kHz < f ≤ 100 kHz	$\pm(0.5\% + 0.5\% \text{ F.S.}) \pm \{0.04 \times (f^1 - 10)\}\%$					
Temperature coefficient	2.5 to 200 mA	5 $\mu\text{A}/^\circ\text{C}$ (after zero-level compensation, or range change)					
	500 mA to 20 A	500 $\mu\text{A}/^\circ\text{C}$ (after zero-level compensation, or range change)					
	Influence of internal sensor self-heating	+ 0.00013 × I ² % of reading to the AC current accuracies + 0.00013 × I ² % of reading + 0.004 × I ² mA (0.5 to 20 A) or 0.00013 × I ² % of reading + 0.00004 × I ² mA (2.5 to 200 mA), add to the DC current accuracy specifications					
Power Measurement Accuracy							
Real power accuracy ^{2,3} (CF= 3) ⁴	DC	$\pm(0.1\% + 0.2\% \text{ F.S.})$					
	0.5 Hz ≤ f < 45 Hz	$\pm(0.3\% + 0.2\% \text{ F.S.})$					
	45 Hz ≤ f ≤ 66 Hz	$\pm(0.1\% + 0.1\% \text{ F.S.})$					
	66 Hz < f ≤ 1 kHz	$\pm(0.2\% + 0.2\% \text{ F.S.})$					
	1 kHz < f ≤ 10 kHz	$\pm(0.1\% + 0.3\% \text{ F.S.}) \pm \{0.067 \times (f-1)\}\%$					
	10 kHz < f ≤ 100 kHz	$\pm(0.5\% + 0.5\% \text{ F.S.}) \pm \{0.09 \times (f-10)\}\%$					
Apparent power (S)	Voltage accuracy + current accuracy						
Reactive power (Q)	Apparent power accuracy + $(\sqrt{1.0004 - \text{PF}^2}) - (\sqrt{1 - \text{PF}^2}) \times 100\%$						
Power factor (PF)	$\pm\{(\text{PF} - \text{PF}/1.0002) + \text{abs}(\cos\emptyset - \cos\{\emptyset + \sin^{-1}(\text{influence from the power factor when PF}=0\%/100)\})\} \pm 1 \text{ digit}$ when voltage and current are at the measurement range rated input						
Phase angle (Φ)	$\pm\{\text{abs}(\emptyset - \cos^{-1}(\text{PF}/1.0002)) + \sin^{-1}\{(\text{influence from the power factor when PF}=0\%/100)\}\} \text{ deg} \pm 1 \text{ digit}$ when voltage and current are at the measurement range rated input						
Temperature coefficient	Same as the temperature coefficient for voltage and current						
Frequency Measurement Accuracy							
Frequency measurement range	Data update interval	0.1 s	0.25 s	0.5 s	1 s	2 s	5 s
	Measurement range	25 Hz ≤ f ≤ 100 kHz	10 Hz ≤ f ≤ 100 kHz	5 Hz ≤ f ≤ 100 kHz	2.5 Hz ≤ f ≤ 100 kHz	1.5 Hz ≤ f ≤ 50 kHz	0.5 Hz ≤ f ≤ 20 kHz
Accuracy	$\pm 0.06\%$			(CF 3 and signal < 30% F.S.) or, (CF 6 and signal < 60% F.S.), and ≤ 200 Hz with frequency filter on			
Frequency filter	500 Hz low-pass						

¹ Input signal frequency in kHz

² Input waveform: Sine wave crest factor: 3, common-mode voltage: 0 V, power factor: 1
Frequency filter: Turn on when measuring ≤ 200 Hz

³ When power factor (PF)=0 (apparent power (S)):

$\pm 0.2\%$ of S when 45 Hz ≤ f ≤ 66 Hz
 $\pm\{(0.2+0.2 \times f)\%$ of S when 0.066 ≤ f ≤ 100 kHz

When 0 < PF < 1 (phase angle (Φ)):

(power reading) × [(power reading error %) + (power range %) × (power range/indicated apparent power value) + {tanΦ × (influence when PF=0)}]

When the line filter is turned ON:

45 to 66 Hz: Add 0.3% of reading
< 45 Hz: Add 1% of reading

⁴ Accuracy when the crest factor is set to 6, the accuracy is obtained by doubling specified accuracies

Power Meter
5335C

om

Specifications (cont.)

Harmonic Measurement Parameters					
Measurement method	PLL synchronization				
Frequency range	PLL frequency source range 10 Hz to 1.2 kHz (typical)				
FFT data length	1024				
Window function	Rectangle				
Fundamental frequency (Fund. freq.)	10 Hz to 75 Hz	75 Hz to 150 Hz	150 Hz to 300 Hz	300 Hz to 600 Hz	600 Hz to 1200 Hz
Sample rate	(Fund. freq.) x 1024	(Fund. freq.) x 512	(Fund. freq.) x 256	(Fund. freq.) x 128	(Fund. freq.) x 64
Window width	1	2	4	8	16
Upper limit of analysis orders	50	32	16	8	4
Harmonic Measurement Accuracy (when line filter is off)					
Frequency	10 Hz ≤ f < 45 Hz	45 Hz ≤ f ≤ 440 Hz	440 Hz < f ≤ 1 kHz	1 kHz < f ≤ 2.5 kHz	2.5 kHz < f ≤ 5 kHz
Voltage and current	±0.15% ± 0.35% F.S.	±0.15% ± 0.35% F.S.	±0.20% ± 0.35% F.S.	±0.80% ± 0.45% F.S.	3.05% ± 0.45% F.S.
Power	±0.15% ± 0.50% F.S.	±0.20% ± 0.50% F.S.	±0.40% ± 0.50% F.S.	1.56% ± 0.60% F.S.	5.77% ± 0.60% F.S.
Oscilloscope Function					
Channels	2				
Measurement	Voltage and current				
Bandwidth (-3 dB)	10 kHz				
Sample rate	100 kS/s				
Record length	300 points/channel				
Horizontal scale (Accuracy ±4.0%)	500 us, 1 ms, 2 ms, 5 ms, 10 ms, 20 ms, 50 ms, 100 ms, 200 ms, 500 ms				
Vertical scale ranges (Accuracy ±4.0%)	CF 3	I: 2.5, 5, 10, 25, 50, 100, 250, 500 mA/div, 1 A, 2.5 A, 5 A, 10 A/div, U: 7.5, 15, 30, 75, 150, 300 V/div			
	CF 6	I: 5, 10, 20, 50, 100, 200, 500 mA/div, 1 A, 2 A, 5 A, 10 A, 20 A/div, U: 15, 30, 60, 150, 300, 600 V/div			
Maximum input voltage (DC+AC peak)	1800 V				
Maximum input current (DC+AC peak)	60 A				
Environmental and Safety					
Temperature	Operating: 41 °F to 104 °F (5 °C to 40 °C) Storage: -4 °F to 122 °F (-20 °C to 50 °C)				
Humidity	20% RH to 80% RH (non-condensing)				
Electromagnetic compatibility	IEC 61326				
Safety	IEC 61010-1, EN 61010-1, Measurement 600 V CAT II				
General					
Display	4.3" TFT-LCD display, 480 x 272				
Remote Interfaces	USB, RS232, LAN				
Power	100 to 240 VAC, 50 / 60 Hz				
Power Consumption	50 VA max.				
Dimensions (W x H x D)	8.4" x 3.5" x 14" (214.5 mm x 88.2 mm x 354.6 mm)				
Weight	6.2 lbs (2.8 kg)				
Three-Year Warranty					
Standard Accessories	Getting started manual, instruction manual (downloadable), AC power cord, USB type A-to-type B cable, certificate of calibration				

Power Meter
5335C

om

Routine Maintenance

This chapter describes general maintenance items and maintenance methods of the 5335C power meter.

10.1 Self-inspection

The 5335C power meter has a self-inspection function. See "Power-on Self-Test" of Chapter 3 "Inspecting the Instrument" of 5335C Installation Instructions for detailed steps of self-inspection.

10.2 Error Information References

The 5335C power meter has a detailed error and prompt information function, so as to help the user to easily carry out positioning and measurement during measurement and use. This section describes all error information of the 5335C power meter as well as error causes and disposals. All prompt information is listed.

10.2.1 Prompt Message List

	Explanation of prompt information
Cal Zero is working!	The instrument is calibrating the zero point.
Cal Zero is completed!	The instrument has completed zero point calibration.
Test screen	Self-inspection of LCD screen
Test dsp	Self-inspection of DSP.
Test beep	Self-inspection of the buzzer.
SelfTest is finished!	The instrument has finished the self-test.
Softkey is not available	The current soft key is not available.
Time set ok!	The time setting is completed.
Meter Initialization	Initialization of general measurement
Integ Initialization	Initialization of integral function
Scope Initialization	Initialization of the oscilloscope function
Harmonic Initialization	Initialization of the harmonic function
Inrush Initialization	Initialization of the inrush function
Setup Initialization	Initialization of setup
System Initialization	Initialization of the system
Initialization is finished!	Initialization is finished.
Integ start	Integration is started.
Integ stop	Integration is stopped.
Integ time up	The integral time is up.
Max page has been reached.	It displays The maximum page has been reached.
One page should exist at least	One page should exist at least.
Not used in current state	The current operation is not available.
Please reset first	Please reset first.

Table 10.1

10.2.2 Error information list

	Error information explanation
usb is not detected	<p>Error description No USB peripheral is found.</p> <p>Possible cause No USB peripheral is inserted.</p> <p>Disposal Insert the U disc type USB peripheral and then copy the screen.</p>
Save screen fail	<p>Error description The screen is not saved successfully.</p> <p>Possible cause USB is disconnected.</p> <p>Disposal Reinsert the USB peripheral.</p>
Start time is less than current	<p>Error description The start time is less than the current time.</p> <p>Possible cause The integral setting is incorrect.</p> <p>Disposal Reset the integral start time.</p>
End time is less than current	<p>Error description The ending time is less than the current time.</p> <p>Possible cause The integral setting is incorrect.</p> <p>Disposal Reset the integral ending time.</p>
Timer must be larger than zero.	<p>Error description The set time must be larger than zero.</p> <p>Possible cause The set integral time is not correct.</p> <p>Disposal Reset the set integral time.</p>
Harmonic open fail	<p>Error description The harmonic function cannot be enabled.</p> <p>Possible cause Communication abnormality</p> <p>Disposal Check the communication cable.</p>
Integ open fail	<p>Error description The integral function cannot be enabled.</p> <p>Possible cause Communication abnormality</p> <p>Disposal Check the communication cable.</p>
Integ start fail	<p>Error description The integral function cannot be started.</p> <p>Possible cause Communication abnormality</p> <p>Disposal Check the communication cable.</p>
Integ stop fail	<p>Error description The integral function cannot be stopped.</p> <p>Possible cause Communication abnormality</p> <p>Disposal Check the communication cable.</p>
Scope openfail	<p>Error description The oscilloscope function cannot be enabled.</p> <p>Possible cause Communication abnormality</p> <p>Disposal Check the communication cable.</p>
Time set fail	<p>Error description Time setting fails.</p> <p>Possible cause Time setting is illegal.</p> <p>Disposal Reset the system time.</p>

Cal zero fail	<p>Error description Zero calibration fails.</p> <p>Possible cause Communication abnormality</p> <p>Disposal Check the communication cable.</p>
---------------	--

10.3 Daily maintenance

Introduce basic maintenance in daily use of equipment. Such as cleaning, self-maintenance allowed to be performed by the user, etc.

10.3.1 Equipment cleaning

Use dry cloth or slightly wet cloth to gently wipe the equipment. Do not arbitrarily wipe the inside of the instrument. Cut off the power supply before cleaning.

10.3.2 Initialize

When this operation is implemented, the system settings are recovered to the factory default values.

1. Select "SYSTEM > INITIAL" in the "Menu" interface to enter the system initialization interface. See the following figure.
2. Select the menu items to be initialized (blue symbol background) via button. Menu items with characters ## following should be initialized; ## indicates that the items will not be initialized.
3. Press the soft key corresponding to the symbol on the right of the interface to determine whether to initialize this menu item. Or use the soft key "" (for initialization of all menu items) or "" (no initialization for all menu items) in the lower part of the interface.
4. Press the "START" soft key to initialize system settings. Press the ESC to exit.

10.4 Troubleshooting

This section describes operations to be carried out by the user in case of failure of the instrument. Preparation before contact

When the instrument fails, check the following:

- Check whether the power meter is powered up.
- Check whether the power meter is started normally.
- Check whether the instrument fuse is in good conditions.
- Check whether other connectors are in good conditions and whether cables, plugs and other parts are connected properly.
- Check whether the system configuration of the instrument is correct during use.
- Check whether self-inspection of the instrument is successful and whether the specifications and performance are within the indicator ranges.
- Check whether the instrument displays error information.
- Use other instruments instead of this instrument for confirmation.

Service Information

Warranty Service: Please go to the support and service section on our website at bkprecision.com to obtain an RMA #. Return the product in the original packaging with proof of purchase to the address below. Clearly state on the RMA the performance problem and return any leads, probes, connectors and accessories that you are using with the device.

Non-Warranty Service: Please go to the support and service section on our website at bkprecision.com to obtain an RMA #. Return the product in the original packaging to the address below. Clearly state on the RMA the performance problem and return any leads, probes, connectors and accessories that you are using with the device. Customers not on an open account must include payment in the form of a money order or credit card. For the most current repair charges please refer to the service and support section on our website.

Return all merchandise to B&K Precision Corp. with prepaid shipping. The flat-rate repair charge for Non-Warranty Service does not include return shipping. Return shipping to locations in North America is included for Warranty Service. For overnight shipments and non-North American shipping fees please contact B&K Precision Corp.

Include with the returned instrument your complete return shipping address, contact name, phone number and description of problem.

Version: September 26, 2022