

FLUKE®

53 & 54 Series II

Thermometer

Test Equipment Depot - 800.517.8431 - 99 Washington Street Melrose, MA 02176 - TestEquipmentDepot.com

Users Manual

September 1999 Rev.1, 6/01

© 1999-2001 Fluke Corporation, All rights reserved. Printed in USA
All product names are trademarks of their respective companies.

Limited Warranty & Limitation Of Liability

This Fluke product will be free from defects in material and workmanship for 3 years from the date of purchase. This warranty does not cover fuses, disposable batteries or damage from accident, neglect, misuse or abnormal conditions of operation or handling. Resellers are not authorized to extend any other warranty on Fluke's behalf. To obtain service during the warranty period, send your defective tester to the nearest Fluke Authorized Service Center with a description of the problem.

THIS WARRANTY IS YOUR ONLY REMEDY. NO OTHER WARRANTIES, SUCH AS FITNESS FOR A PARTICULAR PURPOSE, ARE EXPRESSED OR IMPLIED. FLUKE IS NOT LIABLE FOR ANY SPECIAL, INDIRECT, INCIDENTAL OR CONSEQUENTIAL DAMAGES OR LOSSES, ARISING FROM ANY CAUSE OR THEORY. Since some states or countries do not allow the exclusion or limitation of an implied warranty or of incidental or consequential damages, this limitation of liability may not apply to you.

Table of Contents

Title	Page
Safety Information.....	1
Contacting Fluke	1
Getting Started.....	4
Components.....	5
Display Elements	6
Buttons.....	7
Using the Thermometer	9
Changing Setup Options.....	9
Entering and Exiting Setup.....	9
Changing the Logging Interval	10
Changing the Thermocouple Type.....	11
Changing the Offset	11
Enabling or Disabling Sleep Mode	12
Setting the Time.....	12
Changing the Line Frequency	13
Measuring Temperatures.....	13
Connecting a Thermocouple	13

Displaying Temperatures.....	14
Holding the Displayed Temperatures	14
Viewing the MIN, MAX, and AVG Readings	14
Using the Offset to Adjust for Probe Errors	15
Using Memory	15
Initial Conditions and Data Entries.....	16
Starting and Stopping Logging	16
Clearing Memory	17
Viewing Logged Readings.....	17
Communicating with a PC	18
Maintenance.....	19
Replacing the Batteries	19
Cleaning the Case and Holster.....	19
Calibration	19
Specifications	19
Environmental.....	19
General.....	20
80 PK-1 Thermocouple (supplied with thermometer)	20
Electrical.....	20
Replacement Parts and Accessories.....	21

53 & 54 Series II

Safety Information

The Fluke Model 53 and Model 54 Thermometers (“the thermometer”) are microprocessor-based, digital thermometers designed to use external J-, K-, T-, E-, R-, S-, and N-type thermocouples (temperature probes) as temperature sensors.

Use the thermometer only as specified in this manual. Otherwise, the protection provided by the meter may be impaired.

Refer to safety information in Table 1 and the meter symbols in Table 2.

Table 1. Safety Information

⚠ Warning

A Warning identifies conditions and actions that pose hazards to the user. To avoid electrical shock or personal injury, follow these guidelines:

- **Before using the thermometer inspect the case. Do not use the thermometer if it appears damaged. Look for cracks or missing plastic. Pay particular attention to the insulation around the connectors.**
- **Disconnect the thermocouple(s) from the thermometer before opening the case.**
- **Replace the batteries as soon as the battery indicator (🔋) appears. The possibility of false readings can lead to personal injury.**
- **Do not use the thermometer if it operates abnormally. Protection may be impaired. When in doubt, have the thermometer serviced.**
- **Do not operate the thermometer around explosive gas, vapor, or dust.**
- **Do not apply more than the rated voltage, as marked on the thermometer, between the thermocouple(s), or between any thermocouple and earth ground.**

Table 1. Safety Information (cont.)

⚠ Warning (cont.)





- **Model 54: Measurement errors may occur if voltages on the measurement surfaces result in potentials greater than 1 V between the two thermocouples. When potential differences are anticipated between the thermocouples, use electrically insulated thermocouples.**
- **When servicing the thermometer, use only specified replacement parts.**
- **Do not use the thermometer with any part of the case or cover removed.**

Caution

A Caution identifies conditions and actions that may damage the meter or the equipment under test.

- **Use the proper thermocouples, function, and range for your thermometer.**
- **Do not attempt to recharge the batteries.**
- **To prevent explosion, do not throw batteries into a fire.**
- **Follow local laws or regulations when disposing of batteries.**
- **Match the + and – polarities of the battery with the battery case.**

Table 2. International Symbols

	Refer to the manual for information about this feature.		Complies with European Union directives.
	Battery.		Complies with relevant Canadian Standards Association directives.

Getting Started

Everything in this *Users Manual* applies both to Models 53 and 54 unless otherwise indicated.

To become familiar with the thermometer, study the following:

- Figure 1 and Table 3 describe the components.
- Figure 2 and Table 4 describe the display.
- Table 5 describes the functions of the buttons.

Then read the following sections.

Components

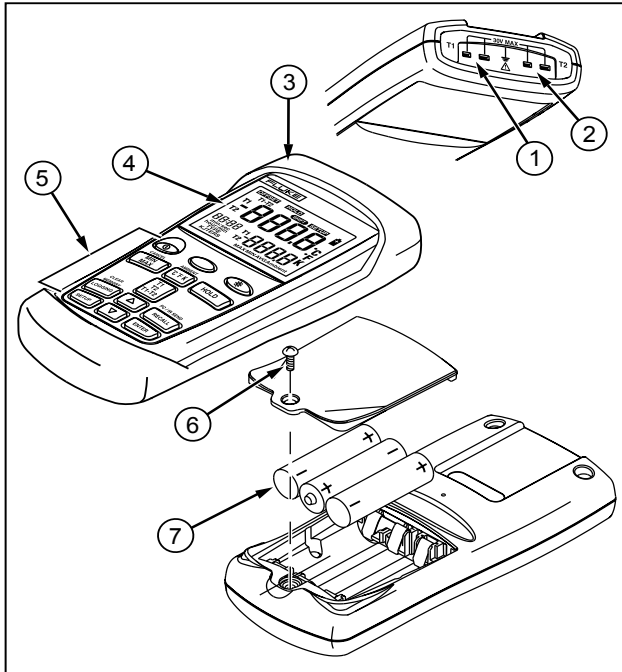

aat01f.eps

Figure 1. Components

Table 3. Components

①	Thermocouple T1 input
②	<i>Model 54:</i> Thermocouple T2 input
③	Holster
④	Display
⑤	Buttons
⑥	Battery door
⑦	Batteries

Display Elements

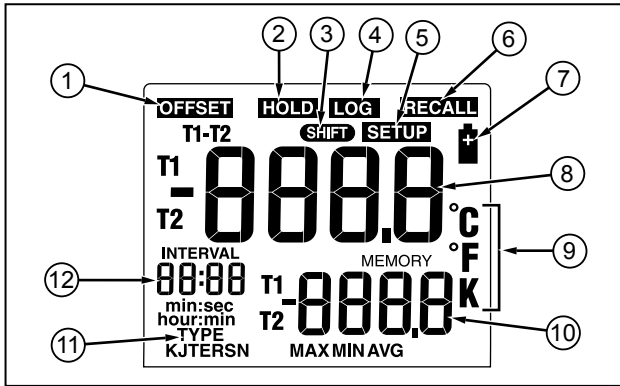

Figure 2. Display Elements

aat02f.eps

Table 4. Display Elements

①	The thermocouple measurement includes an offset. See "Changing Setup Options."
②	The displayed readings do not change.
③	A shift function is in progress.
④	Readings are being logged.
⑤	Setup is in progress.
⑥	Logged readings are displayed.
⑦	Low battery. Replace the batteries.
⑧	Primary Display. <i>Model 53</i> : T1 reading. <i>Model 54</i> : T1, T2, or T1-T2 reading.
⑨	The temperature units.
⑩	Secondary Display: MAX, MIN, AVG, MEMORY, or offset. <i>Model 54</i> : T1 or T2 reading.
⑪	The thermocouple type.
⑫	Time Display: 24-hour clock. Shows the INTERVAL length in SETUP. Shows elapsed time when AVG is on or before clock has been set.

Buttons

Table 5. Buttons









































	<p>Press  to turn the thermometer on or off.</p>
<p> (Shift function)</p>	<p>Press ,  (CANCEL) to stop displaying the minimum, maximum, and average readings in the secondary display.</p> <p>Press ,  (CLEAR MEMORY) to delete logged readings from memory.</p> <p>Press ,  (PC/IR SEND) to toggle the IR port on and off.</p>
	<p>Press  to turn the backlight on and off. The backlight turns off after 2 minutes without any button presses. If the battery is low, the backlight is disabled.</p>
	<p>Press  to step through the maximum, minimum, and average readings.</p> <p>When viewing logged readings, shows the maximum, minimum, and average of the logged readings.</p> <p>Press ,  (CANCEL) to turn off this display.</p>
	<p>Press  to switch between Celsius (°C), Fahrenheit (°F), and Kelvin (K).</p>

Table 5. Buttons (cont.)

	<p>Press  to freeze or unfreeze the displayed readings.</p> <p>Press  when turning on the thermometer to test the display. All display elements appear.</p>
	<p><i>Model 54:</i> Press  to toggle showing the T1, T2, and T1-T2 (differential temperature measurement) in the primary or secondary display.</p>
	<p>Press  to start or exit Setup. (See "Changing Setup Options.")</p>
	<p>Press  to scroll to the Setup option you want to change.</p> <p>Press  to increase the displayed setting.</p>
	<p>Press  to scroll to the Setup option you want to change.</p> <p>Press  to decrease the displayed setting.</p>
	<p>Press  to enter a Setup option.</p> <p>Press  again to store the displayed setting in memory.</p>
	<p>Press  to start or stop logging.</p> <p>During manual logging, the thermometer stores a single set of logged readings in memory each time you press .</p>
	<p>Press  to show logged readings and MIN MAX readings on the display.</p> <p>Press  again to stop.</p>

Using the Thermometer

1. Plug the thermocouple(s) into the input connector(s).
2. Press  to turn on the thermometer.

After 1 second the thermometer displays the first reading. If no thermocouple is plugged into the selected input or the thermocouple is "open," the display shows "----."

Changing Setup Options

Use Setup to change the logging interval, thermocouple type, offset, sleep mode, time, and line frequency settings.



The thermometer stores the settings in its memory. Setup settings reset only when the batteries are removed for more than 2 minutes.

Entering and Exiting Setup

When the thermometer is in Setup mode, the display shows **SETUP**.

- Press  to start or exit Setup.

Notes

Press  or  to scroll to the setup option you want to change.

Setup is disabled in MIN MAX mode.

Changing the Logging Interval

The logging interval determines how often the thermometer stores logged readings in memory. You choose the length of the logging interval. See "Using Memory."

The thermometer stores logged readings at the end of each logging interval. You can select a logging interval of 1 second (**1**), 10 seconds (**2**), 1 minute (**3**), 10 minutes (**4**), or user-defined (**USER**).

You can also set the logging interval manually (**0**). Each time you press **LOGGING**, the thermometer stores the current readings in memory.

1. Press **▲** or **▼** until the display shows **INTERVAL**.
2. Press **ENTER** to display the logging interval choices.
3. Press **▲** or **▼** until the display shows the logging interval you want, and then press **ENTER** to select.

4. If you selected a user-defined logging interval:

- Press **▲** or **▼** until the display shows **hour:min** or **min:sec**, and then press **ENTER** to select.

The left two digits blink.

- Press **▲** or **▼** until the left two digits you want appear on the display, and then press **ENTER** to select them.

The right two digits blink.

- Press **▲** or **▼** until the right two digits you want appear on the display, and then press **ENTER** to select them.

Holding down **▲** or **▼** causes the number to change more quickly.

Changing the Thermocouple Type

1. Press or until the display shows **TYPE**.
2. Press to display the thermocouple type choices.

The currently selected thermocouple blinks.
3. Press or until the thermocouple you want appears on the display.
4. Press to store the thermocouple type in memory.

Changing the Offset

You can adjust the thermometer's readings to compensate for the errors of a specific thermocouple. See "Using the Offset to Adjust for Probe Errors." The allowable adjustment range is ± 5.0 °C or K, and ± 9.0 °F.

Model 54: You can store individual offsets for T1 and T2.

1. Press or until the display shows **OFFSET** and **T1** or **T2**.
2. Press to indicate that you want to change the offset setting.

The temperature measurement plus the offset appears in the primary display. The offset appears in the secondary display.
3. Press or until the primary display shows the correct reading.
4. Press to store the offset setting in memory.

Remember to reset the offset to 0.0 when it is no longer needed. The offset automatically resets to 0.0 when you change the thermocouple type.

Enabling or Disabling Sleep Mode

The thermometer enters sleep mode if no button press occurs for 20 minutes.

Pressing any button wakes the thermometer and returns it to its previous state.

1. Press or until the display shows **SLEEP**.
2. Press to indicate that you want to change the sleep setting.

The display shows **ON** if sleep mode is on and **OFF** if sleep mode is off.

3. Press or as needed until the display shows **ON** or **OFF**.
4. Press to store the sleep setting in memory.

Sleep mode is enabled each time you turn on the thermometer and is automatically disabled in MIN MAX and logging modes.

Setting the Time

1. Press or until the display shows the time if it is set or shows "-- : --."

2. Press to indicate you want to set the time.

The left two digits blink.

3. Press or until the display shows the correct hour (24-hour format), and then press to select.

The right two digits blink.







4. Press or until the display shows the correct minutes, and then press to store the time in memory.

Note

Holding down or causes the number to change more quickly.

Changing the Line Frequency

For optimum rejection of line noise, set the thermometer for the local line frequency as follows:

1. Press  or  until the display shows L_{LINE} .
2. Press  to indicate that you want to change the line setting.
3. Press  or  as needed until the display shows 50 H or 60 H (50 Hz or 60 Hz).
4. Press  to store the line setting in memory.

Measuring Temperatures

Connecting a Thermocouple

Thermocouples are color coded by type based on the North American ANSI Color Code:

Type	Color	Type	Color
J	Black	R	Green
K	Yellow	S	Green
T	Blue	N	Orange
E	Purple		

1. Plug a thermocouple into the input connector(s).
2. Set the thermometer for the correct thermocouple type.

To change the thermocouple type, see “Changing Setup Options.”

Displaying Temperatures

1. Press  to select the correct temperature scale.
2. Hold or attach the thermocouple(s) to the measurement location.

The temperature reading appears in the selected display.

3. *Model 54:* Press  to toggle between showing the T1, T2, and T1-T2 reading in the primary or secondary display.

Notes

The display shows "- - -" when a thermocouple is not connected.



The display shows  (overload) when the temperature being measured is outside the thermocouple's valid range.

Model 54: If only thermocouple T2 is connected, the T2 reading appears in the primary display.

Holding the Displayed Temperatures

1. Press  to freeze the readings on the display.

The display shows **HOLD**.

2. *Model 54:* Press  to toggle showing the T1, T2, or T1-T2 readings in the primary or secondary display.
3. Press  again to turn off the HOLD function.

Viewing the MIN, MAX, and AVG Readings

1. Press  to step through the maximum (MAX), minimum (MIN), or the average (AVG) readings.

The elapsed time since entering MIN MAX mode, or the time at which the minimum or maximum occurred, appears on the display.

2. Press ,  (CANCEL) to exit MIN MAX mode.

Using the Offset to Adjust for Probe Errors

Use the offset option in Setup to adjust the thermometer's readings to compensate for the errors of a specific thermocouple.

1. Plug the thermocouple into the input connector.
2. Place the thermocouple in a known, stable temperature environment (such as an ice bath or a dry well calibrator).
3. Allow the readings to stabilize.
4. In Setup change the offset until the primary display reading matches the calibration temperature. (See "Changing Setup Options.")

Using Memory

During a logging session the thermometer stores logged readings in its memory.

At the end of the logging session you can view the logged readings on the display.

You can also transfer the logged readings to a PC running *FlukeView Forms* software. (See "Communicating with a PC.")

FlukeView Forms displays the logged readings on an online form, which you can print or store for later use.

Initial Conditions and Data Entries

Logged readings include *initial conditions* and *data entries*.

The initial conditions are the thermocouple type and the offsets for each thermocouple input. You can only view initial conditions using *FlukeView Forms*.

The data entries are a time stamp, the T1 reading, and the T2 and T1-T2 readings (*Model 54*). You can view these values by pressing  or using *FlukeView Forms*. Temperature readings display 0.1 degree resolution in *FlukeView Forms*.

The thermometer has 500 memory locations. The thermometer stores 499 sets of temperature readings and one set of initial conditions when logging continuously. It stores 250 sets of temperature readings and 250 sets of initial conditions when logging individual points manually.

Starting and Stopping Logging

Setup, memory clear, and PC communications are inaccessible during logging.

1. Set the logging interval. (See “Changing Setup Options.”)

2. Press  to start logging.



The display shows **LOG**.

3. Press  again to stop logging.

4. If you selected a manual logging interval, press  each time you want to store logged readings in memory.

Clearing Memory

When memory is full, Full appears on the display and logging stops. You can clear memory in normal or MIN MAX mode.

- Press ,  (CLEAR MEMORY) to delete logged readings from memory.

The display shows the following for 2 seconds.





MEMORY
[] r

Viewing Logged Readings

1. Press  to view logged readings.

The display shows **RECALL**.

2. Press  or  to scroll through the logged readings.

The display shows each logged reading, its time stamp, and its memory location. For example, Figure 3 shows the logged reading stored at 2:02 PM in memory location 18.

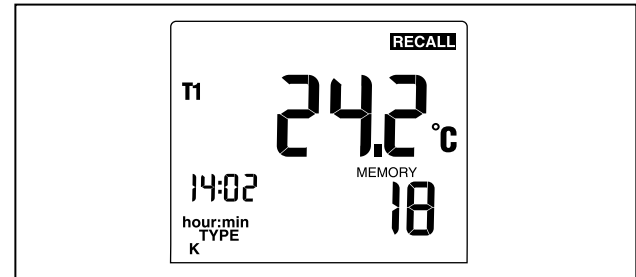

aat03f.eps

Figure 3. Logged Reading

- Press **MIN MAX** to step through the minimum, maximum, average, and current logged reading. For example, Figure 4 shows the maximum reading in memory. The maximum reading occurred at 1:49 P.M. and was stored in memory location 5.

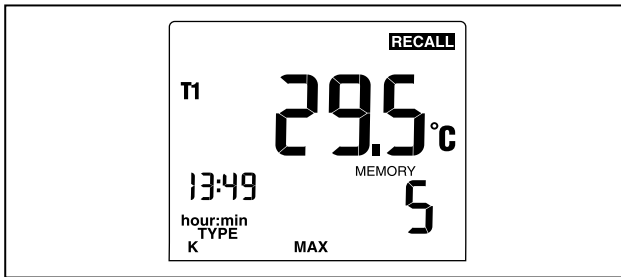

aat04f.eps

Figure 4. Maximum Reading

- Press **RECALL** to stop viewing logged readings.

Note

The thermometer calculates the minimum and maximum of all logging sessions in memory.

The display shows "- - : - -" if the log is empty.

Communicating with a PC

You can transfer the contents of the thermometer's memory to a PC using *FlukeView Forms*. The communication requires an IR (infrared) serial connection. Refer to the *FlukeView Forms Installation Guide* and *FlukeView Help*.

FlukeView Forms places the logged readings into standard (default) or customized forms. The forms also display user comments. You can use these forms to satisfy ISO-9000 documentation requirements.

When you send logged readings to a PC, all functions are disabled except power off, backlight, and turning off communication.

- Press **IR SEND**, **RECALL** (PC/IR SEND) to toggle the IR port on and off.

The display shows:

IR
SEND

When the IR port is enabled you can communicate with *FlukeView Forms*.

Maintenance

Replacing the Batteries

Refer to the safety information in Table 1 before replacing the batteries.

1. Turn off the thermometer if necessary.
2. Loosen the screw and remove the battery door.
3. Replace the three AA batteries.
4. Replace the battery door and tighten the screw.

Cleaning the Case and Holster

Use soap and water or a mild commercial cleaner.

Wipe with a damp sponge or soft rag.

Calibration

To ensure that the thermometer performs to its accuracy specifications, Fluke recommends that you calibrate the thermometer annually, starting one year after purchase.



To calibrate the thermometer, contact Fluke for the Service Center nearest you or follow the calibration procedure in the service manual listed in "Replacement Parts and Accessories."

Specifications

Environmental

Operating Temperature	-10 °C to 50 °C (14 °F to 122 °F)
Storage Temperature	-40 °C to +60 °C (-40 °F to +140 °F)
Humidity	Non condensing <10 °C (<50 °F) 95% RH: 10 °C to 30 °C (50 °F to 86 °F) 75% RH: 30 °C to 40 °C (86 °F to 104 °F) 45% RH: 40 °C to 50 °C (104 °F to 122 °F)

General

Weight	280 g (10 oz)
Dimensions (without holster)	2.8 cm × 7.8 cm × 16.2 cm (1.1 in × 3 in × 6.4 in)
Battery	3 AA batteries
Certification	CE,  
Safety	CSA C22.2 No. 1010.1 1992 EN 61010 Amendments 1, 2
CAT I	OVERVOLTAGE (Installation) CATEGORY I, Pollution Degree 2 per IEC1010-1*
* Refers to the level of Impulse Withstand Voltage protection provided. Equipment of OVERVOLTAGE CATEGORY I is equipment for connection to circuits in which measures are taken to limit the transient over voltages to an appropriate low level. Example include protect electronic circuits.	

80 PK-1 Thermocouple (supplied with thermometer)

Type	Type K, Chromel Alumel, bead style
Temperature Range	-40 °C to +260 °C (-40 °F to +500 °F)
Accuracy	± 1.1 °C (± 2.0 °F)

Electrical

Measurement Range	J-type: -210 °C to +1200 °C (-346 °F to + 2192 °F) K-type: -200 °C to +1372 °C (-328 °F to +2501 °F) T-type: -250 °C to +400 °C (-418 °F to +752 °F) E-type: -150 °C to +1000 °C (-238 °F to +1832 °F) N-type: -200 °C to +1300 °C (-328 °F to +2372 °F) R- and S-type: 0 °C to +1767 °C (+32 °F to +3212 °F)
Display Resolution	0.1 °C / °F / K < 1000° 1.0 °C / °F / K ≥ 1000°

Electrical (cont.)

Measurement Accuracy, T1, T2 or T1-T2 (Model 54)	J-, K-, T-, E-, and N-type: $\pm[0.05\% \text{ of reading} + 0.3\text{ }^{\circ}\text{C} (0.5\text{ }^{\circ}\text{F})]$ [below $-100\text{ }^{\circ}\text{C} (-148\text{ }^{\circ}\text{F})$: add 0.15 % of reading for J-, K-, E-, and N-type; and 0.45 % of reading for T-type] R- and S-type: $\pm[0.05\% \text{ of reading} + 0.4\text{ }^{\circ}\text{C} (0.7\text{ }^{\circ}\text{F})]$
Temperature Coefficient	0.01 % of reading + 0.03 $^{\circ}\text{C}$ per $^{\circ}\text{C}$ (0.05 $^{\circ}\text{F}$ per $^{\circ}\text{F}$) outside the specified +18 $^{\circ}\text{C}$ to 28 $^{\circ}\text{C}$ (+64 $^{\circ}\text{F}$ to +82 $^{\circ}\text{F}$) range [below $-100\text{ }^{\circ}\text{C} (-148\text{ }^{\circ}\text{F})$: add 0.04 % of reading for J-, K-, E-, and N-type; and 0.08 % of reading for T-type]
Electromagnetic Compatibility	Susceptibility: $\pm 2\text{ }^{\circ}\text{C} (\pm 3.6\text{ }^{\circ}\text{F})$ for 80 MHz to 200 MHz in 1.5 V/m field, for 200 MHz to 1000 MHz in 3 V/m field. Emmissions: Commercial Limits per EN50081-1
Maximum Differential Common Mode Voltage	1 V (Maximum voltage difference between T1 and T2)
Temperature Scale	ITS-90
Applicable Standards	NIST-175
Accuracy is specified for ambient temperatures between 18 $^{\circ}\text{C}$ (64 $^{\circ}\text{F}$) and 28 $^{\circ}\text{C}$ (82 $^{\circ}\text{F}$) for a period of 1 year. The above specifications do not include thermocouple error.	

Replacement Parts and Accessories

Accessory	Part Number
Holster and Flex Stand™ Assembly	1272438
AA NEDA 15A IEC LR6 batteries	376756
80PK-1 K-Type Bead Thermocouple	773135
CD-ROM	1276106
Service Manual	1276123

