

# BK PRECISION®

Model: 5492B, 5492BGPIB

## 5 ½ Bench Digital Multimeter

USER MANUAL



**Test Equipment  
Depot**  
1-800-517-8431

99 Washington Street  
Melrose, MA 02176  
Phone 781-665-1400  
Toll Free 1-800-517-8431



Visit us at [www.TestEquipmentDepot.com](http://www.TestEquipmentDepot.com)

# Safety Notice

As described in the International Electrotechnical Commission (IEC) Standard IEC 664, digital multimeter measuring circuits (e.g., B&K Models 5492B) and the USB terminal are Installation Category II (CAT II). All other instruments' signal terminals are Installation Category I and must not be connected to mains.

This equipment is a POLLUTION DEGREE 2, INDOOR USE product.

## Safety Summary

The following safety precautions apply to both operating and maintenance personnel and must be observed during all phases of operation, service, and repair of this instrument. Before applying power, follow the installation instructions and become familiar with the operating instructions for this instrument.

### ***GROUND THE INSTRUMENT***

To minimize shock hazard, the instrument chassis and cabinet must be connected to an electrical ground. This instrument is grounded through the ground conductor of the supplied, three-conductor ac power cable. The power cable must be plugged into an approved three-conductor electrical outlet. Do not alter the ground connection. Without the protective ground connection, all accessible conductive parts (including control knobs) can render an electric shock. The power jack and mating plug of the power cable meet IEC safety standards.

### ***DO NOT OPERATE IN AN EXPLOSIVE ATMOSPHERE***

Do not operate the instrument in the presence of flammable gases or fumes. Operation of any electrical instrument in such an environment constitutes a definite safety hazard.

### ***KEEP AWAY FROM LIVE CIRCUITS***

Instrument covers must not be removed by operating personnel. Component replacement and internal adjustments must be made by qualified maintenance personnel. Disconnect the power cord before removing the instrument covers and replacing components. Under certain conditions, even with the power cable removed, dangerous voltages may exist. To avoid injuries, always disconnect power and discharge circuits before touching them.

### ***DO NOT SERVICE OR ADJUST ALONE***

Do not attempt any internal service or adjustment unless another person, capable of rendering first aid and resuscitation, is present.

### ***DO NOT SUBSTITUTE PARTS OR MODIFY THE INSTRUMENT***

Do not install substitute parts or perform any unauthorized modifications to this instrument. Return the instrument to B&K Precision for service and repair to ensure that safety features are maintained.

## **WARNINGS AND CAUTIONS**

**WARNING** and **CAUTION** statements, such as the following examples, denote a hazard and appear throughout this manual. Follow all instructions contained in these statements.

A **WARNING** statement calls attention to an operating procedure, practice, or condition, which, if not followed correctly, could result in injury or death to personnel.

A **CAUTION** statement calls attention to an operating procedure, practice, or condition, which, if not followed correctly, could result in damage to or destruction of parts or the entire product.

**WARNING:** *Do not alter the ground connection. Without the protective ground connection, all accessible conductive parts (including control knobs) can render an electric shock. The power jack and mating plug of the power cable meet IEC safety standards.*

**WARNING:** *To avoid electrical shock hazard, disconnect power cord before removing covers. Refer servicing to qualified personnel.*

**CAUTION:** *Before connecting the line cord to the AC mains, check the rear panel AC line voltage indicator. Applying a line voltage other than the indicated voltage can destroy the AC line fuses. For continued fire protection, replace fuses only with those of the specified voltage and current ratings.*

**CAUTION:** *This product uses components which can be damaged by electro-static discharge (ESD). To avoid damage, be sure to follow proper procedures for handling, storing and transporting parts and subassemblies which contain ESD-sensitive components.*

## SAFETY SYMBOL



This symbol serves as a warning to users of the input safety ratings. Refer to the operating instructions for details.



Electrical Shock hazard.



Chassis ground symbol.

**CAT I  
(1000V)**

IEC Measurement Category I.  
Inputs may be connected to  
mains (up to 300 VAC) under  
Category II overvoltage conditions.

**CAT II  
(300V)**

IEC Measurement Category II.

## Compliance Statements

**Disposal of Old Electrical & Electronic Equipment (Applicable in the European Union and other European countries with separate collection systems)**

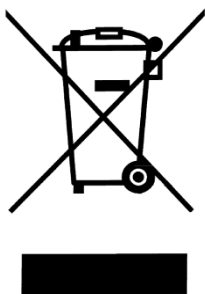

This product is subject to Directive 2002/96/EC of the European Parliament and the Council of the European Union on waste electrical and electronic equipment (WEEE) , and in jurisdictions adopting that Directive, is marked as being put on the market after August 13, 2005, and should not be disposed of as unsorted municipal waste. Please utilize your local WEEE collection facilities in the disposition of this product and otherwise observe all applicable requirements.

## **CE Declaration of Conformity**

The 5492B and 5492BGPIB meets the requirements of 2006/95/EC Low Voltage Directive and 2004/108/EC Electromagnet Compatibility Directive.

### **Low Voltage Directive**

- EN61010-1: 2001 (2<sup>nd</sup> edition)  
Safety requirements for electrical equipment for measurement, control, and laboratory use.

### **EMC Directive**

- EN 61326-1:2006
- EN 61326-2-2: 2006  
Electrical equipment for measurement, control, and laboratory use.

# Table of Contents

Chapter 1 General Information .....	9
1.1 Feature Overview .....	9
1.2 Input Power and Fuse Requirements .....	9
1.3 Package Contents .....	11
Chapter 2 Overview .....	12
2.1 Front Panel Overview .....	12
2.2 Screen Display .....	14
2.3 Front Panel Menu Options.....	14
2.4 Front Panel Menu Overview .....	16
2.5 Rear Panel Summary .....	17
2.6 Power up.....	18
2.6.1 Power Line Connection .....	18
2.6.2 Power-up Sequence .....	18
2.6.3 High Energy Circuit Safety Precautions .....	19
2.6.4 Power-on Defaults .....	19
2.6.5 Warm-up time .....	21
Chapter 3 Basic Measurements.....	22
3.1 Overview .....	22
3.2 Measuring Voltage.....	22
3.2.1 Connections.....	22
3.2.2 Crest factor .....	24
3.3 Measuring Current.....	24
3.3.1 Connections.....	24
3.3.2 Front Panel Fuse Replacement.....	25
3.4 Measuring Resistance .....	26
3.4.1 Connections.....	26
3.4.2 Shielding .....	27
3.5 Measuring Frequency and Period.....	28
3.5.1 Trigger Level and Measurement Errors.....	28
3.5.2 Gate Time .....	28
3.5.3 Connections.....	28
3.6 Measuring Continuity.....	29
3.6.1 Connections.....	29
3.6.2 Threshold resistance level.....	30
3.7 Testing Diode .....	30
3.7.1 Connections.....	30
3.7.2 Current Range .....	31
3.8 Math Functions.....	32

3.8.1 <i>mX+b</i> .....	32
3.8.2 <i>Percent</i> .....	33
3.8.3 <i>dB Calculation</i> .....	34
3.8.4 <i>dBm Calculation</i> .....	35
<b>Chapter 4 Measurement Options .....</b>	<b>37</b>
4.1 Measurement configuration .....	37
4.1.1 <i>Range</i> .....	37
4.1.2 <i>Filter</i> .....	38
4.1.3 <i>Relative</i> .....	39
4.1.4 <i>Rate</i> .....	40
4.2 Trigger Operations.....	41
4.2.1 <i>Trigger Model</i> .....	41
4.2.2 <i>EXT Trig &amp; VM Comp</i> .....	44
4.3 Buffer Operations .....	44
4.3.1 <i>Store Reading</i> .....	45
4.3.2 <i>Recall Readings</i> .....	46
4.3.3 <i>Buffer Statistics</i> .....	47
4.4 Limit Operations .....	47
4.4.1 <i>Enabling limits</i> .....	48
4.4.2 <i>Setting Limit Values</i> .....	48
4.4.3 <i>Configure Limit Beep</i> .....	49
4.5 System Operations.....	49
4.5.1 <i>Beeper Control</i> .....	50
4.5.2 <i>Save Settings</i> .....	50
4.5.3 <i>Restore Settings</i> .....	51
4.5.4 <i>Display Control</i> .....	51
4.5.5 <i>Key Sound</i> .....	52
4.5.6 <i>Self-test</i> .....	52
4.5.7 <i>Calibration</i> .....	53
<b>Chapter 5 Remote Operation.....</b>	<b>54</b>
5.1 Selecting an Interface.....	54
5.1.1 <i>USB (Virtual COM) Interface</i> .....	54
5.1.2 <i>RS-232 Serial Interface</i> .....	55
5.1.3 <i>GPIB Interface (model 5492BGPIB only)</i> .....	55
5.2 USB & RS-232 Interface Operation .....	56
5.2.1 <i>RS-232 Connection</i> .....	56
5.2.2 <i>Sending and receiving data</i> .....	57
5.2.3 <i>Selecting Baud Rate</i> .....	57
5.2.4 <i>Selecting Parity Mode</i> .....	57
5.2.5 <i>Selecting Terminal Character</i> .....	58
5.2.6 <i>Selecting Echoing</i> .....	58
5.2.7 <i>Software Protocol</i> .....	59

5.3 GPIB Interface operation (model 5492BGPIB only) .....	60
5.3.1 GPIB Connection .....	60
5.3.2 GPIB Interface Capability .....	61
5.3.3 GPIB Addressing .....	61
5.4 Data Format .....	61
<b>Chapter 6 SCPI Command Reference .....</b>	<b>62</b>
6.1 Command Structure .....	62
6.2 Command Syntax .....	63
6.2.1 Commands and command parameters .....	63
6.2.2 Short-form Rules .....	64
6.2.3 Basic Rules of Command Structure .....	65
6.2.4 Multiple Command Rules .....	65
6.2.5 Command Path Rules .....	65
6.3 Command Reference .....	66
6.3.1 Measurement Commands .....	66
6.3.2 DISPlay subsystem .....	70
6.3.3 CALCulate Subsystem .....	70
6.3.4 SENSE subsystem command .....	79
6.3.5 SYSTem Subsystem .....	92
6.3.6 UNIT Subsystem .....	94
6.3.7 TRIGger Subsystem .....	97
6.3.8 Common Commands .....	99
<b>Chapter 7 Troubleshooting Guide .....</b>	<b>100</b>
7.1 Frequently Asked Questions .....	100
7.2 Error Messages .....	101
<b>Chapter 8 Specifications .....</b>	<b>102</b>
8.1 Technical Specifications .....	102
<b>SERVICE INFORMATION .....</b>	<b>110</b>
<b>LIMITED THREE-YEAR WARRANTY .....</b>	<b>110</b>



# Chapter 1      **General Information**

This chapter is outlined as follows:

- 1.1      Feature Overview**
- 1.2      Input Power and Fuse Requirements**
- 1.3      Package Contents**

## **1.1      Feature Overview**

5492B is a 5½ digital multimeter with high accuracy, stability and speed. It has a 0.01% DC voltage basic accuracy, 0.03% basic resistance accuracy and broad ranges that can measure:

- DC voltage up to 1000 V
- AC (RMS) voltage up to 750 V, or about 1000 V Peak
- DC current up to 12 A
- AC (RMS) current up to 12 A
- Two and four-wire resistance up to 120 MΩ
- Frequency from 5 Hz to 1 MHz

## **1.2      Input Power and Fuse Requirements**

The 5492B digital multimeter can operate on 110 V or 220 V with +/- 10% tolerance at 60 Hz or 50 Hz with +/- 5% tolerance respectively. Before powering the instrument, please check for correct power input setup that corresponds to the line voltage to be used for operation. Note the label in the rear label, as shown below:

<b>RATING</b>	<b>FUSE</b>
~110 V / 60 Hz	T1AL, 250 V
~220 V / 50 Hz	T500mAL, 250 V

There are two items to check for:

1. Check that the correct fuse is placed inside the fuse box. Referring to the above table, use a 1 A fuse for 110 V/ 60 Hz operation, and 500 mA fuse for 220 V/50 Hz operation.
2. Check the fuse holder position. There is a voltage indicator window on the front face of the fuse box that indicates the selected line voltage. To change or select the appropriate line voltage, remove the fuse box and pull out and rotate the fuse holder, as illustrated below:

## General information

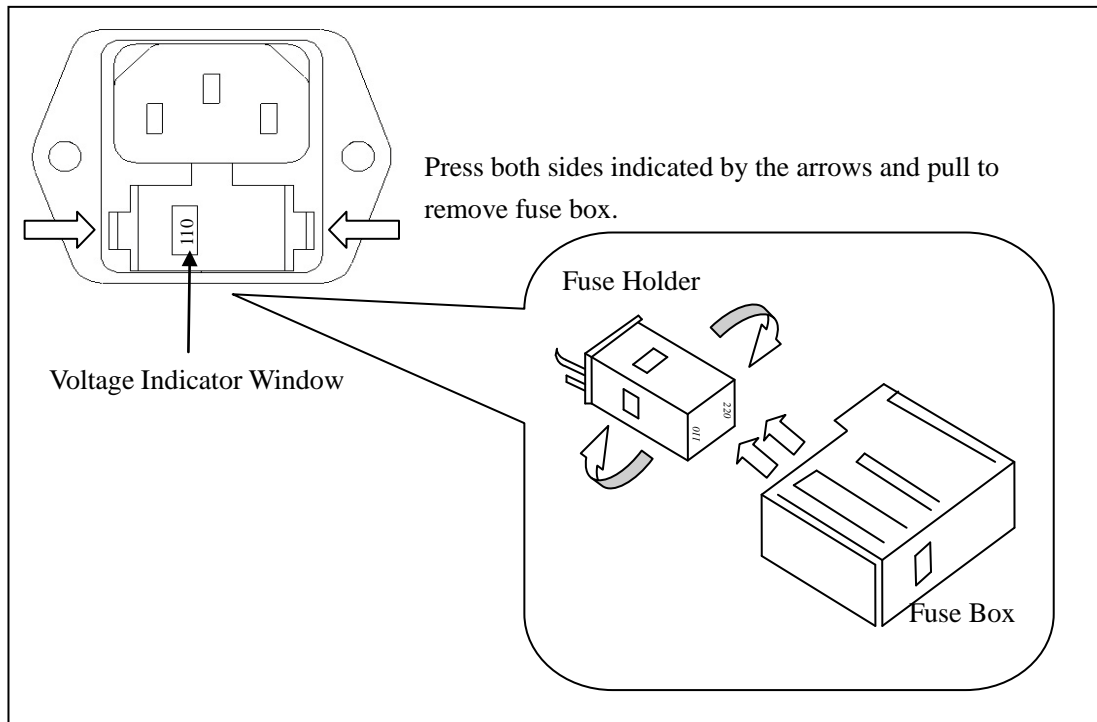

There is a second fuse with a fuse holder located in the front panel of the multimeter. This is an over current protection fuse for the low current measurement input. It is rated for a T2AL, 250 V fuse. To remove and replace this fuse, see the illustration below:

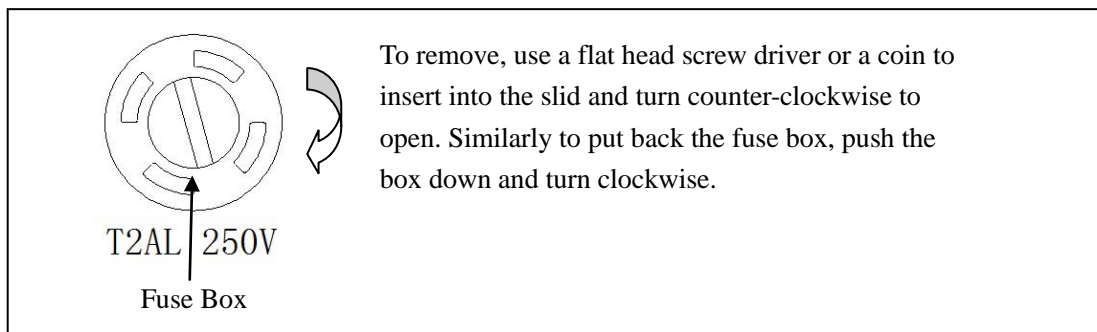

There is a third fuse located inside the instrument which protects the 12 A input terminal if current exceeds the maximum rating. It is a 6 x 32 mm 250V, 20 A fast acting high energy ceramic fuse.

### 1.3 Package Contents

Please inspect the instrument mechanically and electrically upon receiving it. Unpack all items from the shipping carton, and check for any obvious signs of physical damage that may have occurred during transportation. Report any damage to the shipping agent immediately. Save the original packing carton for possible future reshipment. Every meter is shipped with the following contents:

- 5492B/5492BGPIB 5½ digit multimeter
- TL35B Test Leads (one set)
- AC Power cord
- Spare fuses
- User Manual
- USB Cable
- Certificate of Calibration and Test Report

Verify that all items above are included in the shipping container. If anything is missing, please contact B&K Precision.

## Chapter 2 Overview

This chapter is outlined as follows:

- 2.1 Front Panel Overview
- 2.2 Screen Display
- 2.3 Front Panel Menu Options
- 2.4 Front Panel Menu Overview
- 2.5 Rear Panel Summary
- 2.6 Power up

### 2.1 Front Panel Overview

The front panel of the B&K 5492B is shown in Figure 2-1. This figure includes some important abbreviated information that should be reviewed before operating the instrument.

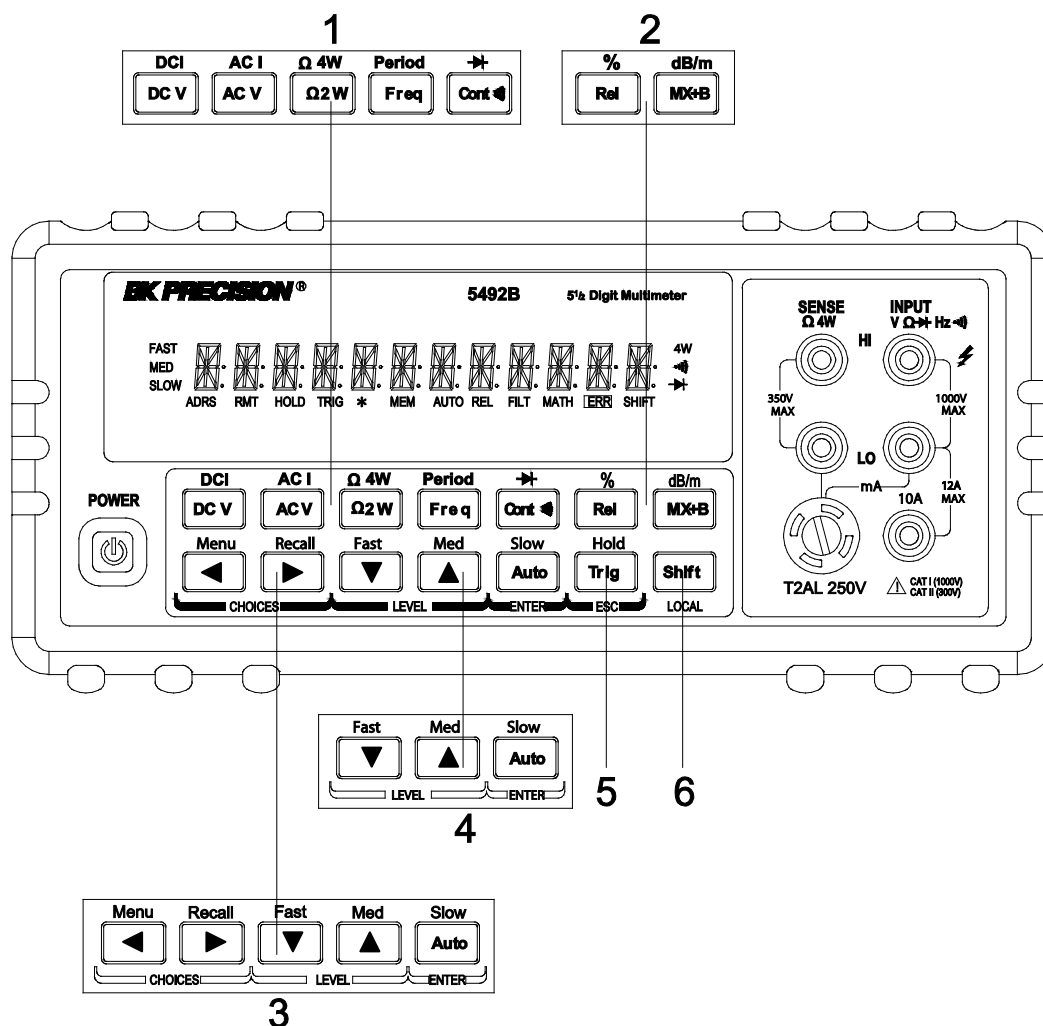

Figure 1 - Front Panel View

## Overview

---

### 1. Measurement function keys



Select measurement function: DC voltage and current, AC voltage and current, 2-wire and 4-wire resistance, frequency, period, continuity and diode test.

### 2. Math function keys

Select math function: mX+b, %, dB, dBm and Rel.

### 3. Menu operation keys

 →  Open/Close menu

 →  Recall the menu performed last

 Move through selections within menu level, sub-menu level or parameter level

 Move through selections within menu level, sub-menu level or parameter level.

 Move up a level.

 Move down a level.

 (ENTER) Save the changes made on “parameter” level, and return to the “sub-menu” level.

 (ESC) Cancel the changes made on “parameter” level, and return to the “sub-menu” level.



### 4. Range and measurement speed keys

 Select a higher range and disable auto ranging.

 Select a lower range and disable auto ranging.

 Toggle between auto ranging and manual ranging.



 →  Set measurement speed to Fast.

 →  Set measurement speed to Medium.

 →  Set measurement speed to Slow.

### 5. Trig/Hold Key

 Trigger a measurement from the front panel.

 →  Hold a stable reading on the display when selected numbers of samples are within the selected tolerance.

### 6. Shift/Local keys

 Used to access shifted keys (labels are in blue).

 (LOCAL) Exit remote operation and set back to local operation.

## 2.2 Screen Display

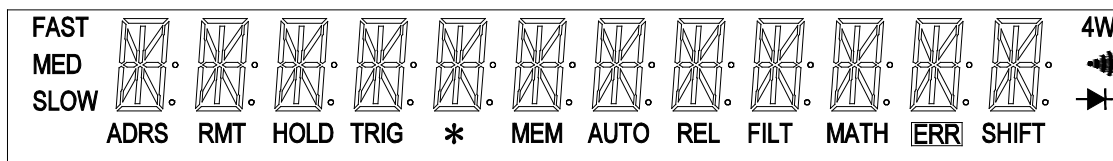

**Figure 2-2 Display Annunciators**

- \* (asterisk) Instrument is ready to store readings (when in system menu) /  
Reading is being stored (when in measurement mode)
- ➔ (Diode) Instrument is in diode testing function
- (Speaker) Beeper on for continuity testing function
- 4W Multimeter is in 4-wire resistance measurement mode.
- ADRS Multimeter is addressed to listen or talk over the GPIB interface
- AUTO Auto ranging enabled
- ERR Hardware or remote control error detected
- FAST Fast reading rate
- FILT Digital filter enabled
- HOLD Reading HOLD is enabled
- MATH A math operation is enabled (mX+b, %, dB, dBm).
- MED Medium reading rate
- MEM Turns on when reading memory is enabled
- REL Relative reading displayed
- RMT Multimeter is in remote mode
- SHIFT Accessing shifted keys
- SLOW Slow reading rate
- TRIG Multimeter is waiting for a trigger (manual, bus, or external trigger).

## 2.3 Front Panel Menu Options

### A : MEASUREMENT MENU

1:CONTINUITY → 2:FILTER → 3:FILT TYPE → 4:FILT COUNT

1. CONTINUITY Select the continuity beeper threshold: 1 Ω to 1000 Ω
2. FILTER Enable or disable FILTER function.
3. FILT TYPE Select the type of filter.  
Select MOVNG AV (Moving Average) or REPEAT (Repeating Average).
4. FILT COUNT Set the number of readings to be filtered or averaged.

### B : MATH MENU

1:SET M → 2:SET B → 3:PERCENT → 4:dB REF → 5:dBm REF → 6:LIMIT TEST → 7:HIGH LIMIT  
→ 8:LOW LIMITT → 9:LIMIT BEEP

1. SET M Set the scale factor M for MX+B function.
2. SET B Set the offset factor B for MX+B function.

## Overview

---

- |               |   |
|---------------|---|
| 3. PERCENT    | Set the reference value for PERCENT function.                             |
| 4. dB REF     | Set the dB reference voltage value.                                       |
| 5. dBm REF    | Set the dBm reference impedance value.                                    |
| 6. LIMIT TEST | Enable or disable the limit testing.                                      |
| 7. HIGH LIMIT | Set the high limit for limit testing.                                     |
| 8. LOW LIMIT  | Set the low limit for limit testing.                                      |
| 9. LIMIT BEEP | Set the beep mode for limit testing. Select from: NEVER, HI, IN, LO, OUT. |

### C : TRIGger MENU

1:TRIG MODE → 2:TRIG DELAY

- |               |  |
|---------------|--|
| 1. TRIG MODE  | Select the trigger source.<br>Select IMM (Immediate), MAN (Manual), BUS, or EXT (External) trigger source.                                   |
| 2. TRIG DELAY | Select AUTO or MANUAl trigger delay mode. Selecting manual will allow you to specify a time interval which is inserted before a measurement. |

### D : SYStem MENU

1:RDGS STORE → 2:RDGS COUNT → 3:SAVED RDGS → 4:BEEP → 5:SAVE CNFG → 6:LOAD CNFG → 7:DISPLAY → 8:KEY SOUND → 9:TEST

- |               |  |
|---------------|--|
| 1. RDGS STORE | Enable or disable reading memory.                                |
| 2. RDGS COUNT | Set the number of readings to be saved (2 to 512).               |
| 3. SAVED RDGS | Recall readings stored in memory.                                |
| 4. BEEP       | Enable or disable the beeper function                            |
| 5. SAVE CNFG  | Save the present configuration as one of the 10 user's settings. |
| 6. LOAD CNFG  | Restore factory or one of the 10 user's settings                 |
| 7. DISPLAY    | Enable or disable the front panel display.                       |
| 8. KEY SOUND  | Enable or disable the key sound when you press a key.            |
| 9. TEST       | Perform a complete self-test.                                    |

### E : Input / Output MENU





1:GPIB ADDR → 2:INTERFACE → 3:BAUD RATE → 4:PARITY → 5:TX TERM → 6:RETURN

- |              |   |
|--------------|---|
| 1. GPIB ADDR | Set the GPIB bus address. (0 to 31)   |
| 2. INTERFACE | Select between GPIB and USB/RS232 as the remote control interface.  |
| 3. BAUD RATE | Select the baud rate for USB/RS232C operation.<br>Select from: 115.2K, 57.6K, 38.4K, 19.2K, 9600, 4800, 2400. |
| 4. PARITY    | Select the parity mode for USB/RS232C operation.<br>Select from: NONE, EVEN, ODD.                             |
| 5. TX TERM   | Select the terminal character for USB/RS232C communication.<br>Selection from: LF, CR, LFCR                   |
| 6. RETURN    | Enable or disable echoing command strings.  |

### F : CALibration MENU (This function is not available)

1:SECURED → 3:CAL DATE → 4:CAL COUNT

## 2.4 Front Panel Menu Overview

The menu is organized in a top-down tree structure with three levels (menus, submenus and parameters) as shown in Figure 2-3. You can use down () or up () keys to browse through the menu tree from one level to another. Each of the three levels has several choices which you can view by using left () or right () keys.

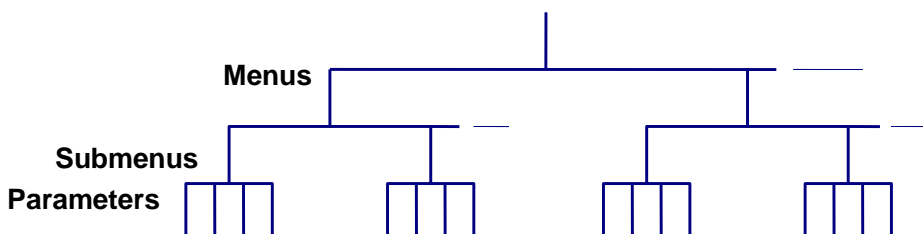











Figure 2-3 Menu Tree



- To turn on the menu, press  →  (Menu).
- To turn off the menu, press  →  (Menu), or press any of the function or math keys on the top row of front panel keys (i.e. DC V, Freq, etc.).
- To confirm a change on the “parameter” level, press  (ENTER).
- To cancel a change on the “parameter” level, press  (ESC).
- To recall the last menu command that was executed, press  →  (Recall)

The messages displayed during menu operation are listed in the following Table 2-1.

Table 2-1 Messages Displayed During Menu Operation

MESSAGES	DESCRIPTION
<b>CHANGE SAVED</b>	The change made on the “parameter” level is saved. This message will be displayed after you press  (ENTER) to save the changes.
<b>TOO SMALL</b>	The value you specified on the “parameter” level is too small for the selected command. The minimum value allowed is displayed for you to edit.
<b>TOO LARGE</b>	The value you specified on the “parameter” level is too large for the selected command. The maximum value allowed is displayed for you to edit.
<b>FILE SAVING</b>	System configuration file is being saved.
<b>FILE LOADING</b>	System configuration file is being restored.
<b>SAVE SUCCEED</b>	System configuration file is successfully saved.
<b>LOAD SUCCEED</b>	System configuration file is successfully restored.



**Note:** If you press  on the “menu” level, nothing will happen because it is at the top menu level of already. Likewise, if you press  on the “parameter” level, nothing will happen because it is at the lowest menu level.

## 2.5 Rear Panel Summary

The rear panel of BK 5492B is shown in Figure 2-4. This section includes important information that should be reviewed before operating the instrument.

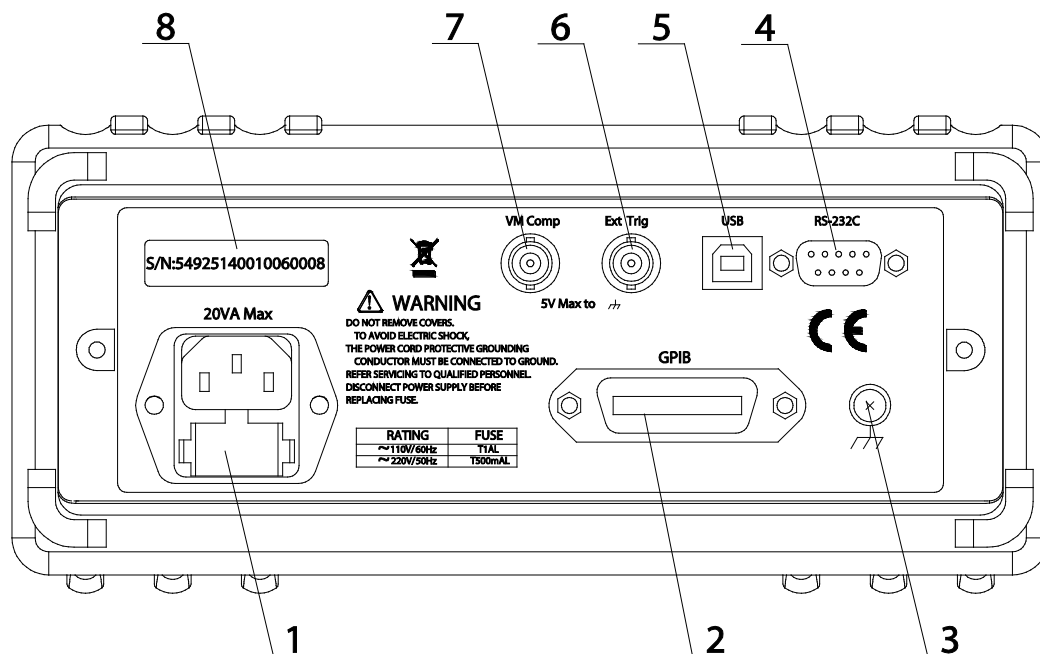

Figure 2-4 Rear Panel

1. Power line fuse holder  
The multimeters can be configured for line voltage of 110/220 V  $\pm$  10 % AC at line frequency of 50/60 Hz  $\pm$  5%.  
Power line fuse is used for instrument protection. (220 V/500 mA or 110 V/1 A)  
**Note: Please use the same-type of fuse as it is in the fuse holder. To verify and replace the fuse, remove the power cable and pull out the fuse holder. See section 1.2 for details.**
2. (optional) GPIB (IEEE-488) interface (model 5492BGPIB)
3. Chassis ground screw terminal
4. RS-232 (Serial) interface
5. USB interface
6. External Trigger BNC input terminal
7. VM Comp (Voltmeter complete) BNC output terminal
8. Serial number label

## 2.6 Power up

### 2.6.1 Power Line Connection

**CAUTION:** *Operating the instrument on an incorrect line voltage may cause damage to the instrument, possibly voiding the warranty.*

**BEFORE** connecting the 5492B multimeter to a power line, please check that the correct fuse is in place, and the fuse box inside the fuse holder is adjusted correctly. See section 1.2 for details.

Follow the procedure below to connect the 5492B to line power and turn on the instrument.

1. Check the line voltage and be sure it is within the acceptable range of the meter **BEFORE** connecting into the AC input in the rear panel of the instrument. **Applying an incorrect voltage may cause damage to the instrument and void its warranty.**
2. Check the fuse box position inside the fuse holder to make sure it is in the correct position that corresponds to the line voltage the unit will be connected to. The fuse holder will have a selected voltage label on the front to indicate the selected voltage tab for operation. Change the fuse box position to change between 110 and 220. If you're not sure, see section 1.2 for details.
3. Check that the correct line fuse is properly inserted into the fuse box. The fuse rating between 110V and 220V operation is different. Refer to section 1.2 for details.
4. Before plugging in the power cord, make sure that the front panel power switch is in the off (out) position.
5. Connect the female end of the supplied power cord to the AC input on the rear panel. Connect the other end of the power cord to a grounded AC outlet.

**WARNING:** *The power cord supplied with the Model 5492B contains a separate ground wire for use with grounded outlets. When proper connections are made, instrument chassis is connected to power line ground through the ground wire in the power cord. Failure to use a grounded outlet may result in personal injury or death due to electric shock.*

6. Turn on the instrument by pressing the front panel power switch.

### 2.6.2 Power-up Sequence

On power-up, the multimeter performs self-tests on its EPROM and RAM and lights all segments and annunciators for about 1 second. If a failure is detected, the instrument momentarily displays an error message and the ERR annunciator will turn on.

If the instrument passes self-tests, the firmware version and the model number will display momentarily before it is ready for use.

### 2.6.3 High Energy Circuit Safety Precautions

To optimize safety when measuring voltage in high energy distribution circuits, read and use the directions in the following warning.

**WARNIG:** *Dangerous arcs of an explosive nature in a high energy circuit can cause severe personal injury or death. If the multimeter is connected to a high energy circuit when set to a current range, low resistance range, or any other low impedance range, the circuit is virtually shorted. Dangerous arcing can result even when the multimeter is set to a voltage range if the minimum voltage spacing is reduced in the external connections.*

When making measurements in high energy circuits, use test leads and accessories that meet the following requirements:

- Test leads and accessories must be fully insulated and adhere to proper ANSI IEC CAT ratings.
- Do not use test leads or accessories that decrease voltage spacing. This diminishes arc protection and creates a hazardous condition.

**WARNING:** *The maximum common-mode voltage (voltage between INPUT LO and the chassis ground) is 500 V peak. Exceeding this value may cause a breakdown in insulation, creating a shock hazard.*

### 2.6.4 Power-on Defaults

The multimeter uses the factory default settings for the power-on settings.

All the procedures in this manual assume factory default settings, therefore reset the instrument to the factory settings when following the step-by-step procedures in later sections. Table 2-2 lists the factory default settings.

## Overview

**Table 2-2 Factory Default Settings**

Setting	Factory Default
Autozero	On
Buffer	No effect
Continuity	
Beeper	On
Digits	4 1/2
Rate	Fast(0.1 PLC)
Threshold	10 Ω
Current(AC and DC)	
Digits(AC)	5 1/2
Digits(DC)	5 1/2
Filter	On
Count	5
Mode	Moving average
Range	Auto
Relative	Off
Value	0.0
Rate(AC)	Medium(10PLC)
Rate(DC)	Medium( 1 PLC)
Diode test	
Digits	5 1/2
Range	1 mA
Rate	Medium(1 PLC)
Frequency and Period	
Digits	5 1/2
Range	12 V
Relative	Off
Value	0.0
Rate	Slow(1 sec)
	DCV
Function	No effect
GPIB	8
Address	SCPI
Language	Off
Limits	ON
Beeper	+1
High limit	-1
Low limit	Off
mX+b	1.0
Scale factor	0.0
Offset	Off
Percent	1.0
Reference	

## Overview

---

**Table 2-2 Factory Default Settings (cont.)**

Resistance(2-wire and 4-wire)	
Digits	5 1/2
Filter	On
Count	5
Mode	Moving average
Range	Auto
Relative	Off
Value	0.0
Rate	Medium(1 PLC)
RS-232(USB)	On
Baud	9600
Triggers	On
Continuous	Auto
Delay	Immediate
Source	
Voltage(AC and DC)	No effect
dB reference	75 $\Omega$
dBm reference	5 1/2
Digits(AC)	5 1/2
Digits(DC)	On
Filter	5
Count	
Mode	Moving average
Range	Auto
Relative	Off
Value	0.0
Rate(AC)	Medium(10PLC)
Rate(DC)	Medium( 1PLC)

### 2.6.5 Warm-up time



The 5492B is ready for use after power-up sequence (boot and self test) is completed. However, to achieve specified accuracy and stability, allow the instrument to warm up for half an hour. If the instrument has been subjected to extreme temperatures, allow additional time for internal temperature to stabilize

## Chapter 3 Basic Measurements

This chapter is outlined as follows:

- 3.1 Overview
- 3.2 Measuring Voltage
- 3.3 Measuring Current
- 3.4 Measuring Resistance
- 3.5 Measuring Frequency and Period
- 3.6 Measuring Continuity
- 3.7 Testing Diode
- 3.8 Math Functions

### 3.1 Overview

The front panel has two rows of keys to select various functions and operations. Most keys have a shifted function printed in blue above the key. To perform a shifted function, press  (the **Shift** annunciator will turn on). Then, press the key that has the desired label above it. For example, to select the AC current function, press  then press  (AC I).

If you accidentally press , just press it again to turn off the **Shift** annunciator.





### 3.2 Measuring Voltage

Voltage ranges: 120 mV, 1.2 V, 12 V, 120 V, 1000 V (750 VAC)



Maximum resolution: 1  $\mu$ V (on 120 mV range)

#### 3.2.1 Connections

Assuming the multimeter is under factory default conditions, the basic procedure for measuring voltage is as follows:

1. Connect test leads to INPUT HI and LO terminals.
2. Select DC or AC voltage measurement by pressing  or  respectively.
3. Press  to toggle between auto and manual ranging. Notice the **AUTO** annunciator is displayed with auto ranging. For manual range, use the RANGE  and  keys to select the appropriate range for measurement.
4. Connect test leads to the sources as shown in Figure 3-1.

**CAUTION:** Do not apply more than 1000 V peak to the input or it will damage the instrument.

5. If the “OVR.FLW” message is displayed, press the up  key to select a higher range until a normal reading is displayed (or press  key for auto ranging). Use the lowest possible range for the best resolution. The measured reading is displayed.

## Basic Measurements

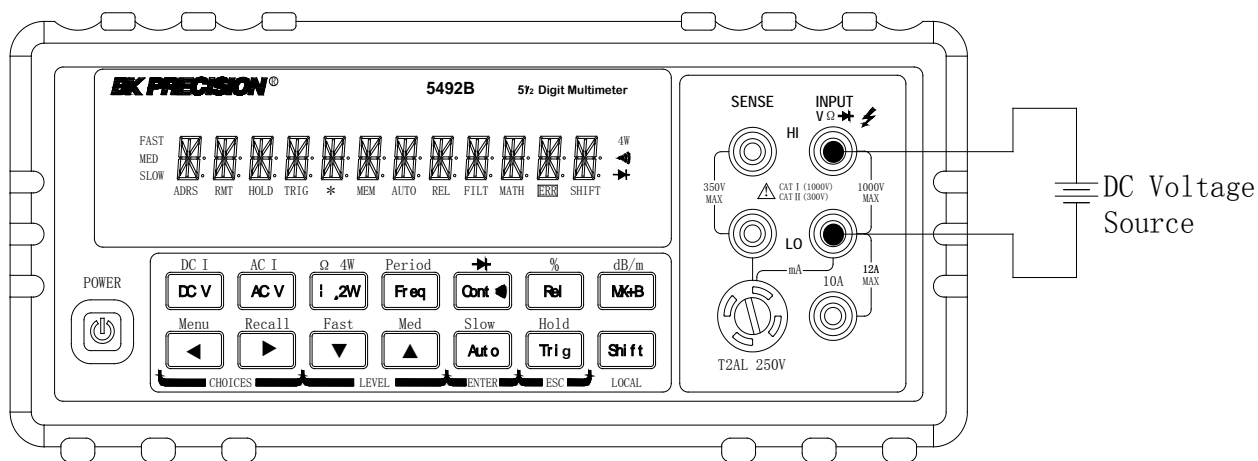

Input Resistance = 10 MΩ on 1000 V and 120 V ranges;  
 > 10 GΩ on 12 V, 1.2 V and 120 mV ranges

**CAUTION:** Maximum Input = 1010 V peak

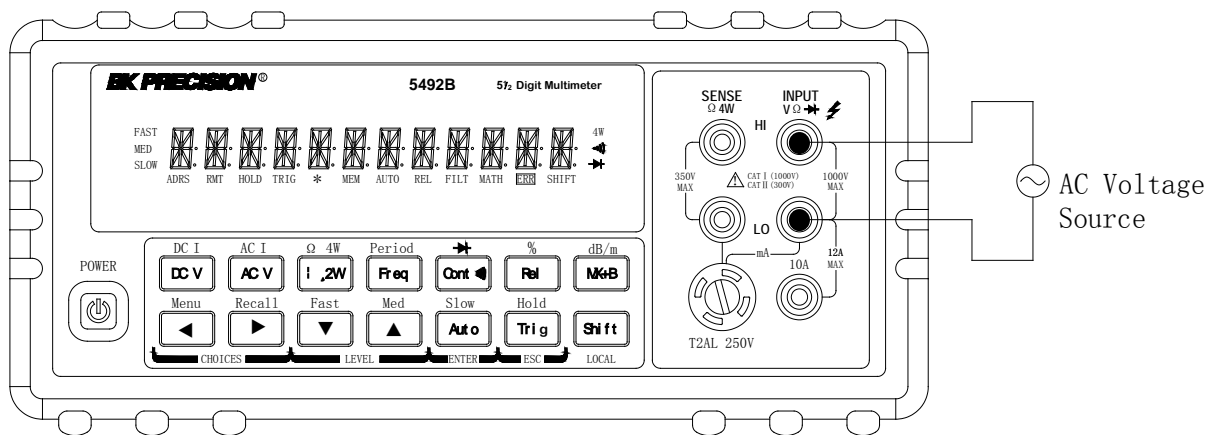

Input Impedance = 1 MΩ, 100 pF

**CAUTION:** Maximum Input = 750 V RMS or 1000 V peak

**Figure 3-1 DC and AC Voltage Measurement Connections**

### 3.2.2 Crest factor

AC voltage and current accuracies are affected by the crest factor of the waveform, the ratio of the peak value to the RMS value. Table 3-1 lists the fundamental frequencies at which the corresponding crest factor must be taken into account for accuracy calculations.

**Table 3-1 Crest Factor Limitations**

Crest Factor	Fundamental Frequency
2	50 kHz
3	3 kHz
4-5	1 kHz

## 3.3 Measuring Current

Current ranges: 12 mA, 120 mA (DCI only, not available for ACI), 1.2 A, 12 A  
 Maximum resolution: 100 nA (on 12 mA range)

**Note: Auto range is only available for 12 mA and 120 mA (DCI only) ranges. For 1.2 A and 12 A range, manual range must be used.**

### 3.3.1 Connections

Assuming the multimeter is under factory default conditions, the basic procedure for measuring current is as follows:

1. Connect test leads to INPUT LO and SENSE LO terminals
2. Select DCI or ACI measurement function by pressing **Shift** → **DCV** or **Shift** → **ACV** respectively.
3. Press **Auto** to toggle between auto and manual ranging. Notice the **AUTO** annunciator is displayed with auto ranging. For manual range, use the RANGE **▲** and **▼** keys to select a measurement range consistent with expected current.

**Auto range is only available for 12 mA and 120 mA (DCI only) ranges. Manual range must be used for 1.2 A and 12 A ranges.**

Therefore, it is recommended to use manual range when measuring current greater than 1 A with 1.2 A or 12 A range.

4. Connect test leads to the source as shown in Figure 3-2:

**CAUTION: Do not apply more than 2 A between INPUT LO and SENSE LO terminals or the protective fuse on the front panel will blow. Use the 10 A terminal for measuring current above 1 A. See Figure 3-2 for details.**

5. If the “OVR.FLW” message is displayed, press up **▲** key to select a higher range until a normal reading is displayed (or press **Auto** key for auto ranging). Use the lowest possible range for the best resolution. Note that auto ranging is only available for 12 mA and 120 mA (DCI only) ranges.



## Basic Measurements

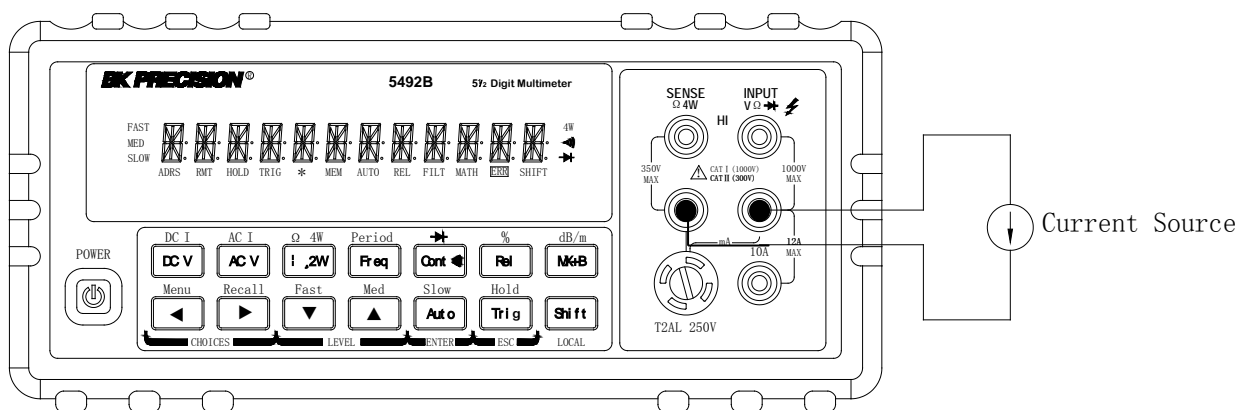

**For low current measurement: INPUT LO and SENSE LO terminals are used.**  
**CAUTION: Maximum input = 1 A DC or RMS**

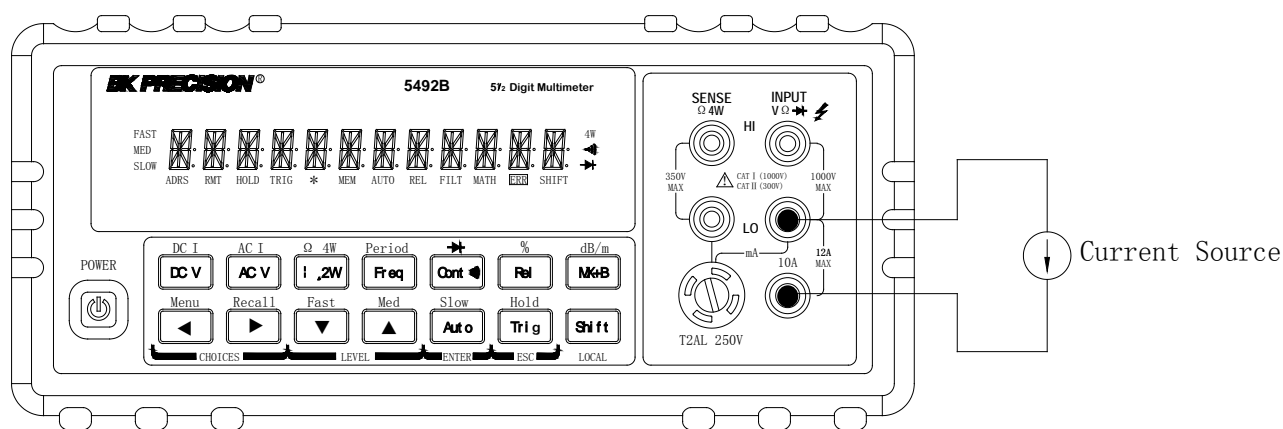

**For 1 A or higher current measurement: 10 A and INPUT LO terminals are used.**  
**CAUTION: Maximum Input = 12 A DC or RMS**  
**Note: Auto range is not available for 1.2 A and 12 A ranges**

Figure 3-2 DC and AC Current Measurements

### 3.3.2 Front Panel Fuse Replacement

**WARNING: Make sure the instrument is disconnected from the power line and other equipment before replacing the fuse.**

1. Turn off the power and disconnect the power line and test leads.
2. From the front panel, use a screwdriver to rotate the fuse holder several turns counter-clockwise. Take the fuse carrier out of the socket.
3. Remove the fuse and replace it with the same type (T2AL, 250 V, 5×20mm)

**CAUTION: Do not use a fuse with a higher current rating than specified or instrument damage may occur. If the instrument repeatedly blows fuses, try to find out the reason before replacing the fuse.**

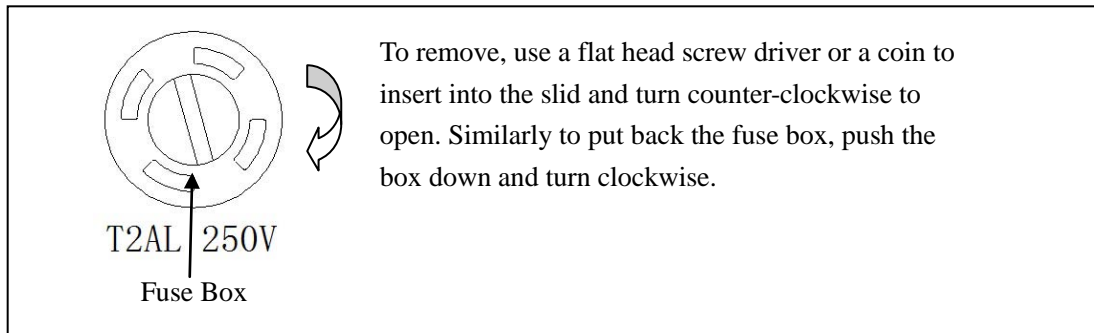

### 3.4 Measuring Resistance

Resistance measurement range: 120  $\Omega$ , 1.2 k $\Omega$ , 12 k $\Omega$ , 120 k $\Omega$ , 1.2 M $\Omega$ , 12 M $\Omega$ , 120 M $\Omega$

Maximum resolution: 1 m $\Omega$  (on 120  $\Omega$  range)

#### 3.4.1 Connections

Assuming the multimeter is under factory default conditions, the basic procedure for measuring resistance is as follows:

1. Connect test leads to the multimeter as follows:
  - A: For  $\Omega$ 2-wire, connect the test leads to INPUT HI and LO.
  - B: For  $\Omega$ 4-wire, connect the test leads to INPUT HI and LO, and SENSE  $\Omega$  4W HI and LO. Kelvin test probes are recommended for this setup.
2. Select  $\Omega$  2-wire or  $\Omega$  4-wire measurement function by pressing  $\Omega$ 2W or Shift  $\rightarrow$   $\Omega$ 2W respectively.
3. Press Auto to toggle between auto and manual ranging. Notice the **AUTO** annunciator is displayed with auto ranging. For manual range, use the RANGE  $\blacktriangle$  and  $\blacktriangledown$  keys to select a measurement range.
4. Connect test leads to the resistance as shown in Figure 3-3:

**CAUTION:** Do not apply more than 1000 V peak between INPUT HI and LO or it will damage the instrument

5. If the "OVR.FLW" message is displayed, press up  $\blacktriangle$  key to select a higher range until a normal reading is displayed (or press Auto key for auto ranging). Use the lowest possible range for the best resolution.
6. The measured reading is displayed.

## Basic Measurements

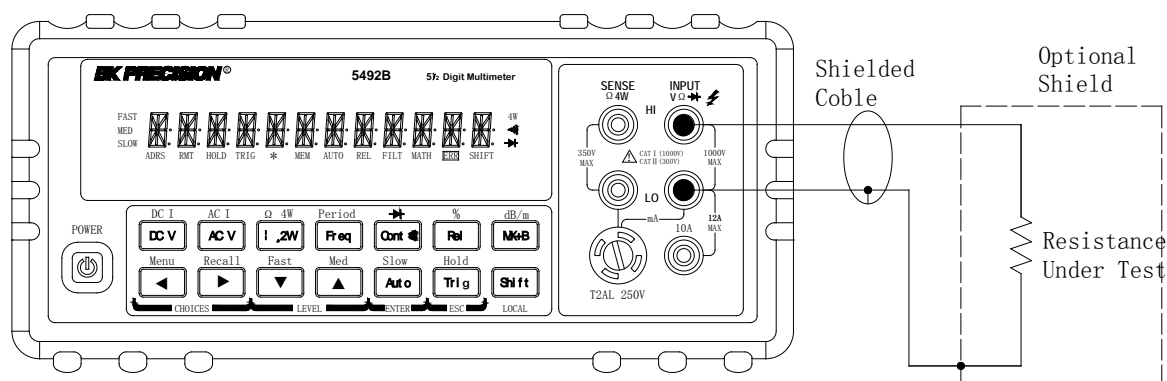

**Note:** Source current flows from the INPUT HI to INPUT LO terminals

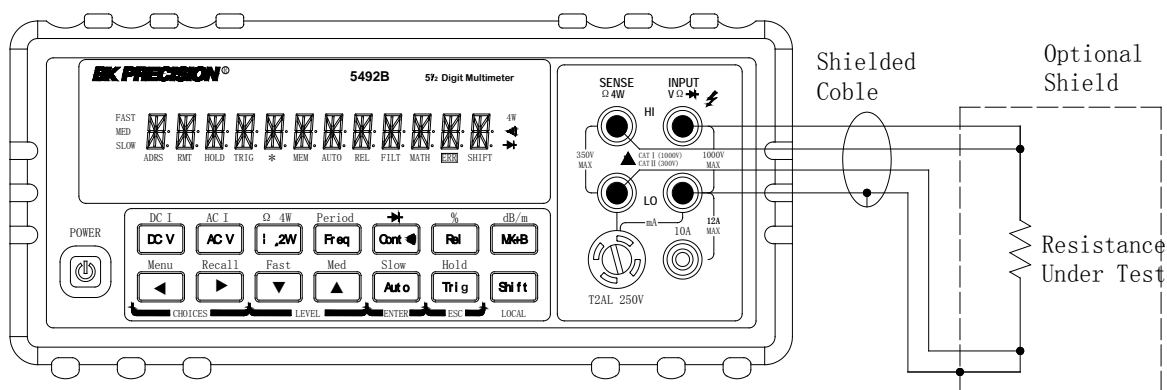

**Note:** Source current flows from the INPUT HI to INPUT LO terminals

Figure 3-3 Two- and Four- wire Resistance Measurements

### 3.4.2 Shielding



To achieve a stable accurate reading, it helps to shield resistances greater than 100 k $\Omega$ . Place the resistance in a shielded enclosure and connect the shield to the INPUT LO terminal of the instrument electrically.

### 3.5 Measuring Frequency and Period

Frequency measurement range: 5 Hz to 1 MHz.

Period measurement range: 0.2 s to 1  $\mu$ s.

Input signal range: 120 mV AC to 750 V AC RMS.

The instrument uses the volts input terminals (INPUT HI and INPUT LO) to measure frequency and period. The AC voltage range can be changed with the RANGE  and  keys. However, the signal voltage must be greater than 10% of the full-scale range.

**Note:** Auto ranging is not available for frequency and period measurement function.

#### 3.5.1 Trigger Level and Measurement Errors

Frequency and Period apply a zero-crossing trigger, meaning that a count is taken when the signal crosses the zero level.



The multimeter uses an interactive counting technique to measure frequency and period. This method generates constant measurement resolution for any input frequency. All frequency counters are subject to errors when measuring low voltage, low frequency signals. Both internal noise and external noise are also critical when measuring low voltage, low frequency signals. Measurement errors will also occur if you attempt to measure the frequency (or period) of an input following a dc offset voltage change. You must allow the multimeter's DC input blocking capacitor to fully settle before making frequency measurements.

#### 3.5.2 Gate Time

Gate time is the amount of time the multimeter uses to sample frequency or period readings. For model 5492B, all RATE settings (Fast, Med and Slow) yield a gate time of one second.

#### 3.5.3 Connections

Assuming the multimeter is under factory default conditions, the basic procedure for measuring frequency or period is as follows:

1. Connect test leads to INPUT HI and LO terminals.
2. Select frequency or period measurement functions by pressing  or  →  respectively.
3. Connect test leads to the source as shown in Figure 3-4:

**CAUTION:** Do not exceed 1000 V peak between INPUT HI and INPUT LO or instrument damage may occur.

4. The measured reading is displayed.

## Basic Measurements

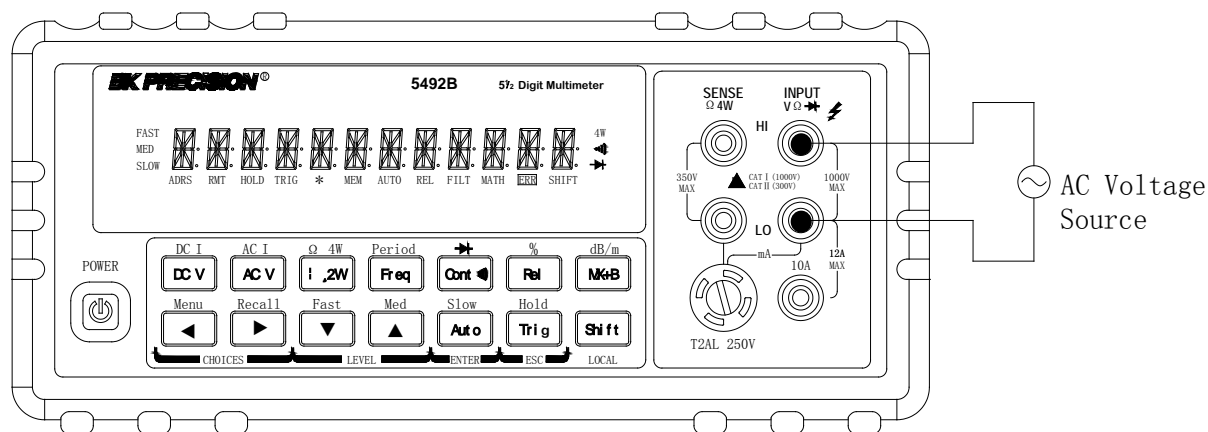

Input Impedance = 1 M $\Omega$  in parallel with <100 pF

**CAUTION:** Maximum Input = 750 RMS, or 1000 V Peak

Figure 3-4 Frequency and Period Measurements

### 3.6 Measuring Continuity

The multimeter uses the 1 k $\Omega$  range to measure circuit continuity. A threshold resistance level (1  $\Omega$  to 1000  $\Omega$ ) should be set. The factory default value is 10  $\Omega$ . The multimeter alerts you with a beep when a reading is below the set level.

**Note:** Continuity function defaults to FAST (0.1 PLC) rate and cannot be changed.

#### 3.6.1 Connections

Assuming the multimeter is under factory default conditions, the basic procedure for continuity testing is as follows:

1. Connect test leads to the INPUT HI and LO terminals.
2. Select Continuity measurement function by pressing **Cont**.
3. Connect test leads to the resistance under test as shown in Figure 3-5.
4. The measured reading is displayed.

## Basic Measurements

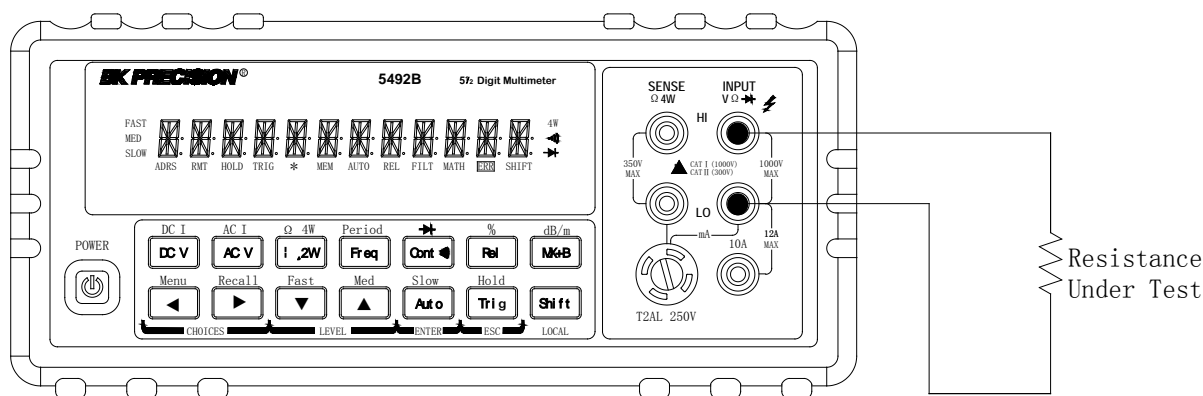

**Note:** Source current flows from the INPUT HI to INPUT LO terminals.

Figure 3-5 Continuity Measurement

### 3.6.2 Threshold resistance level

You can define a threshold resistance from 1  $\Omega$  to 1000  $\Omega$ . Factory default value is 10  $\Omega$ . Follow the steps below to define the resistance level:

1. Press **Cont** for Continuity Measurement.
2. Press **Shift**  $\rightarrow$  **▶** to enter the submenu level, "1: CONTINUITY" will be displayed.
3. Press **▼** to enter the parameter level, the current LEVEL value will be displayed.
4. Use **◀** and **▶** keys to change the cursor position and use **▲** and **▼** keys to increment or decrement the digits respectively. Enter a value from 1 to 1000.
5. Press **Auto** (ENTER) to confirm your setting. Message "CHANGE SAVED" will be displayed for a moment.
6. Press **Cont** or **Shift**  $\rightarrow$  **◀** to exit the menu and return to the continuity measurement.

## 3.7 Testing Diode

The multimeter can also be used to measure the forward voltage drop of general-purpose diodes and the zener voltage of zener diodes. A current range (1 mA, 100  $\mu$ A, or 10  $\mu$ A) can be selected for diode measurement.

**Note:** Diode testing defaults to MED (1 PLC) rate and cannot be changed.

### 3.7.1 Connections

Assuming the multimeter is under factory default conditions, the basic procedure for diode testing is as follows:

1. Connect test leads to INPUT HI and LO terminals.
2. Press **Shift**  $\rightarrow$  **Cont** for diode measurement function.
3. Connect test leads to the diode under test as shown in Figure 3-6.
4. Take a reading from the display.

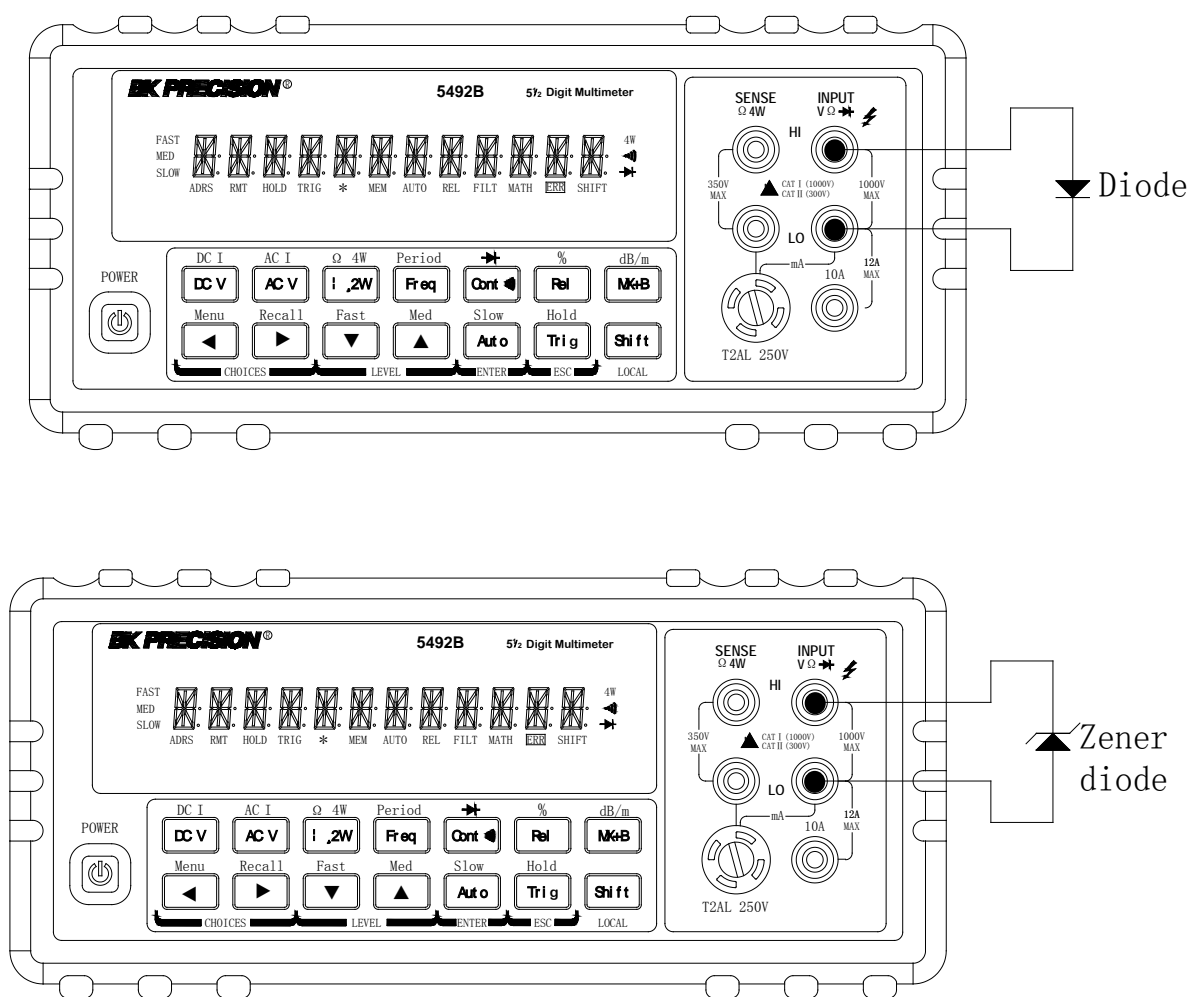

**Note:** Source current flows from the INPUT HI to INPUT LO terminals

**Figure 3-6 Diode Measurement**

## 3.7.2 Current Range

You can set the test current range from the front panel. The choices are 1 mA, 100  $\mu$ A, and 10  $\mu$ A. The factory default current range is 1 mA. To set the test current, follow the steps below:

1. Press **Shift**  $\rightarrow$  **Cont** for diode measurement function
2. Using **▲** and **▼** keys to scroll through the three test current selections.

The diode test function measures voltage on the 3V range for the 1 mA test current and the 10 V range for the 100  $\mu$ A and 10  $\mu$ A ranges. If a reading is more than 10V, the multimeter will display the "OVR.FLW" message.

## 3.8 Math Functions

The multimeter math operations are divided into four categories:

- $mX+b$  and percent
- dB and dBm calculations
- Statistics of buffered readings
- Limit testing

The first two categories are discussed here in this section, while buffered reading statistics and reading limit testing are described in the next chapter, "Measurement Options".

**Notes:** *Once math is enabled for a function, the  $mX+b$  and percentage calculations will take effect across function changes.*

### 3.8.1 $mX+b$

This math operation lets you manipulate normal display readings (X) mathematically according to the following calculation:

$$Y = mX + b$$

Where: X is the normally display actual reading

m and b are user-entered constants for scale factor and offset respectively

Y is the displayed result

To configure the  $mX+b$  calculation, perform the following steps:

1. Press  $mX+b$  for  $mX+b$  math operation and the present scale factor M will be displayed:  
M: +1.00000 $\Delta$
2. Use the  $\leftarrow$  and  $\rightarrow$  keys to select the cursor position and use  $\blacktriangle$  and  $\blacktriangledown$  keys to increment or decrement the selected digits respectively. When the cursor position selects " $\Delta$ ", the up and down arrow keys can be used to move the decimal place left or right of its current position.
3. Press  $\text{Auto}$  (ENTER) to confirm the M value and the message "**CHANGE SAVED**" will be displayed for a moment and then the present B value will be displayed. "m" is the default unit and represents milli ( $10^{-3}$ ).  
B: +0.00000 m
4. Enter a value using the arrow keys, similar to step 2 above.
5. Press  $\text{Auto}$  (ENTER) to confirm the B value, "**CHANGE SAVED**" will be displayed.
6. The multimeter then returns back to the main display and will now show the results of the  $mX+B$  calculation. The right of the display will show MXB.

If you want to change the M and B parameter values after enabling the math function at any time, you can also do the following:

1. Press  $\text{Shift}$   $\rightarrow$  , "**1: SET M**" will be displayed (Submenu level).
2. Press  $\blacktriangledown$  key to enter the parameter level and the present scale factor M will be displayed:  
M: +1.00000 $\Delta$ .
3. Use the  $\leftarrow$  and  $\rightarrow$  keys to select the cursor position and use  $\blacktriangle$  and  $\blacktriangledown$  keys to



## Basic Measurements

increment or decrement the digits respectively. When the cursor position selects “^”, the up and down arrow keys can be used to move the decimal place left or right of its current position.

4. Press **Auto** (ENTER) to confirm the M value and the message “**CHANGE SAVED**” will be displayed for a moment and then multimeter returns back to the submenu level. Press **Trig** (ESC) to cancel the M value input, and the multimeter will return back to the submenu level without changing the M value.
5. Press **▶**, “**2: SET B**” will be displayed (Submenu level).
6. Press **▼** key to enter the parameter level and the present offset factor B will be displayed:  
B: +00.0000 m.
7. Use the **◀** and **▶** keys to select the cursor position and use **▲** and **▼** keys to increment or decrement the digits respectively. Enter a value using the arrow keys.
8. Press **Auto** (ENTER) to confirm the B value. The message “**CHANGE SAVED**” will be displayed for a moment and then the multimeter will return back to the submenu level. Press **Trig** (ESC) to cancel the B value input, and the multimeter will return back to the submenu level without changing the B value.
9. Press **Shift** → **◀** to exit the menu operation and return back to the mX+b calculated display.

### 3.8.2 Percent

When selecting the percent calculation function, a reference value must be specified. The displayed reading will be expressed as the percent deviation from the reference value. The percentage calculation is performed as follows:

$$\text{Percent} = \frac{\text{Input} - \text{Reference}}{\text{Reference}} \times 100\%$$

Where: Input is the normally display actual reading  
Reference is the user-entered constant  
Percent is the displayed result

To configure the percent calculation, perform the following steps:

1. Press **Shift** → **Rel** for percent math operation and the reference value will display as:  
REF: +1.00000^
2. Use the **◀** and **▶** keys to select the cursor position and use **▲** and **▼** keys to increment or decrement the digits respectively. When the cursor position selects “^”, the up and down arrow keys can be used to move the decimal place left or right of its current position.
3. Press **Auto** (ENTER) to confirm the reference value. The message “**CHANGE SAVED**” will be displayed for a moment.
4. The multimeter will display the result of the percent calculation.

If you want to change the parameter values when the percent math function is enabled, you can also do the following:

1. Press **Shift** → **▶** to enter the submenu level, “**3: PERCENT**” will be displayed.
2. Press **▼** to enter the parameter level, and the reference value will be displayed:  
REF: +1.00000^.
3. Use the **◀** and **▶** keys to select the cursor position and use **▲** and **▼** keys to increment or decrement the digits. Enter a value. When the cursor position selects “^”, the up and

## Basic Measurements

down arrow keys can be used to move the decimal place left or right of its current position.

- Press **Auto** (ENTER) to confirm the reference value, "**CHANGE SAVED**" will be displayed for a moment, and the multimeter will return to the submenu level. Press **Trig** (ESC) to cancel the reference value input, and the multimeter will go back to the submenu level without changing the reference value.
- Press **Shift** → **◀** key to exit the menu and return to the percent math operation.

The multimeter will display measurement result of the percent calculation. If the value of "Input" is larger than that of "Reference", displayed result will be positive. Contrarily, it will be negative if the value of "Input" is smaller than that of "Reference".

### 3.8.3 dB Calculation

The 5492B can express AC and DC voltages in dB units. The relationship between dB and voltage is defined by the following equation:

$$\text{dB} = 20 \log \frac{V_{\text{IN}}}{V_{\text{REF}}}$$

Where:  $V_{\text{IN}}$  is the DC or AC input signal

$V_{\text{REF}}$  is the specified voltage reference level

The instrument will read 0dB when the reference voltage level is applied to the input.

If a relative value is in effect when dB is selected, this relative value will be converted to dB value before REL is applied. If REL is applied after dB function has been selected, dB reading will have REL applied to it directly.

To set the reference voltage, perform the following steps:

- Press **Shift** + **mX+b** for dB math operation and the reference value is displayed:  
REF: +0.00000Λ
- Use **◀** and **▶** keys to select cursor position and use **▲** and **▼** keys to increment or decrement the digits respectively. Enter a value.
- Press **Auto** (ENTER) to confirm the reference voltage, and the message "**CHANGE SAVED**" will be displayed for a moment. The multimeter will then return back to the measurement status.
- Now the multimeter will display the result of the dB calculation.

If you want to change the parameter values when dB function is in effect, you can do the following:

- Press **Shift** → **▶** to enter the command level, "**4: dB REF**" will be displayed.
- Press **▼** to enter the parameter level, and the reference value will be displayed:  
REF: +1.00000Λ.
- Use **◀** and **▶** keys to select cursor position and use **▲** and **▼** keys to increment or decrement the digits respectively. Enter a value and units prefix.
- Press **Auto** (ENTER) to confirm the reference value, the message "**CHANGE SAVED**" will be displayed for a moment, and the multimeter will return to the submenu level. Press **Trig** (ESC) to cancel the reference value input, and the multimeter will return back to the submenu level without

changing the reference value.

5. Press **Shift** → **◀** key to exit the menu and return to the dB math operation.

**Notes:** *The dB calculation takes the absolute value of the ratio  $V_{IN}/V_{REF}$ . The largest negative value of dB is -160 dB. This will accommodate a ratio of  $V_{IN} = 1 \mu V$ ,  $V_{REF} = 1000 V$ .*

### 3.8.4 dBm Calculation

dBm is defined as decibels above or below a 1 mW reference. With a user-programmable reference impedance, B&K 5492B reads 0 dBm when the voltage needed to dissipate 1mW through the reference impedance is applied. The relationship between dBm, reference impedance, and the voltage is defined by the following equation:

$$\text{dBm} = 10 \log \frac{(V_{IN}^2 / Z_{REF})}{1\text{mW}}$$

Where:  $V_{IN}$  is the DC or AC input signal voltage value.

$Z_{REF}$  is the specified reference impedance.

If a relative value is in effect when dBm is selected, the relative value will be converted to dBm value before REL is applied. If REL is applied after dBm has been selected, dBm calculation will have REL applied to it directly.

To set the reference impedance, perform the following steps:

1. Press **Shift** → **mX+b**, the voltage reference value for dB math function will be displayed.
2. Press **Auto** (ENTER) to confirm the voltage reference value, now you have selected the dB math function.
3. Press **Shift** → **mX+b** again, and the impedance reference value for dBm math function will be displayed:  
REF: 0075 Ω
4. Use **◀** and **▶** keys to select cursor position and use **▲** and **▼** keys to increment or decrement the digits respectively. Enter a value from 1 Ω to 9999 Ω.
5. Press **Auto** (ENTER) to confirm the reference impedance, and the message “**CHANGE SAVED**” will be displayed for a moment. The multimeter will then return back to the measurement status.
6. Now the meter will display the result of the dBm calculation.

If you want to change the impedance reference value after the dBm function is enabled, you can also do the following:

1. Press **Shift** → **▶** to enter the command level, “**5: dBm REF**” will be displayed.
2. Press **▼** to enter the parameter level, and the current impedance reference value will be displayed:  
REF: +1.0000Λ
3. Use **◀** and **▶** keys to select cursor position and use **▲** and **▼** keys to increment or decrement the digits respectively. Enter a value from 1 Ω to 9999 Ω.

## Basic Measurements

---

4. Press **Auto** (ENTER) to confirm the reference value, and the message “**CHANGE SAVED**” will be displayed for a moment, then the multimeter will return to the submenu level. Press **Trig** (ESC) to cancel the reference value input, and the multimeter will return back to the submenu level without changing the reference value.
5. Press **Shift** → **◀** key to exit the menu and return to the dB math operation.

**NOTE:** *The reference impedance and input impedance mentioned in this chapter are completely different. Input impedance is inherent in the instrument and cannot be changed via foregoing methods.*

*dBm is valid for both positive and negative DC voltage.*

*The  $mX+b$  and percent math operations are applied after the dBm or dB math calculations. For example, if  $mX+b$  is selected with  $m=10$  and  $b=0$ , the display will read 10.000 MXB for a 1 VDC signal. If dBm is selected with ( $Z_{REF} = 50 \Omega$ ), the display will read 130 MXB.*

## Chapter 4 Measurement Options

This chapter is outlined as follows:



- 4.1 Measurement configuration
- 4.2 Trigger Operations
- 4.3 Buffer Operations
- 4.4 Limit Operations
- 4.5 System Operations

### 4.1 Measurement configuration

#### 4.1.1 Range

You can let the multimeter automatically select the range using auto ranging or you can select a fixed range using manual ranging. Auto ranging is convenient because the multimeter automatically selects the appropriate range for each measurement. However, you can use manual ranging for faster measurements since the multimeter will not have to determine which range to use for each measurement. The digital multimeter returns back to auto ranging when power has been off or after a remote interface reset. Note that auto ranging is not available for some measurement functions and ranges.

##### Manual ranging

To select a range, simply press  or  key. The instrument changes one range per key press. The selected range is displayed momentarily before showing the measured readings.

If the instrument displays the “OVR.FLW” message on a particular range, select a higher range until an in-range reading is displayed. Use the lowest range possible without causing an overflow to ensure best accuracy and resolution.

##### Autoranging

To enable auto range, press  key. The **AUTO** annunciator turns on when autoranging is selected. While selected, the instrument automatically chooses the best range to measure the applied signal.

Note that up-ranging occurs at 100% of the range, while down-ranging occurs at 10 % of normal range.

To cancel auto range, press  or  or  key. Pressing  to cancel auto range will leave the instrument in its present range.

The  key has no effect on the continuity and diode test functions.

### 4.1.2 Filter

FILTER lets you set the filter response to stabilize noisy measurements. The multimeter uses a digital filter. The displayed, stored and transmitted readings are simply an average of a number of reading conversions (from 1 to 100).

Perform the following steps to select a filter:

1. Press **Shift** → **◀** to enter the menu on the menu level, “**A: MEAS MENU**” will be displayed.
2. Press **▼** to move down to the submenu level within the MEAS MENU, “**1: CONTINUITY**” will be displayed.
3. Use **◀** or **▶** key to move across to the Filter option on the submenu level, “**2: FILTER**” will be displayed.
4. Press **▼** to move down a level to the filter parameter choice.
5. Using **◀** or **▶** to turn ON or OFF the filter.
6. Press **Auto** (ENTER) to confirm the selection. The message “**CHANGE SAVED**” will be displayed to show that the change is now in effect. The multimeter automatically exits the parameter level and moves up a level to the submenu level.
7. Use **▶** to move across to the filter type option on the submenu level, “**3: FILT TYPE**” will be displayed.
8. Press **▼** to move down a level to the filter type parameter choice.
9. Use **◀** or **▶** to select MOVNG AV (Moving average) or REPEAT filter type.
10. Press **Auto** (ENTER) to confirm the selection. The message “**CHANGE SAVED**” will be displayed to show that the change is now in effect. The multimeter automatically exits the parameter level and moves up a level to the submenu level.
11. Use **▶** to move across to the filter count option on the submenu level, “**4: FILT COUNT**” will be displayed.
12. Press **▼** to move down a level to edit the filter count parameter.
13. Use **◀** and **▶** keys to select cursor position and use **▲** and **▼** keys to increment or decrement the digits respectively. Enter a filter count from 1 to 100.
14. Press **Auto** (ENTER) to confirm the count value. The message “**CHANGE SAVED**” will be displayed to show that the change is now in effect. The meter automatically exits the parameter level and moves up a level to the submenu level.
15. Press **Shift** → **◀** key to exit from the menu and return to the measurement status.
16. The **FILT** annunciator will display when the filter function is ON.

**NOTE:** *The filter cannot be set for frequency, period, continuity and diode test functions.*

### Filter Types

#### A. Moving Average (MOVNG AV)

The Moving average filter uses a first-in, first-out stack. When the stack becomes full, the measurement conversions are averaged, yielding a reading. For each subsequent conversion placed into the stack,

## Measurement Options

the oldest conversion is discarded, and the stack is re-averaged, yielding a new reading. See Figure 4-1 below.

### B. Repeat Average (REPEAT)

For the repeating average filter, the stack is filled and the conversions are averaged to yield a reading. The stack is then cleared and the process starts over as shown in Figure 4-1.

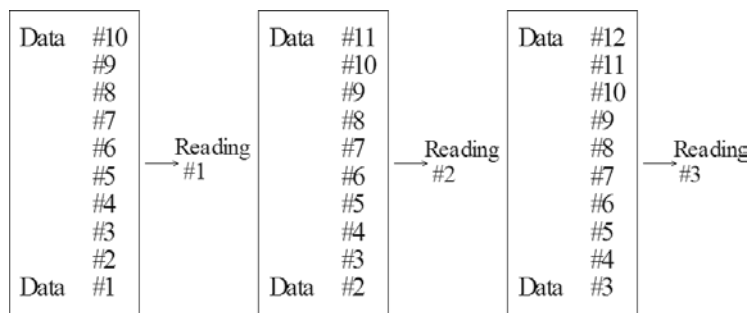

A. Type-Moving average, Filter Count=10

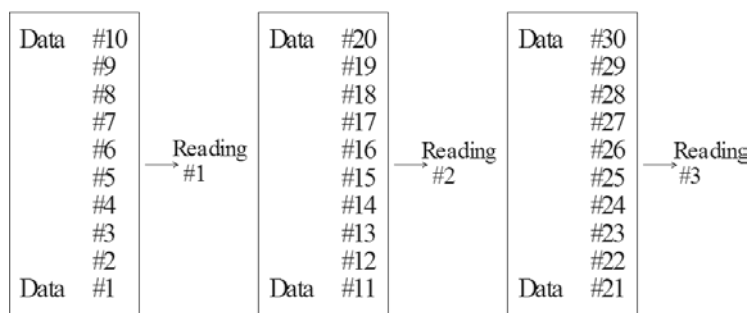

B. Type- Repeat average, Filter Count=10

**Figure 4-1 Moving average and repeating average filters**

### Response Time

The filter parameters have speed and accuracy tradeoffs for the time needed to display, store, or output a filtered reading.

## 4.1.3 Relative

The relative operation can be used to null offsets or subtract a baseline reading from present and future readings. When relative function is enabled, the multimeter uses the present reading as a relative value. Subsequent readings will be the difference between the actual input value and the relative value.

You can define a relative value for each function. Once a relative value is set for a measurement function, the value is the same for all ranges. For example, if 2 V is set as a relative value on the 12 V range, the relative is also 2 V on the 1000 V, 120 V, 1.2 V or 120 mV ranges.

Additionally, when you perform a zero correction for DCV,  $\Omega 2$  or  $\Omega 4$  measurements by enabling REL, the

## Measurement Options

---

displayed offset becomes the reference value. Subtracting the offset from the actual input, the display will be as follows:

$$\text{Displayed reading} = \text{Actual Input} - \text{Reference}$$

Selecting a range that cannot accommodate the relative value does not cause an overflow condition, but it also does not increase the maximum allowable input for that range. For example: on the 1.2 V range, the meter still overflows for a 1.4 V input.

To set a REL value, press  when the display shows the value you want as the relative value. The REL annunciator will display. To disable REL, Press  again.

You can also input a REL value manually using the mX+b function. Set M for 1 and B for any value you want. Please refer to Chapter 3 for details about mX+b function.

### 4.1.4 Rate

The RATE operation sets the integration time of the A/D converter, the period of time the input signal is measured. The integration time affects the usable digits, the amount of reading noise, as well as the reading rate of the instrument. The integration time is specified in parameters based on a number of power line cycles (NPLC), where 1 PLC for 50 Hz is 20 msec.

In general, the fastest integration time (FAST (0.1 PLC) set from the front panel or remote interface) results in increased reading noise and fewer usable digits, while the slowest integration time (10 PLC) provides the best common-mode and normal-mode rejection. In-between settings are a compromise between speed and noise.

The RATE parameters are explained as follows:

#### Fast

FAST sets integration time to 0.1 PLC. Use FAST if speed is of primary importance, however it is at the expense of increased reading noise and fewer usable digits.

#### Medium

Medium sets integration time to 1 PLC. Use Medium when a compromise between noise performance and speed is acceptable.

#### Slow

Slow sets integration time to 10 PLC. SLOW provides better noise performance at the expense of speed.

For the AC functions (ACV, ACI), Rate setting determines the bandwidth setting as below:

<b>Fast</b>	500 Hz~100 kHz
<b>Medium</b>	50 Hz~100 kHz
<b>Slow</b>	5 Hz~100 kHz

**Note:** *The integration time can be set for any measurement function except frequency, period, continuity (FAST) and diode test (MEDium). For frequency and period, it is the equivalent of the gate time, 1 sec.*



## 4.2 Trigger Operations

The multimeter's triggering system allows you to generate triggers either manually, automatically, or externally for taking multiple readings per trigger. The following discusses front panel triggering, programmable trigger delay, and the reading hold feature.

### 4.2.1 Trigger Model

The flowchart below (Figure 4-2) summarizes the triggering process of the instrument.

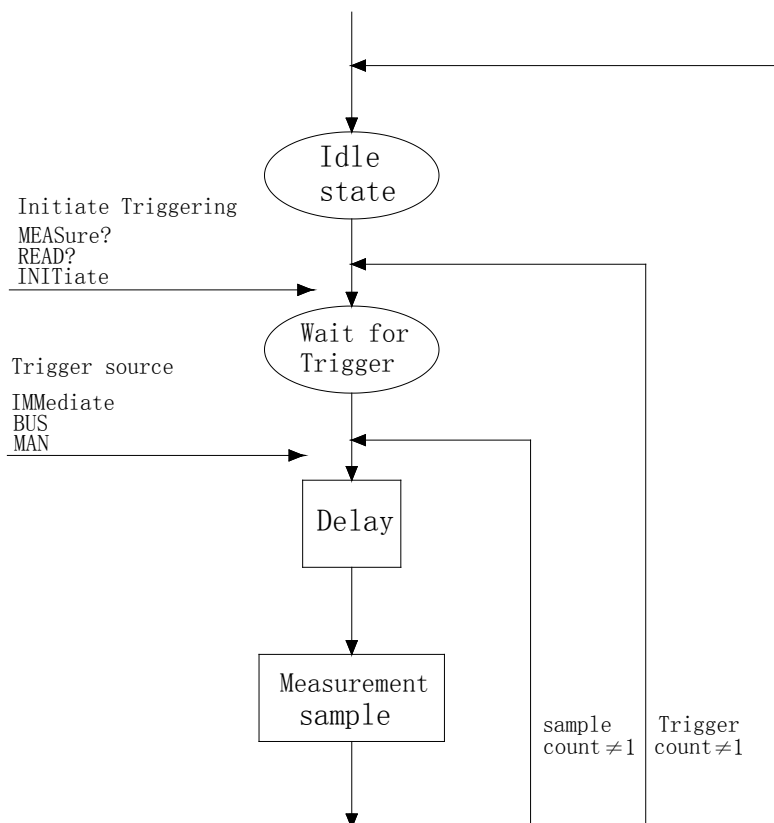

Figure 4-2 Trigger model

#### Idle

The instrument is considered to be in the idle state whenever it is not performing any measurement.

#### Wait for Trigger

The control source holds up operation until the programmable event occurs and is detected. See description below for trigger sources:

- Immediate  
With this trigger source, event detection happens immediately.
- External  
Event detection happens when either of the following takes place:

## Measurement Options

---

1. A bus trigger (\*TRG) command is received via remote control.
2. The front panel  key is pressed (The meter must be in local mode first).

### Trigger Source

The trigger source can be set from the front panel trigger menu. Users can select either IMM, MAN, BUS, or EXT. Description of each are as follows:











**IMM:** Immediate. Event detection happens immediately and will continue making measurement continuously.

**MAN:** Manual. Event detection happens when the front panel  key is pressed. (The unit must already be in local mode first).

**BUS:** Event detection happens with a bus trigger (\*TRG) command is received via remote control.

**EXT:** Event detection happens when an external trigger signal is sent to the EXT TRIG input terminal in the rear panel of the instrument.

To set or change the trigger source, do the following:

1. Press  →  to enter the menu on the menu level, “**A: MEAS MENU**” will be displayed.
2. Use  or  key to move across to the TRIG MENU on the menu level, “**C: TRIG MENU**” will be displayed.
3. Press  to move down to the command level within the TRIG MENU, “**1: TRIG MODE**” will be displayed.
4. Press  to move down a level to select the trigger source.
5. Use  or  to select IMM, MAN, BUS, or EXT trigger source.
6. Press  (ENTER) to confirm the selection. The message “**CHANGE SAVED**” will be displayed to show that the change is now in effect. The meter will then exit the parameter level and move up a level to the command level.
7. Press  →  key to exit from the menu and return to the measurement display.

### Delay

A programmable delay is available after event detection. It can be set manually or automatically. With Auto delay, the meter selects a delay based on the function and range. The AUTO delay settings are listed in Table 4-1 below.

## Measurement Options

**Table 4-1 Auto delay settings**

Function	Range and Delay						
DCV	120mV 1ms	1.2V 1ms	12V 1ms	120V 5ms	1000V 5ms		
ACV	120mV 400ms	1.2V 400ms	12V 400ms	120V 400ms	750V 400ms		
FREQ	120mV 1ms	1.2V 1ms	12V 1ms	120V 1ms	750V 1ms		
DCI	12mA 2ms	120mA 2ms	1.2A 2ms	12A 2ms			
ACI	12mA 400ms		1.2A 400ms	12A 400ms			
$\Omega$ 2W, $\Omega$ 4W	120 $\Omega$ 3ms	1.2k $\Omega$ 3ms	12k $\Omega$ 13ms	120k $\Omega$ 25ms	1.2M $\Omega$ 100ms	12M $\Omega$ 150ms	120M $\Omega$ 250ms
Continuity		1k $\Omega$ 3ms					
Diode testing		1mA 1ms	100uA 1ms	10uA 1ms			

To set the delay manually, follow the below steps:

8. Press **Shift** → **←** to enter the menu on the menu level, "**A: MEAS MENU**" will be displayed.
9. Use **←** or **→** key to move across to the TRIG MENU on the menu level, "**C: TRIG MENU**" will be displayed.
10. Press **▼** to move down to the command level within the TRIG MENU, "**1: TRIG MODE**" will be displayed.
11. Use **→** to move across to the TRIG DELAY command on the command level, "**2: TRIG DELAY**" will be displayed.
12. Press **▼** to move down a level to set the type of delay mode.
13. Using **←** or **→** to select AUTO or MANU (Manual) delay mode.
14. Press **Auto** (ENTER) to confirm the choice. The message "**CHANGE SAVED**" will be displayed to show that the change is now in effect. If AUTO mode is selected, the multimeter will exit the parameter level and move up a level to the command level.
15. If MANU mode is selected, a delay time will need to be specified. The screen will display like below to show the current manual trigger delay value:  
 DELAY: 0000mS
16. Use **←** and **→** keys to choose a numerical place and use **▲** and **▼** keys to increment or decrement the digits. Enter a value for delay time (0 to 6000 ms).
17. Press **Auto** (ENTER) to confirm the delay time. The message "**CHANGE SAVED**" will be displayed to show that the change is now in effect. The multimeter will automatically exit the parameter level and move up a level to the command level.
18. Press **Shift** → **←** key to exit from the menu and return to the measurement display.

**Note:** *Changing the trigger delay to MANU (Manual) on any function changes the same for all other functions.*

## 4.2.2 EXT Trig & VM Comp

The rear panel of the instrument has two BNC terminals: Ext Trig and VM Comp. This section describes the functionality of these two terminals.

### Ext Trig

This is the external trigger input terminal. When trigger mode is set to EXT, this terminal can be used as the source for triggering a measurement. Input a negative pulse into this terminal to trigger the instrument. The pulse width must be greater than 1  $\mu$ s. An example is illustrated in Figure 4-3 below.

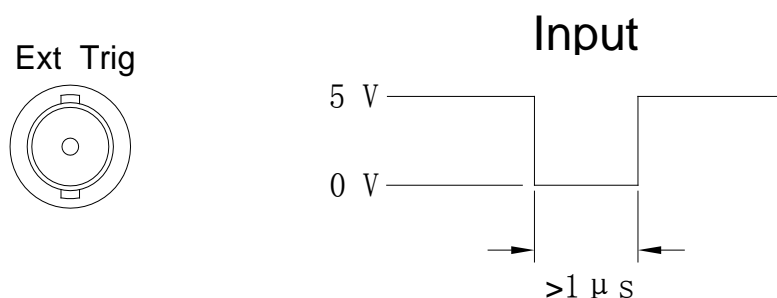

Figure 4-3 Trigger model

### VM Comp

This is the voltmeter complete output terminal. When the instrument completes its present measurement, a voltmeter complete output signal will output from this terminal as shown in Figure 4-4 below.

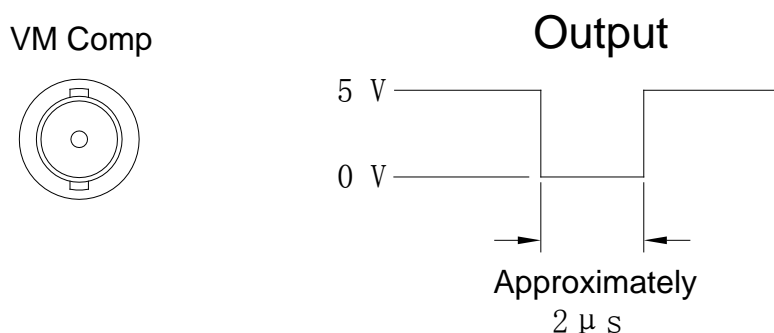

Figure 4-4 Trigger model

## 4.3 Buffer Operations

The 5492B has an internal buffer to store 2 to 512 readings. In addition, the buffer includes statistical information based on the stored readings such as the minimum reading, maximum reading, average based on the stored readings, and standard deviation of the stored readings (See section "4.3.3 Buffer Statistics" for details).

The buffer fills up with the requested number of readings and then stops. Readings are then placed into the buffer and can be read back via front panel or remote operation. Buffered data is overwritten each time the reading store function is turned enabled (ON) and initiated. The data is volatile; it is not

saved through a power cycle.

Note: Readings will not include the function (i.e. VDC, VAC, Frequency, etc.) or the unit of measurement (i.e. V, A, Hz,  $\Omega$ , etc.) selected prior to storing into the buffer.

### 4.3.1 Store Reading

Select a measurement function and any math operations first, then connect the test leads to the signal under test. Setup the reading speed (FAST, MED, SLOW), then use the following procedure to store readings:

1. Press **Shift** → **Left Arrow** to enter the menu on the menu level, "**A: MEAS MENU**" will be displayed.
2. Use **Left Arrow** or **Right Arrow** key to move across to the SYS MENU on the menu level, "**D: SYS MENU**" will be displayed.
3. Press **Down Arrow** to move down to the command level within the SYS MENU, "**1: RDGS STORE**" will be displayed.
4. Press **Down Arrow** to move down a level to set RDGS STORE function.
5. Use **Left Arrow** or **Right Arrow** key to set reading store function to ON or OFF.
6. Press **Auto** (ENTER) to confirm the ON/OFF selection. The message "**CHANGE SAVED**" will be displayed to show that the change is now in effect. The meter will automatically exit the parameter level and move up a level to the command level.
7. At this time, a "\*" annunciator will light up on the display (This may not light up if the number of readings to store has not been specified or if it is 000. Continue to the next step to set this up). This indicates that the instrument is ready to store readings into the buffer. If the user decides to turn it off at this moment, do not exit the menu system. Instead, follow step 5-7 again, with reading store function set to OFF in step 6.
8. Use **Right Arrow** to move across to the RDGS COUNT command on the command level, "**2: RDGS COUNT**" will be displayed.
9. Press **Down Arrow** to move down a level to edit the number of readings to store into buffer.
10. Use **Left Arrow** and **Right Arrow** keys to choose a numerical place and use **Up Arrow** and **Down Arrow** keys to increment or decrement the digits. Enter a number between 2 to 512.
11. Press **Auto** (ENTER) to confirm the number of readings to store. The message "**CHANGE SAVED**" will be displayed to show that the change is now in effect. The multimeter will exit the parameter level and move up a level to the command level.
12. If you did not see a "\*" indicator on display in step 7, you will see it now after the number of readings for RDGS COUNT parameter has been set to a number (2 to 512).
13. Press **Shift** → **Left Arrow** key to exit from the menu, and readings will immediately start storing into the buffer.
14. Notice the "\*" annunciator is still lid. At this point, it will stay lid until the specified number of readings are stored into the buffer. During this time, do not push any keys to interrupt the instrument from storing readings into the buffer.

**Note:** When the instrument completes the storage of readings into the buffer, the reading store function (1: RDGS STORE) parameter within the system menu will automatically set back to OFF. To store readings again, go into the system menu and set this parameter back to ON.

**Warning:** Readings inside the buffer are volatile. Therefore do not power off the instrument or data will be lost. Additionally, each time the store reading function is enabled and initialized, previously stored data in the buffer will be overwritten.

### 4.3.2 Recall Readings

Use the following steps to recall the stored readings and their statistical information (minimum, maximum, average, and standard deviation):

1. Press **Shift** → **Left Arrow** to enter the menu on the menu level, “**A: MEAS MENU**” will be displayed.
2. Use **Left Arrow** or **Right Arrow** key to move across to the SYS MENU on the menu level, “**D: SYS MENU**” will be displayed.
3. Press **Down Arrow** to move down to the command level within the SYS MENU, “**1: RDGS STORE**” will be displayed.
4. Use **Left Arrow** or **Right Arrow** key to move across to the SAVED RDGS command, “**3: SAVED RDGS**” will be displayed.
5. Press **Down Arrow** to move down a level to view the stored readings. “**MEM**” annunciator will turn on to indicate the instrument accessing buffer memory. If no readings are stored, a “**BUFFER EMPTY**” message will be displayed for a few seconds.
6. Use **Left Arrow** or **Right Arrow** key to navigate through the readings. The display may look like any of the following when browsing through all the stored readings:

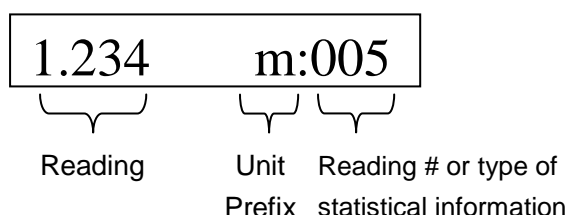

**Reading:** Stored reading value

**Unit Prefix:** The unit prefix that applies to the Reading. This can be m ( $10^{-3}$ ), u ( $10^{-6}$ ), n ( $10^{-9}$ ), or blank.

**Reading # or type of statistical**

**information:** Indicates the reading # or count that corresponds to the Reading. This can be any number from 001 – 512. Additionally, this can display the type of statistical information in which the Reading corresponds with. This can be MAX, MIN, AVG, or STD (See section “4.3.3 Buffer Statistics” for details).

7. Use the function keys or press **Shift** → **Left Arrow** to exit from the menu and return to measurement mode.

**Warning:** Readings inside the buffer are volatile. Therefore do not power off the instrument or data will be lost. Additionally, each time the store reading function is enabled and initialized, previously stored data in the buffer will be overwritten.

### 4.3.3 Buffer Statistics

In addition to measured readings that can be stored into the internal buffer, four other statistical information of the stored readings are also kept inside the buffer. They are: MAX, MIN, AVG, STD.

#### MAX and MIN

The MAX and MIN refer to the maximum and minimum value of the readings stored in the buffer respectively.

For example, suppose the buffer contains the following five readings: 1.234, 2.345, 3.456, 4.567, 5.678.

MAX = 5.678

MIN = 1.234

#### AVR

AVR stands for average. The AVR value is the mean(average) of the buffered readings. The equation used to calculate this is:

$$y = \frac{\sum_{i=1}^n X_i}{n}$$

Where:  $X_i$  is a stored reading

$n$  is the number of stored readings

For example, suppose the buffer contains the following five readings: 1.234, 2.345, 3.456, 4.567, 5.678.

AVG = 3.456

#### STD

The STD value is the standard deviation of the buffered readings. The equation used to calculate the standard deviation is:

$$y = \sqrt{\frac{\sum_{i=1}^n x_i^2 - \left(\frac{1}{n}(\sum_{i=1}^n x_i)^2\right)}{n - 1}}$$

Where:  $X_i$  is a stored reading

$n$  is the number of stored readings

## 4.4 Limit Operations

Limit operations set and control the values that determine the HI / IN / LO status of subsequent measurements. Limits can be applied to all measurement functions except continuity. The limit test is performed after mX+b and percent math operations. Unit prefixes are applied before the limit test, for example:

Low Limit = -1.0, High Limit = 1.0

A 150mV reading becomes 0.15V (IN).

Low Limit = -1.0, High Limit = 1.0

## Measurement Options

---

A 0.6k $\Omega$  reading becomes 600 $\Omega$  (HI).

When the reading is within the configured limit range specified by low and high limits, "IN" will be shown after measured display. If it is higher than the limit range, "HI" will be shown after the measured display. Similarly, if it is lower than the limit range, "LO" will be shown. You can configure the multimeter to beep or not when readings are outside of the limit range.

### 4.4.1 Enabling limits

Use the following procedure to turn on the limit operation:

1. Press **Shift** → **Left Arrow** to enter the menu on the menu level, "**A: MEAS MENU**" will be displayed.
2. Use **Left Arrow** or **Right Arrow** key to move across to the MATH MENU on the menu level, "**B: MATH MENU**" will be displayed.
3. Press **Down Arrow** to move down to the command level within the MATH MENU, "**1: SET M**" will be displayed.
4. Use **Left Arrow** or **Right Arrow** key to move across to the LIMIT TEST command, "**6: LIMIT TEST**" will be displayed.
5. Press **Down Arrow** to move down a level to set LIMIT TEST function to ON.
6. Press **Auto** (ENTER) to confirm the set of LIMIT TEST function. The message "**CHANGE SAVED**" will be displayed to show that the change is now in effect.
7. Press **Shift** → **Left Arrow** key to exit from the menu.
8. When the multimeter returns to the measurement display, the HI/IN/LO status will be displayed along with the reading. If the reading is within the range specified by the high and low limits (configured in the next section), it will show "IN". If higher than the range, it will show "HI". If lower than the range, it will show "LO".

### 4.4.2 Setting Limit Values

Follow the below steps to configure high and low limits for limit operation:

1. Press **Shift** → **Left Arrow** to enter the menu on the menu level, "**A: MEAS MENU**" will be displayed.
2. Use **Left Arrow** or **Right Arrow** key to move across to the MATH MENU on the menu level, "**B: MATH MENU**" will be displayed.
3. Press **Down Arrow** to move down to the command level within the MATH MENU, "**1: SET M**" will be displayed.
4. Use **Left Arrow** or **Right Arrow** key to move across to the HIGH LIMIT command, "**7: HIGH LIMIT**" will be displayed.
5. Press **Down Arrow** to move down a level to input the high limit value. The current high limit value will be displayed:  
HI: +1.00000 $\Lambda$
6. Use **Left Arrow** and **Right Arrow** keys to choose a numerical place and use **Up Arrow** and **Down Arrow** keys to increment or decrement the digits. Enter a high limit value.
7. Press **Auto** (ENTER) to confirm the value of high limit. The message "**CHANGE SAVED**" will be displayed to show that the change is now in effect.



## Measurement Options

---

8. Use  or  key to move across to the LOW LIMIT command, "**8: LOW LIMIT**" will be displayed.
9. Press  to move down a level to input the low limit value. The current low limit value will be displayed:  
LO: -1.00000Λ
10. Use  and  keys to choose a numerical place and use  and  keys to increment or decrement the digits. Enter a low limit value.
11. Press  (ENTER) to confirm the value of low limit. The message "**CHANGE SAVED**" will be displayed to show that the change is now in effect.
12. Press  →  key to exit from the menu.

### 4.4.3 Configure Limit Beep

Users can configure the multimeter to make a beep sound upon specified conditions when using limit operation. Follow the below steps to configure:

1. Press  →  to enter the menu on the menu level, "**A: MEAS MENU**" will be displayed.
2. Use  or  key to move across to the MATH MENU on the menu level, "**B: MATH MENU**" will be displayed.
3. Press  to move down to the command level within the MATH MENU, "**1: SET M**" will be displayed.
4. Use  or  key to move across to the LIMIT BEEP command, "**9: LIMIT BEEP**" will be displayed.
5. Press  to move down a level to select the condition in which the meter should make a beep sound when using limit operation. The display should show "**ALARM:**" with the current selection blinking.
6. Use  and  keys to choose between one of the following:
  - NEVER: Never beep regardless of the limit status (HI, LO, IN).
  - HI: Beep only when the reading is HI (Reading is above the high limit).
  - IN: Beep only when the reading is within the range specified by high and low limits.
  - LO: Beep only when the reading is LO (Reading is below the low limit).
  - OUT: Beep only when the reading is HI or LO.
7. Press  (ENTER) to confirm the value of high limit. The message "**CHANGE SAVED**" will be displayed to show that the change is now in effect.

## 4.5 System Operations

There are some system settings that can be configured on the 5492B multimeter, which include beeper control, saving and restoring instrument settings, front panel display control, key sound control, self-test, and calibration. The following sections will describe in details each of these settings.

### 4.5.1 Beeper Control

Under default settings, the multimeter will emit a beep tone whenever certain conditions are met. This beep can be disabled by the user.

- When you disable the beeper, the multimeter will not emit a tone when:
  1. A limit is exceeded in a limit test
- Disabling the beeper has no effect on the tone generated when:
  1. An internal error is generated.
  2. The continuity threshold is exceeded.
  3. A front panel key is pressed (This is controlled by KEY SOUND CONTROL setting).
- The beeper state is stored in non-volatile memory and does not change when power has been off or after a reset.

Use the following steps to change the beeper's state:

1. Press **Shift** → **◀** to enter the menu on the menu level, "**A: MEAS MENU**" will be displayed.
2. Use **◀** or **▶** key to move across to the SYS MENU on the menu level, "**D: SYS MENU**" will be displayed.
3. Press **▼** to move down to the command level within the SYS MENU, "**1: RDGS STORE**" will be displayed.
4. Use **◀** or **▶** key to move across to the BEEP command, "**4: BEEP**" will be displayed.
5. Press **▼** to move down a level to set the beeper control.
6. Use **◀** or **▶** key to select ON or OFF.
7. Press **Auto** (ENTER) to confirm the beeper control. The message "**CHANGE SAVED**" will be displayed to show that the change is now in effect.
8. Press **Shift** → **◀** key to exit from the menu.

### 4.5.2 Save Settings







The 5492B allows user to save up to 10 instrument settings. These settings are saved as files in non-volatile memory (10 files: FILE-0 – FILE-9). Files will not be lost when the instrument is powered off. These settings can be restored at any time after power on. The settings that can be stored in each file are the same settings listed under the default settings. Refer to section "2.6.4 Power-on Defaults" for details.

To save settings, first setup the instrument with the settings you want to save. Then, follow the steps below:

1. Press **Shift** → **◀** to enter the menu on the menu level, "**A: MEAS MENU**" will be displayed.
2. Use **◀** or **▶** key to move across to the SYS MENU on the menu level, "**D: SYS MENU**" will be displayed.
3. Press **▼** to move down to the command level within the SYS MENU, "**1: RDGS STORE**" will be displayed.
4. Use **◀** or **▶** key to move across to the SAVE CNFG command, "**5: SAVE CNFG**" will be displayed.













## Measurement Options

---

5. Press  to move down a level to select a file to save.
6. Use  or  key to select a file from FILE-0 to FILE-9.
7. Press  (ENTER) to save the present setting to the selected file. The message “**FILE SAVING**” will display when saving is in progress. Once completed, “**SAVE SUCCEED**” will be displayed.
8. Press  →  key to exit from the menu.

### 4.5.3 Restore Settings

To recall previously saved settings (stored in FILE-0 to FILE-9), or to restore factory default settings, follow the below steps:

1. Press  →  to enter the menu on the menu level, “**A: MEAS MENU**” will be displayed.
2. Use  or  key to move across to the SYS MENU on the menu level, “**D: SYS MENU**” will be displayed.
3. Press  to move down to the command level within the SYS MENU, “**1: RDGS STORE**” will be displayed.
4. Use  or  key to move across to the LOAD CNFG command, “**6: LOAD CNFG**” will be displayed.
5. Press  to move down a level to select a file to restore.
6. Use  or  key to select “FACT” to restore factory default settings. To restore user saved settings, select one of the “FILE-#” locations that contain the settings you want to restore (FILE-0 to FILE-9).
7. Press  (ENTER) to restore the selected setting. The message “**FILE LOADING**” and “**LOAD SUCCEED**” will be displayed.
8. Press  →  key to exit from the menu.









### 4.5.4 Display Control

To speed up measurement rate for remote control, the 5492B allows the user to turn off the front panel display.

When the front panel display is turned off, readings are not sent to the display. Some annunciators will still stay lid. Front panel operation is unaffected by turning off the display.





The display will be enabled again after a power on/off or after a remote interface reset.

To control the display settings, follow the below steps:

1. Press  →  to enter the menu on the menu level, “**A: MEAS MENU**” will be displayed.
2. Use  or  key to move across to the SYS MENU on the menu level, “**D: SYS MENU**” will be displayed.
3. Press  to move down to the command level within the SYS MENU, “**1: RDGS STORE**” will be displayed.
4. Use  or  key to move across to the DISPLAY command, “**7: DISPLAY**” will be displayed.
5. Press  to move down a level to set the display control.

## Measurement Options













---

6. Use  or  key to select ON or OFF for the front panel display.
7. Press  (ENTER) to confirm the selection. The message “**CHANGE SAVED**” will be displayed to show that the change is now in effect.
8. Press  →  key to exit from the menu.

### 4.5.5 Key Sound











The multimeter by default is shipped with beep sound enabled when keys are pressed. This can be set to ON or OFF by the user.



Follow the steps below to set the key sound settings:

1. Press  →  to enter the menu on the menu level, “**A: MEAS MENU**” will be displayed.
2. Use  or  key to move across to the SYS MENU on the menu level, “**D: SYS MENU**” will be displayed.
3. Press  to move down to the command level within the SYS MENU, “**1: RDGS STORE**” will be displayed.
4. Use  or  key to move across to the KEY SOUND command, “**8: KEY SOUND**” will be displayed.
5. Press  to move down a level to enable or disable the key sound.
6. Use  or  key to turn ON or turn OFF the key sound.
7. Press  (ENTER) to confirm the selection. The message “**CHANGE SAVED**” will be displayed to show that the change is now in effect.
8. Press  →  key to exit from the menu.

### 4.5.6 Self-test

The multimeter has a built-in self-test routine that is processed during an initial power up of the instrument. Additionally, two other self-test routines can be run from the front panel. To do this, follow the below steps:

1. Press  →  to enter the menu on the menu level, “**A: MEAS MENU**” will be displayed.
2. Use  or  key to move across to the SYS MENU on the menu level, “**D: SYS MENU**” will be displayed.
3. Press  to move down to the command level within the SYS MENU, “**1: RDGS STORE**” will be displayed.
4. Use  or  key to move across to the KEY SOUND command, “**9: TEST**” will be displayed.
5. Press  to move down a level to select the self-test to run.
6. Use  or  key to select “KEY” (tests the keys) or “BUILT-IN” self-test.
7. Press  (ENTER) to confirm the selection.

If “KEY” is selected, it will initially display a message “**NO KEY PRESS**”. At this point, pressing any keys will display the key’s function. For example, pressing  will display “**LEFT PRESS**” message. To exit the key self-test. Press  button. After it displays “**SHIFT PRESS**”

## Measurement Options

---

message, it will return to the parameter level for selecting self-test.

If "BUILT-IN" is selected, the unit will run an internal self-test. This will take approximately 10-15 seconds. After completion, the message "TEST PASS" will display if no errors occur during the self-test.

8. Press  →  key to exit from the menu.

### 4.5.7 Calibration

B&K Precision recommends a calibration period of once a year.

**Note:** *To prevent corruption of the calibration data stored in non-volatile memory of the instrument, only authorized service center or qualified individuals may proceed with calibrating the instrument.*

Please contact B&K Precision for information about instrument calibration.

# Chapter 5 Remote Operation

This chapter is outlined as follows:

- 5.1 Selecting an Interface**
- 5.2 USB & RS-232 Interface Operation**
- 5.3 GPIB Interface operation**
- 5.4 Data Format**

The 5492B supports remote control over the USB (virtual com), RS-232, and GPIB interface located in the rear panel. You can use only one interface at a time. Standard Commands for Programmable Instruments (SCPI) is supported by these interfaces (unless otherwise noted), however they use different hardware configurations and communication protocols.

## 5.1 Selecting an Interface

The 5492B supports the following interfaces for remote communication:

- USB (virtual COM) device interface
- RS-232 interface
- GPIB bus interface (optional) (model 5492BGPIB)

You can only use one interface at a time for remote communication. USB & RS232 interfaces are selected as the default factory setting. You can select the interface from the front panel menu system. The interface selection is stored in non-volatile memory and does not change from a power on/off or instrument reset.

### 5.1.1 USB (Virtual COM) Interface

The USB device interface on this instrument is a USB virtual COM. After installing the appropriate USB drivers, the instrument will be recognized and assigned to a COM port automatically by the PC as if it's a RS-232 serial interface. Aside from installing drivers, the setup and operation is the same as RS-232 serial interface, which is described in details in the following sections.

#### Installing USB Driver

To install the USB driver, visit [www.bkprecision.com](http://www.bkprecision.com) and go to the product page to download the driver. The drivers are managed and updated by a third-party, so check B&K Precision's website for the latest version.

### 5.1.2 RS-232 Serial Interface

Perform the following steps to select the USB and RS-232 interface for remote communication:

1. Press **Shift** → **◀** to enter the menu on the menu level, "**A: MEAS MENU**" will be displayed.
2. Use **◀** or **▶** key to move across to the I/O MENU on the menu level, "**E: I/O MENU**" will be displayed.
3. Press **▼** to move down to the command level within the I/O MENU, "**1: GPIB ADDR**" will be displayed.
4. Use **◀** or **▶** key to move across to the INTERFACE command, "**2: INTERFACE**" will be displayed.
5. Press **▼** to move down a level to select an interface.
6. Use **◀** or **▶** key to select "USB.RS232" option as the interface.
7. Press **Auto** (ENTER) to confirm the selection. The message "**CHANGE SAVED**" will be displayed to show that the change is now in effect.
8. Press **Shift** → **◀** key to exit from the menu.

### 5.1.3 GPIB Interface (model 5492BGPIB only)

**Note:** *GPIB interface is only available on model 5492BGPIB.*

Perform the following steps to select the GPIB interface for remote communication:

1. Press **Shift** → **◀** to enter the menu on the menu level, "**A: MEAS MENU**" will be displayed.
2. Use **◀** or **▶** key to move across to the I/O MENU on the menu level, "**E: I/O MENU**" will be displayed.
3. Press **▼** to move down to the command level within the I/O MENU, "**1: GPIB ADDR**" will be displayed.
4. Use **◀** or **▶** key to move across to the INTERFACE command, "**2: INTERFACE**" will be displayed.
5. Press **▼** to move down a level to select an interface.
6. Use **◀** or **▶** key to select "GPIB" option as the interface.
7. Press **Auto** (ENTER) to confirm the selection. The message "**CHANGE SAVED**" will be displayed to show that the change is now in effect.
8. Press **Shift** → **◀** key to exit from the menu.

## 5.2 USB & RS-232 Interface Operation

### 5.2.1 RS-232 Connection

The RS-232 interface on this instrument uses a 9-pin DB9 connector. The pin outs are defined below in Table 5-1:

**Table 5-1 RS-232 Pin Out**

Function	Code	9 Pin Connector Pin Number
Transmitted Data	TXD	3
Received Data	RXD	2
Signal Ground Common	GND	5

Figure 5-1 shows the rear panel connector for the RS232 interface.

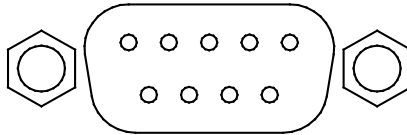

**Figure 5-1 Rear Panel RS232 Interface**

**Note:** To interface with a serial port on a computer with the RS232 interface, use a **NULL MODEM** or **CROSS OVER** serial DB-9 female to female cable. **Do NOT** use a straight-through serial DB-9 cable. To check that you have the correct cable, probe pin 2 on one end and pin 3 on the other and vice versa to check continuity.

Below is a pin connection diagram between 5492B and a computer (Figure 5-2):

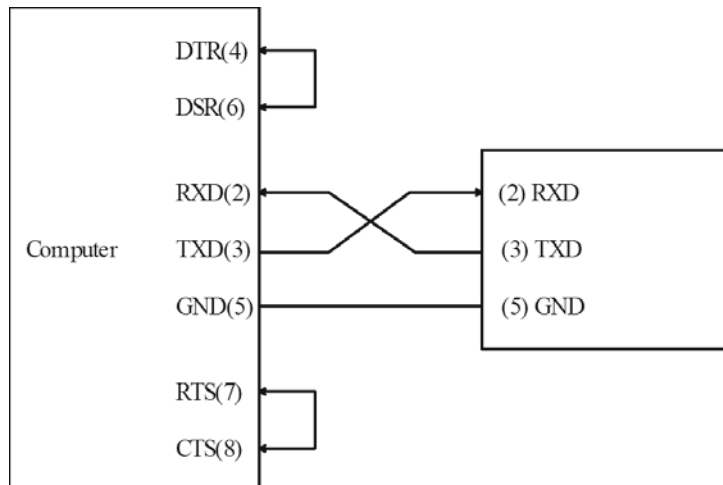

**Figure 5-2 RS-232 Connection Sketch**

**Note:** Pin 4 and 6, pin 7 and 8 are shorted respectively at the end of the controller.



### 5.2.2 Sending and receiving data

The multimeter uses the following settings for USB(virtual com) and RS-232 interface:

**Data bits: 8**

**Stop bit: 1**

**Parity: None, Even, Odd (selectable from menu)**

**Flowcontrol: None**

**Termination character: LF (Line Feed; 0x0A; \n), CR (Carriage Return; 0x0D; \r), or LFCR (Line Feed and Carriage Return) (Selectable from menu)**

### 5.2.3 Selecting Baud Rate

The multimeter supports the following baudrates: **115200 (115.2K), 57600 (57.6K), 38400 (38.4K), 19200 (19.2K), 9600, 4800, 2400**

***Note:** Factory default baud rate is 9600. Although baudrates 115200 (115.2K) and 57600 (57.6K) are selectable, B&K Precision does not recommend using them for fast repetitive remote communication as instability and chances of transmission error may increase.*

Perform the following steps to select a baud rate:

1. Press **Shift** → **Left Arrow** to enter the menu on the menu level, "**A: MEAS MENU**" will be displayed.
2. Use **Left Arrow** or **Right Arrow** key to move across to the I/O MENU on the menu level, "**E: I/O MENU**" will be displayed.
3. Press **Down Arrow** to move down to the command level within the I/O MENU, "**1: GPIB ADDR**" will be displayed.
4. Use **Left Arrow** or **Right Arrow** key to move across to the BAUD RATE command, "**3: BAUD RATE**" will be displayed.
5. Press **Down Arrow** to move down a level to set the baud rate.
6. Use **Left Arrow** or **Right Arrow** key to select a baud rate. Available options are: 115.2K, 57.6K, 38.4K, 19.2K, 9600, 4800, 2400.
7. Press **Auto** (ENTER) to confirm the selection. The message "**CHANGE SAVED**" will be displayed to show that the change is now in effect.
8. Press **Shift** → **Left Arrow** key to exit from the menu.

### 5.2.4 Selecting Parity Mode









The multimeter supports the following parity: **NONE, EVEN, ODD.**

Perform the following steps to select a Parity mode:

1. Press **Shift** → **Left Arrow** to enter the menu on the menu level, "**A: MEAS MENU**" will be displayed.
2. Use **Left Arrow** or **Right Arrow** key to move across to the I/O MENU on the menu level, "**E: I/O MENU**" will be displayed.

## Remote Operation













---

3. Press  to move down to the command level within the I/O MENU, “1: GPIB ADDR” will be displayed.
4. Use  or  key to move across to the PARITY command, “4: PARITY” will be displayed.
5. Press  to move down a level to set the parity mode.
6. Use  or  key to select a parity mode. Available options are: NONE, EVEN, ODD.
7. Press  (ENTER) to confirm the selection. The message “CHANGE SAVED” will be displayed to show that the change is now in effect.
8. Press  →  key to exit from the menu.

### 5.2.5 Selecting Terminal Character

There are three selectable configurations for terminal characters: **LF, CR, LFCR (Asserts both LF and CR character)**

Perform the following steps to select the terminal characters:





1. Press  →  to enter the menu on the menu level, “A: MEAS MENU” will be displayed.
2. Use  or  key to move across to the I/O MENU on the menu level, “E: I/O MENU” will be displayed.
3. Press  to move down to the command level within the I/O MENU, “1: GPIB ADDR” will be displayed.
4. Use  or  key to move across to the terminal character command, “5: TX TERM” will be displayed.
5. Press  to move down a level to set the terminal character.
6. Use  or  key to select a terminal character. Available options are: LF, CR, LFCR.
7. Press  (ENTER) to confirm the selection. The message “CHANGE SAVED” will be displayed to show that the change is now in effect.
8. Press  →  key to exit from the menu.

### 5.2.6 Selecting Echoing

The instrument allows you to enable or disable echoing. Echoing allows the instrument to respond or echo back the command string that was sent to the instrument. For example, sending the command string “\*IDN?” will return both “\*IDN?” and the query string “5492B Digital Multimeter, Version#, serial#”. This can be used as a software handshake to verify that the instrument has received the command string correctly.









**Note:** *This function is for USB (virtual com) and RS-232 interface only.*

Perform the following steps to enable or disable echoing.

1. Press  →  to enter the menu on the menu level, “A: MEAS MENU” will be displayed.
2. Use  or  key to move across to the I/O MENU on the menu level, “E: I/O MENU” will be displayed.

## Remote Operation

---

3. Press  to move down to the command level within the I/O MENU, "1: GPIB ADDR" will be displayed.
4. Use  or  key to move across the menu to display "6: RETURN".
5. Press  to move down a level to set the return on or off.
6. Use  or  key to select ON or OFF to enable or disable echoing respectively.
7. Press  (ENTER) to confirm the selection. The message "CHANGE SAVED" will be displayed to show that the change is now in effect.
8. Press  →  key to exit from the menu.

### 5.2.7 Software Protocol

Since the hardware handshaking lines CTS and RTS are not used by the 5492B, the multimeter can be setup to use the character return (echoing) function as a software handshake to decrease data losses and errors during communication. Please refer to the content below before remote programming.

1. For remote commands syntax and format, refer to the next chapter for details.
2. The controller (interfacing software or application) transmits the command using ASCII code with <LF>, <CR> or <LF><CR> as the termination character. The multimeter executes the command after the termination character is received.
3. The character received by the multimeter will be sent back to the controller again. The controller will not send the next character until the last returned character is received correctly from the multimeter. If the controller fails to receive the character sent back by the multimeter, it could be any of the reasons listed below:
  - The serial interface is not connected correctly.
  - Check if the RS232 function is enabled. Check that the same baud rate is configured on both the instrument and the controller.
  - When the multimeter is busy with executing a bus command, it will not accept any character from the serial interface at the same time. So the character sent by controller will be ignored. In order to make sure the whole command is sent and received correctly, the character without a return character (if echoing is enabled) should be sent again by the controller.
4. The multimeter only sends information under the following two conditions. The first is when a character is received normally; the multimeter will send the character back as a response when return function (echoing) is ON. The second is when a query command is received; the multimeter will send the query response information.
5. A query response is sent out in ASCII code and includes terminal character.
6. For some commands that will take a long time to execute, for example reset command, the controller should keep waiting to avoid the next command from being lost when the multimeter executes it.

## 5.3 GPIB Interface operation (model 5492BGPIB only)

### 5.3.1 GPIB Connection

When configuring a GPIB system, the following restrictions must be adhered to.

- The total length of cable in one bus system must be less than or equal to two meters times the number of devices connected on the bus (the GPIB controller counts as one device) and the total length of cable must not exceed 20 meters.
- A maximum of 15 devices can be connected on one bus system.
- There are no restrictions on how the cables are connected together. However, it is recommended that no more than four piggyback connectors be stacked together on any one device. The resulting structure could exert enough force on the connector mounting to damage it.

Figure 5-3 shows the GPIB interface on the rear panel of the 5492BGPIB.

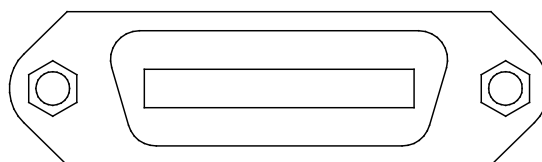

Figure 5-3 Rear Panel GPIB Interface

To allow many parallel connections to one instrument, stack the connector. Two screws are located on each connector to ensure that connections remain secure. Figure 5-4 shows a typical GPIB system interconnection.

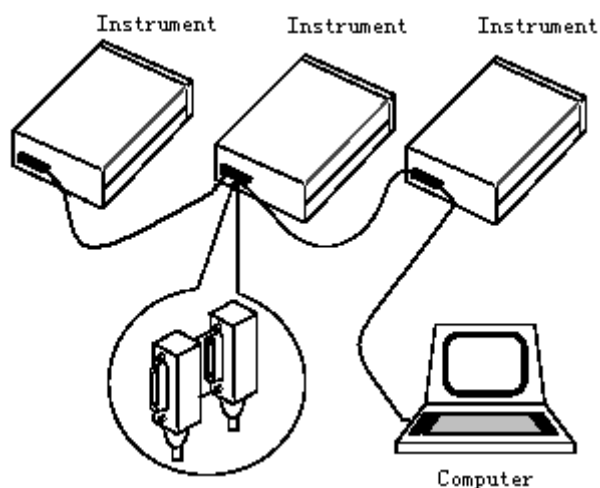

Figure 5-4 Typical GPIB System Interconnection

### 5.3.2 GPIB Interface Capability

Table 5-3 lists the multimeter's GPIB capabilities and functions. These functions provide the mean for an instrument to receive, process, and transmit commands, data, and status over the GPIB bus.

**Table 5-3 GPIB interface Capability**

Code	Function
SH1	Complete Source Handshake capability
AH1	Complete Acceptor Handshake capability
T5	Basic Talker; Talk-Only; Unaddressed if MLA; no serial poll.
L4	Basic Listener; Unaddressed if MTA; no Listen Only.
RL1	Remote/Local capability
DC1	Device Clear capability
DT1	Device Trigger capability
C0	No controller capability
E1	Drivers are open-collector

### 5.3.3 GPIB Addressing

The factory default setting for the GPIB address is 8. You can set the address to a value of 0 to 31 and the address is saved in the non-volatile memory. Do not assign the same address to another device or a controller that are on the same GPIB bus system.

Follow the below steps to change the GPIB address:

1. Press **Shift** → **Left Arrow** to enter the menu on the menu level, "**A: MEAS MENU**" will be displayed.
2. Use **Left Arrow** or **Right Arrow** key to move across the I/O MENU on the menu level, "**E: I/O MENU**" will be displayed.
3. Press **Down Arrow** to move down to the command level within the I/O MENU, "**1: GPIB ADDR**" will be displayed.
4. Use **Left Arrow** and **Right Arrow** keys to choose a numerical place and use **Up Arrow** and **Down Arrow** keys to increment or decrement the digits. Enter a value for the GPIB address (0 to 31).
5. Press **Auto** (ENTER) to confirm the address. The message "**CHANGE SAVED**" will be displayed to show that the change is now in effect.
6. Press **Shift** → **Left Arrow** key to exit from the menu.

## 5.4 Data Format

5492BGPIB outputs the measurement results using the ASCII character string format via the GPIB bus. The data format is described in the following Figure 5-5.

SD.DDDDDDESDDD<NL>	
S: +/-	E: exponent sign ("+"is omitted)
D: number 0 to 9	<NL>: New Line; Termination character

**Figure 5-5 Data Format**

# Chapter 6 SCPI Command Reference

This chapter is outlined as follows:

- 6.1 Command Structure
- 6.2 Command Syntax
- 6.3 Command Reference

## 6.1 Command Structure

The remote commands are divided into two types: Common commands and SCPI commands. The common commands are defined in IEEE std. 488.2-1987, and these commands are common for all devices. Not all commands are supported by the 5492B, and some commands are not supported by the GPIB interface for the 5492BGPIB. Please look through the command syntax thoroughly before programming. The SCPI commands are used to control most of the 5492B functions. They can be represented as a tree structured with three levels deep. (The highest level commands are called the subsystem commands in this manual.) The lower level commands are part of subsystem commands and a colon (:) is used to separate the higher level commands and the lower level commands. See Figure 6-1 as an example.

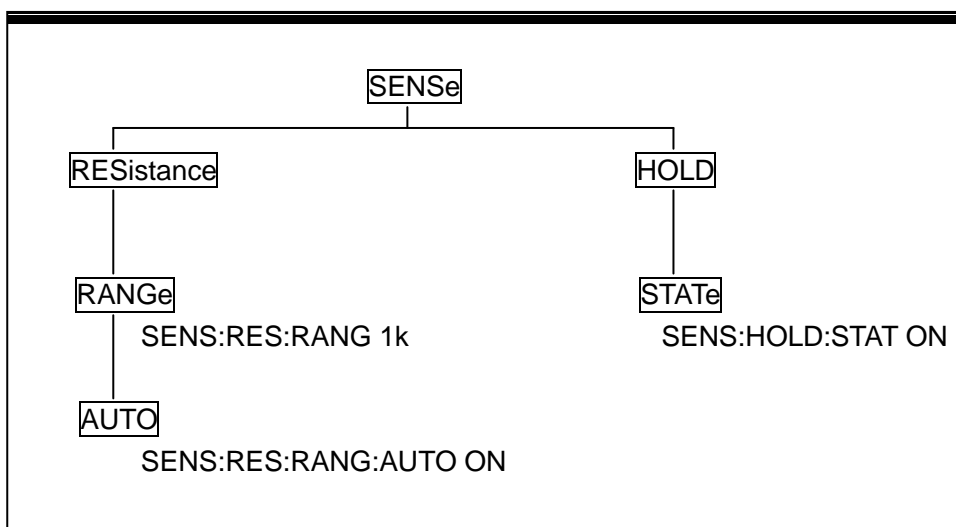

Figure 6-1 Command Tree Example

## 6.2 Command Syntax

### 6.2.1 Commands and command parameters

Common commands and SCPI commands may or may not use a parameter. The following are some examples:

*RST	No parameter used
:FORMat <name>	Parameter<name> required
:IMMEDIATE	No parameter used

For commands that use a parameter, include a space in between the command and the parameter.

- Brackets [ ]: Some command words are enclosed in brackets. These brackets are used to denote an optional command word that does not need to be included in the program message. For example:

```
:RANGe[:UPPer] <n>
```

These brackets indicate that :UPPer is optional and does not have to be used. Thus, the above command can be sent in one of the two ways below:

```
:RANGe <n>
or :RANGe:UPPer <n>
```

**NOTICE:** *When using optional command words in your program, do not include the brackets.*

- Angel brackets <>: Angle brackets are used to denote a parameter type. Do not include the brackets in the program message. For example:

```
:HOLD:STATe <b>
```

The <b> indicates that a Boolean-type parameter is required. Thus, to enable the HOLD feature, you must send the command with ON or 1 parameter as below:

```
:HOLD:STATe ON
or :HOLD:STATe 1
```

- Parameter types: The following are some of the more common parameter types:  
<b> Boolean: Used to enable or disable an instrument operation. "0" or "OFF" disables the operation and "1" or "ON" enables the operation. Example:

```
:CURRent:AC:RANGe:AUTO ON Enable autoranging
```

<name> Name parameter: Select a parameter name from a listed group. Example:

## SCPI Command Reference

---

<name> =   MOVing  
              REPeat

:RESistance:AVERage:TCONtrol   MOVing

<NRf>       Numeric Representation format: This parameter is a number that can be expressed as an integer (e.g., 6), a real number (e.g., 25.3) or an exponent (e.g., 5.6E2). Example:

:MMFactor 5

<n>         Numeric value: A numeric value parameter can consist of a NRf number or one of the following name parameters: DEFault, MINimum, MAXimum. When DEFault parameter is used, the instrument is programmed to the \*RST default value. When the MINimum parameter is used, the instrument is programmed to the lowest allowable value. When the MAXimum parameter is used, the instrument is programmed to the largest allowable value. Examples:

```
[:SENSe[1]]:CURRent[:DC]:NPLCycles 1
[:SENSe[1]]:CURRent[:DC]:NPLCycles DEFault
[:SENSe[1]]:CURRent[:DC]:NPLCycles MINimum
[:SENSe[1]]:CURRent[:DC]:NPLCycles MAXimum
```

### 6.2.2 Short-form Rules

Use the following rules to determine the short-form version of any SCPI command:

- If the length of the command word is four letters or less, no short form version exists. Example:  
:AUTO = :AUTO
- These rules apply to command words that exceed four letters, with some exceptions.
- If the fourth letter of the command word is a vowel, delete it and all the letters after it. Example:  
:immediate = :imm
- Rule exception – The short form version of the following command uses only the first two letters of the word.  
:TCouple = :tc
- If the fourth letter of the command word is a consonant, retain it but drop all the letters after it. Example:  
:FORMat = :FORM
- If the command contains a question mark (?; query) or a non-optional number included in the command word, you must include it in the short-form version. Example:  
:delay? = :del?
- Command words or characters that are enclosed in brackets ([ ]) are optional and need not be included in the program message.



### 6.2.3 Basic Rules of Command Structure

- Commands are not case sensitive.  
For example:  
FUNC:\VOLT:DC = func:volt:dc = Func:Volt:Dc
- Spaces (␣ is used to indicate a space) must not be placed before and/or after the colon (:).  
For example:  
(wrong) FUNC␣:\VOLT:DC  
(right) FUNC:\VOLT:DC
- The command can be completely spelled out or in abbreviated type. (In the following description, short form will be printed in upper case.)  
For example:  
FUNCTION: VOLTAGE:DC = FUNC: VOLT:DC
- The command header should be followed by a question mark (?) to generate a query for that command.  
For example:  
FUNC?

### 6.2.4 Multiple Command Rules

The semicolon (;) can be used as a separator to execute multiple commands on a single line. The multiple command rules are as follows.

- Commands at the same level and in the same subsystem command group can be separated by a semicolon (;) on a multiple command line.  
For example:  
CALCulate3:LIMit[1]:STATe <b>;STATe?
- To restart commands from the highest level, a semicolon (;) must be used as the separator, and then a leading colon (:), which shows that the restarted command is a command at the top of the command tree.  
For example:  
:CALCulate[1]:FORMat?;;CALCulate[1]:KMATH:MMFactor <NRf>
- The common commands can restart only after a semicolon on a multiple command line.  
For example,  
CALCulate3:LIMit[1]:STATe <b>;\*IDN?

### 6.2.5 Command Path Rules

- Each new program message must begin with the root command, unless it is optional (e.g., [:SENSe]). If the root is optional, simply treat a command word on the next level as the root.
- The colon at the beginning of a program message is optional and need not be used. Example:  
:DISPlay:ENABle <b> = DISPlay:ENABle <b>
- When the path pointer detects a colon(;), it moves down to the next command level.

- When the path pointer detects a colon (:) after a semicolon (;), it resets back to the root level.
- The path pointer can only move down. It cannot be moved up a level. Executing a command at a higher level requires that you start over at the root command.

### 6.3 Command Reference

The following are the subsystem commands:

- DISPlay
- CALCulate
- SENSE
- SYStem
- UNIT
- TRIGger

The supported common commands are:

- \*RST
- \*TRG
- \*IDN?

#### 6.3.1 Measurement Commands

The measurement commands described in this section are used to acquire readings. These commands are summarized in Table 6-1 below.

**Table 6-1 Signal Oriented Measurement Command Summary**

<b>Command</b>	<b>Function Description</b>
MEASure:<function>? :CONFigure:<function>	Perform an :ABORt, :CONFigure:<function>, and :READ? Configure instrument to the selected measurement function.
:FETCh?	Request the latest reading.
:READ?	Perform an :ABORt, :INITiate, and a :FETCh?

### MEASure command

Command syntax:

:MEASure:<function>?

Command parameter :

<function> =	VOLTage:DC	DC voltage
	VOLTage:AC	AC voltage
	CURRent:DC	DC current
	CURRent:AC	AC current
	RESistance	2-wire resistor
	FRESistance	4-wire resistor
	FREQuency	Frequency
	PERiod	Period
	DIODe	Diode testing
	CONTInuity	Continuity test

Return String:

Returns a measured reading.

Description:

This command combines all of the other signal oriented measurement commands to perform a “one time” measurement and acquire the reading.

When this command is sent, the following commands execute in order:

:ABORt

:CONFigure:<function>

:READ?

When :ABORt is executed, if continuous initiation is disabled, the instrument goes into the idle state. If continuous initiation is enabled, the operation re-starts at the beginning of the Trigger Model.

When :CONFigure is executed, the instrument goes the selected measurement mode.

When :READ? is executed, another :ABORt is performed, then an :INITiate, and finally a FETCh? to acquire the reading.

### CONFigure Command

Command syntax:

:CONFigure:<function>

Command parameter :

<function> =	VOLTage:DC	DC voltage
	VOLTage:AC	AC voltage
	CURRent:DC	DC current
	CURRent:AC	AC current
	RESistance	2-wire resistor
	FRESistance	4-wire resistor
	FREQuency	Frequency
	PERiod	Period
	DIODe	Diode testing
	CONTInuity	Continuity test

Query:

:CONFigure?                      Query the selected function.

Return String Example:

volt:dc

Description:

This command configures the instrument for subsequent measurements on the specified function. It places the instrument in the selected measurement mode. You then use the :READ? command to trigger a measurement and acquire a reading.

When this command is sent, the multimeter will be configured as follows:

- The function specified by this command is selected.
- All controls related to the selected function are defaulted to the \*RST values.
- Continuous initiation is disabled.
- The control source of the Trigger Model is set to Immediate.
- The delay of the Trigger Model is set to zero.
- All math calculations are disabled.
- Buffer operation is disabled. A storage operation currently in process will be aborted.
- Autozero is set to the \*RST default value.

This command is automatically asserted when the :MEASure? Command is sent.

### FETCh Command

Command syntax:

:FETCh?

Description:

This query command is used to obtain the latest post-processed reading. This command does not affect the configuration of the instrument.

This command does not trigger a measurement. The command simply requests the last available reading. It will continue to return the same reading until there is a new reading.

This command will be automatically asserted when :READ? or :MEASure? command is sent. Continuous initiation must be enabled or an error will occur when sending this command.

### READ Command

Command syntax:

:READ?

Description:

When this command is sent, the following commands execute in order:

:ABORt

:INITiate

:FETCh?

When :ABORt is executed, if continuous initiation is disabled, the instrument goes into the idle state. If continuous initiation is enabled, the operation re-starts at the beginning of the Trigger Model.

If the instrument is in the idle state, :INITiate takes the instrument out of the idle state. If continuous initiation is enabled (:INITiate:CONTinuous ON), then the :INITiate command generates an error and ignores the command.

See the :FETCh? command for more details. Note that an "Init ignored" error will not cancel the execution of the :FETCh? command.

**NOTE:** *You cannot use the :READ? command if there are readings stored in the buffer (error -225, out of memory). Clear the buffer before using :READ?*

## 6.3.2 DISPlay subsystem

The DISPlay subsystem commands are mainly used to control the display of the multimeter and are summarized in Table 6-2.

**Table 6-2 DISPlay Subsystem Commands Summary**

Command	Function Description
:DISPlay :ENABle <b> :ENABle?	Enable or disable front panel display Query state of the display

### :ENABle <b>

Command syntax:

:DISPlay:ENABle <b>

Command Parameter:

<b> = 0 or OFF            Disable front panel display  
          1 or ON            Enable front panel display

Query:

:ENABle?                Query state of the display

Return String:

1 or 0

Description:

This command is used to enable or disable front panel display circuitry. When disabled, the instrument operates at a higher speed. While disabled, the display will be frozen. All front panel controls except LOCAL are disabled. Normal display operation can be resumed by using :ENABle command or pressing LOCAL key to enable the display.

## 6.3.3 CALCulate Subsystem

The commands in this subsystem are used to configure and control the calculate subsystems and are summarized in Table 6-3.

**Table 6-3 CALCulate Command Summary**

Command	Function Description	Default Parameter
:CALCulate[1] :FORMat <name> :FORMat? :KMATH :MMFactor <NRf> :MMFactor?	Subsystem to control CALC1 (MX+B and % MATH) Select math format (NONE,MXB,PERCent) Query math format. Path to configure math calculations: Set "m" factor for mx+b (-100e6 to 100e6) Query "m" factor	NONE    1

## SCPI Command Reference

:MBFactor <NRf>	Set "b" factor for mx+b (-100e6 to 100e6)	0
:MBFactor?	Query "b" factor	
:PERCent <NRf>	Set target value for PERCent calculation(-100e6 ~100e6)	1
:ACQuire	Use input signal as target value.	
:PERCent?	Query percent	
:STATe <b>	Enable or disable KMATH calculation	
:STATe?	Query state of KMATH calculation	
:DATA?	Read result of KMATH calculation	
:CALCulate2	Subsystem to control CALC2 (Buffer operation)	
:TRACe		
:CLEAr	Clear readings in the buffer.	
:POINTs <NRf>	Specify the size of buffer (2 to 512)	
:POINTs?	Query buffer size.	
:DATA?	Read all readings in the buffer. (GPIB not supported)	
:FORMat <name>	Select type of statistical calculation for readback	NONE
:FORMat?	Query the type of statistical calculation for readback	
:STATe <b>	Enable or disable store reading	
:STATe?	Query state of store reading function	
:DATA?	Read statistical calculated result	
:CALCulate3	Subsystem to control CALC3 (Limit test operation):	
:LIMit[1]		
:UPPer <n>	Set upper limit (-100e6 to 100e6).	1
:UPPer?	Query upper limit.	
:LOWer <n>	Set lower limit (-100e6 to 100e6).	-1
:LOWer?	Query lower limit	
:STATe <b>	Enable or disable limit test	OFF
:STATe?	Query state of limit test	
:FAIL?	Query test result (1=pass, 0=fail)	

### **:CALCulate[1] Subsystem**

Use this subsystem for commands to configure and control MXB and percent math calculations.

#### **:FORMat <name>**

Command syntax:

:CALCulate[1]:FORMat <name>

Command Parameter:

<name> =	NONE	No calculations
	MXB	MX+B math calculation
	PERCent	Percent math calculation

Query:

:FORMat?            Query programmed math format

Return String:

NONE, MXB, or PERC

Description:

This command is used to specify the format for the CALC1 math calculations. With NONE selected, no CALC1 calculation is performed. With MXB or PERCent selected and enabled, the result of the calculation is displayed. The calculated reading is refreshed every time the instrument takes a reading.

#### **:KMATH Commands**

##### **:MMFactor <NRf>**

Command syntax:

:CALCulate[1]:KMATH:MMFactor <NRf>

Command Parameter:

<NRf> =        -100e6 to 100e6        Specify "m" factor.

Query:

:MMFactor?        Query "m" factor.

Return String:

The value of m in <NRf> format

Description:

This command is used to define the "m" factor for the mx+b calculation.

##### **:MBFactor <NRf>**

Command syntax:

:CALCulate[1]:KMATH:MBFactor <NRf>

Command Parameter:

<NRf> =        -100e6 to 100e6        Specify "b" factor.



Query:

:MBFactor?      Query "b" factor

Return String:

The value of b in <NRf> format

Description:

This command is used to define the "b" factor for the mx+b calculation.

**:PERCent <NRf>**

Command syntax:

:CALCulate[1]:KMATh:PERCent <NRf>

Command Parameter:

<NRf> =      -1e6 to 1e6      Specify target value.

Query:

:PERCent?      Query percent target value

Description:

This command is used to specify the target value for the percent calculation.

**:ACQuire**

Command syntax:

:CALCulate[1]:KMATh:PERCent:ACQuire

Description:

This action command is used to acquire the current reading and use it as the target value for the PERCent calculation.

**:STATe <b>**

Command syntax:

:CALCulate[1]:STATe <b>

Command Parameter:

<b> =      0 or OFF      Disable CALC1 calculation.  
         1 or ON      Enable CALC1 calculation.

Query:

:STATe?      Query state (ON or OFF) of CALC1.

Return String:

1 or 0

### Description:

This command is used to enable or disable the CALC1 calculation. When enabled, each instrument reading will reflect the selected calculation.

### **:DATA?**

#### Command syntax:

:CALCulate[1]:DATA?

#### Return String:

Math calculated measurement in <NRf> format

### Description:

This query command is used to read the result of the CALC1 calculation. If CALC1 is disabled or NONE is selected, the measured reading without the math calculations will be returned.

## **:CALCulate2 Subsystem**

Use this subsystem for commands to configure and control buffer operations.

### **:TRACe Command**

#### **:CLEar**

#### Command syntax:

:CALCulate2:TRACe:CLEar

### Description:

This action command is used to clear the readings in the buffer. If the buffer is not cleared, a subsequent store will overwrite the previous readings. If the subsequent store is aborted before the buffer becomes full, you could end up with some readings that were previously stored in the buffer.

**Note:** For USB(virtual com) and RS-232 interface, this command must be used before a subsequent store can process. You will know that the display will not have "\*" lid up until the buffer is cleared, even if store reading function is enabled with ":CALC2:STAT 1" command.

#### **:POINTS <NRf>**

#### Command syntax:

:CALCulate2:TRACe:POINTS <NRf>

#### Command Parameter:

<NRf> = 2 to 512 Specify buffer size.

### Query:

:POINTS? Query buffer size.

### Description:

This command is used to specify the buffer size, which in turn sets the number of readings to store.

### **:DATA?**

Command syntax:

:CALCulate2:TRACe:DATA?

Return String Format:

If no readings are in buffer: Empty

If 5 readings are in buffer:

<reading><sp><unit>:<LF>

<reading><sp><unit>:<LF>

<reading><sp><unit>:<LF>

<reading><sp><unit>:<LF>

<reading><sp><unit>:<LF>

**Note: Using GPIB interface, the Return String Format will be different than above in that <LF> character will not follow after every reading. For example, for 2 readings, the format will be:**

**<reading><sp><unit>:<reading><sp><unit>:**

Where:

<reading> - This is the stored reading and consists of 8 characters, which includes decimal.

If the reading does not take up 8 characters, the unused characters become spaces.

For example: If the stored reading is 11.0016, the return string is: \_ 11.0016

If the stored reading is 0.326, the return string is: \_ \_ \_0.326

(where \_ is a space)

<sp> - This is a space character.

<unit> - This is the unit notation that corresponds to the <reading>.

It can be m ( $10^{-3}$ ), u ( $10^{-6}$ ), or n ( $10^{-9}$ ).

If the <reading> does not require a unit notation, this becomes a <sp>.

For example: 1.234 VDC does not require a unit notation.

<LF> - Linefeed character (0x0A, \n)

Description:

When this command is sent, all the readings stored in the buffer are sent to the computer. If there are no readings in the buffer, it will return with the string "Empty".

### **:FORMat <name>**

Command syntax:

:CALCulate2:FORMat <name>

Command Parameter:

<name> =	NONE	No calculation
	MAXimum	Largest reading in buffer
	MINimum	Lowest reading in buffer
	MEAN	Mean (average) value of readings in buffer
	SEDEViation	Standard deviation of readings in buffer

Query:

:FORMat?            Query programmed math format.

Return String:

NONE, MEAN, SEDV, MAX, or MIN

Description:

This command is used to specify which statistical calculations to recall (using “:CALC2:DATA?” command) from the stored readings in the buffer. If NONE is selected or if the buffer is empty, using “:CALC2:DATA?” command will return the current measured reading on the display.

### **:STATe <b>**

Command syntax:

:CALCulate2:STATe <b>

Command Parameter:

<b> =	0 or OFF	Disable store reading
	1 or ON	Enable store reading

Query:

:STATe?            Query state (ON or OFF) of store reading function

Return String:

1 or 0

Description:

This command is used to enable or disable store reading. It is equivalent to setting “RDGS STORE” to ON from the front panel menu. When enabled, readings on the display will immediately begin storing into the buffer if the meter is already in measurement mode.

For USB/RS-232 Interface: To store reading subsequently with this command, the buffer must be cleared prior to sending this command using the “:CALC2:TRAC:CLE” command.

### **:DATA?**

Command syntax:

:CALCulate2:DATA?

Return String:

<reading><sp>

where

<reading> - This is the stored reading and consists of 8 characters, which includes decimal.

If the reading does not take up 8 characters, the unused characters become spaces.

For example: If the stored reading is 11.0016, the return string is: \_ 11.0016

If the stored reading is 0.326, the return string is: \_ \_ \_0.326

(where \_ is a space)

<sp> - This is a space character.

Description:

This query command will return a statistical calculation result based on the stored readings inside the buffer. It can be either the Maximum reading, minimum reading, the average of the stored readings, or the standard deviation based on the stored readings. The “:CALC2:FORM” command is used to select which calculation result to return after this query.

### **:CALCulate3 Subsystem**

These commands are used to configure and control the limit test.

**:LIMit[1]:UPPer <n>** Specify upper limit

**:LIMit[1]:LOWer <n>** Specify lower limit

Command syntax:

:CALCulate3:LIMit[1]:UPPer <n>

:CALCulate3:LIMit[1]:LOWer <n>

Command Parameter:

<n> = -100e6 to 100e6 Specify limit value

Query:

:UPPer? Query upper limit

:LOWer? Query lower limit

Return String:

<n>

where

<n> - Specified limit value.

### Description:

This command is used to specify the upper and lower limit for limit testing. The actual limit depends on which measurement function is currently selected. For example, a limit value of 1 is 1V for the voltage measurement functions (DCV or ACV), 1A for the current measurement functions (DCI or ACI), 1  $\Omega$  on the resistance measurement function (2-wire or 4-wire). A limit value is not range sensitive. For example, a limit of 1 for DCV is 1 V on all measurement ranges.

### **:STATe <b>**

#### Command syntax:

:CALCulate3:LIMit[1]:STATe <b>

#### Command Parameter:

<b> =	0 or OFF	Disable limit test
	1 or ON	Enable limit test

#### Query:

:STATe? Query state (on or off) of limit test

#### Return String:

1 or 0

### Description:

This command is used to enable or disable the limit test function. When enabled, the limit test will be active.

### **:FAIL?**

#### Command syntax:

:CALCulate3:LIMit[1]:FAIL?

### Description:

This command is used to read the results of the limit test

0 = Limit test failed

1 = Limit test passed

The response message (0 or 1) only tells you if a limit test has passed or failed. In the case of 0 (failed), it does not tell you which limit (upper or lower) has failed.

### 6.3.4 SENSE subsystem command

This SENSE subsystem is used to configure and control the 5492B measurement functions and are summarized in Table 6-4 below.

**Table 6-4 SENSE Command Summary**

Command	Function Description	Default
[:SENSE[1]] :FUNCTION<name>	Select measurement function: 'VOLTage:AC', 'VOLTage:DC', 'RESistance', 'FRESistance', 'CURRent:AC', 'CURRent:DC', 'FREQuency', 'PERiod', 'DIODE', 'CONTInuity'.	VOLT:DC
:FUNCTION?	Query function.	
:DATA?	Output the latest reading	
:CURRent:AC	Path to configure AC current	
:NPLCycles <n>	Set A/D integration rate (Line cycle; 0.1 to 10)	1
:NPLCycles?	Query line cycle integration rate	
:RANGE	Path to configure measurement ranges	
[:UPPer] <n>	Select range	10
[:UPPer]?	Query range	
:AUTO <b>	Enable or disable auto range	ON
:AUTO?	Query auto range	
:REFerence <n>	Specify reference (-10 to 10)	0
:STATe <b>	Enable or disable reference	OFF
:STATe?	Query state of reference	
:ACQuire	Use input signal as reference	
:REFerence?	Query reference value	
:AVERage	Path to configure and control the filter	
:TCONtrol <name>	Select filter type(MOVing or REPeat)	
:TCONtrol?	Query filter type	
:COUNt <n>	Specify filter count (1 to 100)	5
:COUNt?	Query filter count	
:STATe <b>	Enable or disable filter	OFF
:STATe?	Query state of digital filter	

## SCPI Command Reference

**Table 6-4 SENSE Command Summary (cont.)**

Command	Function Description	Default
:CURRent:DC	Path to configure DC current	
:NPLCycles <n>	Set integration rate(line cycles; 0.1 to 10)	1
:NPLCycles?	Query line cycle integration rate	
:RANGe	Path to configure measurement range	
[:UPPer] <n>	Select range (0 to 10)	10
[:UPPer]?	Query range	
:AUTO <b>	Enable or disable auto range	ON
:AUTO?	Query auto range	
:REFerence <n>	Specify reference (-10 to 10)	0
:STATe <b>	Enable or disable reference	OFF
:STATe?	Query state of reference	
:ACQuire	Use input signal as reference	
:REFerence?	Query reference value	
:AVERage	Path to configure and control the filter	
:TCONtrol <name>	Select filter type (MOVing or REPeat)	
:TCONtrol?	Query filter type	
:COUNt <n>	Specify filter count (1 to 100)	5
:COUNt?	Query filter count	
:STATe <b>	Enable or disable filter	OFF
:STATe?	Query state of digital filter	
:VOLTage:AC	Path to configure AC voltage	
:NPLCycles <n>	Set integration rate (line cycles; 0.1 to 10)	1
:NPLCycles?	Query line cycle integration rate	
:RANGe	Path to set measurement range	
[:UPPer] <n>	Select range	750
[:UPPer]?	Query range	
:AUTO <b>	Enable or disable auto range	ON
:AUTO?	Query auto range	
:REFerence <n>	specify reference (-757.5 to 757.5)	0
:STATe <b>	Enable or disable reference	OFF
:STATe?	Query state of reference	
:ACQuire	Use input signal as reference	
:REFerence?	Query reference value	
:AVERage	Path to configure and control the filter	
:TCONtrol <name>	Select filter type: MOVing or REPeat	
:TCONtrol?	Query filter type	
:COUNt <n>	Specify filter count (1 to 100)	5
:COUNt?	Query filter count	
:STATe <b>	Enable or disable filter	OFF
:STATe?	Query state of digital filter	



## SCPI Command Reference

**Table 6-4 SENSE Command Summary (cont.)**

Command	Function Description	Default
:VOLTage:DC	Path to configure DC voltage	
:NPLCycles <n>	Set integration rate (line cycle; 0.1 to 10)	1
:NPLCycles?	Query line cycle integration rate	
:RANGe	Path to configure measurement range	
[:UPPer] <n>	Select range	1000
[:UPPer]?	Query range	
:AUTO <b>	Enable or disable auto range	ON
:AUTO?	Query auto range	
:REFerence <n>	Specify reference (-1010 to 1010)	0
:STATe <b>	Enable or disable reference	OFF
:STATe?	Query state of reference (0,1)	
:ACQuire	Use input signal as reference.	
:REFerence?	Query reference value	
:AVERage	Path to configure and control the filter	
:TCONtrol <name>	Select filter type (MOVing, REPeat)	
:TCONtrol?	Query filter type	
:COUNT <n>	Specify filter count (1 to 100)	5
:COUNT?	Query filter count	
:STATe <b>	Enable or disable filter	OFF
:STATe?	Query state of digital filter	
:RESistance	Path to configure 2-wire resistance	
:NPLCycles <n>	Set integration rate (line cycles: 0.1 to 10)	1
:NPLCycles?	Query line cycle integration rate	
:RANGe	Path to configure measurement range	
[:UPPer] <n>	Select range	100e6
[:UPPer]?	Query range	
:AUTO <b>	Enable or disable auto range	ON
:AUTO?	Query auto range	
:REFerence <n>	Specify reference (0 to 120e6)	0
:STATe <b>	Enable or disable reference	OFF
:STATe?	Query state of reference	
:ACQuire	Use input signal as reference	
:REFerence?	Query reference value	
:AVERage	Path to configure and control filter	
:TCONtrol <name>	Select filter type (MOVing, REPeat)	
:TCONtrol?	Query filter type	
:COUNT <n>	Specify filter count (1 to 100)	5
:COUNT?	Query filter count	
:STATe <b>	Enable or disable filter	OFF
:STATe?	Query state of digital filter	

## SCPI Command Reference

**Table 6-4 SENSe Command Summary (cont.)**

Command	Function description	Default
:FRESistance :NPLCycles <n> :NPLCycles? :RANGe [:UPPer] <n> [:UPPer]? :AUTO <b> :AUTO? :REFERence <n> :STATe <b> :STATe? :ACQuire :REFERence? :AVERage :TCONtrol <name> :TCONtrol? :COUNt <n> :COUNt? :STATe <b> :STATe?	Path to configure 4-wire resistance Set integration rate (line cycle: 0.1 to 10) Query line cycle integration rate Path to configure measurement range Select range Query range Enable or disable auto range Query auto range Specify reference (0 to 1201e6) Enable or disable reference Query state of reference Use input signal as reference Query reference value Path to configure and control filter Select filter type (MOVing, REPeat) Query filter type Specify filter count (1 to 100) Query filter count Enable or disable filter Query state of digital filter	1   100e6  ON  0 OFF     5  OFF
:FREQuency :THReshold :VOLTage :RANGe <n> :RANGe? :REFERence <n> :STATe <b> :STATe? :ACQuire :REFERence?	Path to configure frequency Path to select the threshold voltage range:  Select threshold range Query threshold range Specify reference (0 to 1.5e7) Enable or disable reference Query state of reference Use input signal as reference Query reference value	   10  0 OFF
:PERiod :THReshold :VOLTage :RANGe <n> :RANGe? :REFERence <n> :STATe <b> :STATe? :ACQuire :REFERence?	Path to configure period Path to select the threshold voltage range:  Select threshold range Query threshold range Specify reference (0 to 1) Enable or disable reference Query state of reference Use input signal as reference Query reference value	   10  0 OFF

## SCPI Command Reference

**Table 6-4 SENSE Command Summary (cont.)**

Command	Function description	Default
:DIODE :CURRent :RANGe [:UPPer] <NRf> [:UPPer]?	Path to configure diode test  Path to select range Select range Query range	1e-3
:CONTInuity :THReshold <NRf> :THReshold?	Path to configure continuity test Specify threshold resistance (1 to 1000) Query threshold resistance	10

### **:[SENSe[1]] Subsystem**

#### **:FUNction <name>**

Command syntax:

:[SENSe[1]]:FUNction <name>

Command Parameter:

<name> =	VOLTage:AC	Select AC Voltage
	VOLTage:DC	Select DC Voltage
	CURRent:AC	Select AC Current
	CURRent:DC	Select DC Current
	RESistance	Select 2-wire Resistance
	FRESistance	Select 4-wire Resistance
	FREQUency	Select Frequency
	PERiod	Select Period
	DIODE	Select Diode Testing
	CONTInuity	Select Continuity Testing

Query:

:FUNction?            Query currently programmed function

Description:

This command is used to select the measurement function of the instrument.

Each measurement function “remembers” its own unique setup configuration, such as range and speed. This eliminates the need to re-program setup conditions every time you switch from one function to another.

### **:DATA?**

Command syntax:

```
[[:SENSe[1]]]:DATA?
```

Description:

This query command is used to read the latest instrument reading. It returns the display reading or a reading with REL enabled. For example, if a reference value of 1.0 is established, the reading returned by this command is the measured reading minus 1.0. Calculated (MATH) readings cannot be read with this command (See the CALCulate subsystem for information on how to read math calculations). The reading is returned in exponent form. For example, a 10V DC reading will be displayed as: +1.000000E+01.

Notice that the measurement function is not included in the response message. Thus, you may want to perform a function query after a reading query to verify which function this reading reflects.

### **NPLCycles Command**

The NPLCycles command is a subset to current, voltage, and resistance measurement commands, of which are part of the SENSE subsystem. The below lists out all the command syntax for setting NPLCycles for different measurement functions.

#### **: NPLCycles <n>**

Command Syntax:

```
[[:SENSe[1]]]:CURRent:AC:NPLCycles <n>
```

```
[[:SENSe[1]]]:CURRent:DC:NPLCycles <n>
```

```
[[:SENSe[1]]]:VOLTage:AC:NPLCycles <n>
```

```
[[:SENSe[1]]]:VOLTage:DC:NPLCycles <n>
```

```
[[:SENSe[1]]]:RESistance:NPLCycles <n>
```

```
[[:SENSe[1]]]:FRESistance:NPLCycles <n>
```

Command Parameter:

<n> =	0.1 to 10	Set power line cycles per integration
	Default	1
	MINimum	0.1
	MAXimum	10

Query:

```
:NPLCycles?                      Query programmed NPLC value
```

Description:

The integration period (measurement speed) for the basic measurement functions (except

## SCPI Command Reference

Frequency and Period) is set using this :NPLCycles command. NPLC (Number of Power Line Cycles) expresses the integration period by basing it on the power line frequency. For example, for a PLC of 1, the integration period in seconds would be 1/60 (for 60Hz line power) or 16.67 ms.

**Note:** Set the measurement function first before setting or querying the NPLC. All the command syntax listed will set or query the same NPLC value.

### RANGE Command

The RANGE command is a subset to current, voltage, and resistance measurement commands, of which are part of the SENSE subsystem. The below lists out all the command syntax for setting RANGE for different measurement functions.

#### :RANGE:[UPPer] <n>

Command syntax:

```
[:SENSe[1]]:CURRent:AC:RANGE[:UPPer] <n>
[:SENSe[1]]:CURRent:DC:RANGE[:UPPer] <n>
[:SENSe[1]]:VOLTage:AC:RANGE[:UPPer] <n>
[:SENSe[1]]:VOLTage:DC:RANGE[:UPPer] <n>
[:SENSe[1]]:RESistance:RANGE[:UPPer] <n>
[:SENSe[1]]:FRESistance:RANGE[:UPPer] <n>
```

Command Parameter:

<n> =	0.01 (12 mA), 0.1 (120 mA), 1 (1.2 mA), 10 (12 A)	For DCI
	0.01 (12 mA), 1 (1.2 mA), 10 (12 A)	For ACI
	0.1 (120 mV), 1 (1.2 V), 10 (12 V), 100 (120 V), 750 (750 V)	For ACV
	0.1 (120 mV), 1 (1.2 V), 10 (12 V), 100 (120 V), 1000 (1000 V)	For DCV
	100 (120 Ω), 1000 (1.2 KΩ), 10000 (12 KΩ), 100000 (120 KΩ), 1000000 (1.2 MΩ), 10000000 (12 MΩ), 100000000 (120 MΩ)	For Ω2/Ω4 Wire
DEFault	10 (12 A range: ACI and DCI) 750 (750 V range: ACV) 1000 (1000 V range: DCV) 100e6 (120 MΩ range: Ω2/Ω4 Wire)	
MINimum	0 (All functions)	
MAXimum	Same as DEFault	

Query:

```
:RANGE[:UPPer]?          Query measurement range of the currently selected function.
```

Description:

This command is used to manually select the measurement range for the specified measurement function.

## SCPI Command Reference

---

**Note:** All the command syntax listed will set or query the same range value, which will be determined by the measurement function currently selected on the instrument. Therefore, set the measurement function first before setting or querying the range.

### **:AUTO <b>**

Command syntax:

```
[[:SENSe[1]]:CURRent:AC:RANGe:AUTO <b>
[:SENSe[1]]:CURRent:DC:RANGe:AUTO <b>
[:SENSe[1]]:VOLTage:AC:RANGe:AUTO <b>
[:SENSe[1]]:VOLTage:DC:RANGe:AUTO <b>
[:SENSe[1]]:RESistance:RANGe:AUTO <b>
[:SENSe[1]]:FRESistance:RANGe:AUTO <b>
```

Command parameter:

<b> =	1 or ON	Enable auto range
	0 or OFF	Disable auto range

Query:

```
:AUTO?           Query auto range (ON or OFF)
```

Return String:

```
1 or 0
```

Description:

These commands are used to control auto ranging. With auto ranging enabled, the instrument automatically goes into the most sensitive range (based on the input) to perform the measurement.

The auto range command (:RANGe:AUTO) is coupled to the command that manually selects the measurement range (:RANGe <n>). When auto range is enabled, the parameter value for :RANGe <n> changes to the automatically selected range value. There, when auto range is disabled, the instrument remains at the automatically selected range. When a valid :RANGe <n> command is sent, auto ranging disables.

**Note:** Autoranging is not available for some current AC and DC ranges.

## REFerence Command

The REFerence command is a subset to current, voltage, resistance, frequency, and period measurement commands, of which are part of the SENSe subsystem. The below lists out all the command syntax for setting REFerence for different measurement functions.

## SCPI Command Reference

---

### **:REFeRence <n>**

Command syntax:

<code>[:SENSe[1]]:CURRent:AC:REFeRence &lt;n&gt;</code>	Specify reference for ACI
<code>[:SENSe[1]]:CURRent:DC:REFeRence &lt;n&gt;</code>	Specify reference for DCI
<code>[:SENSe[1]]:VOLTage:AC:REFeRence &lt;n&gt;</code>	Specify reference for ACV
<code>[:SENSe[1]]:VOLTage:DC:REFeRence &lt;n&gt;</code>	Specify reference for DCV
<code>[:SENSe[1]]:RESistance:REFeRence &lt;n&gt;</code>	Specify reference for $\Omega 2$
<code>[:SENSe[1]]:FREStance:REFeRence &lt;n&gt;</code>	Specify reference for $\Omega 4$
<code>[:SENSe[1]]:FREQuency:REFeRence &lt;n&gt;</code>	Specify reference for FREQ
<code>[:SENSe[1]]:PERiod:REFeRence &lt;n&gt;</code>	Specify reference for PER

Command parameter:

<code>&lt;n&gt; = -12 to 12</code>	Reference for ACI and DCI
<code>-757.5 to 757.5</code>	Reference for ACV
<code>-1010 to 1010</code>	Reference for DCV
<code>0 to 120e6</code>	Reference for $\Omega 2$ or $\Omega 4$
<code>0 to 1.5e7</code>	Reference for FREQ
<code>0 to 1</code>	Reference for PER

Query:

`:REFeRence?` Query reference for relative function

Return String:

Returns reference value in exponent form. For example, 1010 = 1.010000e+003

Description:

These commands are used to establish a reference value for the specified function. When reference is enabled (`:REFeRence:STATe`), the result will be the difference between the input signal and the reference value:

Reading = Input signal – Reference

From the front panel, reference is called relative (REL).

The `:REFeRence <n>` command is coupled to the `:ACQuire` command. The last command sent (`:REFeRence <n>` or `:ACQuire`) establishes the reference. When a reference is set using the `:REFeRence <n>` command, the `REFeRence?` Query command returns the programmed value. Conversely, when a reference is set using the `:ACQuire` command, the `:REFeRence?` Query command returns the acquired reference value.

### **:STATe <b>**

Command syntax:

<code>[:SENSe[1]]:CURRent:AC:REFeRence:STATe &lt;b&gt;</code>	Control reference for ACI
<code>[:SENSe[1]]:CURRent[:DC]:REFeRence:STATe &lt;b&gt;</code>	Control reference for DCI
<code>[:SENSe[1]]:VOLTage:AC:REFeRence:STATe &lt;b&gt;</code>	Control reference for ACV
<code>[:SENSe[1]]:VOLTage[:DC]:REFeRence:STATe &lt;b&gt;</code>	Control reference for DCV
<code>[:SENSe[1]]:RESistance:REFeRence:STATe &lt;b&gt;</code>	Control reference for $\Omega 2$

## SCPI Command Reference

---

<code>[:SENSe[1]]:FRESistance:REFerence:STATe &lt;b&gt;</code>	Control reference for $\Omega$ 4
<code>[:SENSe[1]]:FREQuency:REFerence:STATe &lt;b&gt;</code>	Control reference for FREQ
<code>[:SENSe[1]]:PERiod:REFerence:STATe &lt;b&gt;</code>	Control reference for PER

Command parameter:

<code>&lt;b&gt; = 1</code> or ON	Enable reference
<code>&lt;b&gt; = 0</code> or OFF	Disable reference

Query:

`:STATe?` Query state of reference.

Return String:

1 or 0

Description:

This command is used to enable or disable reference mode for the specified measurement function. When enabled, the displayed reading will include the programmed reference value. When disabled, the displayed reading will not include the reference value.

### **:ACQUIRE**

Command syntax:

<code>[:SENSe[1]]:CURRent:AC:REFerence:ACQUIRE</code>	Acquire reference for ACI
<code>[:SENSe[1]]:CURRent[:DC]:REFerence:ACQUIRE</code>	Acquire reference for DCI
<code>[:SENSe[1]]:VOLTage:AC:REFerence:ACQUIRE</code>	Acquire reference for ACV
<code>[:SENSe[1]]:VOLTage[:DC]:REFerence:ACQUIRE</code>	Acquire reference for DCV
<code>[:SENSe[1]]:RESistance:REFerence:ACQUIRE</code>	Acquire reference for $\Omega$ 2
<code>[:SENSe[1]]:FRESistance:REFerence:ACQUIRE</code>	Acquire reference for $\Omega$ 4
<code>[:SENSe[1]]:FREQuency:REFerence:ACQUIRE</code>	Acquire reference for FREQ
<code>[:SENSe[1]]:PERiod:REFerence:ACQUIRE</code>	Acquire reference for PER

Description:

When this command is sent, the measurement input signal is acquired and becomes the reference value. This command is typically used to zero the display. For example, if the instrument is displaying a 1  $\mu$ V offset, sending this command and enabling reference zeroes the display.

This command is functional only if the instrument is on the specified measurement function. Sending this command while in any other function causes an error. Also, if the latest reading is overflowed or a reading has not been triggered, an error occurs when this command is sent.

### **AVERage Command**

The AVERage command is a subset to current, voltage, and resistance measurement commands, of which are part of the SENSe subsystem. The below lists out all the command syntax for setting AVERage for different measurement functions.



### **:STATe <b>**

Command syntax:

```
[[:SENSe[1]]:CURRent:AC:AVERage:STATe <b>
[:SENSe[1]]:CURRent:DC:AVERage:STATe <b>
[:SENSe[1]]:VOLTage:AC:AVERage:STATe <b>
[:SENSe[1]]:VOLTage:DC:AVERage:STATe <b>
[:SENSe[1]]:RESistance:AVERage:STATe <b>
[:SENSe[1]]:FRESistance:AVERage:STATe <b>
```

Command parameter:

<b> =	1 or ON	Enable the digital filter
	0 or OFF	Disable the digital filter

Query:

:STATe?	Query state of digital filter
---------	-------------------------------

Return String:

1 or 0

Description:

These commands are used to enable or disable the digital filter for the current measurement function. When enabled, readings will be filtered according to how the filter is configured.

### **:TCONtrol <name>**

Command syntax:

```
:CURRent:AC:AVERage:TCONtrol <name>
:CURRent:DC:AVERage:TCONtrol <name>
:VOLTage:AC:AVERage:TCONtrol <name>
:VOLTage:DC:AVERage:TCONtrol <name>
:RESistance:AVERage:TCONtrol <name>
:FRESistance:AVERage:TCONtrol <name>
```

Command parameter:

<name> =	REPeat	Select repeating filter
	MOVing	Select moving filter

Query:

:TCONtrol?	Query filter type
------------	-------------------

Return String

REP or MOV

Description:

These commands are used to select the type of averaging filter for the specified function.

### **:COUNT <n>**

Command syntax:

```
[[:SENSe[1]]:CURRent:AC:AVERage:COUNT <n>
[:SENSe[1]]:CURRent:DC:AVERage:COUNT <n>
[:SENSe[1]]:VOLTage:AC:AVERage:COUNT <n>
[:SENSe[1]]:VOLTage:DC:AVERage:COUNT <n>
[:SENSe[1]]:RESistance:AVERage:COUNT <n>
[:SENSe[1]]:FRESistance:AVERage:COUNT <n>
```

Command parameter:

<n> =	1 to 100	Specify filter count
	MINimum	1
	MAXimum	100

Query:

```
:COUNT?           Query filter count
```

Description:

These commands are used to specify the filter count. In general, the filter count is the number of readings that are acquired and stored in the filter buffer for the averaging calculation. The larger the filter count, the more filtering that is performed.

### **THReshold Command**

Use these commands to set the maximum range input (signal level) for frequency and period measurements.

### **:RANGe <n>**

Command syntax:

```
[[:SENSe[1]]:FREQuency:THReshold:VOLTage:RANGe <n>   Set voltage threshold range.
[:SENSe[1]]:PERiod:THReshold:VOLTage:RANGe <n>     Set voltage threshold range.
```

Command parameter:

<n> =	0.1 (120 mV), 1 (1.2 V), 10 (12 V), 100 (120 V), 750 (750 V)
	Specify signal levels in volts (voltage threshold)

Query:

```
:RANGe?           Query maximum signal level.
```

Return String:

0.1, 1, 10, 100, or 750

Description:

This command is used to set the current or voltage threshold range for frequency and period

measurements.

### DIODe Command

**:RANGe[:UPPer] <NRf>**

Command syntax:

`[:SENSe[1]]:DIODe:CURRent:RANGe[:UPPer] <NRf>` Specify current range for diode test

Command parameter:

<NRf> =	1 (1 mA)	Specify diode test current to 1 mA
	10 (10 $\mu$ A)	Specify diode test current to 10 $\mu$ A
	100 (100 $\mu$ A)	Specify diode test current to 100 $\mu$ A

Query:

`[UPPer]?` Query selected range

Description:

There are three current ranges available for the diode test: 10  $\mu$ A range, 100  $\mu$ A and 1 mA range. Range is selected by using this command to specify one of the above current range for the diode under test. Be sure to set the instrument for diode measurement function prior to using this command because it will set or query the range for the current measurement function instead.

### CONTInuity Command

**:THReshold <n>**

Command Syntax:

`[:SENSe[1]]:CONTInuity:THReshold <NRf>`

Command parameter:

<NRf> =	1 to 1000	Specify threshold in ohms
---------	-----------	---------------------------

Query:

`:THReshold?` Query threshold resistance

Description:

This command is used to specify the threshold resistance for the continuity test. Continuity occurs when the measurement is less than or equal to the specified threshold level.

### 6.3.5 SYSTem Subsystem

The SYSTem subsystem contains miscellaneous commands that are summarized in Table 6-5

**Table 6-5 SYSTem Command Summary**

Command	Function Description	Default
:SYSTem		
:PRESET	Return to system defaults	
:AZERo	Path to set up autozero	
:STATe <b>	Enable or disable autozero	ON
:STATe?	Query autozero	
:BEEPer	Path to control beeper	
[:STATe] <b>	Enable or disable beeper	ON
[:STATe]?	Query state of beeper	
:LOCal	Take multimeter out of remote state and restore front panel operation	

#### **:PRESET**

Command Syntax:

:SYSTem:PRESET

Description:

This command returns the instrument to factory defaults states.

#### **:AZERo**

**:STATe <b>**

Command Syntax:

:SYSTem:AZERo:STATe <b>

Command parameter:

<b> =	1 or ON	Enable autozero
	0 or OFF	Disable autozero

Query:

:STATe? Query state of autozero.

Return String:

1 or 0

Description:

This command is used to enable or disable autozero. When enabled, accuracy is optimized. When disabled, speed is increased at the expense of accuracy.

**Note:** Before you can enable or disable autozero, the multimeter must first be in the idle state.



### 6.3.6 UNIT Subsystem

The UNIT subsystem is used to configure and control the measurement units for ACV and DCV, summarized in Table 6-6.

**Table 6-6 UNIT Command Summary**

Command	Function description	Default
:UNIT		
:VOLTage	Path to configure voltage unit	
:AC <name>	Select ACV measurement units (V, DB or DBM)	V
:DB	Path to set DB reference voltage	
:REFerence <n>	Specify reference in volts (1e-7 to 1000)	1
:REFerence?	Query DB reference	
:DBM	Path to set DBM reference impedance	
:IMPedance <n>	Specify reference impedance (1 to 9999)	75
:IMPedance?	Query DBM reference impedance	
:AC?	Query ACV units	
:DC <name>	Select DCV measurement units(V, DB, DBM)	V
:DB	Path to set DB reference voltage:	
:REFerence <n>	Specify reference in volts (0 to 1000)	1
:REFerence?	Query DB reference voltage	
:DBM	Path to set DBM reference impedance:	
:IMPedance <n>	Specify reference impedance(1e-7 to 1000)	75
:IMPedance?	Query DBM reference impedance	
:DC?	Query DCV units	

**:VOLTage:AC <name>**

Command Syntax:

:UNIT:VOLTage:AC <name>

Command parameter:

<name> =	V	AC voltage measurement units
	DB	dB AC voltage measurement units
	DBM	dBm AC voltage measurement units

Query:

:VOLTage:AC?                      Query AC voltage units

Returned String:

V, DB, or DBM

Description:

The command is used to select the units for ACV measurement. With volt (V) unit selected, normal AC voltage measurement are made. With DB unit selected, AC dB voltage measurements are performed. With DBM units selected, AC dBm voltage measurements are made.

## SCPI Command Reference

---

### **:DB:REFeRence <n>**

Command Syntax:

:UNIT:VOLTage:AC:DB:REFeRence <n>

Command Parameter:

<n> = 1e-7 to 1000                      Specify reference voltage

Query:

:DB:REFeRence?                      Query reference voltage

Description:

This command is used to specify the dB reference level. When DB unit is selected, ACV dB measurements are made using the specified reference voltage.

The reference level is specified in volts and is not range dependent. For example: a dB reference level of 1 is 1 V on all ACV measurement ranges.

### **:DBM:IMPedance <n>**

Command Syntax:

:UNIT:VOLTage:AC:DBM:IMPedance <n>

Command parameter:

<n> = 1 to 9999                      Specify reference impedance

Query:

:DBM:IMPedance?                      Query reference impedance.

Description:

This command is used to specify the dBm reference impedance level. When dBm unit is selected, ACV dBm measurements are made using the specified reference impedance.

The reference impedance is specified in ohms and is not range dependent. For Example: a dBm reference level of 500 is 500 on all ACV measurement ranges.

### **:VOLTage:DC <name>**

Command Syntax:

:UNIT:VOLTage:DC <name>

Command Parameter:

<name> =	V	DC voltage measurement units
	DB	dB DC voltage measurement units
	DBM	dBm DC voltage measurement units

Query:

:VOLTage:DC?                      Query DC voltage units

## SCPI Command Reference

---

### Description:

The command is used to select the units for DCV measurement. With volt (V) unit selected, normal AC voltage measurement are made. With DB unit selected, DC dB voltage measurements are performed. With DBM units selected, DC dBm voltage measurements are made.

### **:DB:REFerence <n>**

#### Command Syntax:

:UNIT:VOLTage:DC:DB:REFerence <n>

#### Command parameter:

<n> = 1e-7 to 1000 Specify reference voltage in volts

#### Query:

:DB:REFerence? Query reference voltage

### Description:

This command is used to specify the dB reference level. When DB unit is selected, DCV dB measurements are made using the specified reference voltage.

The reference level is specified in volts and is not range dependent. For example: a dB reference level of 1 is 1 V on all DCV measurement ranges.

### **:DBM:IMPedance <n>**

#### Command Syntax:

:UNIT:VOLTage:DC:DBM:IMPedance <n>

#### Command Parameter:

<n> = 1 to 9999 Specify reference impedance

#### Query:

:DBM:IMPedance? Query reference impedance

### Description:

This command is used to specify the dBm reference impedance level. When dBm unit is selected, DCV dBm measurements are made using the specified reference impedance.

The reference impedance is specified in ohms and is not range dependent. For Example: a dBm reference level of 500 is 500 on all DCV measurement ranges.



## 6.3.7 TRIGger Subsystem

The Trigger subsystem is made up of a series of commands to configure the Trigger model. These commands and subsystems are summarized in Table 6-7

**Table 6-7 TRIGger Command Summary**

Command	Function Description	Default
:INITiate	Subsystem command path	
[:IMMEDIATE]	Initiate one trigger cycle.	
:CONTinuous <b>	Enable or disable continuous initiation.	
:CONTinuous?	Query continuous initiation.	
:ABORt	Reset trigger system	
:TRIGger		
:SOURce <name>	Select control source	IMMEDIATE
:SOURce?	Query control source	
:DELay <n>	Set delay time	0
:AUTO <b>	Enable or disable auto delay	OFF
:AUTO?	Query state of delay	

### **:INITiate**

***[:IMMEDIATE]***

Command Syntax:

:INITiate[:IMMEDIATE]

Description:

This command takes the instrument out of the idle state. After all programmed operations are completed, the instrument returns to the idle state if continuous initiation is disabled (see next command).

***:CONTinuous <b>***

Command Syntax:

:INITiate:CONTinuous <b>                      Control continuous initiation

Command parameter:

<b> =    0 or OFF                      Disable continuous initiation  
          1 or ON                      Enable continuous initiation

Query:

:CONTinuous?                      Query continuous initiation

Return String:

1 or 0

Description:

When continuous initiation is selected (ON), the instrument is taken out of the idle state. At the end

## SCPI Command Reference

---

of all programmed operations, the instrument will return to the top of the trigger model.

**NOTE:** *With continuous initiation enabled (ON), you cannot use the :READ? Command.*

### **:ABORt**

Command Syntax:

:ABORt

Description:

When this command is sent, the multimeter aborts operation and returns to the top of the Trigger Model.

### **:TRIGger**

This subsystem is used for to configure trigger mode and trigger delay

#### **:SOURce <name>**

Command Syntax:

TRIGger:SOURce <name>

Command parameter:

<name> =	IMMEDIATE	Internal trigger
	BUS	Trigger via USB/RS-232 or GPIB interface
	MANual	Press <input type="button" value="Trig"/> in the front panel for Trigger
	EXTernal	Trigger from external signal connected to EXT TRIG terminal

Query:

:SOURce?                      Query trigger source

Return String:

IMM, BUS, MAN, or EXT

Description:

This command is used to select the trigger source.

#### **:DELay <n>**

Command Syntax:

:TRIGger:DELay <n>

Command parameter:

<n> =    0 to 6000                      Specify delay in milliseconds

Description:

This command is used to set the delay time for trigger delay. It takes into effect only if auto delay is disabled.

### **:AUTO <b>**

Command Syntax:

:TRIGger:DElay:AUTO <b>

Command parameter:

<b> =	1 or ON	Enable auto delay
	0 or OFF	Disable auto delay

Query:

:AUTO?                      Query delay state

Return String:

1 or 0

Description:

This command is used for enable or disable trigger auto delay. If disabled, the trigger will delay based on the delay time configured with “:TRIGger:DElay” command.

## **6.3.8 Common Commands**

Common commands can be used in instruments that are SCPI-compliant. The common commands available for the 5492B are described below:

### **\*RST**

Command Syntax:

\*RST

Description:

Resets the instrument.

### **\*TRG**

Command Syntax:

\*TRG

Description:

Sends a bug trigger to the instrument. Use this if trigger source is set to BUS.

### **\*IDN?**

Query Syntax:

\*IDN?

Query return:

<product>,<version>,<sn number>

Example: 5492B Digital Multimeter, Ver1.0.00.00.01,123A45678

Description: Query the identification of the instrument.

# Chapter 7 Troubleshooting Guide

## 7.1 Frequently Asked Questions

### Front Panel Operation

**1. How do I exit the menu system?**

- Press any of the top row of keys (i.e. DCV, ACV, etc.) or press Shift + Left Arrow key.

**2. How do I see the data stored inside the buffer after running store reading function?**

- Press Shift + Left Arrow key to enter the menu and use the Left or Right Arrow keys until display shows D: SYS MENU.
- Press the Down Arrow key once, then use Left or Right Arrow keys again to 3: SAVED RDGS.
- Press the Down Arrow key once more and you will see the stored readings. Use Left or Right Arrow key to browse through all stored readings.

**3. I cannot read AC or DC current.**

- You might not be connecting to the correct inputs. For low current measurements (< 1 A), connect SENSE LO and INPUT LO terminals. For high current measurements (1 to 12 A), connect INPUT LO and 10 A terminals.
- Auto range is only available for low current measurements ( 12 mA and 120 mA(DCI) ranges only). If you are measuring current outside of these two ranges, use the Up Arrow key to manually select a higher current range.
- If you have connected SENSE LO and INPUT LO terminals with a current above 2 A, the front panel protection fuse may have been blown already. Check the fuse and replace it if necessary. See “3.3.2 Front Panel Fuse Replacement” for details.

**4. How do I calibrate the instrument?**

- Please contact B&K Precision for details.

**5. How do I turn off the beep sound after every key presses?**

- Press Shift + Left Arrow to go into the menu. Use the Left or Right Arrow keys until display shows D: SYS MENU.
- Press the Down Arrow key once, then use Left or Right Arrow keys again to 8: KEY SOUND.
- Press the Down Arrow key once more and the display will show SOUND: OFF. Use Left or Right Arrow key to change it to ON.
- Press Auto to save the setting, and the key sound will now be disabled.

### Remote Operation

**1. How do I extract stored buffer readings over GPIB interface?**

- Currently the command used for recalling buffer readings is only available for USB and RS-232 interfaces.

**2. I have connected the USB cable from the instrument to the computer, but it is not working.**

- The USB interface is a virtual COM. You first need to install the drivers, which can be downloaded at [www.bkprecision.com](http://www.bkprecision.com) .

## Troubleshooting Guide

---

- After drivers are installed, the USB connection will become a virtual com port, which is like a serial com port for RS-232 communication.
- Generally, Windows® will automatically assign a com port number after USB drivers are installed. To verify this, go to Device Manager and select “Port & LPT” in the list. You will see your device and its com port # listed in ( ).

### 3. I have connected the RS-232C port into a serial port on my computer, but it's not working.

- First, check that you have the correct cable. You will need a cross over or null modem serial DB-9 female to female cable to communicate over RS-232.
- Check the Baud Rate and Parity settings on the instrument as well as the interfacing software/application. They must match.

### 4. How come every command I send gets read back in the incoming buffer?

- This is the command echoing function and can be used as a software handshake. To disable this, go to the menu system under E: I/O MENU, select 6: RETURN, and set it to OFF. Press Auto to save the setting. Now, command echoing will be disabled.

## 7.2 Error Messages

Below is a table of errors and their descriptions that may be prompted during operation or a self test of the multimeter.

Number	Description
ERR:-100	Ram self check failed
ERR:-200	DCV Calibrate Data is lost
ERR:-201	DCV Short Data is lost
ERR:-210	ACV Calibrate Data is lost
ERR:-211	ACV Short Data is lost
ERR:-220	DCI Calibrate Data is lost
ERR:-221	DCI open Data is lost.
ERR:-230	ACI Calibrate Data is lost
ERR:-231	ACI short data is lost
ERR:-240	R2 Calibrate Data is lost
ERR:-241	R2 short Data is lost
ERR:-250	R4 Calibrate Data is lost
ERR:-251	R4 short data is lost
ERR:-260	Eeprom cannot Write.
ERR:-300	Adc No Unk
ERR:-301	Adc No End
ERR:-303	Adc No Count

# Chapter 8      Specifications

## 8.1      Technical Specifications

### Specifications Assumptions

- One year calibration cycle.
- Operating temperature between 18°C to 28°C
- Accuracy is expressed as:  $\pm(\% \text{ of reading} + \% \text{ of range})$  after a 30 minute warm up and valid for 10 PLC (slow)
- Temperature Coefficient: add  $\pm [0.1\% \times (\text{the applicable accuracy}) / ^\circ\text{C}]$  for 0°C to 18°C and 28°C to 40°C;
- Relative Humidity: Up to 80% for 0°C to 28°C (75% RH for 10 M $\Omega$  and above ranges of resistance measurement). Up to 70 for 28°C to 40°C.

### Displayed Readings and Reading rates

#### Full Scale displayed reading

Slow	Med	Fast
119,999	119,999	11,999

#### Reading rates on front panel (Reading/sec, Approximate)

Measurement Function	Slow	Med	Fast
DCV	4	16	57
DCA	4	16	57
ACV	3	4	25
ACA	3	4	25
2-Wire $\Omega$ (Ranges below 120 k $\Omega$ )	4	16	57
2-Wire $\Omega$ (120 k $\Omega$ range and above)	4	16	25
4-Wire $\Omega$ (Ranges below 120 k $\Omega$ )	3	10	33
4-Wire $\Omega$ (120 k $\Omega$ range and above)	3	10	20
Freq	1	————	————
Period	1	————	————
Diode	————	16	————
Continuity	————	————	57

## Specifications

---

### DC CHARACTERISTICS

CONDITIONS: SLOW or MED with filter count of 10

#### DC Voltage

Resolution, Full Scale reading and Accuracy  $\pm$  (% of reading + % of range), 23 °C  $\pm$  5 °C

Rate	Range	Resolution	Typical Input Impedance	Accuracy (1 year)	Full Scale Reading
Slow	120.000 mV	1 $\mu$ V	>10G	0.02+0.008 <sup>(1)</sup>	119.999
	1.20000 V	10 $\mu$ V	>10G	0.01+0.004 <sup>(1)</sup>	1.19999
	12.0000 V	100 $\mu$ V	>10G	0.01+0.004	11.9999
	120.000 V	1 mV	10M $\pm$ 1%	0.01+0.004	119.999
	1000.00 V	10 mV	10M $\pm$ 1%	0.01+0.004	1010.00 <sup>(2)</sup>
Med	120.000 mV	1 $\mu$ V	>10G	0.02+0.015 <sup>(1)</sup>	119.999
	1.20000 V	10 $\mu$ V	>10G	0.01+0.008 <sup>(1)</sup>	1.19999
	12.0000 V	100 $\mu$ V	>10G	0.01+0.008	11.9999
	120.000 V	1 mV	10M $\pm$ 1%	0.01+0.008	119.999
	1000.00 V	10 mV	10M $\pm$ 1%	0.01+0.008	1010.00 <sup>(2)</sup>
Fast	120.00 mV	10 $\mu$ V	>10G	0.02+0.040 <sup>(1)</sup>	119.99
	1.2000 V	100 $\mu$ V	>10G	0.02+0.020 <sup>(1)</sup>	1.1999
	12.000 V	1 mV	>10G	0.02+0.020	11.999
	120.00 V	10 mV	10M $\pm$ 1%	0.02+0.020	119.99
	1000.0 V	100 mV	10M $\pm$ 1%	0.02+0.020	1010.0 <sup>(2)</sup>
<sup>(1)</sup> under REL status					
<sup>(2)</sup> 1% over-range (1010 V) is readable at 1000 V range					

Maximum input voltage: 1000VDC or peak ac for all ranges.

## Specifications

### DC Current

Rate	Range	Resolution	Full Scale Reading	Accuracy (1 year)	Burden Voltage <sup>(1)</sup> & Shunt Resistor
Slow	12.0000mA	0.1 $\mu$ A	11.9999	0.05+0.008 <sup>(2)</sup>	<0.15 V / 10.1 $\Omega$
	120.000mA	1 $\mu$ A	119.999	0.05+0.004 <sup>(2)</sup>	<1.5 V / 10.1 $\Omega$
	1.20000 A	10 $\mu$ A	1.19999	0.10+0.004	<0.3 V / 0.1 $\Omega$
	12.0000 A <sup>(3)</sup>	100 $\mu$ A	11.9999	0.25+0.004	<0.15 V / 10 m $\Omega$
Med	12.0000mA	0.1 $\mu$ A	11.9999	0.05+0.015 <sup>(2)</sup>	<0.15 V / 10.1 $\Omega$
	120.000mA	1 $\mu$ A	119.999	0.05+0.008 <sup>(2)</sup>	<1.5 V / 10.1 $\Omega$
	1.20000 A	10 $\mu$ A	1.19999	0.10+0.008	<0.3 V / 0.1 $\Omega$
	12.0000 A <sup>(3)</sup>	100 $\mu$ A	11.9999	0.25+0.008	<0.15 V / 10 m $\Omega$
Fast	12.000mA	1 $\mu$ A	11.999	0.10+0.02 <sup>(2)</sup>	<0.15 V / 10.1 $\Omega$
	120.00mA	10 $\mu$ A	119.99	0.10+0.02 <sup>(2)</sup>	<1.5 V / 10.1 $\Omega$
	1.2000 A	100 $\mu$ A	1.1999	0.10+0.02	<0.3 V / 0.1 $\Omega$
	12.000 A <sup>(3)</sup>	1 mA	11.999	0.25+0.02	<0.15 V / 10 m $\Omega$

(1) Typical voltage across the input terminals at full scale reading.  
 (2) Use REL function  
 (3) In 12A range, >10-12 A is readable for 20 seconds maximum

## TRUE RMS AC CHARACTERISTICS

### AC Voltage

#### Resolution and Full Scale Reading

Range	Resolution		Full Scale Reading	
	Slow & Med	Fast	Slow & Med	Fast
120.000 mV	1 $\mu$ V	10 $\mu$ V	119,999	119.99
1.20000 V	10 $\mu$ V	100 $\mu$ V	1.19999	1.1999
12.0000 V	100 $\mu$ V	1 mV	11.9999	11.999
120.000 V	1 mV	10 mV	119.999	119.99
750.00 V	10 mV	100 mV	757.50 <sup>(1)</sup>	757.5 <sup>(1)</sup>

(1) 1% over- range (757.5V) is readable at 750 V range.

### Accuracy

Rate	Range	Accuracy (1 year) $\pm$ (% of reading + % of range), 23°C $\pm$ 5°C <sup>(1)</sup>				
		10~20 Hz	20~50 Hz	50~20 kHz	20~50 kHz	50~100 kHz
Slow	120.000 mV	1.50+0.100	0.50+0.100	0.10+0.100	0.30+0.150	1.0+0.150
	1.20000 V	1.50+0.100	0.50+0.100	0.10+0.100	0.30+0.100	1.0+0.100
	12.0000 V	1.50+0.100	0.50+0.100	0.10+0.100	0.30+0.100	1.0+0.100
	120.000 V	1.50+0.100	0.50+0.100	0.10+0.100	0.30+0.100	1.0+0.100
	750.00 V	1.50+0.100	0.50+0.100	0.10+0.100	0.30+0.100 <sup>(2)</sup>	1.0+0.100 <sup>(1)</sup>



## Specifications

Med	120.000 mV	1.50+0.200	0.50+0.200	0.10+0.200	0.30+0.300	1.0+0.300
	1.20000 V	1.50+0.150	0.50+0.150	0.10+0.150	0.30+0.200	1.0+0.200
	12.0000 V	1.50+0.150	0.50+0.150	0.10+0.150	0.30+0.200	1.0+0.200
	120.000 V	1.50+0.150	0.50+0.150	0.10+0.150	0.30+0.200	1.0+0.200
	750.00 V	1.50+0.150	0.50+0.150	0.10+0.150	0.30+0.200 <sup>(2)</sup>	1.0+0.200 <sup>(1)</sup>
Fast	120.00 mV		1.50+0.30	0.20+0.15	0.50+0.15	1.5+0.15
	1.2000 V		1.50+0.20	0.20+0.10	0.50+0.10	1.5+0.10
	12.000 V		1.50+0.20	0.20+0.10	0.50+0.10	1.5+0.10
	120.00 V		1.50+0.20	0.20+0.10	0.50+0.10	1.5+0.10
	750.0 V		1.50+0.20	0.20+0.10	0.50+0.10 <sup>(2)</sup>	1.5+0.10 <sup>(1)</sup>
Max. crest factor: 3.0 at full scale						
<sup>(1)</sup> Specifications are for sine wave inputs >5% of the range						
<sup>(2)</sup> $\leq 3 \times 10^7$ Volt-Hz at 750 VAC range						

**Maximum input voltage:** 750 Vrms

$\leq 3 \times 10^7$  Volt-Hz for all ranges

**Input impedance:** 1 M $\Omega$ ±2% in parallel with capacitance <100 pF

**Maximum DCV:** 500V for all AC ranges

### AC Current (True RMS, AC Coupling)

#### Resolution and Full Scale Reading

Rate	Range	Resolution	Full Scale Reading	Burden Voltage <sup>(1)</sup> & Shunt Resistor
Slow	12.0000mA	0.1 $\mu$ A	11.9999	<0.15 V / 10.1 $\Omega$
	1.20000 A	10 $\mu$ A	1.19999	<0.3 V / 0.1 $\Omega$
	12.0000 A <sup>(2)</sup>	100 $\mu$ A	11.9999	<0.15 V / 10 m $\Omega$
Med	12.0000mA	0.1 $\mu$ A	11.9999	<0.15 V / 10.1 $\Omega$
	1.20000 A	10 $\mu$ A	1.19999	<0.3 V / 0.1 $\Omega$
	12.0000 A <sup>(2)</sup>	100 $\mu$ A	11.9999	<0.15 V / 10 m $\Omega$
Fast	12.000mA	1 $\mu$ A	11.999	<0.15 V / 10.1 $\Omega$
	1.2000 A	10 $\mu$ A	1.1999	<0.3 V / 0.1 $\Omega$
	12.000 A <sup>(2)</sup>	1 mA	11.999	<0.15 V / 10 m $\Omega$
<sup>(1)</sup> Typical voltage across the input terminals at full scale reading.				
In 12A range, >10-12 A <sub>AC</sub> is readable for 20 seconds maximum				

### Accuracy

Rate	Range	Accuracy (1 year) $\pm$ (% of reading + % of range), 23°C $\pm$ 5°C <sup>(1)</sup>			
		10~20 Hz	20~50 Hz	50~2 kHz	2~10 kHz
Slow	12.0000 mA	1.0+0.080	0.50+0.080	0.25+0.080	2.0+0.080
	1.20000 A	1.0+0.080	0.50+0.080	0.25+0.080	2.0+0.080
	12.0000 A	1.0+0.080	0.50+0.080	0.25+0.080	2.0+0.080

## Specifications

Med	12.0000 mA	1.0+0.150	0.50+0.150	0.25+0.150	2.0+0.150
	1.20000 A	1.0+0.150	0.50+0.150	0.25+0.150	2.0+0.150
	12.0000 A	1.0+0.150	0.50+0.150	0.25+0.150	2.0+0.150
Fast	12.000 mA		1.0+0.20	0.5+0.10	3.0+0.10
	1.2000 A		1.0+0.20	0.5+0.10	3.0+0.10
	12.000 A		1.0+0.20	0.5+0.10	3.0+0.10
Max. crest factor: 3.0 at full scale					
<sup>(1)</sup> Specifications are for sine wave inputs >5% of the range					

Maximum Input and Overload Current Protection: 2A/ 250V fuse.

### Resistance (2-Wire and 4-Wire)

Accuracy  $\pm$  (% of reading + % of range), 23°C  $\pm$ 5°C

Rate	Range <sup>(1)</sup>	Resolution	Full Scale Reading	Test Current	Accuracy (1 year)
Slow	120.000 $\Omega$	1 m $\Omega$	119.999	1 mA	0.05 +0.008 <sup>(2)</sup>
	1.20000 k $\Omega$	10 m $\Omega$	1.19999	1 mA	0.03 +0.004 <sup>(2)</sup>
	12.0000 k $\Omega$	100 m $\Omega$	11.9999	100 $\mu$ A	0.03 +0.004 <sup>(2)</sup>
	120.000 k $\Omega$	1 $\Omega$	119.999	10 $\mu$ A	0.03 +0.004
	1.20000 M $\Omega$	10 $\Omega$	1.19999	10 $\mu$ A	0.03 +0.004
	12.0000 M $\Omega$	100 $\Omega$	11.9999	7.0/(10M+Rx) $\mu$ A	0.10 +0.004
	120.000 M $\Omega$	1 k $\Omega$	119.999	7.0/(10M+Rx) $\mu$ A	0.50 +0.008
Med	120.000 $\Omega$	1 m $\Omega$	119.999	1 mA	0.05 +0.015 <sup>(2)</sup>
	1.20000 k $\Omega$	10 m $\Omega$	1.19999	1 mA	0.03 +0.008 <sup>(2)</sup>
	12.0000 k $\Omega$	100 m $\Omega$	11.9999	100 $\mu$ A	0.03 +0.008 <sup>(2)</sup>
	120.000 k $\Omega$	1 $\Omega$	119.999	10 $\mu$ A	0.03 +0.008
	1.20000 M $\Omega$	10 $\Omega$	1.19999	10 $\mu$ A	0.03 +0.008
	12.0000 M $\Omega$	100 $\Omega$	11.9999	7.0/(10M+Rx) $\mu$ A	0.10 +0.008
	120.000 M $\Omega$	1 k $\Omega$	119.999	7.0/(10M+Rx) $\mu$ A	0.50 +0.015
Fast	120.000 $\Omega$	10 m $\Omega$	119.99	1 mA	0.05 +0.02 <sup>(2)</sup>
	1.20000 k $\Omega$	100 m $\Omega$	1.1999	1 mA	0.03 +0.02 <sup>(2)</sup>
	12.0000 k $\Omega$	1 $\Omega$	11.999	100 $\mu$ A	0.03 +0.02 <sup>(2)</sup>
	120.000 k $\Omega$	10 $\Omega$	119.99	10 $\mu$ A	0.03 +0.02
	1.20000 M $\Omega$	100 $\Omega$	1.1999	10 $\mu$ A	0.05 +0.02
	12.0000 M $\Omega$	1 k $\Omega$	11.999	7.0/(10M+Rx) $\mu$ A	0.10 +0.02
	120.000 M $\Omega$	10 k $\Omega$	119.99	7.0/(10M+Rx) $\mu$ A	0.50 +0.02
<sup>(1)</sup> In order to eliminate the noise interference, which might be induced to the test leads, it is recommended to use a shielded test cable for measuring resistance above 120 k $\Omega$ .					
<sup>(2)</sup> Using REL function					
Note: Rx is the measured resistance value.					

## Specifications

---

**Maximum Input Protection:** 1000VDC or 750VAC for all ranges.

**Open circuit voltage:** Maximum voltage is 13.3 VDC for 120 Ω, 1.2 kΩ, 12 Ω, 12 MΩ and 120 MΩ ranges.

Maximum voltage is 7 VDC for 120 kΩ and 1.2M ranges.

### Continuity

**Accuracy ± (% of reading + % of range), 23°C ±5°C**

Rate	Range	Resolution	Full Scale Reading	Test Current	Accuracy (1 year)
Fast	1 kΩ	100 mΩ	999.9	1 mA	0.10+0.020

Maximum Input Protection: 1000VDC or 750VAC for all ranges.

**Open circuit voltage:** <13.3 VDC

**Test Current:** Approximately 1 mA DC

**Threshold resistance:** From 1 Ω to 1000 Ω, default of power on is 10 Ω

### Diode

**Accuracy ± (% of reading + % of range), 23°C ±5°C**

Rate	Range	Resolution	Full Scale Reading	Test Current	Accuracy (1 year)
Med	3.0000 V	100 μV	2.9999	1 mA	0.030+0.020
	10.0000 V	100 μV	10.0000	100 μA	0.030+0.020
	10.0000 V	100 μV	10.0000	10 μA	0.030+0.020

Maximum Input Protection: 1000VDC or 750VAC for all ranges.

## Specifications

### FREQUENCY AND PERIOD CHARACTERISTICS

CONDITIONS: SLOW RATE (GATE TIME 1 Sec)

#### Frequency

Accuracy: ± (% of Reading)

ACV Range	Frequency Range	Gate Time	Resolution	Full Scale Reading	Accuracy <sup>(2)</sup>	Input Sensitivity (Sine Wave)
100 mV to 750 V	5 ~ 10 Hz	1 s (Slow)	10 µHz	9.99999	0.05	200 mVrms
	10 ~ 100Hz		100 µHz	99.9999	0.01	40 mVrms
	100 ~ 100 kHz		1 mHz	999.999	0.005	40 mVrms
	100 k ~ 1 MHz <sup>(1)</sup>		1 Hz	999.999	0.005	100 mVrms

<sup>(1)</sup> If testing frequency is greater than 1MHz, it will be displayed but no specified accuracy is guaranteed.

<sup>(2)</sup> Specified accuracy at input >5 % of range.

#### Period

ACV Range	Period Range	Gate Time	Resolution	Full Scale Reading	Accuracy <sup>(2)</sup>	Input Sensitivity (Sine Wave)
100 mV to 750 V	1 ~ 10 µs <sup>(1)</sup>	1 s (Slow)	0.01 ns	9.99999	0.005	100 mVrms
	10 µs ~ 10 ms		0.1 ns	9.99999	0.005	40 mVrms
	10 ms ~ 100 ms		0.1 µs	99.9999	0.01	40 mVrms
	100 ms ~ 200 ms		1 µs	199.999	0.05	200 mVrms

<sup>(1)</sup> If testing frequency is greater than 1MHz, it will be displayed but no specified accuracy is guaranteed.

<sup>(2)</sup> Specified accuracy at input >5 % of range.

Maximum Crest factor: 3.0 at full scale

Maximum input voltage: 750Vrms

$\leq 3 \times 10^7$  Volt-Hz for all ranges

**Input impedance:** 1 MΩ ± 2% in parallel with capacitance <100pF

**Maximum DCV:** 500 V for all AC ranges

**Triggering and Memory** Trigger Delay: 0 to 6000ms (1 ms step size)

Memory: 512 readings can be stored

#### Math Functions

Rel, Max/Min/Average/StdDev (for stored readings), dB, dBm, Limit Test, % and mX+b

dBm Reference Resistance: 1 Ω to 9999 Ω (1Ω step size)

## Specifications

---

### Standard Programming Languages

SCPI (Standard Commands for Programmable Instruments)

### Remote Interface

(optional) GPIB (model 5492BGPIB only), USB and RS-232C

### General Specifications

**Power Supply:** 110/220V  $\pm$  10%

**Power Line Frequency:** 50/60Hz  $\pm$ 5%

**Power Consumption:**  $\leq$  20 VA

**Operating Environment:** 0 °C to 40 °C,  $\leq$ 90 %RH

**Storage Environment:** -40 °C to 70 °C

**Dimensions (W×H×D):** 225 mm x 100 mm x 355 mm

**Net Weight:** Approx. 2.5 kg

**Warranty Period:** 3 years