

C.A 6418













Oblong ground tester clamp

Thank you for purchasing this **C.A 6418 oblong ground tester clamp**.

For best results from your instrument:

- **read** these operating instructions carefully,
- **comply with** the precautions for use.

	WARNING, risk of DANGER! The operator must refer to these instructions whenever this danger symbol appears.
	Equipment protected throughout by double insulation.
	Battery.
	Application or withdrawal authorized on uninsulated or bare conductors at dangerous. Type A current sensor per IEC 61010 2 032.
	Information or useful tip.
	The product has been declared recyclable after analysis of its life cycle in accordance with the ISO 14040 standard.
	Chauvin Arnoux has adopted an Eco-Design approach in order to design this appliance. Analysis of the complete lifecycle has enabled us to control and optimize the effects of the product on the environment. In particular this appliance exceeds regulation requirements with respect to recycling and reuse.
	
	The CE marking indicates conformity with European directives, in particular LVD and EMC.
	The rubbish bin with a line through it indicates that, in the European Union, the product must undergo selective disposal in compliance with Directive WEEE 2002/96/EC. This equipment must not be treated as household waste.

Definition of measurement categories

- Measurement category IV corresponds to measurements taken at the source of low-voltage installations.
Example: power feeders, counters and protection devices.
- Measurement category III corresponds to measurements on building installations.
Example: distribution panel, circuit-breakers, machines or fixed industrial devices.
- Measurement category II corresponds to measurements taken on circuits directly connected to low-voltage installations.
Example: power supply to domestic electrical appliances and portable tools.

PRECAUTIONS FOR USE

This instrument is compliant with safety standard IEC 61010-2-032, for voltages up to 100V in category IV or 150V in category III.

Failure to observe the safety instructions may result in electric shock, fire, explosion, and destruction of the instrument and of the installations.

- The operator and/or the responsible authority must carefully read and clearly understand the various precautions to be taken in use. The operator and/or the responsible authority must carefully read and clearly understand the various precautions to be taken in use. Sound knowledge and a keen awareness of electrical hazards are essential when using this instrument.
- If you use this instrument other than as specified, the protection it provides may be compromised, thereby endangering you.
- The safety of any system in which this instrument might be incorporated is the responsibility of the integrator of the system.
- Do not use the clamp above its rated frequency, since this might cause it to overheat dangerously.
- Do not use the instrument on networks of which the voltage or category exceeds those mentioned.
- Observe the environmental conditions of use.
- Do not use the instrument if it seems to be damaged, incomplete, or poorly closed.

- Before each use, check the condition of the insulation on the housing. Any item of which the insulation is deteriorated (even partially) must be set aside for repair or scrapping.
- Before using your instrument, check that it is perfectly dry. If it is wet, it must be thoroughly dried before it can be connected or used.
- When handling the instrument, keep your fingers behind the physical guard.
- Avoid impacts on the measurement head, in particular the air gap.
- Keep the surfaces of the air gap clean; even a little dirt can cause the clamp to malfunction.
- Use personal protection equipment systematically.
- All troubleshooting and metrological checks must be done by competent accredited personnel.

CONTENTS

1. PRESENTATION	4
1.1. Unpacking.....	4
1.2. Description of the device	4
1.3. Function keys	6
1.4. Display.....	6
1.5. Inserting the batteries	7
1.6. Setting the date and time.....	7
2. USE.....	8
2.1. General.....	8
2.2. Impedance and current measurement.....	8
2.3. Current measurement.....	10
2.4. Configuring the instrument (Set-up)	11
2.5. Adjustment.....	12
2.6. Errors.....	14
2.7. Automatic stop	14
2.8. Storage	15
3. TECHNICAL CHARACTERISTICS	17
3.1. General reference conditions	17
3.2. Electrical characteristics	17
3.3. Variation in the domain of use	18
3.4. Power supply	19
3.5. Environmental conditions	19
3.6. Mechanical characteristics	20
3.7. Compliance with international standards	20
3.8. Electromagnetic compatibility (EMC).....	20
4. MAINTENANCE.....	21
4.1. Cleaning	21
4.2. Replacement of the batteries.....	21
5. WARRANTY	23

1. PRESENTATION

1.1. UNPACKING

1.1.1. DELIVERY CONDITION

The instrument is delivered in a carrying case containing:

- 4 LR6 or AA batteries.
- A wrist strap
- One CD containing the operating manuals (one file per language).
- One multilingual safety data sheet.
- One multilingual quick start guide.
- One verification certificate.

1.1.2. ACCESSORIES

CL1 calibration loop.

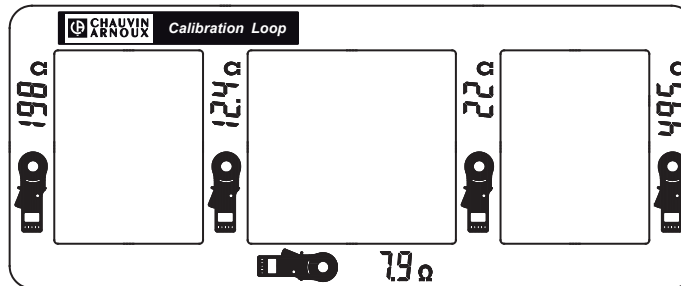

1.1.3. REPLACEMENT PARTS

- Carrying case MLT110.
- Set of 12 LR6 or AA batteries.

For the accessories and spares, consult our web site:

www.chauvin-arnoux.com

1.2. DESCRIPTION OF THE DEVICE

The C.A 6418 is used to make loop impedance measurements in a parallel earth network, for example for power distribution poles, overhead contact lines, etc. These measurements are simpler to perform than the traditional measurements with two auxiliary rods.

The C.A 6418 can make loop impedances measurements with good accuracy at low values, and AC current measurements.

The C.A 6418 is simple to use. Its large measurement head can clamp bars up to 30x40mm.

Its memory function is used to record and read back the measurements.

Its OLED (Organic Light Emitting Diode) display unit is very easy to read, even in direct sunlight.

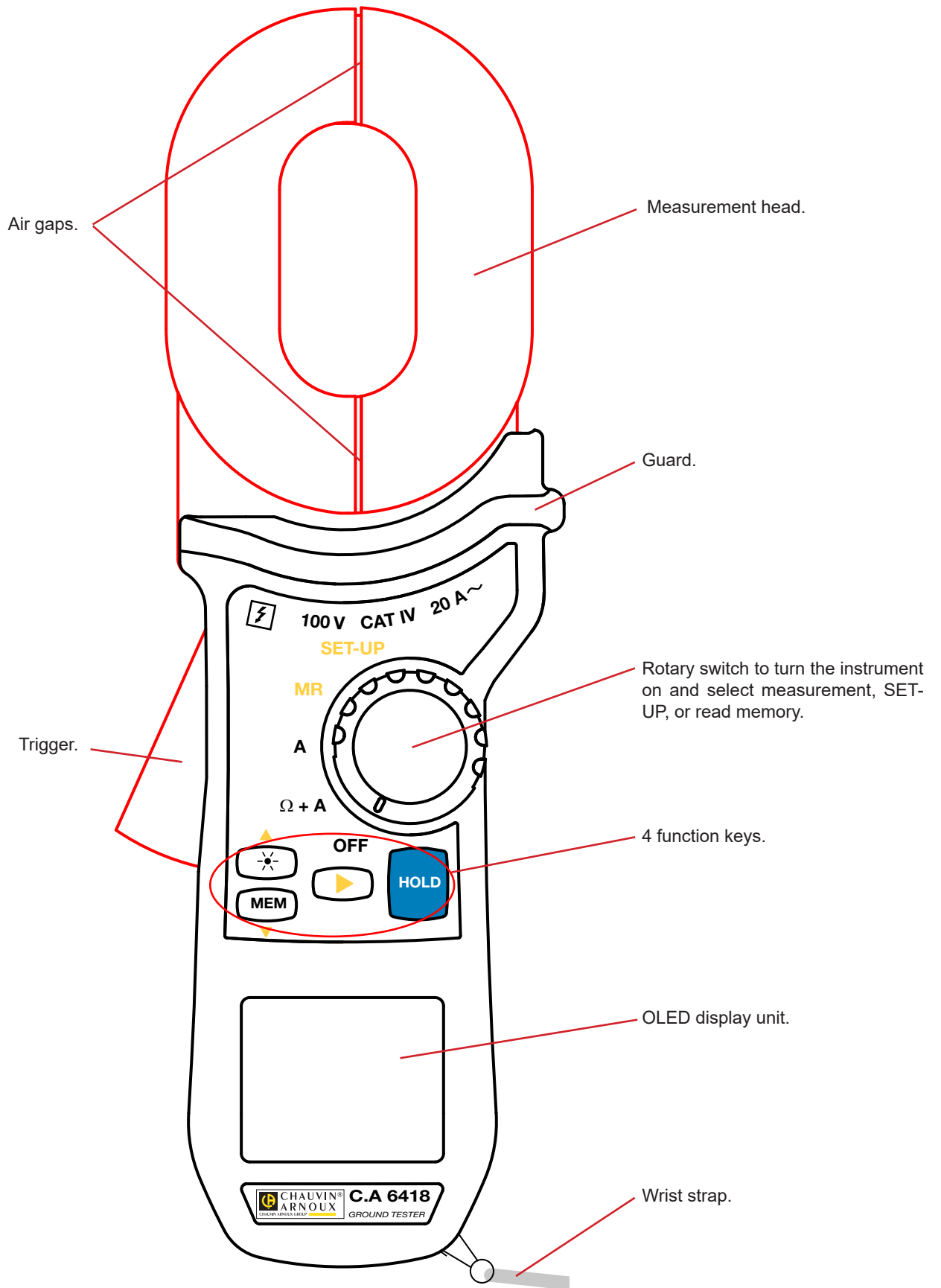

1.3. FUNCTION KEYS

As a general rule, the functions shown in white on the keys are available when the switch is set to **Ω+A** or **A**. And the yellow arrows (▲, ▼ and ►) are available when the switch is set to **MR** or **SET-UP**.

Key	Function
☼	The ☼ key is used to switch the display unit backlighting on and off.
MEM	The MEM key is used to record the measurement displayed.
HOLD	The HOLD key is used to freeze, then unfreeze, the display of the measurement.
▲ ▼	The ▲ and ▼ keys are used: <ul style="list-style-type: none"> ■ to browse in the SET-UP menu and change the value of the parameter selected, ■ to browse in memory read (MR).
►	<ul style="list-style-type: none"> ■ When the switch is set to Ω+A or A, a long press on the ► key activates or deactivates the audible signal. ■ When the switch is set to SET-UP, the ► key can be pressed to browse in the menu and confirm the changes made. ■ When the switch is set to MR, pressing the ► key toggles the display between the measurement and the date and time.

1.4. DISPLAY

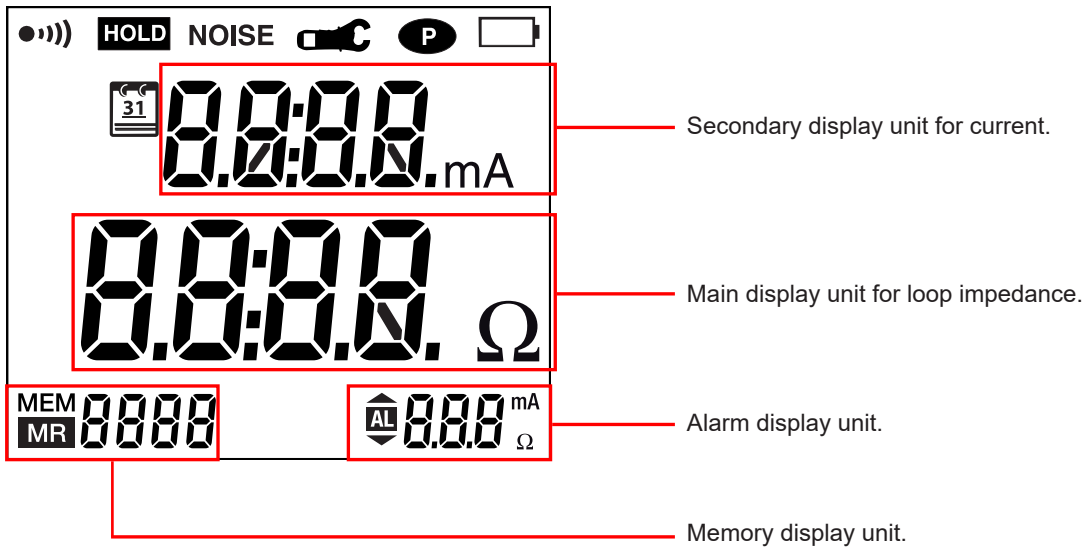

When the measurement exceeds the limits of the measurement range, the instrument displays **OR**.

1.5. INSERTING THE BATTERIES

Refer to §4.2.

1.6. SETTING THE DATE AND TIME

During the first use, set the date and time of your instrument. When you switch it on by turning the switch to **Ω+A**, the instrument prompts you to set the date.

The year blinks. Set it using the ▲ and ▼ keys.

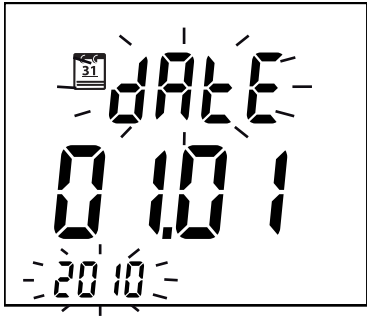

Then press the ► key to make the month blink. Set it using the ▲ and ▼ keys.

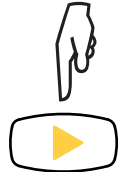
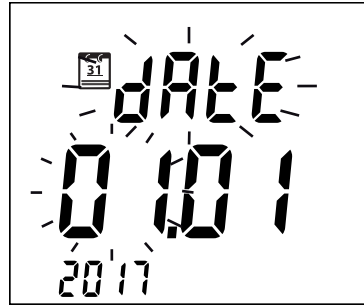

Press the ► key. The date blinks. Set it using the ▲ and ▼ keys and confirm with the ► key.

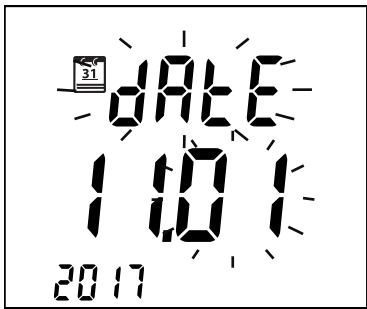

The instrument then displays the time to be set. First choose 24h or 12h (A or P) form using the ▲ and ▼ keys.

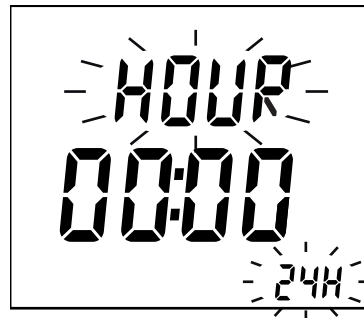

Confirm with the ► key. The hours reading blinks. Set it using the ▲ and ▼ keys and confirm with the ► key.

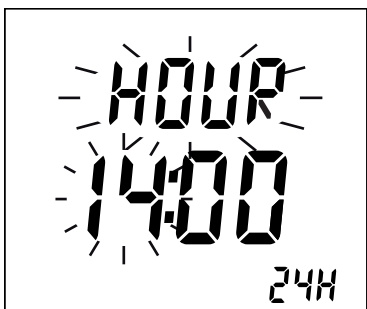

The minutes reading blinks. Set it using the ▲ and ▼ keys and confirm with the ► key.

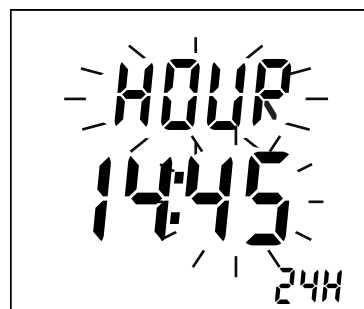

2. USE

2.1. GENERAL

When switched on, the instrument makes an adjustment. The jaws of the clamp must therefore be closed and there must not be any conductor in the measurement head.

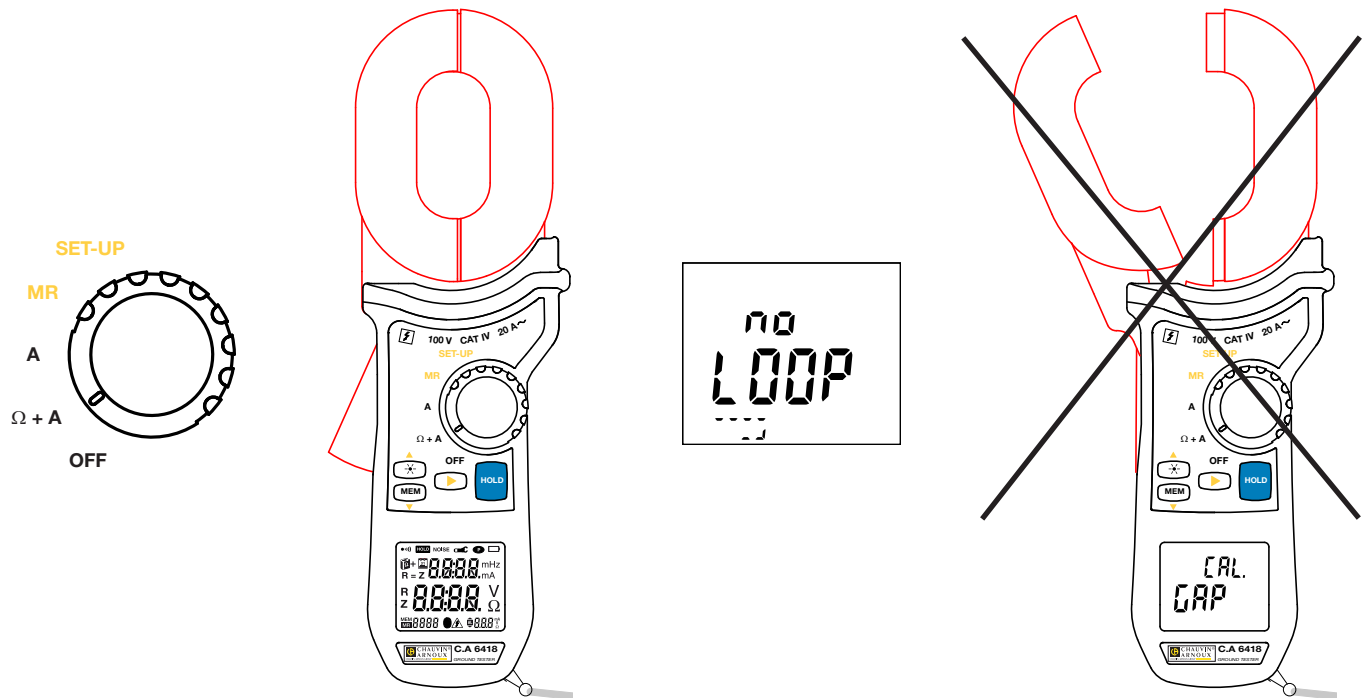

If the instrument fails to make the adjustment, it reports an error by displaying **Err. CAL.** If this happens, switch the instrument off, check that the air gaps are clean, then switch the instrument back on.

2.2. IMPEDANCE AND CURRENT MEASUREMENT

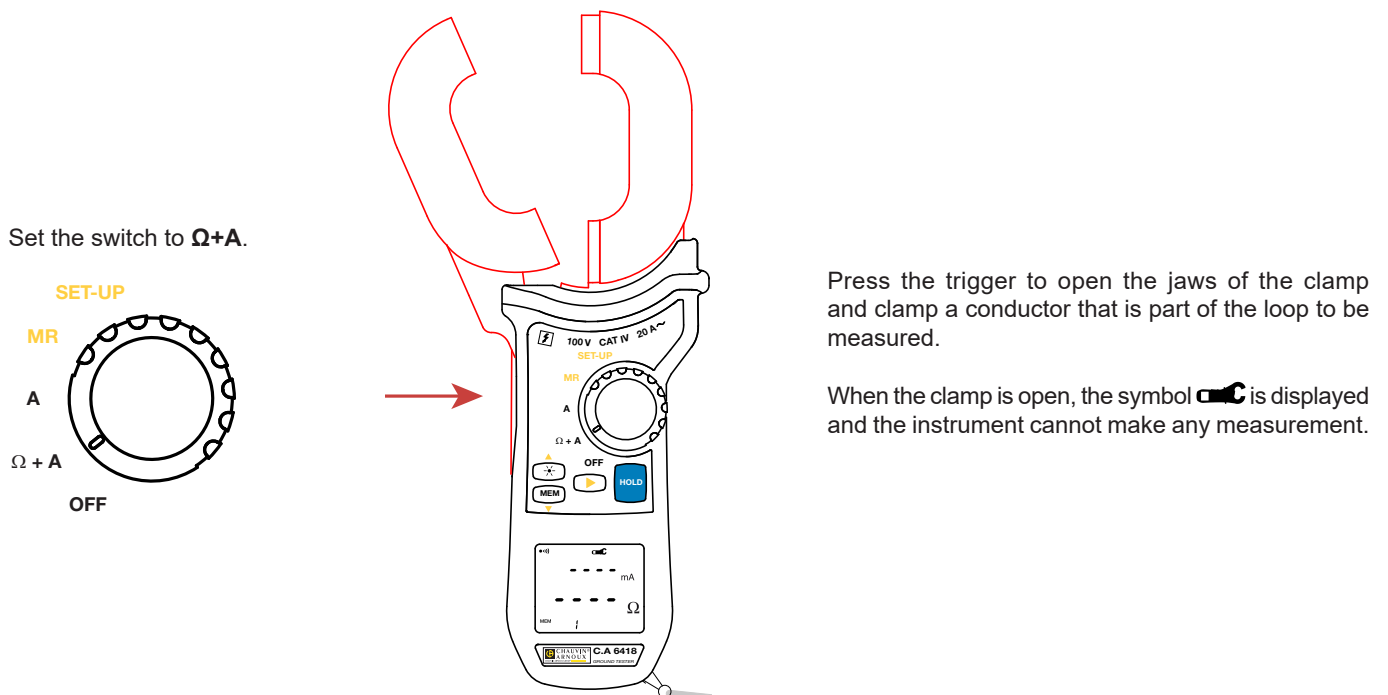

2.2.1. CONNECTION

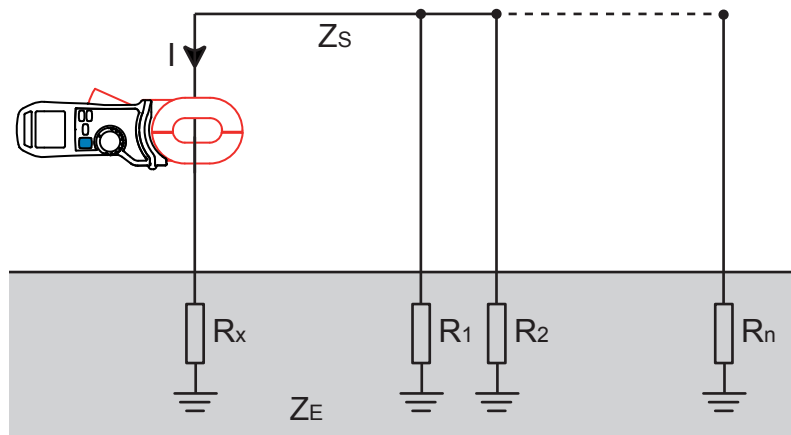

The earth electrode to be measured, R_x , is in parallel with the others via earth Z_E and guard wire Z_s .

The impedance measured by the clamp is slightly greater than R_x . In the case of a regular check, a sudden change in the value measured shows that there is a problem.

For a first-time measurement, for greater accuracy, it is best to make an earth measurement with rods. The C.A 6418 will then be used for subsequent checks.



During the impedance measurement, the instrument emits a discontinuous audible signal (beep, beep). This sound cannot be eliminated because it is due to the measurement frequency that flows in the measurement head. The sound can vary as a function of the frequency and amplitude of the current measured.

2.2.2. AFTER THE MEASUREMENT

Once the measurement has stabilized, you can press the **HOLD** key to freeze it and/or **MEM** to record it.

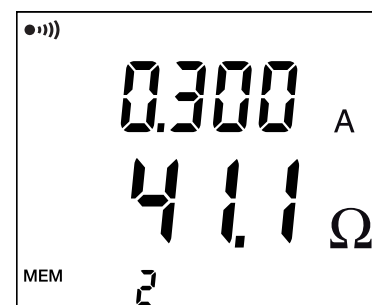
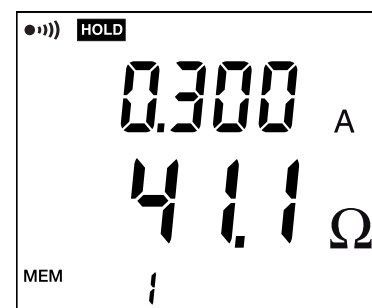
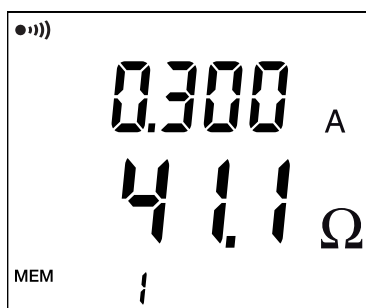

2.2.3. PRE-HOLD FUNCTION

You can also use the pre-HOLD function (see §2.4), which freezes the measurement automatically when the jaws of the clamp are opened. This can be useful when you have only one hand free to make a measurement.

2.2.4. ALARMS

To facilitate making the measurements, you can program an alarm on the impedance measurement value (see §2.4) and/or the current measurement value (see §2.4). You then know whether the measurement is OK without looking at the display unit.

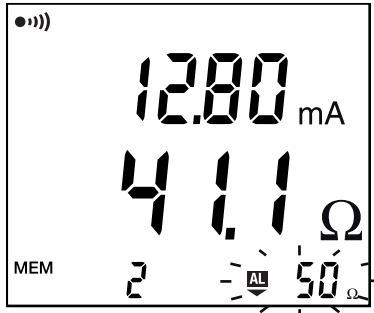

The alarm part of the display unit blinks and the instrument emits a continuous audible signal.

To eliminate this audible signal, press and hold the ► key.

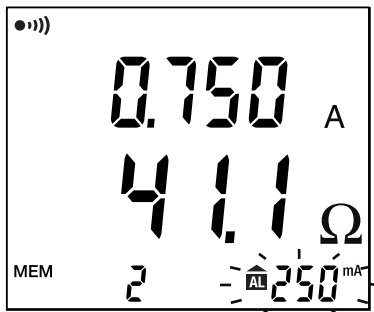

If you set alarms on both the impedance and the current and both alarm thresholds are exceeded, it is the alarm on the current that has priority.

2.3. CURRENT MEASUREMENT

The current measurement alone is identical to the current measurement with the impedance measurement.

Set the switch to A.

Press the trigger to open the jaws of the clamp and clamp the conductor in which the current to be measured flows.

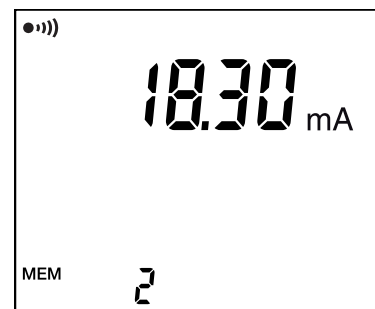
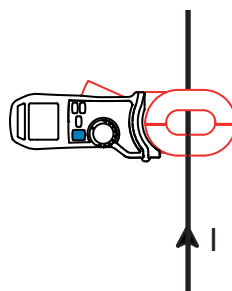
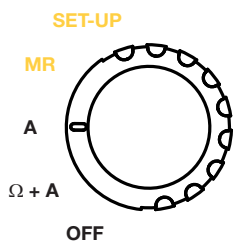

Once the measurement has stabilized, you can press the **HOLD** key to freeze it and/or **MEM** to record it.

You can also use the pre-HOLD function (see §2.4), which freezes the measurement automatically when the jaws of the clamp are opened. This can be useful when you do not have both hands free to make a measurement.

To facilitate making the measurements, you can program an alarm on the current measurement value (see §2.4). You then know whether the measurement is OK without looking at the display unit.

2.4. CONFIGURING THE INSTRUMENT (SET-UP)

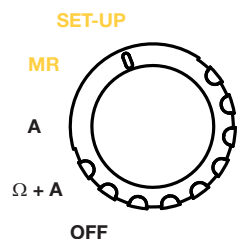

Set the switch to **SET-UP**.

Use the ▼ and ▲ keys to scroll through the various screens of the SET-UP menu.

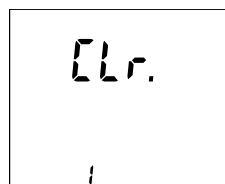

CLR (erase memory) menu.

Press the ► key to enter the CLR menu.

To cancel, press the ► key.

To erase all of the records, press and hold the ▲ and ▼ keys simultaneously. The instrument emits 5 audible beeps before erasing the memory.

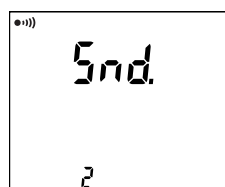

SND menu (activation of the sound).

Press the ► key to enter the SND menu. Use the ▲ and ▼ keys to display or hide the ●))) symbol.

When it is displayed, the instrument emits an audible signal when keys are pressed and when alarm thresholds are crossed.

Confirm with the ► key.

During the measurements (when the switch is set to Ω+A or A), a long press on the ► key activates or deactivates the audible signal.

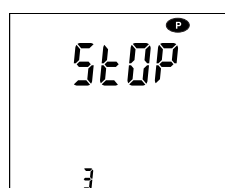

STOP menu (automatic standby).

Press the ► key to enter the STOP menu. Use the ▲ and ▼ keys to display or hide the ●P symbol (permanent operation).

When it is displayed, automatic switching of the instrument to standby at the end of 5 minutes is disabled.

Confirm with the ► key.

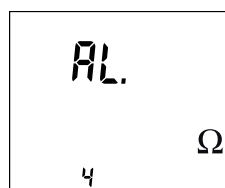

ALΩ menu (loop impedance alarm).

Press the ► key to enter the ALΩ menu. Use the ▲ and ▼ keys to scroll through the display:

- 10 Ω: there is no impedance measurement alarm.
- 10 Ω: there is an alarm when the impedance is >10Ω.
- 10 Ω: there is an alarm when the impedance is <10Ω.

Press the ► key to make the alarm threshold blink. Set it using the ▲ and ▼ keys, between 1 and 199Ω. A long press scrolls the values faster.

Confirm with the ► key.

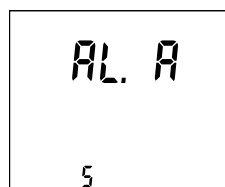

AL A menu (current alarm).

Press the ► key to enter the AL A menu. Use the ▲ and ▼ keys to scroll through the display:

- 30 mA: there is no current measurement alarm.
- 30 mA: there is an alarm when the current is >30mA.

Press the ► key to make the alarm threshold blink. Set it using the ▲ and ▼ keys, between 1mA and 20.0 A. A long press scrolls the values faster.

Confirm with the ► key.

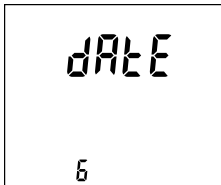

DATE menu (setting of the date).

Press the ► key to enter the DATE menu. Use the ▲ and ▼ keys to set the year. Press the ► key to make the month blink. Set it using the ▲ and ▼ keys. Do the same for the day and confirm with the ► key. For a more detailed procedure, see §1.6.



HOUR menu (setting of the time).

Press the ► key to enter the HOUR menu. Use the ▲ and ▼ keys to choose 24h or 12h (A or P) form. Press the ► key for make the hours blink. Set them using the ▲ and ▼ keys. Press the ► key to make the minutes blink. Set them using the ▲ and ▼ keys and confirm with the ► key. For a more detailed procedure, see §1.6.



HOLD menu (activation of the pre-HOLD function).

Press the ► key to enter the pre-HOLD menu. Use the ▲ and ▼ keys to display or hide the  symbol. When it is displayed, the pre-HOLD function is activated. This means that, if the measurement is stable, it is frozen when the clamp is opened. Confirm with the ► key.

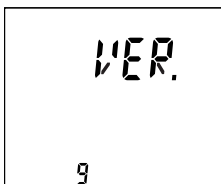

VER menu (display of the software version).

Press the ► key to see the software version number. Press the ▼ key to display the serial number of the instrument.

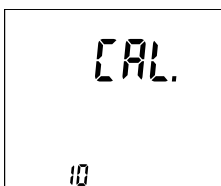

CAL menu (adjustment of the instrument).

Press the ► key to display the last screen. This menu is used for the adjustment of the instrument. In order to prevent handling errors, access to it is made difficult. Refer to the next section for the procedure.

2.5. ADJUSTMENT

To access the instrument's adjustment procedure, hold the ► key down, then press the ▲ and ▼ keys simultaneously.

2.5.1. ADJUSTMENT OF THE IMPEDANCE MEASUREMENT

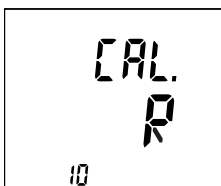

To enter the impedance measurement adjustment procedure, press the ► key for more than 3 seconds. The instrument then alternately displays **NO LOOP** and **PRESS RT** to indicate that the clamp must not be on a conductor. When this condition is met, press the ► key.



The instrument adjusts the empty clamp. Then it makes the adjustment on an internal resistance of 10Ω. When it has terminated, it displays the result: **PASS** or **FAIL** depending on whether the adjustment succeeded or failed. Press the ► key to terminate.

2.5.2. ADJUSTMENT OF THE CURRENT MEASUREMENT

Press the ▼ key to go to the next screen.

You must have a stabilized current source to generate AC currents between 0.1 and 10A.

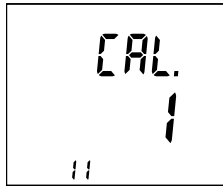

To enter the current measurement adjustment procedure, press the ► key for more than 3 seconds.

Step 1/7. The instrument alternately displays **100mA SET** and **PRESS RT.** Clamp a cable in which there flows a current of 100mA, then press the ► key.

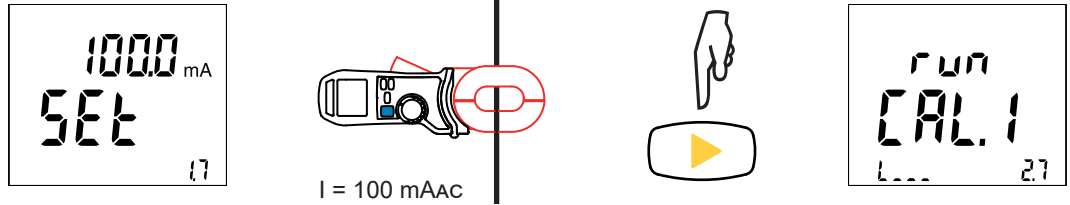

Step 2/7. The instrument performs the first part of the current measurement adjustment.

Step 3/7. The instrument alternately displays **5.00A SET** and **PRESS RT.** Clamp a cable in which there flows a current of 5A, then press the ► key.

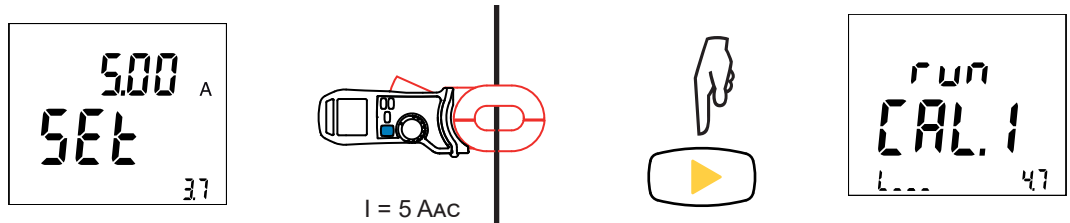

Step 4/7. The instrument performs the second part of the current measurement adjustment.

Step 5/7. The instrument alternately displays **15.00A SET** and **PRESS RT.** Clamp a cable in which there flows a current of 15A, then press the ► key.

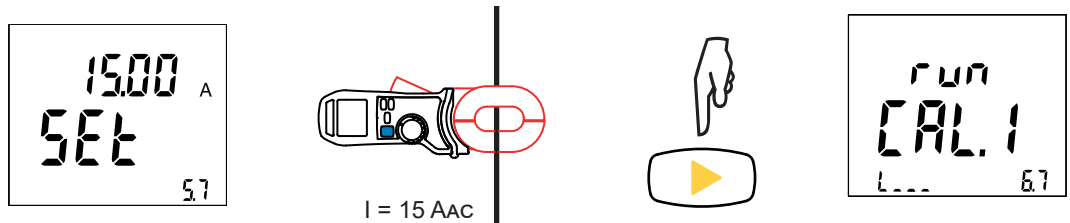

Step 6/7. The instrument performs the third part of the current measurement adjustment.

Step 7/7. When it has terminated, it displays the result: **PASS** or **FAIL** depending on whether the adjustment succeeded or failed. Press the ► key to terminate.

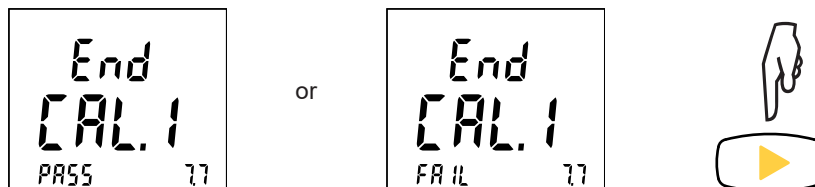

In the event of failure, repeat the procedure.

2.5.3. RESTORING THE FACTORY VALUES

Press the ▼ key to go to the next screen. Restoring the factory values returns the adjustment values to the factory settings. The configuration and stored measurements are not erased.



Press the ► key for more than 3 seconds.

The instrument displays **PRESS RT.** Press the ► key to confirm. Turn the switch to abort.

When it has terminated, the instrument displays the result: **PASS** or **FAIL**. Press the ► key to terminate.

2.6. ERRORS

During the measurement, the instrument reports any errors.

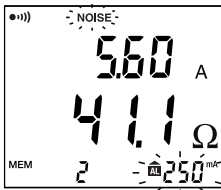

Display of the **NOISE** symbol during the impedance measurement reports a current that is too high (>5A) or a voltage that is too high ($Z \times I > 25V$). The accuracy of the measurement displayed is uncertain.

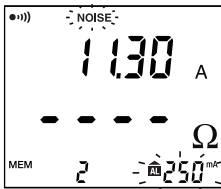

When the current exceeds 10A, the impedance measurement is not displayed.

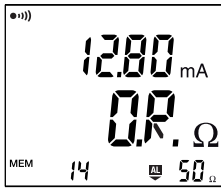

When the impedance measurement is >1200Ω, the instrument indicates **OR**.

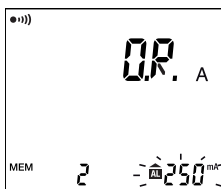

When the current measurement is >20A, the instrument so indicates.

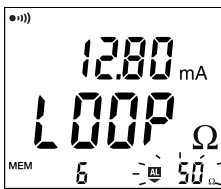

When the impedance measurement is <1Ω, the display alternately indicates the measured value and **LOOP**, because the value is very low for an earth loop impedance. Check your connection; in other words, check that you have not clamped a local loop rather than an earth loop.

2.7. AUTOMATIC STOP

After 5 minutes of operation with no sign of the user's presence (key press or rotation of the switch), the instrument switches to standby.

Simply press any key or turn the switch to exit from standby. The instrument restarts without repeating the calibration procedure if it has not been on standby for more than 15 minutes.

It is possible to disable automatic standby; refer to §2.4 (STOP menu). The **P** symbol is then displayed.

2.8. STORAGE

2.8.1. RECORDING A MEASUREMENT

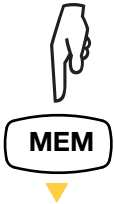

To record a measurement, press the **MEM** key.
You can first press the **HOLD** key to freeze the measurement.



For it to be possible to record a measurement, the batteries must not be discharged. This means that the  symbol must not be displayed.

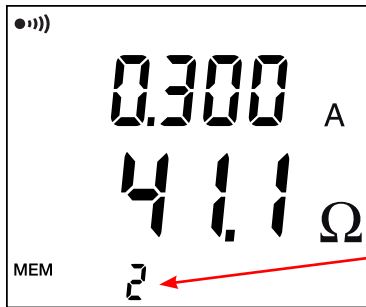

The measurement is recorded in the memory slot of which the number is displayed (here slot number 2).

- It is recorded with all accompanying information:
- the date and time,
 - any alarms and their status (triggered or not),
 - any errors (**NOISE**, **OR**, **LOOP**),
 - ancillary displays (**HOLD**, **P**).

2.8.2. REREADING THE RECORDS

Set the switch to **MR**.

The instrument displays the last measurement recorded.
Press the  key to display the date and time.

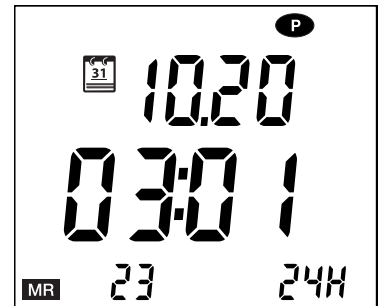
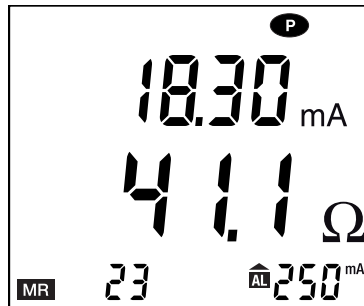
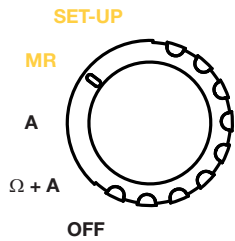

Use the  and  keys to scroll through all of the recorded measurements.

2.8.3. ERASING ALL RECORDS

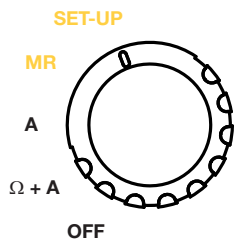

Set the switch to **SET-UP**.

Then follow the procedure described in §2.4 in the CLR menu.

When you return to the **MR** setting, the instrument indicates that the memory is empty.

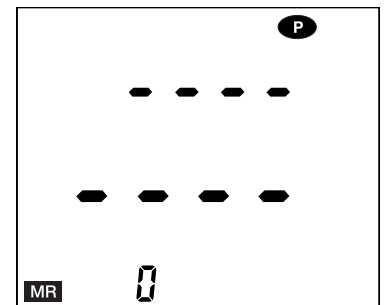

2.8.4. MEMORY FULL

You can record up to 300 measurements (numbered from 0 to 299).

If you continue recording, measurement number 300 overwrites measurement number 0, measurement 301 overwrites measurement 1, and so on.

The instrument reports this by alternately displaying FULL and the memory slot number.

You can continue like this up to number 9999, at which point recording becomes impossible and you must erase the memory to be able to resume recording.

3. TECHNICAL CHARACTERISTICS

3.1. GENERAL REFERENCE CONDITIONS

Quantities of influence	Reference values
Temperature	23 ±3°C
Relative humidity	50 ±10%RH
Supply voltage	6 ±0.2V
Electric field	<1V/m
Magnetic field	<40A/m
Operating position	clamp horizontal
Position of the conductor in the jaws	centred
Adjacent conductors carrying current in impedance measurement	At least 10cm
Magnetic mass	At least 10cm
Frequency	50Hz, sinusoidal
Level of distortion	<0.5%
Current present in impedance measurement	0mA

The **intrinsic uncertainty** is the error defined under the conditions of reference.

The **operational uncertainty** is the intrinsic uncertainty plus the variation of the quantities of influence (position, supply voltage, temperature) as defined in standard IEC 61557.

The uncertainties are expressed as a percentage of the reading (L) and as a number of display counts (R):
 $\pm(a\%L+b.R)$

3.2. ELECTRICAL CHARACTERISTICS

3.2.1. IMPEDANCE MEASUREMENTS

Particular conditions of reference

Inductance in series with the resistance: zero.

Specified measurement range	0,010 to 0,099 Ω	0,10 to 0,99 Ω	1,0 to 49,9 Ω	50 to 149 Ω
Resolution (R)	1 mΩ	10 mΩ	100 mΩ	1 Ω
Intrinsic uncertainty (δ)	± (1,5%L + 0,01Ω)	± (1,5%L + 2 R)	± (1,5%L + 2 R)	± (2,5%L + 2 R)
No-load voltage	≤ 45 mV to 2083 Hz			

Specified measurement range	150 to 245 Ω	250 to 440 Ω	450 to 640 Ω	650 to 1 200 Ω
Resolution (R)	5 Ω	10 Ω	10 Ω	50 Ω
Intrinsic uncertainty (δ)	± (5%L + 2 R)	± (10%L + 2 R)	± (15%L + 2 R)	± (20%L + 2 R)
No-load voltage	≤ 45 mV to 2083 Hz			

3.2.2. CURRENT MEASUREMENTS

Particular conditions of reference

Frequency of the signal: 47 to 800Hz

Specified measurement range	0,50 to 9,995 mA	10,00 to 99,90 mA	100,0 to 299,0 mA	0,300 to 2,990 A
Resolution (R)	50 μ A	100 μ A	1 mA	10 mA
Intrinsic uncertainty (δ)	$\pm (2\%L + 200 \mu\text{A})$	$\pm (2\%L + R)$	$\pm (2\%L + R)$	$\pm (2\%L + R)$

Specified measurement range	3,00 to 20,00 A
Resolution (R)	100 mA
Intrinsic uncertainty (δ)	$\pm (2\%L + R)$



Beyond 20A and 800Hz, the clamp may overheat dangerously.

3.2.3. STORAGE

Number of records: 300.

3.3. VARIATION IN THE DOMAIN OF USE

Z = impedance

I = current

δ = intrinsic uncertainty given in §3.2.

R = resolution given in §3.2.

For the impedance measurement

Quantities of influence	Range of influence	Influence			
		Typical		Maximum	
Temperature	-20 to + 55 °C	0.5 δ / 10°C \pm R		1.5 δ / 10°C + R	
Relative humidity	10 to 90 %RH	1 δ \pm R		2 δ \pm R	
Supply voltage	4 to 6.5 V	0.05 δ \pm R		0.1 δ \pm R	
Position of conductor	from the edge to the centre	Z < 450 Ω 0.2 δ \pm R	Z \geq 450 Ω 0.5 δ \pm R	Z < 450 Ω 0.4 δ \pm R	Z \geq 450 Ω 1 δ \pm R
Position of clamp	+/- 180°	Z < 450 Ω 0.25 δ \pm R	Z \geq 450 Ω 0.5 δ \pm R	Z < 450 Ω 0.5 δ \pm R	Z \geq 450 Ω 1 δ \pm R
Proximity to magnetic mass	Sheet steel 1mm thick against the air gap	0.1 δ \pm R		0.5 δ \pm R	
Magnetic field 50/60Hz	30 A/m	0.05 δ \pm R		0.1 δ \pm R	
Adjacent conductor	I < 40A	Z < 250 Ω 0.25 δ \pm R	Z \geq 250 Ω 0.4 δ \pm R	Z < 250 Ω 0.5 δ \pm R	Z \geq 250 Ω 0.8 δ \pm R
Leakage current in the loop from 50 to 60Hz I < 10 A. ZxI < 75 V	Z < 100 Ω	Z x I < 20 V	0.5 δ \pm R		1 δ \pm R
		20 V \leq Z x I < 40 V	1 δ \pm R		3 δ \pm R
		40 V \leq Z x I	2 δ \pm R		4 δ \pm R
	Z \geq 100 Ω	0.5 δ \pm R		1 δ \pm R	
Loop inductance	0 to 500 μ H	The instrument displays Z at the measurement frequency (2083Hz)			

For the current measurement

Quantities of influence	Range of influence	Influence	
		Typical	Maximum
Temperature	-20 to + 55 °C	0.5 δ / 10°C ± R	1.5 δ / 10°C + R
Relative humidity	10 to 90 %RH	0.5 δ ± R	1 δ ± R
Supply voltage	4 to 6.5 V	0.05 δ ± R	0.1 δ ± R
Position of conductor	from the edge to the centre	0.05 δ ± R	0.2 δ ± R
Position of clamp	+/- 180°	0.1 δ ± R	0.25 δ ± R
Proximity to magnetic mass	Steel sheet 1mm thick against air gap	0.1 δ ± R	0.2 δ ± R
Magnetic field 50/60Hz	10 A/m	0.75 mA	1.5 mA
	30 A/m	2 mA	4.5 mA
	100 A/m	8 mA	15 mA
Deformation of the leakage current	IEC 61557-13 5 % to 150 Hz at 0° 6 % to 250 Hz at 180° 5 % to 350 Hz at 0°	0.05 δ ± R	0.1 δ ± R
Adjacent conductor	I < 40A	> 70 dB	> 66 dB
Frequency of the leakage current	47 to 800 Hz ¹	0.5 δ ± R	1 δ ± R

1: For the whole current measurement range

3.4. POWER SUPPLY

The instrument is powered by four 1.5V AA batteries (LR6 alkaline batteries; NiMH rechargeable batteries may also be used). The voltage range ensuring proper operation is from 4V to 6.5V.

The battery life of the instrument is 20 hours, or approximately 2400 30-second measurements.

3.5. ENVIRONMENTAL CONDITIONS

The conditions of ambient temperature and relative humidity are given by the following graph:

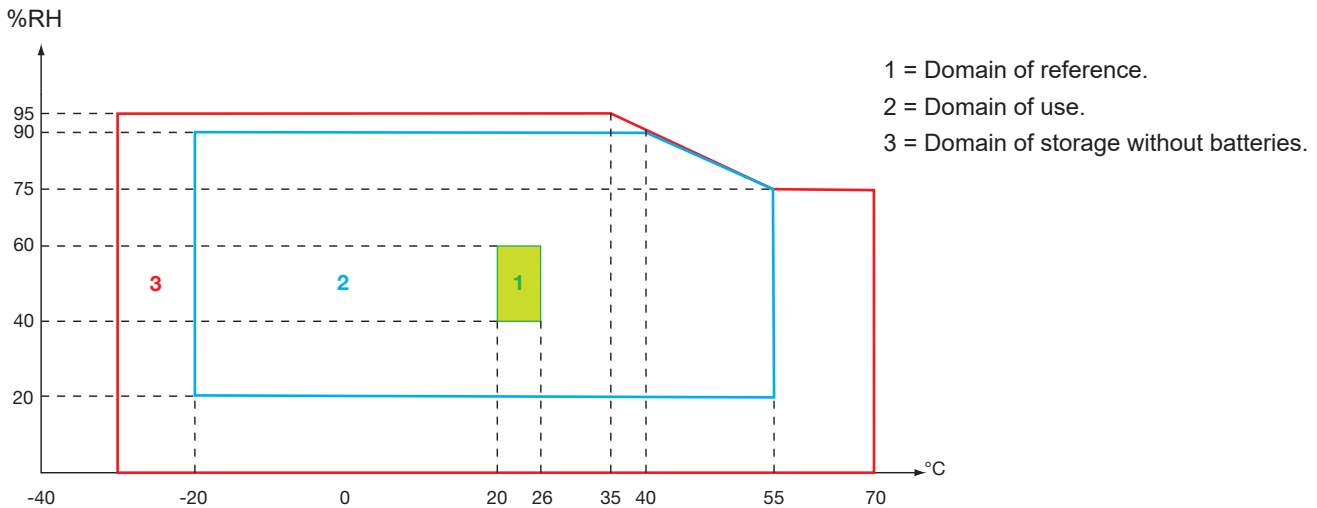

3.6. MECHANICAL CHARACTERISTICS

Dimensions (L x W x H)	300 x 106 x 56mm
Weight	approximately 1.2kg
Clamping diameter	32mm or a 30 x 40mm or 20 x 55mm bar

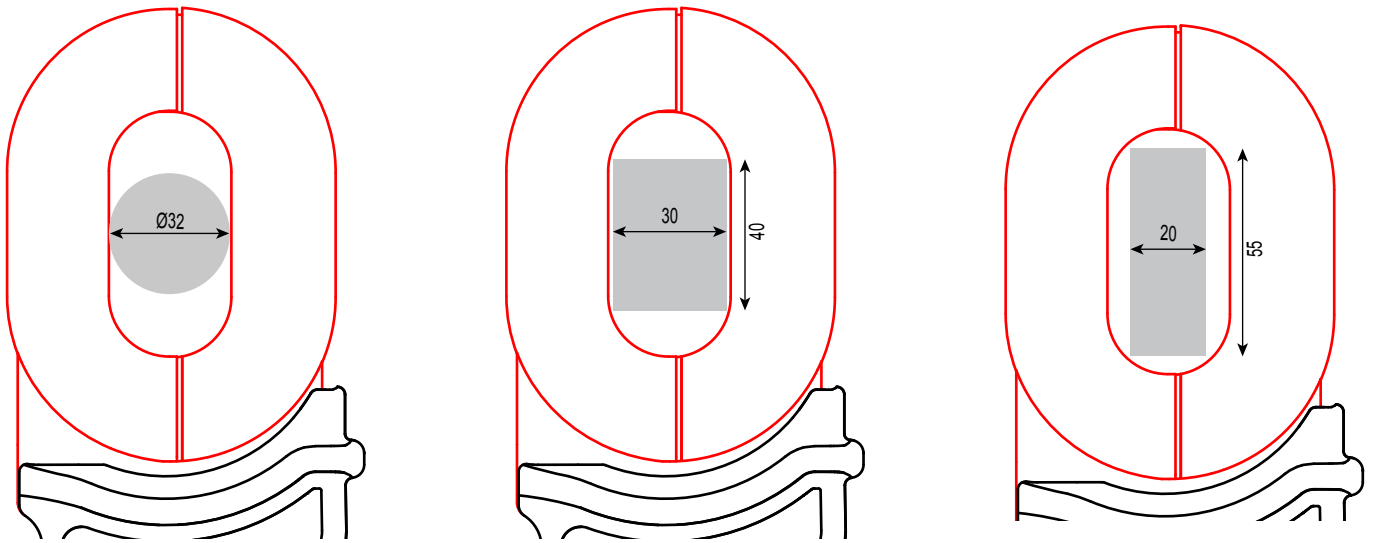

Ingress protection

IP40 per IEC 60529

3.7. COMPLIANCE WITH INTERNATIONAL STANDARDS

The device is compliant with standard IEC 61010-1 and IEC 61010-2-032, 100V category IV or 150V category III.

3.8. ELECTROMAGNETIC COMPATIBILITY (EMC)

The device is compliant with standard IEC 61326-1.

4. MAINTENANCE



Except for the batteries, the instrument contains no parts likely to be replaced by personnel who are not specially trained and accredited. Any unauthorized repair or replacement of a part by an “equivalent” may gravely impair safety.

4.1. CLEANING



Disconnect everything connected to the device and set the switch to OFF.

Use a soft cloth, dampened with soapy water. Rinse with a damp cloth and dry rapidly with a dry cloth or forced air. Do not use alcohol, solvents, or hydrocarbons.

Do not use the instrument again until it has completely dried.

Keep the air gap of the clamp perfectly clean.

4.2. REPLACEMENT OF THE BATTERIES

The blinking of the symbol  on the display unit warns you that the batteries are low. When the  symbol is lit steadily, it is time to replace all of the batteries.

- Disconnect everything connected to the device and set the switch to OFF.
- Turn the instrument over and unscrew the 2 captive screws securing the battery compartment cover.

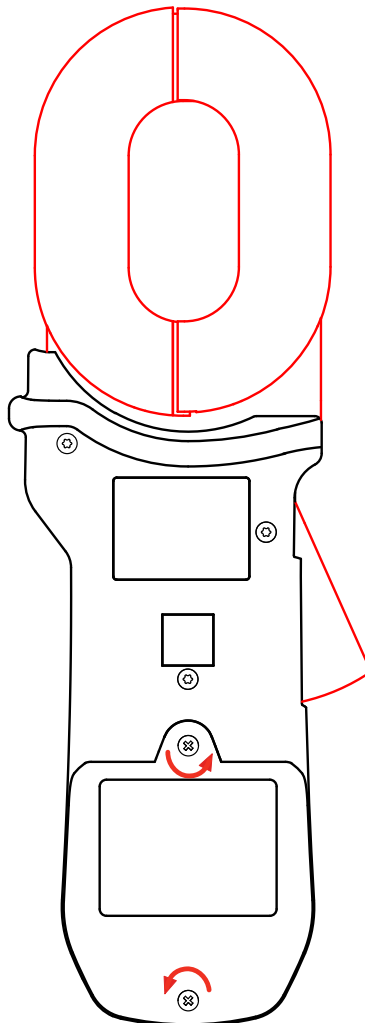

- Remove the battery compartment cover.
- Withdraw the batteries from the compartment.

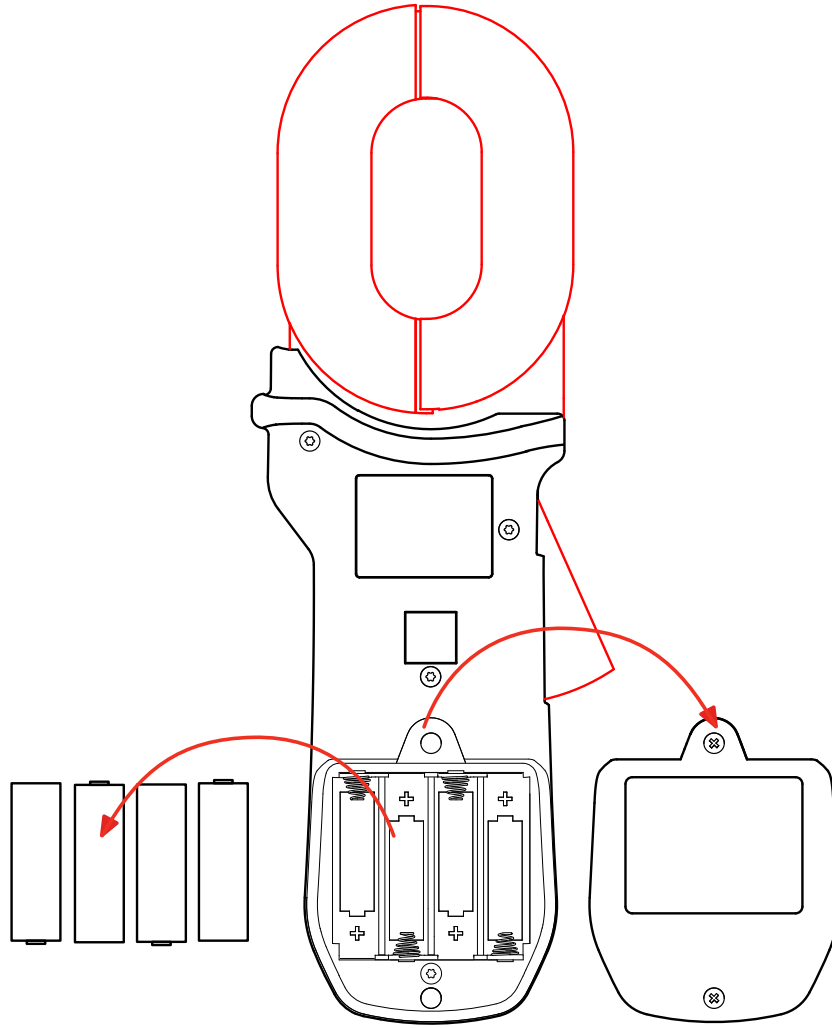

Spent batteries must not be treated as ordinary household waste. Take them to the appropriate recycling collection point.

- Place the new batteries in the compartment, observing the polarities.
- Put the battery compartment cover back in place and make sure that it is completely and correctly closed.
- Screw the two captive screws back in.



The date and time are preserved for several minutes, long enough for you to change the batteries. If, however, the date and time are lost, the instrument will prompt you to reset them when it is switched on (see §1.6).

5. WARRANTY

Except as otherwise stated, our warranty is valid for **24 months** starting from the date on which the equipment was sold. Extract from our General Conditions of Sale, provided on request.

The warranty does not apply in the following cases:

- Inappropriate use of the equipment or use with incompatible equipment.
- Modifications made to the equipment without the explicit permission of the manufacturer's technical staff.
- Work done on the device by a person not approved by the manufacturer.
- Adaptation to a particular application not anticipated in the definition of the equipment or not indicated in the user's manual.
- Damage caused by shocks, falls, or floods.