

# Models 707B and 708B Switching Matrix

## User's Manual

707B-900-01 Rev. A / August 2010

# Models 707B and 708B Switching Matrix User's Manual

© 2010, Keithley Instruments, Inc.

Cleveland, Ohio, U.S.A.

All rights reserved.

Any unauthorized reproduction, photocopy, or use the information herein, in whole or in part, without the prior written approval of Keithley Instruments, Inc. is strictly prohibited.

All Keithley Instruments product names are trademarks or registered trademarks of Keithley Instruments, Inc. Other brand names are trademarks or registered trademarks of their respective holders.

Document number: 707B-900-01 Rev. A / August 2010



# Safety Precautions



The following safety precautions should be observed before using this product and any associated instrumentation. Although some instruments and accessories would normally be used with non-hazardous voltages, there are situations where hazardous conditions may be present.

This product is intended for use by qualified personnel who recognize shock hazards and are familiar with the safety precautions required to avoid possible injury. Read and follow all installation, operation, and maintenance information carefully before using the product. Refer to the user documentation for complete product specifications.

If the product is used in a manner not specified, the protection provided by the product warranty may be impaired.

The types of product users are:

**Responsible body** is the individual or group responsible for the use and maintenance of equipment, for ensuring that the equipment is operated within its specifications and operating limits, and for ensuring that operators are adequately trained.

**Operators** use the product for its intended function. They must be trained in electrical safety procedures and proper use of the instrument. They must be protected from electric shock and contact with hazardous live circuits.

**Maintenance personnel** perform routine procedures on the product to keep it operating properly, for example, setting the line voltage or replacing consumable materials. Maintenance procedures are described in the user documentation. The procedures explicitly state if the operator may perform them. Otherwise, they should be performed only by service personnel.

**Service personnel** are trained to work on live circuits, perform safe installations, and repair products. Only properly trained service personnel may perform installation and service procedures.

Keithley Instruments products are designed for use with electrical signals that are rated Measurement Category I and Measurement Category II, as described in the International Electrotechnical Commission (IEC) Standard IEC 60664. Most measurement, control, and data I/O signals are Measurement Category I and must not be directly connected to mains voltage or to voltage sources with high transient over-voltages. Measurement Category II connections require protection for high transient over-voltages often associated with local AC mains connections. Assume all measurement, control, and data I/O connections are for connection to Category I sources unless otherwise marked or described in the user documentation.

Exercise extreme caution when a shock hazard is present. Lethal voltage may be present on cable connector jacks or test fixtures. The American National Standards Institute (ANSI) states that a shock hazard exists when voltage levels greater than 30V RMS, 42.4V peak, or 60VDC are present. A good safety practice is to expect that hazardous voltage is present in any unknown circuit before measuring.

Operators of this product must be protected from electric shock at all times. The responsible body must ensure that operators are prevented access and/or insulated from every connection point. In some cases, connections must be exposed to potential human contact. Product operators in these circumstances must be trained to protect themselves from the risk of electric shock. If the circuit is capable of operating at or above 1000V, no conductive part of the circuit may be exposed.

Do not connect switching cards directly to unlimited power circuits. They are intended to be used with impedance-limited sources. NEVER connect switching cards directly to AC mains. When connecting sources to switching cards, install protective devices to limit fault current and voltage to the card.

Before operating an instrument, ensure that the line cord is connected to a properly-grounded power receptacle. Inspect the connecting cables, test leads, and jumpers for possible wear, cracks, or breaks before each use.

When installing equipment where access to the main power cord is restricted, such as rack mounting, a separate main input power disconnect device must be provided in close proximity to the equipment and within easy reach of the operator.

For maximum safety, do not touch the product, test cables, or any other instruments while power is applied to the circuit under test. ALWAYS remove power from the entire test system and discharge any capacitors before: connecting or disconnecting cables or jumpers, installing or removing switching cards, or making internal changes, such as installing or removing jumpers.

Do not touch any object that could provide a current path to the common side of the circuit under test or power line (earth) ground. Always make measurements with dry hands while standing on a dry, insulated surface capable of withstanding the voltage being measured.

The instrument and accessories must be used in accordance with its specifications and operating instructions, or the safety of the equipment may be impaired.

Do not exceed the maximum signal levels of the instruments and accessories, as defined in the specifications and operating information, and as shown on the instrument or test fixture panels, or switching card.

When fuses are used in a product, replace with the same type and rating for continued protection against fire hazard.

Chassis connections must only be used as shield connections for measuring circuits, NOT as safety earth ground connections.

If you are using a test fixture, keep the lid closed while power is applied to the device under test. Safe operation requires the use of a lid interlock.

If a  screw is present, connect it to safety earth ground using the wire recommended in the user documentation.

The  symbol on an instrument means caution, risk of danger. The user should refer to the operating instructions located in the user documentation in all cases where the symbol is marked on the instrument.

The  symbol on an instrument means caution, risk of danger. Use standard safety precautions to avoid personal contact with these voltages.

The  symbol on an instrument shows that the surface may be hot. Avoid personal contact to prevent burns.

The  symbol indicates a connection terminal to the equipment frame.

If this  symbol is on a product, it indicates that mercury is present in the display lamp. Please note that the lamp must be properly disposed of according to federal, state, and local laws.

The **WARNING** heading in the user documentation explains dangers that might result in personal injury or death. Always read the associated information very carefully before performing the indicated procedure.

The **CAUTION** heading in the user documentation explains hazards that could damage the instrument. Such damage may invalidate the warranty.

Instrumentation and accessories shall not be connected to humans.

Before performing any maintenance, disconnect the line cord and all test cables.

To maintain protection from electric shock and fire, replacement components in mains circuits - including the power transformer, test leads, and input jacks - must be purchased from Keithley Instruments. Standard fuses with applicable national safety approvals may be used if the rating and type are the same. Other components that are not safety-related may be purchased from other suppliers as long as they are equivalent to the original component (note that selected parts should be purchased only through Keithley Instruments to maintain accuracy and functionality of the product). If you are unsure about the applicability of a replacement component, call a Keithley Instruments office for information.

To clean an instrument, use a damp cloth or mild, water-based cleaner. Clean the exterior of the instrument only. Do not apply cleaner directly to the instrument or allow liquids to enter or spill on the instrument. Products that consist of a circuit board with no case or chassis (e.g., a data acquisition board for installation into a computer) should never require cleaning if handled according to instructions. If the board becomes contaminated and operation is affected, the board should be returned to the factory for proper cleaning/servicing.

# Table of Contents

---

## **Introduction ..... 1-1**

Introduction to this manual.....	1-1
Models 707B and 708B applications.....	1-1
CD-ROM contents.....	1-2

## **Using the front-panel interface..... 2-1**

Introduction .....	2-1
Model 707B front panel.....	2-2
Model 708B front panel.....	2-2
Keys and navigation wheel .....	2-3
Navigation wheel.....	2-3
Front-panel keys .....	2-4
Display.....	2-5
Channel identification.....	2-6
Selecting and closing a channel from the front panel.....	2-7
Exercise: Select and close slot 1, row C, column 7 crosspoint.....	2-8
Crosspoint display (Model 707B only) .....	2-9
Selecting and closing channels using the crosspoint display .....	2-10
Viewing the close or open status of a channel .....	2-11
Channel patterns.....	2-11
Create a channel pattern.....	2-12
Performing close and open operations on channel patterns .....	2-12
Set up row, column, and channel labels .....	2-13
Exercise: Create a row label for row D using the front panel .....	2-14

## **Using the web interface..... 3-1**

Introduction .....	3-1
Connect to the instrument web interface .....	3-1
Web interface home page.....	3-2
Log in to the instrument.....	3-2
Card pages.....	3-3
Open and close channels from the card pages.....	3-4
Set up channel patterns from the web interface.....	3-6
Scan Builder page.....	3-8
Create a scan list .....	3-9
Run the scan.....	3-9
Stop the scan .....	3-10
Clear the scan list from the web interface .....	3-10
Set up simple triggers .....	3-10

TSB Embedded.....	3-11
Create a script using TSB Embedded.....	3-11
<b>Working with the Model 4200-SCS.....</b>	<b>4-1</b>
Introduction.....	4-1
Equipment required to run the example.....	4-1
Configure Model 707B or 708B for Model 4200-SCS.....	4-1
Add Model 707B or 708B to Model 4200-SCS.....	4-2
Next steps.....	4-3
<b>Working with the Series 2600A.....</b>	<b>5-1</b>
About the Series 2600A examples.....	5-1
Equipment required to run the examples.....	5-2
Connect the equipment.....	5-2
Logical block diagram of test connections.....	5-3
Example 1: Control with separate interfaces.....	5-4
Set up communication.....	5-4
Example program code for the Model 707B or 708B.....	5-5
Example program code for the Model 2635.....	5-5
Example code to run the test.....	5-6
Example 2: Using TSP-Link to configure instruments.....	5-7
Set up communication.....	5-8
Example program code.....	5-9
Example code to run the test.....	5-10
Example 3: Configure using TSP-Link and interactive triggers.....	5-12
Set up communication.....	5-12
Example program code.....	5-13
Example program code to run the test.....	5-16
Example 4: Using the scanning and triggering model.....	5-17
Set up communication.....	5-17
Example program code.....	5-17
Example program code to run the test.....	5-20
Using background scans for longer scan lists.....	5-21
<b>Working with the Series 2400.....</b>	<b>6-1</b>
About the Series 2400 examples.....	6-1
Equipment required to run the examples.....	6-1
Connect the equipment.....	6-1
Logical block diagram of test connections.....	6-2
Example 1: Individual commands for switch-measure.....	6-3
Example program code for the Model 2400.....	6-3
Example program code for the Model 707B or 708B.....	6-4
Example 2: Digital I/O triggering for switch-measure synchronization.....	6-5

Example program code for the Model 2400 ..... 6-5  
Example program code for the Model 707B or 708B ..... 6-6  
Overview of running the test..... 6-9  
Example code to run the test..... 6-9

**Troubleshooting FAQs ..... 7-1**

About this section ..... 7-1  
Need different line frequency or voltage ..... 7-1  
Model 4200-SCS does not recognize switch matrix ..... 7-1  
"A" model software does not run on "B" models ..... 7-3  
Matrix Ready and External Trigger lines ..... 7-3  
Switch matrix does not recognize my card ..... 7-3  
Instrument's internal web page is not accessible..... 7-4  
Error when I try to close a channel ..... 7-5  
Switch relays will not close ..... 7-5  
Save the present state of the instrument ..... 7-5  
LabVIEW driver for the Model 707B or 708B..... 7-6

**Next steps ..... 8-1**

**Index..... Index-1**





## Introduction

### In this section:

<a href="#">Introduction to this manual .....</a>	<a href="#">1-1</a>
<a href="#">Models 707B and 708B applications .....</a>	<a href="#">1-1</a>
<a href="#">CD-ROM contents.....</a>	<a href="#">1-2</a>

## Introduction to this manual

The purpose of this manual is to provide detailed tutorials to help you achieve success with your Keithley Instruments Model 707B or 708B Semiconductor Switching Matrix. The basics of the two simplest interfaces, the front panel and the web interface, are provided to familiarize you with the instrument. The tutorials build upon one another, so we recommend that you read this manual from Section 1 to the end of Section 3. Select and run all examples in Sections 4, 5, and 6 that are relevant to your intended use and to the equipment you are using.

Some of the examples in this manual may use unfamiliar commands and concepts. For detailed information about these, refer to the Models 707B and 708B Reference Manual (part number 707B-901-01) on the Product Information CD-ROM that came with your instrument.

## Models 707B and 708B applications

Unlike a standalone instrument, the Keithley Instruments Models 707B and 708B are switching systems that are used to intelligently connect other instruments to multiple devices. This manual provides application examples that guide you through several common instrument-to-device switching scenarios. These applications are presented after the summary information about the switching matrix, and include:

- [Working with the Model 4200-SCS](#) (on page 4-1): Demonstrates how to connect the Keithley Instruments Model 4200 Semiconductor Characterization System to a Model 707B or 708B. This enables the Model 4200-SCS to automate measurements to multiple devices for DC, C-V, and pulsed I-V characterization.
- [Working with the Series 2600A](#) (on page 5-1): Demonstrates how to use the Model 707B or 708B with a Keithley Instruments Series 2600A System SourceMeter<sup>®</sup> instrument to perform an I-V sweep across a diode.
- [Working with the Series 2400](#) (on page 6-1): Demonstrates the basic interaction of the Model 707B or 708B with a Keithley Instruments Model 2400 SourceMeter instrument, including how to use digital I/O triggering to synchronize source and measure actions between the Model 707B or 708B and the Model 2400. The concepts in these examples can be applied when used using the Model 707B or 708B with other SCPI-based instruments.

## CD-ROM contents

There are several CD-ROMs that are included with your instrument, which contain the following items:

- The Test Script Builder Software and the Model 707B or 708B TSB add-in, which is a software tool you can use to create, modify, debug, and store test script processor (TSP<sup>®</sup>) test scripts
- Switching product information
- Product documentation, including PDFs of the Model 707B or 708B Quick Start Guide, User Manual, and Reference Manual, as well as the product data sheet, product specifications, and rack-mount kit instructions
- Product documentation for the switch cards that are compatible with the Model 707B or 708B
- Model 707B or 708B drivers for IVI Instrument Driver and driver for National Instrument's LabVIEW<sup>®</sup> and related release notes
- J2SE<sup>™</sup> Runtime Environment, which is necessary to use the instrument's web interface
- Keithley I/O layer and release notes, including necessary drivers for communication over the USB interface (see the Models 707B and 708B Reference Manual for details on using the USB interface).

---

## Using the front-panel interface

### In this section:

---

Introduction .....	2-1
Model 707B front panel .....	2-2
Model 708B front panel .....	2-2
Keys and navigation wheel.....	2-3
Display .....	2-5
Selecting and closing a channel from the front panel .....	2-7
Crosspoint display (Model 707B only) .....	2-9
Viewing the close or open status of a channel .....	2-11
Channel patterns .....	2-11
Set up row, column, and channel labels.....	2-13

## Introduction

Before starting this section, complete the tasks outlined in the Models 707B and 708B Quick Start Guide and install a switch card within the switching matrix. Once you have completed those tasks, read this section, which provides enough basic information about the Models 707B and 708B front-panel interfaces to work through the examples provided in this manual.

The front panel of the Keithley Instruments Model 707B or 708B contains the following items:

- The display
- The crosspoint display (Model 707B only)
- The keys and navigation wheel 
- The LAN STATUS light
- The POWER button

You can use the keys, displays, and the navigation wheel  to change the selected channel or channel pattern. You can also use them to access, view, and edit the menu items. The crosspoint display on the Model 707B shows you which channels are opened and closed.

For additional information about the front panel, see the "Front-panel operation" section in the Models 707B and 708B Reference Manual.

## Model 707B front panel

The front panel of the Model 707B is shown below.

Figure 1: Model 707B front panel

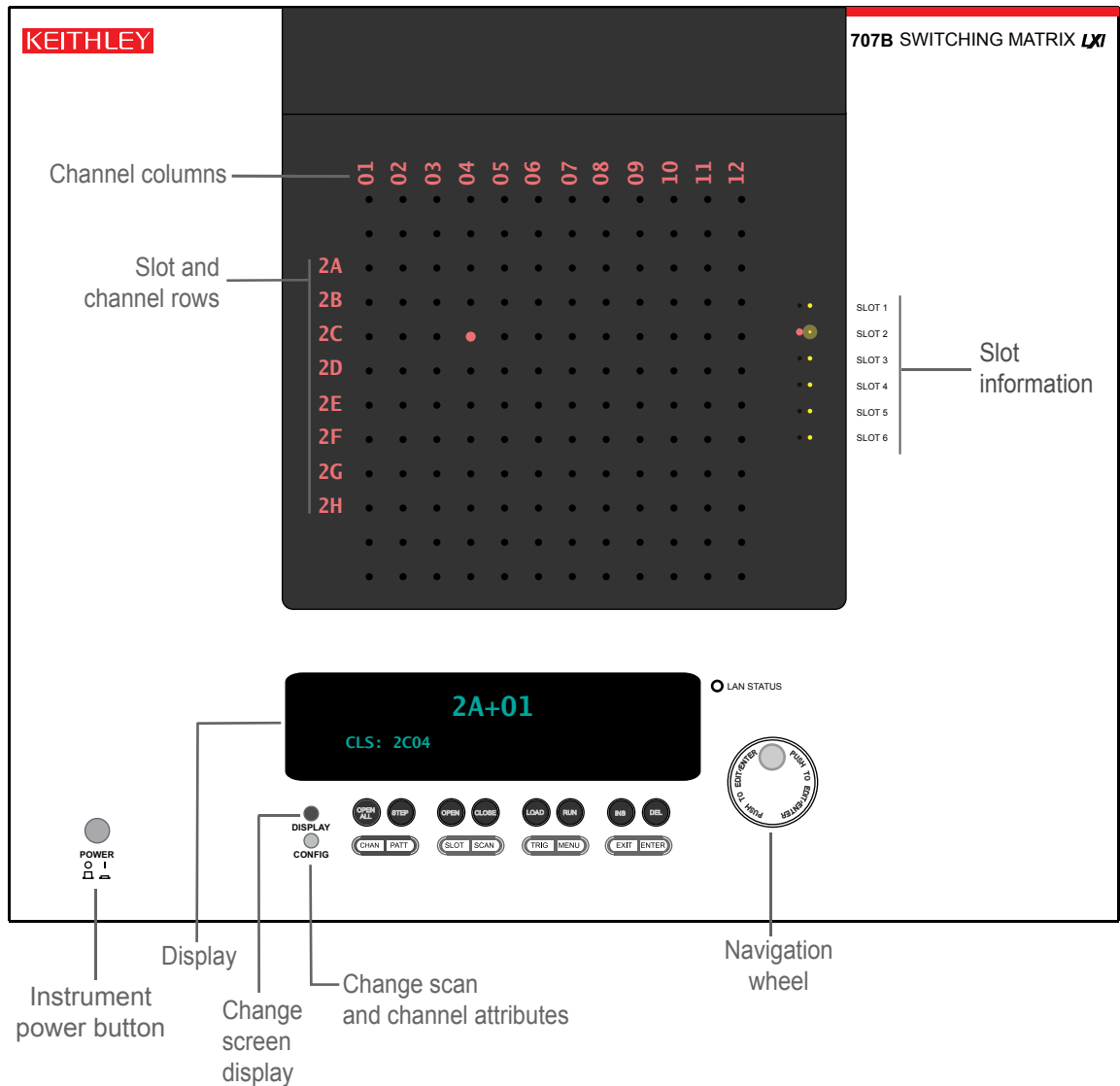

## Model 708B front panel

The front panel of the Model 708B is shown below.

Figure 2: Model 708B front panel

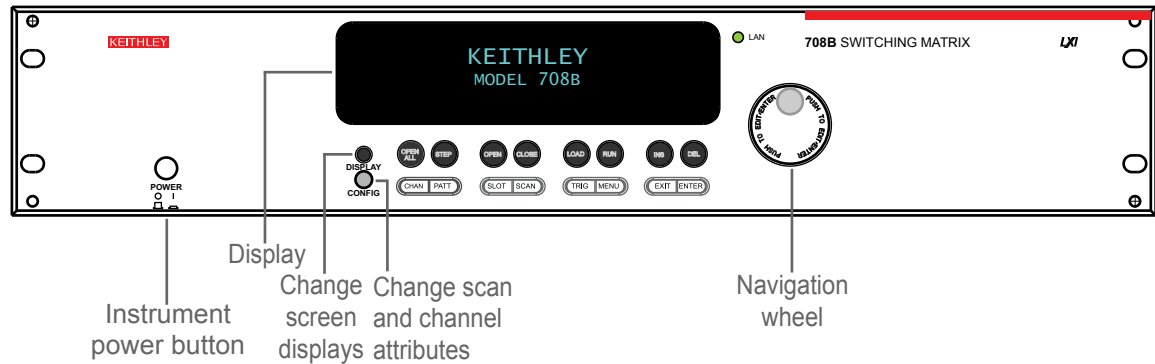



## Keys and navigation wheel

The keys and navigation wheel  on the front panel allow you to turn on, set up, and operate the instrument from the front panel.

The **POWER** key. Press this key to turn the instrument on (I). Press it again to turn the instrument off (O).





## Navigation wheel

Turn the navigation wheel  to scroll to a menu option or to change the selected value.

Push the navigation wheel  to open menus or to select a menu option or a value. In most cases, pressing the navigation wheel  performs the same action as pressing the **ENTER** key.

On the Model 707B, you can use the navigation wheel  to control which slot is displayed on the crosspoint display.

### ***To change a value with multiple characters:***

1. Turn the navigation wheel  to go to the character you want to change (the character blinks when selected).
2. Press the navigation wheel  to edit that character.
3. Turn the navigation wheel  to change the value.
4. Press the navigation wheel  to keep the change.
5. Repeat these steps as needed to change the value.
6. Press the **ENTER** key or the navigation wheel  when finished changing all the characters.

## Front-panel keys

The **DISPLAY** key cycles between three screens: The channel display or pattern display, the closed channel list, and the user screen text, which is set with `display.settext()`.

When the closed channel listing is displayed, if the list of channels is longer than one screen, you can use the navigation wheel  to scroll through the list of closed channels.

The **CONFIG** key accesses attribute menus in which you can configure channels and scans.

**CONFIG** and then **CHAN** opens the Channel Attribute Menu.

**CONFIG** and then **SCAN** opens the Scan Attribute Menu.

The top row of keys under the display allows you to open and close channels, work with scan lists, and load and run scripts.

**Figure 3: Models 707B and 708B top row of keys**



Key descriptions	
Key	Description
<b>OPEN ALL</b>	Opens all closed channels.
<b>STEP</b>	If a scan list has been defined, press <b>STEP</b> to step through the list. Each press is one scan step. See Working with scan lists from the front panel.
<b>OPEN</b>	Opens the selected channel or channel pattern.
<b>CLOSE</b>	Closes the selected channel or channel pattern.
<b>LOAD</b>	Loads code or scripts that can be run from the front panel.
<b>RUN</b>	Runs the last code or script selected through the <b>LOAD</b> key.
<b>INS</b>	Appends the selected channel or channel pattern to the scan list.
<b>DEL</b>	Deletes the first occurrence of the selected channel or channel pattern from the scan list.

The bottom row of keys allow you access menus and set up channels, patterns, cards, scans, triggers, and general instrument operation.

**Figure 4: Bottom row of keys**



Key descriptions	
Key	Description
<b>CHAN</b>	If a channel is displayed, opens the Channel Action Menu options, which allows you to open and close channels. If a pattern is displayed, pressing <b>CHAN</b> switches to channel view.
<b>PATT</b>	If a pattern is displayed, opens the Pattern Action Menu options, which allows you to manage patterns, open and close patterns, and reset them. If a channel is displayed, pressing <b>PATT</b> changes to display a pattern.
<b>SLOT</b>	Displays information about the installed cards and the instrument. Information includes the firmware revision, model name, and model number.
<b>SCAN</b>	Opens the Scan Action Menu options, which allows you to run, manage, view, and reset scan lists. See Scanning and triggering.
<b>TRIG</b>	Generates a trigger that can be used in a script or the trigger model. See Scanning and triggering.
<b>MENU</b>	Opens the Main Menu options, which allows you to manage scripts, manage communications, select channel connections, test the keys, test the display, manage digital I/O settings, set up the beeper, and display instrument information.
<b>EXIT</b>	This key: <ul style="list-style-type: none"> <li>• Cancels the current selection and returns to the previous menu item.</li> <li>• Exit remote operation so you can control the instrument from the front panel.</li> <li>• Aborts a scan that is running.</li> <li>• Aborts a script that is executing.</li> </ul>
<b>ENTER</b>	Accepts the current selection or brings up the next menu option. In most cases, pressing <b>ENTER</b> is the same as pressing the navigation wheel  .

## LAN status light

The LAN Status light is lit when the instrument is connected through the local area network (LAN) with no errors.

If this is not lit, the instrument is not connected through the LAN or there is a connection problem.

If you are using the web interface, the LAN Status light blinks when you click **ID**.

See the "LAN communication interface" topic in the Models 707B and 708B Reference Manual for more information.

## Display

**NOTE**

This section describes the front-panel display of the Model 708B and the bottom display of the Model 707B.



During operation, the display provides information about the selected channel, channel pattern, channel state, and errors. You can press **DISPLAY** to cycle between the display of the channel or pattern, the closed channel list, or a screen message.

During setup, the display shows menu choices that you can use to configure the instrument.

During operation, the display shows the control status (local or remote) and the current channel, and indicates if any channels are closed. An example is shown below. If **REM** is not displayed, control is through the front panel.

The control status is shown in the upper left corner of the display. If **REM** is displayed, the instrument is being controlled remotely (through GPIB, LAN, or USB). If **REM** is not displayed, control is through the front panel.

**Figure 5: Display during operation**

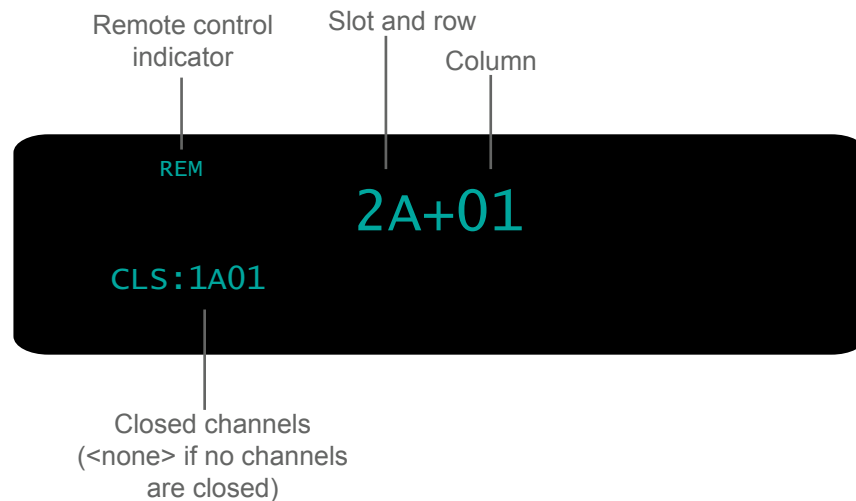

By default, the top line of the display shows the slot, row, and column of the selected channel.

## Channel identification

The channels on the cards that you can use with the Model 707B or 708B are referred to by a channel specifier. The specifier is used to identify channels for use with close and open operations, scans, and channel patterns, using the front panel, web, or remote command interface.

A channel specifier is a four or five-digit alphanumeric sequence. The first digit is always the slot number of the card in the mainframe. The remaining digits vary depending on the type of card.

### Channel types

The Models 707B and 708B support matrix cards. The documentation for your specific card model lists the available channels.

Specify multiple channels using lists. Lists build on the individual channel specifier.

### Channel identifiers

The channels on the matrix cards are referred to by their slot, bank, row, and column numbers:

- **Slot number:** The number of the slot in which the card is installed.
- **Bank:** The bank number, if used by your card. See your card documentation.
- **Row number:** The row number is either 1 to 8 or A to Z. See your card documentation.
- **Column number:** Always two digits. For columns greater than 99, use A, B, C and so on to represent 10, 11, 12, ...; the resulting counting sequence is: 98, 99, A0, A1, ..., A8, A9, B0, B1, ...

Matrix channel examples				
Reference	Slot	Bank	Row	Column
1A05	1	N/A	1	05
1C05	1	N/A	3	05
3C12	3	N/A	3	12

Figure 6: Matrix card display showing channel identifier

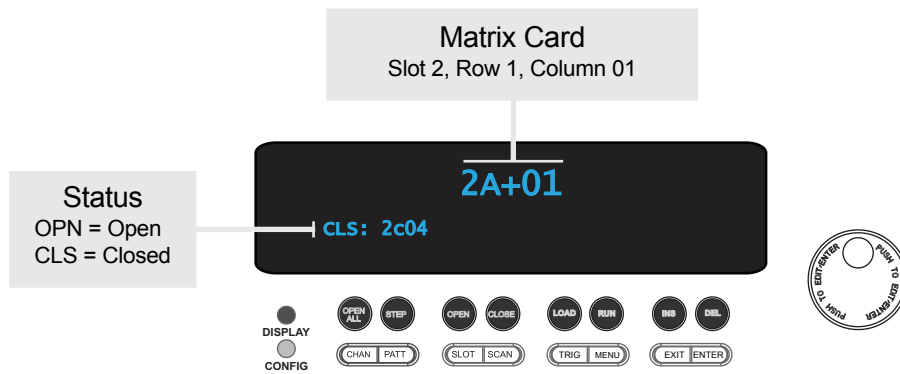

## Selecting and closing a channel from the front panel

**NOTE**

For the Model 707B, also see [Selecting and closing channels using the crosspoint display](#) (on page 2-10) to select a channel using the crosspoint display.

**CAUTION**

Hot switching can dry weld reed relays such that they will always be on. Hot switching is recommended only when external protection is provided.





You can perform operations on a single channel from the front panel. To select a channel, you use the navigation wheel . Once a channel is selected, it is the selected channel for front panel operation.

**NOTE**

If labels are assigned to your rows and columns, you will see those labels instead of the four-digit channel specifiers referred to in the following text.

**Exercise: Select and close slot 1, row C, column 7 crosspoint**

*To select and close the crosspoint on slot 1, at row C and column 7:*

1. To change the present row, press the navigation wheel. The first two digits of the four-digit channel specifier flash, indicating edit mode.
2. Turn the navigation wheel  change the digit to 1C.
3. Press the navigation wheel . This accepts the row selection and selects edit mode for the column. The last two digits of the channel specifier flash, indicating edit mode.
4. Turn the navigation wheel  to change the digits to 07.
5. Press the navigation wheel  or **ENTER** to accept the channel, exit edit mode, and return to the main display.
6. To:
  - Open the channel: Press **OPEN**.
  - Close a channel without affecting any other channels: Select **CLOSE**.
  - Close a channel and open any other closed channels on the instrument: Select **CHAN** and select **EXCLOSE**. Press **ENTER** to close the selected channels.
  - Close a channel and open any other closed channels on the slot that contains the selected channel: Select **CHAN**, and then select **EXSLOTCLOSE**. Press **ENTER** to close the selected channels.

## Crosspoint display (Model 707B only)

The crosspoint display on the front panel of the Model 707B displays information about the slots that contain cards and the open and closed state of the channels. for one card slot at a time. If there are no cards in the instrument's slots, the crosspoint display shows "No card in unit."

**Figure 7: Model 707B crosspoint display**

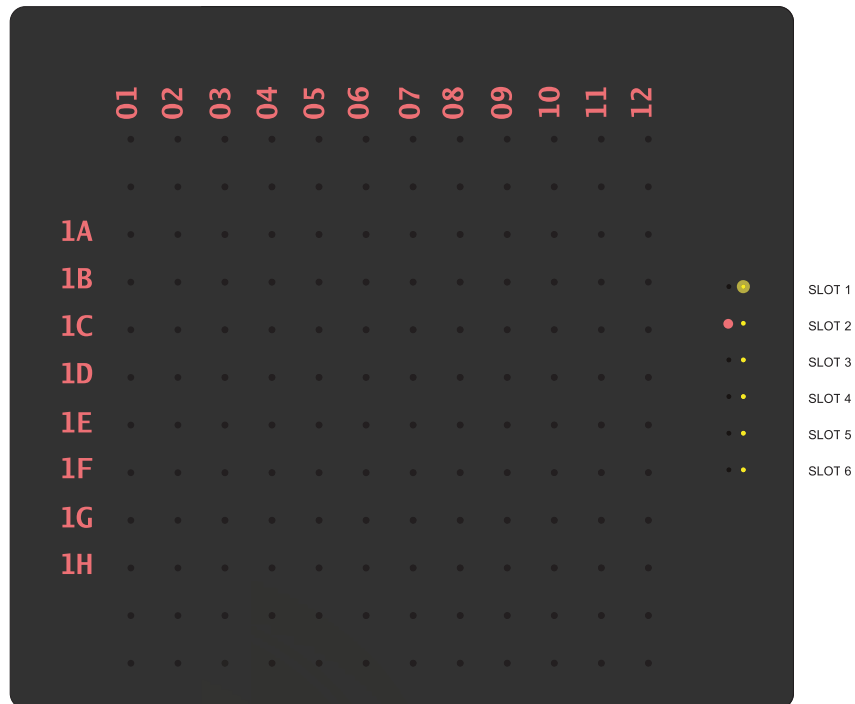

The crosspoint display has a list of slots on the right. To the left of the slot list are lights that show you an overview of the cards in the instrument's slots.

**Figure 8: Model 707B slot indicators**

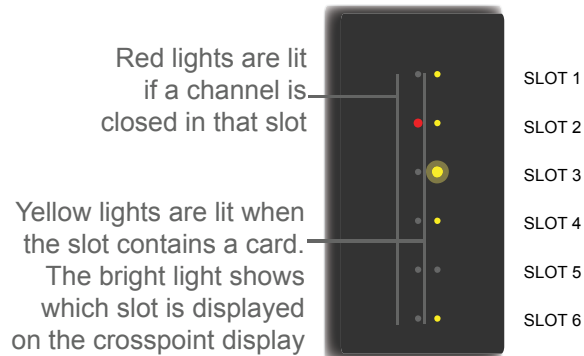

In the figure above, there are cards in five slots, no card in slot 5, and the channels for the card in slot 3 are displayed on the crosspoint display. Also, at least one channel is closed on the card in slot 2.

## Selecting and closing channels using the crosspoint display



From the front panel, you can change the display to show another card slot, choose a specific channel, and open and close channels. For the Model 707B, the crosspoint display shows you the status of the channels for one card at a time.

### *To display a different slot:*

Turn the navigation wheel  to the right to go to the next slot, or to the left to go to the previous slot.

### **Exercise: Select crosspoint on slot 2, row C, column 3**

#### *To select the crosspoint that is on slot 2, at row C and column 3*



1. When you are displaying slot 2, press the navigation wheel . The red lights for that slot are displayed.
2. Turn the navigation wheel  to go to row 2C.
3. Press the navigation wheel  to select the row. The red lights for each crosspoint in the row are on, as shown in the following figure.

**Figure 9: One row selected**



### NOTE

On the Model 707B, if you scroll past the last row of any slot, you will go to the next slot.

4. After choosing the row, press the navigation wheel . A column of red lights is displayed.
5. Turn the navigation wheel  to go to column 03. Note that scrolling through the columns will not scroll through slots as scrolling through rows does.
6. Press the navigation wheel  or **ENTER** to select the column and row. This channel is now displayed on the bottom display as 2C+03.
7. To:
  - Open the channel: Press **OPEN**.
  - Close a channel without affecting any other channels: Select **CLOSE**.
  - Close a channel and open any other closed channels on the instrument: Select **CHAN** and select **EXCLOSE**. Press **ENTER** to close the selected channels.
  - Close a channel and open any other closed channels on the slot that contains the selected channel: Select **CHAN**, and then select **EXSLOTCLOSE**. Press **ENTER** to close the selected channels.

## Viewing the close or open status of a channel

Closed channels are shown separated by commas after the **CLS:** characters on the display of the instrument. If no channels are closed, <none> is displayed here. If the list of closed channels extends past one screen, . . . is displayed at the end of the line. Press **DISPLAY** to display the full list of closed channels. Use the navigation wheel  to scroll through the list. After viewing the list, press **DISPLAY** twice to return to the main display.

**Figure 10: Multiple closed channels**

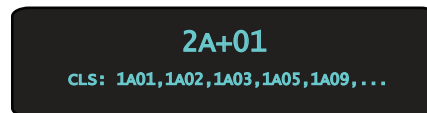

## Channel patterns

You can use channel patterns as a convenient way to refer to a group of switching channels with a single alphanumeric name. When you perform close or open operations on a channel pattern, only the channels that are in the channel pattern are affected.

There is no speed advantage in performing close and open operations on channel patterns compared to performing the same operations on individual channels or a list of channels.

## Create a channel pattern

When you create a channel pattern, make sure to:

- Include all of the channels that are needed for that channel pattern.
- Check that channels contained in the pattern are correct.
- Check that channels contained in the pattern create the desired path connection.
- Make sure that channels that you want to include in the pattern are not set to forbidden to close.

When naming the channel pattern, be aware:

- The first character of the name must be alphabetic (upper or lower case)
- Names are case sensitive
- Pattern names must be different than row, column, and channel labels

### Exercise: Create channel pattern "TEST01" from closed channels

*To create channel pattern "TEST01" from channels currently closed:*

1. Close the channels you want to include in the channel pattern. For this example, close channels "1A01," "1B02," and "1C03." Refer to [Selecting and closing a channel from the front panel](#) (on page 2-7) for instructions on how to close individual channels.
2. Press the **PATT** key.
3. From this menu, select the **CREATE** menu item.
4. From this menu, select the **SNAPSHOT** menu item.
5. At the prompt, enter a pattern name using the navigation wheel. For this example, enter the name **TEST01**. Use the navigation wheel to select each character of the name.
6. Use the **ENTER** key to apply the selection.
7. Use the **EXIT** key to leave the menu.

### NOTE

Refer to "Channel patterns" in the Models 707B and 708B Reference Manual for more details.

## Performing close and open operations on channel patterns



### WARNING

*Careless channel pattern operation could create an electric shock hazard that could result in severe injury or death. Improper operation can also cause damage to the switching cards and external circuitry. The control of multiple channels using channel patterns should be restricted to experienced test engineers who recognize the dangers associated with multiple channel closures.*

You can close and open channel patterns the same way you do for individual channels.

When you request a close or open operation, the Model 707B or 708B verifies that the channels exist for a pattern, but does not verify that the switch path connection is correct. You must ensure the requested operation is safe for a channel pattern and that a good connection will result for your application with the channel pattern.

### **Exercise: Close channel pattern "TEST01" from the front panel**

---

#### ***To close channel pattern "TEST01" from the front panel:***

1. Press the **PATT** key to display a channel pattern.
2. Use the navigation wheel to select "TEST01," the channel pattern you want to close.  
**Model 707B only:** Note that when you select a pattern, on the crosspoint display, the lights for the channels included in the pattern are dimly lit.
3. Perform any of the following actions:
  - Open the channels in the channel pattern: Press **OPEN**.
  - Close the channels in the channel pattern without affecting any other channels: Press **CLOSE**.
  - Close the channels in the channel pattern and open any other closed channels on the instrument: Select **PATT** and select **EXCLOSE**. Press **ENTER** to open or close the channels.
  - Close the channels in the channel pattern and open any other closed channels on the slot: Press **PATT** and select **EXSLOTCLOSE**. Press **ENTER** to open or close the channels.

## **Set up row, column, and channel labels**

You can define labels for rows, columns, and channels. Using labels is a more descriptive way to refer to switching paths than the default channel identifiers.

Labels must be unique; they cannot have the same as the name of another row, column, channel, or channel pattern. Labels cannot contain spaces, and they do not persist through a power cycle.



Channel labels can be up to 19 characters. Row and columns labels can be up to 8 characters. On the crosspoint display, the first four characters of the label are displayed. On the bottom display, the full label is displayed.

You can only set labels for slots and channels that are installed in the instrument.



## Exercise: Create a row label for row D using the front panel

### *To create a row label for row D using the front panel:*

1. If a pattern name is currently displayed on the bottom display, press **CHAN** to place the display in Channel view.
2. Use the navigation wheel to select any channel on row D. For example, select "1D01."
3. Press CONFIG, then press CHAN.
4. Use the navigation wheel  to select **LABEL-ROW** to define a row label. The label selections are defined as:
  - **LABEL:** Sets the label that is displayed on the front panel for the specified crosspoint.
  - **LABEL-ROW:** Sets the label that is displayed on the front panel for the specified row.
  - **LABEL-COL:** Sets the label that is displayed on the front panel for the specified column.
5. Change the row label to "SMU1" using the navigation wheel  to change each character.
6. Press the navigation wheel  or **ENTER** to save the change.
7. Press **EXIT** to return to the main display.

The bottom display will now use "SMU1" to refer to row D on slot 1. For example, selecting crosspoint "1D03" prints "SMU1+03" to the bottom display. Additionally, the crosspoint display on the Model 707B updates to use the new row label.



### Quick Tip

The exercise, "[Create a script using TSB embedded](#)," shows setting up labels using the remote interface and TSB Embedded.

---

# Using the web interface

### In this section:

---

Introduction .....	3-1
Connect to the instrument web interface .....	3-1
Web interface home page .....	3-2
Log in to the instrument.....	3-2
Card pages.....	3-3
Scan Builder page.....	3-8
TSB Embedded.....	3-11

## Introduction

The Model 707B or 708B web interface allows you to review instrument status, control the instrument, and upgrade the instrument over a LAN connection.

The instrument web page resides in the firmware of the instrument. Changes you make through the web interface are immediately made in the instrument.

Many examples in this manual and in the Model 707B and 708B Reference Manual can be run through the TSB Embedded page of the instrument web interface.

## Connect to the instrument web interface

The web interface requires the web browser plug-in Sun Java Runtime Environment Version 6 or higher. Installation files are also available on the Models 707B and 708B Product Information CD-ROM that came with your instrument. Install the J2SE software.

The ActiveX control and Java applets are installed from the instrument but, depending on the browser security settings, they may require the users permission to be downloaded and installed.

To connect to the instrument web interface, you must have an LAN connection from the computer to the instrument. See "LAN communications" in the Model 707B and 708B Reference Manual. Follow the instructions under the heading, "LAN quick start."

An alternative to the LXI Discovery Tool is to follow the instructions below to connect to the instrument:

1. Confirm the LAN light on the instrument is illuminated.

2. Open an Internet browser, such as Windows Internet Explorer (v6.0 or higher only).
3. In the Address box, enter the IP address of the instrument (to find the IP address, from the front panel of the instrument, select **MENU > LAN > STATUS > IP-ADDRESS**).

The home page of the instrument web interface is displayed.

## Web interface home page

The home page of the instrument web interface gives you basic information about the instrument, including:

- The model, serial number, firmware revision, raw socket, and LXI information
- A list of slots and the switch cards installed in each slot
- An ID button to help you locate the instrument

## Log in to the instrument

The web interface has both interactive and read-only pages. These pages are always listed in the navigation panel on the left side of the web interface. You can review information on any of the pages without logging in, but to change information, you must log in.

Pages that contain information you can change include a **Login** button. You must be logged in to complete the exercises in this section. Once you have logged in to one page of the web interface, you do not need to log in again unless you reload the page.

### *To log into the instrument:*

1. Open a page that contains a **Login** button, such as one of the Cards pages, Scan Builder, or TSB Embedded.
2. Click **Login**. The login dialog box is displayed.

**Figure 11: Log in**

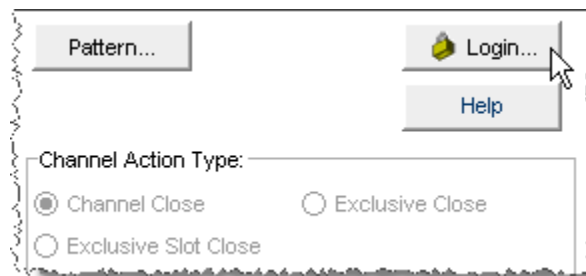

3. Enter the password (the default is **admin**).

Figure 12: Enter password

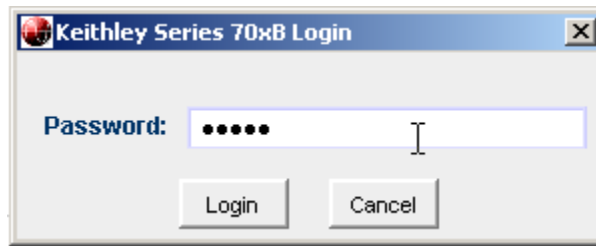

4. Click **Login**.

**NOTE**

The default password is **admin**. If the password has been changed, it is available from the front panel of the instrument. Press **MENU > LAN > STATUS > PASSWORD**.

## Card pages

The card pages are interactive pages where you can work with channels in each slot.

To open a card page, on the left navigation, click the slot number.

There is a specific page for each card installed in the mainframe. This page displays a grid that shows the relay configuration of the switch card.

Figure 13: Web interface Cards page

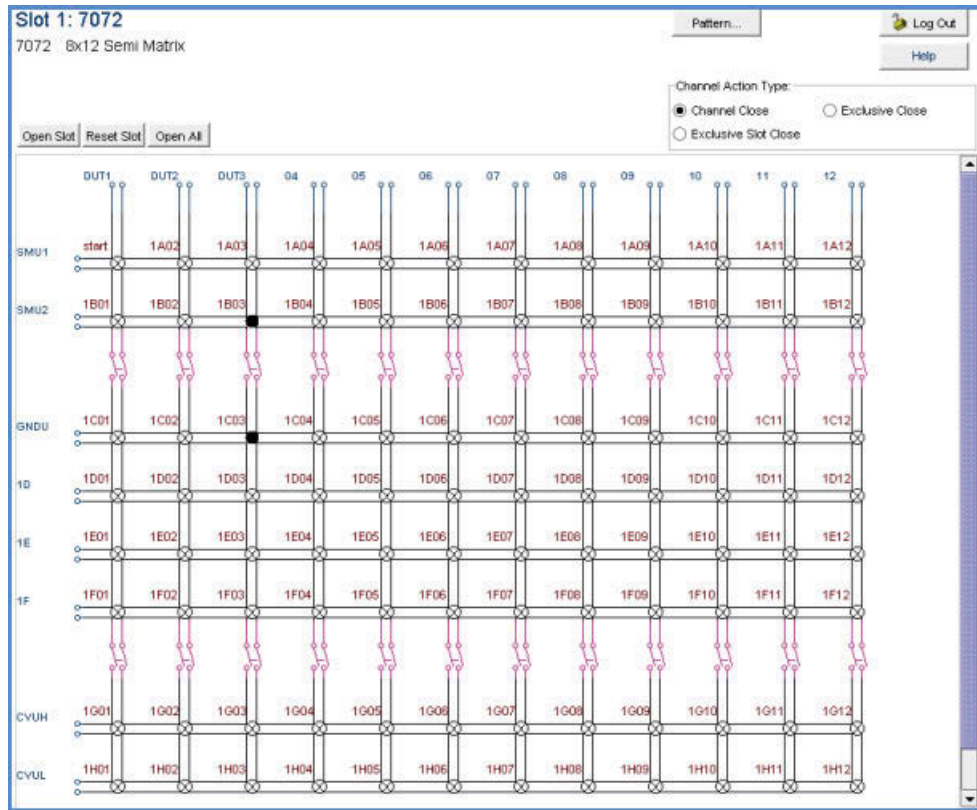

### Open and close channels from the card pages

You can open and close channels from the card pages in several ways.

The simplest method is to click a connection. The channel changes state to open or closed. When the channel is open, the connection is a circle with an x in it:

Figure 14: Web interface open channel



When the channel is closed, the connection is black:

Figure 15: Web interface closed channel



To specify the type of close, select a Channel Action Type from the box in the upper right before closing a channel. The options are:

- **Channel Close:** Close the selected channel without affecting the state of any other channels.
- **Exclusive Slot Close:** Close the selected channel and open any closed channels in the same slot.
- **Exclusive Close:** Close the selected channel and open any closed channels in the instrument (the only closed channel is the selected channel).

You can open all channels in a slot by clicking **Open Slot**.

You can open all channels in the instrument by clicking **Open All**.

For more information on opening and closing channels, see "Working with channels" in the Models 707B and 708B Reference Manual.

### **Exercise: Close multiple channels using the web interface**

---

This exercise describes how to close channels and channel patterns using the web interface.

**To close multiple channels using the web interface:**

1. The instrument home page is displayed. From the navigation on the left, select the slot that contains the channels you want to close.

**Figure 16: Select the slot**

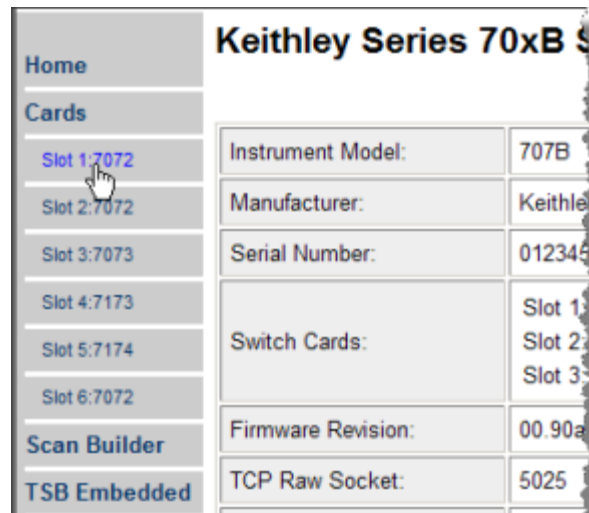

2. You must log into the instrument to work with the channels. See [Log in to the instrument](#) (on page 3-2). After logging in, you can access the channel controls.
3. To close channel "1A01," click the channel.

**Figure 17: Close a channel**

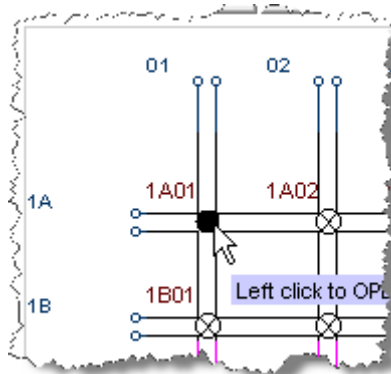

4. To perform an exclusive close on channel "1A02," select **Exclusive Slot Close** in the Channel Action Type box.

**Figure 18: Select exclusive slot close**

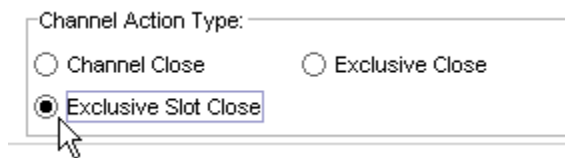

5. Click **1A02** to close that channel and open all other channels.

**Figure 19: Close a channel with exclusive close**

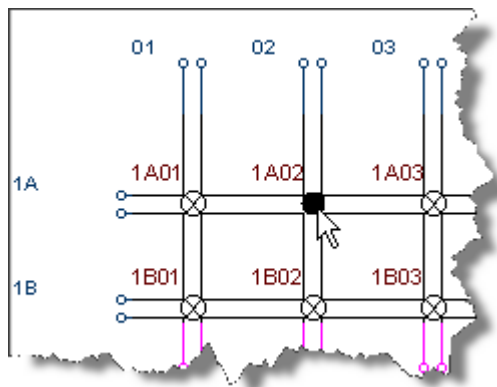

## Set up channel patterns from the web interface

You can use channel patterns as a convenient way to refer to a group of switching channels with a single alphanumeric name. When you perform close or open operations on a channel pattern, only the channels that are in the channel pattern are affected.

There is no speed advantage in performing close and open operations on channel patterns compared to performing the same operations on individual channels or a list of channels.

## Exercise: Create channel pattern "TEST02" using the Snapshot feature

*To create a channel pattern "TEST02" from the web interface using the Snapshot feature:*

1. From the left navigation, click slot 1.
2. Close the channels that you want to include in the pattern. For this example, close channels **1D12**, **1C11**, **1B10**, and **1A09**.
3. Click **Pattern** (above the Channel Action Type box). The Channel Pattern Configuration dialog box is displayed.
4. Type **TEST02** for the pattern name in the box at the top of the dialog box.
5. Click **Snapshot**. A new pattern is created that contains the closed channels.

**Figure 20: Channel pattern configuration dialog box**

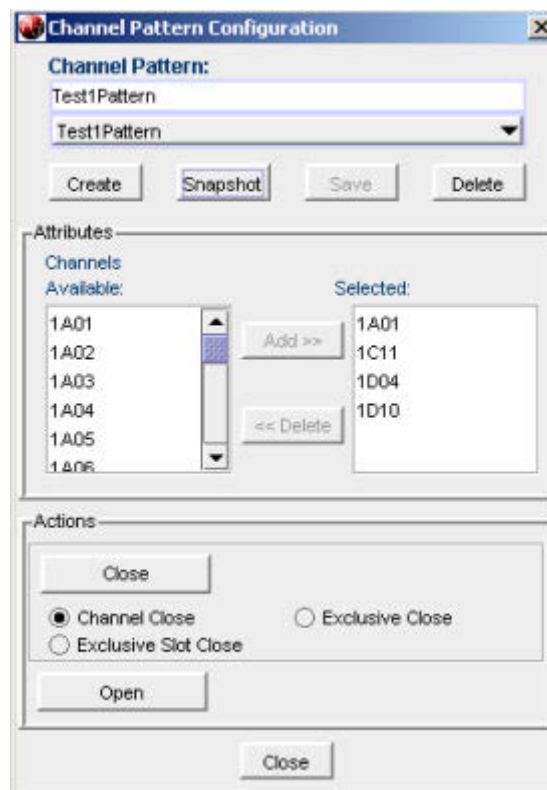

## Exercise: Close channels in "TEST02" from the web interface

*To close channels in channel pattern "TEST02" from the web interface:*

1. Click **Pattern** (above the Channel Action Type box). The Channel Pattern Configuration dialog box is displayed.
2. Select **TEST02** from the list box at the top of the dialog box.
3. In the Actions area, select the type of close you want to perform.



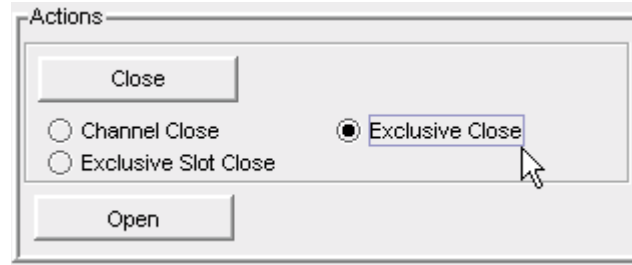

4. Click **Close** to close the channels.
5. When you are done acting on this channel pattern, click **Close** at the bottom of the dialog box to exit.

**To delete a channel pattern from the web interface:**

1. Select the name of the pattern that you want to delete in the Channel Pattern Configuration dialog box.
2. Click **Delete**.
3. For more information about patterns, including opening and closing the channels that are in patterns, see [Channel patterns](#) (on page 2-11).

## Scan Builder page

The Scan Builder page allows you to set up and run scans and triggers.

A scan is a series of steps that opens and closes switches sequentially for a selected group of channels. During each step, actions occur, such as waiting for a trigger, taking a measurement on an external instrument, and completing a step count. Scans automate actions that you want to perform consistently and repeatedly on a set of channels.

Triggers are events that prompt the instrument to move from one step to another in a scan. Triggers can come from a variety of sources, such as a key press, digital input, or expiration of a timer. The sequence of actions and events that occur during the scan is called the trigger model, described in Trigger model.

Scanning and triggering allow you to synchronize actions across channels. You can set up a scan using the trigger model to precisely time and synchronize the Model 707B or 708B between channels and multiple instruments. You can also use triggers without the triggering model to set up a scan to meet the needs of a specific application that does not fit the triggering model.

### NOTE

If you use Scan Builder to create a scan, use the options in the Scan Builder to run the scan. Using the TSB Embedded page may not give you the expected results.

## Create a scan list

Before you can run a scan, you must create a scan list. A scan list is a set of steps that runs in order during a scan. Each step contains a channel, channels, or channel patterns that you want to measure in that step. Each step is acted on separately during the scan.

You can mix channel patterns and individual channels in a scan list. Note that the steps are executed in the order in which they are added to the scan.

### NOTE

Before setting up a scan list, make sure your channels and channel patterns are configured. See "Working with channels" in the Models 707B and 708B Reference Manual for detail.

If you change the channel configurations or channel patterns after the scan list has been set up, you may not see expected results. If the change prevents the scan from functioning properly (such as deleting something referenced by the scan), an error message is logged.

## Exercise: Create a scan list from the web interface

### *To create a scan list from the web interface:*

In this exercise, create a scan list containing channels **1A01**, **1B02**, **1C03**, **1D04**, **1E05**, and pattern **TEST01**.

1. From the left navigation of the web interface home page, select **Scan Builder**.
2. In the Add Channel By list on the right, select **Number** to add the channels. Select the channel numbers **1A01**, **1B02**, **1C03**, **1D04**, and **1E05** from the list. You can use **Ctrl+click** to select multiple channels and **Shift+click** to select a range of channels. To remove your selections from the Add Channel By list, click **Clear Channel Selection**.
3. Click **Add Step**. The channels are added to the Steps list.
4. In the Add Channel By list on the right, select **Pattern** to add channel pattern TEST01. Select **TEST01** from the Channel Pattern List.
5. Click **Add Step**. The pattern is added to the Steps list.
6. In the Scan Count box, enter the number of times you want to repeat the steps in the scan. For example, enter **5**.

## Run the scan

You can run a scan in one of several ways:

- **Background:** Runs the scan in the background so that you can perform other tasks while the scan is running. You can use the Query State to check scan status.
- **Step by Step:** Steps through the scan.

**To run the scan from the web interface:**

Click **Execute Background** or **Step by Step**.

## Stop the scan

**To stop the scan from the web interface:**

On the Build & Run tab, click **Abort**.

## Clear the scan list from the web interface

Clearing the scan list deletes all channels and channel patterns from the scan list.

**To clear the scan list from the web interface:**

1. From the left navigation area of the web interface home page, select **Scan Builder**.
2. Click **Scan Clear**.

## Set up simple triggers

You can set up triggers to control your scan using the options on the Simple Triggers tab. You can set:

- The event that starts the scan
- The time interval between scans
- The time interval between channels

To see these options, click the **Simple Trigger** tab in the top left corner of the Scan Builder page.

### Trigger to start a scan

---

You can choose the triggers that will be used to start the scan. The options to start the scan are:

**Immediate:** When Immediate is selected, the scan starts as soon as you click **Execute Background** on the Build & Run tab. Select Immediate when you do not have trigger requirements to start the scan. This is the default selection.

**Digital Input:** When selected, you select a digital line (1 to 14) that is used to start a scan. You can select falling or rising for the digital input. Falling selects the falling edge trigger. Rising selects the rising edge of the trigger.

### NOTE

If Other is displayed in the mode list, a different mode (other than falling or rising) is already selected. Other is not a mode and cannot be selected. It is only an indicator that the digital triggering is already set up for a different mode. See the Models 707B and 708B Reference Manual, "Using the web interface" section, and the "Advanced triggering" topic for other options.

You can select the trigger to use to continue channel action for each scan. The options to continue channel action are:

**Immediate:** When immediate is selected, the scan immediately steps to the next channel in the scan list. This is the default setting.

**Digital Input:** When selected, you select a digital line (1 to 14) that is used to trigger the instrument to step to the next channel. You can select falling or rising for the digital input. Falling selects the falling edge trigger. Rising selects the rising edge of the trigger.

**Every *N* seconds:** This parameter adds a fixed delay between each channel. The delay occurs before the next channel in the scan list is closed.

## TSB Embedded

TSB Embedded is an application that includes a command line interface that you can use to issue ICL commands. It also offers script-building functionality. TSB Embedded resides in the instrument. You can use TSB Embedded to run some of the application examples in Section 5 of this manual, [Working with the Series 2600A](#) (on page 5-1).

### Create a script using TSB Embedded

#### NOTE

If you are using TSB Embedded to create scripts, you do not need to use the commands `loadscript` or `loadandrunscript` and `endscript`. For information on using TSB Embedded, see the help located on the instrument's web page.

#### Exercise: Create and run a script with TSB Embedded

This exercise script assigns row and column labels for the card installed in slot 1. It then commands the Model 707B or 708B to close a crosspoint specified by the row and column labels.

##### *To create and run a script with TSB Embedded:*

1. From the navigation area on the left side of the web interface, select TSB Embedded. The TSB Embedded page is displayed.

Figure 21: Select TSB Embedded

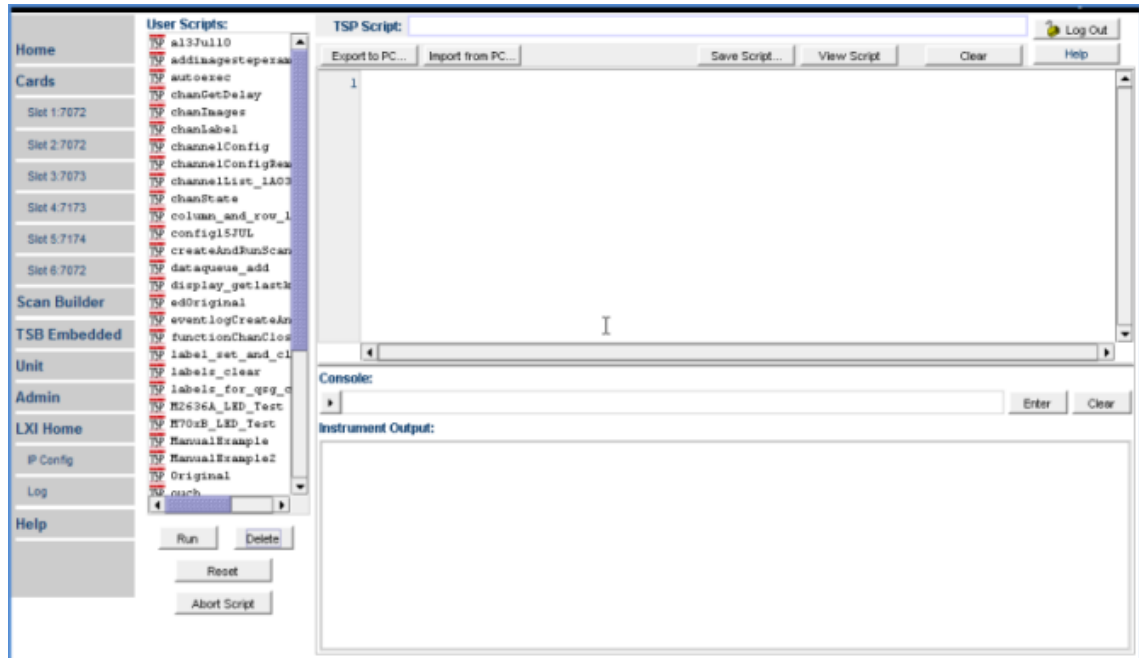

2. You must log in to the instrument to use TSB Embedded. After logging in, you can access the options on the TSB Embedded page.
3. To create the example script, enter the name, **column\_and\_row\_labels**, in the TSP Script box.

Figure 22: Enter script name

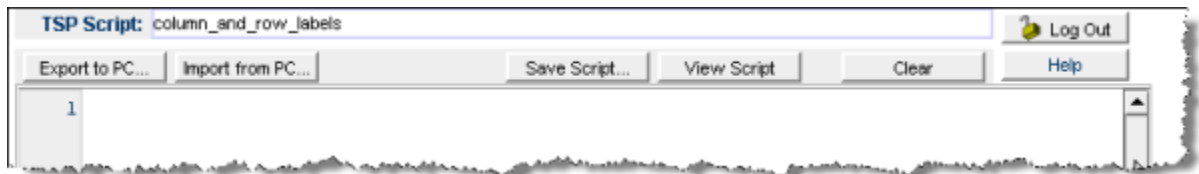

4. Enter the code below in the box below the buttons:

```
channel.setlabelrow("1A01", "SMU1")
channel.setlabelrow("1B01", "SMU2")
channel.setlabelrow("1C01", "GNDU")
channel.setlabelrow("1G01", "CVUH")
channel.setlabelrow("1H01", "CVUL")
channel.setlabelcolumn("1A01", "DUT1")
channel.setlabelcolumn("1B02", "DUT2")
channel.setlabelcolumn("1C03", "DUT3")
channel.open("allslots")
channel.close("SMU1+DUT3")
```

**NOTE**

Commands and parameters for Models 707B and 708B are case-sensitive. It is important to type in the commands exactly as show to avoid any syntax and execution errors.

5. Click **Save Script**. The script is added to the User Scripts list.

**Quick Tip**

Standard edit functions, such as Copy, Cut, and Paste, work within TSB Embedded.

**Figure 23: Script added to User Scripts list**

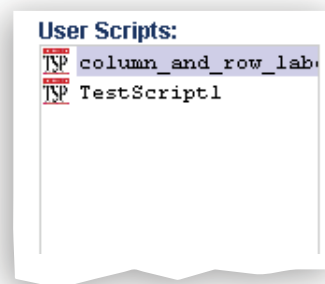

6. To run the script, select the script in the User Scripts list and click **Run**.
7. The Instrument Output box displays any error messages and output from the script.

**Script management options**

Existing scripts are listed in the User Scripts box on the left side of the web interface. To delete a script, click the name of the script and click **Delete**. The script is deleted from the User Scripts list and from the nonvolatile memory of the instrument. To stop operation of a script, click **Abort Script**.

To export the selected script to the computer, click **Export to PC**. Choose the directory where you want to save the script and click **Save**. Scripts are saved to a file with the extension `tsp`. TSP files are native to Test Script Builder or TSB Embedded, but they can be opened and edited in any text editor.

To import scripts from the computer, click **Import to PC**. Select the directory that contains the file. You can only import files with the extension `tsp`.

To clear the name box and the box that contains the script, click **Clear**. You can type the name of a script in the **TSP Script** box and click **View Script** to view the contents of the script.

**Exercise: Use the command line to close and open channels**

**Use the command line interface to perform close and open operations on channels:**

1. To send a single command to the instrument, you can enter it in the Console box.
2. To close channel 1B02, enter `channel.close("1B02")` in the Console box.

3. Click **Enter** to send the command.

**Figure 24: Enter command in Console box**

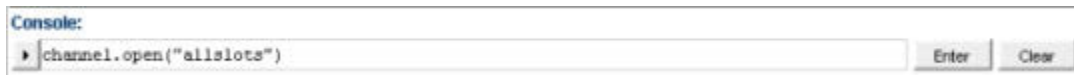

4. To open all channels, enter `channel.open("allslots")` in the Console box.
5. Click **Enter** to send the command.
6. To resend a command, click the drop-down arrow on the left side of the Console box.

**Figure 25: Model 707B or 708B web interface console**

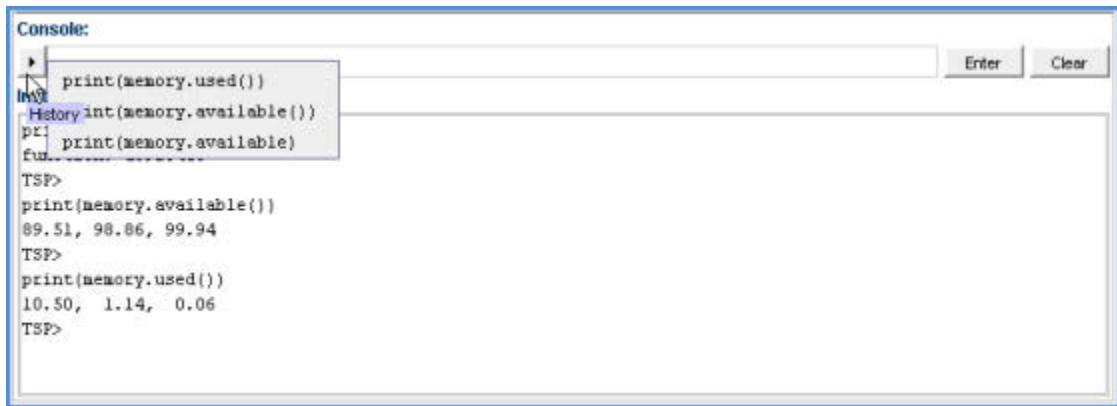

More information about commands to control the instrument can be found in the Models 707B and 708B Reference Manual.

---

## Working with the Model 4200-SCS

### In this section:

---

Introduction .....	4-1
Equipment required to run the example .....	4-1
Configure Model 707B or 708B for Model 4200-SCS .....	4-1
Add Model 707B or 708B to Model 4200-SCS .....	4-2
Next steps .....	4-3

## Introduction

You can connect the Model 4200 Semiconductor Characterization System to a Model 707B or 708B. This enables the Model 4200-SCS to automate measurements to multiple devices for DC, CV, and pulsed I-V characterization.

This section describes:

- How to configure the Model 707B or 708B for use with the Model 4200-SCS
- How to add the Model 707B or 708B to a Model 4200-SCS
- Where to look for more information

## Equipment required to run the example

To run this test, you will need the following equipment:

- One Model 4200-SCS instrument
- GPIB cable to connect the Model 707B or 708B to the Model 4200
- Model 707B or 708B and associated switch cards

## Configure Model 707B or 708B for Model 4200-SCS

To use the Model 707B or 708B with the Model 4200-SCS, first configure the Model 707B or 708B to use compatible Model 707A commands:

1. Press **MENU**.
2. Select **DDC**.



3. Select **ENABLE**.
4. Select **70xA-VERSION**. The instrument displays the message "Must Power Cycle for DDC to enable."

Figure 26: Front panel DDC enable menu



5. Press **ENTER**.
6. Cycle power to the instrument.

## NOTE

When DDC mode is enabled (70xA-VERSION OR 70xB-VERSION), the Model 707B or 708B sends a different identification string in response to the "\*IDN?" query. With DDC mode enabled, the response of the 707B to "\*IDN?" is:

```
707A03
```

With DDC mode disabled (OFF), the response to "\*IDN?" is:

```
KEITHLEY INSTRUMENTS INC, MODEL 707B, <serial #>, <firmware rev>
```

## Add Model 707B or 708B to Model 4200-SCS

### *To add the Model 707B or 708B to the Model 4200-SCS:*

1. Connect the Model 707B or 708B to the GPIB controller on the Model 4200.
2. Ensure that the Model 707B or 708B has a GPIB address that is different than any other instrument connected to the Model 4200-SCS and is different than the controller's address.
3. On the Model 4200, open KCON.
4. In KCON, open the **Tools** menu.
5. Select **Add External Instrument**.
6. Select **Switch Matrix**.
7. Select **Model 707/707A Switching Matrix**. Note that the instrument is added to the Configuration Navigator. In the KCON Workspace, the Switch System Properties dialog box is displayed.
8. Enter the appropriate GPIB Address for the Model 707B or 708B.
9. Select an instrument connection scheme.
10. Select the switch cards that you have already installed in the Model 707B or 708B.
11. From the Tools menu, check the configuration by selecting **Validate Configuration**.

12. When the Model 4200-SCS finds the Model 707B or 708B, a green check mark appears next to "Verifying Keithley 707A Switching Matrix." If there is an error, a red X appears next to "Verifying Keithley 707A Switching matrix." An error description is provided. Generally, these errors are associated with an incorrect GPIB address.
13. From the File menu, save the current configuration by selecting **Save Configuration**.

You can now use the Model 707B or 708B with the Model 4200-SCS.

## Next steps

See the Model 4200-SCS Reference Manual, "Appendix B: Using Switch Matrices," "Key Concepts" section, which includes:

- Switch matrix connection scheme settings for row-column and instrument cards
- Configuring switch card property configurations in KCON
- Connecting the Model 4200-SCS instrument to the Model 707B or 708B
- Accessing and using the user module library to control the switch matrix

See "Section 15: Multi-Frequency C-V measurements" in the Model 4200-SCS Reference Manual, which includes information on using the Model 4200-CVU card with a switch matrix.

To customize the switch user library of the Model 4200-SCS, see the Models 707B and 708B Reference Manual, "Using Models 707A and 708A compatibility mode".



---

## Working with the Series 2600A

### In this section:

---

About the Series 2600A examples .....	5-1
Equipment required to run the examples .....	5-2
Connect the equipment .....	5-2
Logical block diagram of test connections .....	5-3
Example 1: Control with separate interfaces .....	5-4
Example 2: Using TSP-Link to configure instruments	5-7
Example 3: Configure using TSP-Link and interactive triggers .....	5-12
Example 4: Using the scanning and triggering model	5-17

## About the Series 2600A examples

This section shows you how to use the Model 707B or 708B with a Series 2600A System SourceMeter<sup>®</sup> instrument to perform an I-V sweep across a diode. In each example, the Model 707B or 708B connects a diode across the output of SMUA of the Series 2600A SourceMeter Instrument (SMU). The SMU then performs an I-V sweep across the diode.

There are four examples in this section, progressing from using direct control over the remote communication interface to automating the sweep using the scan and trigger model.

**Example 1** shows you how to control the Series 2600A and Model 707B or 708B instruments using direct control over the remote communication interface. This example:

- Demonstrates how to use the PC to send commands to each instrument separately and cannot be run using TSB Embedded. It requires a separate application development environment.
- Requires two communication identifiers, such as the GPIB address or LAN IP address. One is required for the Model 707B or 708B and the other for the Series 2600A.
- Does not require TSP-Link.
- Does not use hardware triggering or the scanning and triggering model of the Model 707B or 708B.

**Example 2** shows you how to use TSP-Link to configure the Series 2600A and Model 707B or 708B instruments. This example:

- Can be run using TSB Embedded.
- Demonstrates how to configure the TSP-Link interface for communication between the instruments.
- Requires unique TSP-Link node numbers for each instrument.
- Demonstrates the benefit of using the TSP-Link interface to send commands to another instrument.
- Does not require hardware triggering or the scanning and triggering model of the Model 707B or 708B.

**Example 3** shows you how to use the TSP-Link interface and interactive triggering with Series 2600A and Model 707B or 708B instruments. This example:

- Can be run using TSB Embedded.
- Demonstrates how to create, load, and execute a TSP script that includes functions.
- Demonstrates how to use the functions in the script to run the test.
- Demonstrates the benefit of using TSP scripts to run the test independently of computer control after initiating a test to run.
- Uses the TSP-Link interface for communication and interactive hardware triggering.
- Does not use the scanning and triggering model of the Model 707B or 708B.

**Example 4** shows you how to use the scanning and triggering model of the Model 707B or 708B with the SourceMeter instrument. This example:

- Can be run using TSB Embedded.
- Demonstrates how to create, load, and execute a TSP script that includes functions, and how to use those functions to run the test.
- Demonstrates the benefit of using TSP scripts to run the test independently of computer control after initiating a test to run.
- Uses the TSP-Link interface for communication and interactive hardware triggering.
- Demonstrates how to use the scanning and triggering model to achieve hardware synchronization during a test.
- Illustrates the speed advantage of preconfiguring the sequence of crosspoints used during the test.
- Includes instructions on how to create a scan list, how to execute a foreground scan, how to configure the trigger model to automatically wait for and assert trigger signals.

## Equipment required to run the examples

To run this test, you will need the following equipment:

- Six diodes with triaxial connections
- One Model 707B or 708B
- One switch matrix card (Model 7174A, 7072, or 7072-HV). You can also use the Model 7173-50 if you convert the connection to coaxial instead of triaxial.
- One Model 2635A SourceMeter Instrument or equivalent source measurement unit (SMU). You can use the Models 2601A and 2611A SourceMeter instruments if an adaptation is made from the screw terminals on the instrument to the triaxial connections on the switch card.

## Connect the equipment

The communication setup and hardware changes for each of the examples and is described at the beginning of each example. However, all of the examples use the same test equipment setup, as shown in the following figure.

**NOTE**

This figure shows connections to the Model 7072 8x12 Switch Card. However, you can make similar connections to the other switch cards listed for this example.

**Figure 27: Connections to switching module**

**Model 2635A**

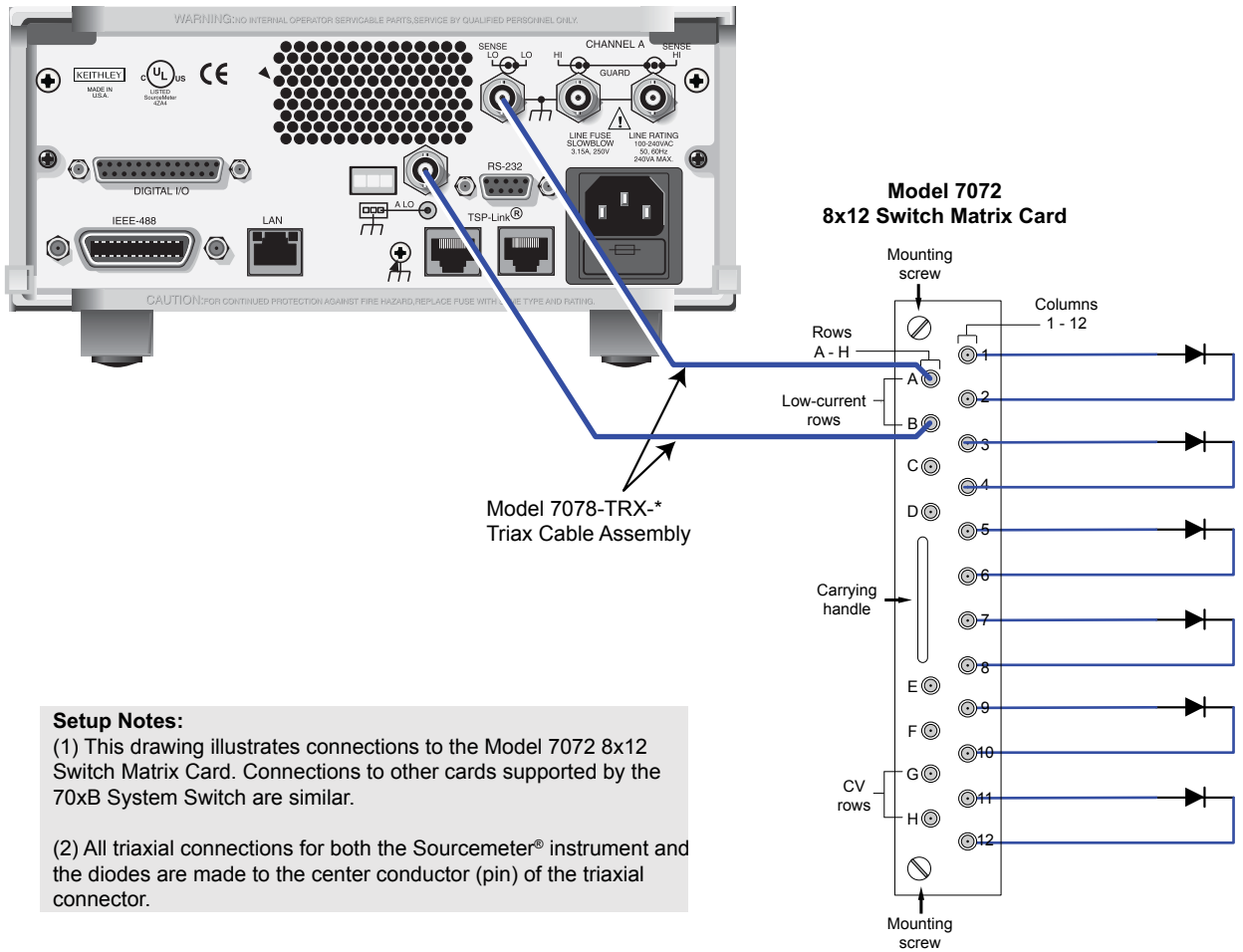

**Setup Notes:**

(1) This drawing illustrates connections to the Model 7072 8x12 Switch Matrix Card. Connections to other cards supported by the 70xB System Switch are similar.

(2) All triaxial connections for both the Sourcemeter® instrument and the diodes are made to the center conductor (pin) of the triaxial connector.

## Logical block diagram of test connections

The following figure shows the logical block diagram of the test connections.

**Figure 28: Logical block diagram of test connections**

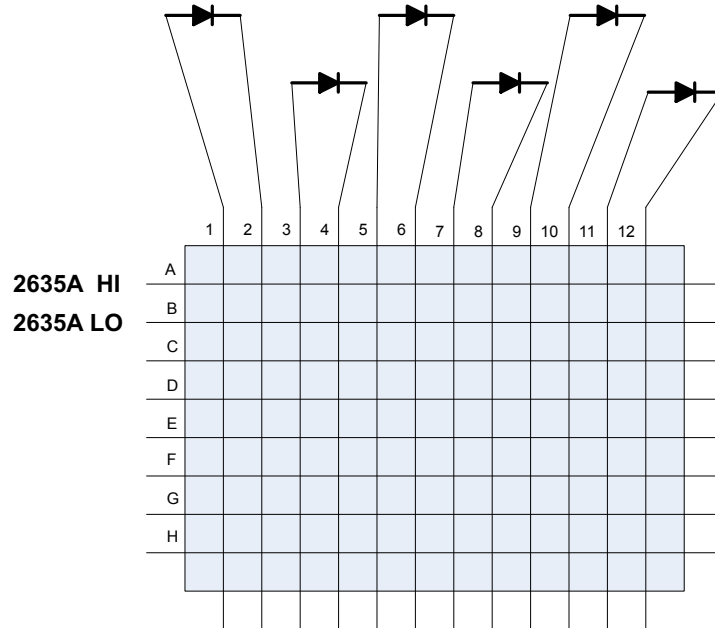

### Example 1: Control with separate interfaces

**Controlling Series 2600A and Model 707B or 708B instruments using separate communication interfaces**

To run this test, you create a table on the Model 707B or 708B that contains the crosspoints that are needed to connect the SMU to each diode under test, one at a time. The SMU then performs an I-V sweep on the diode. Data from the SMU is returned to the controlling computer after all six diodes have been tested.

### Set up communication

The communication setup is illustrated in the diagram below. GPIB is used as an example, but this application can be run using any of the supported communication interfaces for the instruments.

**Figure 29: GPIB communication setup**

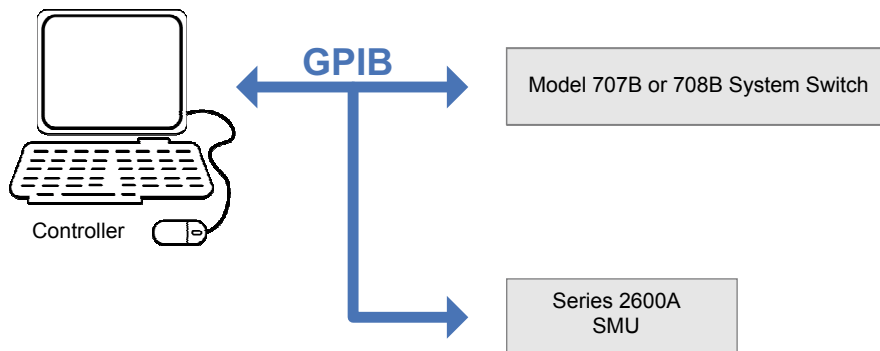

## Example program code for the Model 707B or 708B

### NOTE

The example code does not include programming syntax to issue commands from the host computer over GPIB or LAN communication interfaces. It cannot be run using TSB Embedded. You are expected to send the instrument commands by means of a separate application development environment, such as Microsoft® Visual Studio® or National Instruments Labview™.

Send the following commands to configure the Model 707B or 708B.

Example program code for the Model 707B or 708B	
Code	Notes and comments
<code>reset</code>	Reset the instrument to factory defaults.
<code>errorqueue.clear()</code>	Clear all errors.
<code>matrixChannels = {}</code>	Define the table that details crosspoints to close to connect each diode to the source-measure unit (SMU).
<code>matrixChannels[1] = "1A01,1B02"</code>	Add entries to the table.
<code>matrixChannels[2] = "1A03,1B04"</code>	
<code>matrixChannels[3] = "1A05,1B06"</code>	
<code>matrixChannels[4] = "1A07,1B08"</code>	
<code>matrixChannels[5] = "1A09,1B10"</code>	
<code>matrixChannels[6] = "1A11,1B12"</code>	

## Example program code for the Model 2635

Send the following commands to configure the Model 2635 System SourceMeter Instrument.



**Example program code for the Model 2635 System SourceMeter Instrument**

Code	Notes and comments
<pre>reset() errorqueue.clear() smua.nvbuffer1.clear()</pre>	<pre>Reset the instrument. Clear all errors and reset status bits. Clear existing data from the data buffer.</pre>
<pre>smua.source.func = smua.OUTPUT_DCAMPS smua.source.rangei = 0.01</pre>	<pre>Set source function to current source. Set source current range to 10 mA.</pre>
<pre>smua.measure.rangev = 6 smua.measure.nplc = 1 smua.nvbuffer1.appendmode = 1</pre>	<pre>Set voltage measurement range to 6 V. Set integration rate. Enable buffer append mode.</pre>
<pre>smua.trigger.source.limitv = 10 smua.trigger.source.linear(0, 0.01, 11) smua.trigger.source.action = smua.ENABLE</pre>	<pre>Set the voltage compliance during the sweep. Configure linear staircase sweep. Enable the source action during the sweep.</pre>
<pre>smua.trigger.measure.v(smua.nvbuffer1) smua.trigger.measure.action =     smua.ENABLE</pre>	<pre>Configure sweep voltage measurements. Enable voltage measurements.</pre>
<pre>smua.trigger.count = 11 smua.trigger.arm.count = 1</pre>	<pre>Set trigger count to number of steps in the sweep. Set arm count to number of sweeps to perform.</pre>

**Example code to run the test**

To run the test, send the following commands to the corresponding instrument.

**Example program code to run the test**

Model	Code	Notes and comments
2635A	<code>smua.source.output = 1</code>	Turn on the Model 2635A output.
707B or 708B	<code>channel.exclusiveclose(matrixChannels[1])</code>	Connect first diode
2635A	<code>smua.trigger.initiate() waitcomplete()</code>	Initiate sweep. Wait until sweep is complete.
707B or 708B	<code>channel.exclusiveclose(matrixChannels[2])</code>	Connect second diode.
2635A	<code>smua.trigger.initiate() waitcomplete()</code>	Initiate sweep. Wait until sweep is complete.
707B or 708B	<code>channel.exclusiveclose(matrixChannels[3])</code>	Connect third diode.
2635A	<code>smua.trigger.initiate() waitcomplete()</code>	Initiate sweep. Wait until sweep is complete.
Model 707B or 708B	<code>channel.exclusiveclose(matrixChannels[4])</code>	Connect fourth diode.
2635A	<code>smua.trigger.initiate() waitcomplete()</code>	Initiate sweep. Wait until sweep is complete
707B or 708B	<code>channel.exclusiveclose(matrixChannels[5])</code>	Connect fifth diode
2635A	<code>smua.trigger.initiate() waitcomplete()</code>	Initiate sweep Wait until sweep is complete
707B or 708B	<code>channel.exclusiveclose(matrixChannels[6])</code>	Connect sixth diode
2635A	<code>smua.trigger.initiate() waitcomplete() smua.source.output = 0</code>	Initiate sweep. Wait until sweep is complete, then turn off the output.
707B or 708B	<code>channel.open('allslots')</code>	Open all crosspoints
2635A	<code>printbuffer(1, smua.nvbuffer1.n, smua.nvbuffer1.readings)</code>	Retrieve data from the Model 2635A.

## Example 2: Using TSP-Link to configure instruments

### Using TSP-Link to configure the Series 2600A and Model 707B or 708B

This example is identical to the test in example 1, except that TSP-Link is used to communicate to the Model 2635 System SourceMeter instrument from the Model 707B or 708B.

To run this test, you create a table on the Model 707B or 708B that contains the crosspoints that are needed to connect the SMU to each diode under test, one at a time. The SMU then performs an I-V sweep on the diode. Data from the SMU is returned to the controlling computer after all six diodes have been tested.

## Set up communication

The communication setup is illustrated in the diagram below. GPIB is used as an example, but this application can be run using any of the supported communication interfaces for the instruments. A TSP-Link connection enables communication between the two instruments and commands for the SourceMeter (on TSP-Link node 2) are sent over the TSP-Link interface.

**Figure 30: GPIB and TSP-Link connections**

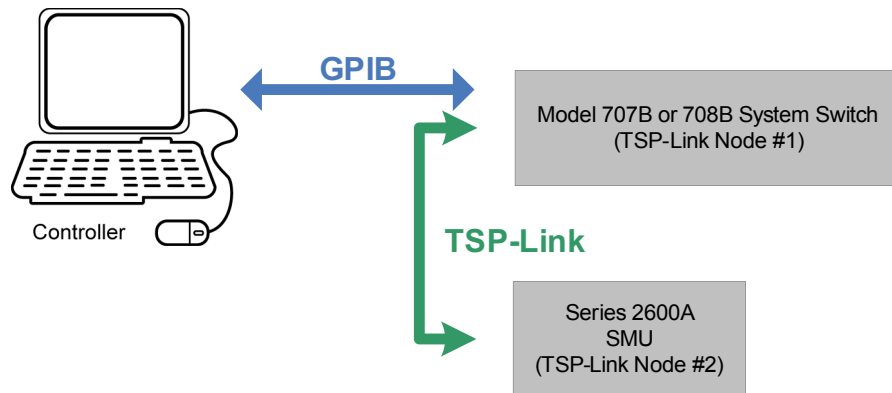

To configure the TSP-Link communication interface, each instrument must have a unique TSP-Link node number. Configure the node number for the Model 707B or 708B to 1 and the SourceMeter Instrument to 2.

**To set the TSP-Link node number using the front panel interface of either instrument:**

1. Press **MENU**.
2. Select **TSPLink**.
3. Select **NODE**.
4. Use the navigation wheel  to adjust the node number.
5. Press **ENTER** to save the TSP-Link node number.

**On the Model 707B or 708B, perform a TSP-Link reset to alert the Model 707B or 708B to the presence of the SMU:**

1. Press **MENU**.
2. Select **TSPLink**.
3. Select **RESET**.

### Quick Tip

You can also perform a TSP-Link reset from the remote command interface by sending `tsplink.reset()` to the Model 707B or 708B. This command is also included in the example program code below for completion.

**NOTE**

If error 1205 is generated during the TSP-link reset, ensure that the Model 2635 System SourceMeter instrument has a unique TSP-Link node number.

**Example program code**

The example code to configure the Model 707B or 708B and System SourceMeter Instrument shown below is identical to the code used in Example 1. However, in this example, all commands are sent to the Model 707B or 708B. This example can be run using TSB Embedded. Commands for the Model 2635 System SourceMeter have the TSP-Link node number appended to the beginning of the command (`node[2]`).

In the following table, the Model 707B or 708B sends the commands in the shaded rows to the System SourceMeter instrument through the TSP-Link interface. Commands in unshaded rows are executed by the Model 707B or 708B.

Example program code for the Model 707B or 708B	
Code	Notes and comments
<pre>tsplink.reset() localnode.reset() errorqueue.clear()  matrixChannels = {}  matrixChannels[1] = "1A01, 1B02" matrixChannels[2] = "1A03, 1B04" matrixChannels[3] = "1A05, 1B06" matrixChannels[4] = "1A07, 1B08" matrixChannels[5] = "1A09, 1B10" matrixChannels[6] = "1A11, 1B12"</pre>	<p>Reset TSP-Link. Reset Model 707B or 708B. Clear errors.</p> <p>Define table that details crosspoints to close to connect each diode to the SMU.</p> <p>Add entries to the table.</p>
<pre>node[2].reset() node[2].errorqueue.clear() node[2].smua.nvbuffer1.clear()</pre>	<p>Reset the instrument. Clear all errors and reset status bits. Clear existing data from data buffer.</p>
<pre>node[2].smua.source.func =     node[2].smua.OUTPUT_DCAMPS node[2].smua.source.rangei = 0.01</pre>	<p>Set source function to current source.</p> <p>Set source current range to 10 mA.</p>
<pre>node[2].smua.measure.rangev = 6 node[2].smua.measure.nplc = 1 node[2].smua.nvbuffer1.appendmode = 1</pre>	<p>Set voltage measurement range to 6 V. Set integration rate. Enable buffer append mode.</p>
<pre>node[2].smua.trigger.source.limitv = 10 node[2].smua.trigger.source.lineari     (0, 0.01, 11) node[2].smua.trigger.source.action =     node[2].smua.ENABLE</pre>	<p>Set the voltage compliance during the sweep. Configure linear staircase sweep.</p> <p>Enable the source action during the sweep.</p>
<pre>node[2].smua.trigger.measure.v     (node[2].smua.nvbuffer1) node[2].smua.trigger.measure.action =     node[2].smua.ENABLE</pre>	<p>Configure sweep voltage measurements.</p> <p>Enable voltage measurements during the sweep.</p>
<pre>node[2].smua.trigger.count = 11  node[2].smua.trigger.arm.count = 1</pre>	<p>Set trigger count to the number of steps in the sweep.</p> <p>Set arm count to the number of sweeps to perform each time the sweep is initiated.</p>

## Example code to run the test

To run the test, send the following commands to the Model 707B or 708B.

**Example program code to run the test**

Code	Notes and comments
<code>node[2].smua.source.output = 1</code>	Turn on the output of the Model 2635A.
<code>channel.exclusiveclose(matrixChannels[1])</code>	Connect first diode.
<code>node[2].smua.trigger.initiate() waitcomplete()</code>	Initiate sweep. Both instruments wait until sweep is complete.
<code>channel.exclusiveclose(matrixChannels[2])</code>	Connect second diode.
<code>node[2].smua.trigger.initiate() waitcomplete()</code>	Initiate sweep. Both instruments wait until sweep is complete
<code>channel.exclusiveclose(matrixChannels[3])</code>	Connect third diode.
<code>node[2].smua.trigger.initiate() waitcomplete()</code>	Initiate sweep. Both instruments wait until sweep is complete.
<code>channel.exclusiveclose(matrixChannels[4])</code>	Connect fourth diode.
<code>node[2].smua.trigger.initiate() waitcomplete()</code>	Initiate sweep. Both instruments wait until sweep is complete.
<code>channel.exclusiveclose (matrixChannels[5])</code>	Connect fifth diode.
<code>node[2].smua.trigger.initiate() waitcomplete()</code>	Initiate sweep. Both instruments wait until sweep is complete.
<code>channel.exclusiveclose(matrixChannels[6])</code>	Connect sixth diode.
<code>node[2].smua.trigger.initiate() waitcomplete() smua.source.output = 0</code>	Initiate sweep. Both instruments wait until the sweep is complete. The SMU output is turned off.
<code>channel.open("allslots")</code>	Open all crosspoints.

To retrieve data from the System SourceMeter instrument through the TSP-Link interface, use the `printbuffer()` command to print the data to the computer communication interface. An example is shown below.

**Example: Retrieve buffer data**

Code	Notes and comments
<code>printbuffer(1, node[2].smua.nvbuffer1.n, node[2].smua.nvbuffer1.readings)</code>	Print all readings from the SMU data buffer. Note that "readings" is a buffer attribute.

## Example 3: Configure using TSP-Link and interactive triggers

This example uses a TSP script to configure and run the test. The script includes two separate functions for configuring the Model 707B or 708B and System SourceMeter Instrument and a third function for running the test. Configuration for both instruments is similar to examples 1 and 2 except that TSP-Link trigger lines are used to coordinate the actions between the two instruments.

When the test is run, the instruments assert trigger signals after completing their respective actions. After connecting the diode, the Model 707B or 708B sends a trigger signal to the System SourceMeter instrument. The SMU then performs a single I-V sweep on the diode and sends a trigger signal back to the Models 707B and 708B to indicate that the test is completed. Hardware handshaking continues in this fashion until all six diodes have been tested. Data from the SMU is returned to the controlling computer at the end of all the tests.



### Quick Tip

A TSP script is a sequence of instrument commands and programming statements. The Model 707B or 708B can store the TSP script for later use. Using scripts allows the Model 707B or 708B to perform simple and complex tasks with less interaction with the remote interface controller (the controlling computer). For more information on using scripts, please see "Instrument Programming" in the Models 707B and 708B Reference Manual.

## Set up communication

In this example, in addition to the TSP-Link interface serving as a communication bus, it will also serve as triggering bus to enable hardware handshaking between the System SourceMeter instrument and Model 707B or 708B.

The communication setup is identical to the setup in Example 2; see [Set up communication](#) (on page 5-8).

There are three digital lines in the TSP-Link cable that may be used for triggering. This example uses trigger lines 1 and 2. The Model 707B or 708B outputs a trigger signal on TSP-Link line 1 and waits for a trigger signal on TSP-Link line 2 before proceeding with the next set of crosspoint closures. The System SourceMeter instrument outputs a trigger signal on TSP-Link line 2 after completing its test and waits for a trigger signal on TSP-Link line #1 before testing. The triggering setup is illustrated in the figure below.

Figure 31: TSP-Link interface

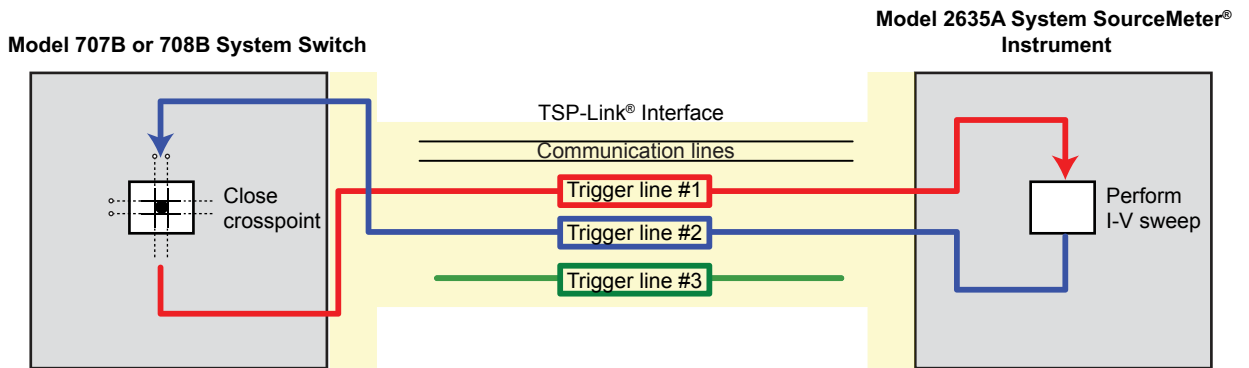

**Note:**  
Trigger line #3 is not used in the example.

### Example program code

In the following table, all commands are sent from the computer to the Model 707B or 708B. This example can be run using TSB Embedded. The Model 707B or 708B sends all commands in the shaded rows to the System SourceMeter instrument through the TSP-Link interface. Commands in unshaded rows are executed by the Model 707B or 708B.



<b>Example program code for the Model 707B or 708B</b>	
<b>Code</b>	<b>Notes and comments</b>
<pre>loadscript diodeTest  function configSwitch()      tsplink.reset()     localnode.reset()     errorqueue.clear()      matrixChannels = {}      matrixChannels[1] = "1A01, 1B02"     matrixChannels[2] = "1A03, 1B04"     matrixChannels[3] = "1A05, 1B06"     matrixChannels[4] = "1A07, 1B08"     matrixChannels[5] = "1A09, 1B10"     matrixChannels[6] = "1A11, 1B12"      tsplink.trigger[1].mode = tsplink.TRIG_FALLING     tsplink.trigger[2].mode = tsplink.TRIG_FALLING     tsplink.trigger[1].clear()     tsplink.trigger[2].clear()      return matrixChannels end</pre>	<p>Create a script "diodeTest" to contain test configuration and execution instructions.</p> <p>Create a function to configure the Model 707B or 708B.</p> <p>Reset TSP-Link. Reset Model 707B or 708B. Clear errors.</p> <p>Define table that details crosspoints to close to connect each diode to the SMU.</p> <p>Add entries to the table.</p> <p>Set TSP-Link lines 1 and 2 to send and receive falling-edge triggers . Clear any latched triggers on TSP-Link trigger lines 1 and 2.</p> <p>Return the table as an output of the function.</p>
<pre>function configSMU()</pre>	<p>Create a function to configure the System SourceMeter instrument.</p>
<pre>    node[2].reset()     node[2].errorqueue.clear()     node[2].smua.nvbuffer1.clear()</pre>	<p>Reset the instrument. Clear all errors and reset status bits. Clear existing data from data buffer.</p>
<pre>    node[2].smua.source.func =     node[2].smua.OUTPUT_DCAMPS      node[2].smua.source.rangei = 0.01</pre>	<p>Set source function to current source. Set source current range to 10 mA.</p>
<pre>    node[2].smua.measure.rangev = 6      node[2].smua.measure.nplc = 1     node[2].smua.nvbuffer1.appendmode = 1</pre>	<p>Set voltage measurement range to 6 V. Set integration rate. Enable buffer append mode.</p>
<pre>    node[2].smua.trigger.source.limitv = 10      node[2].smua.trigger.source.linear(0, 0.01, 11)     node[2].smua.trigger.source.action =         node[2].smua.ENABLE</pre>	<p>Set voltage compliance during sweep. Configure linear staircase sweep. Enable the source action during the sweep.</p>

<pre>node[2].smua.trigger.measure.v(node[2].smua.nvbuffer1)  node[2].smua.trigger.measure.action = node[2].smua.ENABLE</pre>	<p>Configure sweep voltage measurements.</p> <p>Enable voltage measurements during the sweep.</p>
<pre>node[2].smua.trigger.count = 11  node[2].smua.trigger.arm.count = 6</pre>	<p>Set trigger count to the number of steps in the sweep.</p> <p>Set arm count to six, the total number of sweeps that will be run for all diodes.</p>
<pre>node[2].tsplink.trigger[1].mode = node[2].tsplink.TRIG_FALLING node[2].tsplink.trigger[2].mode = node[2].tsplink.TRIG_FALLING</pre>	<p>Set TSP-Link trigger lines 1 and 2 to send and receive falling edge trigger signals.</p>
<pre>node[2].tsplink.trigger[1].clear() node[2].tsplink.trigger[2].clear()</pre>	<p>Clear any latched triggers on TSP-Link trigger lines 1 and 2.</p>
<pre>node[2].smua.trigger.arm.stimulus = node[2].tsplink.trigger[1].EVENT_ID</pre>	<p>Configure sweep to start when signal received on TSP-Link line 1.</p>
<pre>node[2].tsplink.trigger[2].stimulus = node[2].smua.trigger.SWEEP_COMPLETE_EVENT_ID</pre>	<p>Configure System SourceMeter to output trigger signal on TSP-Link line 2 when sweep is complete.</p>
<pre>end  function runDiodeTest()  xptTable = configSwitch()  configSMU() node[2].smua.source.output = 1  node[2].smua.trigger.initiate()</pre>	<p>This function sequences the crosspoint closures and triggering.</p> <p>Call the function to configure the switch storing the result in the variable xptTable.</p> <p>Call function to configure the SMU and turn on its output.</p> <p>Initiate the System SourceMeter so that it is ready to sweep once a trigger signal is received (the output turns on but no power is applied).</p>

<pre> for i = 1, table.getn(xptTable) do      if i &gt; 1 then         triggered = tsplink.trigger[2].wait(3)         if triggered == true then             channel.exclusiveclose(xptTable[i])             tsplink.trigger[1].assert()         else             print("Trigger not received")         end     else         channel.exclusiveclose(xptTable[i])         tsplink.trigger[1].assert()      end end  waitcomplete() node[2].smua.source.output = 0 channel.open("allslots") print("done")  end  endscript                 </pre>	<p>The "for" loop iterates through the channel list, waiting three seconds for a trigger on TSP-Link line 2 before closing a channel. The first channel of the list does not wait for a trigger. After channel closure is complete, an output trigger is asserted on TSP-Link line 1.</p> <p>After all switch and measure actions have completed, turn off the SMU output, open all crosspoints, and print "done"; the computer controller can query for "done" to determine when the test is complete.</p> <p>Ends the function "runDiodeTest."</p> <p>Ends the script "diodeTest."</p>
---	--

### Example program code to run the test

The example program code stores the program in the instrument for later use. To run the program, send the following commands to the Model 707B or 708B.

Example program code to run the test	
Code	Notes and comments
<pre> diodeTest() runDiodeTest()                 </pre>	<p>Run the script to define the functions.</p> <p>Execute the test by calling the function that configures the instruments and sequences their actions.</p>

To retrieve data from the System SourceMeter instrument through TSP-Link, use the `printbuffer()` command to print the data to the computer communication interface. An example is shown below.

Example: Retrieve buffer data	
Code	Notes and comments
<pre> printbuffer(1, node[2].smua.nvbuffer1.n,             node[2].smua.nvbuffer1.readings)                 </pre>	<p>Print all readings from the SMU data buffer. Note that "readings" is a buffer attribute.</p>

## Example 4: Using the scanning and triggering model

This example demonstrates how to use the scanning and triggering model of the Model 707B or 708B to maximize the speed of the test by preconfiguring the sequence of crosspoints used.

This example uses a TSP script to configure the instruments for testing. Once the instruments are configured, the Model 707B or 708B internally manages all close and open actions, as well as any triggering signals, to interface with the System SourceMeter instrument. No separate script is required to sequence these actions.

As with the previous examples, a full I-V sweep is performed on each of the six diodes. Data from these tests is available from the System SourceMeter instrument after all tests have been completed.

### Set up communication

In this example, in addition to the TSP-Link interface serving as a communication bus, it will also serve as triggering bus to enable hardware handshaking between the System SourceMeter instrument and Model 707B or 708B.

The communication setup is identical to the setup in Example 2; see [Set up communication](#) (on page 5-8).

There are three digital lines in the TSP-Link cable that may be used for triggering. This example uses trigger lines 1 and 2. The Model 707B or 708B outputs a trigger signal on TSP-Link line 1 and waits for a trigger signal on TSP-Link line 2 before proceeding with the next set of crosspoint closures. The System SourceMeter instrument outputs a trigger signal on TSP-Link line 2 after completing its test and waits for a trigger signal on TSP-Link line #1 before testing. The triggering setup is illustrated in the figure named "TSP-Link interface" in [Example 3: Configure using TSP-Link and interactive triggers](#) (on page 5-12).

### Example program code

In the following table, all commands are sent from the computer to the Model 707B or 708B. This example can be run using TSB Embedded. The Model 707B or 708B sends all commands in the shaded rows to the System SourceMeter instrument through the TSP-Link interface. Commands in unshaded rows are executed by the Model 707B or 708B.

Example program code for the Model 707B or 708B	
Code	Notes and comments
<pre> loadscript diodeTest  function configSwitch()      tsplink.reset()     localnode.reset()     errorqueue.clear()      matrixChannels = {}      matrixChannels[1] = "1A01, 1B02"     matrixChannels[2] = "1A03, 1B04"     matrixChannels[3] = "1A05, 1B06"     matrixChannels[4] = "1A07, 1B08"     matrixChannels[5] = "1A09, 1B10"     matrixChannels[6] = "1A11, 1B12"      for i = 1, 6 do         scan.addimagestep(matrixChannels[i])     end      tsplink.trigger[1].mode = tsplink.TRIG_FALLING     tsplink.trigger[2].mode = tsplink.TRIG_FALLING      tsplink.trigger[1].clear()     tsplink.trigger[2].clear()      scan.bypass = scan.ON      scan.trigger.arm.stimulus = 0     scan.trigger.channel.stimulus =         tsplink.trigger[2].EVENT_ID     tsplink.trigger[1].stimulus =         scan.trigger.EVENT_CHANNEL_READY     scan.scancount = 1  end </pre>	<p>Create a script "diodeTest" to contain test configuration and execution instructions.</p> <p>Create a function to configure the Model 707B or 708B.</p> <p>Reset TSP-Link. Reset Model 707B or 708B. Clear errors.</p> <p>Define table that details crosspoints to close to connect each diode to the SMU.</p> <p>Add entries to the table.</p> <p>Use the values in the table to create a scan list.</p> <p>Set TSP-Link lines 1 and 2 to send and receive falling-edge triggers.</p> <p>Clear any latched triggers on TSP-Link trigger lines 1 and 2.</p> <p>Configure the scanning and triggering mode of Model 707B or 708B. Bypass needed for trigger signal to start scan. Arm scan immediately. Trigger channel close action with receipt of trigger on TSP-Link line 2. Output trigger on TSP-link line 1 after channel close action occurs.</p> <p>Loop through scan list once.</p> <p>End of the configSwitch function.</p>
<pre> function configSMU() </pre>	<p>Create a function to configure the System SourceMeter instrument.</p>

<pre>node[2].reset()  node[2].errorqueue.clear()  node[2].smua.nvbuffer1.clear()</pre>	<p>Reset the instrument.</p> <p>Clear all errors and reset status bits.</p> <p>Clear existing data from data buffer.</p>
<pre>node[2].smua.source.func = node[2].smua.OUTPUT_DCAMPS  node[2].smua.source.rangei = 0.01</pre>	<p>Set source function to current source.</p> <p>Set source current range to 10 mA.</p>
<pre>node[2].smua.measure.rangev = 6  node[2].smua.measure.nplc = 1  node[2].smua.nvbuffer1.appendmode = 1</pre>	<p>Set voltage measurement range to 6 V</p> <p>Set integration rate.</p> <p>Enable buffer append mode.</p>
<pre>node[2].smua.trigger.source.limitv = 10  node[2].smua.trigger.source.linear(0, 0.01, 11)  node[2].smua.trigger.source.action = node[2].smua.ENABLE</pre>	<p>Set the voltage compliance during the sweep.</p> <p>Configure linear staircase sweep.</p> <p>Enable the source action during the sweep.</p>
<pre>node[2].smua.trigger.measure.v(node[2].smua.nvbuffer1)  node[2].smua.trigger.measure.action = node[2].smua.ENABLE</pre>	<p>Configure sweep voltage measurements.</p> <p>Enable voltage measurements during the sweep.</p>
<pre>node[2].smua.trigger.count = 11  node[2].smua.trigger.arm.count = 6</pre>	<p>Set trigger count to the number of steps in the sweep.</p> <p>Set arm count to six, the total number of sweeps that will be run for all diodes.</p>
<pre>node[2].tsplink.trigger[1].mode = node[2].tsplink.TRIG_FALLING node[2].tsplink.trigger[2].mode = node[2].tsplink.TRIG_FALLING</pre>	<p>Set TSP-Link trigger lines 1 and 2 to send and receive falling edge trigger signals.</p>
<pre>node[2].tsplink.trigger[1].clear() node[2].tsplink.trigger[2].clear()</pre>	<p>Clear any latched triggers on TSP-Link trigger lines 1 and 2.</p>
<pre>node[2].smua.trigger.arm.stimulus = node[2].tsplink.trigger[1].EVENT_ID</pre>	<p>Configure sweep to start when signal received on TSP-Link line 1.</p>
<pre>node[2].tsplink.trigger[2].stimulus = node[2].smua.trigger.SWEEP_COMPLETE_EVENT_ID</pre>	<p>Configure System SourceMeter to output trigger signal on TSP-Link line 2 when sweep is complete.</p>
<pre>end</pre>	<p>End of the function "Config SMU."</p>

<code>function runDiodeTest()</code>	This function sequences the crosspoint closures and triggering.
<code>configSwitch()</code>	Call function to configure the Model 707B or 708B.
<code>configSMU()</code> <code>node[2].smua.source.output = 1</code> <code>node[2].smua.trigger.initiate()</code>	Call function that configures the System SourceMeter instrument and turns on its output. Initiate the System SourceMeter so that it is ready to sweep once a trigger signal is received. Note that the output turns on but no power is applied.
<code>scan.execute()</code> <code>waitcomplete()</code>	Initiate the System Switch to start a foreground scan. Waits until Model 2635A finishes all measurements. Remote operation pauses until all six tests are complete. For other options on running a scan, see the box "Using background scans for longer scans."
<code>node[2].smua.source.output = 0</code> <code>channel.open("allslots")</code>	Turn off the SMU output. Open all crosspoints.
<code>end</code>	Ends the runDiodeTest function.
<code>endscript</code>	Ends the diodeTest script.

### Example program code to run the test

The example program code stores the program in the instrument for later use. To run the program, send the following commands to the Model 707B or 708B.

Example program code to run the test	
Code	Notes and comments
<code>diodeTest()</code> <code>runDiodeTest()</code>	Run the script to define the functions. Execute the test by calling the function that configures the instruments and sequences their actions.

To retrieve data from the System SourceMeter instrument through TSP-Link, use the `printbuffer()` command to print the data to the computer communication interface. An example is shown below.

Example: Retrieve buffer data	
Code	Notes and comments
<code>printbuffer(1, node[2].smua.nvbuffer1.n, node[2].smua.nvbuffer1.readings)</code>	Print all readings from the SMU data buffer. Note that "readings" is a buffer attribute.

## Using background scans for longer scan lists

Example 4 illustrates use of the scanning and triggering model to create a foreground scan.

While running a foreground scan, you must wait for the scan to complete or you must abort the scan before you can query the instrument state or any reading buffers. For a scan with a few channels or crosspoints in the scan list, this might not be a problem. However, when there are many channels in the scan list, or when scans are run over long time periods, it can be useful to determine instrument state. In these situations, you can run a background scan. A background scan allows you to query settings during a scan.

To change Example 4 from a foreground scan to a background scan, you need to change one command in the "runDiodeTest" function. Change `scan.execute()` to `scan.background()`. You can then use the `scan.state()` command to query the status of the scan, including the number of steps in the scan, the number of steps performed, and the number of entire scans performed.

The following table shows a revised example of the `runDiodeTest` function in Example 4.

<code>function runDiodeTest()</code>	This function sequences the crosspoint closures and triggering.
<code>configSwitch()</code>	Call function to configure the Model 707B or 708B.
<code>configSMU()</code> <code>node[2].smua.source.output = 1</code>  <code>node[2].smua.trigger.initiate()</code>  <code>scan.background()</code>  <code>delay(2)</code> <code>scanState, scanCount, stepCount = scan.state()</code>  <code>print(scanState, " ", scanCount, " ", stepCount, "</code> <code> ")</code>  <code>while scanState ~=6 do</code> <code>  delay(1)</code> <code>end</code>	Call function that configures the System SourceMeter instrument and turns on its output. Initiate the System SourceMeter so that it is ready to sweep once a trigger signal is received. Note that the output turns on but no power is applied. Initiate the System Switch to start a background scan. Delay 2 seconds to allow the scan to start. Use variables to hold the scan state response. Print the response to scan state, which you can use to determine when the scan is complete. Query the scan state every second to determine when the scan completes. When the scan is complete ( <code>scan state = 6</code> ), exit the loop.
<code>node[2].smua.source.output = 0</code> <code>channel.open("allslots")</code>	Turn off the SMU output. Open all crosspoints.
<code>end</code>	Ends the <code>runDiodeTest</code> function.





---

# Working with the Series 2400

### In this section:

---

About the Series 2400 examples .....	6-1
Equipment required to run the examples .....	6-1
Connect the equipment .....	6-1
Logical block diagram of test connections .....	6-2
Example 1: Individual commands for switch-measure	6-3
Example 2: Digital I/O triggering for switch-measure synchronization .....	6-5

## About the Series 2400 examples

This section provides examples that demonstrate the basic interaction of the Model 707B or 708B with a Model 2400 SourceMeter Instrument. One of the examples also shows how to use digital I/O triggering to synchronize source and measure actions between the Model 707B or 708B and the SourceMeter instrument.

The concepts in these examples can be applied when using the Model 707B or 708B with other SCPI-based instruments. TSB Embedded cannot be used to program the Model 2400 SourceMeter Instrument; it cannot be used for these examples.

## Equipment required to run the examples

To run this test, you will need the following equipment:

- Six diodes with triaxial connections
- One Model 707B or 708B
- One switch matrix card (Model 7174A, 7072, or 7072-HV). You can also use the Model 7173-50 if you convert the connection to coaxial instead of triaxial
- One Model 2400 SourceMeter instrument or equivalent source measurement unit (SMU)
- Example 2 only: One Model 2600-TLINK trigger link to digital I/O cable assembly
- Two Model 237-BAN-3A banana jack to triaxial cable assemblies

## Connect the equipment

To run the test, make the connections as shown in the figure below. Note that all triax connections for the SourceMeter Instrument and the diodes are made to the center conductor (pin) of the triaxial connector.

## NOTE

This drawing shows connections to the Model 7072 8x12 Switch Card. However, you can make similar connections to the other switch cards listed for this example.

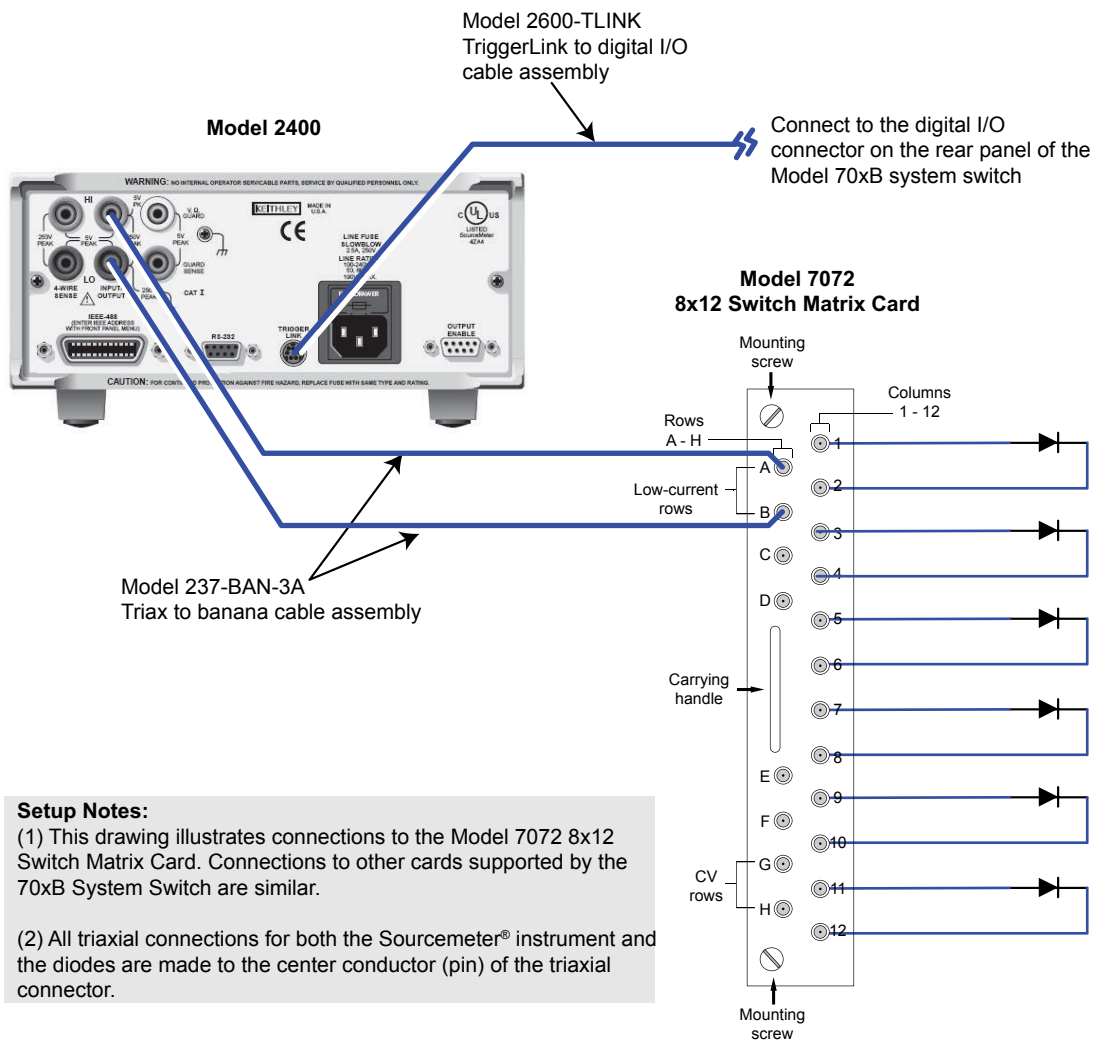

**Setup Notes:**

(1) This drawing illustrates connections to the Model 7072 8x12 Switch Matrix Card. Connections to other cards supported by the 70xB System Switch are similar.

(2) All triaxial connections for both the Sourcemeter® instrument and the diodes are made to the center conductor (pin) of the triaxial connector.

## Logical block diagram of test connections

The following figure shows the logical block diagram of the test connections.

**Figure 32: Test system block diagram**

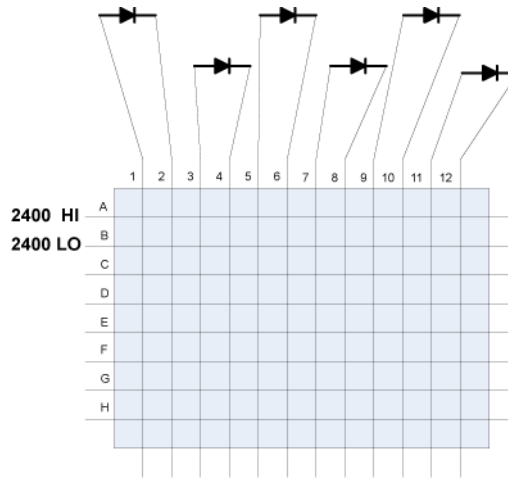

### Example 1: Individual commands for switch-measure

In this example, individual commands are sent to the Model 707B or 708B and SourceMeter Instrument to perform switch closure and measure actions.

### Example program code for the Model 2400

**NOTE**

TSB and TSB Embedded cannot be used to control the Model 2400 SourceMeter instrument. You are expected to send commands to the Model 2400 using a separate application development environment, such as Microsoft® Visual Studio® or National Instruments LabVIEW™.

Send the following commands to configure the Model 2400 SourceMeter Instrument.

**Example program code for the Model 2400 SourceMeter Instrument**

Code	Notes and comments
*RST	Reset the instrument.
*CLS	Clear all errors and reset status bits.
:FORM:ELEM VOLT, CURR	Format return data string to return current and voltage values.
:SOUR:FUNC CURR"	Configure current source to perform a linear sweep from 0 to 10 mA in 1 mA steps.
:SOUR:CURR:MODE SWE	
:SOUR:CURR:STAR 0	
:SOUR:CURR:STOP 10E-3	
:SOUR:CURR:STEP 1e-3	
:SOUR:SWE:SPAC LIN	
:SENS:VOLT:PROT 10	Configure voltage limit.
:SENS:FUNC 'VOLT'	Configure SMU to measure voltage.
:SENS:VOLT:RANG 5	Set a fixed voltage range of 5 V.
:SENS:VOLT:NPLC 1	Set integration rate to 1 PLC.
:ARM:COUN 1	Complete each sweep once.
:TRIG:COUN 11	Number of steps in sweep = 11.

**Example program code for the Model 707B or 708B**

Send the following commands to configure the Model 707B or 708B.

**Example program code for the Model 707B or 708B**

Code	Notes and comments
reset	Reset the instrument to factory defaults.
errorqueue.clear()	Clear all errors.

To run the test, send the following commands to the corresponding instrument.

**NOTE**

After each :READ? query to the Model 2400, you must retrieve the instrument's response. If you do not retrieve the response, the Model 2400 generates an error.

**Example program code to run the test**

Model	Code	Notes and comments
2400	:OUTP:STAT ON	Turn on the output of the SourceMeter instrument.
707B or 708B	channel.exclusiveclose("1A01,1B02")	Connect first diode.
2400	:READ?	Initiate sweep and return data.
707B or 708B	channel.exclusiveclose("1A03,1B04")	Connect second diode.
2400	:READ?	Initiate sweep and return data.
707B or 708B	channel.exclusiveclose("1A05,1B06")	Connect third diode.
2400	:READ?	Initiate sweep and return data.
707B or 708B	channel.exclusiveclose("1A07,1B08")	Connect fourth diode.
2400	:READ?	Initiate sweep and return data.
707B or 708B	channel.exclusiveclose("1A09,1B10")	Connect fifth diode.
2400	:READ?	Initiate sweep and return data.
707B or 708B	channel.exclusiveclose("1A11,1B12")	Connect sixth diode.
2400	:READ?	Initiate sweep and return data.
2400	:OUTP:STAT OFF	Turn off the output of the SourceMeter instrument.
707B or 708B	channel.open("allslots")	Open all crosspoints.

## Example 2: Digital I/O triggering for switch-measure synchronization

In this example, you will configure both the Model 707B or 708B and the SourceMeter instrument to wait for and send digital trigger signals after each performs the requested switch closure or measure action.

### Example program code for the Model 2400

**NOTE**

TSB and TSB Embedded cannot be used to control the Model 2400 SourceMeter. You are expected to send commands to the Model 2400 using a separate application development environment, such as Microsoft Visual Studio or National Instruments' Labview.

Send the following commands to configure the Model 2400 SourceMeter Instrument.

**Example program code for the Model 2400 SourceMeter Instrument**

Code	Notes and comments
*RST	Reset the instrument.
*CLS	Clear all errors and reset status bits.
:FORM:ELEM VOLT, CURR	Format return data string to return current and voltage values.
:SOUR:FUNC CURR	Configure current source to perform a linear sweep from 0 to 10 mA in 1 mA steps.
:SOUR:CURR:MODE SWE	
:SOUR:CURR:STAR 0	
:SOUR:CURR:STOP 10E-3	
:SOUR:CURR:STEP 1e-3	
:SOUR:SWE:SPAC LIN	
:SENS:VOLT:PROT 10	Configure voltage limit.
:SENS:FUNC 'VOLT'	Configure the SMU to measure voltage.
:SENS:VOLT:RANG 5	Set a fixed voltage range of 5 V.
:SENS:VOLT:NPLC 1	Set integration rate to 1 PLC.
:ARM:DIR ACC	Configure the SMU to trigger entire sweep on receipt of hardware trigger on the TriggerLink connector.
:ARM:SOUR TLINK	
:ARM:ILIN 1	
:ARM:OLIN 2	
:ARM:OUTP TEXIT	Configure the counts of the trigger model so that the 11-point sweep is performed six times (once for each diode).
:TRIG:DIR ACC	
:TRIG:SOUR IMM	
:TRIG:COUN 11	
:ARM:COUN 6	
:TRAC:POIN 66	Configure the nonvolatile data buffer of the SMU to store all 66 sets of readings generated for sweeps across all diodes.
:TRAC:FEED SENS	
:TRAC:FEED:CONT NEXT	

**Example program code for the Model 707B or 708B**

The following code loads a script on the 70xB that contains two functions that:

- Set up the table of crosspoints to close
- Execute the test

**Example program code for the Model 707B or 708B**

Code	Notes and comments
<pre>loadscript forScan  function setup70xChanList()      reset()     errorqueue.clear()      chanTable = {}     chanTable[1] = "1A01,1B02"     chanTable[2] = "1A03,1B05"     chanTable[3] = "1A05,1B06"     chanTable[4] = "1A07,1B08"     chanTable[5] = "1A09,1B10"     chanTable[6] = "1A11,1B12"      digio.trigger[1].mode = digio.TRIG_FALLING     digio.trigger[2].mode = digio.TRIG_FALLING      digio.trigger[1].clear()     digio.trigger[2].clear()      return chanTable  end</pre>	<p>This script creates two functions on the Model 707B or 708B to configure and run the test. This script should be stored in the Model 707B or 708B.</p> <p>Remember that <code>loadscript</code> and <code>endscript</code> commands are not necessary if this script is created in the instrument using TSB or TSB Embedded.</p> <p>Create a function that sets up the Model 707B or 708B and the list of channels to be used in the test.</p> <p>Reset the instrument and clear errors.</p> <p>Define and populate a table that holds the crosspoints to be used to connect the SMU to the diodes under test (also see notes below this example).</p> <p>Configure the digital I/O trigger lines to respond to and generate falling edge triggers.</p> <p>Clear any latched triggers.</p> <p>Return the table as an output of the function</p>



<pre>function run70xForScan(cTable)      for i = 1, table.getn(cTable) do         if i &gt; 1 then             triggered = digio.trigger[2].wait(3)             if triggered == true then                 channel.exclusiveclose(cTable[i])                 waitcomplete()                 digio.trigger[1].assert()             else                 print("Trigger not received")             end         else             channel.exclusiveclose(cTable[i])             waitcomplete()             digio.trigger[1].assert()         end     end     print("done") end  endscript  forScan()  crossptTable = setup70xChanList()</pre>	<p>This function sequences the crosspoint closures and hardware triggering. A table of crosspoints to close must be input to this function.</p> <p>The <code>for</code> loop iterates through the channel list and waits for a trigger on a digital I/O line to occur before closing a channel.</p> <p>The first channel of the list does not wait for a trigger.</p> <p>After channel closure is complete, an output trigger is asserted on digital I/O line.</p> <p>Run the script to generate the functions.</p> <p>Call the function that sets up the Model 707B or 708B and store the output of the function in the variable <code>crossptTable</code>.</p>
--	--

### Alternate method for creating a list of crosspoints

The following code creates a list of crosspoints that can be used in a test. This code replaces `chanTable` in the example code above.

```
x = 1
--The following nested for loop creates channel list for the scan.  --This list is
  compiled in the table "jscTable"
for i = 1,11,2 do
    j = i + 1
    chan1 = channel.createspecifier(1,1,i)
    chan2 = channel.createspecifier(1,2,j)
    chanTable[x] = chan1 .. "," .. chan2
    --Crosspoints are printed to show output of example
    print(chanTable[x])
x = x+1
end
```

Output:

```
1A01,1B02
1A03,1B05
1A05,1B06
1A07,1B08
1A09,1B10
1A11,1B12
```

## Overview of running the test

The Model 707B or 708B closes the crosspoints necessary to connect the SourceMeter to each diode under test one-at-a-time. The SourceMeter then performs an I-V sweep on each diode. This process continues until all six diodes are tested.

## Example code to run the test

To run the test, send the following commands to the corresponding instrument.

Example program code to run the test		
Model	Code	Notes and comments
2400	:OUTP ON	Turn on the output of the SourceMeter Instrument.
2400	:INIT	Initiate the sweep. After processing this command, the Model 2400 waits for a trigger from the Model 707B or 708B.
707B or 708B	run70xForScan(crossptTable)	Call the function that executes the sequence of crosspoints and generates hardware trigger signals to trigger sweeps on the SMU.
2400	:TRAC:DATA?	After the test is complete, send this command to retrieve the data from the Model 2400. Retrieve the data from the Model 2400 after sending :TRAC:DATA?.



---

# Troubleshooting FAQs

### **In this section:**

---

About this section .....	7-1
Need different line frequency or voltage.....	7-1
Model 4200-SCS does not recognize switch matrix ...	7-1
"A" model software does not run on "B" models.....	7-3
Matrix Ready and External Trigger lines .....	7-3
Switch matrix does not recognize my card .....	7-3
Instrument's internal web page is not accessible .....	7-4
Error when I try to close a channel.....	7-5
Switch relays will not close.....	7-5
Save the present state of the instrument.....	7-5
LabVIEW driver for the Model 707B or 708B .....	7-6

## **About this section**

The intent of this section is to troubleshoot the most common problems encountered with the Models 707B and 708B. For additional troubleshooting information, please see the "Troubleshooting" section in the Models 707B and 708B Reference Manual.

## **Need different line frequency or voltage**

**I need to use 707B or 708B at a different line frequency or voltage. What do I need to do?**

The Model 707B or 708B only supports a line frequency of 50/60 Hz. The line frequency is automatically sensed and no user action is needed.

## **Model 4200-SCS does not recognize switch matrix**

**The Model 4200-SCS does not recognize the Model 707B or 708B. What do I do?**

To work with the Model 4200-SCS, you must have DDC compatibility mode enabled and must communicate through the GPIB.

You can select one of two options when enabling Model 707A or 708A DDC compatibility mode:

- **70xA-VERSION:** This option most closely matches Model 707A or 708A operation. Use this version if you are transferring applications directly from a Model 707A or 708A with few changes.
- **70xB-VERSION:** This options provides enhanced operation, including error checking and more robust settling time operation. Use this version if you are updating existing applications.

***To enable Model 707A or 708A DDC compatibility mode:***

1. From the front panel, select **MENU**.
2. Select **DDC**.
3. Select **ENABLE**.
4. Select the version.
5. Press **ENTER**.
6. Cycle instrument power.

***To enable GPIB communications:***

1. From the front panel, select **MENU**.
2. Select **GPIB**.
3. Select **ENABLE**.
4. Select **ON**.
5. Cycle power to the instrument.

If DDC compatibility mode is selected and GPIB is enabled, also verify that:

- The GPIB cable is connected to the instrument.
- The instrument has a unique GPIB address.

## "A" model software does not run on "B" models

**Software that I used with my Model 707A or 708A does not run on the Model 707B or 708B. What do I do?**

Verify that DDC compatibility mode is enabled.

You can select one of two options when enabling Model 707A or 708A DDC compatibility mode:

- **70xA-VERSION:** This option most closely matches Model 707A or 708A operation. Use this version if you are transferring applications directly from a Model 707A or 708A with few changes.
- **70xB-VERSION:** This options provides enhanced operation, including error checking and more robust settling time operation. Use this version if you are updating existing applications.

**To enable Model 707A or 708A DDC compatibility mode:**

1. From the front panel, select **MENU**.
2. Select **DDC**.
3. Select **ENABLE**.
4. Select the version.
5. Press **ENTER**.

Cycle instrument power.

Review "Using Model 707A and 708A compatibility mode" in the Models 707B and 708B Reference Manual for additional information. Also see "Migrating from Models 707A and 708A."

## Matrix Ready and External Trigger lines

**Does this model have Matrix Ready and External Trigger lines?**

Yes, these signals appear on the digital I/O connector. For information on the digital I/O capabilities, refer to "Controlling digital I/O lines" in the Model 707B or 708B Reference Manual. If you wish to use a Model 707B or 708B in an existing Model 707A or 708A application, please refer to "Using Model 707A or 708A compatibility mode" in the Model 707B or 708B Reference Manual.

## Switch matrix does not recognize my card

**The Model 707B or 708B does not recognize my switch card. What do I do?**

***Card is not correctly seated in the slot***

Check the seating of the card:

1. Remove power from the instrument.
2. Pull the card out of the slot.
3. Carefully guide the card inside the rails while re-installing.
4. Make sure the outer shield is not inserted into the card rails.
5. Make sure that no other portions of the card catch on any part of the instrument frame while installing.
6. Make sure the card is fully seated before restarting the instrument.

***Edge connector is dirty***

If the card was stored outside of the instrument, it is possible that the edge connector has gotten dirty.

1. Check the edge connector. The gold edge connector fingers should have a bright surface when properly cleaned.
2. If necessary, clean the edge connector.
3. Re-install the card.

***Confirm that the card is supported in the Model 707B or 708B***

See the Models 707B and 708B specifications.

## Instrument's internal web page is not accessible

**I cannot access the instrument's internal web page. How do I fix this?**

Ensure that the instrument has a valid and unique IP address assigned.

- To view the IP address of the Models 707B and 708B, press **MENU**. Select **LAN > STATUS > IP-ADDRESS**. If a valid IP address is displayed, the instrument configuration is correct. If 0.0.0.0 is displayed, the IP address is not valid.
- If you are using the automatic configuration method over a corporate network, contact your network administrator for assistance.
- If you are using the automatic configuration method and you have a one-to-one connection between the instrument and the computer, verify that the computer is set to receive an IP address automatically. When the computer and the Model 707B or 708B synchronize, the green LED status light on the front panel of the instrument lights.
- If you are using the manual configuration method over a corporate network, verify that you have entered the IP address, gateway and subnet mask provided by your network administrator.
- If you are using the manual configuration method and a one-to-one connection with the computer, verify that the subnet mask agrees with the computer's settings.
- If the above suggestion do not work, see Models 707B and 708B Reference Manual, "Communication interfaces."

## Error when I try to close a channel

### The instrument generates an error when I try to close a channel. What do I do?

If the instrument generates "Error 1115: Parameter error no forbidden channels accepted," make sure that the channel specifier is valid. For more information on channel specifiers, see [Channel identifiers](#) (on page 2-7).

If the specifier is correct, the channel's forbidden attribute may be set to true. To close the specified channel, the forbidden attribute must be set to false.

#### **To set the forbidden attribute to false using the front panel:**

1. Press **CONFIG** then **CHAN**.
2. Select FORBID.
3. Select NO.

#### **To set the forbidden attribute to false using the web interface:**

1. On the Cards page, right-click the channel.
2. Clear the Forbidden box.
3. Click **OK**.

#### **To set the forbidden attribute to false using remote commands:**

Use the command:

```
channel.setforbidden()
```

## Switch relays will not close

### Why are the switch relays not closing?

Verify that the system power is sufficient to close the switch relays.

Check the front panel or script output for error that might have been returned from the operation.

## Save the present state of the instrument

### How do I save the present state of the instrument?

Use the Create Config Script option (or the command createconfigscript). See the Models 707B and 708B Reference Manual, "Save the present configuration."



## **LabVIEW driver for the Model 707B or 708B**

**Where do I find the LabVIEW driver for the Model 707B or 708B?**

### **Next steps**

This manual has prepared you to start using your new Model 707B or 708B for your real-world applications. For more detailed information about the Model 707B or 708B, refer to the Keithley Instruments Models 707B and 708B Reference Manual, part number 707B-901-01.

If you are migrating from a Keithley Model 707A or 708A, and wish to use the native commands for the Model 707B or 708B, please refer to the "Migrating from Models 707A and 708A" topic in the "Features and Functions" section of the Model 707B or 708B Reference Manual. If you would like to use existing software that ran with the Model 707A or 708A without modification, please refer to "Using Model 707A or 708A Compatibility Mode" in the Model 707B or 708B Reference Manual.



---

# Index

## 2

2400 • 6-1

2600 • 5-1

## 4

4200 • 4-1

## 7

707B-708B Quick Start Guide • 1-2

## A

applications • 1-1

## C

CD\_-ROM • 1-2

channel

designations • 2-6

patterns • 2-11

channel patterns • 2-11

configuration

CONFIG key • 2-4

crosspoint • 2-9

## D

Display

DISPLAY key • 2-4

Model 707B front panel • 2-2

Model 708B front panel • 2-2

documentation • 1-2

## F

front panel

display • 2-4, 2-5, 2-9

interface • 2-1

introduction • 2-1

keys • 2-3, 2-4

Model 707B front panel • 2-2

Model 708B front panel • 2-2

## H

hot switching • 1-1

## I

I/O layer • 1-2

IVI drivers • 1-2

## J

J2SE Runtime Environment • 1-2

## K

keys

DISPLAY • 2-4

## L

LabVIEW drivers • 1-2

## M

matrix card notation • 2-7

**N**

navigation wheel • 2-3

**P**

POWER switch • 2-3

precautions • 1-1

**S**

safety precautions • 1-1

**T**

Test Script Builder • 1-2

# Warranty

---

Keithley Instruments, Inc. warrants this product to be free from defects in material and workmanship for a period of one (1) year from date of shipment.

Keithley Instruments, Inc. warrants the following items for 90 days from the date of shipment: probes, cables, software, rechargeable batteries, diskettes, and documentation.

During the warranty period, Keithley Instruments will, at its option, either repair or replace any product that proves to be defective.

To exercise this warranty, write or call your local Keithley Instruments representative, or contact Keithley Instruments headquarters in Cleveland, Ohio. You will be given prompt assistance and return instructions. Send the product, transportation prepaid, to the indicated service facility. Repairs will be made and the product returned, transportation prepaid. Repaired or replaced products are warranted for the balance of the original warranty period, or at least 90 days.

## Limitation of Warranty

This warranty does not apply to defects resulting from product modification without Keithley Instruments' express written consent, or misuse of any product or part. This warranty also does not apply to fuses, software, non-rechargeable batteries, damage from battery leakage, or problems arising from normal wear or failure to follow instructions.

THIS WARRANTY IS IN LIEU OF ALL OTHER WARRANTIES, EXPRESSED OR IMPLIED, INCLUDING ANY IMPLIED WARRANTY OF MERCHANTABILITY OR FITNESS FOR A PARTICULAR USE. THE REMEDIES PROVIDED HEREIN ARE BUYER'S SOLE AND EXCLUSIVE REMEDIES.

NEITHER KEITHLEY INSTRUMENTS, INC. NOR ANY OF ITS EMPLOYEES SHALL BE LIABLE FOR ANY DIRECT, INDIRECT, SPECIAL, INCIDENTAL, OR CONSEQUENTIAL DAMAGES ARISING OUT OF THE USE OF ITS INSTRUMENTS AND SOFTWARE, EVEN IF KEITHLEY INSTRUMENTS, INC. HAS BEEN ADVISED IN ADVANCE OF THE POSSIBILITY OF SUCH DAMAGES. SUCH EXCLUDED DAMAGES SHALL INCLUDE, BUT ARE NOT LIMITED TO: COST OF REMOVAL AND INSTALLATION, LOSSES SUSTAINED AS THE RESULT OF INJURY TO ANY PERSON, OR DAMAGE TO PROPERTY.

**KEITHLEY**

A GREATER MEASURE OF CONFIDENCE

Specifications are subject to change without notice.  
All Keithley trademarks and trade names are the property of Keithley Instruments, Inc.  
All other trademarks and trade names are the property of their respective companies.

---

**KEITHLEY**

A G R E A T E R M E A S U R E O F C O N F I D E N C E