

**FLUKE**®

# 709/709H

Precision Loop Calibrator

Test Equipment Depot - 800.517.8431 - 99 Washington Street Melrose, MA 02176 - [TestEquipmentDepot.com](http://TestEquipmentDepot.com)

## Users Manual

January 2013

© 2013 Fluke Corporation. All rights reserved. Specifications are subject to change without notice.

All product names are trademarks of their respective companies.

## **LIMITED WARRANTY AND LIMITATION OF LIABILITY**

This Fluke product will be free from defects in material and workmanship for three years from the date of purchase. This warranty does not cover fuses, disposable batteries, or damage from accident, neglect, misuse, alteration, contamination, or abnormal conditions of operation or handling. Resellers are not authorized to extend any other warranty on Fluke's behalf. To obtain service during the warranty period, contact your nearest Fluke authorized service center to obtain return authorization information, then send the product to that Service Center with a description of the problem.

THIS WARRANTY IS YOUR ONLY REMEDY. NO OTHER WARRANTIES, SUCH AS FITNESS FOR A PARTICULAR PURPOSE, ARE EXPRESSED OR IMPLIED. FLUKE IS NOT LIABLE FOR ANY SPECIAL, INDIRECT, INCIDENTAL OR CONSEQUENTIAL DAMAGES OR LOSSES, ARISING FROM ANY CAUSE OR THEORY. Since some states or countries do not allow the exclusion or limitation of an implied warranty or of incidental or consequential damages, this limitation of liability may not apply to you.

# Table of Contents

Title	Page
Introduction .....	1
How to Contact Fluke .....	2
Safety Information .....	3
Symbols .....	4
Standard Equipment.....	6
The Product.....	8
The Buttons .....	8
The Selection Knob .....	9
Main Menu .....	9
mA Source.....	10
mA Simulate .....	12
mA Measure .....	13
mA Measure with 24V .....	14
Volts Measure .....	15
Calibrator Setup Menu .....	16

Auto Ramp Time .....	17
Auto Step Time .....	17
Step and Ramp Operation .....	18
Automatic Step and Ramp .....	18
Valve Test.....	19
HART 250Ω Resistor .....	20
mA Span .....	20
Contrast .....	21
Auto Shutdown Time.....	21
HART Write Enable.....	22
HART Device Communication .....	23
HART Connections .....	23
In Circuit, External Loop Power .....	24
In Circuit, Product Loop Power.....	25
Across Circuit, Communicator Only .....	26
Communications Setup and Selection .....	27
Mode .....	28
250Ω Resistor .....	28
HART Connect.....	29
Polling Loop .....	29
Tag Selection .....	30
Acquiring Data.....	30
Disconnect from Loop .....	31
Function Select Menu .....	31
Device Setup and Data .....	32
Write LRV and URV Values.....	33
Write LRV .....	33
Write URV.....	34
Trim, Set, and Zero Menu.....	34

Trim 4 mA .....	35
Trim 20 mA .....	36
Set Fixed mA Output .....	37
PV Zero .....	38
Device Diagnostic.....	39
Configuration Log and Data Log.....	40
Configuration Log .....	40
Data Log .....	42
Maintenance.....	44
Clean the Product.....	45
Fuse .....	45
Battery Replacement.....	46
User-Replaceable Parts .....	47
Specifications .....	49



# ***List of Tables***

<b>Table</b>	<b>Title</b>	<b>Page</b>
1.	Symbols.....	4
2.	Standard Equipment.....	6
3.	Buttons .....	8
4.	User-Replaceable Parts .....	47





# List of Figures

<b>Figure</b>	<b>Title</b>	<b>Page</b>
1.	Standard Equipment.....	7
2.	Buttons .....	8
3.	Main Menu.....	9
4.	mA Source Connections.....	11
5.	mA Simulate Connections .....	12
6.	mA Measure Connections .....	13
7.	mA Measure with 24 V Connections .....	14
8.	Volts Measure Connections.....	15
9.	Setup Menu, Screen 1.....	16
10.	Setup Menu, Screen 2.....	16
11.	Auto Ramp Time Screen .....	17
12.	Auto Ramp Step Time Screen.....	17
13.	Valve Test Enable Screen.....	19
14.	HART Resistor Enable Screen .....	20
15.	mA Span Selection Screen.....	20

16.	Contrast Adjustment Screen .....	21
17.	Auto Shutdown Screen .....	21
18.	Hart Write Enable Screen .....	22
19.	Password Screen.....	22
20.	In Circuit, External Loop Power Connections.....	24
21.	In Circuit, 709H Loop Power .....	25
22.	Across Circuit, Communicator Only Connections .....	26
23.	HART Comm. Menu Screen .....	27
24.	Mode Selection Screen.....	28
25.	250 $\Omega$ Resistor Screen.....	28
26.	Polling Screen.....	29
27.	Tag Selection Screen.....	30
28.	Acquiring Data Screen .....	30
29.	Disconnect from Loop Screen.....	31
30.	Function Select Menu .....	31
31.	Sample Screen .....	32
32.	Write LRV and URV Screen.....	33
33.	Write LRV Screen .....	33
34.	Write URV Screen .....	34
35.	Trim, Set, and Zero Screen.....	34
36.	Trim 4 mA Screen .....	35
37.	Trim 20 mA Screen .....	36
38.	Set Fixed mA Output Screen .....	37
39.	PV Zero Screen .....	38
40.	Self Test Screen .....	39
41.	Self Test Results Screen .....	39
42.	Data Log and Configuration Log Screen.....	40
43.	Configuration Log Screen .....	40
44.	Configuration Log Showing Storage Position.....	41

45.	Data Log Screen .....	42
46.	Logging Interval Screen .....	43
47.	Active Logging Screen .....	43
48.	Battery Replacement.....	46



## ***Introduction***

The Fluke 709 Precision Loop Calibrator and 709H Precision HART Loop Calibrator (the Product or the Calibrator) can be used for installation, calibration, and troubleshooting of field transmitters, valves, and other control system components at process plants. Primary functions are source and measure mA signals in the 0 mA to 24 mA range. The Product can also produce 24 V dc loop power.

The 709H includes HART communication functionality and supports a select set of HART universal and common-practice commands. The Product can be used as a loop calibrator or basic function communicator.

Product functions include:

- Current measurement, sourcing, and a selectable 24 V supply
- 30 V dc measurement
- Valve test capability
- A selectable HART 250  $\Omega$  loop resistor
- Output step and ramp

Product features include:

- Large backlit display
- Digital selection knob with selectable decade control for easy data entry
- Interactive menus
- Communicator mode reads basic device information, does diagnostic tests, and can be used to trim the calibration of most HART-enabled transmitters.

*Note*

*All figures in this Manual show the 709H.*

## Safety Information

A **Warning** identifies conditions and procedures that are dangerous to the user. A **Caution** identifies conditions and procedures that can cause damage to the Product or the equipment under test.

### Warning











To prevent possible electrical shock, fire, or personal injury:

- Read all safety Information before you use the Product.
- Use the Product only as specified, or the protection supplied by the Product can be compromised.
- Examine the case before you use the Product. Look for cracks or missing plastic. Carefully look at the insulation around the terminals.
- Do not use test leads if they are damaged. Examine the test leads for damaged insulation and measure a known voltage.
- Do not use and disable the Product if it is damaged.
- Do not use the Product around explosive gas, vapor, or in damp or wet environments.
- Do not touch voltages >30 V ac rms, 42 V ac peak, or 60 V dc.
- Do not apply more than the rated voltage, between the terminals or between each terminal and earth ground.
- Do not connect directly to mains.
- Do not exceed the Measurement Category (CAT) rating of the lowest rated individual component of a Product, probe, or accessory.
- Keep fingers behind the finger guards on the probes.
- Remove all probes, test leads, and accessories before the battery door is opened.
- Remove the batteries if the Product is not used for an extended period of time, or if stored in temperatures above 50 °C. If the batteries are not removed, battery leakage can damage the Product.
- Replace the batteries when the low battery indicator shows to prevent incorrect measurements.
- The battery door must be closed and locked before you operate the Product.

## Symbols



Symbols used on the Product and in this manual are explained in Table 1.

**Table 1. Symbols**

Symbol	Meaning	Symbol	Meaning
	Earth ground		Conforms to relevant North American Safety Standards.
	AC- alternating current		Conforms to European Union directives.
	DC- direct current		Conforms to relevant Australian standards.
	Risk of danger. Important information. See manual.		This product complies with the WEEE Directive (2002/96/EC) marking requirements. The affixed label indicates that you must not discard this electrical/electronic product in domestic household waste. Product Category: With reference to the equipment types in the WEEE Directive Annex I, this product is classed as category 9 "Monitoring and Control Instrumentation" product. Do not dispose of this product as unsorted municipal waste. Go to Fluke's website for recycling information.
	Hazardous voltage. Risk of electrical shock.		Examined and licensed by TÜV Product Services.



**Table 1. Symbols (cont.)**

	Battery.		Double insulated
CAT II	Measurement Category II is applicable to test and measuring circuits connected directly to utilization points of low voltage mains installation.	CAT III	Measurement Category III is applicable to test and measuring circuits connected to the distribution part of the building's low-voltage MAINS installation.
CAT IV	Measurement Category IV is applicable to test and measuring circuits connected at the source of the building's low-voltage MAINS installation.		
The CAT ratings apply to the handheld accessories only. The Product is rated to 30 V maximum.			

## **Standard Equipment**

Items included with the Product are listed in Table 2 and shown in Figure 1.

**Table 2. Standard Equipment**

<b>Item</b>	<b>Description</b>
①	Two AC72-1 alligator clips (709)
②	TL-75-4201 test leads (709)
③	754-8016 alligator clip set (709H)
④	75X-8014 stackable lead set (709H)
⑤	TP220-4201 test probes (709H)
⑥	AC280-5001 Suregrip hook clips (709H)
⑦	Soft Case
Not Shown	Six AAA batteries (installed)
	<i>709/709H Product Manual CD-ROM</i>
	<i>709/709H Quick Reference Guide</i>
	<i>709/709H Safety Information</i>

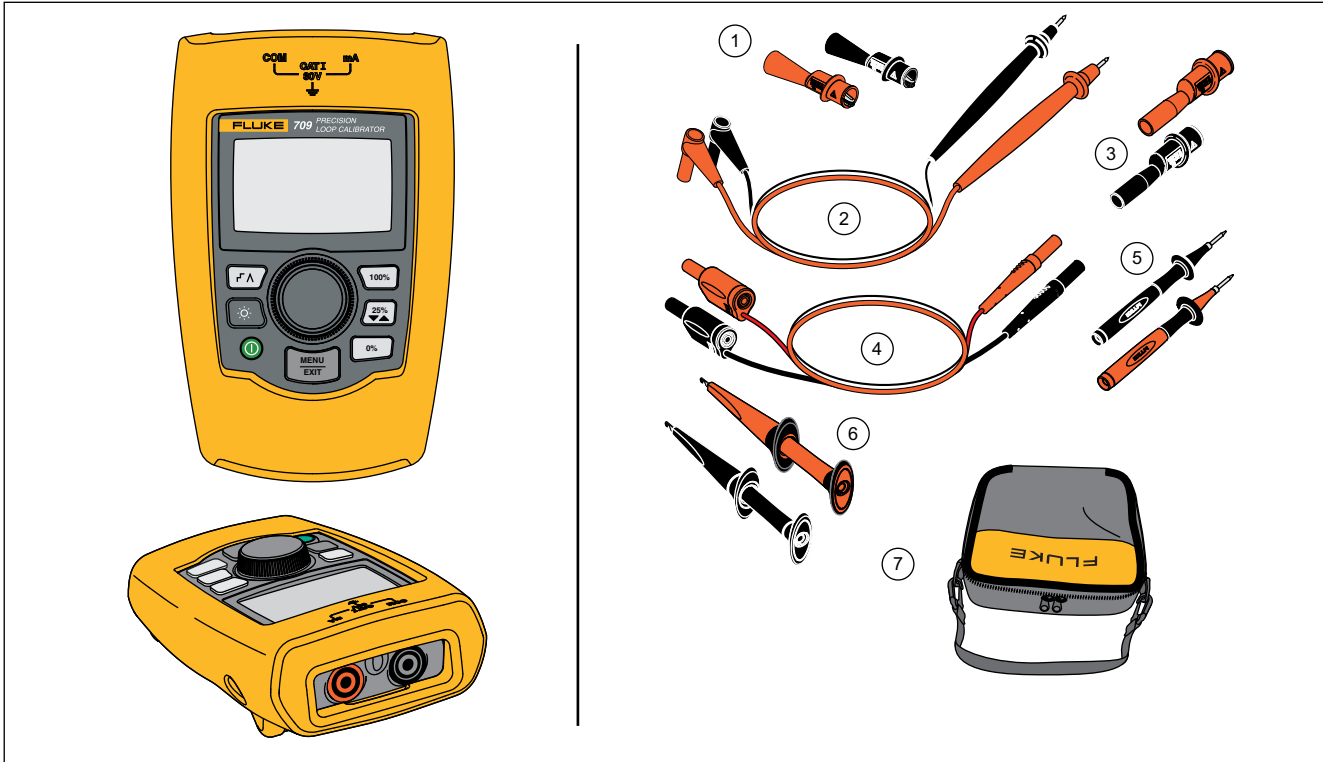

Figure 1. Standard Equipment

gzx002.eps

## The Product

The subsequent sections are about the features and functions of the Product.

### The Buttons

Figure 2 and Table 3 show the location and brief descriptions of the Product buttons.

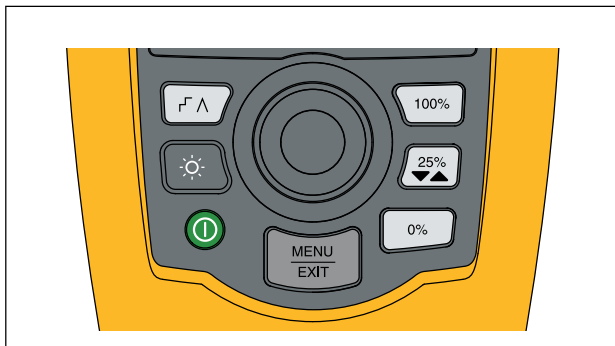

gzx001.eps

Figure 2. Buttons





Table 3. Buttons

Button	Function
	Push to enable step or ramp.
	Push to turn on or turn off the backlight.
	Push to turn on and turn off the Product.
	Push to set the output to 20 mA when in mA Source or mA Simulate modes. In Measurement mode the button does not set the output current.
	Push to step the output up or down by 25 % increments (4, 8, 12, 16, 20 mA).
	Push to set the output to 4 mA when in mA Source or mA Simulate mode. In Measurement mode the button does not set the output current
	Push to enter the Main menu. Push a second time to exit the Main menu. See the “Main Menu” section.

## The Selection Knob

The selection knob lets you select and control necessary functions and navigate through the Product menus. Turn the selection knob to highlight a menu item or adjust a value. When the necessary selection is highlighted, push the selection knob to do the selected action, or push and hold to save any changes that have been made. Push  to go to the main screen with no action.

In the output modes (mA Source, mA Simulate):

- Push the selection knob to move the display cursor to the next digit.
- Turn the selection knob to increment or decrement the output in steps shown by the selected decade.
- Push , , or  to set the output to preset values.
- Push  to select and stop these advanced modes.

## Main Menu

Push  to show the Main menu, choose the primary operation mode of the Product, access the Product setup menu, or to use HART mode. See Figure 3.

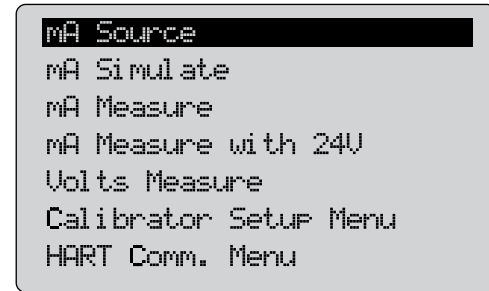

gzx20.eps

Figure 3. Main Menu

The first five items shown on the Main menu change the Product operation mode accordingly and once selected, change the Product menu to a “home” screen for the selected function. The operation modes are explained in the subsequent sections of this manual.

For the last two items of the Main menu, see “The Calibrator Setup Menu” and “Hart Comm. Menu” sections.

### Note

The “HART” menu items only apply to the 709H.

*Note*

*Some menus have multiple screens. When this is the case, the lower-left corner of the menu shows ▼ when additional screens follow the current screen. ▲ is shown when additional screens precede the current screen. Both icons are shown when additional screens follow and precede the present screen.*

***mA Source***

In the **mA Source** mode, the Product outputs a signal from 0 mA to 24 mA into a load of up to 1000  $\Omega$  (750  $\Omega$  if the internal HART resistor is switched on).

Figure 4 shows the mA Source home screen and typical connections for this mode.

To use mA Source:

1. Select **mA Source** from the Main menu.
2. Push the selection knob to move the decade cursor.
3. Turn the selection knob to increment or decrement the output in steps indicated by the selected decade.
4. Push  $0\%$ ,  $25\%$ , or  $100\%$  to set the output to preset values.
5. Push  $\text{F}\Delta$  to select and stop these advanced modes. When automatic step or ramp is active, one of the subsequent icons is shown in the lower left corner:

Automatic step:  $\text{r}$

Automatic ramp:  $\Lambda$

6. Push  $\text{MENU}/\text{EXIT}$  to go to the Main menu.
7. Push  $\text{MENU}/\text{EXIT}$  again to go to the mA Source home screen.
  - **Valve Test** is shown in the lower center when the valve test function has been enabled on the Setup menu. See the “Valve Test” section of this manual.
  - **250 $\Omega$**  is shown in the lower right corner when the HART resistor has been enabled on the setup menu.

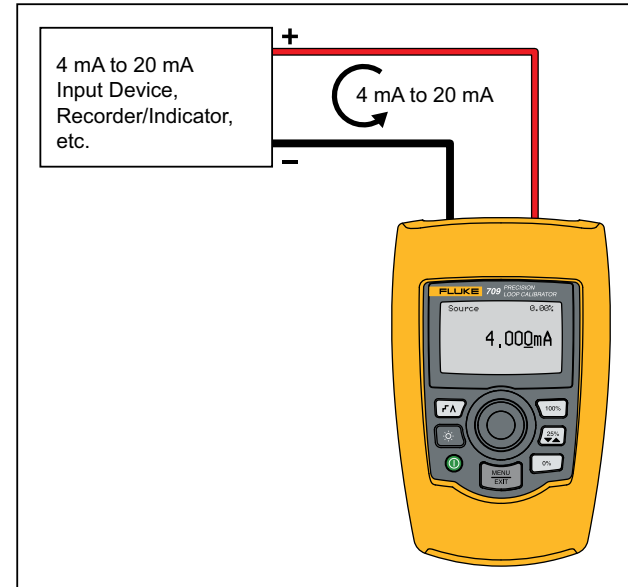

gzx003.eps

Figure 4. mA Source Connections

### **mA Simulate**

In the **mA Simulate** mode, the Product functions like a 2-wire transmitter and controls the loop current from an external power supply. This function can test a loop with the transmitter removed.

Figure 5 shows the mA Simulate home screen and typical connections for this mode.

To use mA Simulate:

1. Select **mA Simulate** from the Main menu.
2. Push the selection knob to move the decade cursor.
3. Turn the selection knob to increment or decrement the output in steps indicated by the selected decade.
4. Push  ,  , or  to set the output to preset values.
5. Push  to select and stop these advanced modes. When automatic step or ramp is active, one of the subsequent icons is shown in the lower left corner:
  - Automatic step:
  - Automatic ramp:
6. Push  to go to the Main menu.
7. Push  again to go to the mA Simulate home screen.

- **Valve Test** is shown in the lower center when the valve test function has been enabled on the Setup menu. See the “Valve Test” section of this manual.
- **250Ω** is shown in the lower right corner when the HART resistor has been enabled on the setup menu.

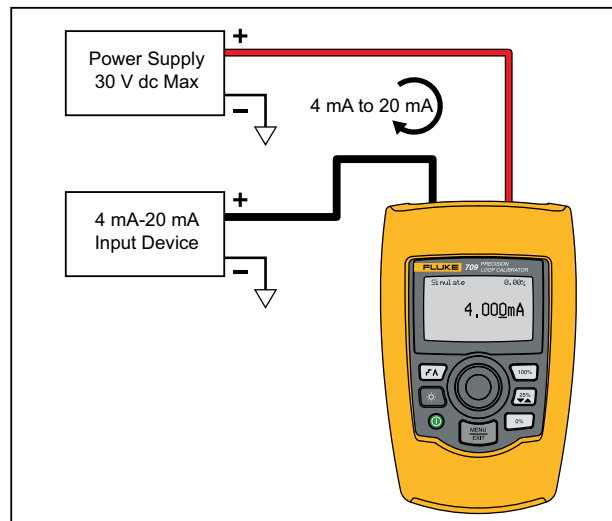

gzx004.eps

**Figure 5. mA Simulate Connections**



### **mA Measure**

In the **mA Measure** mode, the Product shows the loop current measurement. This mode is without 24 V.

Figure 6 shows the mA Measure home screen and typical connections for this mode.

To use mA Measure:

Select **mA Measure** from the Main menu. Once selected, the Product changes to the mA Measure home screen.

**250 $\Omega$**  is shown in the lower right corner when the HART resistor has been enabled on the setup menu.

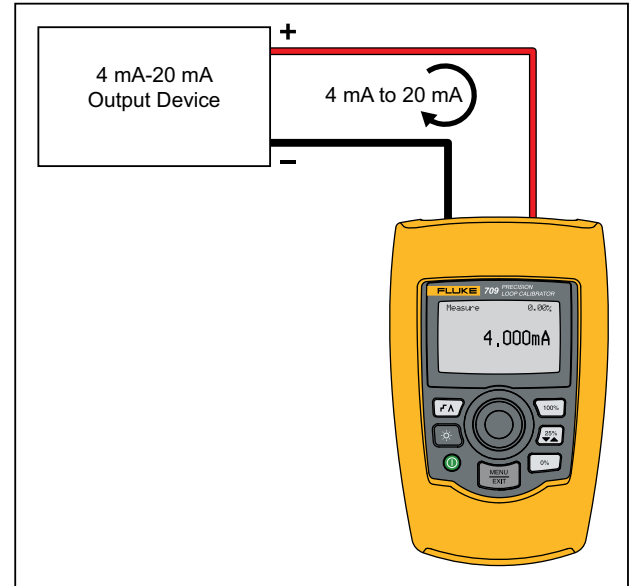

gzx005.eps

**Figure 6. mA Measure Connections**

**mA Measure with 24V**

In the **mA Measure with 24V** mode, the Product outputs 24 V dc as it shows the loop current. The mode can power a transmitter without a separate power supply.

Figure 7 shows the home screen and typical connections for this mode.

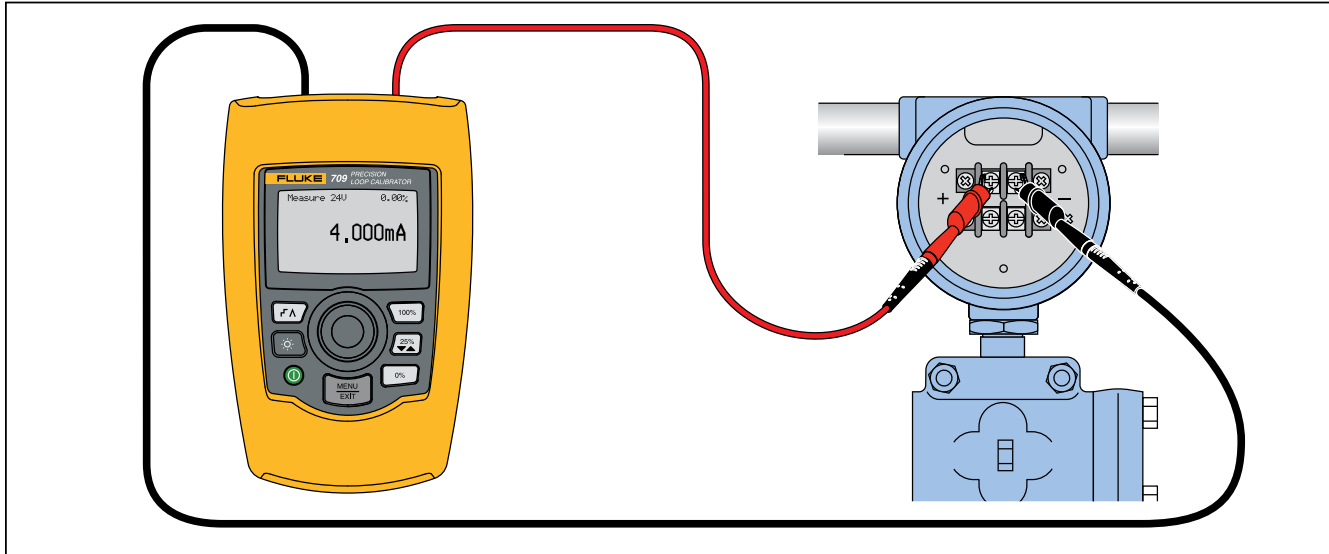

gzx006.eps

Figure 7. mA Measure with 24 V Connections

To use mA Measure with 24 V:

1. Select **mA Measure with 24 V** from the Main menu. Once selected, the Product changes to the mA Measure with 24 V home screen.

**250Ω** is shown in the lower right corner when the HART resistor has been enabled on the setup menu.

### **Volts Measure**

In the **Volts Measure** mode, the Product shows the loop voltage. Figure 8 shows the Volts Measure home screen and typical connections for this mode.

To use the Volts Measure mode:

Select **Volts Measure** from the Main menu. Once selected, the Product changes to the Volts Measure home screen.

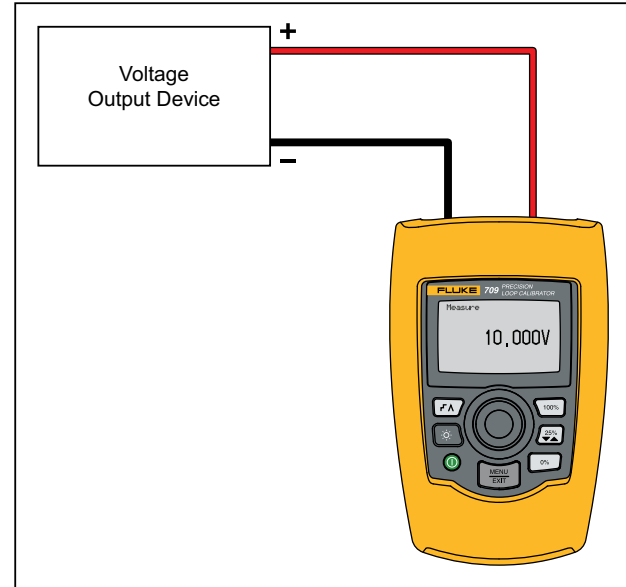

gzx007.eps

**Figure 8. Volts Measure Connections**

## Calibrator Setup Menu

The **Calibrator Setup Menu** has two screens. To go to the second screen, select **Other Parameters** from the first screen. Screen 1 is shown in Figure 9 and screen 2 is shown in Figure 10.

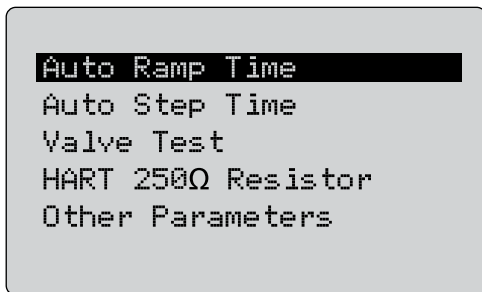

gzx21.eps

Figure 9. Setup Menu, Screen 1

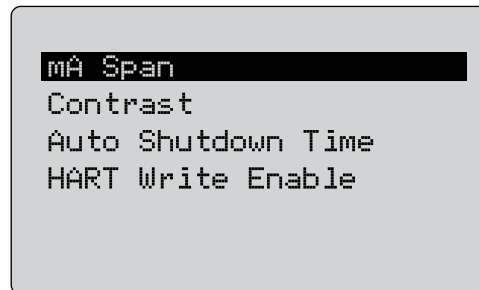

gzx22.eps

Figure 10. Setup Menu, Screen 2

### Note

The “HART Write Enable” menu item only is shown on the 709H.

### **Auto Ramp Time**

The **Auto Ramp Time** function sets the full-scale ramp time for the mA ramp feature. The value can be set from 5 seconds to 300 seconds. Push the selection knob to move the decade cursor. Turn the selection knob to adjust the value in steps indicated by the decade selected. See Figure 11.

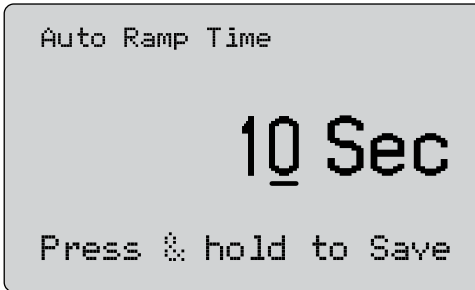

gzx23.eps

**Figure 11. Auto Ramp Time Screen**

### **Auto Step Time**

The **Auto Step Time** function sets the step interval time for the mA Auto Step feature. The value can be set from 5 seconds to 300 seconds. Push the selection knob to move the decade cursor. Turn the selection knob to adjust the value in steps indicated by the decade selected. See Figure 12.

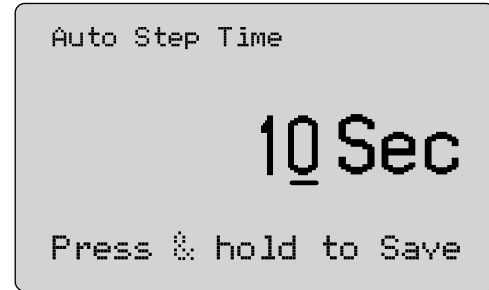

gzx24.eps

**Figure 12. Auto Ramp Step Time Screen**



### **Step and Ramp Operation**

For step and ramp operation, the percent keys can be used to set the milliamp output to 0 % of span, 100 % of span, or step the output by 25 % of span.

Hands-free operation is possible with . Set the Product to automatically and continuously step or ramp the milliamp output from 0 % to 100 % and back.





The 100 % value is always 20 mA, but the 0 % value can be 0 mA or 4 mA. This depends on how the mA span is set. The 25 % step size is 5 mA or 4 mA accordingly.

To use the manual step function:

1. Use the Main menu to set the Product to source or simulate current.
2. Push  to set the output to 0 % of span.
3. Push  to set the output to 100 % of span.
4. Push  to step the output in 25 % of span increments, from 0 % of span to 100 % of span and back.

### **Automatic Step and Ramp**

To use the automatic step and automatic ramp functions:

1. Use the Main menu to set the Product to source or simulate current.
2. The Product has separate auto ramp and step times. Use the menu to set the ramp or step time.
3. Push  once to continually step the output from 0 % of span to 100 % of span and back in increments of 25 % of span at the specified interval.
4. Push  once more to go to auto ramp.
5. Push one of the percent keys, and  twice, to turn off the auto step and ramp.
6. Push  twice to continually ramp the output from 0 % of span to 100 % of span over the specified interval, and then back over the specified interval.
7. Push one of the percent keys or  once more, to turn off the auto step and ramp.

### Valve Test

The **Valve Test** function turns on or off the valve test feature. See Figure 13.

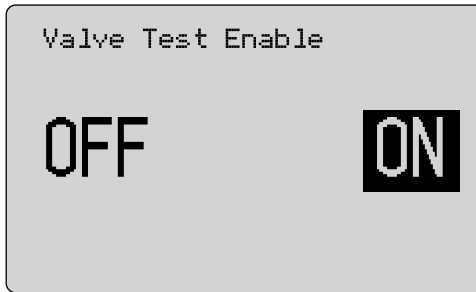

g2x25.eps

**Figure 13. Valve Test Enable Screen**

The valve test verifies correct operation of valves. In valve test, the output can be stepped to these values:

- 3.8 mA
- 4.0 mA
- 4.2 mA
- 8.0 mA
- 12.0 mA
- 16.0 mA
- 19.8 mA
- 20.0 mA
- 20.2 mA

The valve test mA values are not affected by the mA span setting.

1. Use the Main menu to set the Product to source or simulate current.
2. If valve test is not enabled, use the menu to enable it.
3. Push **[F1]** or **[25%]** to step the output to verify the proper valve operation.
4. Use the menu to disable valve test when done.

### HART 250 $\Omega$ Resistor

The **HART 250 $\Omega$  Resistor Enable** function turns on and turns off the HART resistor. See the “HART Resistor” section of this manual. See Figure 14.

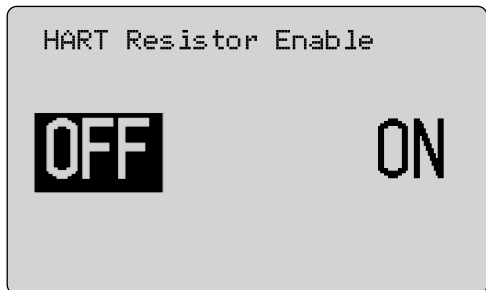

gzx26.eps

**Figure 14. HART Resistor Enable Screen**

The Product can insert a 250  $\Omega$  resistor in series with the power supply in order to use a HART communicator. The HART resistor is enabled through the menu.

To get to the second Calibrator Setup Screen, highlight **Other Parameters** and push the selection knob.

### mA Span

**mA Span** is the first item on the second Calibrator Setup Menu.

The mA Span function sets the step interval for the mA Auto Step feature. The value can be set from 5 seconds to 300 seconds. See the “Step and Ramp Operation” section of this manual. See Figure 15.

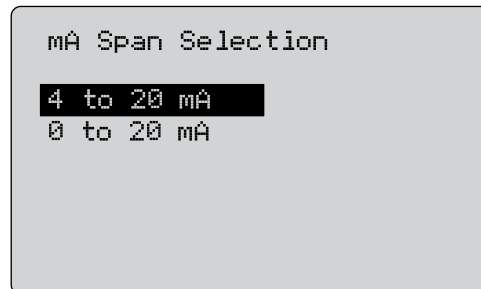

gzx27.eps

**Figure 15. mA Span Selection Screen**



### **Contrast**

The **Contrast** function adjusts the display contrast. Turn the selection knob to adjust the contrast. The range is shown by the bar graph. Higher contrast is shown by a longer bar. The **sample normal** and **reverse video** selections let you evaluate both text modes. See Figure 16.

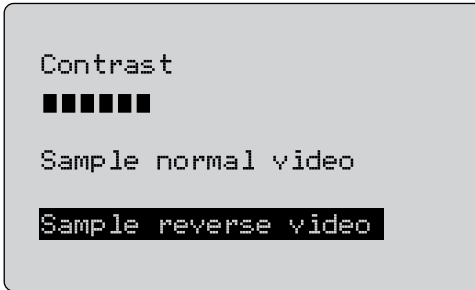

gzx28.eps

**Figure 16. Contrast Adjustment Screen**

### **Auto Shutdown Time**

The **Auto Shutdown Time** function sets or turns off the time before the Product automatically shuts itself down if the keypad is not used. The value can be set to **Disabled**, or from 1 minute to 30 minutes. See Figure 17.

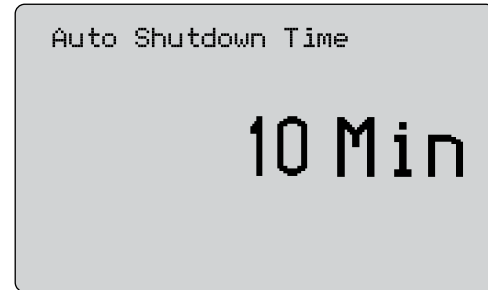

gzx29.eps

**Figure 17. Auto Shutdown Screen**

### HART Write Enable

**HART Write Enable** is the last function in the Calibrator Setup Menu. See Figure 18.



gzx30.eps

**Figure 18. Hart Write Enable Screen**

This function is available only on the 709H. It protects the Write LRV, Write URV, Device Diagnostic, Trim 4mA, Trim 20mA, Set Fixed Output, and PV Zero functions. The default setting is **ON**, but it may be turned off to protect the Product against unauthorized use.

Before the setting is changed, a password is required. The password is set to 617 at the factory. The range of values that can be set is 000 to 999. See Figure 19.

The write-enable selection is saved only when the correct password is given. Otherwise an error message is shown.

Push the selection knob to move the decade cursor. Turn the selection knob to adjust the value in steps indicated by the decade selected. Push and hold the selection knob to save the write enable setting. Push  to restore the previous HART-enable selection and go to the Main screen.

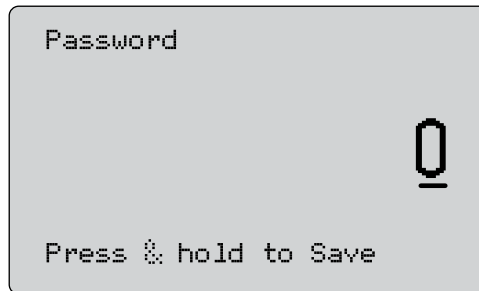

gzx31.eps

**Figure 19. Password Screen**

## **HART Device Communication**

The HART functions are only available in the 709H.

Auto shutdown is disabled when the HART menus are used. Auto shutdown is restored to its previous state when you exit the HART menus.

### *Note*

*Loop current trim is supported for transmitter devices, but is not supported for actuator devices.*

These functions can be disabled with the **HART Write Enable** selection on the Product:

- write LRV
- write URV
- device diagnostic
- trim 4 mA
- trim 20 mA
- fixed output

PV zero functions can be disabled with the **HART Write Enable** selection on the Calibrator Setup menu. See the “Calibrator Setup Menu” section of this manual. If these functions are necessary, they must be enabled before you enter the HART menus.

## **HART Connections**

See the subsequent sections for HART connections.

*In Circuit, External Loop Power*

In **mA Measure** mode, the Product is in circuit and loop power is supplied externally. In Figure 20, the 250  $\Omega$

HART resistor is enabled. If the loop already has 250  $\Omega$ , do not enable the HART resistor.

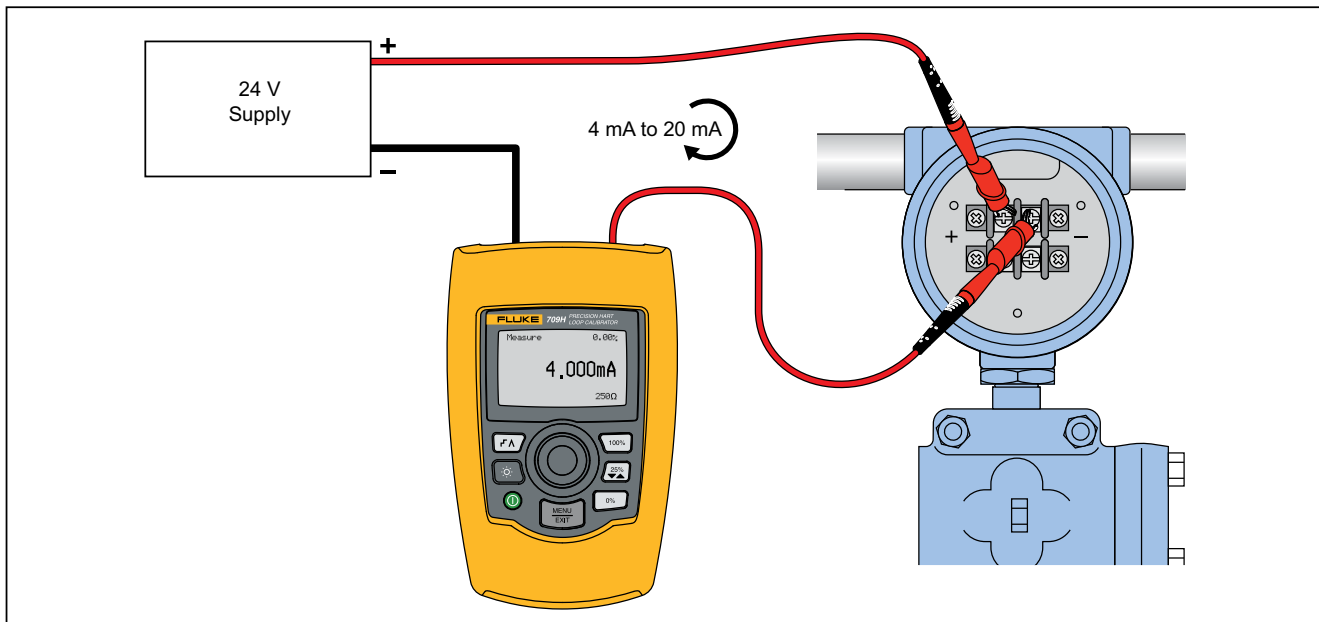

Figure 20. In Circuit, External Loop Power Connections

gzx008.eps

***In Circuit, Product Loop Power***

In **mA Measure with 24V** mode, the Product is in circuit and loop power is supplied by the Product. In Figure 21,

the 250  $\Omega$  HART resistor is enabled. If the loop already has 250  $\Omega$ , do not enable the HART resistor.

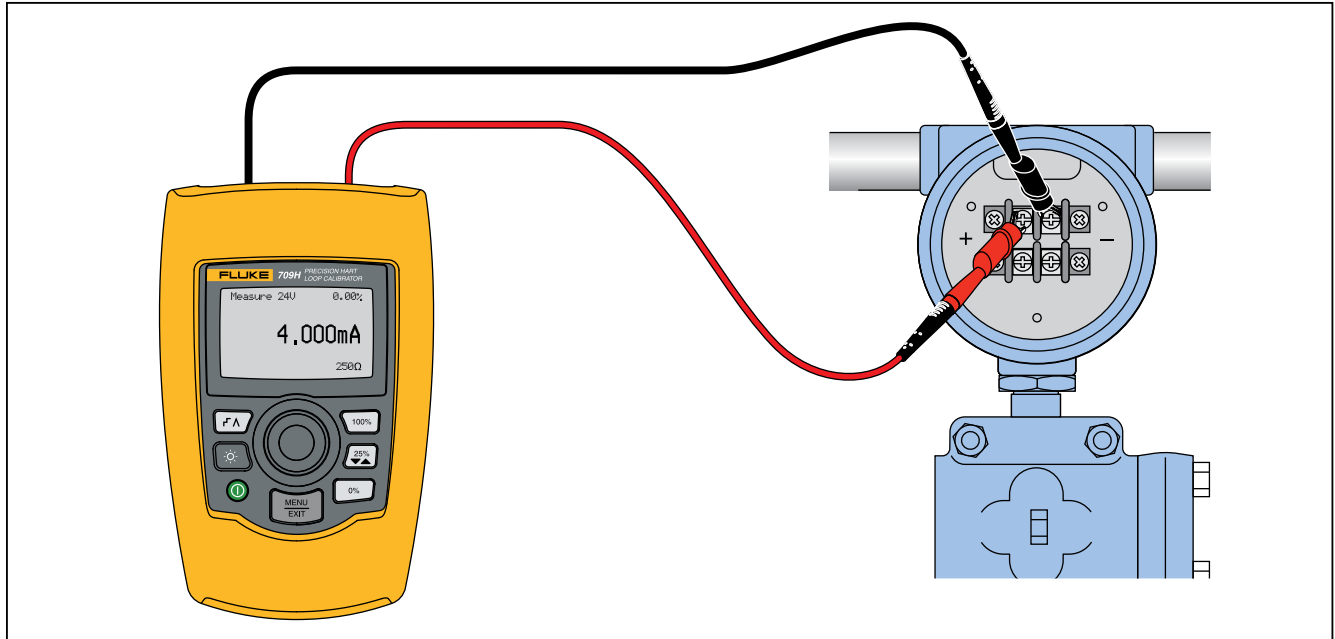

**Figure 21. In Circuit, 709H Loop Power**

gzx009.eps

*Across Circuit, Communicator Only*

In **Communicator Only** mode, the Product is across the circuit and loop power is supplied externally. In Figure 22,

when in Communicator Only mode, there must be 250  $\Omega$  resistance present in the loop.

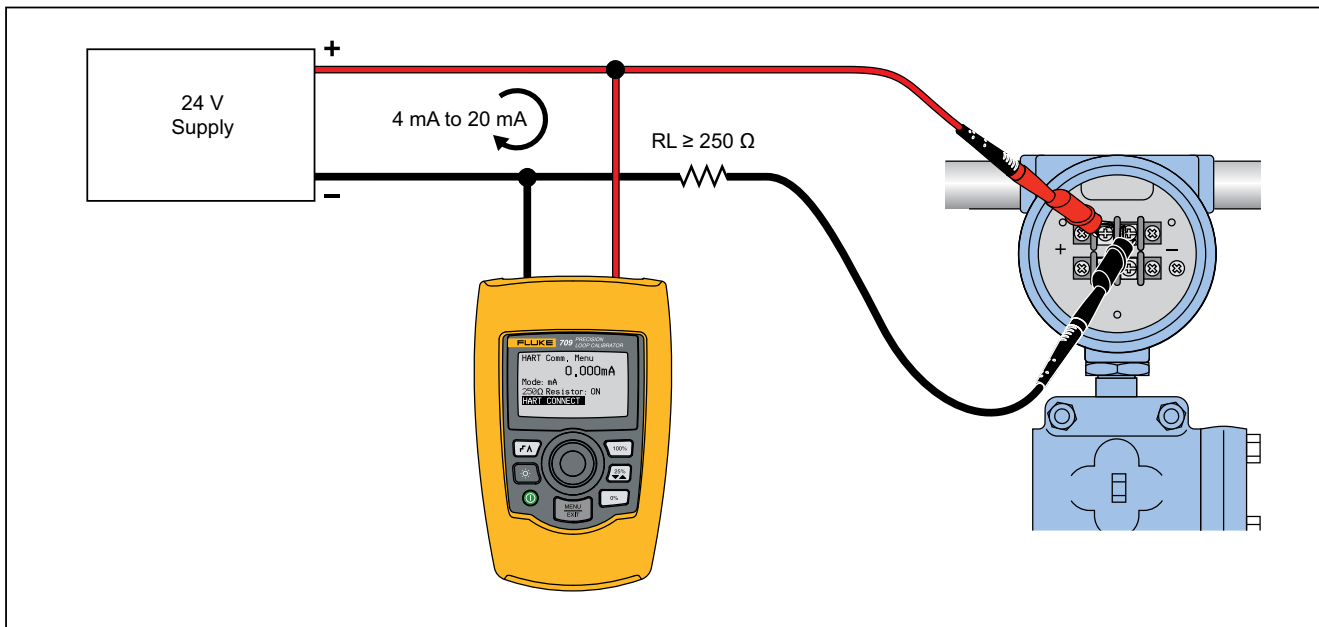

Figure 22. Across Circuit, Communicator Only Connections

gzx010.eps

### Communications Setup and Selection

For all Main screen operation modes, except **mA Measure with 24V** or **Volts Measure**, the operation mode is set to **mA Measure** when you enter the **HART Comm. Menu**.

The operation mode remains the same as the main screen when it is **Measure with 24V**. If **Volts Measure** was selected from the Main menu, the menu defaults to communicator mode only and the 250  $\Omega$  resistor selection shows **n/a**.

The 250  $\Omega$  resistor selection cannot be edited in communicator mode.

The mode and resistor will change from the last selections made in the **HART Comm. Menu** when you exit the menu.

The mode and 250  $\Omega$  resistor settings must correspond to how the test leads are connected before you connect. See Figure 23.

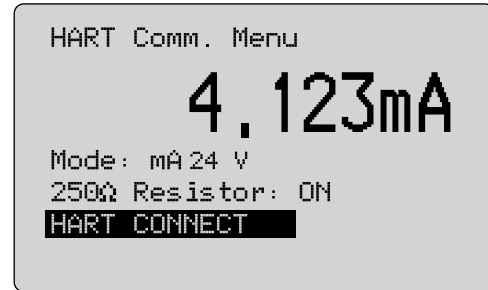

gzx32.eps

Figure 23. HART Comm. Menu Screen

Select a function from the menu and push the selection knob to do the function. Push  to disconnect from HART mode and go to the function home screen without action.

An error is shown and no action is taken if the measured input is out of range, **OL** or **-OL**.

**250 $\Omega$  Resistor**, and **HART CONNECT** functions are described in subsequent sections.

### Mode

The **Mode** function from the **HART. Comm. Menu** lets you select what mode to work in. See Figure 24.

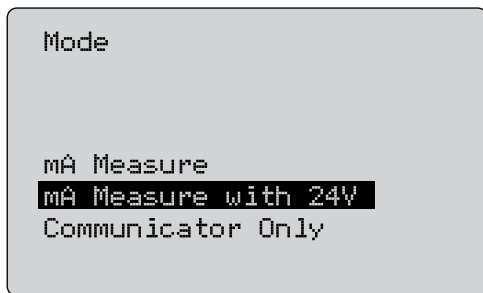

gzx33.eps

**Figure 24. Mode Selection Screen**

Use the selection knob to choose the necessary mode:

- **mA Measure**- The Product is in circuit and loop power is supplied externally.
- **mA Measure with 24V**- The Product is in circuit and the loop power is supplied by the Product.
- **Communicator Only**- The Product is across the circuit and the loop power is supplied externally. The 250Ω resistor selection defaults to **n/a** (not applicable).

### 250Ω Resistor

The **250Ω Resistor** function lets you turn the 250 Ω resistor on or off. Use the selection knob to change the resistor to the highlighted selection and return to the Setup and Selection screen. See Figure 25.

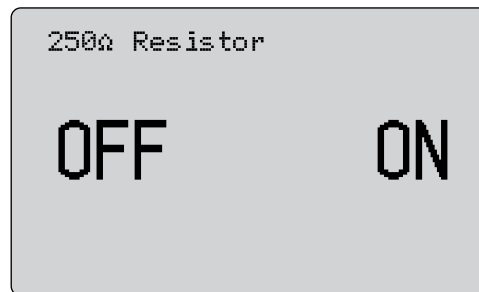

gzx34.eps

**Figure 25. 250Ω Resistor Screen**



### HART Connect

The **HART Connect** function locates the HART device in the loop. Before an operation with a HART device, the device must be located on the loop. This is done by polling all of the possible device addresses and selecting a device from those addresses that respond to the search.

If a HART protocol revision 5 or earlier device is found on the loop, polling stops at poll address 15. If not found, the Product continues to poll address 63. Polling stops after 10 devices are found on the loop.

If multiple devices are found on the loop, a tag list is shown. From the list, select the correct device. If only one device is found on the loop, it becomes the selected device by default.

When a selected device is found, all relevant data is read from the device and the operations described in the “Function Select Menu” and “Device Setup and Data” sections of this manual become available.

### Polling Loop

The **Polling Loop** function searches the loop for HART devices. This function starts immediately. The screen changes to show the string of dots that is extended once per second to as the operation progresses. See Figure 26.

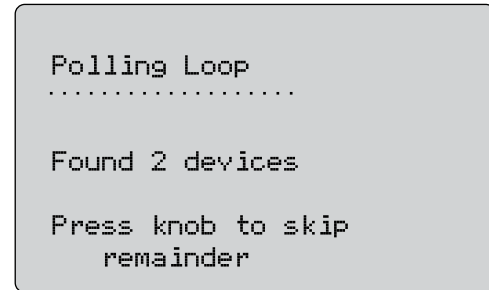

gzx35.eps

**Figure 26. Polling Screen**

The number of devices found on the loop during polling is shown.

The selection knob can be pushed to stop polling early if it is known that all of the devices on the loop have been found. Push  to stop polling, disconnect from HART mode, and go to the function home screen.

An error is shown if no device is found.

If multiple devices are found, a list of tags is shown. Use the list of tags to select the necessary device.

If only one device is found, the tag selection step is skipped.

### Tag Selection

The tag selection screen lists all of the long tag names found during polling. Tag names can span two lines if necessary to show all of the text.

If the long tag name is not available, or it is blank, a short tag name is used. If the short tag name is blank, the text **Poll address x** is used.

Use the selection knob to go to the necessary tag. See Figure 27.

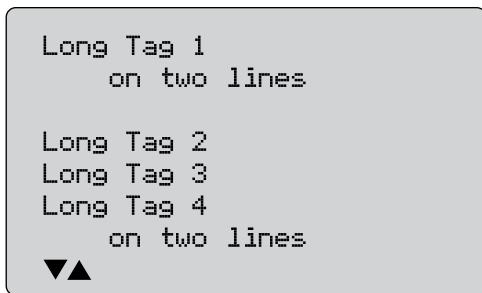

gzx36.eps

Figure 27. Tag Selection Screen

### Acquiring Data

The **Acquiring Data** screen is shown while the Product acquires all of the configuration data from the device. The string of dots extends once per second to show the operation progress. ♥ flashes in the upper-right corner to show a live HART connection.

The screen in Figure 28 shows the name of the tag that is accessed.

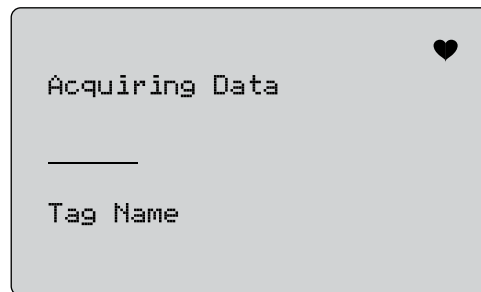

gzx37.eps

Figure 28. Acquiring Data Screen

Push  to stop data acquisition, disconnect from HART mode, and go to the function home screen.

When data acquisition is complete, the **Function Select Menu** is shown.

### **Disconnect from Loop**

The **Disconnect from Loop** screen is shown before the Product returns to the function home screen so the Product can be disconnected from the Loop. See Figure 29 .



gzx38.eps

**Figure 29. Disconnect from Loop Screen**

### **Function Select Menu**

The **Function Select** menu is shown in Figure 30.

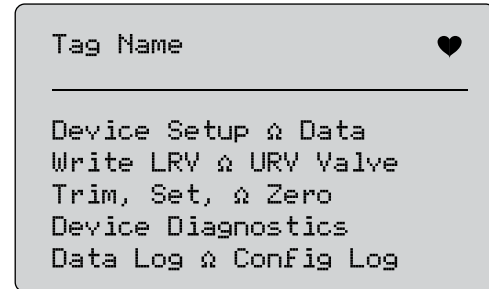

gzx39.eps

**Figure 30. Function Select Menu**

The tag name is truncated to fit on one line when necessary. ♥ flashes in the upper-right corner to show a live connection.

Use the selection knob to choose the necessary action. Push  to disconnect from HART mode and go to the function main screen.

### Device Setup and Data

The **Device Setup and Data** screen spans 11 screens with the format shown in Figure 31.

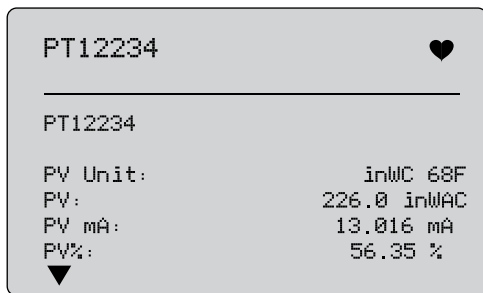

gzx40.eps

**Figure 31. Sample Screen**

This screen shows all of the data retrieved from the data acquisition procedure.

The tag name is truncated to fit on one line when necessary. ♥ flashes in the upper-right corner to show a live connection.

Each screen holds a maximum of 6 data points. An item can span more than one line when necessary to show the full text. If a data item is not supported in the HART device, it is marked **n/a** (not available). Data items that change dynamically in the HART device are updated as often as possible on the screens.

Turn the selection knob to go from screen to screen. Push  to go to the **Function Select** menu.

## Write LRV and URV Values

### Note

For the screens in this section, tag names can be truncated to fit on one line if necessary. ♥ flashes in the upper-right corner to show a live connection.

If the HART write commands are not active, these functions are not available and an error message is shown instead of the screen in Figure 32.

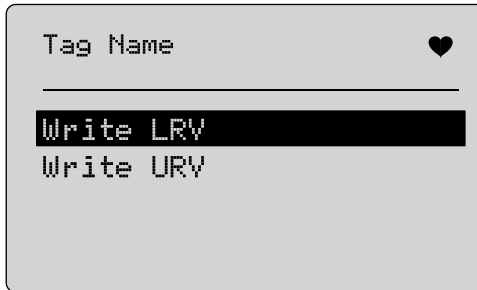

gzx41.eps

Figure 32. Write LRV and URV Screen

Use the selection knob to choose the necessary function. Push the selection knob to choose the highlighted action and go to the corresponding screen. These screens are explained in the “Write LRV” and “Write URV” sections.

Push  to go to the **Function Select** menu.

## Write LRV

The Product warns you to change the loop to MANUAL before you proceed. Push the selection knob to proceed. Push  to go to the **Write LRV** and **Write URV** menu.

The present LRV value and units are shown. See Figure 33.

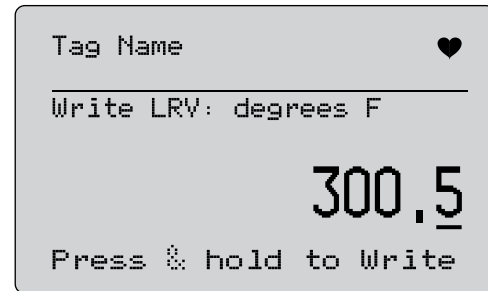

gzx42.eps

Figure 33. Write LRV Screen

1. Push the selection knob to move the decade cursor.
2. Turn the selection knob to increment or decrement the value in steps indicated by the selected decade.
3. Push and hold the knob to send the new value to the HART device. An error is shown if the HART device rejects the value.

4. Push  to go to the **Function Select** menu. A reminder to change the loop to **AUTOMATIC** is shown first.

### Write URV

The Product warns you to change the loop to **MANUAL** before you proceed. Push the selection knob to proceed. Push  to go to the LRV and URV menu.

The present URV value and units are shown. See Figure 34.



gzx43.eps

Figure 34. Write URV Screen

1. Push the selection knob to move the decade cursor.
2. Turn the selection knob to increment or decrement the value in steps indicated by the selected decade.

3. Push and hold the knob to send the new value to the HART device, remaining on this display. An error is shown if the HART device rejects the value.
4. Push  to go to the LRV and URV menu. A prompt to change the loop to **AUTOMATIC** is shown first.

### Trim, Set, and Zero Menu

#### Note

*For the screens in this section, tag names can be truncated to fit on one line if necessary. ♥ flashes in the upper-right corner to show a live connection.*

If the HART write commands are not enabled, these functions are not available and an error message is shown instead of the screen shown in Figure 35.

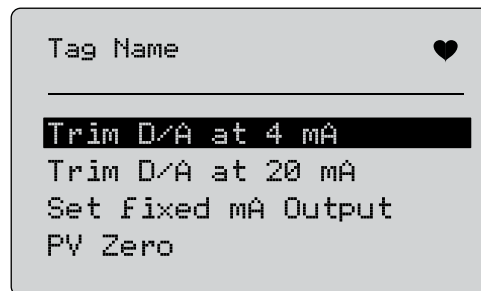

gzx44.eps

Figure 35. Trim, Set, and Zero Screen

Use the selection knob to select and start the necessary action. Push  to go to the **Function Select** menu.

### **Trim 4 mA**

If the operation mode is **Communicator Only**, this function is not available and an error message is shown.

A prompt to change the loop to **MANUAL** before you proceed is shown. Push the selection knob to proceed. Push  to go to the Trim, Set and Zero menu.

While the HART device is changed to fixed output mode, An error is shown if the HART device rejects the mode change command. When the mode change is successful, the screen in Figure 36 is shown.

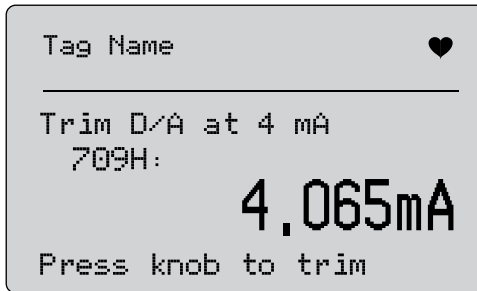

gzx45.eps

**Figure 36. Trim 4 mA Screen**

While the output to settles at 4 mA, the screen shows the Product measurement. The measurement is updated once a second.

1. Push the selection knob to trim the HART device. Stay on this screen to evaluate the result. An error is shown if the HART device rejects the trim command.
2. Push  to change the HART device to normal output mode and go to the Trim, Set, and Zero menu. A warning to change the loop to **AUTOMATIC** is shown first. An error is shown if the device rejects the mode change command.

### Trim 20 mA

If the operation mode is **Communicator Only**, this function is not available and an error message is shown.

A warning to change the loop to **MANUAL** before you proceed is shown. Push the selection knob to proceed. Push  to go to the Trim, Set and Zero menu.

While the HART device is changed to fixed output mode, an error is shown if the HART device rejects the mode change command. When the mode change is successful, the screen in Figure 37 is shown.

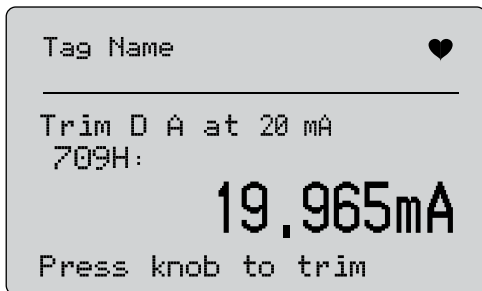

gzx46.eps

Figure 37. Trim 20 mA Screen

As the output settles at 20 mA, the screen shows the Product measurement. The measurement is updated once a second.

1. Push the selection knob to trim the HART device. Stay on this screen to evaluate the result. An error is shown if the HART device rejects the trim command.
2. Push  to change the HART device to normal output mode and go to the Trim, Set, and Zero menu. A prompt to change the loop to **AUTOMATIC** is shown first. An error is shown if the device rejects the mode change command.



### **Set Fixed mA Output**

If the operation mode is **Communicator Only**, this function is not available and an error message is shown.

A warning to change the loop to **MANUAL** before you proceed is shown. Push the selection knob to proceed. Push  to go to the Trim, Set and Zero menu.

As the HART device is changed to fixed output mode, an information screen is shown. An error is shown if the HART device rejects the mode change command. When the mode change is successful, the screen in Figure 38 is shown.

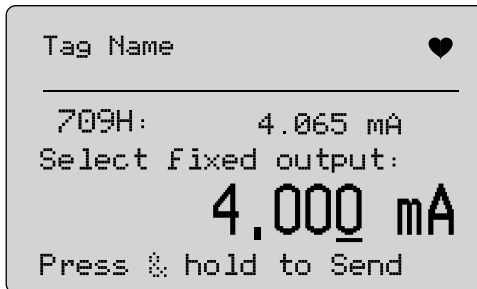

gzx47.eps

**Figure 38. Set Fixed mA Output Screen**

This screen is used to set a fixed output and monitor the result with the Product measurement. The measurement is updated once a second.

The range of values that can be set is 3.0 mA to 21.0 mA.

1. Use the selection knob to select and increment or decrement the value in steps shown by the selected decade.
2. Push and hold the selection knob to send the new value to the HART device and stay on this screen. An error is shown if the HART device rejects the value.
3. Push  to change the HART device to normal output mode and go to the Trim, Set, and Zero menu. A warning to change the loop to **AUTOMATIC** is shown first. An error is shown if the device rejects the mode change command.

### PV Zero

A warning to change the loop to MANUAL before you proceed is shown. Push the selection knob to proceed. Push  to go to the Trim, Set, and Zero menus.

The screen shown in Figure 39 prompts you to set the PV process input signal to zero and then monitors the result with the Product measurement. The measurement is updated once a second.

When the operation mode is **Communicator Only**, the mA measurement is not available and the message **mA not available, in Comm. Only** mode is shown instead.

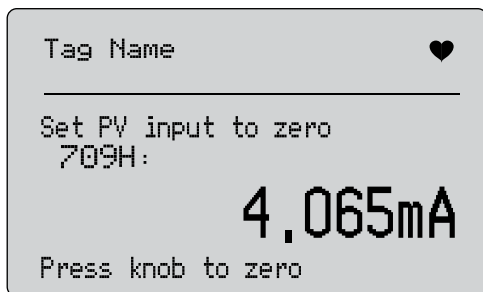

gzx48.eps

Figure 39. PV Zero Screen

1. Push the selection knob to zero the HART device, and stay on this screen to evaluate the result. An error is shown if the HART device rejects the zero command.
2. Push  to go to the Trim, Set, and Zero menu. A prompt to restore the PV process input signal to normal operation configuration and change the loop to **AUTOMATIC** is shown first.

## Device Diagnostic

### Note

For the screens in this section, tag names can be truncated to fit on one line if necessary. ♥ flashes in the upper-right corner to show a live connection.

If the HART write commands are not active, this function is not available and an error message is shown.

A warning to change the loop to **MANUAL** before you proceed is shown. Push the selection knob to proceed. Push  to go to the Function Select menu.

Push the selection knob to select and start the self test. See Figure 40.

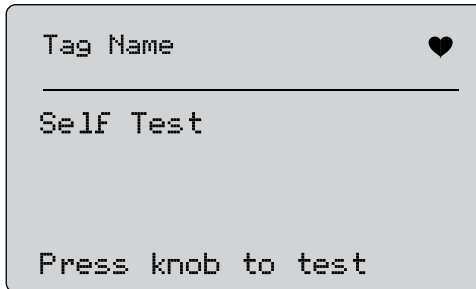

gzx49.eps

Figure 40. Self Test Screen

As the self test is done, the bottom line of the screen changes to **Testing** and a string of dots extends once per second to show the operation progress.

At the end of the self test, the screen in Figure 41 is shown. It shows **No errors** or the first error is reported.

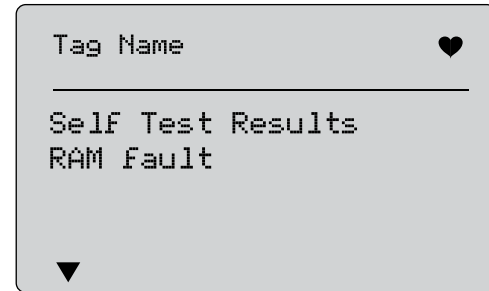

gzx50.eps

Figure 41. Self Test Results Screen

The lower-left corner shows ▼ when additional errors follow the present error. ▲ is shown when additional errors precede the present error. ▼ and ▲ show when additional errors follow and precede the present error.

Turn the selection knob to step between errors.

1. Push  to go to the **Function Select** menu. A reminder to change the loop to **AUTOMATIC** is shown first.

### Configuration Log and Data Log

Configuration Log and Data Log are only available when connected to a HART device. Use the selection knob to choose either the Configuration Log or Data Log. See Figure 42.

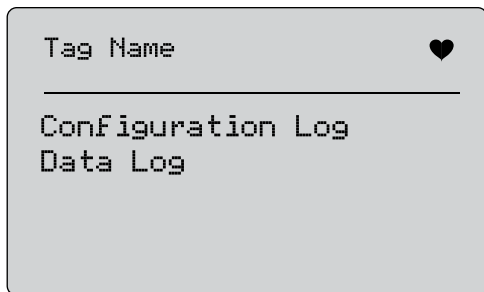

gzx51.eps

Figure 42. Data Log and Configuration Log Screen

### Configuration Log

Configuration data for a maximum of 20 tags can be stored for later recall. The configuration data saved is the same as that shown on the Device Data screen.

The initial Configuration Log screen spans more than one screen and shows a list of the tags held in storage. If a storage position is not used, the tag name area shows **<empty>**. See Figure 43.

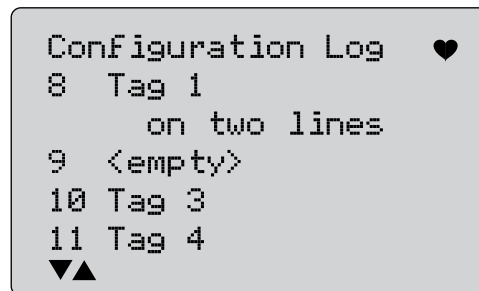

gzx52.eps

Figure 43. Configuration Log Screen

After a storage position is selected, data can be saved or recalled from it. It can be erased or sent to the USB port. The data can also be uploaded to a PC with the 709H/TRACK Windows Software.

It is recommended that you use a Lemo to USB cable with 709H/TRACK Software. It has a USB/Serial adapter that uses an FTDI chipset. This combination gives consistent and reliable communication between the Product and PC. The USB Drivers are included on the 709H/TRACK Software CD.

Use the selection knob to highlight and select the correct storage location.

Push  to go to the **Log Select** menu.

When a storage position is selected, the menu in Figure 44 is shown. Select the necessary action.

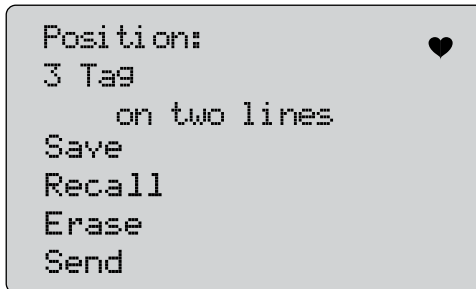

gzx53.eps

**Figure 44. Configuration Log Showing Storage Position**

The number and contents of the storage position are shown at the top. The tag number is **<empty>** if the storage position is empty.

Use the selection knob to highlight and select the correct function. Push  to go to the **Log Select** menu.

**SAVE** operation:

- If the position is empty, save the present device configuration data into the storage position.
- If the position is in use, confirm that the existing data is to be replaced with the present tag data before you save it into the storage position.

**RECALL** operation:

- If the position is empty, an error message is shown.
- If the position is in use, the data is shown in a sequence of screens identical to the Device Data screen.

**ERASE** operation:

- If the position is empty, an error message is shown.
- If the position is in use, confirm that the existing data is to be permanently deleted before doing so.

**SEND** operation:

- If the position is empty, an error message is shown.
- If the position is in use, send the data to the RS232 port in a report format.

**Data Log**

Process data can be stored for a single tag for later upload to a PC with the 709H/TRACK Windows Software. See the “Configuration Log” section of this manual for more.

Data can be logged in multiple sessions, but all sessions must be from the same HART device as determined by the long tag name. A different logging interval can be selected for each session. Each data sample has the Product measurement, device mA, and all four process variables.

There are 9810 records available. Each data sample uses one record. Each session uses two records for overhead data that is common to all of the data samples in that session. There can be from 1 to 99 sessions.

The total number of data samples that can be logged is 9810 less 2 times the number of sessions started and stopped. See Figure 45.

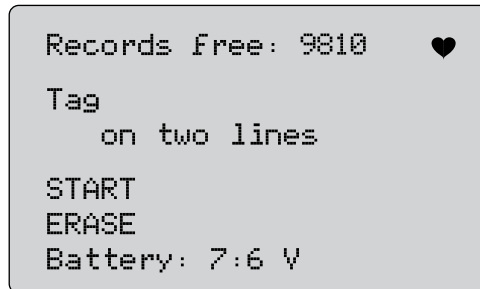

gzx54.eps

**Figure 45. Data Log Screen**

The number of free records is shown on the first line. If data has already been logged, the tag number is shown below it.

The present battery voltage is shown at the bottom so that you can tell if the batteries should be changed before a log session starts. The log is stopped before the Product is turned off when the battery reaches its low voltage automatic shutoff limit of 5.6 V.

- Use the selection knob to highlight and select the correct function.
- Push the knob to do the operation. Push  to return to the Log Select menu.

**START** operation:

- If no free records or free sessions remain, or the present HART device does not match the HART device already logged, an error message is shown.
- Otherwise, proceed to interval selection described below.

**ERASE** operation:

- If there is no logged data, an error message is shown.
- Otherwise, confirm that the present data is to be permanently erased before doing so.

Select the logging interval. See Figure 46.

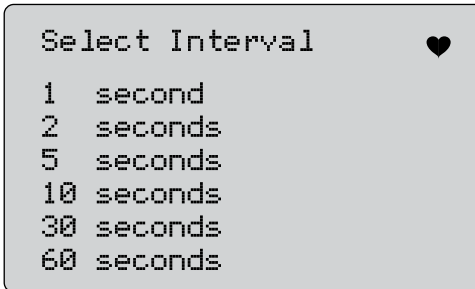
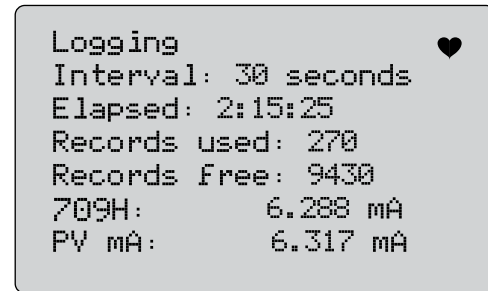

**Figure 46. Logging Interval Screen**

gzx55.eps

Turn the selection knob to move the highlight and select the necessary interval. Push the selection knob to start logging at that interval. Push  to go to the first data log screen.

While logging, the screen in Figure 47 is shown to monitor progress.



gzx56.eps

**Figure 47. Active Logging Screen**

Push  to stop logging and go to the first data log screen.

The data items shown are:

- The top line indicates is logging is in progress (**Logging**) or is stopped (**Stopped**). Logging stops automatically when storage is full or before the Product is turned off when the battery reaches its low voltage automatic shutoff limit of 5.6 V.
- **Interval** is the item previously selected.
- **Elapsed** is the time since the log was started, updated each time a new sample is saved.
- **Records used** is the total number used to date for all sessions, updated each time a new sample is saved.
- **Records free** is the total number that remain unused, updated each time a new sample is saved.
- **709H** is the present measurement, updated as often as possible.
- **PV mA** is the last HART device measurement, updated as often as possible.

## **Maintenance**

### **⚠⚠ Warning**

**For safe operation and maintenance of the Product:**

- **Repair the Product before use if the battery leaks.**
- **Be sure that the battery polarity is correct to prevent battery leakage.**
- **Remove the input signals before you clean the Product.**
- **Use only specified replacement parts.**
- **Have an approved technician repair the Product.**



### ***Clean the Product***

Clean the Product and pressure modules with a soft cloth dampened with water or water and mild soap.

#### **⚠ Caution**

**To prevent possible damage to the Product:**

- **Do not use solvents or abrasive cleansers.**
- **Do not allow water into the case.**

### ***Fuse***

The Product is protected from overcurrent condition by an internal self-resetting fuse. The fuse will automatically reset within a few seconds. The fuse cannot be repaired manually.

### **Battery Replacement**

Replace the batteries when the battery indicator is shown on the display.

To replace the batteries:

1. Remove the holster.
2. Turn the Product over so the display is face down.
3. With a flat-head screwdriver, remove the battery door screws.
4. Remove the batteries.
5. Replace the old batteries. Note the correct polarity as the new batteries are installed.
6. Attach the battery door.
7. Tighten the two battery door screws.
8. Put the Product back into the holster. See Figure 48.

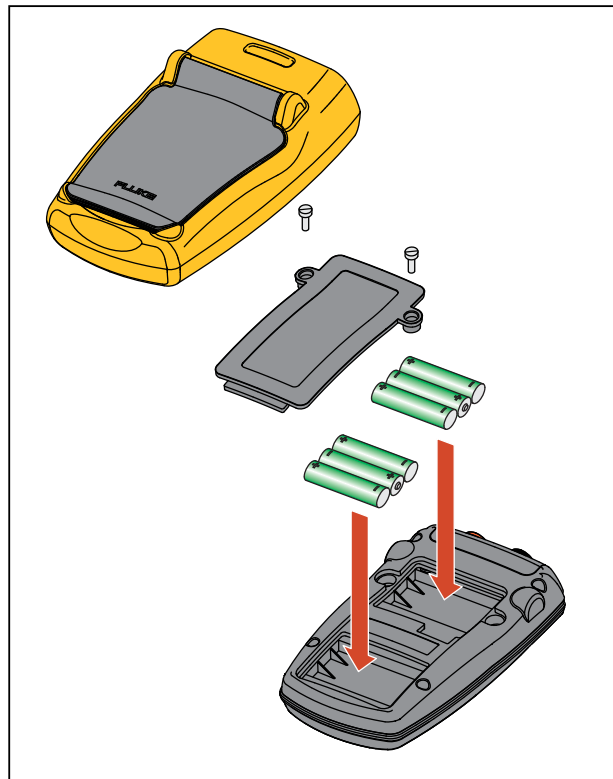

gzx011.eps

**Figure 48. Battery Replacement**

### **User-Replaceable Parts**

User-replaceable parts are shown in Table 4. For more information about these items and their prices, contact a Fluke representative. See the “Contact Fluke” section.

**Table 4. User-Replaceable Parts**

<b>Item</b>	<b>Fluke Part Number</b>
Fluke-709-2005, Knob	4282155
Fluke-709-2001, Case Top	4252536
Fluke-709-2002, Case Bottom	4252549
Fluke-709-2003, Battery Door	4257167
Fluke-709-2004, Connector Panel	4257171
Fluke-709-2006, Holster, Fluke-709	4241437
Fluke-709H-2006, Holster, Fluke-709H	4241443
Fluke-709-2007, Bail, Fluke709/709H	4241455
Fluke-709-8003, Keypad, Fluke-709/709H	4252551
TL75-4201 ,TEST LEADS	855742

**Table. User-Replaceable Parts (cont.)**

<b>Item</b>	<b>Fluke Part Number</b>
AC280-5001-01,175-277-011, AC280 SUREGRIP HOOK CLIP,BLACK,BULK	2063165
AC280-5001,175-277-013,SUREGRIP HOOK CLIP,RED,BULK	1613782
AC72-1-01, ALLIGATOR CLIP,30V, 2MM JACK, RED BOOT	4209063
AC72-1-02, ALLIGATOR CLIP,30V, 2MM JACK, BLACK BOOT	4209074
TP220-4201,TEST PROBES,RED	2047206
TP220-4201-01,TEST PROBES,BLACK	2063129
FLUKE-754-8016,ALLIGATOR CLIP SET, EXTENDED TOOTH	3765923
FLUKE-75X-8014,CABLE ASSEMBLY, STACKABLE LEAD SET	3669716
CD, Users Manual, Fluke 709/709H	4240654
Safety Sheet, Fluke-709/709H	4240668
Quick Reference Guide, Fluke-709/709H	4255201
709H/TRACK, Datalogging Software & Cable	4281225
SOFTCASE,POLYESTER,BLK/YEL,10.00,7.50,3.00, C115	2643273

## Specifications

### Ranges

mA ..... 0 mA to 24 mA

Volts ..... 0 V dc to 30 V dc

### Resolution

mA Ranges ..... 1  $\mu$ A

Voltage Range ..... 1 mV

Accuracy ..... 0.01 %  $\pm$ 2 LSD all ranges (@23 °C  $\pm$ 5 °C)

Stability ..... 20 ppm of F.S. /°C from -10 °C to 18 °C and 28 °C to 55 °C

Operating Temp Range ..... -10 °C to 50 °C (14 °F to 122 °F)

Storage Temp Range ..... -20 °C to 60 °C (-4.0 °F to 140 °F)

Altitude ..... 3000 meters

Ingress Protection Rating ..... IEC 60529: IP40

Humidity Range ..... 10 % to 95 % non-condensing

Display ..... 128 x 64 pixels, LCD Graphic with backlight, 8.6 mm high digits

Power ..... Six AAA alkaline batteries

Battery Life (Alkaline Batteries) .....  $\geq$ 40 hours continuous use (measure mode)

Loop Compliance Voltage ..... 24 V dc @ 20 mA

Loop Drive Capability ..... 1200  $\Omega$  without HART resistor, 950  $\Omega$  with HART resistor

## **709/709H**

### *Users Manual*

---

Electromagnetic Environment ..... IEC 61326-1 (portable equipment)

Dimensions (LxWxD) ..... (152 x 93 x 44) mm, (6.0 x 3.7 x 1.7) in

Weight.....0.3 kg (9.5 oz)