

FLUKE®

719PRO

Pressure Calibrator

Test Equipment Depot - 800.517.8431 - 99 Washington Street Melrose, MA 02176 - TestEquipmentDepot.com

Users Manual

October 2013

© 2013 Fluke Corporation. All rights reserved. Specifications are subject to change without notice.

All product names are trademarks of their respective companies.

LIMITED WARRANTY AND LIMITATION OF LIABILITY

This Fluke product will be free from defects in material and workmanship for three years from the date of purchase. This warranty does not cover fuses, disposable batteries, or damage from accident, neglect, misuse, alteration, contamination, or abnormal conditions of operation or handling. Resellers are not authorized to extend any other warranty on Fluke's behalf. To obtain service during the warranty period, contact your nearest Fluke authorized service center to obtain return authorization information, then send the product to that Service Center with a description of the problem.

THIS WARRANTY IS YOUR ONLY REMEDY. NO OTHER WARRANTIES, SUCH AS FITNESS FOR A PARTICULAR PURPOSE, ARE EXPRESSED OR IMPLIED. FLUKE IS NOT LIABLE FOR ANY SPECIAL, INDIRECT, INCIDENTAL OR CONSEQUENTIAL DAMAGES OR LOSSES, ARISING FROM ANY CAUSE OR THEORY. Since some states or countries do not allow the exclusion or limitation of an implied warranty or of incidental or consequential damages, this limitation of liability may not apply to you.

Table of Contents

Title	Page
Introduction	1
Contact Fluke	1
Safety Information	2
Symbols	4
Standard Equipment.....	5
Product Features.....	5
Display.....	8
Language Selection.....	9
Home Menu Functionality.....	10
Backlight Use	10
The MENU Option	10
Main Menu Functionality.....	11
Set the Active Display.....	11
Set Active Display Parameters	11
Zero Function Use.....	13

Internal Sensor and Pressure Module (non-absolute).....	13
Absolute Pressure	13
Other Menu Controlled Functions	14
Set the Contrast	14
Lock and Unlock Configurations.....	15
Save and Recall Setups.....	15
Set Auto Off Parameters	16
Activate and Deactivate a Display.....	17
Set the RTD Probe Type.....	17
Damping.....	18
HART™ Resistor	18
Pump Limits	18
Initial Setup and Basic Pressure Generation	18
Electric Pump Considerations.....	20
Measure Pressure	20
Media Compatibility.....	21
Measure Pressure with External Modules.....	21
Measure and Generate Current (4 mA to 20 mA).....	22
Measure Voltage.....	24
Measure Temperature with an RTD.....	25
Pressure Switch Test.....	26
Transmitter Calibration	29
mA Input Function.....	29
Pressure-to-Current Transmitter Calibration	30
Percent Error Function.....	30
Minimum and Maximum Storage Capability	35
Factory Setups	36
Custody Transfer / Flow Calibration.....	39
Remote Operation	39

Remote Interface	39
Set up the RS-232 Port for Remote Control	41
Change Between Remote and Local Operation	42
Command Use and Types	42
Character Processing	43
Response Data Types	44
Calibrator Status	44
Remote Commands and Error Codes	45
Enter Commands.....	50
Common Commands	50
Calibrator Commands	51
Ranges and Resolution	59
Maintenance.....	61
Replace the Batteries	61
Clean the Product.....	63
Clean the Valve Assembly.....	63
User-Replaceable Parts and Accessories	64
Specifications	67

List of Tables

Table	Title	Page
1.	Symbols.....	4
2.	Product Features.....	7
3.	Display Functions.....	9
4.	Mode Concurrency.....	12
5.	Common Commands.....	45
6.	Calibrator Commands.....	45
7.	Parameter Units.....	48
8.	Error Codes.....	49
9.	Ranges and Resolutions.....	59
10.	User-Replaceable Parts and Accessories.....	64

List of Figures

Figure	Title	Page
1.	Product Interface	6
2.	Display.....	8
3.	Pump Connection.....	19
4.	Pressure with External Modules	21
5.	Measure and Generate Current.....	23
6.	Voltage Measurement	24
7.	Temperature Measurement with RTD Probe.....	25
8.	Pressure Switch Connection	26
9.	Pressure-to-Current Transmitter Connections.....	31
10.	Percent Error Function Connection	32
11.	Typical Remote Connection	40
12.	Battery Replacement.....	62
13.	User-Replaceable Parts and Accessories	66

Introduction

The 719PRO Pressure Calibrator (the Product) is a simple to use and versatile pressure calibrator. Its internal pressure sensor and innovative electrically-powered pump reach higher pressures (maximum 300 psi) and let the Product calibrate virtually any pressure device. The Product features inputs for mA, voltage, switch contacts, and an RTD probe. An external-pressure module option gives a wider range of pressure calibration options that include absolute and differential.

To download manuals, or to view, print, or download the latest manual supplement, visit <http://us.fluke.com/user/support/manuals>.

Safety Information

A **Warning** identifies conditions and procedures that are dangerous to the user. A **Caution** identifies conditions and procedures that can cause damage to the Product or the equipment under test.

Warning

To prevent possible electrical shock, fire, or personal injury:











- Only assemble and operate high-pressure systems if you know the correct safety procedures. High-pressure liquids and gases are hazardous and the energy from them can be released without warning.
- Read all safety information before you use the Product.
- Carefully read all instructions.
- Do not use the Product around explosive gas or vapor.
- Use the correct terminals, function, and range for measurements.
- Do not apply more than the rated voltage, between the terminals or between each terminal and earth ground.
- Do not touch voltages > 30 V ac rms, 42 V ac peak, or 60 V dc.
- Remove all probes, test leads, and accessories before the battery door is opened.
- Do not exceed the Measurement Category (CAT) rating of the lowest rated individual component of a Product, probe, or accessory.
- Do not use and disable the Product if it is damaged.
- Remove the input signals before you clean the Product.
- Use only specified replacement parts.
- Have an approved technician repair the Product.
- Use the Product only as specified, or the protection supplied by the Product can be compromised.

- **Pressure sensors can be damaged and/or personnel injury can occur due to improper application of pressure. Vacuum should not be applied to any gauge pressure sensor. The Product display shows “OL” when an inappropriate pressure is applied. If “OL” is shown on any pressure display, the pressure should be reduced or vented immediately to prevent Product damage or possible personnel injury. “OL” is shown when the pressure exceeds 110 % of the nominal range of the sensor or when a vacuum in excess of 2 PSI is applied on gauge range sensors.**
- **Push the ZERO button to zero the pressure sensor when vented to atmospheric pressure.**
- **Remove the batteries if the Product is not used for an extended period of time, or if stored in temperatures that exceed the battery manufacturer’s specification. If the batteries are not removed, battery leakage can damage the Product.**
- **Replace the batteries when the low battery indicator shows to prevent incorrect measurements.**
- **Be sure that the battery polarity is correct to prevent battery leakage.**
- **Repair the Product before use if the battery leaks.**
- **The battery door must be closed and locked before you operate the Product.**
- **Use only specified replacement parts.**

Symbols

Symbols used on the Product or in this manual are shown in Table 1.

Table 1. Symbols

Symbol	Description	Symbol	Description
	Risk of Danger. Important information. See Manual.		Conforms to relevant North American Safety Standards.
	Hazardous voltage. Risk of electric shock.		Double Insulated
	Conforms to European Union directives.		Conforms to relevant Australian EMC standards.
	Inspected and licensed by TÜV Product Services.		Battery
	This product complies with the WEEE Directive (2002/96/EC) marking requirements. The affixed label indicates that you must not discard this electrical/electronic product in domestic household waste. Product Category: With reference to the equipment types in the WEEE Directive Annex I, this product is classed as category 9 "Monitoring and Control Instrumentation" product. Do not dispose of this product as unsorted municipal waste. Go to Fluke's website for recycling information.		Conforms to relevant South Korean EMC Standards.

Standard Equipment

Make sure that the Product shipment is complete. It must include:

- The Product
- Product Manuals CD
- Getting Started Manual
- Quick Reference Guide
- Test leads
- Calibration Hose kit with fittings
- Carry case
- Calibration certificate

Product Features

Figure 1 and Table 2 shows the location of the buttons, pressure controls, connection ports, and electrical inputs.

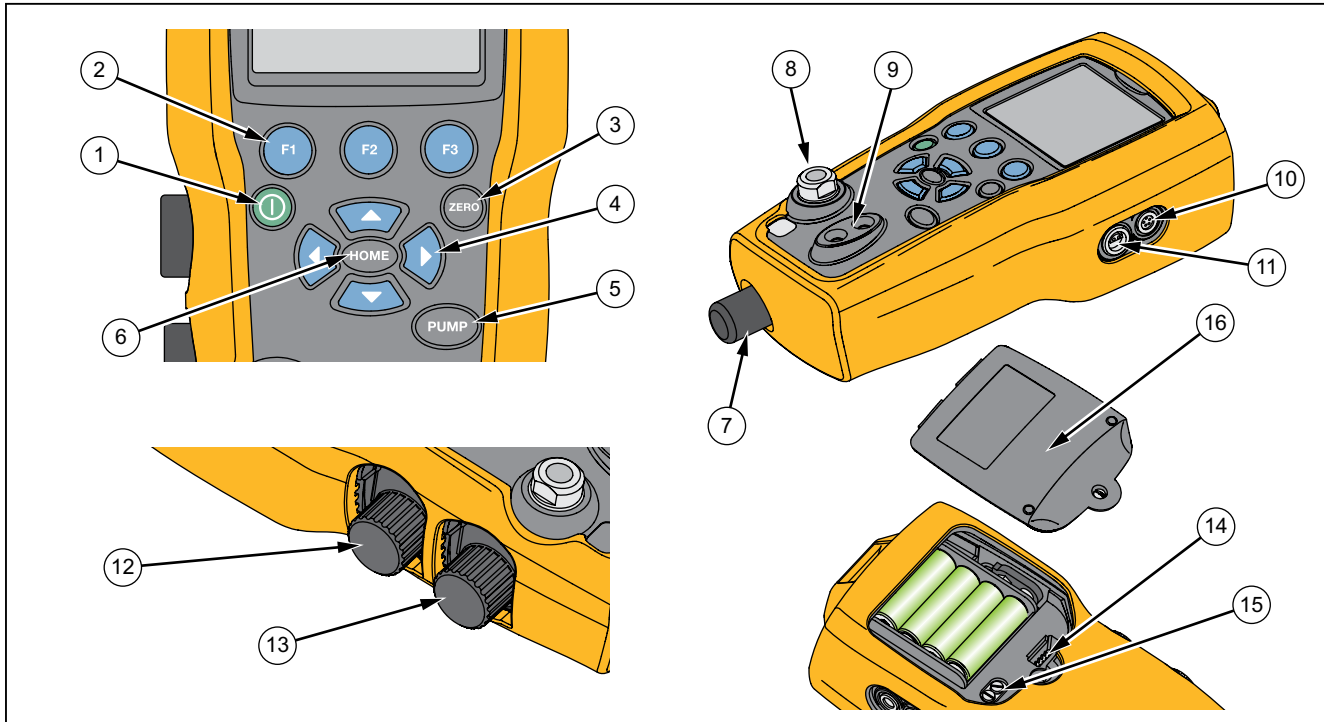

Figure 1. Product Interface

hix001.eps

Table 2. Product Features

Item	Description
①	Power button. Turns on and off the Product.
②	Three function buttons. Used to configure the Product. These buttons correspond to messages on the display.
③	Zero button. Zeros pressure measurements.
④	Arrow buttons. Controls mA source/sim. and sets pump and % error limits
⑤	Pump button. Runs the electric pump.
⑥	Home button. Returns to the main menu screen.
⑦	Pressure vernier adjust knob
⑧	Pressure source or measurement connector
⑨	Input terminals to measure current, volts and contact closure for switch test.
⑩	External pressure module connector
⑪	RTD probe connector
⑫	Pressure/Vacuum Selector
⑬	Vent
⑭	Firmware programming connector (for factory use only)
⑮	Pump clean-out valve
⑯	Battery door

Notes

When **Ⓢ** is pushed to turn on the Product, a short startup self-check routine is run. During that routine, the display shows the current firmware revision level, auto-shutdown status, and the range of the internal pressure sensor.

A maximum of 5 minutes warm-up is necessary for the product to reach rated accuracy. A longer warm-up period can be necessary for large changes in ambient temperature. See the “Zero Function Use” section for more about zeroing the pressure sensor displays. It is recommended that pressure ranges be zeroed each time the Product is started.

Display

The display has two main regions:

- The menu bar (located at the bottom of the screen) is used to access the Product menu.
- The main display has a maximum of three process measurement sub-regions.

These sub-regions will be referred to as the UPPER, MIDDLE and LOWER displays. Figure 2 shows the location of the different display fields while Table 3 describes them.

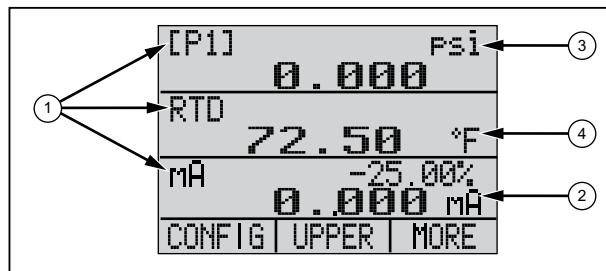

hix007.eps

Figure 2. Display

Table 3. Display Functions

Item Number	Name	Description
①	Primary Parameters	Shows what is being measured.
②	Span Indicator	Shows the percent of the 4 mA to 20 mA span. (For mA and mA loop functions only.)
③	Pressure Units	Shows one of 15 pressure units available for display.
④	Units	Shows the unit of measure for the display.

Language Selection

The Product user interface is available in three languages:

- English
- Norwegian
- German

To select a user interface language:

1. Turn the Product off.
2. Hold down **F1**, **HOME**, and **Ⓢ** simultaneously.
3. As the Product powers up, the display shows the language in the top left corner of the display. Repeat the procedure to show each subsequent language. Once the necessary language is shown, the Product user interface stays in that language until another language is chosen.

Home Menu Functionality

There are three options for the Home Menu:

- MENU
- Active Display (LOWER, MIDDLE, or UPPER)
- LIGHT



These options are shown across the bottom of the display.

From anywhere within the menu structure, push  to get back to the Home Menu.

Backlight Use

From the Home Menu, push  to toggle on and off the backlight. This is one of the few functions that cannot be controlled by the serial interface. There are no user-configuration settings for the backlight.

The MENU Option

Push  to access the Product Main Menus that start with CONFIG. Then push  and  to go to subsequent menus.

Main Menu Functionality

There are three options on the Main Menu, shown below:



hix021.eps

Set the Active Display

The active display is indicated by the center option on the Main Menu. Push **F2** from this menu to toggle the active display (UPPER, MIDDLE, or LOWER).

Set Active Display Parameters

To set the parameters of the active display, push **F1** from the Main Menu to go to the Active Display Configuration menu, shown below:



hix022.eps

Push **F1** to toggle through the selections for each parameter of the active display. The first parameter is Mode. Since voltage, current, and switch test modes all use the same jacks, two of these functions cannot be used at the same time. The ability to select some functions is limited based on what is already selected on a different display.

Push **F2** to change to the NEXT active display parameter. Only RTD and Pressure modes have a second parameter. RTDs can be read in Celsius or Fahrenheit. Pressures can be read in 15 engineering units.

With a single display, the modes below are available. Push **F1** to access each mode:

- [P1] = Pressure internal sensor
- [EXT] = Pressure with external pressure module
- [P1] ST = Switch Test with left side sensor
- [EXT] ST = Switch Test with external pressure module

Note

mA functions are only available on the lower display.

- mA measure = Milliamps measure without loop power
- mA w/24V = Milliamps measure with loop power
- mA source = Milliamps source
- mA sim = Milliamps simulate an external supply from the UUT

- VOLTS = Voltage Measure
- RTD = RTD Temperature Measurement (if a probe is connected)

Table 4 shows functions available at the same time. An X in a column shows that the mode in the active display is not available if the mode in that row is in operation on a different display.

Table 4. Mode Concurrency

		Current Display							
		[P1]	[EXT]	[P1] ST	[EXT] ST	mA	mA Loop	VOLTS	RTD
OTHER DISPLAYS	[P1]								
	[EXT]								
	[P1] ST			X	X	X	X	X	
	[EXT] ST			X	X	X	X	X	
	mA			X	X		X	X	
	mA Loop			X	X	X		X	
	Volts			X	X	X	X		
	RTD								
X = Not a valid mode									

Zero Function Use

If a pressure mode is selected and pressure is within the zero limit, the Product zeros the active display when **ZERO** is pushed. The zero limits are within 10 % of the full-scale range of the selected sensor. If the display shows "OL," the zero function will not operate.

Note

ZERO is only used for pressure.

Internal Sensor and Pressure Module (non-absolute)

When a sensor or module is selected on the active display, and **ZERO** is pushed, the Product subtracts the current reading from the output. The zero limits are within 10 % of the full-scale range of the selected sensor. If the display shows "OL," the zero function will not operate.

Absolute Pressure

When an absolute pressure range is selected on the active display, and **ZERO** is pushed, the Product prompts for the barometric reference pressure as in the screen below.



hix023.eps

Push **F2** and **F3** to use the on-screen arrows to record the correct barometric reference pressure. The sensor port should be open (vented) to atmosphere while this procedure is done.

Other Menu Controlled Functions

There are 12 “sub-main” menus that can be accessed with **F3** from the Main Menu. A “sub-main” menu contains three options. The first option is unique to the function. The second and third options of a “sub-main” menu are always the same. **F2** goes to the next “sub-main” menu. For the last “sub-main” menu, **F2** goes back to home.

Note

If a “sub-main” menu has subordinate menus, it will be referred to as {function} Main Menu. For example, the display contrast sub-main menu will be called the Contrast Main Menu. If not, it will be called the {function} menu.

The 12 sub-main menus are:

- CONFIG (Main Menu start point)
- %ERROR
- MINMAX
- CONTRAST
- LOCK CFG
- SETUPs
- AUTO OFF
- DISPLAY
- PROBE TYPE

- DAMP
- HART
- PUMP

Set the Contrast

From the Contrast main menu, push **F1** to access the Contrast Adjustment Menu. See the Contrast Main Menu below.



hix024.eps

Push **F2** and **F3** to adjust the display contrast to the necessary level. Push **F1** to finish the adjustment and go home as shown below.



hix025.eps

Lock and Unlock Configurations

Use the LOCK CFG or UNLOCK CFG options of the Configuration Lock Menu (CONFIG), shown below, to lock or unlock the display configuration.



hix026.eps

When the LOCK CFG option is pushed, the menu display goes home and the menu configuration option on the Main Menu is locked. All menus are locked with the exception of:

- Min Max menu
- Contrast Adjustment menu
- Configuration Lock menu

When the UNLOCK CFG option is selected, the configuration is unlocked and the menu display goes to the subsequent sub-main menu.

Save and Recall Setups

The Product automatically saves the current setup for recall at power up. Five setups can be accessed through the SETUPS menu. Select the SETUPS option from the Setups Main Menu shown below.



hix027.eps

Push **F1** to store a setup, **F2** to show the setup, or **F3** to do nothing and go to the Main Menu.



hix028.eps

If **F1** or **F2** is pushed, use the on-screen arrows, as shown below, to select the setup location. Then use **F1** to save the current setup into the selected location or **F2** to recall the setup stored in the selected location. The display menu automatically goes to the Main Menu.



hix029.eps



hix030.eps

Set Auto Off Parameters

The Product can be set to automatically power off after a chosen number of minutes. This function can also be disabled. To set the auto off parameters, push **F1** on the Auto Off Main Menu shown below.



hix031.eps

Push **F2** or **F3** to select the number of minutes before the Product turns off or scroll down to 0 to disable Auto Off as shown below.

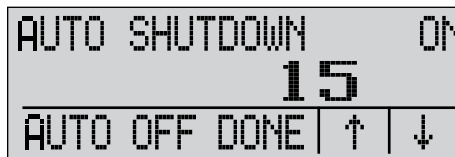

hix032.eps

Push **F1** to set the parameters and go to the main menu. The auto off time is reset when a key is pushed.

Activate and Deactivate a Display

From the Display Main Menu, push **F1** to access the Display Activation Menu.



hix033.eps

The {display} option can be used to select which display is active. The selected display and current on/off state are shown in the lower display as seen below.

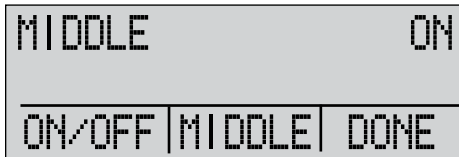

hix034.eps

Push **F3** to save the changes and go back to the Main Menu. When a display is deactivated, its configuration is saved. When the display is activated, its configuration is compared against the configurations of the other currently-active displays. If the configurations are in conflict, the recalled display configuration is changed to prevent conflict. If all three displays are deactivated, the LOWER display comes on automatically.

Set the RTD Probe Type

Push **F1** from the Probe Type Main Menu to access the RTD Probe selections.



hix035.eps

There are four probe types to select from:

- P100-385 (select this type for use with Fluke-720RTD probe accessory)
- P100-392
- P100-JIS
- CUSTOM

Push **F1** to select the necessary probe type (see the figure below). Push **F3** to store the change and go to the Main Menu.

Note

The default probe type is PT100-385.

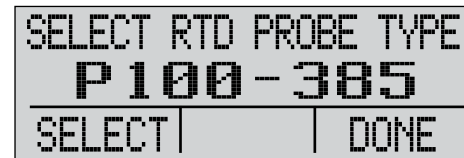

hix036.eps

Damping

Turn Damping on or off with the Damping menu selection. When damping is on, the Product shows a running average from ten measurements. The Product makes approximately three indications per second.

HART™ Resistor

An internal 250 Ω HART resistor can be enabled when the Product operates in the mA Measure-24 V mode. This lets a HART Communicator be connected across the mA terminals. It is not necessary to add an external resistor.

Note

When the HART resistor is on, the maximum load-driving capacity is 750 Ω .

Pump Limits

To prevent overpressure of sensitive devices, the maximum pressure (pump limit) can be set. When in this mode, use the arrow softkeys to set the maximum pressure.

Initial Setup and Basic Pressure Generation

The Product is supplied with a special low-volume calibration hose kit for faster pumping to pressure and quick pressure stabilization. The necessary “quick-fit” hose connectors and BSP adapter for non-NPT applications are also included. Fluke recommends that this type of hose be used to get the best performance from the Product. When the fittings are installed and the Product is connected to the unit under test (UUT), the Product is ready. Figure 3 shows a typical setup.

1. Before pressure is generated, make sure the Product is configured for the application. If necessary, review the “Calibrator Interface” section to select the correct configuration.
2. Make sure that the pressure vacuum knob is set for the correct function (+ for pressure and – for vacuum).

Pressure Calibrator Initial Setup and Basic Pressure Generation

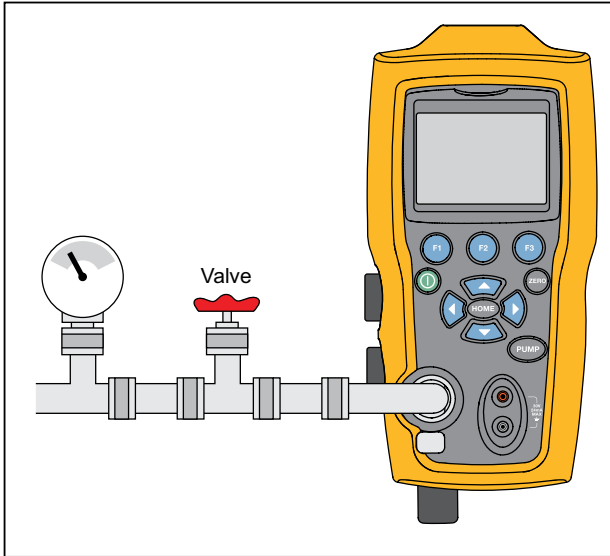

hix009.eps

Figure 3. Pump Connection

3. Close the vent knob.
4. Push the pump key and see the pressure (or vacuum) increase until the necessary pressure is reached.

Note

The pump motor speed will start slowly when pressure is low (<15 psi) for better control at low pressures.

5. Use the fine adjustment vernier to fine tune the pressure/vacuum indication as necessary.
6. To fully decrease or bleed off the pressure, slowly turn the vent knob to the open position. When this is done carefully, the pressure-bleed rate can be carefully controlled and this helps when taking down-scale pressure readings.

Electric Pump Considerations

The Product uses a small, battery-powered pneumatic pump that can quickly build rated high pressure. Because the pump has an upper pressure generation limit, there may be atmospheric conditions where it cannot go to full-scale pressure. High-altitude use (about 3000 ft or 1000 meters), or use at cold temperatures, can limit the pump to about 90 % of its rated pressure. In these cases, the vernier adjustment can be used to supply additional pressure necessary if full-scale pressure must be supplied.

In these situations, start the calibration with the vernier in the full counter-clockwise position and then, when the electric pump reaches its limit, turn the vernier clockwise. This will raise the pressure to set the necessary reading. See Figure 3.

Measure Pressure

To measure pressure, connect the Product with the correct fitting. Select a pressure setting for the display that is used. The Product has one internal sensor and many optional external sensors (EPMs) are available. Make sure to choose the sensor based on working pressures and accuracy.

⚠ Warning

To prevent personal injury:

- **Pressure sensors can be damaged and/or personnel injury can occur due to improper application of pressure. Refer to Table 9 for information on overpressure and burst pressure ratings. Vacuum should not be applied to any gauge pressure sensor. The Product display shows “OL” when an inappropriate pressure is applied. If “OL” is shown on any pressure display, the pressure should be reduced or vented immediately to prevent Product damage or possible personnel injury. “OL” is shown when the pressure exceeds 110 % of the nominal range of the sensor or when a vacuum in excess of 2 PSI is applied on gauge range sensors.**
- **Push  to zero the pressure sensor when vented to atmospheric pressure.**

Note

To ensure accuracy of the Product, the Product must be zeroed before a device is calibrated. See the “Zero Function Use” section.

Media Compatibility

The Product has a unique user-accessible valve cleaning port for easy pump service. See the “Clean the Valve Assembly” section for how to clean these valves. Make sure to only expose the Product to clean, dry gases.

Measure Pressure with External Modules

The Product has a digital interface to be used with external pressure modules. These modules are available in different ranges and types that include gauge, vacuum, differential, and absolute. Connect the modules to the interface and select [EXT] (external sensor). Since the interface between the Product and the module is digital, all accuracy and display resolution is derived from the module. See Figure 4.

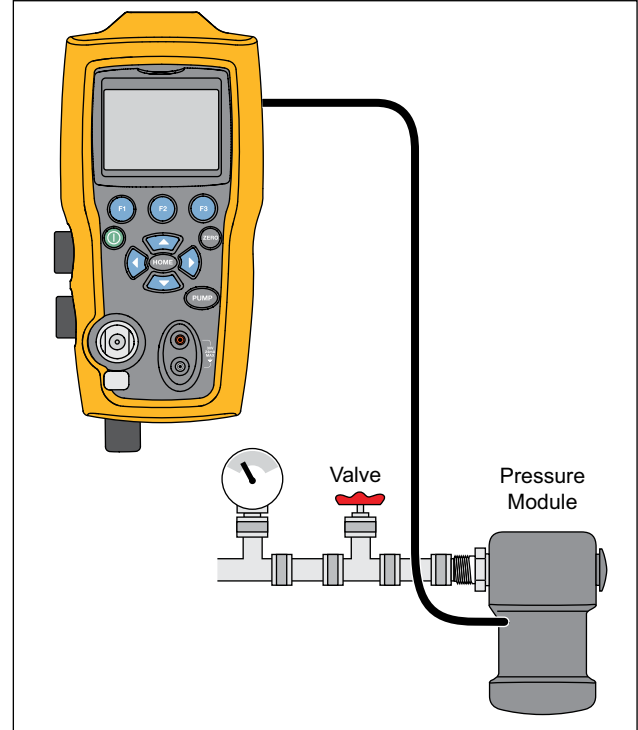

hix010.eps

Figure 4. Pressure with External Modules

Measure and Generate Current (4 mA to 20 mA)

Use the input terminals on the front of the Product to measure current, see Figure 5:

1. Select the mA function on the lower display and select MEASURE. Current is measured in mA and percentage of range. The range on the Product is set to 0 % at 4 mA and 100 % at 20 mA.

For example:

If the current measured is shown as 75 % then the mA value is 16 mA.

Note

The display shows “OL” when the measured current is more than the nominal range of current measurement (24 mA).

2. To source current, the same connections are used. From the configuration screen, select mA source or mA Sim-2W.

3. This function will only work on the LOWER screen. In the source mode, the Product supplies 0 mA to 24 mA with its own internal 24-volt supply, whereas in the simulate mode the Product acts as a two-wire transmitter and an external 24-volt supply is necessary.
4. Push any of the arrow softkeys to start the output mode and use the arrow softkeys to adjust the mA output. The function keys can also be used to step the output in either 25 % steps (4, 8, 12, 16, 20 mA) or 0 % (4 mA) and 100 % (20 mA). While in the mA output mode, if the loop is opened or the compliance is exceeded the display flashes “OL”.

Pressure Calibrator
Measure and Generate Current (4 mA to 20 mA)

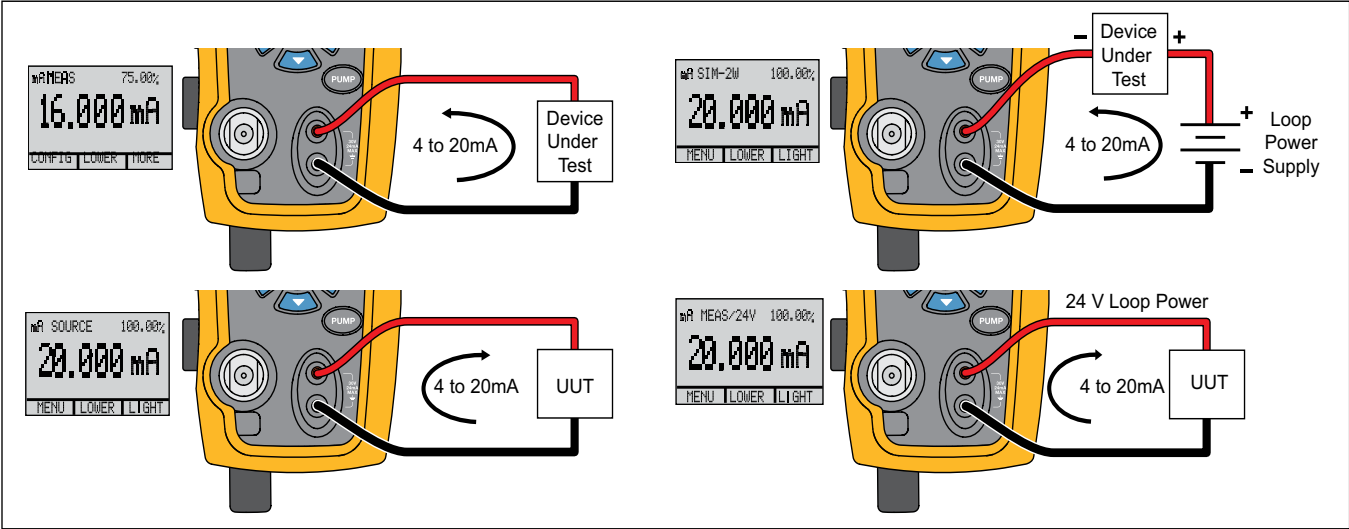

Figure 5. Measure and Generate Current

hix011.eps

Measure Voltage

To measure voltage, use the input terminals on the front of the Product. Select the volts function on one of the displays. The Product can measure a maximum of 30 V dc. See Figure 6.

Note

The display shows "OL" when the measured voltage is more than the nominal range of the voltage measurement (30 V).

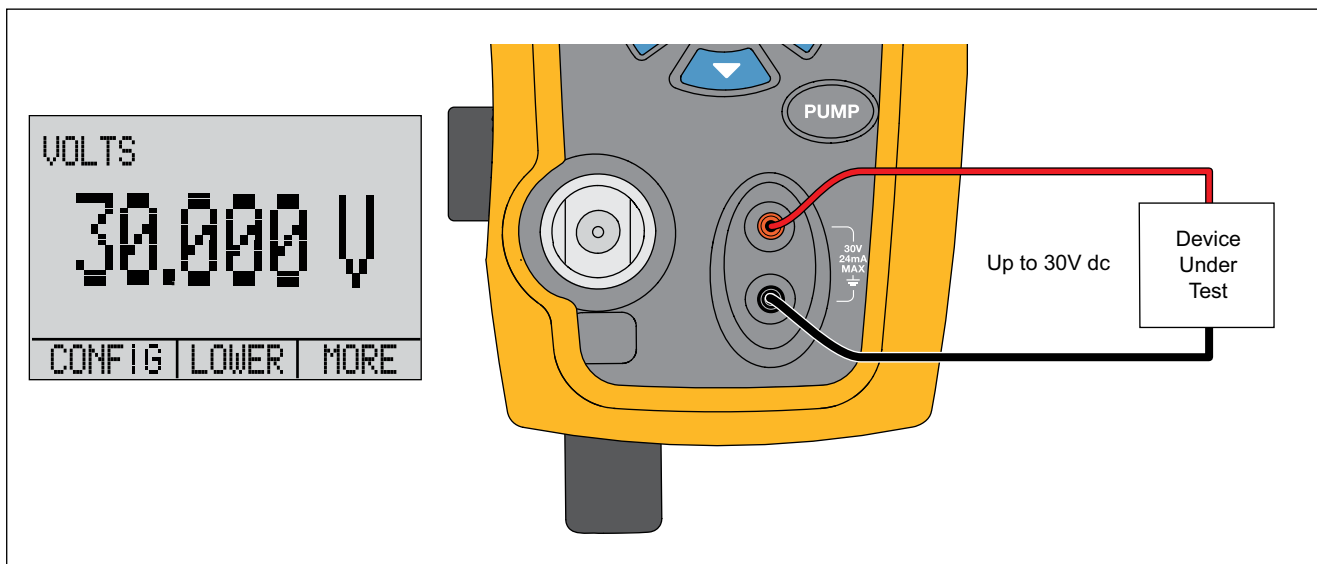

Figure 6. Voltage Measurement

hix015.eps

Measure Temperature with an RTD

To measure temperature with an RTD probe, select the RTD function on one of the displays. Make sure the correct probe type is selected. See the “Set the RTD Probe Type” section.

The standard probe has a 10-inch insertion depth with a ¼-inch diameter stainless steel sheath. See Figure 7.

Note

The factory default type is PT100-385 so if the Product is used with the Fluke 720 RTD Probe (pn 4366669), it is not necessary to set the probe type. Connect the probe to the Product and configure the display to read temperature.

The display shows “OL” when the measured temperature is outside the nominal measurement range of the RTD function (below -40 °C or above 150 °C). If a custom probe is used, enter the R0 and coefficients with the serial interface (see the “Remote Operation” section).

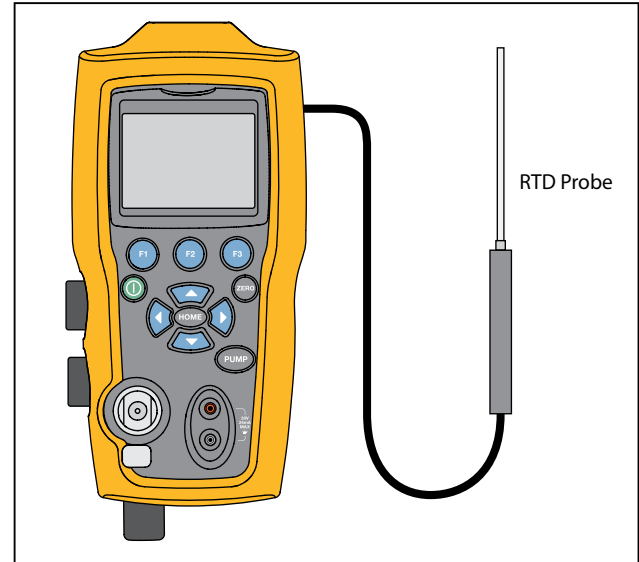

hix016.eps

Figure 7. Temperature Measurement with RTD Probe

Pressure Switch Test

Connect a pressure switch to the Product as shown in Figure 8.

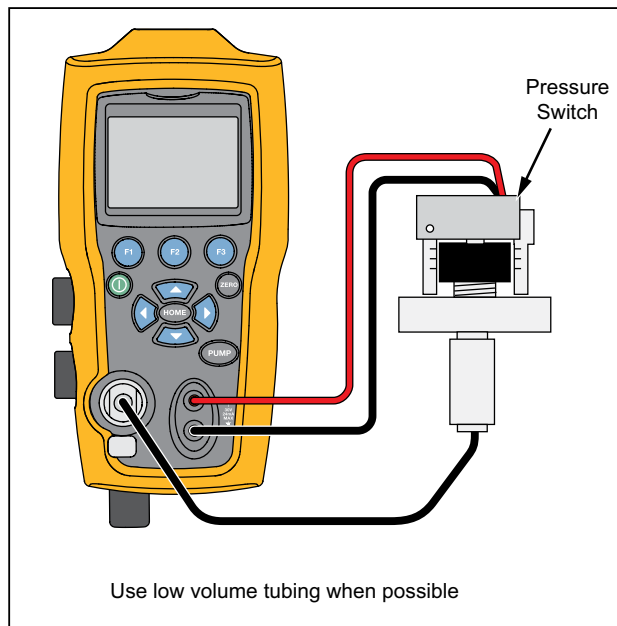

hix017.eps

Figure 8. Pressure Switch Connection

To do a pressure switch test:

1. Change the setup to Setup 4 (default switch test) listed under “Setups” in the MORE configuration menu choices. The upper display is set to [P1] ST, all other displays are off.

Note

The pressure switch test can be done with these functions: [P1] ST, or EXT ST.

Use low-volume tubing when possible.

2. Connect the Product to the switch with the pressure switch terminals to the pressure switch contacts (de-energized dry contacts). The polarity of the terminals does not matter. Connect the pump from the Product to the input of the pressure switch.
3. Make sure the vent on the pump is open.
4. Zero the Product if necessary.
5. Close the vent after the Product is zeroed. If a normally closed switch, the top of the display shows “CLOSE”.
6. Apply pressure with the pump slowly until the switch opens.

Note

In switch-test mode the display update rate is increased to help capture pressure input changes. Even with this enhanced sample rate, pressurization of the device under test should be done slowly to ensure accurate readings.

7. When the switch is open, "OPEN" is shown on the display. Bleed the pump slowly until the pressure switch closes.

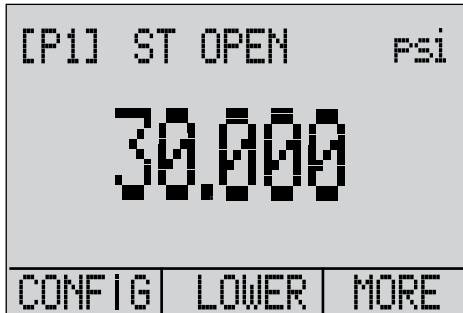

hix043.eps

At the top of the display "SW OPENED AT" and the pressure that the switch was opened at is shown as in the figure below.

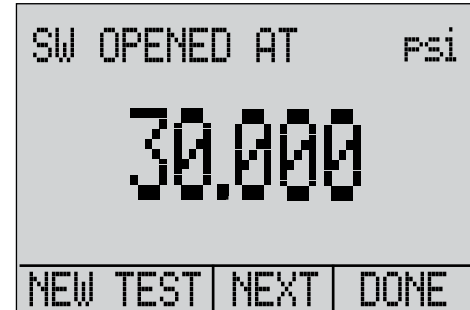

hix044.eps

8. Push the “NEXT” option to view when the switch closed, and the deadband as seen below.

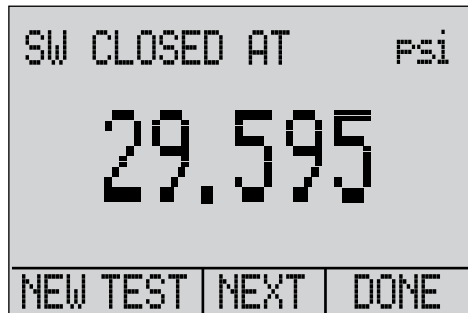

hix045.eps

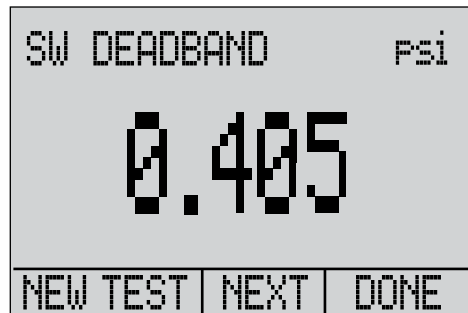

hix046.eps

9. Push **F1** to clear the data and do another test.
10. Push **F3** to end the test and return to the standard pressure setting.

Example:

[P1] ST will return to [P1].

Note

The previous example uses a normally-closed switch. The basic procedure is the same for a normally-open switch. The display reads “OPEN” instead of “CLOSE”.

Transmitter Calibration

mA Input Function

The mA input function reads back the 4 mA to 20 mA output from the device being calibrated. This can be done in one of two ways:

1. Passively – Where the device under test directly regulates or generates 4 mA to 20 mA and can be read by the Product.

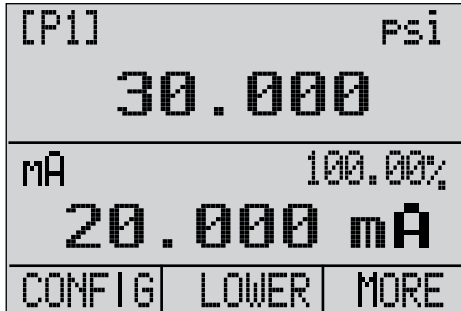

hix047.eps

2. Actively – Where the Product supplies 24 V dc loop power to the device under test to power the device while reading the resulting 4 mA to 20 mA signal.

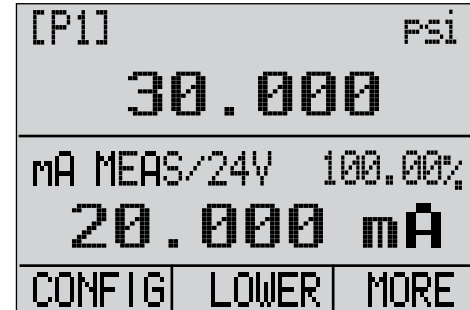

hix048.eps

Pressure-to-Current Transmitter Calibration

To calibrate a pressure-to-current transmitter (P/I):

1. Connect the Product and the pump to the transmitter. See Figure 9.
2. Apply pressure with the pump.
3. Measure the current output of the transmitter.
4. Ensure the reading is correct. If not, adjust the transmitter as necessary.

Note

Use low-volume tubing when possible.

Percent Error Function

The Product features a unique function which can calculate pressure vs. milliamp error as a percentage of the 4 mA to 20 mA loop span. The percent error mode uses all three screens and has a unique menu structure. It simultaneously shows pressure, mA, and percent error. See Figure 10.

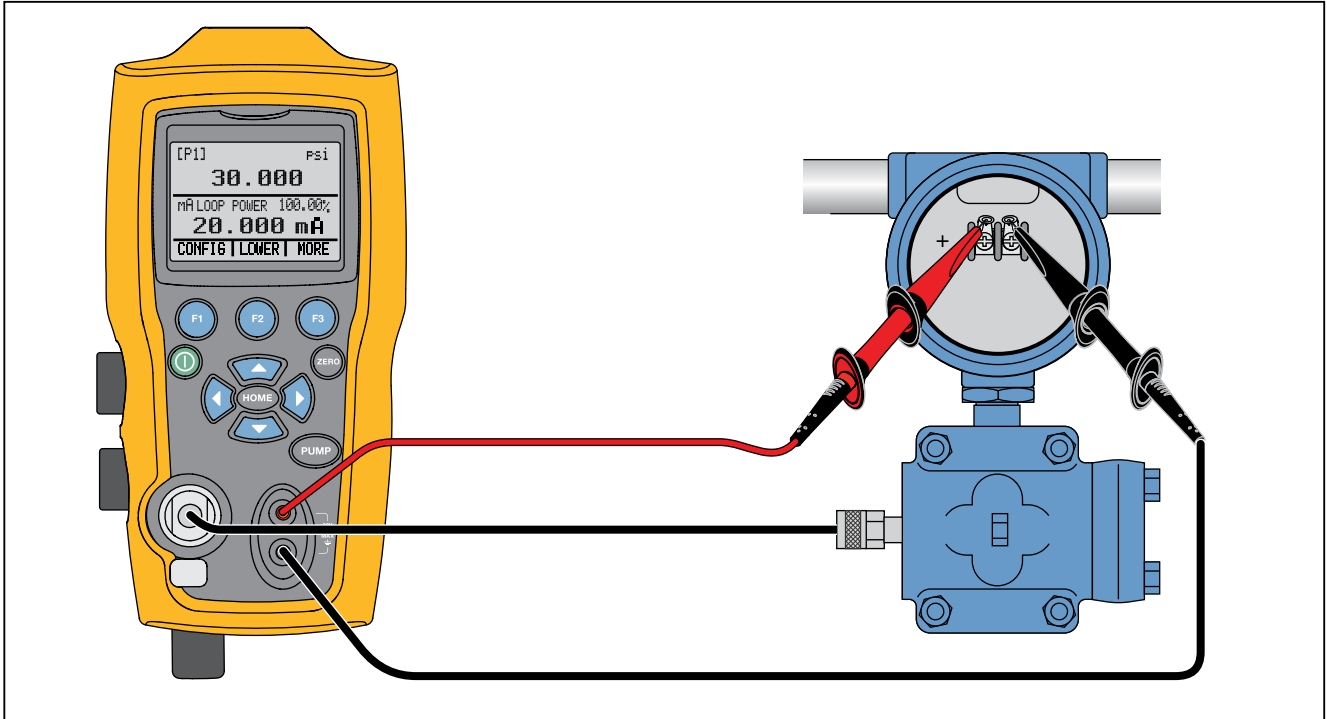

hix018.eps

Figure 9. Pressure-to-Current Transmitter Connections

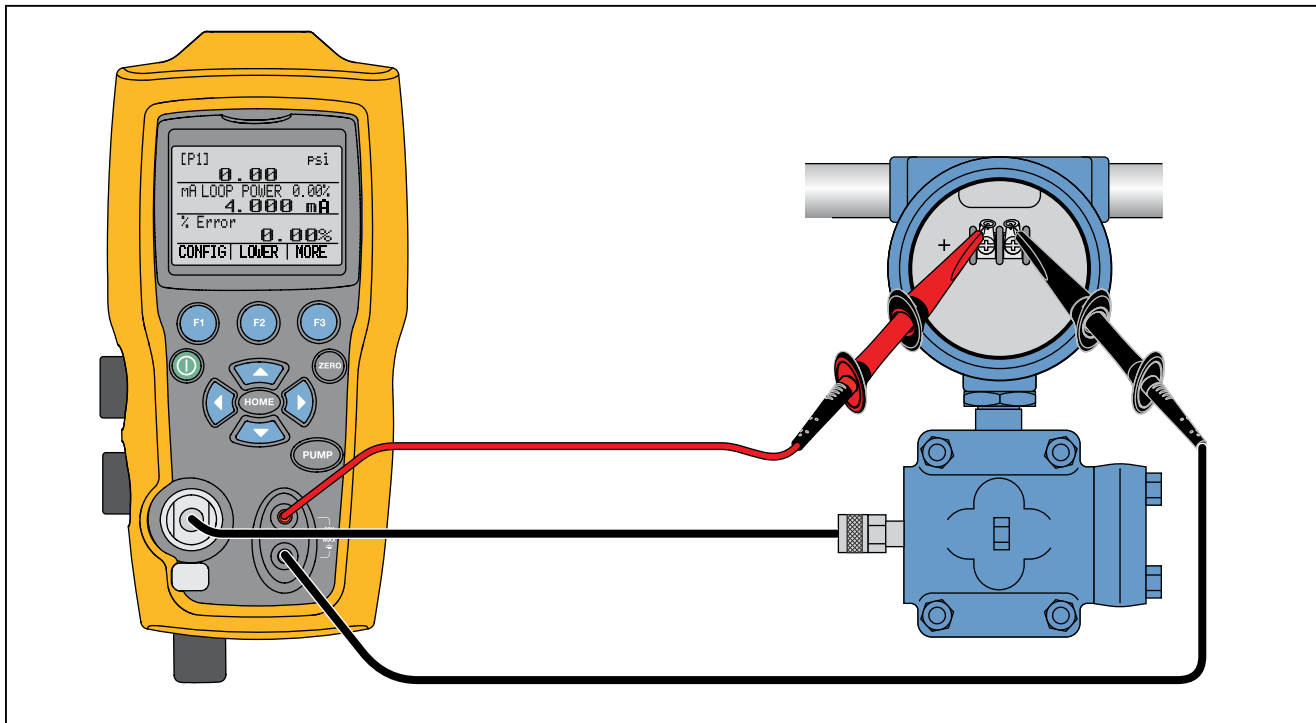

Figure 10. Percent Error Function Connection

hix019.eps

Example:

A pressure transmitter under test is 30 psi (2 Bar) Full-Scale and regulates a corresponding 4 mA to 20 mA signal. Program a 0 psi to 30 psi pressure span into the Product and the Product calculates and shows the deviation or %Error from the expected 4 mA to 20 mA output. This eliminates the need for manual calculations and helps when it is difficult to set an exact pressure with an external pump.

To use the %ERROR function:

1. From the Main Menu, push **F1**.
2. Push **F3**.
3. Push **F1** to start the %ERROR option.
4. Push **F1** to configure the option. The first option sets the Port.
5. Push **F1** to scroll through the port choices.
6. When finished, push **F2**.



hix049.eps

7. Loop Power can be toggled on/off as seen below. Push **F2** when done.

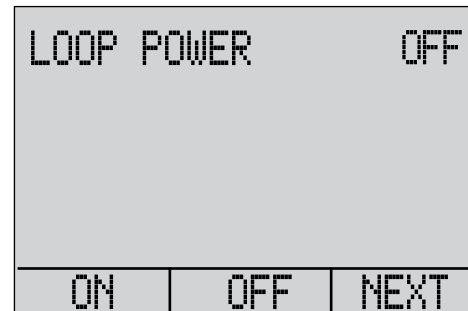

hix050.eps

8. Push **F1** to toggle through the unit options, and push **F2** to move on.

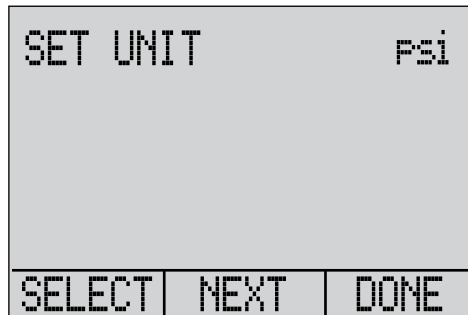

hix051.eps

9. Use the arrow keys to set the 100 % point of the desired pressure range, select DONE SET when finished.



hix052.eps

10. Use the arrow keys to set 0 % point and select DONE SET when finished and the % ERROR mode will be ready to use.

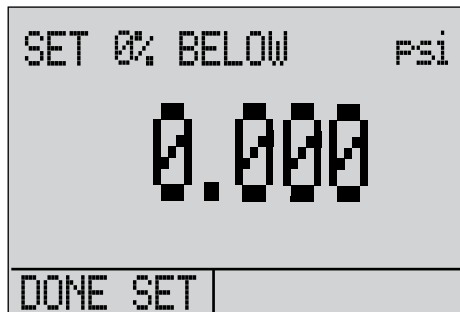

hix053.eps

Note

The 0 % and 100 % point will be saved in non-volatile memory until they are changed again by the user for the internal sensors, and external pressure modules. When an external module is used, the 0 % and 100 % are set to low and full scale of the module until the user changes it, or if it was previously saved.

[P1]	Psi	
0.0000		
mA measure	-25.00%	
0.000 mA		
% Error	-25.00%	
CONFIG	LIGHT	EXIT

hix054.eps

Minimum and Maximum Storage Capability

The Product has a min/max feature to capture the minimum and maximum values of any displayed parameter.

Step through the menu options to access the min/max function. "MIN/MAX" is shown on the display above **F1**. Push **F1** to toggle the display through the min/max values that are stored in the min/max registers. These readings are live so that the new min/max values will be recorded while in this mode.

[P1]	Psi	
-0.003		
mA	0.00%	
4.000 mA		
MIN	CLEAR	DONE

hix055.eps

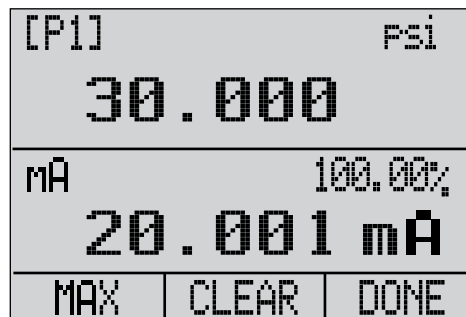

hix056.eps

To reset the min/max registers, push **F2** for "CLEAR".
These registers are also cleared at power-up or when the configuration is changed.

Factory Setups

The Product is loaded with five commonly used factory setups. To access these SETUPS, select from the MORE configurations options. These setups are shown below.

Note

Any of these setups can be changed and saved.

Setup 1: The upper display is set to [P1] mode and the lower is set to mA, middle is off.

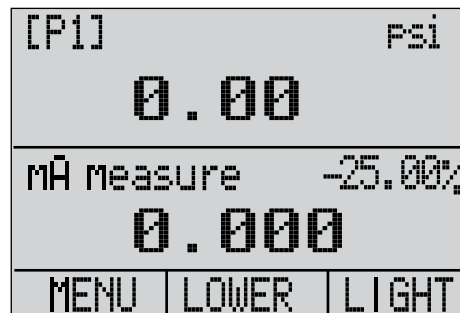

hix057.eps

Setup 2: The upper display is set to [P1] mode and the lower is set to RTD, middle is off.

[P1]		Psi
0.00		
RTD		
23.50 °C		
MENU	LOWER	LIGHT

hix058.eps

Setup 3: The upper display is set to [P1] mode and the middle is set to RTD, lower is mA.

[P1]		Psi
0.00		
RTD		
23.50 °C		
mA measure		-25.00%
0.000		
MENU	LOWER	LIGHT

hix059.eps

Setup 4: The lower display is set to [P1] switch test, the other displays are off.

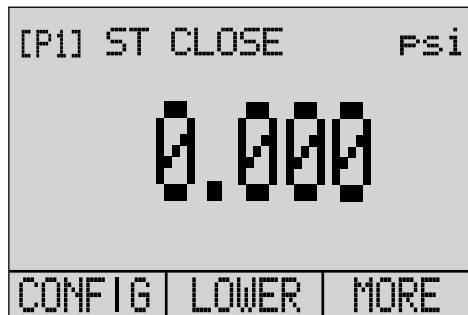

hix062.eps

Setup 5: The upper display is set to [P1], the middle display is set to [EXT] and the lower display is set to RTD.

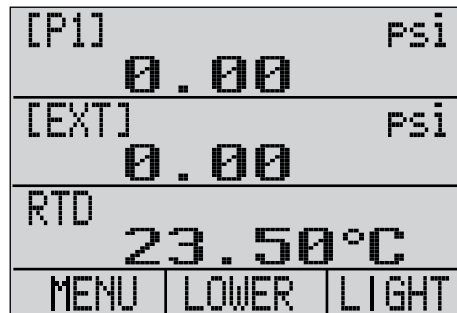

hix060.eps

Custody Transfer / Flow Calibration

The Product is ideal for flow computer calibration. Every manufacturer of flow computers has a different calibration procedure, but most call for calibration of three parameters: static pressure, differential pressure and temperature. To facilitate these measurements, recall setup #5 on the Product.

1. Connect the Product to the static and differential pressures. ([P1], EXT) Then connect the RTD sensor to the Product.
2. With the reading of the RTD, static, and differential pressures, make sure the flow computer has the correct reading. If not, adjust the flow computer as necessary.

Remote Operation

Remote Interface

The Product can be remotely controlled with a PC terminal or by a computer program that runs the Product in an automated system. It uses an RS-232 serial port connection for remote operation.

Note

To use the remote control option, a custom miniature circular to USB interface cable, PN 4401616 must be purchased separately. To contact Fluke refer to the "Contact Fluke" section.

With this connection the user can write programs on the PC, with Windows languages like Visual Basic to operate the Product, or use a terminal program similar to Hyper Terminal, to enter single commands. Typical RS-232 remote configurations are shown in Figure 11.

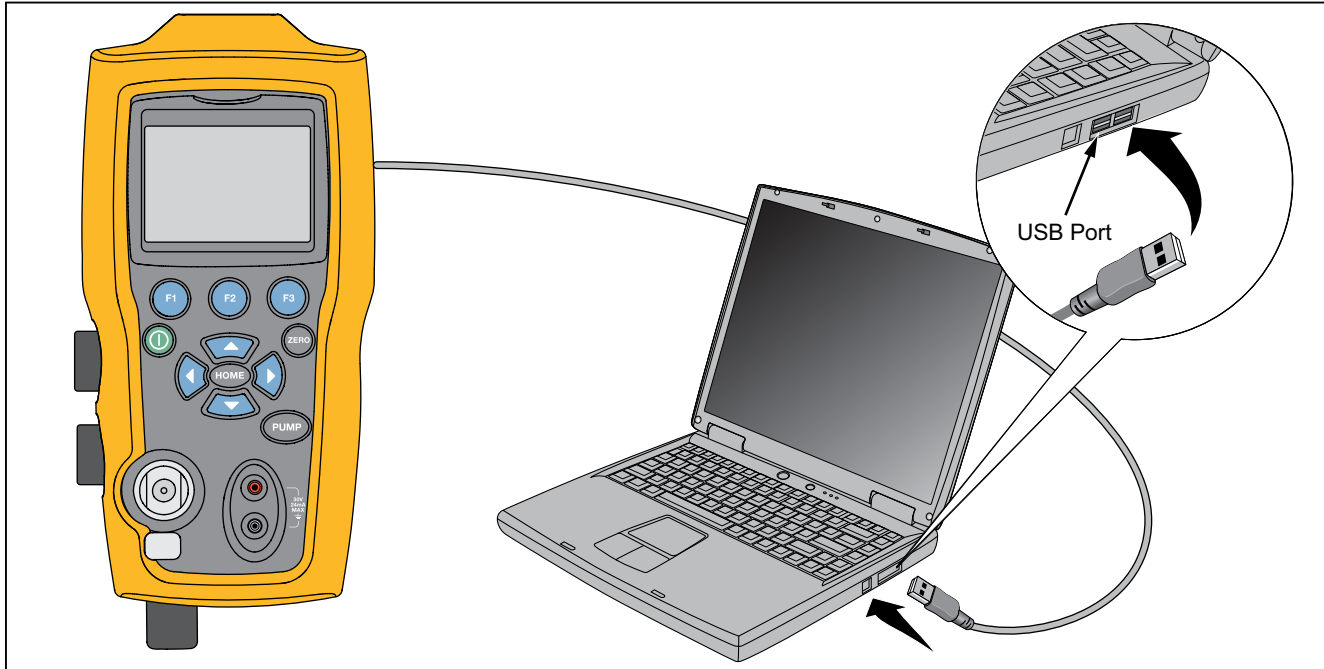

hix020.eps

Figure 11. Typical Remote Connection

Set up the RS-232 Port for Remote Control

Note

The RS-232 connection cable should not exceed 15 m unless the load capacitance measured at connection points is less than 2500 pF.

Serial parameter values:

- 9600 baud
- 8 data bits
- 1 stop bit
- no parity
- Xon/Xoff
- EOL (End of Line) character or CR (Carriage Return) or both

Note

To use the remote control option, a custom miniature circular to USB interface cable, PN 4401616, must be purchased separately.

Connect the Product to the computer, attach the miniature circular connector end of the cable to the pressure module port on the right side of the Product and the USB connector to the computer. The Product should be turned off prior to making the connection and then turned on.

For remote operation of the Product, connect it to a COM port on the PC as in Figure 11. Use a terminal emulator program and follow the subsequent procedure:

1. Start the terminal emulator program.
2. Select New Connection.
3. For Name enter "Fluke 719PRO". Select the serial port that the Product is connected to.
4. Enter the above information for port settings.
5. Select ASCII setup from File/Properties/Settings and mark these choices:
 - Echo typed characters locally
 - Wrap lines that exceed terminal width
6. Select Ok.
7. To see if the port works enter *IDN?. This command will return information on the Product.

Change Between Remote and Local Operation

There are three modes of operation of the Product: Local, Remote, and Remote with Lockout. Local mode is the default mode. Commands may be entered with the keypad on the Product or with a computer. In Remote mode the keypad is disabled and commands may only be entered with a computer. If [GO TO LOCAL] is chosen from the display menu, the Product restores keypad operation. In Remote with Lockout, the keypad cannot be used.

To switch modes:

1. To enable Remote mode, enter the serial command REMOTE at the computer terminal.
2. To enable Remote with Lockout, enter "REMOTE LOCKOUT" in either order.
3. To switch back to local operation enter LOCAL at the terminal. This command also turns off LOCKOUT if it is on. For more information on commands, refer to the "Remote Commands" section.

Command Use and Types

Refer to the "Remote Commands" section for all available commands. The Product may be controlled by commands and queries. All commands may be entered with upper or lower case. The commands are divided into the categories listed below:

Calibrator Commands

Only the Product uses these commands. For example:

VAL?

asks for the values displayed on the Product display.

Common Commands

Standard commands used by most devices. These commands always begin with an "*" .

For example:

*IDN?

tells the Product to return its identification.

Query Commands

Commands that ask for information, they always end with a "?". For example:

FUNC?

returns the current modes of the Product displays.

Compound Commands

Commands that contain more than one command on one line. For example:

RTD_TYPE PT385_100;RTD_TYPE?

Sets the Product to RTD type PT385_100 and queries it to verify. It will return:

PT385_100

Character Processing

The data entered into the Product is processed as follows:

- ASCII characters are discarded if their decimal equivalent is less than 32 (space), except 10 (LF) and 13 (CR):
- Data is taken as 7-bit ASCII
- The most significant data bit is ignored.
- Upper or lower case is acceptable.

Response Data Types

The data returned by the Product can be divided into four types:

Integer

For most computers and controllers they are decimal numbers that range from -32768 to 32768. For example:

FAULT? could return 110

Refer to Table 8 for more information on error codes.

Floating

Floating numbers have up to 15 significant figures and exponents. For example:

CPRT_COEFA? returns 3.908300E-03

Character Response Data (CRD)

Data returned as keywords. For example:

RTD_TYPE? returns PT385_100

Indefinite ASCII (IAD)

Any ASCII characters followed by a terminator. For example:

*IDN? returns FLUKE,719PRO,1234567,1.00

Calibrator Status

Error Queue

If an error occurs due to invalid input or buffer overflow, its error code is sent to the error queue. The error code can be read from the queue with the command FAULT?. The error queue holds 15 error codes. When it is empty, FAULT? returns 0. The error queue is cleared when power is reset or when the clear command *CLS is entered.

Input Buffer

The Product stores all received data in the input buffer. The buffer holds 250 characters. The characters are processed on a first in, first out basis.

Remote Commands and Error Codes

Tables 5, 6, 7, and 8 list all commands, and their descriptions, that are accepted by the Product.

Table 5. Common Commands

Command	Description
*CLS	(Clear status) Clears the error queue.
*IDN?	Identification query. Returns the manufacturer, model number, serial number, and firmware revision level of the Product.
*RST	Resets the Product to the power up state.

Table 6. Calibrator Commands

Command	Description
CPRT_COEFA	Sets the custom RTD coefficient A
CPRT_COEFA?	Returns the custom RTD coefficient A
CPRT_COEFB	Sets the custom RTD coefficient B
CPRT_COEFB?	Returns the custom RTD coefficient B
CPRT_COEFC	Sets the custom RTD coefficient C
CPRT_COEFC?	Returns the custom RTD coefficient C
CPRT_R0	Sets the custom RTD R0 resistance
CPRT_R0?	Returns the custom RTD R0 resistance

Command	Description
DAMP	Turns Damp on or off.
DAMP?	Returns if DAMP is on/off
DISPLAY	Turns on/off the displays specified in the command
DISPLAY?	Returns which displays are on/off
ERROR_LOOP	Turns loop power on or off in percent error mode
ERROR_LOOP?	Returns the current state of loop power in error mode
ERROR_MODE	Turns percent error mode on or off
ERROR_MODE?	Returns whether percent error mode is on or off
ERROR_PORT	Set the pressure port for percent error mode
ERROR_PORT?	Returns the pressure port for percent error mode

Command	Description
FAULT?	Returns the most recent error code
FUNC	Sets the display mode as specified in the command
FUNC?	Returns the current mode of the upper, middle, and lower display
HART_ON	Turns the hart resistor on.
HART_OFF	Turns the hart resistor off.
HART?	Returns the current state of the Hart resistor.
HI_ERR	Sets the 100 % of span limit for percent error mode
HI_ERR?	Returns the 100 % of span limit for percent error mode
IO_STATE	Set the Product's mA state.
IO_STATE?	Return the Product's mA state.

Pressure Calibrator
Remote Operation

Command	Description
LOCAL	Returns user to manual operation of the Product
LOCKOUT	Locks out the keypad of the Product in remote operation
LO_ERR	Sets the 0 % of span limit for percent error mode
LO_ERR?	Returns the 0 % of span limit for percent error mode
MOTOR_ON	Turns the motor on.
MOTOR_OFF	Turns the motor off.
MOTOR?	Returns the current state of the Hart resistor
OHMS?	Returns ohms value measured from the RTD
OUT	Set the Product to output the requested current.
OUT?	Returns the value of the current being simulated.

Command	Description
PRES_UNIT	Set the pressure unit for the indicated display
PRES_UNIT?	Returns the pressure from the indicated display
PUMP_LIMIT	Sets the approximate value at which the pump will turn off.
PUMP_LIMIT?	Returns the approximate value at which the pump will turn off.
REMOTE	Puts the Product in remote mode
RTD_TYPE	Sets the RTD type
RTD_TYPE?	Returns the RTD type
SIM	Set the Product to simulate the requested current.

Command	Description
SIM?	Returns the value of the current being simulated.
ST_CLOSE?	Returns pressure value at which the switch closed
ST_DEAD?	Returns pressure value of the deadband of the switch
ST_OPEN?	Returns pressure value at which the switch opened
ST_START	Starts a switch test
TEMP_UNIT	Set the RTD to read in °F or °C on the indicated display
TEMP_UNIT?	Returns the unit the RTD is set to
VAL?	Returns the measured values
ZERO_MEAS	Zeros the pressure module
ZERO_MEAS?	Returns the zero offset of the pressure module

Table 7. Parameter Units

Units	Meaning
CEL	Temperature in degrees Celsius
CUSTOM	Custom RTD type
DCI	Current function
DCV	Voltage measure function
EXT	External pressure measurement function
FAR	Temperature in degrees Fahrenheit
LOWER	Designates Lower display
MA	Milliamps of current
MEASURE	Measure state
MEAS_LOOP	Measure with loop power state
MIDDLE	Designates Middle display
OHM	Resistance in ohms

Units	Meaning
PCT_ERR	Percent Error
PERCENT	Percent
PT385_100	100 Ohm 385 Platinum RTD type
PT392_100	100 Ohm 392 Platinum RTD type
PTJIS_100	100 Ohm JIS Platinum RTD type
P1	P1 pressure measurement function
RTD	Temperature measure function
ST_P1	Switchtest mode with P1
ST_EXT	Switchtest mode with external module
SOURCE	Source state
SIM	Simulate state
UPPER	Designates Upper display
V	Voltage

Table 8. Error Codes

Error Number	Error Description
100	A non-numeric entry was received where it should be a numeric entry
101	Too many digits entered
102	Invalid units or parameter value received
103	Entry is above the upper limit of the allowable range
104	Entry is below the lower limit of the allowable range
105	A required command parameter was missing
106	An invalid command parameter was received
107	Pressure not selected

Error Number	Error Description
108	Invalid sensor type
109	Pressure module not connected
110	An unknown command was received
111	Bad Parameter received
112	The serial input buffer overflowed
113	Too many entries in the command line
114	The serial output buffer overflowed

Enter Commands

Commands for the Product may be entered in upper or lower case. There is at least one space required between the command and parameter, all other spaces are optional. Almost all commands for the Product are sequential. Any overlapped commands are indicated as such. This section briefly explains each of the commands and describe their general use, which include any parameters that may be entered with the command as well as what the output of the command is.

Common Commands

***CLS**

Clears the error queue. Also terminates all pending operations. When programs are written, use before each procedure to avoid buffer overflow.

***IDN?**

Returns the manufacturer, model number, serial number, and firmware revision of the Product. For example:

*IDN? returns FLUKE,719PRO,1234567,1.00

Calibrator Commands

CPRT_COEFA

Use this command to enter a custom RTD into the Product. The numeric value entered after the command is set as the first coefficient of the polynomial used by the custom RTD.

For example:

CPRT_COEFA 3.908300E-03 enters 3.908300e-3 as coefficient A.

CPRT_COEFA?

Returns the number that was entered for the first coefficient of the polynomial used in the custom RTD. With the example above, CPRT_COEFA? returns:

3.908300E-03

CPRT_COEFB

This command is used to enter a custom RTD into the Product. The numeric value entered after the command will be set as the second coefficient of the polynomial used by the custom RTD.

For example:

CPRT_COEFB -5.774999E-07 enters -5.774999E-07 as coefficient B.

CPRT_COEFB?

Returns the number which was entered for the second coefficient of the polynomial used in the custom RTD. With the example above, CPRT_COEFB? returns:

-5.774999E-07

CPRT_COEFC

This command is used to enter a custom RTD into the Product. The numeric value entered after the command will be set as the first coefficient of the polynomial used by the custom RTD.

For example:

CPRT_COEFC -4.183000E-12 enters -4.183000E-12 as coefficient C.

CPRT_COEFC?

Returns the number that was entered for the third coefficient of the polynomial used in the custom RTD. The example above CPRT_COEFC? returns:

-4.183000E-12

CPRT_R0

Sets the 0 ° resistance, R0, in the custom RTD. The value must be entered with a unit label. Refer to Table for assistance.

For example:

CPRT_R0 100 OHM sets R0 to 100 Ω.

CPRT_R0?

Returns the value for the resistance in custom RTD. The above example returns:

1.000000E+02, OHM

DAMP

Turns on or off the damping function.

For example:

If DAMP ON is sent, this will turn on the damping function.

DAMP?

Returns the current state of the damping function.

For example:

If DAMP? is sent, it will return ON if the damping function is on.

DISPLAY

Turns on or off the indicated display.

For example:

If DISPLAY LOWER is sent ON, this will turn on the lower display.

DISPLAY?

Returns the current state of the each of the displays.

For example:

If DISPLAY? is sent, it will return ON, ON, ON if the all the displays are on.

FAULT?

Returns the error code number of an error that has occurred. The command may be entered when the previous command did not do what it was meant to do.

For example, if a value for current output is entered that is bigger than the supported range (0 mA -24 mA) `FAULT?` returns:

103 which is the code number for an entry over range.

Refer to Tables 5, 6, 7, and 8 for more information on error code numbers.

ERROR_LOOP

Turns on or off loop power in percent error mode.

For example:

To set loop power on, send `ERROR_LOOP ON`.

ERROR_LOOP?

Returns the current state of loop power in percent error mode.

For example:

If `ERROR_LOOP?` is sent, it will return ON if loop power is on in error mode.

ERROR_MODE

Turns percent error mode on and off.

For example:

To turn on percent error mode, send `ERROR_MODE ON`.

ERROR_MODE?

Returns the current state of percent error mode.

For example:

If `ERROR_MODE?` is sent, it will return ON if the Product is in percent error mode.

ERROR_PORT

Sets the pressure port for percent error.

For example:

To set the pressure port for percent error to [P1], send
`ERROR_PORT P1.`

ERROR_PORT?

Returns the current pressure port for percent error mode.

For example:

If `ERROR_PORT?` is sent, it will return P1 if the pressure port in percent error is [P1].

FUNC

Sets the display indicated in argument one to the function indicated in argument 2.

For example:

To set the lower display to RTD mode send `FUNC LOWER,RTD.`

FUNC?

Returns the current mode of all displays. For example, if the Product is set to [P2] ST on the upper display, [P1] on the middle, and RTD on the lower, `FUNC?` returns:

`ST_P2,P1,RTD`

HART_ON

Turns on the Hart resistor.

HART_OFF

Turns off the Hart resistor.

HART?

Returns the state of the Hart resistor.

For example:

If the Hart resistor was on `HART?` returns ON.

HI_ERR

Sets the 100 % point for the percent error mode calculation in the current engineering units.

For example:

To set the 100 % point to 100 psi, send `HI_ERR 100.`

HI_ERR?

Returns the 100 % point for the percent error mode calculation.

For example:

If the 100 % point is set to 100 psi, `HI_ERR?` returns `1.000000E+02, PSI.`

IO_STATE

Sets the input/output/simulate state of the mA function of the Product. Does not put the Product into mA if it is not in mA already.

For example:

If the Product is in mA simulate mode, `IO_STATE MEASURE` would put it in measure mode.

IO_STATE?

Returns the input/output/simulate state of the mA function of the Product.

For example:

If the Product was in mA simulate mode `IO_STATE?` would return SIM.

LOCAL

Restores the Product to local operation if it was in remote mode. Also clears LOCKOUT if the Product was in lockout mode.

LOCKOUT

Send this command to set the lockout state, when the unit is in REMOTE or if it goes to remote it prohibits use of the keypad. The lockout state can only be cleared by if the LOCAL command is sent.

LO_ERR

Sets the 0 % point for the percent error mode calculation in the current engineering units.

For example:

To set the 0 % point to 20 psi, send `LO_ERR 20`.

LO_ERR?

Returns the 0 % point for the percent error mode calculation.

For example:

If the 0 % point is set to 20 psi, `LO_ERR?` returns 2.000000E+01, PSI.

MOTOR_ON

Turns on the motor.

MOTOR_OFF

Turns off the motor.

MOTOR?

Returns the state of the motor.

For example:

If the motor was on, `MOTOR?` returns ON.

OHMS?

Returns the raw ohm value from the RTD.

For example:

If when a P100-385 is measured at 0 °C, `OHMS?` returns 1.000000E+02, OHM.

OUT

This command also switches the Product into mA output mode. A number and a unit must be entered after the command.

For example:

`OUT 5 MA` sets the current output at 5 mA

OUT?

Returns the output of the Product.

With the above example, `OUT?` returns 5.000000E-03, A

PRES_UNIT

Used to set the pressure unit for the indicated display.

For example:

To set the pressure unit to psi on the lower display, send `PRES_UNIT LOWER, PSI`.

PRES_UNIT?

Returns the pressure unit used when pressure is measured for each of the 3 displays.

PUMP_LIMIT

Sets the approximate pressure in psi at which the pump will turn off.

For example:

`PUMP_LIMIT 50` sets the approximate value that the pump will shut off at to 50 psi

PUMP_LIMIT?

Returns the pump limit. The above example with PUMP_LIMIT? returns:

50.000

REMOTE

Puts the Product into remote mode. From the remote mode, the keypad can be used to get back to local mode unless the command LOCKOUT was entered before REMOTE. Then the keypad is locked out, and the LOCAL command must be sent to get back to local operation.

RTD_TYPE

Sets the RTD type. The subsequent list shows RTD types the way they should be entered after the command:

PT385_100; PT392_100; PTJIS_100; CUSTOM;

For Example:

RTD_TYPE PT385_100 sets RTD type to PT100-385

RTD_TYPE?

Returns the RTD type.

For example:

If the RTD type is PT385_100, RTD_TYPE?, PT100_385 is returned.

SIM

Sets the output for current simulation. This command also switches the Product into mA simulation mode. A number and a unit must be entered after the command.

For example:

SIM 5 MA sets the current simulation at 5 mA

SIM?

Returns the output of the current simulation. With the example above, the output would be: 5.000000E-03, A

ST_START

Starts a switch test.

ST_CLOSE?

Returns the pressure that the switch closed at in the current pressure units.

ST_OPEN?

Returns the pressure that the switch opened at in the current pressure units.

ST_DEAD?

Returns deadband of the switch in the current pressure units.

TEMP_UNIT

This command is used to set the temperature unit used when temperature is measured.

The first argument indicates which display to apply the change to. The second argument is the unit, either CEL for Celsius or FAR for Fahrenheit.

For example:

To set the temperature unit to Fahrenheit on the lower display, send `TEMP_UNIT LOWER, FAR`.

TEMP_UNIT?

Returns the temperature unit, (CEL or FAR) used when RTDs are measured for each of the 3 displays.

VAL?

Returns the value of any measurement on the upper and lower display. For example, if the upper display shows 5 mA, and the lower display shows 10 V, then `VAL?` returns:

5.000000E-03, A, 1.000000E+01, V

ZERO_MEAS

Zeros the attached pressure module. Enter the value zeroed in PSI after the command when an absolute pressure module is zeroed.

ZERO_MEAS?

Returns the zero offset or the reference value for absolute pressure modules.

Ranges and Resolution

Ranges and resolutions for the Product are shown in Table 9.

Table 9. Ranges and Resolutions

Range (PSI)		30 PSI / 2.0 Bar	150 PSI / 10 Bar	300 PSI / 20 Bar
Burst Pressure (PSI)		300	300	600
Proof Pressure (PSI)		60	200	400
Engineering Unit	Factor			
Psi	1	30.000	150.00	300.00
Bar	0.06894757	2.0684	10.3421	20.684
mbar	68.94757	2068.4	10342.1	20684
kPa	6.894757	206.84	1034.21	2068.4
MPa	.00689476	0.2068	1.03421	2.0684
kg/cm2	0.07030697	2.1092	10.5460	21.092
cmH2O @ 4 °C	70.3089	2109.3	10546.3	21093
cmH2O @ 20 °C	70.4336	2113.0	10565.0	21130
mmH2O @ 4 °C	703.089	21093	N/A	N/A
mmH2O @ 20 °C	704.336	21130	N/A	N/A

719PRO*Users Manual*

inH ₂ O @ 4 °C	27.68067	830.42	4152.1	8304.2
inH ₂ O @ 20 °C	27.72977	831.89	4159.5	8318.9
inH ₂ O @ 60 °C	27.70759	831.23	4156.1	8312.3
mmHg @ 0 °C	51.71508	1551.5	7757.3	15515
inHg @ 0 °C	2.03602	61.081	305.40	610.81
Proof pressure - maximum allowable pressure without a shift in calibration				
Burst pressure - sensor damaged or destroyed; some risk of personnel injury				

Maintenance

Replace the Batteries

If the batteries discharge too far, the Product automatically shuts down to prevent battery leakage.

Note

Use only AA size alkaline, Lithium batteries ,or rechargeable NiMh cells.

⚠⚠ Warning

To prevent possible electrical shock, fire, or personal injury:

- **Remove the batteries if the Product is not used for an extended period of time, or if stored in temperatures that exceed the battery manufacturer's specification. If the batteries are not removed, battery leakage can damage the Product.**
- **Replace the batteries when the low battery indicator shows to prevent incorrect measurements.**

- **Be sure that the battery polarity is correct to prevent battery leakage.**
- **Repair the Product before use if the battery leaks.**
- **The battery door must be closed and locked before you operate the Product.**

To change the batteries, see Figure 12:

1. Turn off the Product.
2. Turn the Product so that the display is down.
3. With a flat-head screwdriver, remove the battery door screw.
4. Lift out and disconnect the battery holder.
5. Replace the eight AA batteries with new batteries. Make sure that the polarity on the batteries is correct.
6. Reconnect the battery holder.
7. Reinsert the battery holder into the battery compartment.
8. Replace the battery door.
9. Tighten the battery door screw.

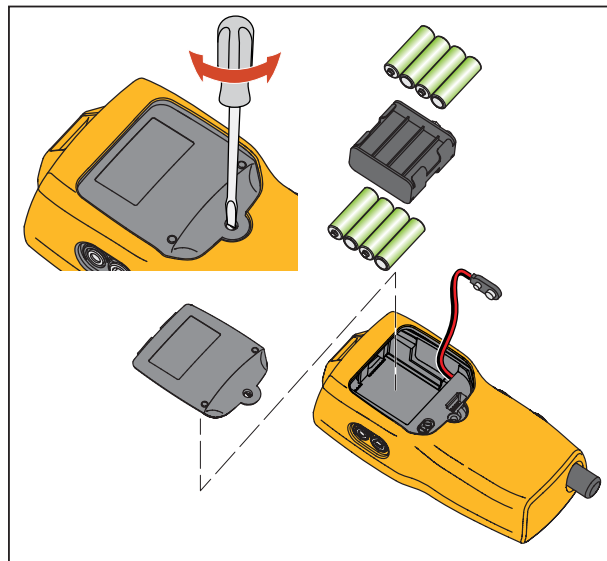

hix061.eps

Figure 12. Battery Replacement

Clean the Product

⚠ Caution

To avoid damaging the plastic lens and case, do not use solvents or abrasive cleansers.

Clean the Product with a soft cloth dampened with water or water and mild soap.

Clean the Valve Assembly

Occasionally, the Product may not work properly due to dirt or other contamination of the internal valve assembly. Use the subsequent procedure to clean the valve assembly. If this procedure does not correct the problem, a repair kit can be ordered. See the “User-Replaceable Parts” section.

1. With a small screwdriver, remove the two valve retention caps located in the battery compartment area (see Figure 12).
2. After the caps have been removed, gently remove the spring and ring assembly.
3. Set aside the valve assemblies in a safe area and clean out the valve body with a cotton swab soaked in IPA (isopropyl alcohol).
4. Repeat the process several times with a new cotton swab each time until there is no evidence of contamination or dirt.
5. Operate the pump handles several times and recheck for contamination.
6. Clean the O-ring assembly and the O-ring on the retention caps with IPA and inspect the O-rings closely for any damage or excessive wear. Replacements are included in the repair kit, if necessary.
7. Inspect the springs for wear or loss of tension. They should be approximately 8.6 mm long in the relaxed state. If shorter, they may not provide sufficient seal tension. Replace if necessary.
8. Once all parts have been cleaned and inspected, reinstall the O-ring and spring assembly into the valve body.
9. Reinstall the retention caps and gently tighten each cap.
10. Seal the output port and operate the pump to at least 50 % of capacity.
11. Release the pressure and repeat several times to ensure that the rings seat properly.

User-Replaceable Parts and Accessories

⚠⚠ Warning

To prevent possible electrical shock, fire, or personal injury, use only specified replacement parts.

User-replaceable parts are listed in Table 10 and shown in Figure 13. For more information about these items, contact a Fluke representative. See the “Contact Fluke” section of this manual.

Table 10. User-Replaceable Parts and Accessories

Item	Description	Part Number
①	Holster	4365551
②	Keypad	4364770
③	Lens, 30 PSIG	4365524
	Lens, 150 PSIG	4365536
	Lens, 300 PSIG	4365549
④	Fluke-7XX-2020 Display Module	4404450
⑤	Selector Knob	4380627
⑥	719Pro Vernier Adjustment Knob	664190
⑦	Port Label, 30 PSI, 2 BAR	4110698
	Port Label, 150 PSI, 10 BAR	4374295
	Port Label, 300 PSI, 20 BAR	4110710
⑧	TPAK80-4-2002 Magnet Strip	669952

Pressure Calibrator
User-Replaceable Parts and Accessories

Item	Description	Part Number
⑨	TPAK80-4-8001 Strap, 9 in.	669960
⑩	Safety Sheet	4354604
⑪	Quick Reference Guide	4354567
⑫	User Manuals CD	4354598
⑬	AA, Alkaline Batteries	376756
Not Shown	Bottom Plug, PRO 30, 150PSIG	4365560
Not Shown	71X-TRAP, Liquid Dirt Trap	4380747
Not Shown	Test Lead Set	Variable ^[1]

Item	Description	Part Number
Not Shown	Alligator Clip, Red	Variable ^[1]
Not Shown	Alligator Clip, Black	Variable ^[1]
Not Shown	RTD Probe	4366669
Not Shown	URTDA, Universal RTD Adapter (RTD Breakout Box) for 719Pro and 721.	4382695
Not Shown	Kit-hose, fittings (3), adapters (2)	3345825
Not Shown	FLK719PRO 300PRK, Pump Rebuild Kit, 719PRO-300G	4401168
Not Shown	FLK719PRO 30 150PR, Pump Rebuild Kit, 719PRO-30 AND 150G	4401179
Not Shown	FLUKE-7XX Cable,USB, 5 Pin LEMO, SGL 6ft	4401616

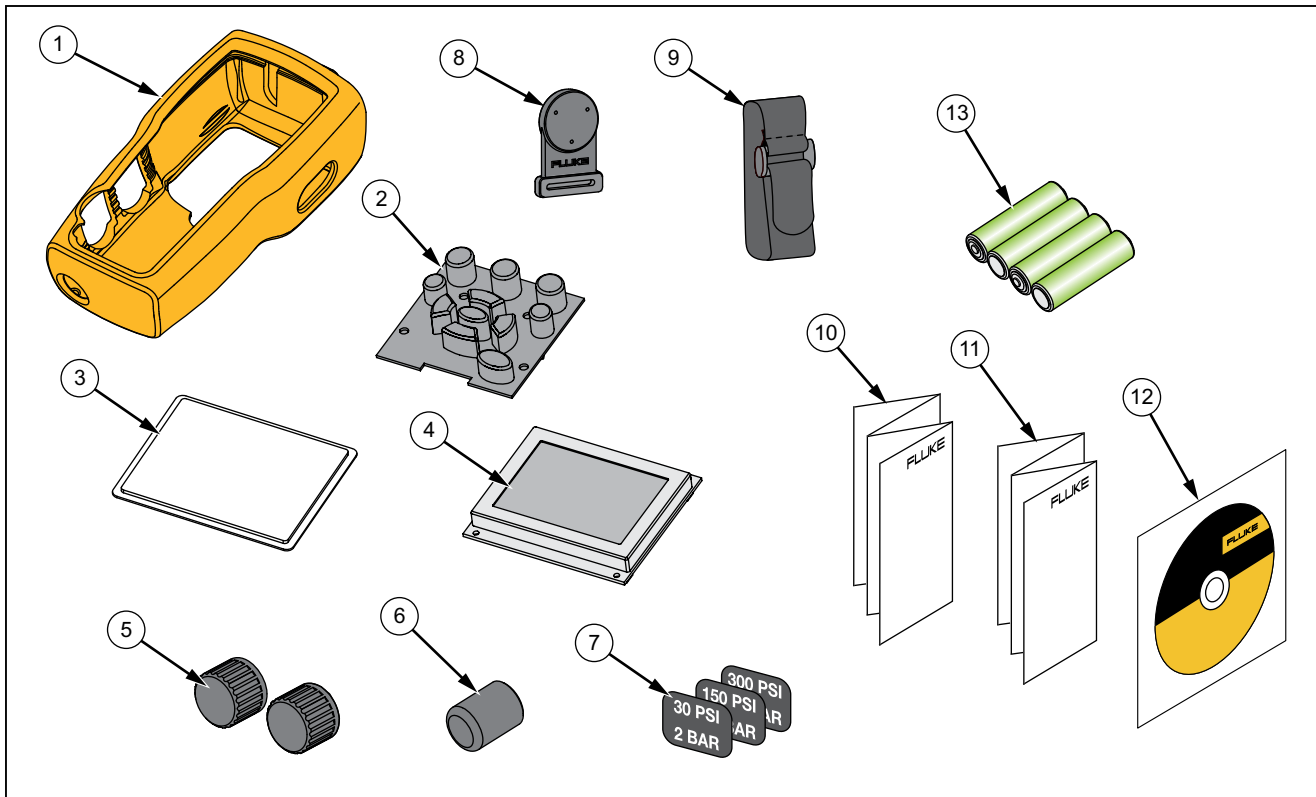

hix063.eps

Figure 13. User-Replaceable Parts and Accessories

Specifications

Pressure Measurement	Range	Resolution	Accuracy	Comment
719Pro-30G	-12 to 30 PSI/-0.8 to 2 bar	0.001 PSI 0.0001 bar	±0.025 % of full scale, 6 months ±0.035 % of full scale, 1 year	Dry air and non-corrosive gas only
719Pro-150G	-12 to 150 PSI/-0.8 to 10 bar	0.01 PSI 0.001 bar		
719Pro-300G	-12 to 300 PSI/-0.8 to 20 bar	0.01 PSI 0.001 bar		
Temperature effect (all ranges)			Add ±0.002 % of full scale for temps outside of 15 °C to 35 °C	No effect on accuracy on all functions from 15 °C to 35 °C
Function	Range	Resolution	Accuracy (1 year)	Comment
mA dc (simulation and measurement)	0 mA dc to 24 mA dc	0.001 mA	±0.015 % of reading ±2 counts	1000 Ω maximum load in mA source, 26 V dc maximum voltage in mA simulate
Volts dc (measurement only)	30 V dc	0.001 V		No ac voltage measurement, do not exceed 30 V dc
Temperature (measurement only, Pt100 RTD)	-50 °C to 150 °C (-58 °F to 302 °F)	0.01 °C 0.01 °F	Temperature ±0.1 °C (0.2 °F)	±0.25 °C (±0.45 °F) combined uncertainty when using 720 RTD probe (optional accessory)
Loop power supply	24 V dc	N/A	24 mA at 24 V	
Temperature Effect (all functions)			Add ±0.002 % full scale/°C for temperatures outside of 15 °C to 35 °C	No effect on accuracy on all functions from 15 °C to 35 °C

719PRO

Users Manual

Temperature Range

Operating-10 °C to +50 °C (14 °F to +122 °F)

Storage

With Batteries Per battery manufacturer's specification, not to exceed storage specification without batteries.

Without Batteries-20 °C to +60 °C (-4 °F to +140 °F)

Altitude2000 m

Power

Batteries 8 AA batteries (alkaline)

Battery Life 300 pump cycles to 150 PSI minimum; 1000 pump cycles to 30 PSI; 100 pump cycles to 300 PSI minimum

Physical

Dimensions with holster(H x W x D) (24.13 x 11.18 x 7) cm, (9.5 x 4.4 x 2.8) in

Weight with holster 1.2 kg (2.5 lb)

Ingress ProtectionIP40

Connectors/Ports

Pressure One (1), 1/8 in NPT

Electrical Standard banana jacks

RTD Probe 4-pin miniature circular

External Module 6-pin miniature circular

Engineering Units psi, bar, mbar, kPa, kgcm², cmH₂O @ 4 °C, cmH₂O @ 20 °C, mH₂O @ 4 °C, mH₂O @ 20 °C, inH₂O @ 4 °C, inH₂O @ 20 °C, inH₂O @ 60 °F, mmHg @ 0 °C, inHg @ 0 °C, ftH₂O @ 4 °C, ftH₂O @ 20 °C, ftH₂O @ 60 °F

Electromagnetic EnvironmentIEC 61326-1: Portable

Electromagnetic CompatibilityApplies to use in Korea only. Class A Equipment (Industrial Broadcasting & Communication Equipment) [1]

[1] This product meets requirements for industrial (Class A) electromagnetic wave equipment and the seller or user should take notice of it. This equipment is intended for use in business environments and is not to be used in homes.

