



Quick Start Manual

8423

MEMORY HiLOGGER

Read first.

Offers an introduction to the Memory HiLogger's basic measuring method for first time users.

HIOKI E. E. CORPORATION

November 2012 Revised edition 6 8423A983-06 12-11H



600197926

Contents

Introduction	1
Verifying Package Contents	3
Names and Functions of Parts	4
Installing the Software	6
Installing Logger Utility	7
Installing the USB Driver	8
Software Screen	12
Setting Up the Instrument	13
Taking Measurements	18
Application Measurement Tips	29

Introduction

Thank you for purchasing the HIOKI "Model 8423 Memory HiLogger." To obtain maximum performance from the instrument, please read this manual first, and keep it handy for future reference.

The following instruction manuals are included with the 8423 Memory HiLogger. Refer to them as they pertain to your usage of the instrument.

Manuals	Contents
1 Quick Start Manual (this manual)	Read first. Offers an introduction to the 8423's basic measuring method for first time users.
2 Instruction Manual	Contains explanation and instructions regarding the instrument's operating method and functions.

- Before reading this manual, fully read and understand "Safety Information" and "Chapter 3 Setting Up the Instrument" in the instruction manual, and then start taking measurements.
- Use an optional measurement unit for measurement. Carefully read the instruction manual supplied with the measurement unit, and observe the safety precautions.



Registered Trademarks

- Windows is a registered trademark of Microsoft Corporation in the United States and/or other countries.
- Pentium is a registered trademark of Intel Corporation.

Notation

Safety Symbols

The following symbols in this manual indicate the relative importance of cautions and warnings.

 WARNING	Indicates that incorrect operation presents a significant hazard that could result in serious injury or death to the user.
 CAUTION	Indicates that incorrect operation presents a possibility of injury to the user or damage to the instrument.
NOTE	Indicates advisory items related to performance or correct operation of the instrument.

Others

	Indicates quick references for operation and remedies for troubleshooting.
*	Indicates that descriptive information is provided below.
[]	Menus, pages, setting items, dialogs, buttons in a dialog, and other names on the screen and the keys are indicated in brackets.
	Unless otherwise specified, "Windows" represents Windows 2000, Windows XP, Windows Vista or Windows 7. Dialog box represents a Windows dialog box.

Mouse Operation

Click	Press and quickly release the left button of the mouse.
Right-click	Press and quickly release the right button of the mouse.
Double click	Quickly click the left button of the mouse twice.
Drag	While holding down the left button of the mouse, move the mouse and then release the left button to deposit the chosen item in the desired position.
Activate	Click on a window on the screen to activate that window.

Verifying Package Contents

When you receive the instrument, inspect it carefully to ensure that no damage occurred during shipping. In particular, check the accessories, panel switches, and connectors. If damage is evident, or if it fails to operate according to the specifications, contact your dealer or Hioki representative.

Please check to make sure that no items are missing from your package.

Model 8423 Memory HiLogger
..... 1

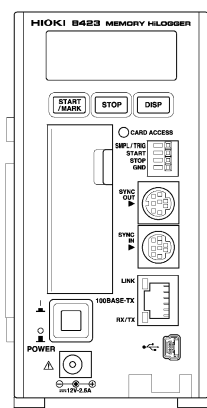

Quick Start Manual 1
 Instruction Manual 1

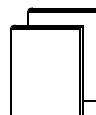

Logger Utility CD (data collection software)..... 1
(The latest version can be downloaded from our web site.)



Model 9418-15 AC Adapter 1



USB Cable 1



Connector Cover..... 1

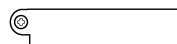

Ferrite Clamps 1

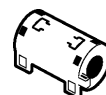

Connection Plate 1



Names and Functions of Parts

Front Panel

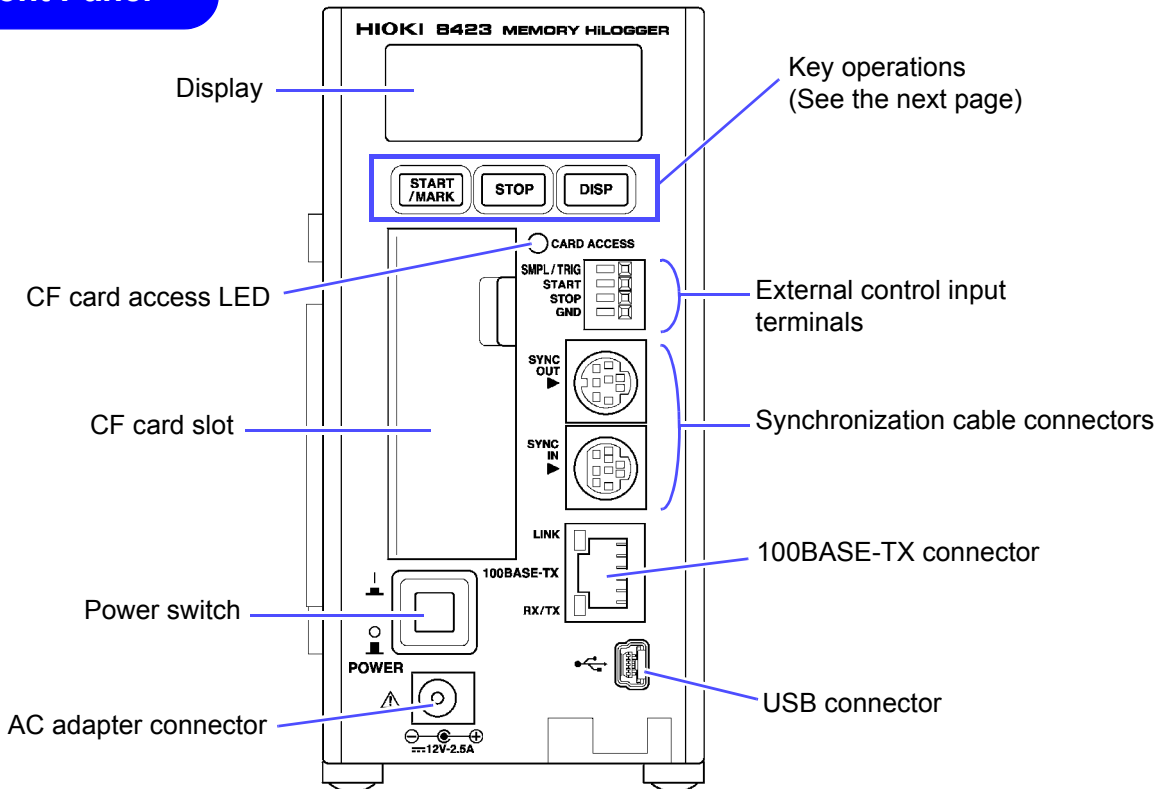

Names of parts	Explanations
Display	Displays setting values, measurement values, error messages, warning messages, and other information.
CF card access LED	<ul style="list-style-type: none"> When the cover is open: <ul style="list-style-type: none"> Off: The CF card can be ejected. Lit red: The CF card cannot be ejected because data is being written. When the cover is closed: <ul style="list-style-type: none"> Off: A CF card is not inserted or recording is not possible because the CF card cannot be recognized. Lit green: A CF card is inserted and recording is possible. Lit red: The CF card is being read or written.
CF card slot	Allows for a CF card to be inserted for saving measurement data.
Power switch	Turns the power ON/OFF.
AC adapter connector	Allows for a 9418-15 AC Adapter to be connected.
USB connector	Allows for a USB cable to be connected.
100BASE-TX connector	Allows for a 9642 LAN Cable to be connected.
Synchronization cable connector	Allows for connecting optional 9683 Connection Cable (for synchronization) when you want to perform synchronized measurement with multiple Memory HiLoggers.
External control input terminals	Allows for controlling the instrument by inputting a signal from an external device.

Key Operations

Keys	Explanations
<div style="border: 1px solid black; padding: 2px; width: fit-content; margin: 0 auto;">START /MARK</div>	<ul style="list-style-type: none"> • The key lights during measurement. • Press the key once during standby to start measurement. • Press the key during measurement to input an event mark. <p>When the power is on: You can initialize the settings by turning the power on while pressing <div style="border: 1px solid black; padding: 2px; display: inline-block; font-size: small;">START /MARK</div> and <div style="border: 1px solid black; padding: 2px; display: inline-block; font-size: small;">STOP</div>.</p> <p>See "13.3 Initializing Settings (System Reset)" in the Instruction Manual.</p>
<div style="border: 1px solid black; padding: 2px; width: fit-content; margin: 0 auto;">STOP</div>	<ul style="list-style-type: none"> • Press the key twice in succession during measurement to stop measurement. <p>When the power is on: You can initialize the settings by turning the power on while pressing <div style="border: 1px solid black; padding: 2px; display: inline-block; font-size: small;">STOP</div>.</p> <p>See "13.3 Initializing Settings (System Reset)" in the Instruction Manual.</p>
<div style="border: 1px solid black; padding: 2px; width: fit-content; margin: 0 auto;">DISP</div>	<ul style="list-style-type: none"> • Switches the display content. • The key flashes while an error message or warning message is displayed. Press the key once to clear the display. • If the key is pressed for at least one second and then released while measurement values are displayed during measurement, the display channels are fixed to those displayed the instant the key was released. Press the key for at least one second again to cancel fixing of the display channels. <p>When the power is on: The instrument enters setting mode if you turn on the power while pressing <div style="border: 1px solid black; padding: 2px; display: inline-block; font-size: small;">DISP</div>.</p> <p>See "Chapter 10 Setting Method for Logger" in the Instruction Manual.</p>

Installing the Software

Install the supplied software Logger Utility on the computer the first time you use the instrument after purchase. Before starting the installation, check the operating environment.

Operating Environment

OS	: Windows 2000 (with SP4 or later) Windows XP (with SP2 or later) Windows Vista Windows 7
CPU	: Pentium III (500 MHz) or better
Monitor Resolution	: 1024 x 768 dots or better
Internet Explorer	: 6.0 or better
Memory	: At least 512 MB
Interface	: Ethernet or USB

Installing Logger Utility

Follow the procedure below to install Logger Utility. This explanation is for installing the software on Windows XP. The messages displayed may differ slightly depending on the operating system you are using.

Important

If you are running software such as antivirus software, be sure to end the software before you start the installation. The installation may not be performed properly if antivirus software is running.

- 1. Start up Windows.**
Exit all running applications.
- 2. Insert the included CD into the computer's CD-ROM drive, the installer run automatically.**
If the installer do not start, execute "Setup.exe" from the CD-ROM drive. In Vista, Although the dialog which ask for installation permission of application, click **[Allow]**.

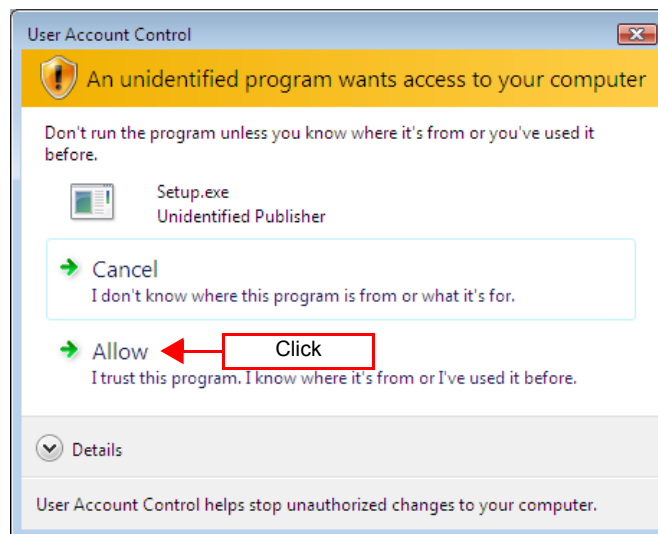

- 3. Follow the on-screen instructions to install the software.**

Installing the USB Driver

Install the USB driver before you use the instrument with a USB connection.

1. **Install the driver.**
Run [SetupDriver32.msi] in the CD-R.
If [Logger Utility] is already installed, run the CD from the following location.

[c:\Program Files\HIOKI\LoggerUtility\Driver\SetupDriver32.msi]

If you are using the Windows Vista/7 64bit version:

[c:\Program Files(x86)\HIOKI\LoggerUtility\Driver\SetupDriver64.msi]

Run [SetupDriver64.msi] in the CD-R.

If [Logger Utility] is already installed, run the CD from the following location.

[c:\Program Files\HIOKI\LoggerUtility\Driver\SetupDriver64.msi]



Depending on the environment, the dialog box may take some time to appear so please wait till it does so.

2. **Click [Next].**

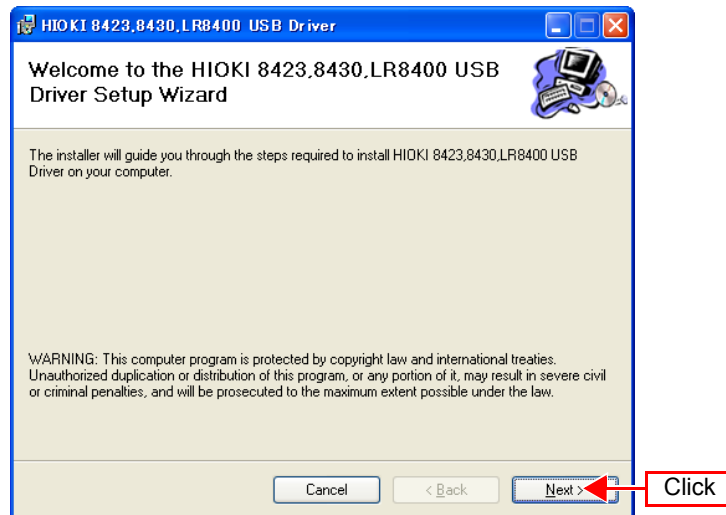

3. Check **[Everyone]** and click **[Next]**.

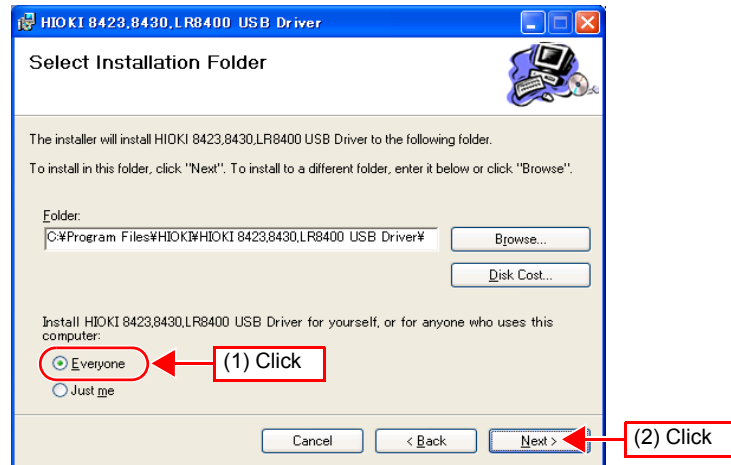

4. Click **[Next]** to start installing.

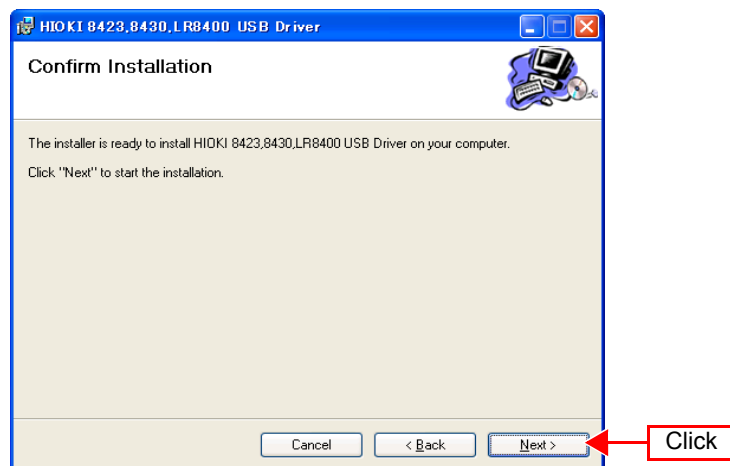

For WindowsXP

During the installation, a message saying that the software has not passed Windows Logo testing will appear a few times, click **[Continue Anyway]** to continue installing.

For WindowsVista/7

When a dialog box requesting your permission to continue the program appears, click **[Continue]**.

Sometimes another dialog box requesting your permission to install the software may appear. When it does, check "Always trust software from **[HIOKI E.E. CORPORATION]** and click **[Install]** to continue.

5. When installation is completed and the dialog box appears, click **[Close]** to exit.

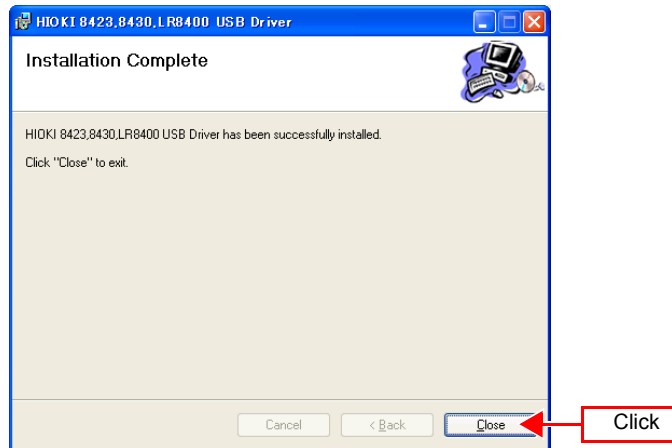

6. Connect the instrument and computer with the USB cable provided.



Do not plug in or unplug the USB cable while the instrument is operating.

For Windows2000/Vista/7

The HiLogger is automatically recognized, and preparations to use the device are complete.

For WindowsXP

A **[Found New Hardware Wizard]** dialog box will appear and the new hardware detection wizard will begin.

7. Check **[No, not this time]** and click **[Next]**.

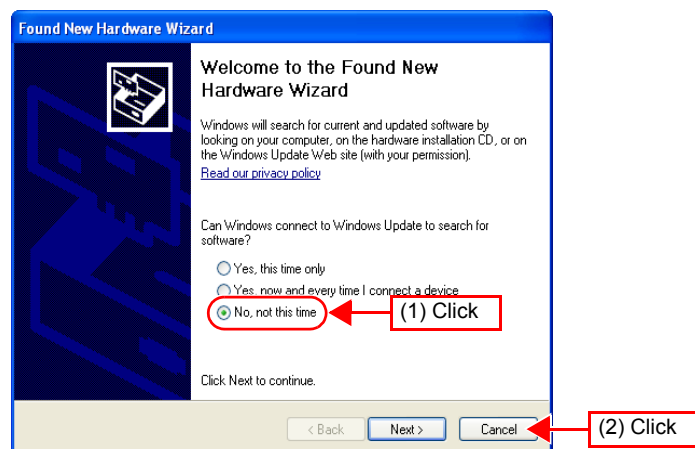

8. Check **[Install the software automatically (Recommended)]** and click **[Next]**. Please wait while the driver is being installed.

9. Click **[Continue Anyway]**.
A message saying that the software has not passed Windows Logo testing will appear a few times, click **[Continue Anyway]** to continue installing.

10. When installation is completed and the dialog box appears, click **[Finish]** to exit.

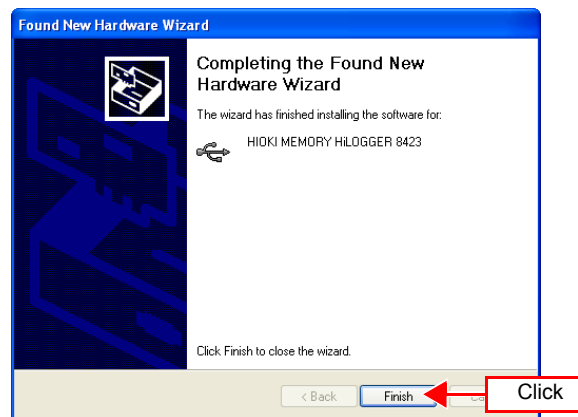

Software Screen

This chapter describes the screen configuration, part names, and functions of the supplied software Logger Utility. Please see the Instruction Manual.

Menu Bar

File View Help

Saves and loads measurement data and setting data, print waveforms, etc.

Tool Button



Displays the settings screen, starts and stops measurement, etc.

Waveform Display Area

Displays measurement data as waveforms.

Measurement Condition

Displays measurement condition as "Measuring", "Stop", "Waiting for TRIG", etc.

Display Settings Windows

Click the tabs on the right side to display setting items. The windows allow for configuring the advanced settings of the waveform display area, analyzing data, etc.

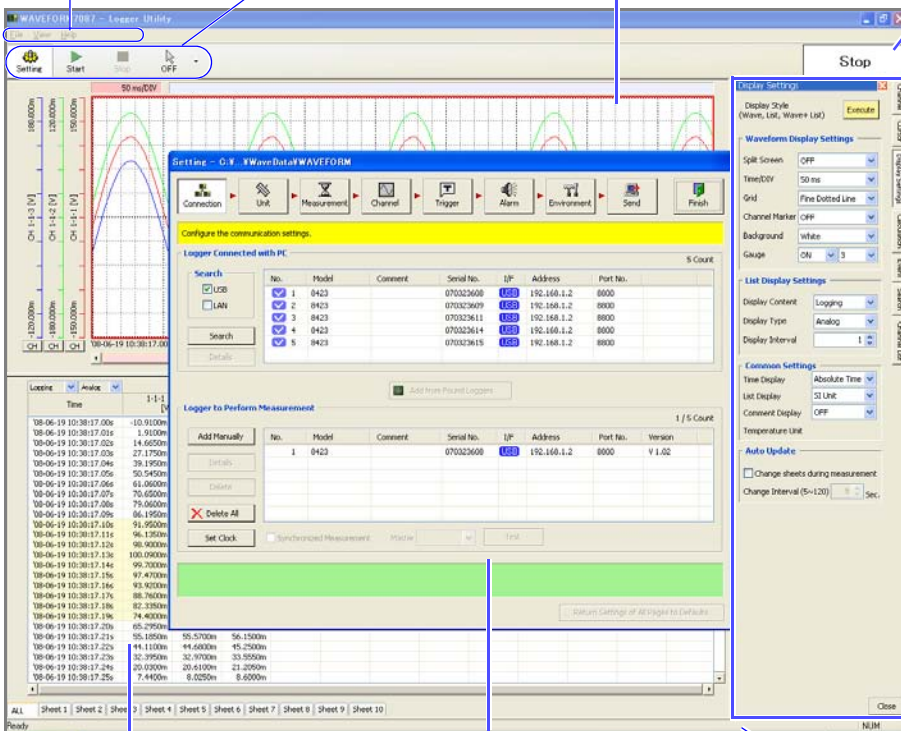

List Display Area

Displays measurement data as numerical values.

Settings Screen

Allows for setting measurement conditions.

Status Bar

Displays the status of the main screen.

Setting Up the Instrument

Follow the procedure below to prepare the measurement instrument before beginning measurement.

Required tools: Phillips screwdriver 1

- 1. Attach the unit to the 8423 Memory HiLogger. To attach multiple units.**

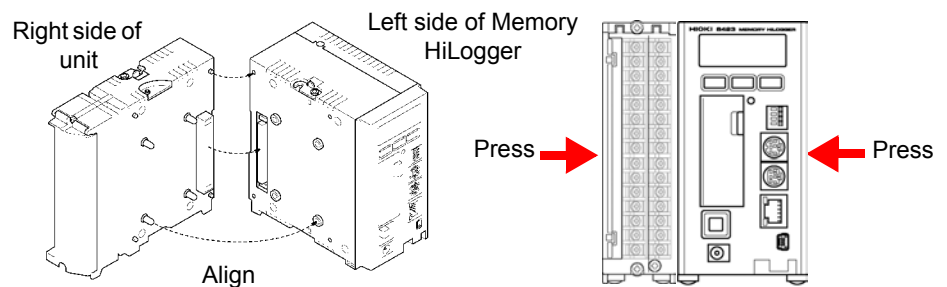

- 2. Secure the unit in place with the connection fittings at the top and bottom of the unit.**

Use the Phillips screwdriver to tighten the screws to no more than 0.6 Nm.

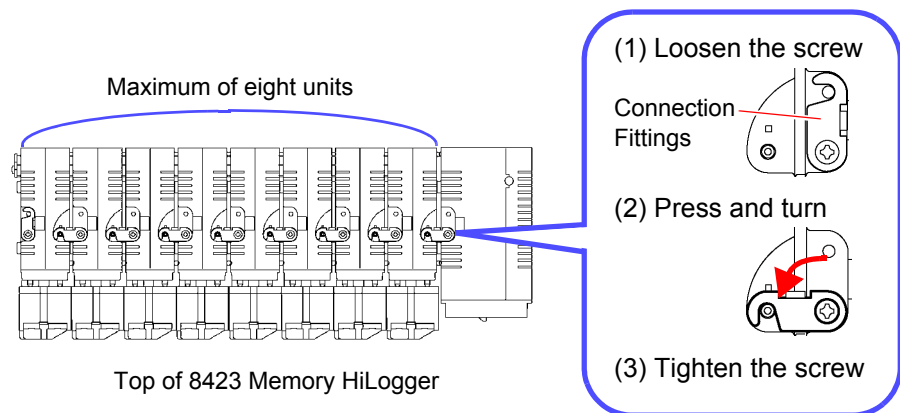

- 3. Attach the supplied connector cover to the unit on the very left side when looking from the front.**

Insert the protruding part of the connector cover into the connector opening of the unit, close the cover, and then secure it in place with the screw. Tighten the screw to no more than 0.6 Nm.

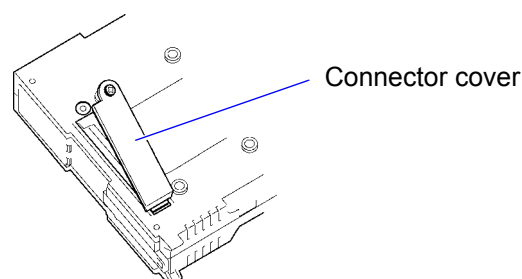

4. Pull down the levers on the rear of the instrument and unit, and hook the connection plate on to the hooks at the top of the DIN rail mounting groove.

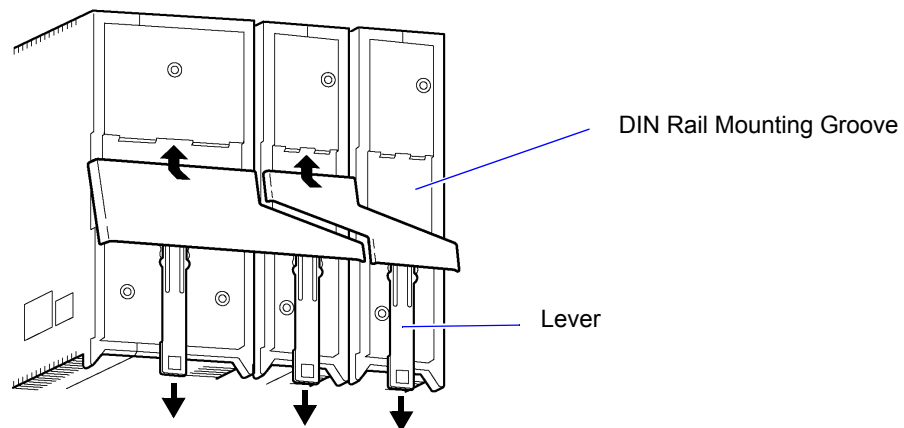

5. Push up the levers until they click into place.

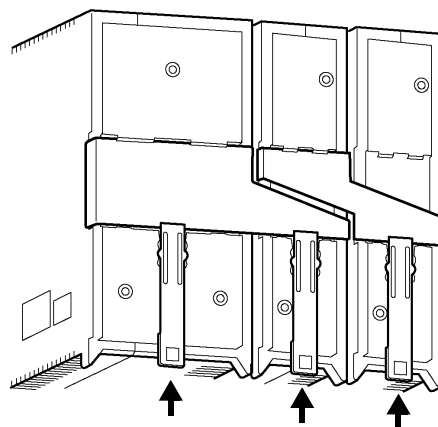

! WARNING

- To avoid electric shock accident, before removing or replacing a unit, confirm that the instrument is turned off and that the cables are disconnected.
- If the units are not securely attached with the connection fittings, the specifications may not be satisfied, resulting in a malfunction.
- Failure to fasten the connectors properly may result in sub-specification performance or damage to the equipment
- Be sure to attach the supplied connector cover to the unit at the very end.

NOTE

Up to eight units can be connected to the instrument. If nine or more units are connected, measurement will not be possible.

- 6.** Loosen the screw at the bottom of the cover with the Phillips screwdriver and lift up the cover.

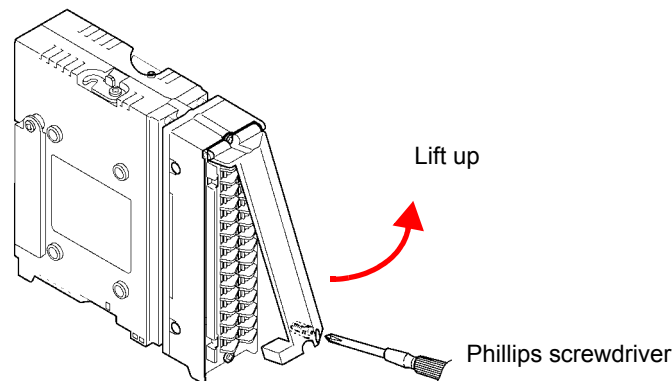

- 7.** Loosen the screws of the terminal block, connect the input cable, and then tighten the screws.

The connection method differs depending on the measurement object. See "3.2 Connecting a Cable to the Terminal Block" in the Instruction Manual.

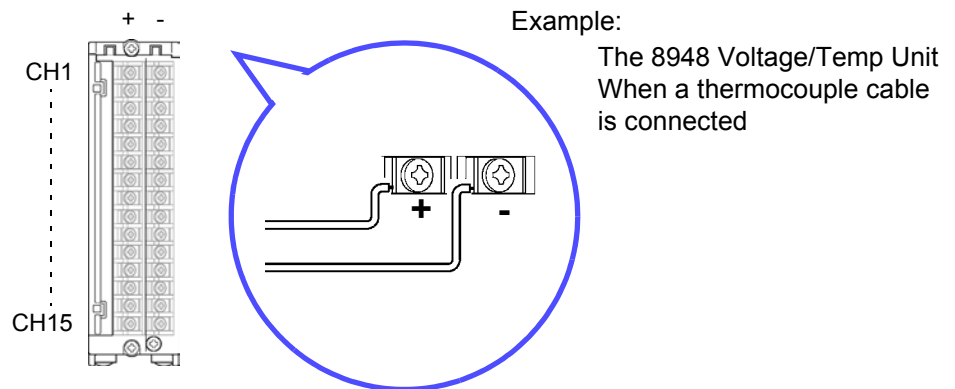

- 8.** Reattach the cover, and tighten the screw.

Tighten the screw to no more than 0.6 Nm.

! WARNING

- In order to prevent electric shock and short-circuit accidents, shut off the power to the line to be measured before connecting the input cable.
- To avoid electrical accidents, confirm that all connections are secure. The increased resistance of loose connections can lead to overheating and fire.
- Channels are isolated by semiconductor relays. Never apply a voltage in excess of the specifications between channels as doing so could damage the semiconductor relays by causing them to short out. Exercise particular care concerning surge protection against lightning and other threats. If the instrument yields erroneous measured values, have it inspected.

! CAUTION

Be sure to pull out an input cable after you loosen the screws of the terminal block. The input cable will be damaged if the screws are not loosened and excessive force is used to pull out the input cable.

- 9.** Connect the connector of the AC adapter to the connector of the instrument, and insert the plug into a power outlet with a ground.

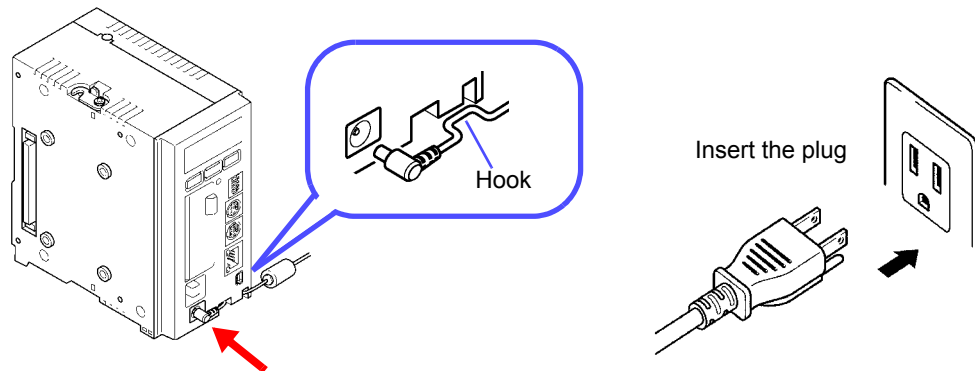

- 10.** Connect the instrument to a computer with a USB cable. A USB cable is used in this example, but you can also use a LAN cable in the same way.

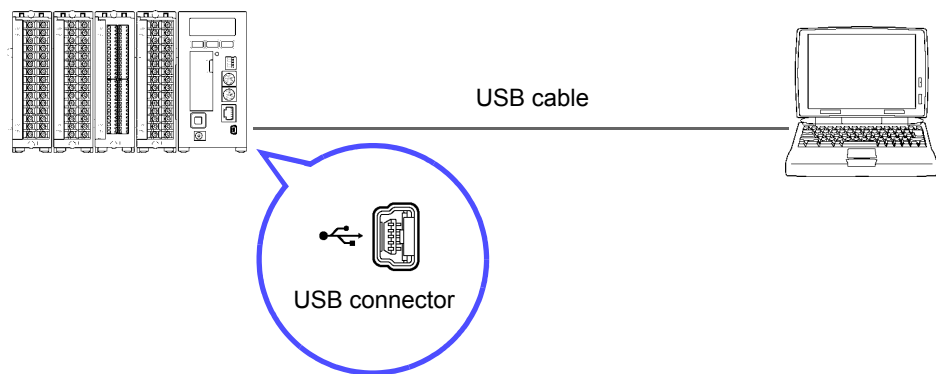

! WARNING

- Turn the instrument off before connecting the AC adapter to the instrument and to AC power.
- Use only the supplied Model 9418-15 AC Adapter. AC adapter input voltage range is 100 to 240 VAC (with $\pm 10\%$ stability) at 50/60 Hz. To avoid electrical hazards and damage to the instrument, do not apply voltage outside of this range.
- To avoid electrical accidents and to maintain the safety specifications of this instrument, connect the power cord provided only to a 3-contact (two-conductor + ground) outlet.

! CAUTION

- To avoid damaging the power cord, grasp the plug, not the cord, when unplugging it from the power outlet.
- To avoid a malfunction, do not connect or disconnect the USB cable or LAN cable during operation.
- To avoid a malfunction, do not connect or disconnect the USB cable or LAN cable during operation.

11. Insert the CF card.

The measurement data is sent to the computer, but you can also save the data to the CF card.

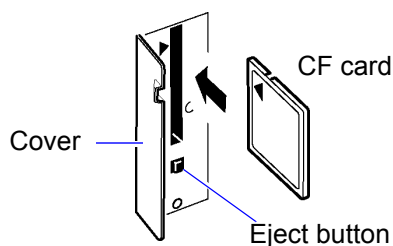
**NOTE**

Format a CF card on a computer the first time you use it or before you begin measurement. If the CF card has been used for another purpose, saving may take a while or the file information may be damaged. Formatting will prevent these problems from occurring.

See "3.6.1 Formatting a CF Card" in the Instruction Manual.

12. Press the power switch to turn the power on (I).

The model name and version appear on the screen, and then the instrument enters the standby state (clock displayed).

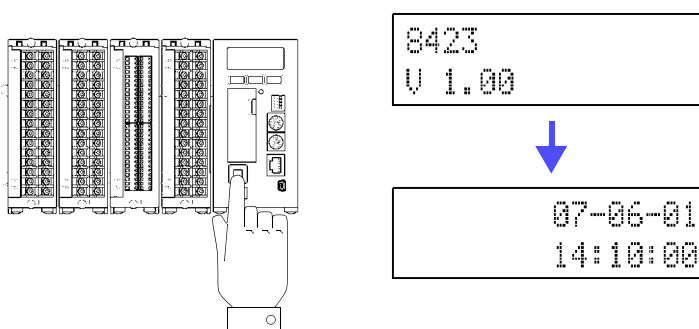
**! WARNING**

To avoid an electric shock or short-circuit accident, confirm the following items before turning on the power.

- When using the AC adapter, make sure the power supply is a rated supply voltage (100 to 240 VAC) and rated supply frequency (50/60 Hz) of the instrument. (Voltage fluctuations of $\pm 10\%$ from the rated supply voltage are taken into account.)
- Makes sure the instrument is installed properly.

! CAUTION

To avoid damaging the instrument, make sure the input cables are connected properly.

Preparations for the measuring instrument are complete with the above.

Taking Measurements

This section uses a simple measurement example to present the flow of measurement to first-time users of the Memory HiLogger.

Measurement Example: Determining the Temperature Distribution in an Office

Connect an 8948 Voltage/Temp Unit to the 8423 Memory HiLogger, and measure the temperature at 15 locations in the office for a period of 8 hours. Set and send the measurement conditions with the application software on the computer.

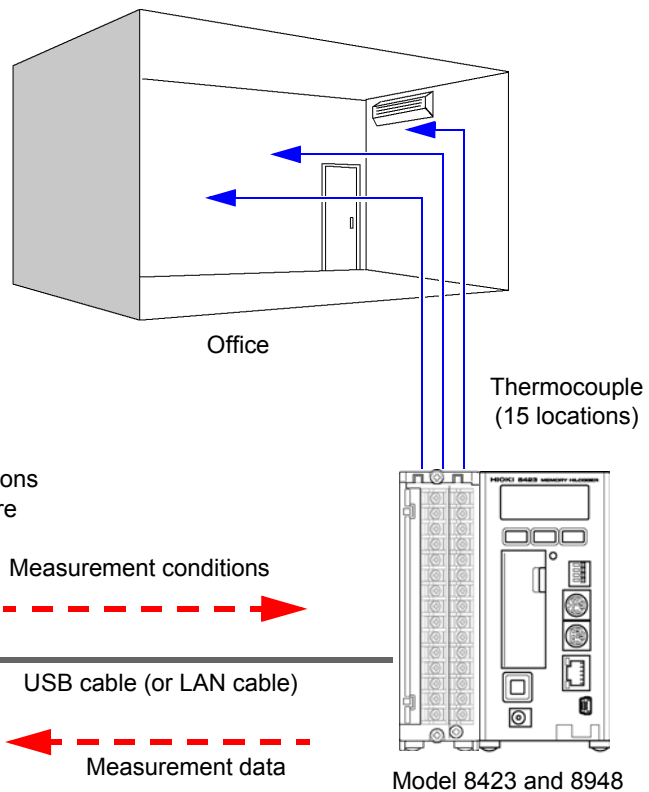
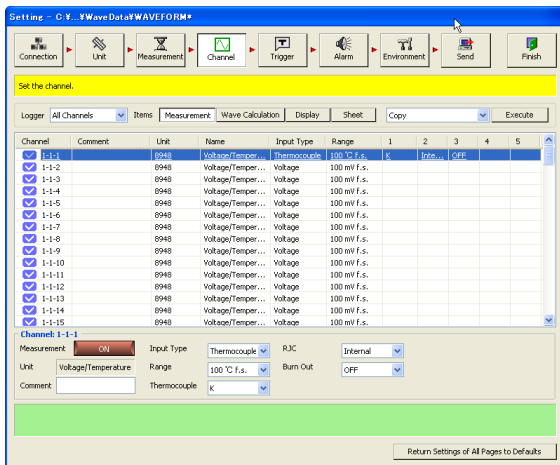

Set the measurement conditions with the application software

- Rec. time 8 hours
- Rec. interval 1 s
- Comm. cable USB cable
- Saved media PC and CF card
- Unit Model 8948 Voltage/Temp Unit
- Required tools Model 8423 Memory HiLogger × 1, Model 8948 Voltage/Temp Unit × 1, Model 9418-15 AC Adapter × 1, USB cable × 1, PC × 1, Thermocouple (K) × 15, Model 9726 PC Card 128M × 1

Setting Measurement Conditions

Follow the procedure below to set the measurement conditions.

Connection Settings

1. From the Start Menu of Windows, click [All Programs] - [HIOKI] - [Logger Utility] - [Logger Utility].

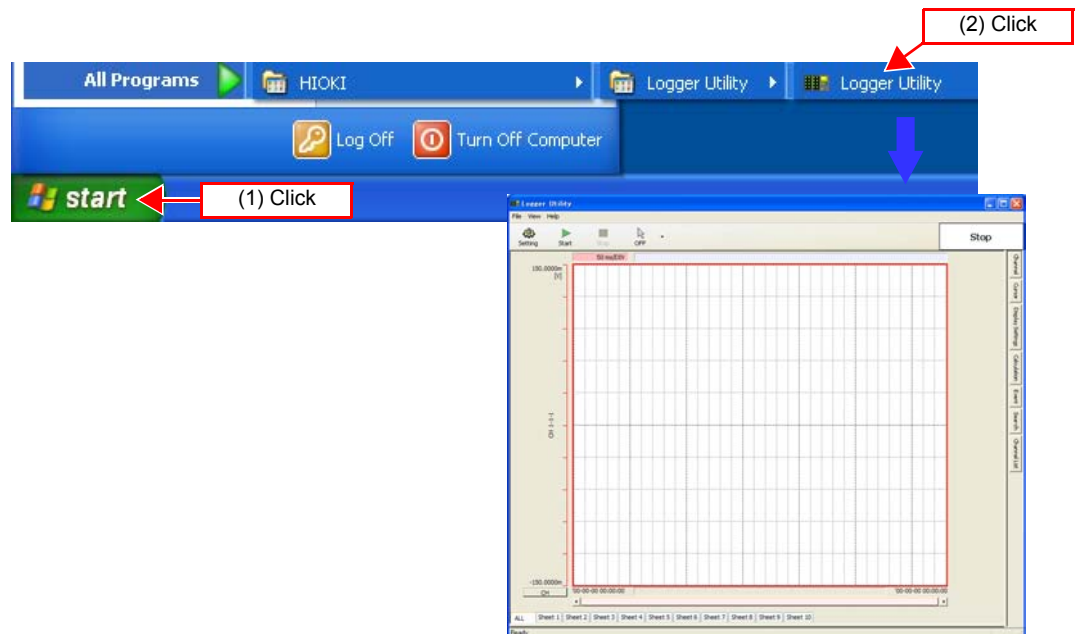

2. Click the  button in the main screen to display the connection settings page of the settings screen.

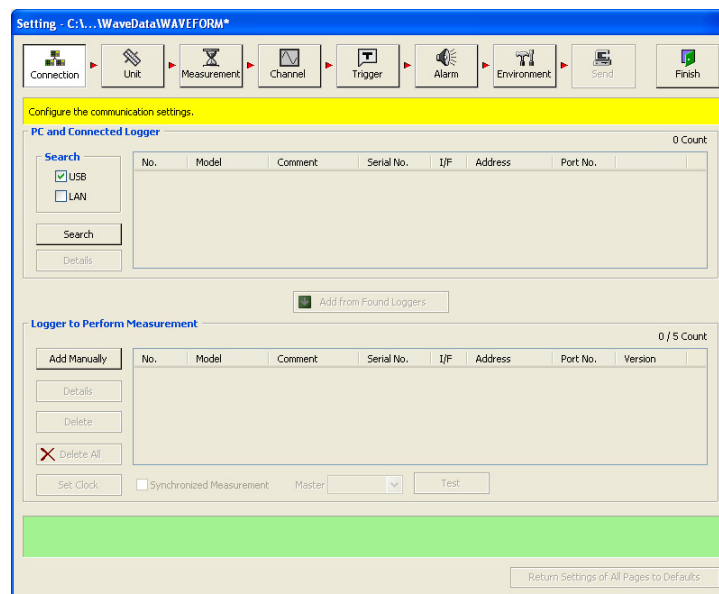

3. Select the search object from USB and LAN.
For this example, select "USB" here.
4. Click the [Search] button, and then The loggers connected to the computer appear.

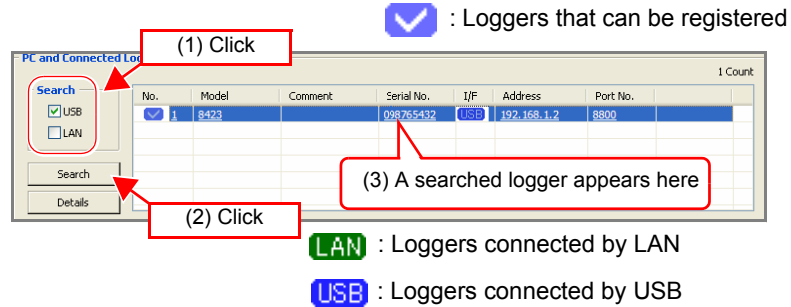

5. Select the logger to register from the list.
6. Click the [Add from Found Loggers] button to register the selected logger.

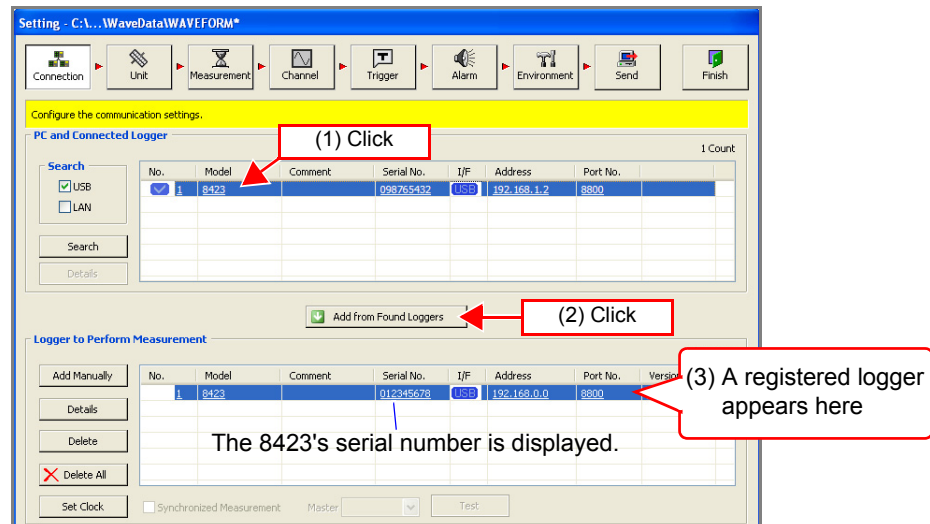

7. Click the [Set Clock] button to display the [Synchronize Clock] dialog box.

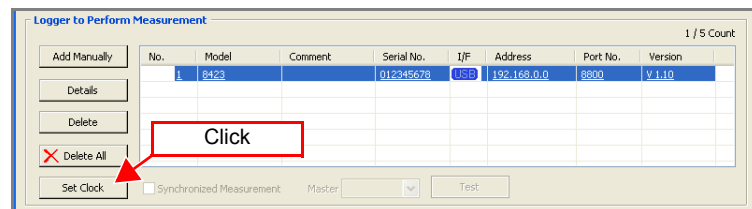

8. Click the [Set Clock] button to set the time of each logger to that of the computer.

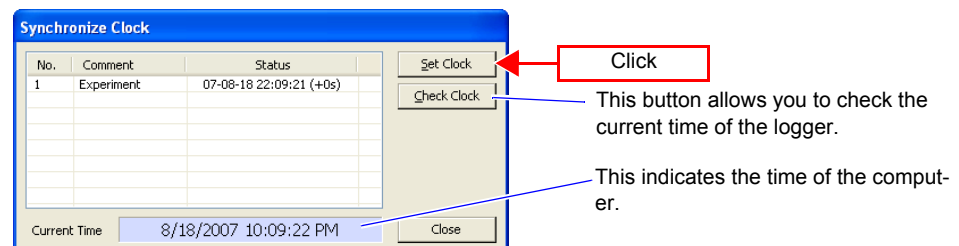

Unit Configuration

1. Confirm that the unit configuration shown on the unit configuration page matches the actual content.
2. Set the digital filter.

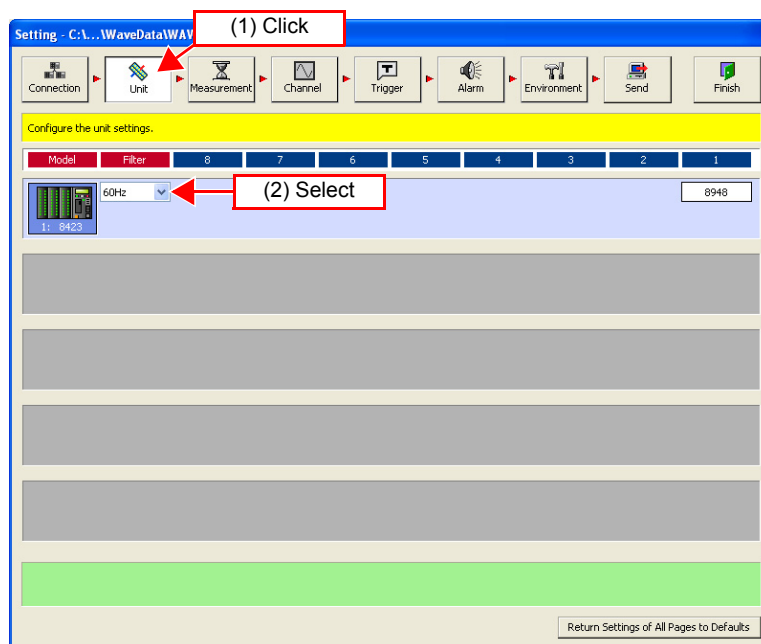

Selectable Items	Explanations
OFF	The filter is not used.
50Hz	Select this to use at an operating power frequency of 50 Hz.
60Hz	Select this to use at an operating power frequency of 60 Hz.

Measurement Settings

1. Click [Normal Sampling] on the measurement settings page.
2. Set the recording interval (high-speed).
For this example, select "1s" here.

Selectable Intervals
10, 20, 50, 100, 200, 500 ms, 1, 2, 5, 10, 20, 30 s, 1, 2, 5, 10, 20, 30 m, 1 h

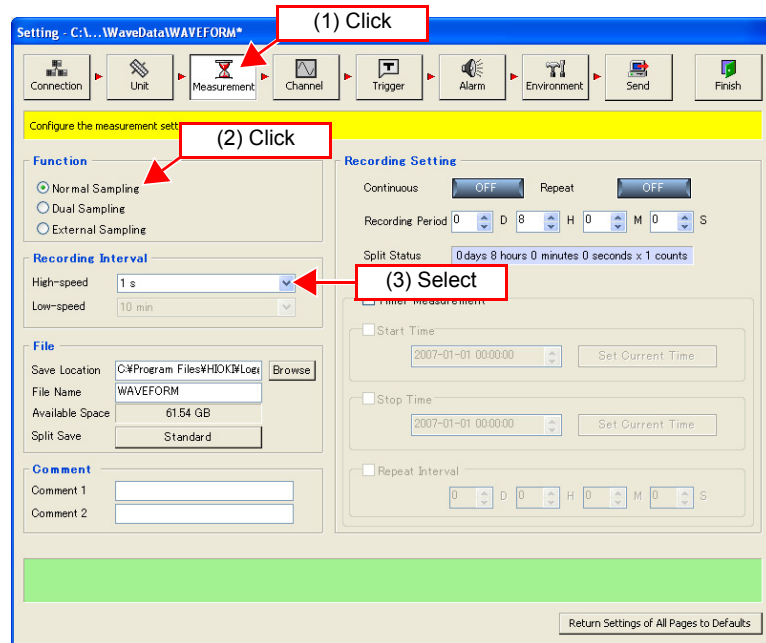

3. Set the location to save the measurement data file.
4. Set any comment.
5. Set the recording period.
For this example, set "8 hours." Set continuous recording and repeat recording to "OFF."

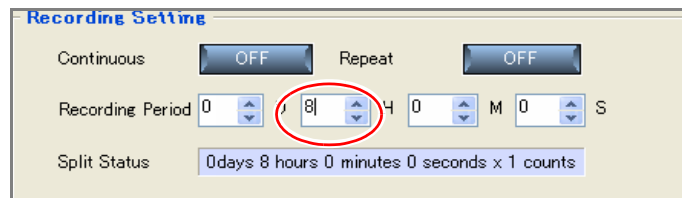

Channel Settings

1. **Select the channel for measurement on the measurement settings page of the channel settings.**
Each click of the button toggles measurement ON and OFF.
2. **Set the input type and range to match the measurement object.**
For this example, select "Thermocouple" and "100°C f.s."
See "5.4.1 Setting Measurement Conditions" in the Instruction Manual.

Narrowing down of display channels

(1) Click

(2) Click

(3) Select

(4) Click

Copy the channel setting information to another channel.

: Measurement ON

Channel	Comment	Unit	Name	Input Type	Range	1	2	3	4	5
1-1-1		8948	Voltage/Temper...	Thermocouple	100 °C f.s.	<input checked="" type="checkbox"/>		Inte...	OFF	
1-1-2		8948	Voltage/Temper...	Voltage	100 mV f.s.	<input checked="" type="checkbox"/>				
1-1-3		8948	Voltage/Temper...	Voltage	100 mV f.s.	<input checked="" type="checkbox"/>				
1-1-4		8948	Voltage/Temper...	Voltage	100 mV f.s.	<input checked="" type="checkbox"/>				
1-1-5		8948	Voltage/Temper...	Voltage	100 mV f.s.	<input checked="" type="checkbox"/>				
1-1-6		8948	Voltage/Temper...	Voltage	100 mV f.s.	<input checked="" type="checkbox"/>				
1-1-7		8948	Voltage/Temper...	Voltage	100 mV f.s.	<input checked="" type="checkbox"/>				
1-1-8		8948	Voltage/Temper...	Voltage	100 mV f.s.	<input checked="" type="checkbox"/>				
1-1-9		8948	Voltage/Temper...	Voltage	100 mV f.s.	<input checked="" type="checkbox"/>				
1-1-10		8948	Voltage/Temper...	Voltage	100 mV f.s.	<input checked="" type="checkbox"/>				
1-1-11		8948	Voltage/Temper...	Voltage	100 mV f.s.	<input checked="" type="checkbox"/>				
1-1-12		8948	Voltage/Temper...	Voltage	100 mV f.s.	<input checked="" type="checkbox"/>				
1-1-13		8948	Voltage/Temper...	Voltage	100 mV f.s.	<input checked="" type="checkbox"/>				
1-1-14		8948	Voltage/Temper...	Voltage	100 mV f.s.	<input checked="" type="checkbox"/>				
1-1-15		8948	Voltage/Temper...	Voltage	100 mV f.s.	<input checked="" type="checkbox"/>				

3. **If you want to copy the setting information from channel 1 to channels 2 to 15, select [Copy] and then click the [Execute] button.**

(1) Select

(2) Click

Channel	Comment	Unit	Name	Input Type	Range	1	2	3	4	5
1-1-1		8948	Voltage/Temper...	Thermocouple	100 °C f.s.	<input checked="" type="checkbox"/>		Inte...	OFF	
1-1-2		8948	Voltage/Temper...	Voltage	100 mV f.s.	<input checked="" type="checkbox"/>				
1-1-3		8948	Voltage/Temper...	Voltage	100 mV f.s.	<input checked="" type="checkbox"/>				
1-1-4		8948	Voltage/Temper...	Voltage	100 mV f.s.	<input checked="" type="checkbox"/>				
1-1-5		8948	Voltage/Temper...	Voltage	100 mV f.s.	<input checked="" type="checkbox"/>				
1-1-6		8948	Voltage/Temper...	Voltage	100 mV f.s.	<input checked="" type="checkbox"/>				
1-1-7		8948	Voltage/Temper...	Voltage	100 mV f.s.	<input checked="" type="checkbox"/>				
1-1-8		8948	Voltage/Temper...	Voltage	100 mV f.s.	<input checked="" type="checkbox"/>				
1-1-9		8948	Voltage/Temper...	Voltage	100 mV f.s.	<input checked="" type="checkbox"/>				
1-1-10		8948	Voltage/Temper...	Voltage	100 mV f.s.	<input checked="" type="checkbox"/>				
1-1-11		8948	Voltage/Temper...	Voltage	100 mV f.s.	<input checked="" type="checkbox"/>				
1-1-12		8948	Voltage/Temper...	Voltage	100 mV f.s.	<input checked="" type="checkbox"/>				
1-1-13		8948	Voltage/Temper...	Voltage	100 mV f.s.	<input checked="" type="checkbox"/>				
1-1-14		8948	Voltage/Temper...	Voltage	100 mV f.s.	<input checked="" type="checkbox"/>				
1-1-15		8948	Voltage/Temper...	Voltage	100 mV f.s.	<input checked="" type="checkbox"/>				

- 4. Select the parameters to copy and the copy destination.**
For this example, select all the parameters.

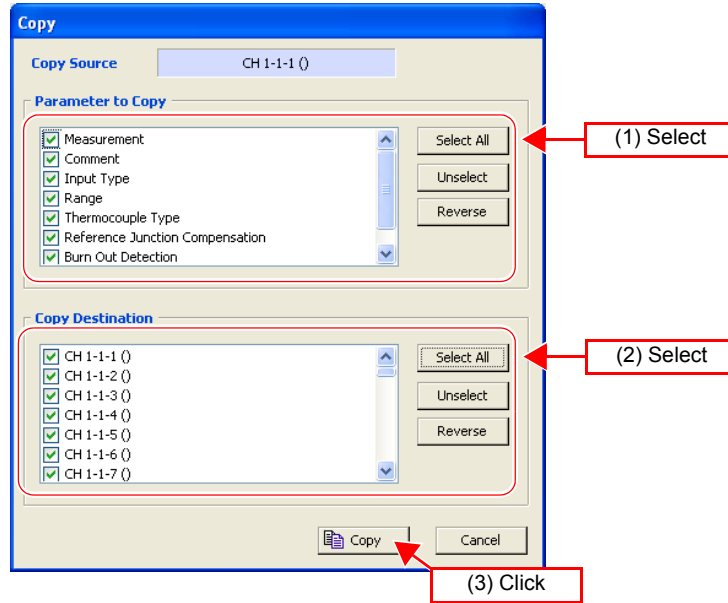

Selectable Items	Explanations
Select All	Select all the parameters to copy or copy destinations.
Unselect	Clear the selection for all the parameters to copy or copy destinations.
Reverse	Reverse the selection for the parameters to copy or copy destinations.

- 5. Click [Copy] to copy the setting information.**
The settings of channels 1 to 15 become the same.

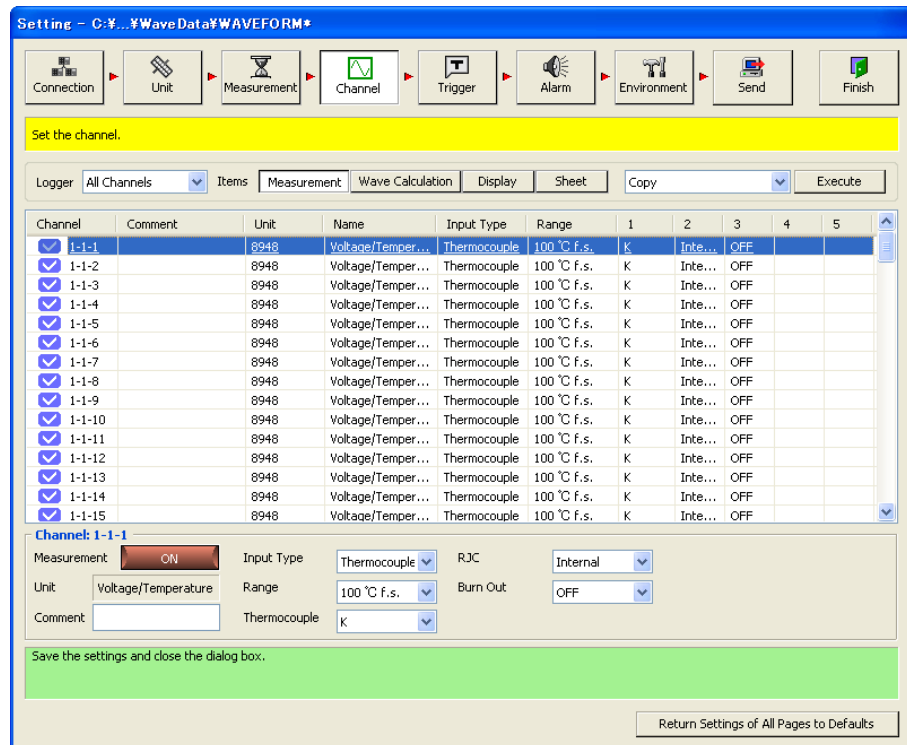

CF Card Save Settings

This section describes setting the method for saving data to a CF (compact flash) card inserted in the logger.

1. **Click the icon of the logger you want to change the settings of on the environment settings page.**

The background color of the selected icon turns red.

2. **Select the auto save method to [Binary (real time)].**

Use the mouse to select the desired setting from the list.

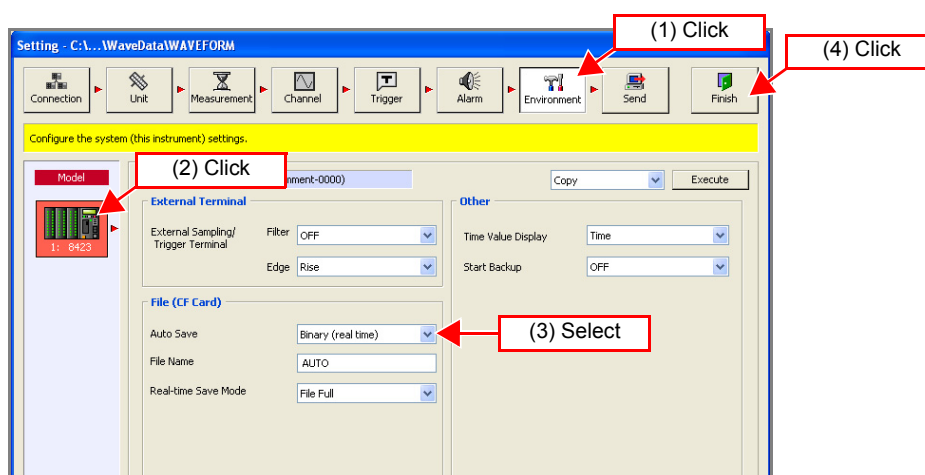

Selectable Items	Explanations
OFF	Do not save measurement data to the CF card inserted in the logger.
Binary (real time)	Save measurement data in binary format to the CF card inserted in the logger, while measuring.

3. **Enter the file name.**

4. **Select the real-time save mode to [File Full].**

Use the mouse to select the desired setting from the list.

Selectable Items	Explanations
File Full	Ends saving when there is no longer much available space on the CF card. However, measurement continues.
Delete and Save	When the amount of available space of the CF card reaches a certain level during measurement, the oldest file in the directory currently being recorded to is deleted and the new data is saved. If a file was unable to be deleted, the same operation as for [File Full] is performed.

5. **Click the [Finish] button.**

Setting of the measurement conditions is finished.

Starting and Ending Measurement

Start measurement. The measurement data is sent to the computer in real time. The same data is also saved in the CF card.

1. Click the  button in the main screen of Logger Utility to start measurement.
2. Measurement continues for 8 hours and then stops automatically.

When you want to stop the measurement part way through, click the  button in the main window.

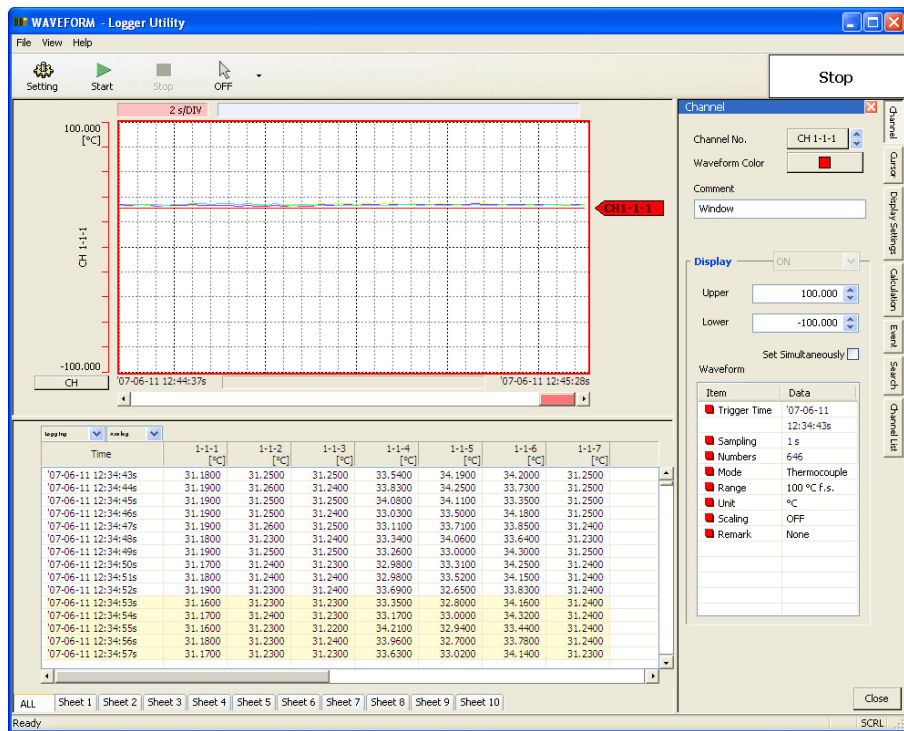

**Why is a waveform not displayed?**

The measurement waveform may have gone out of the display range. Change the display upper limit and display lower limit settings on the **[Channel]** tab of the display settings window to match the measurement values.

See "7.1 Changing the Waveform Display Range" in the Instruction Manual.

**How do I check the measurement value at any point of a waveform?**

Click the tool button on the main screen to display cursors A and B. You can confirm the measurement value of a specific position of a cursor on the **[Cursor]** tab of the display settings window.

See "7.2 Checking Cursor Values" in the Instruction Manual.

**How do I add graduations (scale) to the graph?**

On the **[Display Setting]** tab in the display settings window, set gauge display to ON. See "7.3 Changing Display Settings" in the Instruction Manual.

**How do I split the waveform display area into two?**

On the **[Display Setting]** tab in the display settings window, set split screen to ON. See "7.3 Changing Display Settings" in the Instruction Manual.

**How do I add a mark to a waveform?**

Click the tool button on the main screen to display an event mark. You can then click on the waveform to add an event mark.

See "7.5 Event Mark Function" in the Instruction Manual.

To ensure measurement is performed safely, observe the following precautions.

! WARNING

- The maximum input voltage, maximum rated voltage to earth, and maximum rated voltage between channels for the input/output terminals of each unit and the external control input terminals of the 8423 Memory HiLogger main unit are as shown in the table below. To avoid an electric shock accident or damage to the instrument, do not input the corresponding voltages or above.
- Channels are isolated by semiconductor relays. Never apply a voltage in excess of the specifications between channels as doing so could damage the semiconductor relays by causing them to short out. Exercise particular care concerning surge protection against lightning and other threats. If the instrument yields erroneous measured values, have it inspected.

! CAUTION

- Do not input a voltage that exceeds the measurement range of each range. Doing so will damage the unit.
- Do not directly input a voltage into the output terminal of the 8997 Alarm Unit. Doing so will damage the unit.
- The GND of the external control input terminals and the GND of the Memory HiLogger main unit are not commonly insulated. To avoid damaging the instrument, make sure wiring is done in such a manner that no potential difference can result between the GND of the external control input terminals and the GND of the equipment or device to be connected.

Input/Output Terminals		Maximum Input Voltage	Maximum Rated Voltage to Earth	Maximum Rated Voltage between Channels
Model 8948 Input terminals		100 VDC	600 V AC/DC	200 VDC
Model 8949 Input terminals		60 VDC	600 V AC/DC	120 VDC
Model 8996 Input terminals		50 V DC	600 V AC/DC* ¹	33 Vrms or 70 VDC* ²
Model 8997 Output terminals		--	600 V AC/DC	33 Vrms or 70 VDC
External Control Input Terminals	SMPL / TRIG	-5 to 10 VDC	Not insulated	--
	START			
	STOP			

*1 Between each of the input channels 1 to 5 and the logger main unit, between each of the input channels 6 to 10 and the logger main unit, between each of the input channels 11 to 15 and the logger main unit, and between each unit

*2 Between each of the input channels 1 to 5 and each of the input channels 6 to 10, between each of the input channels 6 to 10 and each of the input channels 11 to 15, and between each of the input channels 1 to 5 and each of the input channels 11 to 15 (GND is common for each of channels 1 to 5, channels 6 to 10, and channels 11 to 15)

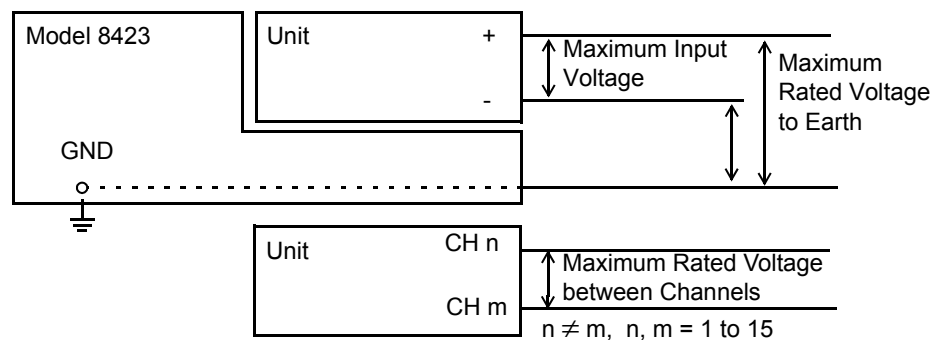

Application Measurement Tips

- **Dividing the measurement data into sheets**

If you divide the channels into individual sheets, the target waveforms become easy to view.

See "5.4.4 Assigning Channels to Sheets" in the Instruction Manual.

- **Outputting an alarm when a certain value is exceeded**

If you use the 8997 Alarm Unit, an error signal can be detected.

See "5.6 Setting the Alarm Function" in the Instruction Manual.

- **Setting sampling for each unit**

You can use different sampling to measure signals with abrupt changes and signals with gradual changes.

See "5.3.1 Setting Function and Recording Interval" in the Instruction Manual.

- **Measuring of 15 or more channels**

A maximum of eight units can be connected to one 8423 Memory HiLogger to enable the measurement of up to 120 channels. Furthermore, the synchronous operation of five Memory HiLoggers facilitates the synchronized measurement of 600 channels.

See "5.1.3 Settings for Synchronized Measurement" in the Instruction Manual.

- **Printing waveforms**

The displayed waveforms can be printed with the printer connected to the computer.

See "Chapter 9 Printing" in the Instruction Manual.

- **Calculating Measured Data**

The measured data is calculated with preset arithmetic expression to display the waveform. Four arithmetic operations (+, -, *, /) are applicable to measurement channels and arithmetic channels. See "5.4.2 Waveform Calculation Settings" on the detailed Instruction Manual.

