

Test Equipment Depot - 800.517.8431 - 99 Washington Street Melrose, MA 02176

TestEquipmentDepot.com

# 9190A

Ultra-Cool Drywell

## Operators Manual

January 2013

© 2013 Fluke Corporation. All rights reserved. Specifications are subject to change without notice.  
All product names are trademarks of their respective companies.



# Table of Contents

Chapter	Title	Page
<b>1</b>	<b>Product Overview and Specifications .....</b>	<b>1-1</b>
	Product Overview .....	1-3
	Safety Information .....	1-4
	Manual Set .....	1-5
	Contact Fluke Calibration .....	1-5
	Calibration and Repair Information .....	1-6
	Specifications .....	1-6
	Base Unit Specifications .....	1-6
	-P Specifications .....	1-7
<b>2</b>	<b>Operation .....</b>	<b>2-1</b>
	Introduction .....	2-3
	Calibrator Features .....	2-3
	Display and Control Panel .....	2-4
	-P Option Panel (Input Panel) .....	2-5
	Power and Remote Interface Panel .....	2-6
	Startup and Main Screen .....	2-6
	Calibrator Setup .....	2-8
	Unpack and Inspect .....	2-8
	Placement .....	2-8
	Connect to Mains Power .....	2-9
	Turn On the Product .....	2-9
	Change Language .....	2-9
	Set Display Contrast .....	2-9
	Toggle Key Beep On or Off .....	2-10
	Security and Password .....	2-10
	Menus and Menu Navigation .....	2-11
	Temperature Setup Menu (TEMP SETUP) .....	2-11
	Temperature Setup .....	2-12
	Cutout .....	2-13
	Cooler Status .....	2-14
	Program Menu (PROG MENU) .....	2-14
	Program Setup .....	2-15
	Ramp/Soak .....	2-15

Test Result (-P Only) .....	2-16
System Menu (SYSTEM MENU).....	2-17
Display Setup .....	2-17
Communications Setup .....	2-18
Date/Time Setup (-P Only) .....	2-18
Calibration Setup Menu.....	2-19
Calibration Points Setup.....	2-19
Control Setup .....	2-20
Reference Input Calibration (-P Only).....	2-21
TC Input Calibration (-P Only).....	2-21
mA Input Calibration (-P Only).....	2-22
System Information.....	2-22
Input Setup Menu (INPUT SETUP).....	2-23
Select Unit Input Menu (-P Only).....	2-23
RTD Setup.....	2-24
TC Setup .....	2-25
mA Setup.....	2-25
Test UUT Calculation .....	2-26
REF Input Menu.....	2-26
Reference Probe Setup .....	2-27
Test Calculation Menu .....	2-28
Probe Preparation.....	2-29
Clamp-On Ferrites.....	2-29
Reference PRT Connection Preparation.....	2-29
4-Wire Reference Probe Wiring Instructions.....	2-29
2-Wire Reference Probe Wiring Instructions.....	2-29
Reference Probe Input Setup.....	2-31
PRT/RTD Connection Preparation.....	2-32
Operation .....	2-33
Insert Installation and Removal Procedure.....	2-33
Probe Insertion and Removal Procedure .....	2-35
Set Temperature.....	2-36
Set the Temperature SETPOINT Manually .....	2-36
Set the Temperature with a Preset SETPOINT .....	2-36
Change a Preset SETPOINT .....	2-37
Cancel or Stop Temperature Change.....	2-37
Set a Soft Cutout.....	2-37
Reset an Over-Temperature Cutout.....	2-38
Programs (Automated Tests).....	2-38
Run a Program.....	2-38
Stop a Program.....	2-38

**3 Remote Operation ..... 3-1**

Introduction.....	3-3
Remote Operation Setup .....	3-3
RS-232 Remote Serial Interface.....	3-4
Wiring .....	3-4
Communication Setup.....	3-5
USB Remote Interface.....	3-6
Wiring .....	3-6
Communication Setup.....	3-6
Remote Operation Commands.....	3-7
Overview of Command Structures .....	3-7
Commands by Function or Group .....	3-7
Alphabetical List of Serial Commands.....	3-13

<b>4</b>	<b>Calibration.....</b>	<b>4-1</b>
	Introduction.....	4-3
	Temperature Source Calibration.....	4-3
	Fundamentals.....	4-4
	Terminology.....	4-5
	Calibration Equipment.....	4-6
	Temperature Source Specifications.....	4-6
	Environmental Conditions.....	4-6
	Temperature Source Calibration Procedure.....	4-6
	UUT and Equipment Setup.....	4-6
	As Found Data Collection.....	4-8
	Uniformity Alignment 1st Iteration.....	4-9
	Uniformity Alignment 2nd Iteration.....	4-10
	Uniformity Alignment 3rd Iteration.....	4-10
	Accuracy Alignment.....	4-12
	As Left Accuracy.....	4-13
	As Left Uniformity.....	4-13
	As Left Stability.....	4-14
	Guard Bands.....	4-14
	9190A Input Panel Calibration.....	4-15
	Fundamentals.....	4-15
	Terminology.....	4-15
	Calibration Equipment.....	4-16
	Environmental Conditions.....	4-17
	Input Panel Calibration Procedure.....	4-17
	Input Panel Calibration/Tests.....	4-17
	Readout Specifications.....	4-17
	Reference Accuracy Test.....	4-17
	UUT PRT 4-Wire Test.....	4-18
	UUT PRT 3-Wire Test.....	4-19
	Reference Accuracy Alignment.....	4-20
	UUT Thermocouple Calibration.....	4-21
	Thermocouple Accuracy Test.....	4-21
	Thermocouple Reference Junction Accuracy Test.....	4-22
	Thermocouple Reference Junction and Accuracy Alignment.....	4-22
	Thermocouple Accuracy Alignment.....	4-23
	4-20 mA Input Calibration.....	4-23
	4-20 mA Accuracy Test.....	4-23
	24 V Source Test.....	4-24
	4-20 mA Accuracy Alignment.....	4-24
<b>5</b>	<b>Maintenance and Troubleshooting.....</b>	<b>5-1</b>
	Introduction.....	5-3
	Maintenance.....	5-3
	Clean the Product.....	5-3
	Moisture Removal.....	5-3
	Clean the Insert.....	5-3
	Change the Fuses.....	5-3
	User-Replaceable Parts and Accessories.....	5-5
	Troubleshooting.....	5-5



# **List of Tables**

<b>Table</b>	<b>Title</b>	<b>Page</b>
1-1.	Symbols.....	1-4
2-1.	Controller Controls and Indicators.....	2-3
2-2.	Display and Control Panel.....	2-4
2-3.	-P Option Panel (Input Panel) .....	2-5
2-4.	Power and Remote Interface Panel .....	2-6
2-5.	Main Screen .....	2-7
2-6.	Parts and Accessories.....	2-8
2-7.	Security Levels.....	2-10
2-8.	Menu Navigation.....	2-11
2-9.	Temperature Setup Menu .....	2-12
2-10.	Cutout Menu.....	2-13
2-11.	Cooler Status Menu.....	2-14
2-12.	Program Setup Menu.....	2-15
2-13.	Ramp/Soak Setup Menu.....	2-15
2-14.	Test Result Menu .....	2-16
2-15.	Display Setup Menu .....	2-17
2-16.	Communication Setup Menu.....	2-18
2-17.	Date and Time Setup Menu.....	2-18
2-18.	Calibration Setup Menu .....	2-19
2-19.	Control Setup Menu .....	2-20
2-20.	Reference Input Calibration Menu .....	2-21
2-21.	TC Input Calibration Menu .....	2-21
2-22.	mA Input Calibration Menu .....	2-22
2-23.	System Information Menu.....	2-22
2-24.	Select Unit Input Menu .....	2-23
2-25.	RTD Setup Menu .....	2-24
2-26.	TC Setup Menu .....	2-25
2-27.	mA Setup Menu .....	2-25
2-28.	Test UUT Calculation Menu .....	2-26
2-29.	Reference Probe Setup Menu.....	2-27
2-30.	Test Calculation Menu .....	2-28
3-1.	Power and Remote Interface Panel .....	3-3
3-2.	Communication Setup Menu.....	3-5
3-3.	Communication Setup Menu.....	3-6
3-4.	Commands by Function or Group.....	3-8

3-5.	PROG:SEQ:PAR Parameters.....	3-19
4-1.	Calibration Terminology.....	4-5
4-2.	Calibration Equipment.....	4-6
4-3.	As Found Accuracy Results.....	4-8
4-4.	As Found Uniformity Results.....	4-9
4-5.	As Found Stability Specifications.....	4-9
4-6.	Accuracy Calibration Parameter Serial Commands.....	4-12
4-7.	As Left Accuracy Specifications.....	4-13
4-8.	As Left Uniformity Results.....	4-13
4-9.	As Left Stability Specifications.....	4-14
4-10.	Calibration Terminology.....	4-15
4-11.	External Reference Calibration Equipment Specifications.....	4-16
4-12.	Standard Resistor Specificatons.....	4-16
4-13.	Reference Probe and UUT PRT Input Process.....	4-17
4-14.	Thermocouple Input Testing Process.....	4-21
4-15.	4-20 mA Input Calibration Steps.....	4-23
5-1.	User-Replaceable Parts and Accessories.....	5-5
5-2.	Troubleshooting Chart.....	5-6



# List of Figures

<b>Figure</b>	<b>Title</b>	<b>Page</b>
1-1.	9190A Ultra-Cool Drywell (-P Option Shown) .....	1-3
2-2.	Program Menu.....	2-14
2-4.	Input Menu .....	2-23
2-5.	Clamp-On Ferrite Installation .....	2-29
2-7.	PRT/RTD Probe Setup .....	2-32
2-8.	Insert Installation and Removal.....	2-34
2-10.	Set Temperature SETPOINT .....	2-36
2-12.	Edit SETPOINT Preset .....	2-37
2-13.	Soft Cutout .....	2-38
4-1.	Change the Product Fuses .....	4-4
4-2.	Calibration Procedure.....	4-5
4-3.	Test Sleeve Orientation .....	4-8



# **Chapter 1**

## ***Product Overview and Specifications***

<b>Title</b>	<b>Page</b>
Product Overview .....	1-3
Safety Information .....	1-4
Manual Set .....	1-5
Contact Fluke Calibration .....	1-5
Calibration and Repair Information .....	1-6
Specifications .....	1-6
Base Unit Specifications .....	1-6
-P Specifications .....	1-7



## Product Overview

The Fluke Calibration 9190A Ultra-Cool Drywell (the Product or Calibrator) is a bench-top temperature calibrator that can calibrate precision temperature instruments from  $-95\text{ }^{\circ}\text{C}$  to  $140\text{ }^{\circ}\text{C}$  (see Figure 1-1).

The Calibrator has two models: the 9190A and the 9190A-P. The 9190A-P is a “Process” version of the 9190A that combines the heat source with a built-in thermometer input panel. The Input Panel includes an input for an external reference/control thermometer that makes it possible to perform a transmitter loop calibration, comparison calibration, or a simple check of a temperature sensor. In addition, the Input Panel can read resistance and current from a probe. For probes that require power to operate, the 4-20 mA input has a loop-power function that can source up to 24 volts of power.

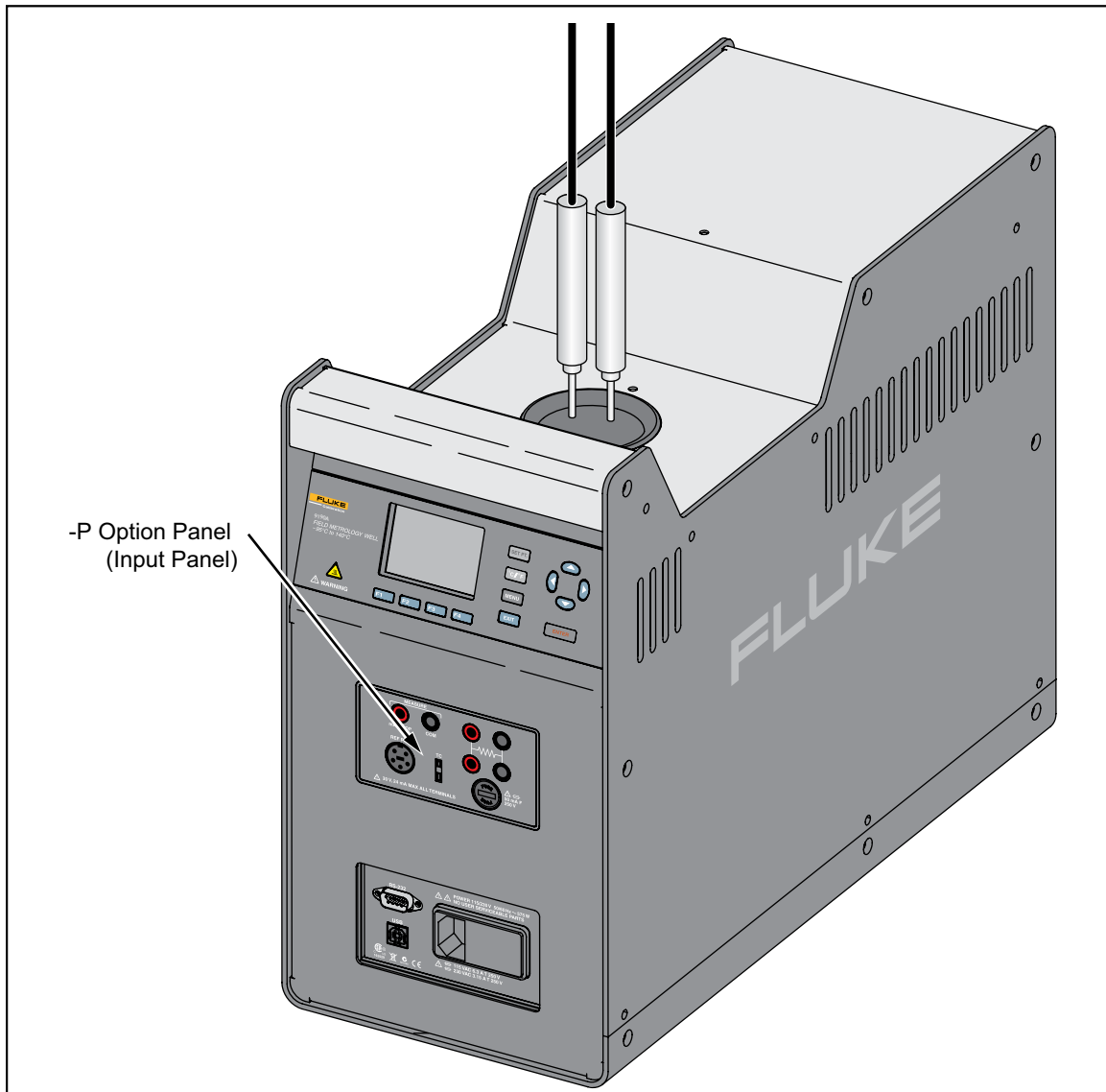

Figure 1-1. 9190A Ultra-Cool Drywell (-P Option Shown)







gzs053.eps

## Safety Information

A **Warning** identifies conditions and procedures that are dangerous to the user. A **Caution** identifies conditions and procedures that can cause damage to the Product or the equipment under test.

See Table 1-1 for a list of symbols used in this manual and on the Calibrator.

Table 1-1. Symbols

Symbol	Description	Symbol	Description
	Conforms to European Union directives		Conforms to relevant North American Safety Standards.
	Risk of Danger. Important information. See manual.		Conforms to relevant Australian EMC requirements
	Earth ground		Hazardous voltage
	This product complies with the WEEE Directive (2002/96/EC) marking requirements. The affixed label indicates that you must not discard this electrical/electronic product in domestic household waste. Product Category: With reference to the equipment types in the WEEE Directive Annex I, this product is classed as category 9 "Monitoring and Control Instrumentation" product. Do not dispose of this product as unsorted municipal waste. Go to Fluke's website for recycling information.		

### **Warning**

To prevent possible electrical shock, fire, or personal injury:

- Read all safety information before you use the Product.
- Use the Product only as specified, or the protection supplied by the Product can be compromised.
- Use this Product indoors only.
- Do not use the Product around explosive gas, vapor, or in damp or wet environments.
- Do not use and disable the Product if it is damaged.
- Use only the mains power cord and connector approved for the voltage and plug configuration in your country and rated for the Product.
- Replace the mains power cord if the insulation is damaged or if the insulation shows signs of wear.
- Make sure the ground conductor in the mains power cord is connected to a protective earth ground. Disruption of the protective earth could put voltage on the chassis that could cause death.
- Do not put the Product where access to the mains power cord is blocked.
- Use caution when you install and remove probes and inserts from the Product. They can be hot.

- Do not touch voltages > 30 V ac rms, 42 V ac peak, or 60 V dc.
- Do not apply more than the rated voltage, between the terminals or between each terminal and earth ground.
- Do not touch the well access surface of the instrument.
- Do not turn off the product at block temperatures higher than 100 °C. Select a SETPOINT less than 100 °C and let the instrument to cool before turning it off.
- Use the correct terminals, function, and range for measurements.
- Do not use test leads if they are damaged. Examine the test leads for damaged insulation, exposed metal, or if the wear indicator shows. Check test lead continuity.
- Do not touch the probes to a voltage source when the test leads are connected to the current terminals.
- Keep fingers behind the finger guards on the probes.
- Do not exceed the Measurement Category (CAT) rating of the lowest rated individual component of a Product, probe, or accessory.

## **Manual Set**

The Calibrator includes an Operators Manual and a Getting Started Manual.

This *9190A Operators Manual* contains feature information, operation instructions, and basic user maintenance and troubleshooting information.

The *9190A Getting Started Manual* is translated and contains basic information to quickly set up and use the Calibrator.

The *9190A Product CD* contains the Operators Manual, the Getting Started Manual, and the 9190A Remote Operation interface drivers.

## Calibration and Repair Information

To schedule and send the Calibrator to Fluke for calibration or repair:

1. Contact the Fluke Calibration Service Center in your area to schedule the calibration or repair (see “Contact Fluke Calibration” on page 1-5).
2. Pack and secure the Calibrator in a shipment box with a minimum of 2 inches of packing around the Calibrator to prevent damage.
3. Send the Calibrator to the Service Center.

## Specifications

### Base Unit Specifications

<b>Temperature Range at 23 °C</b> .....	-95 °C to 140 °C (-139 °F to 284 °F)
<b>Display Accuracy</b> .....	±0.2 °C Full Range
<b>Accuracy with External Reference</b> <sup>[3]</sup> .....	±0.05 °C Full Range
<b>Stability</b> .....	±0.015 °C Full Range
<b>Axial Uniformity at 40 mm (1.6 in)</b> .....	±0.05 °C Full Range
<b>Radial Gradient</b> .....	±0.01 °C Full Range
<b>Loading Effect</b>	
(with a 6.35 mm reference probe and three 6.35 mm probes) .....	±0.006 °C Full Range
(versus display with 6.35 mm probes) .....	±0.25 °C at -95 °C ±0.10 °C at 140 °C
<b>Operating Conditions</b> .....	0 °C to 35 °C, 0 % to 90 % RH (non-condensing) < 2000 m altitude
<b>Environmental conditions for all specifications except temperature range</b> .....	13 °C to 33 °C
<b>Immersion (Well) Depth</b> .....	160 mm (6.3 in)
<b>Well Diameter</b> .....	30 mm (1.18 in)
<b>Heating Time</b> <sup>[1]</sup> .....	-95 °C to 140 °C: 40 min
<b>Cooling Time</b> <sup>[1]</sup> .....	23 °C to -90 °C: 80 min 23 °C to -95 °C: 90 min 140 °C to 23 °C: 60 min
<b>Stabilization Time</b> <sup>[2]</sup> .....	15 min
<b>Resolution</b> .....	0.01 °
<b>Display</b> .....	LCD, °C or °F user selectable
<b>Size (H x W x D)</b> .....	480 mm x 205 mm x 380 mm (18.8 in x 8.0 in x 14.9 in)
<b>Weight</b> .....	16 kg (35 lb)
<b>Power Requirements</b> .....	100 V to 115 V (±10 %) 50/60 Hz, 575 W 200 V to 230 V (±10 %) 50/60 Hz, 575 W
<b>System Fuse Ratings</b> .....	115 V: 6.3 A T 250 V 230 V: 3.15 A T 250 V
<b>4–20 mA Fuse (-P model only)</b> .....	50 mA F 250 V
<b>Computer Interface</b> .....	RS-232, USB Serial, and 9930 Interface-it Temperature Calibration Software included
<b>Safety</b> .....	IEC 61010-1, Installation Category II, Pollution degree 2
<b>Electromagnetic Environment</b> .....	IEC 61326-1: Basic
<b>Refrigerants</b>	
R32 (Difluoromethane) .....	< 20 g, ASHRAE Safety Group A2L
R704 (Helium) .....	< 20 g, ASHRAE Safety Group A1



**-P Specifications**

**Built-in Reference Thermometer Readout**

**Accuracy (4-Wire Reference Probe)** <sup>[3]</sup> .....  $\pm 0.010$  °C at -95 °C  
 $\pm 0.013$  °C at -25 °C  
 $\pm 0.015$  °C at 0 °C  
 $\pm 0.020$  °C at 50 °C  
 $\pm 0.025$  °C at 140 °C

**Reference Resistance Range**..... 0  $\Omega$  to 400  $\Omega$

**Reference Resistance Accuracy** <sup>[4]</sup> ..... 0  $\Omega$  to 42  $\Omega$ :  $\pm 0.0025$   $\Omega$   
42  $\Omega$  to 400  $\Omega$ :  $\pm 60$  ppm of reading

**Reference Characterizations** ..... ITS-90, CVD, IEC-751, Resistance

**Reference Measurement Capability** ..... 4 wire

**Reference Probe Connection** ..... 6-Pin Din with INFO-CON Technology

**Built-in RTD Thermometer Readout Accuracy** .. NI-120:  $\pm 0.015$  °C at 0 °C  
PT-100 (385):  $\pm 0.02$  °C at 0 °C  
PT-100 (3926):  $\pm 0.02$  °C at 0 °C  
PT-100 (JIS):  $\pm 0.02$  °C at 0 °C

**RTD Resistance Range**..... 0  $\Omega$  to 400  $\Omega$

**Resistance Accuracy** <sup>[4]</sup> ..... 0  $\Omega$  to 25  $\Omega$ :  $\pm 0.002$   $\Omega$   
25  $\Omega$  to 400  $\Omega$ :  $\pm 80$  ppm of reading

**RTD Characterizations** ..... PT-100 (385),(JIS),(3926), NI-120, Resistance

**RTD Measurement Capability** ..... 2-wire, 3-wire, and 4-wire RTD with Jumpers only

**RTD Connection**..... 4-terminal input

**Built-in TC Thermometer Readout Accuracy** <sup>[5]</sup> . Type J:  $\pm 0.70$  °C at 140 °C  
Type K:  $\pm 0.75$  °C at 140 °C  
Type T:  $\pm 0.60$  °C at 140 °C  
Type E:  $\pm 0.60$  °C at 140 °C  
Type R:  $\pm 1.60$  °C at 140 °C  
Type S:  $\pm 1.60$  °C at 140 °C  
Type M:  $\pm 0.65$  °C at 140 °C  
Type L:  $\pm 0.65$  °C at 140 °C  
Type U:  $\pm 0.70$  °C at 140 °C  
Type N:  $\pm 0.75$  °C at 140 °C  
Type C:  $\pm 1.00$  °C at 140 °C

**TC Millivolt Range**..... -10 mV to 75 mV

**Voltage Accuracy**..... 0.025 % of reading +0.01 mV

**Internal Cold Junction**

**Compensation Accuracy**.....  $\pm 0.35$  °C (ambient of 13 °C to 33 °C)

**TC Connection** ..... Miniature Connectors (ASTM E1684)

**Built-in mA Readout Accuracy** ..... 0.02 % of reading + 0.002 mA

**mA Range** ..... Cal 4-22 mA, Spec 4-24 mA

**mA Connection** ..... 2 terminal input

**Loop Power Function** ..... 24 VDC loop power

**Built-in Electronics Temperature Coefficient**

**(0 °C to 13 °C, 33 °C to 50 °C)**.....  $\pm 0.005$  % of range per °C

Notes:

[1] – For ambient temperature of 23 °C.

[2] – Time from when the SETPOINT is reached to when the unit is with in Stability specification.

[3] – The temperature range may be limited by the reference probe connected to the readout. The built-in Reference Accuracy does not include the sensor probe accuracy. It does not include the probe uncertainty or probe characterization errors.

[4] – Measurement accuracy specifications apply within the operating range and assume 4 wires for PRTs. With 3-wire RTDs add 0.05  $\Omega$  to the measurement accuracy plus the maximum possible difference between the resistances of the lead wires.

[5] – The thermocouple input readout is sensitive to EM fields in the frequency range of 500 MHz to 700 MHz.



# Chapter 2 Operation

	<b>Title</b>	<b>Page</b>
Introduction.....		2-3
Calibrator Features.....		2-3
Display and Control Panel.....		2-4
-P Option Panel (Input Panel).....		2-5
Power and Remote Interface Panel.....		2-6
Startup and Main Screen .....		2-6
Calibrator Setup .....		2-8
Unpack and Inspect .....		2-8
Placement .....		2-8
Connect to Mains Power .....		2-9
Turn On the Product .....		2-9
Change Language .....		2-9
Set Display Contrast.....		2-9
Toggle Key Beep On or Off.....		2-10
Security and Password.....		2-10
Menus and Menu Navigation.....		2-11
Temperature Setup Menu (TEMP SETUP).....		2-11
Temperature Setup .....		2-12
Cutout.....		2-13
Cooler Status .....		2-14
Program Menu (PROG MENU).....		2-14
Program Setup.....		2-15
Ramp/Soak .....		2-15
Test Result (-P Only) .....		2-16
System Menu (SYSTEM MENU).....		2-17
Display Setup .....		2-17
Communications Setup .....		2-18
Date/Time Setup (-P Only) .....		2-18
Calibration Setup Menu.....		2-19
Calibration Points Setup.....		2-19
Control Setup .....		2-20
Reference Input Calibration (-P Only).....		2-21
TC Input Calibration (-P Only).....		2-21
mA Input Calibration (-P Only).....		2-22
System Information.....		2-22
Input Setup Menu (INPUT SETUP).....		2-23
Select Unit Input Menu (-P Only).....		2-23
RTD Setup.....		2-24

TC Setup .....	2-25
mA Setup.....	2-25
Test UUT Calculation .....	2-26
REF Input Menu.....	2-26
Reference Probe Setup .....	2-27
Test Calculation Menu .....	2-28
Probe Preparation.....	2-29
Clamp-On Ferrites .....	2-29
Reference PRT Connection Preparation.....	2-29
4-Wire Reference Probe Wiring Instructions.....	2-29
2-Wire Reference Probe Wiring Instructions.....	2-29
Reference Probe Input Setup.....	2-31
PRT/RTD Connection Preparation.....	2-32
Operation .....	2-33
Insert Installation and Removal Procedure.....	2-33
Probe Insertion and Removal Procedure .....	2-35
Set Temperature.....	2-36
Set the Temperature SETPOINT Manually .....	2-36
Set the Temperature with a Preset SETPOINT .....	2-36
Change a Preset SETPOINT .....	2-37
Cancel or Stop Temperature Change.....	2-37
Set a Soft Cutout.....	2-37
Reset an Over-Temperature Cutout.....	2-38
Programs (Automated Tests) .....	2-38
Run a Program.....	2-38
Stop a Program.....	2-38

## Introduction

This chapter supplies instructions on how to set up and operate the Calibrator. The control panels and features of the Calibrator are described first, followed by setup, menus, and operation.

## Calibrator Features

Table 2-1 identifies and describes the panels on the front of the Calibrator.

**Table 2-1. The 9190A Front Panel**

Item	Name	Function
①	Display and Control Panel	Control panel and display. See “Display and Control Panel” on page 2-4.
②	-P Option Panel (Input Panel)	Input panel used to connect to external sensors and probes. Panel is only available on the “-P” model. See “-P Option Panel” on page 2-5.
③	Power and Remote Interface Panel	Power module and Remote Interface Panel. See “Power and Remote Interface Panel” on page 2-6.

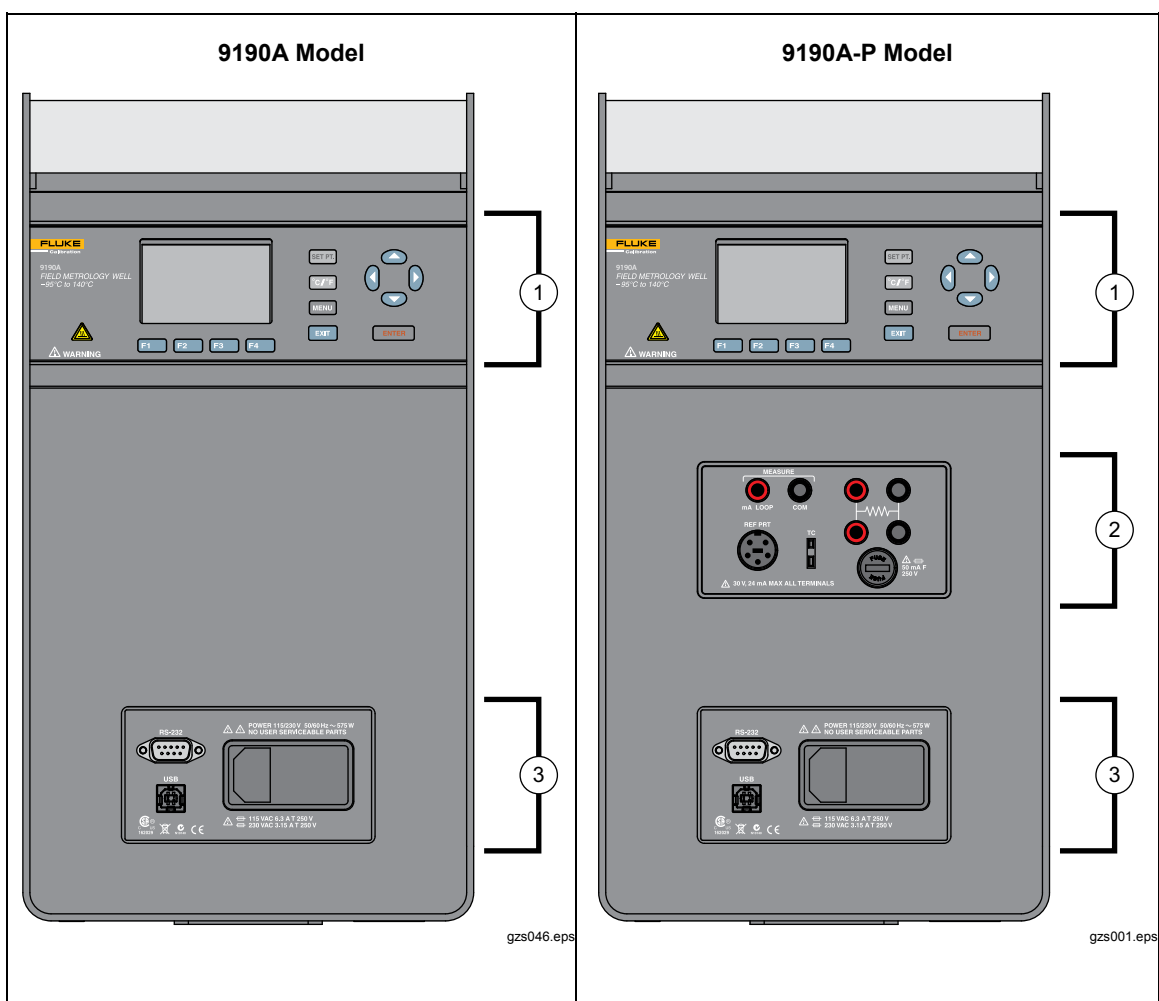

## Display and Control Panel

Table 2-2 shows and describes the function of each button on the Control Panel.

**Table 2-2. Display and Control Panel**

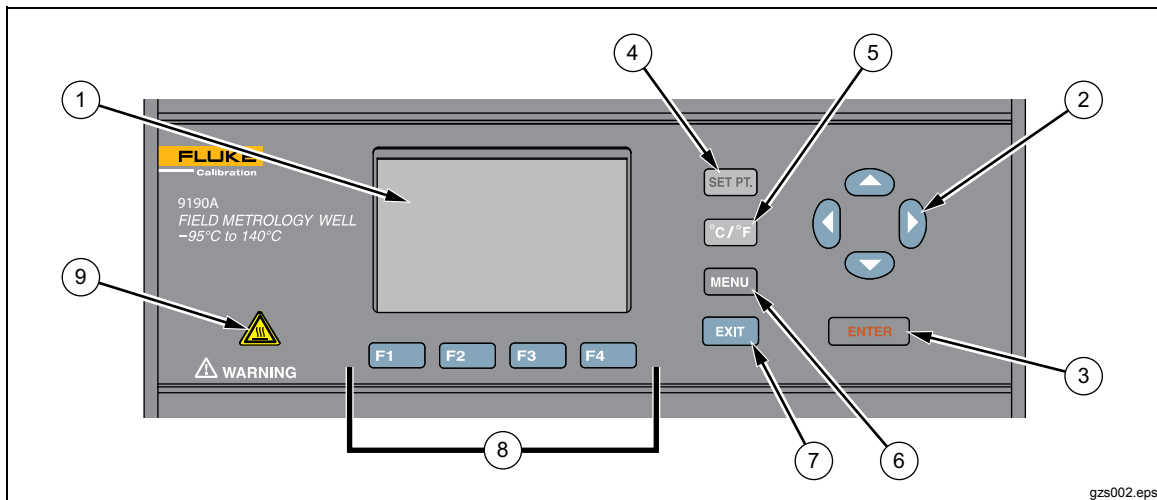

gzs002.eps

Item	Name	Function
①	Display	Shows block temperature, measurements, status information, operating parameters, and softkey functions. The contrast of the display is adjustable. To adjust the contrast, push ▲ to increase contrast or ▼ to decrease contrast while the Main screen is shown.
②	Arrow Keys ▲ ▼ ◀ ▶	Navigates through menu selections, increases or decreases numbers, and scrolls menus up or down.
③	Enter Key <b>ENTER</b>	Selects menus and sets new values.
④	SET Point Key <b>SET PT.</b>	Set a SETPOINT temperature to heat or cool to.
⑤	°C/°F Key <b>°C/°F</b>	Switches the displayed temperature units between °C and °F. Key is enabled only when the Main screen is shown. <i>Note</i> <i>This key is disabled in some regions of the world.</i>
⑥	Menu Key <b>MENU</b>	Opens the Main menu. See “Menus and Menu Navigation” on page 2-10 for information on each menu and the settings found in the menus.
⑦	Exit Key <b>EXIT</b>	Cancel all changes and navigates back to the previous menu.
⑧	Softkeys <b>F1 F2 F3 F4</b>	Navigates the menus on the display. The functions of the softkeys are shown on the display above the buttons.
⑨	Block Temperature Indicator 	Visual safety indicator that illuminates when the block temperature is unsafe and extinguishes when the block temperature is safe. If the block temperature is unsafe and the Calibrator is turned off or the mains power cord is disconnected, the indicator flashes until the block temperature cools to a safe temperature. Do not transport or remove Inserts until the indicator is off.  <b>⚠ Warning</b> <b>For safe operation and maintenance of the product, do not remove Inserts when the Block Temperature indicator is illuminated.</b>

**-P Option Panel (Input Panel)**

Table 2-3 shows and describes the connectors and ports on the -P Option Panel. The optional process version -P Option Panel is also referred to as the Input Panel.

**Table 2-3. -P Option Panel (Input Panel)**

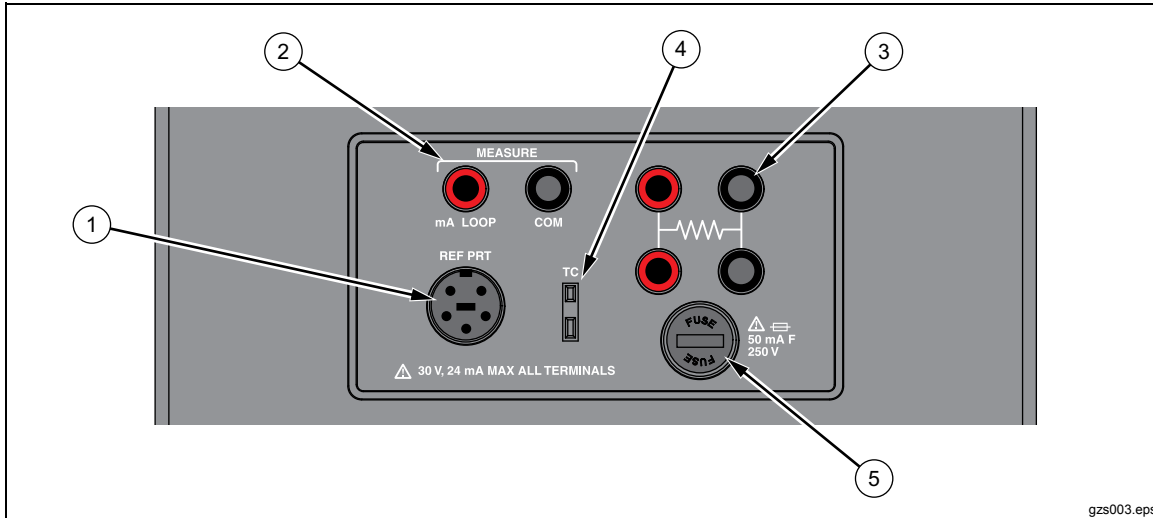

Item	Name	Function
①	Reference Thermometer Input (REF PRT)	<p>Connect a Reference PRT probe to the Calibrator for use with the reference thermometer function. The Reference Thermometer Input accepts 4-wire or 2-wire traditional 6-pin DIN Smart Connectors (see “Reference PRT Connection Preparation” on page 2-29).</p> <p>The Reference Thermometer Input can store calculated probe calibration coefficients. Coefficient values can be manually keyed into the readout or a characterization curve can be selected through the user interface.</p> <p style="text-align: center;"><i>Note</i></p> <p style="text-align: center;"><i>A Platinum Resistance Thermometer (PRT) is the only type of probe that is supported by the Reference Thermometer Input.</i></p>
②	4-20 mA Connectors	Connect a 4-20 mA transmitter to the Calibrator. The 4-20 mA Connectors can supply a low voltage (24 V) to power a transmitter. See “mA Setup” on page 2-25.
③	4-Wire PRT/RTD Connector	Connect a 4-wire, 3-wire, or 2-wire PRT/RTDs to be tested to the input. See “PRT/RTD Connection Preparation” on page 2-30.
④	Thermocouple (TC) Connector	Connect a thermocouple to be tested that is fitted with a subminiature thermocouple (TC) connector.
⑤	Fuse	Fuse for the 4-20 mA circuit. See Chapter 4 for fuse replacement instructions.

## Power and Remote Interface Panel

Table 2-4 shows and describes the connectors and ports on the Power and Remote Interface Panel.

**Table 2-4. Power and Remote Interface Panel**

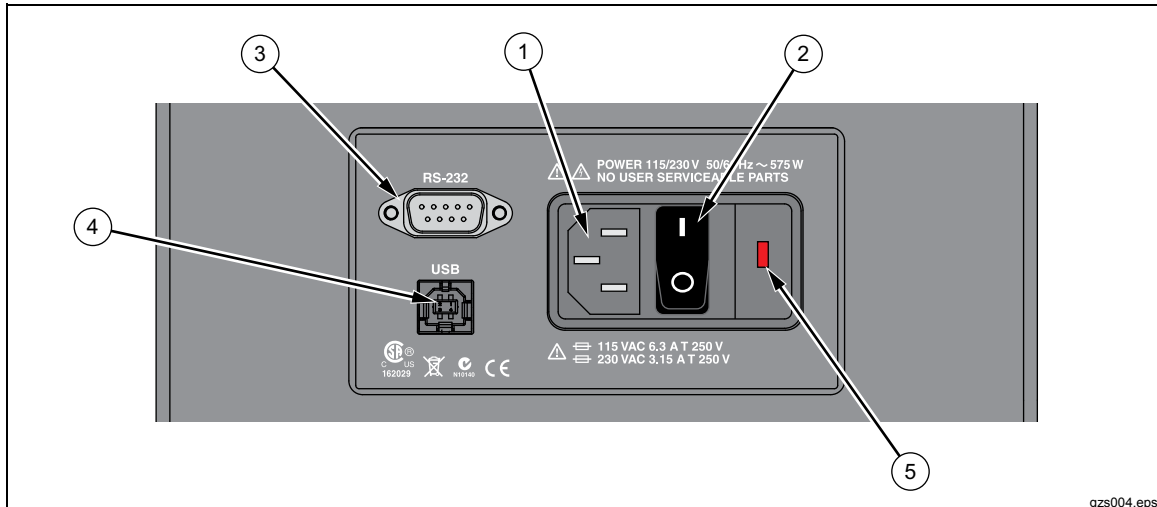

Item	Name	Function
①	Mains Power Cord Receptacle	Receptacle for the mains power cord. Use an AC mains supply appropriate for the voltage range and region of use.
②	Power Switch	Turn on (I) and turn off (O) the Calibrator.
③	9-pin Subminiature Serial Connector (RS-232)	Transmits measurements and remotely controls the operation of the instrument. See Chapter 3, "Remote Operation".
④	USB Serial Connector	Transmits measurements and remotely controls the operation of the instrument. See Chapter 3, "Remote Operation".
⑤	Fuse	Product fuse. See Chapter 4 for fuse replacement instructions.

## Startup and Main Screen

When the Calibrator turns on, the system initializes, does a self-check, then shows a startup screen that shows the model number and firmware version information. If the self-check finds an error, the error is shown on the Startup screen. Contact Fluke Calibration if an error shows on the Startup screen.

After the start-up initialization is complete, the Startup screen disappears and the Main screen shows on the display. Table 2-4 shows and describes the indicators on the Main screen.



Table 2-5. Main Screen

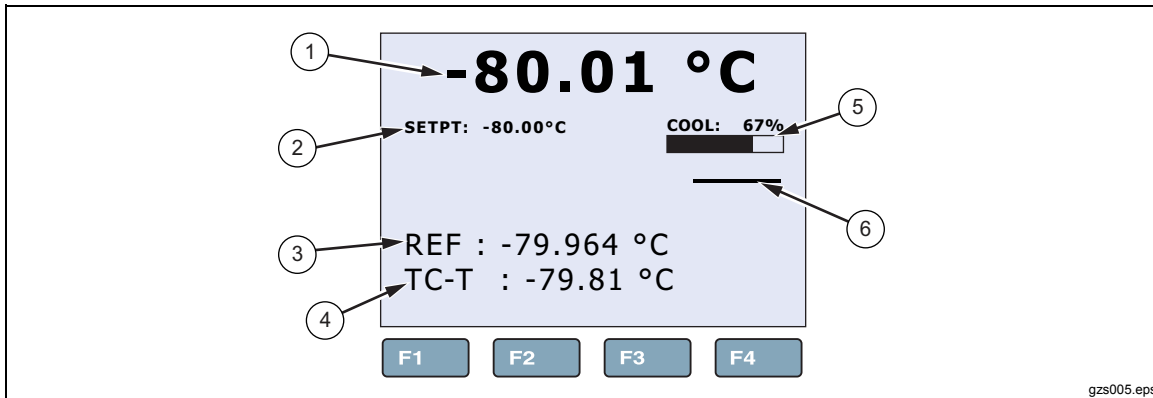

gzs005.eps

Item	Name	Function
①	Block Temperature	Temperature of the internal temperature block.
②	SETPOINT Temperature	Target SETPOINT temperature. A set temperature value is referred to as a "SETPOINT". The Calibrator uses the SETPOINT value to know what temperature to heat or cool to.
③	Reference Temperature <sup>[-P Only]</sup>	Shows the most recent reference measurement when a Reference PRT probe is connected and set up. See "Reference PRT Connection Preparation" on page 2-29.
④	UUT Output <sup>[-P Only]</sup>	Shows the most recent UUT output measurement of a probe that is connected and setup. The value shown depends on the output type selected in the Input Setup Menu (see page 2-23).
⑤	Heating/Cooling Status	Shows the mode the calibrator is in. The modes are: OFF, COOL, HEAT, and CUTOOUT. The bar under the mode corresponds to the percent heating or cooling. The bar is blank at 0 % when HEATING or COOLING is off or not necessary. The bar is completely dark at 100 % HEATING or COOLING. CUTOOUT is a feature that shuts off power to the heat source if the well temperature exceeds the set limit value. CUTOOUT shows when a limit has been exceeded. For more information on CUTOOUT, see "Cutout" on page 2-13.
⑥	Stability Status Indicator	<p>Visually shows if the block temperature is stable and within the Stability Limits.</p> <p>When temperature of the internal temperature block is not within the Stability Limits, the indicator shows a wavy line (~~~~). When the temperature is within the Stability Limits, the indicator shows as a flat line (---) which indicates that a measurement can be made. See "Stability Limits" on page 2-12.</p> <p style="text-align: center;"><i>Note</i></p> <p><i>To prevent inaccurate measurements, do not make measurements until the Stability Indicator shows as a flat line (---).</i></p>

## Calibrator Setup

### Unpack and Inspect

Unpack the instrument carefully and examine it for any damage that could have occurred during shipment. If there is shipping damage, notify the Fluke Calibration and the carrier immediately. Table 2-6 lists the equipment and the accessories that comes with the Calibrator. Verify that all the equipment and accessories in Table 2-6 are in the box.

**Table 2-6. Parts and Accessories**

Name	Quantity
9190-INSX Insert (X=A, B, C, D, E, or F)	1
2-meter (6-foot) Mains Power Cord	1
USB Cable	1
Getting Started Manual	1
Product CD that contains manuals and remote interface driver files	1
9930 Interface-it Calibration Software and Users Guide	1
Report of Calibration and Calibration Label	1
Well Insulator Cap	1
Insert Removal Tool	1
Clamp-on Ferrites (-P model only)	4
6-pin DIN Connector (-P model only)	1
Test Lead Kit (-P model only)	1

### Placement

Put the Calibrator on a clean, flat surface. Make sure the Calibrator is 150 mm (6 inches) away from all objects. For best results, choose a location to set up the Product where room temperature changes are minimum.

#### **Warning**

**To prevent possible fire or personal injury:**

- **Do not operate Product in orientations other than upright. A fire hazard can be made if the Product is put on its side.**
- **Do not remove Inserts when the Product shows temperatures more than 50 °C.**
- **Do not operate near flammable materials.**
- **Do not touch the well access surface of the Product.**
- **Do not turn off the Product when the temperature is above 100 °C. Set a SETPOINT temperature below 100 °C and let the Product cool.**

**⚠ Caution**

For safe operation and maintenance of the Product:

- Energize the Product for a 2-hour dry-out period before use, if the Product was:
  - In transport
  - In a humid or semi-humid storage environment
  - Not energized for more than 10 days

If the product is wet or has been in a wet environment, take necessary measures to remove moisture prior to applying power.

- Always operate this Product on a flat, level, stable surface.
- Do not store the Product at temperatures above 50 °C. The Product has a refrigeration system and contains gasses under pressure.
- Do not turn the Product upside down. The inserts will fall out.
- To prevent damage to the cooling system, do not tilt the Product on its side or upside down while the Product is operating.

**Connect to Mains Power**

Use the 2-meter (6-foot) mains power cord to connect the Product to a 120 V ac or 230 V ac outlet rated for at least 15 amps.

**Turn On the Product**

1. Push the “I” side of the power switch on the front panel of the Calibrator.
2. Monitor the Startup screen for errors while the product turns on. If an error shows, contact Fluke Calibration.

**Change Language**

To change the display language:

1. Push **MENU**.
2. Push **F3**.
3. Push **F1**.
4. Push **F1**.
5. Push **⬅** or **➡** to highlight a language.
6. Push **ENTER** to set language.

*Note*

If the incorrect language is set by accident, push softkeys **F1** and **F4** at the same time to temporarily switch back to the English language.

**Set Display Contrast**

With the Main screen shown in the display, push **▲** to increase or push **▼** to decrease display contrast.

### Toggle Key Beep On or Off

With the Main screen shown in the display, push **F1** and **F3** at the same time to enable or disable key beep.

### Security and Password

The Calibrator has two user-level access security levels (Low and High) to protect from undesired changes to the settings (see Table 2-7). The Calibrator comes from the factory with the security level set to High and a default password of “1234”.

If the password is not available, the information can still be viewed. To view the information without the password, push **ENTER** twice or push **EXIT** when prompted for the password. The information is then shown on the screen, but cannot be changed.

#### Note

*The Calibrator does not have a password reset function. If the password is lost, contact Fluke Calibration for password reset assistance.*

Table 2-7. Security Levels

Security Level	Definition
Low	Protects the specific metrological information and calibration information settings.
High	Protects all operating parameters. It is intended to minimize user choices, for example to perform repeated identical calibrations under consistent conditions.

To change the password:

1. Push **MENU**.
2. Push **F3**.
3. Push **F2**.
4. Enter the current 4-digit password to open the password screen (the default factory password is **1234**).
5. Push **◀** and **▶** to highlight a digit then push **▲** to increase the digit or push **▼** to decrease the digit.
6. Push **ENTER** to save the password.

To change the security level:

1. Push **MENU**.
2. Push **F3**.
3. Push **F2**.
4. Enter the current 4-digit password to open the password screen (the default factory password is **1234**).
5. Push **◀** and **▶** to highlight **HIGH** or **LOW**.
6. Push **ENTER** to save the selection.

## Menus and Menu Navigation

The Main menu (**MENU**) contains four submenus that supply access to all features, tools, and functions. The four submenus are: Temperature Setup, Program Setup, System, and Input Setup.

Table 2-8 shows and describes the buttons used to navigate the submenus.

**Table 2-8. Menu Navigation**

Button	Navigation Function
<b>F1</b> <b>F2</b> <b>F3</b> <b>F4</b>	Function softkeys to open submenus.
◀ ▶ ▲ ▼	Scroll menus, increases or decreases values, and highlights selections.
<b>ENTER</b>	Saves changes and navigates to the next menu.
<b>EXIT</b>	Cancel all changes and navigates back to the Main menu.

### Temperature Setup Menu (TEMP SETUP)

The Temperature Setup menu contains Field Metrology Well functions related to temperature setup. The TEMP SETUP menu has three submenus: SETUP, CUTOUT, and STATUS.

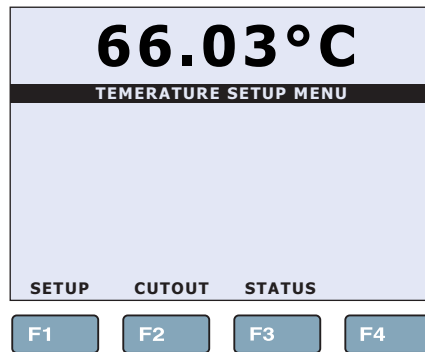

**Figure 2-1. Temperature Setup Menu**

gzs006.eps

## Temperature Setup

Table 2-9 shows and describes the menu selections on the Temperature Setup menu.

Table 2-9. Temperature Setup Menu

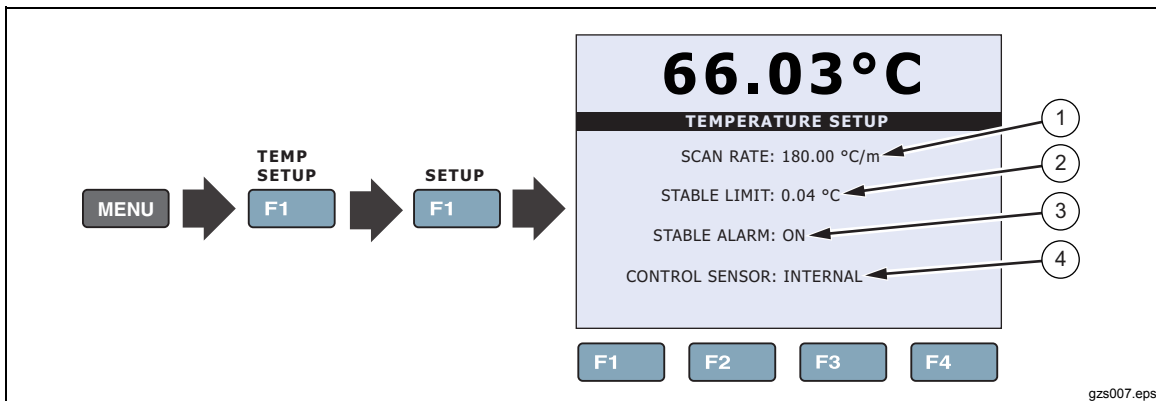

Item	Function
①	<p><b>SCAN RATE</b> sets the rate at which the Calibrator heats or cools in degrees per minute (°C/min or °F/min). The Scan Rate can be set from 0.1 °C/min to 500 °C/min (0.2 °F/min to 900 °F/min).</p> <p><i>Note</i></p> <p><i>The actual Scan Rate is limited to the natural rate the Product heats and cools. This is less than the maximum Scan Rate setting.</i></p>
②	<p><b>STABLE LIMIT</b> sets the temperature stability parameter the Calibrator uses to determine when the temperature is stable enough to make a measurement.</p> <p>When the temperature is within the range of the Stable Limit, the Calibrator shows a flat bar (---) on the Main screen (Stability Status Indicator) and audibly sounds the Stable Alarm if it is set to ON (see item ③). The Stable Alarm sounds once per SETPOINT.</p> <p>Example: A specific calibration process requires the instrument to operate within ±0.1°C. “0.1” is entered into the Stability Limit parameter. When the block temperature is within ±0.1°C, the Stability Status indicator on the Main screen changes to a flat line (---) and the Stable Alarm sounds once.</p> <p><i>Note</i></p> <p><i>The 9190A and 9190A-P should not be expected to operate better than the stability specification found in the Specifications section of this manual. Thus, the minimum setting of the Stability Limit should not be less than the stability specification. See the “Base Unit Specifications” in Chapter 1.</i></p>
③	<p><b>STABLE ALARM</b> turns on or turns off the audible Stable Alarm that sounds when the block temperature is within the Stable Limit. See item ②.</p>
④	<p><b>CONTROL SENSOR</b> <sup>[P Only]</sup> sets the Calibrator to use the internal sensor or an external sensor to control the block temperature. The Control Sensor setting has two options: Internal and Reference.</p> <p><i>Note</i></p> <p><i>Use of an external sensor such as a PRT can result in improved temperature accuracy.</i></p> <p>Internal tells the Calibrator to use the internal sensor for temperature control. In return, it relies on its own calibration for accuracy.</p> <p>Reference tells the Calibrator to use a PRT that is connected to the Reference Probe input (REF PRT) for temperature control. In this mode, the temperature of the reference PRT is measured and shown on the Main screen, and the block temperature is automatically adjusted so that the temperature of the Reference PRT aligns with the SETPOINT.</p>

**Cutout**

Table 2-10 shows and describes the menu selections on the Cutout menu.

**Table 2-10. Cutout Menu**

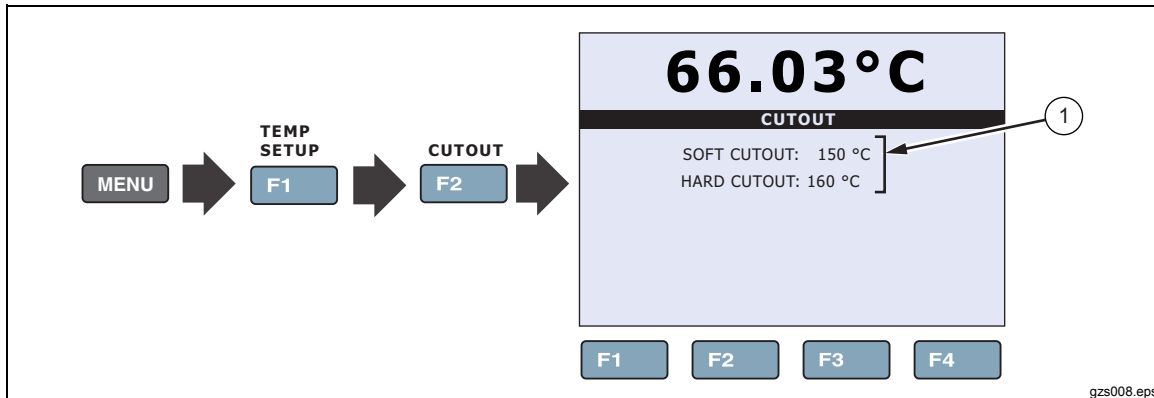

Item	Function
①	<p><b>SOFT CUTOUT</b> and <b>HARD CUTOUT</b> are limit parameters that shut off power to the heat source if the well temperature exceeds the set limit value.</p> <p>The Soft Cutout is a safety barrier to protect probes from temperatures more than their specified temperature limits.</p> <p>The Hard Cutout protects the Calibrator from irreparable internal damage. See “Set Soft Cutout” on page 2-37.</p> <p style="text-align: center;"><i>Note</i></p> <p><i>The Soft Cutout is user configurable and should be set within 5 °C to 10 °C above the temperature limit of the instrument being calibrated. The Hard Cutout is not user configurable and is set by the factory to approximately 160 °C.</i></p> <p>If the cutout is activated because of an excessive well temperature, the Calibrator enters a “Cutout mode” where power to the heat source is shut off to immediately cool the Calibrator and instrument. When in Cutout mode, the instrument displays “<b>CUTOUT</b>” above the Stability Status indicator. The instrument stays in Cutout mode until the temperature is below the cutout SETPOINT and the cutout is reset. See “Reset an Over-Temperature Cutout” on page 2-38.</p>

### Cooler Status

Table 2-11 shows and describes the menu selections on the Cooler Status menu.

*Note*

The information on the Cooler Status menu is not editable. Fluke Calibration Service Center personnel use this information to help troubleshoot the system if a malfunction occurs.

**Table 2-11. Cooler Status Menu**

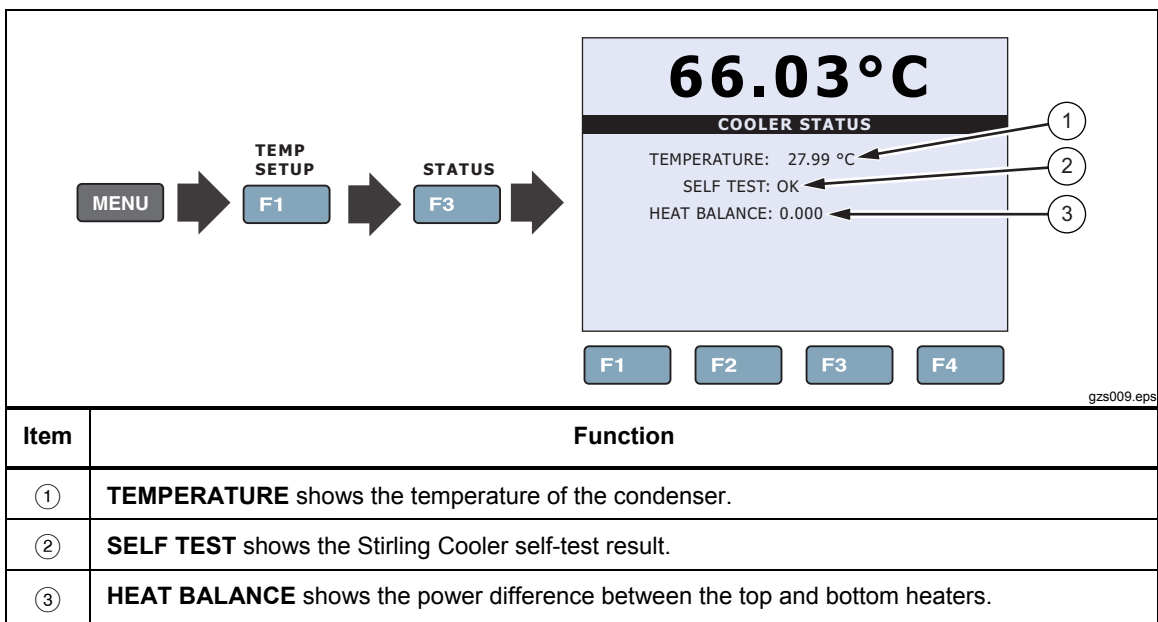

### Program Menu (PROG MENU)

The Program menu supplies access to the automated and manual program selections (see Figure 2-2). A Program is a test that can be configured and run to calibrate an instrument.

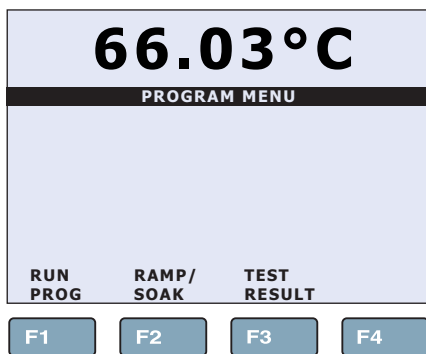

**Figure 2-2. Program Menu**



**Program Setup**

Table 2-12 shows and describes the menu selections on the Program Setup menu.

**Table 2-12. Program Setup Menu**

Item	Function
①	<b>TEST STATUS</b> starts (ON) or stops (OFF) a Program.
②	<b>RECORD DATA</b> <sup>[P Only]</sup> turns on (YES) or turns off (NO) the data record function of the Program.
③	<b>TEST ID</b> <sup>[P Only]</sup> is a unique identification of the Program. The identification can be an alpha-numeric entry up to 16 characters in length.

**Ramp/Soak**

Table 2-13 shows and describes the menu selections on the Ramp/Soak Setup menu.

**Table 2-13. Ramp/Soak Setup Menu**

Item	Function
①	<b>NO. SETPOINTS</b> is the number of SETPOINTS for a Program. Eight SETPOINTS can be set for the program. Set the maximum number of SETPOINTS necessary.
②	<b>SOAK TIME</b> is the duration (in minutes) that each of the programmed SETPOINTS temperature is maintained. The time starts when the temperature settles to within the specified stability. The Stability Limit is set in the Temperature Setup menu (see page 2-12).
③	<b>NO. CYCLES</b> is the number of times that the Program is repeated.

Table 2-13. Ramp/Soak Setup Menu (cont.)

Item	Function
④	<b>DIRECTION</b> controls whether the SETPOINTS are sequenced in one direction “→” (ascending from 1 to 8) or in both directions “↻” (ascending from 1 to 8 and then descending from 8 to 1) before the sequence is repeated. If the both directions option is selected, the Program sequences from the first SETPOINT to the last and then reverses direction sequencing from the last to the first.
⑤	<b>PASS TOLERANCE</b> <sup>[-P Only]</sup> is the allowable tolerance condition for the test and is used to highlight test points that have large errors.
⑥	<b>SETPOINTS MENU</b> opens a menu to set each of the SETPOINTS for the Program. Only the number of SETPOINTS defined by NO. SETPOINTS will be displayed.

**Test Result (-P Only)**

Table 2-14 shows and describes the menu selections on the Test Result menu. This menu is available on the -P Model only.

Table 2-14. Test Result Menu

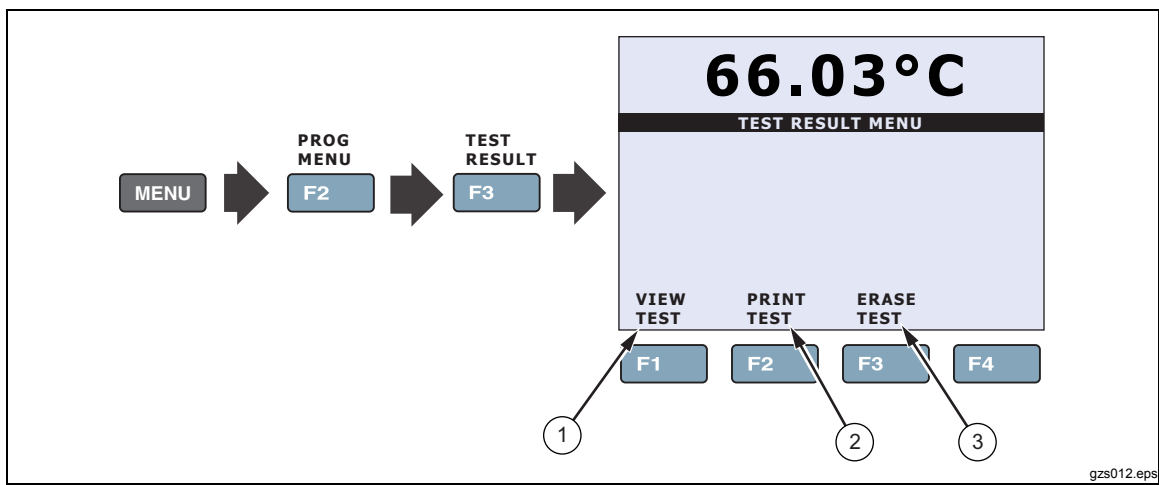

Item	Function
①	<b>VIEW TEST</b> <sup>[-P Only]</sup> opens a menu where test results can be viewed.
②	<b>PRINT TEST</b> <sup>[-P Only]</sup> opens a menu to select a programs results and transmit them to a PC to be printed. The data is transmitted from the RS-232 or USB port in ASCII format. Terminal emulator or other software can be used to receive the data and save it to a text file on a computer.
③	<b>ERASE TESTS</b> <sup>[-P Only]</sup> opens a menu to erase test results.

### System Menu (SYSTEM MENU)

The System menu lets the user set up the display settings, communications protocol, date/time settings (-P model only), password settings, calibrations settings, and view system information (see Figure 2-3).

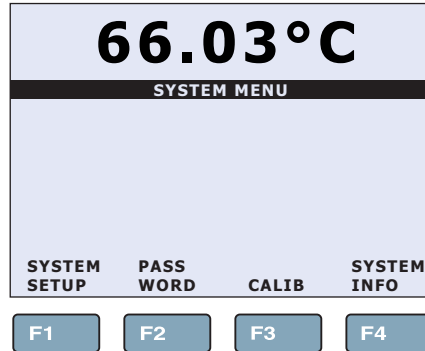

Figure 2-3. System Menu

gzs014.eps

### Display Setup

Table 2-15 shows and describes the menu selections on the Display Setup menu.

Table 2-15. Display Setup Menu

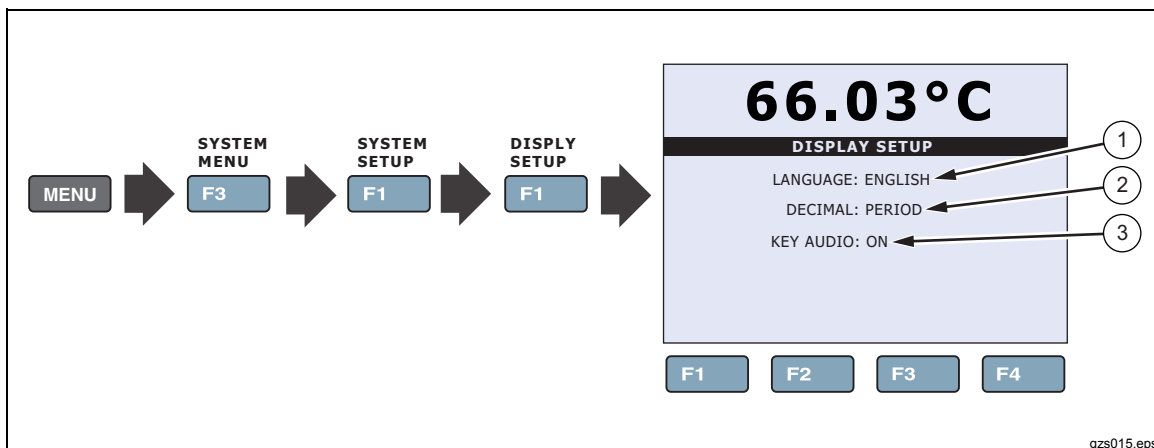

gzs015.eps

Item	Function
①	<b>LANGUAGE</b> sets the display language. See “Change Language” on page 2-9.
②	<b>DECIMAL</b> set the decimal separator to be a period (.) or a comma (,).
③	<p><b>KEY AUDIO</b> turns on (ON) or turns off (OFF) the key-beep sound. See “Toggle Key Beep On or Off” on page 2-10.</p> <p style="text-align: center;"><i>Note</i></p> <p><i>With the Main screen shown in the display, push <b>F1</b> and <b>F3</b> at the same time to quickly toggle key beep on or off.</i></p>

### Communications Setup

Table 2-16 shows and describes the menu selections on the Communication Setup menu.

**Table 2-16. Communication Setup Menu**

tem	Function
①	<b>BAUD RATE</b> is the serial communication transmission rate or baud rate. BAUD can be set to 1200, 2400, 4800, 9600, 19200, or 38400 baud.
②	<b>LINEFEED</b> turns on or turns off transmission of a line feed character (LF, ASCII 10) after transmission of a carriage-return.

### Date/Time Setup (-P Only)

Table 2-17 shows and describes the menu selections on the Date and Time Setup menu.

**Table 2-17. Date and Time Setup Menu**

Item	Function
①	<b>TIME</b> <sup>[-P Only]</sup> sets the internal time of the instrument. The Product uses a 24-hour clock.
②	<b>DATE</b> <sup>[-P Only]</sup> sets the date for the date and time stamp function.
③	<b>REPORT DATE</b> <sup>[-P Only]</sup> sets the date format used in the reports.

### Calibration Setup Menu

The Calibration Setup menu supplies access to all calibration parameters for the Calibrator. Calibration parameters are set at the factory when the instrument is calibrated. Access to these parameters is protected by a password to prevent unauthorized changes that could make the Calibrator inoperable. These parameters require periodic adjustments by trained, knowledgeable personnel to maintain the accuracy of the instrument. For Calibration instructions, see Chapter 4.

#### ⚠ Caution

**Do not change the values of the control parameters from the factory set values. Calibration parameters must be correct for the instrument to function properly.**

### Calibration Points Setup

Table 2-18 shows and describes the menu selections on the Calibration Points Setup menu.

**Table 2-18. Calibration Setup Menu**

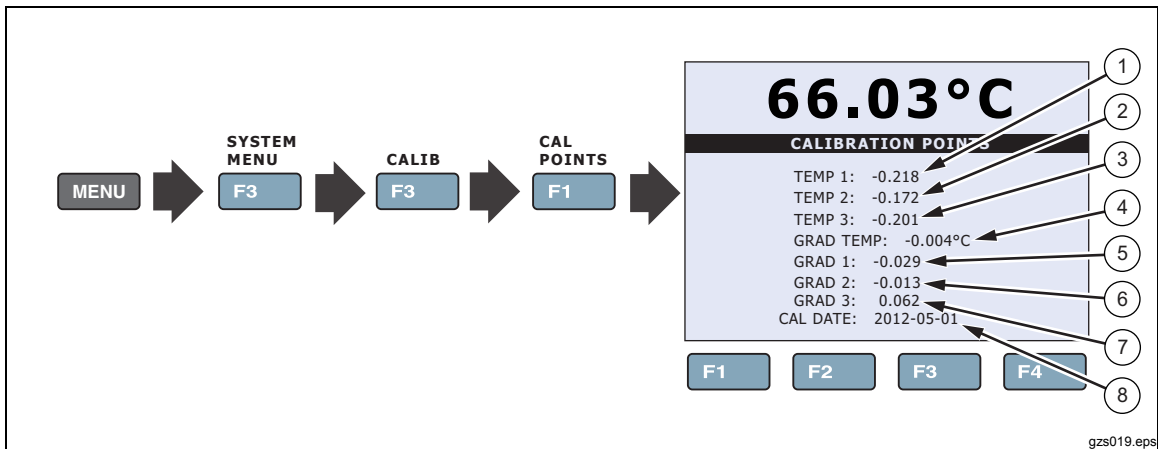

Item	Function
①	<b>TEMP 1</b> sets the offset in °C for the heat source accuracy at the 1 <sup>st</sup> calibration point.
②	<b>TEMP 2</b> sets the offset in °C for the heat source accuracy at the 2 <sup>nd</sup> calibration point.
③	<b>TEMP 3</b> sets the offset in °C for the heat source accuracy at the 3 <sup>rd</sup> calibration point.
④	<b>GRAD TEMP</b> is a view only parameter that shows the gradient temperature. Fluke Calibration Service Center personnel use this to help troubleshoot the system if a malfunction occurs.
⑤	<b>GRAD 1</b> sets the offset for the top zone heater control for the axial gradient calibration at the 1 <sup>st</sup> calibration point.
⑥	<b>GRAD 2</b> sets the offset for the top zone heater control for the axial gradient calibration at the 2 <sup>nd</sup> calibration point.
⑦	<b>GRAD 3</b> sets the offset for the top zone heater control for the axial gradient calibration at the 3 <sup>rd</sup> calibration point.
⑧	<b>CAL DATE</b> is the calibration date for the Calibrator.

## Control Setup

Table 2-19 shows and describes the menu selections on the Control Setup menu.

**Table 2-19. Control Setup Menu**

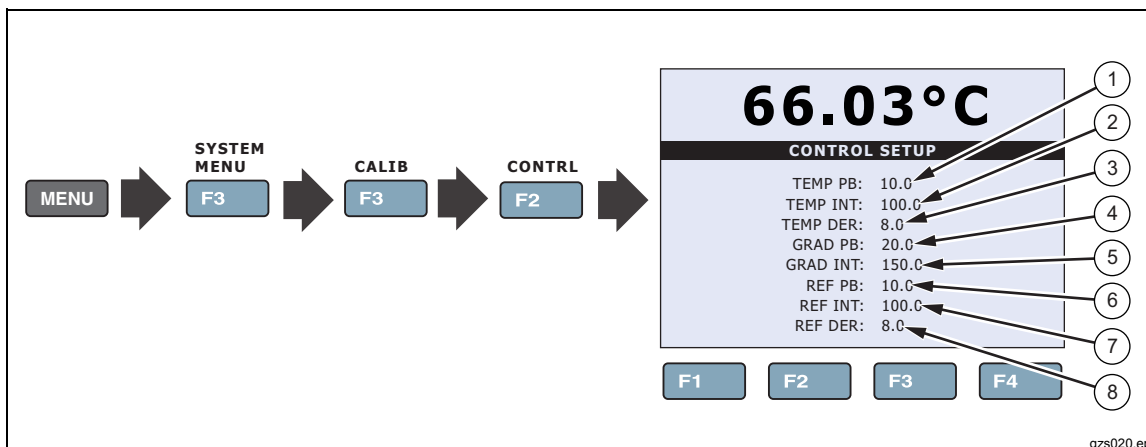

gzs020.eps

Item	Function
①	<b>TEMP PB</b> sets the main zone proportional band and the gain in °C that the proportional-integral-derivative (PID) controller uses for main zone control.
②	<b>TEMP INT</b> sets the main zone integral, which is the integration time in seconds that the PID controller uses for main zone control.
③	<b>TEMP DER</b> sets the main zone derivative, which is the derivative time in seconds that the PID controller uses for main zone control.
④	<b>GRAD PB</b> sets the gradient proportional band and the gain in °C at the proportional-integral-derivative (PID) controller uses for gradient zone control.
⑤	<b>GRAD INT</b> sets the gradient integral, which is the integration time in seconds that the PID controller uses for gradient zone control.
⑥	<b>REF PB</b> sets the main zone proportional band like item ① when an external reference probe is used for control.
⑦	<b>REF INT</b> sets the main zone integral like item ② when an external reference probe is used control.
⑧	<b>REF DER</b> sets the main zone derivative like item ③ when an external reference probe is used for control.

**Reference Input Calibration (-P Only)**

Table 2-20 shows and describes the menu selections on the Reference Input Calibration menu. This menu is available on the -P Model only.

**Table 2-20. Reference Input Calibration Menu**

Item	Function
①	<b>REF C0</b> <sup>[-P Only]</sup> adjusts the first calibration point for the reference resistance.
②	<b>REF C100</b> <sup>[-P Only]</sup> adjusts the second calibration point for the reference resistance.
③	<b>INPUT CAL DATE</b> <sup>[-P Only]</sup> is the calibration date for the readout.

**TC Input Calibration (-P Only)**

Table 2-21 shows and describes the menu selections on the TC Input Calibration menu. This menu is available on the -P Model only.

**Table 2-21. TC Input Calibration Menu**

Item	Function
①	<b>TC C0</b> <sup>[-P Only]</sup> adjusts the measurement at 0 mV.
②	<b>TC C100</b> <sup>[-P Only]</sup> adjusts the measurement at 100 mV.
③	<b>TC CRJ</b> <sup>[-P Only]</sup> adjusts the reference junction temperature measurement.
④	<b>INPUT CAL DATE</b> <sup>[-P Only]</sup> is the calibration date for the TC input.

*mA Input Calibration (-P Only)*

Table 2-22 shows and describes the menu selections on the mA Input Calibration menu. This menu is available on the -P Model only.

**Table 2-22. mA Input Calibration Menu**

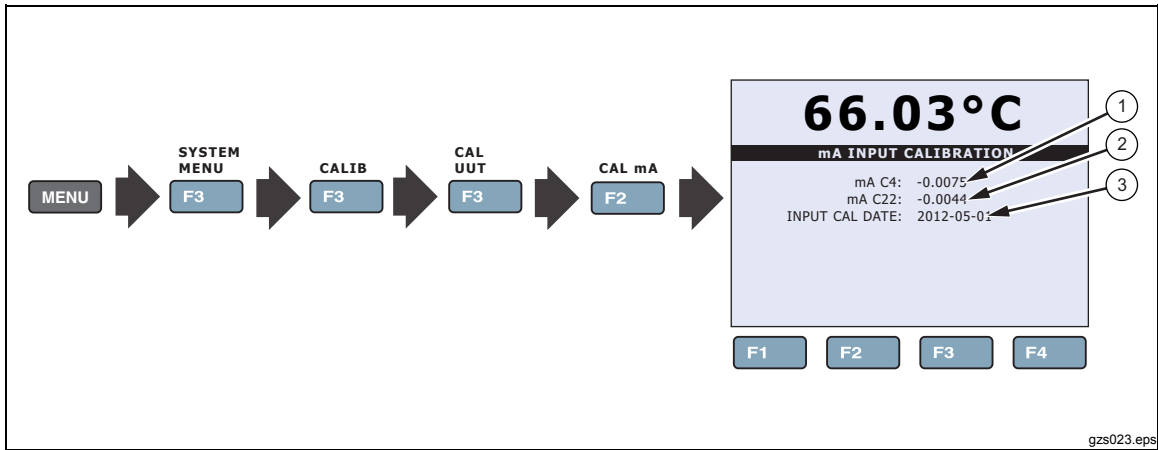

Item	Function
①	<b>mA C4</b> <sup>[-P Only]</sup> adjusts the measurement at 4 mA.
②	<b>mA C22</b> <sup>[-P Only]</sup> adjusts the measurement at 22 mA.
③	<b>INPUT CAL DATE</b> <sup>[-P Only]</sup> is the calibration date for the measurement function of the Calibrator.

*System Information*

Table 2-23 shows and describes the menu selections on the System Information menu.

**Table 2-23. System Information Menu**

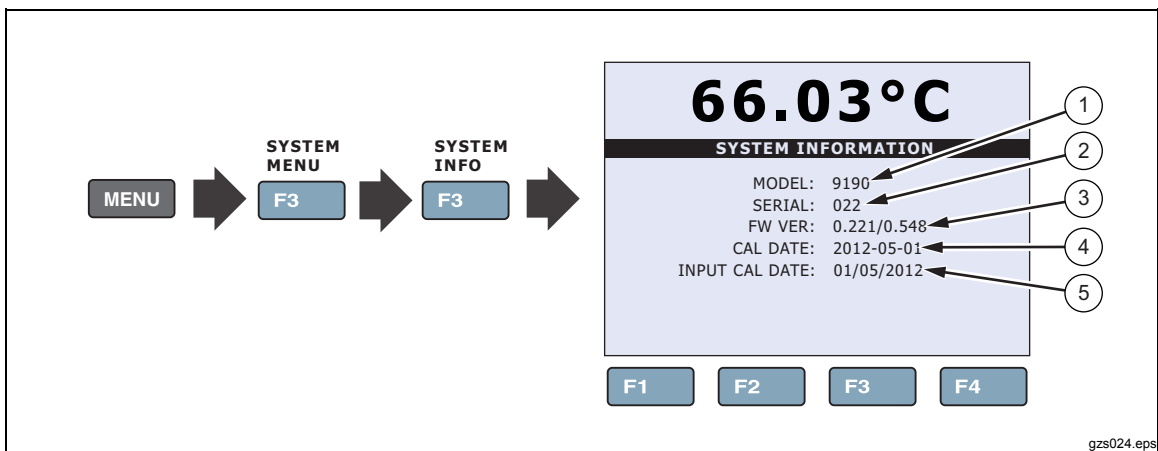

Item	Function
①	<b>MODEL</b> shows the model number of the Calibrator.
②	<b>SERIAL</b> shows the serial number of the Calibrator.
③	<b>FW VER</b> shows the firmware version of the Calibrator.
④	<b>CAL DATE</b> shows the calibration date of the heat source.
⑤	<b>INPUT CAL DATE</b> <sup>[-P Only]</sup> shows the calibration date for the readout or the -P module.



**Input Setup Menu (INPUT SETUP)**

The Input menu (INPUT MENU) supplies access to the parameters related to the -P module (process version) or readout function. The parameters found in this menu affect the performance, accuracy and display type of reference PRTs and UUTs used (see Figure 2-4). The menus in this section are available on the -P Model only.

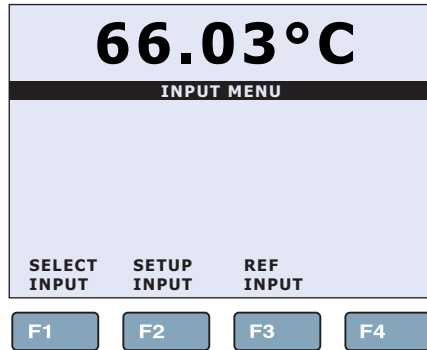

Figure 2-4. Input Menu

gzs026.eps

**Select Unit Input Menu (-P Only)**

Table 2-24 shows and describes the menu selections on the Select Unit Input menu. This menu is available on the -P Model only.

Table 2-24. Select Unit Input Menu

<p>The flowchart shows a sequence of menu screens. It starts with 'MENU', followed by 'INPUT SETUP' (accessed via F4), then 'SELECT INPUT' (accessed via F1), and finally the 'SELECT UNIT INPUT' menu. The 'SELECT UNIT INPUT' menu shows '66.03°C' at the top, 'SELECT UNIT INPUT' title, and 'SENSOR TYPE: TC'. A circled '1' points to the 'SENSOR TYPE: TC' text. Below the menu are four function keys: F1, F2, F3, and F4.</p>	
Item	Function
①	<b>SENSOR TYPE</b> sets the active input for the instrument connected. Selections are: mA, TC, and RTD.

gzs025.eps

## RTD Setup

Table 2-25 shows and describes the menu selections on the RTD Setup menu.

### Note

The selections in the *SETUP INPUT* menu is dependent on the *Sensor Type* selected in the *SELECT INPUT* menu. The *SETUP INPUT* menu is used to set up the *UUT* input or to run the test algorithm.

**Table 2-25. RTD Setup Menu**

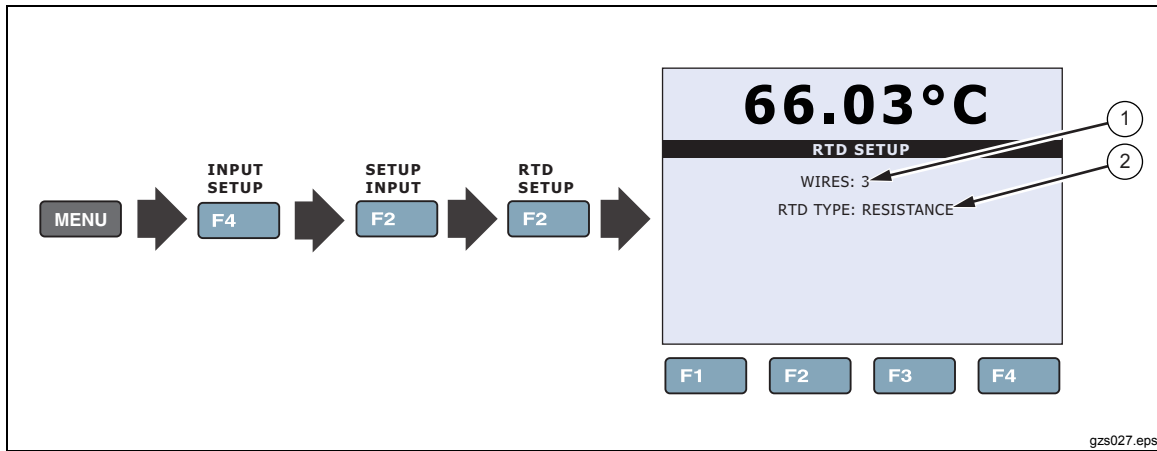

The diagram illustrates the navigation sequence for the RTD Setup menu. It starts with a 'MENU' button, followed by 'INPUT SETUP' (F4), 'SETUP INPUT' (F2), and 'RTD SETUP' (F2). The final screen shows a temperature reading of 66.03°C, the title 'RTD SETUP', 'WIRES: 3', and 'RTD TYPE: RESISTANCE'. Callouts 1 and 2 point to 'WIRES: 3' and 'RTD TYPE: RESISTANCE' respectively. Below the screen are four function buttons: F1, F2, F3, and F4.

Item	Function
①	<b>WIRES</b> configures the RTD input for a 2, 3, or 4-wire input.
②	<b>RTD TYPE</b> sets up the conversion type for the RTD. RTD characterization types include PT100(385), PT100(392), PT100(ITS), NI-120, and RESISTANCE.  <i>Note</i> <i>When RESISTANCE is selected the RTD resistance is shown instead of temperature.</i>

### TC Setup

Table 2-26 shows and describes the menu selections on the TC Setup menu.

**Table 2-26. TC Setup Menu**

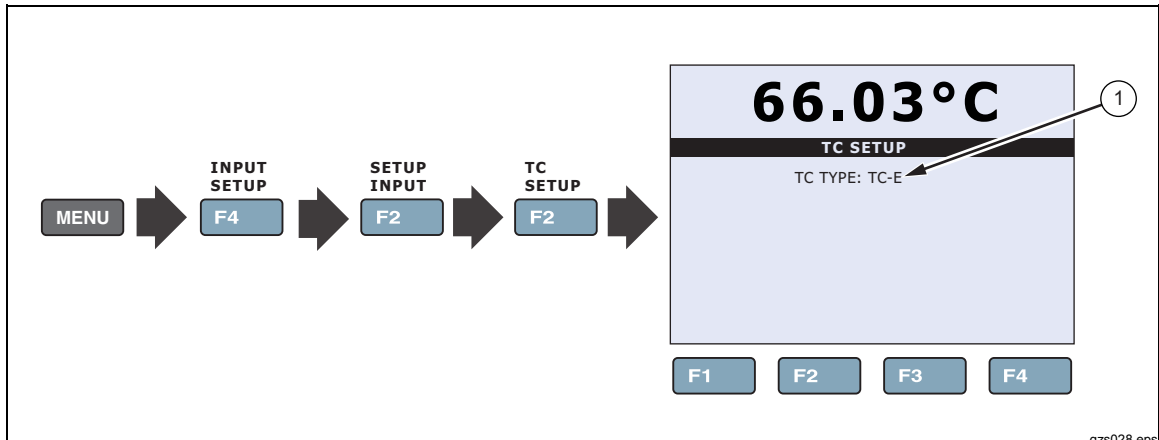

Item	Function
①	<p><b>TC TYPE</b> sets the thermocouple conversion type. Standard thermocouple conversions include types C, E, J, K, L, M, N, R, S, T, and U.</p> <p style="text-align: center;"><i>Notes</i></p> <p><i>When mV is selected, the TC Type shows the measurement in uncompensated millivolts rather than temperature.</i></p> <p><i>The cold junction compensation is measured at the input, automatically computed, then read by the Calibrator.</i></p>

### mA Setup

Table 2-27 shows and describes the menu selections on the mA Setup menu.

**Table 2-27. mA Setup Menu**

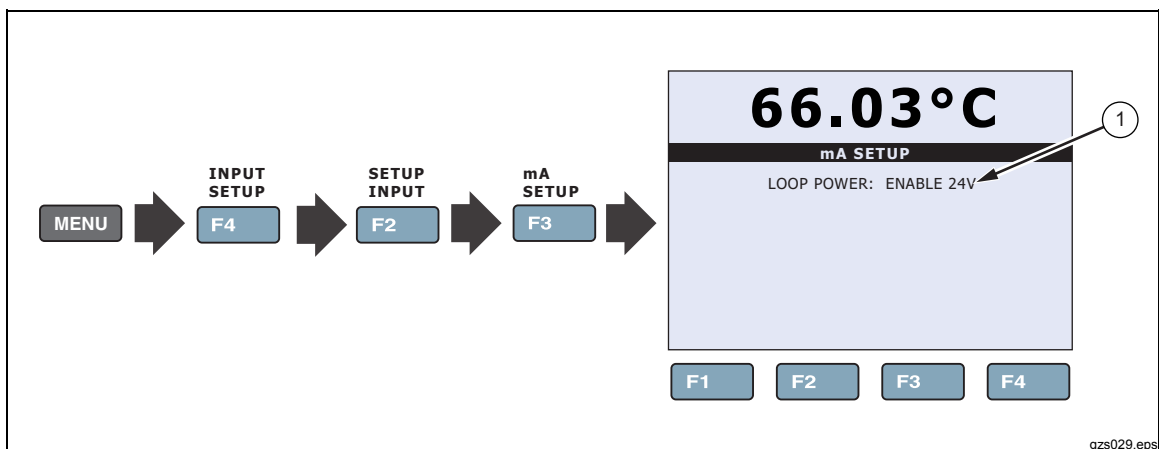

Item	Function
①	<p><b>LOOP POWER</b> turns on or turns off the 24 V loop power.</p>

### Test UUT Calculation

Table 2-28 shows and describes the menu selections on the Test UUT Calculation menu. Use this function to verify the accuracy of temperature calculations.

Table 2-28. Test UUT Calculation Menu

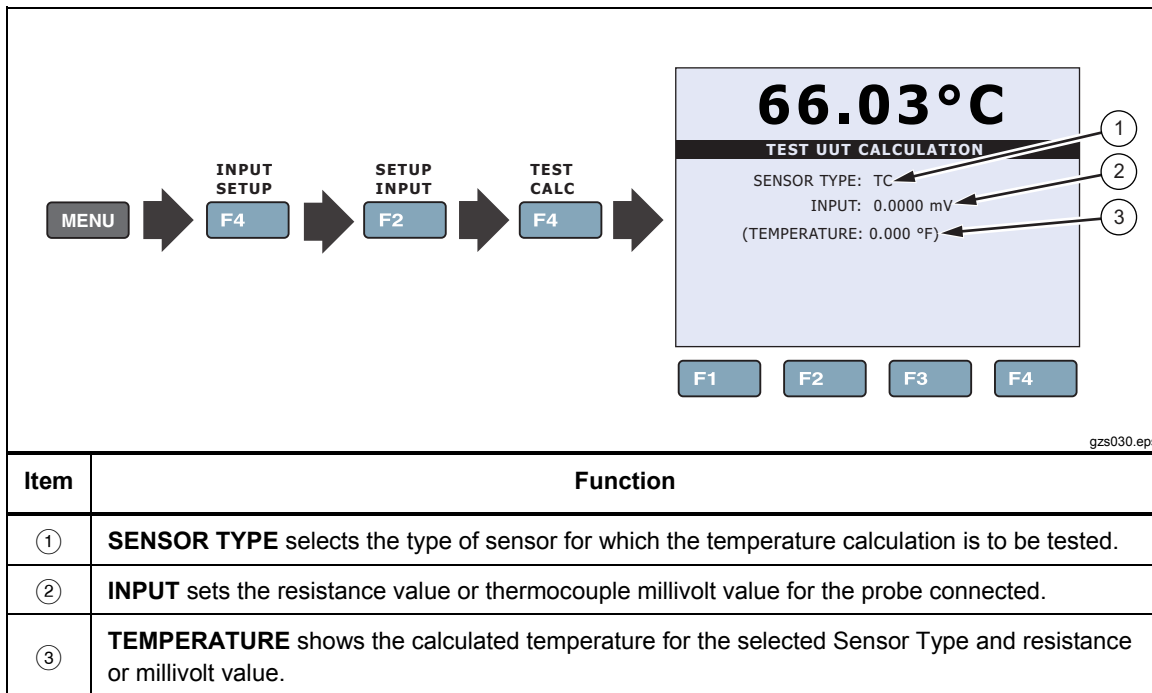

### REF Input Menu

The REF INPUT menu contains the parameters for the reference input to the readout module of the Calibrator. The Reference Input is only compatible with PRTs with ITS-90, Callendar-Van Dusen, or IEC-751 coefficients. Additionally, the Reference Input can read straight resistance instead of temperature.

The probe serial number and coefficients can be found on the calibration certificate that was shipped with the probe. If the probe requires calibration, contact an Authorized Service Center to inquire about calibration services offered by Fluke Calibration (see Chapter 1).

**Reference Probe Setup**

Table 2-29 shows and describes the menu selections on the Reference Probe Setup menu.

**Table 2-29. Reference Probe Setup Menu**

Item	Function
①	<b>SERIAL</b> is the 10-digit, alpha-numeric serial number for the reference probe.
②	<b>CAL DATE</b> is the Calibration date for the reference probe.
③	<b>PROBE TYPE</b> is the probe conversion type to be set up. The type can be set to ITS-90, Callendar-Van Dusen (CVD), IEC-751, or Resistance.
④	<p>The <b>PRT characterization coefficients</b> that are shown depend on the probe type that was selected. If ITS-90 is selected, the associated coefficients are a, b, c, a4, and b4. Coefficients a, b, and c characterize the Reference Probe above 0 °C. Unused coefficients must be set to 0.</p> <p style="text-align: center;"><i>Note</i></p> <p><i>If the probe connected is fitted with a smart connector, the PROGRAM prompt appears when the Reference Probe Setup screen is exited. Select YES to update the smart connector memory with the present probe setup or NO to leave the memory unchanged.</i></p>

**Test Calculation Menu**

Table 2-30 shows and describes the menu selections on the Test Calculation menu. Use this function to test the accuracy of the temperature calculation for the Reference input.

**Table 2-30. Test Calculation Menu**

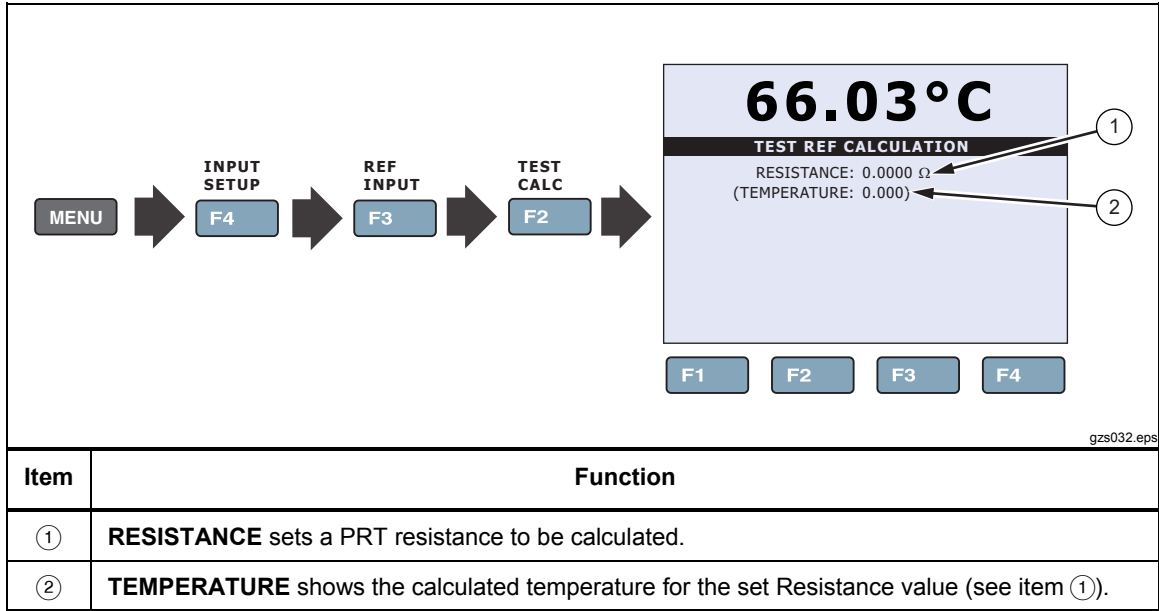

## Probe Preparation

### Clamp-On Ferrites

Ferrites clamped around the PRT/RTD input and the thermocouple (TC) probe reduce the risk of electro-magnetic interference (EMI) that can cause inaccurate measurements. If the Calibrator is used in an area that is susceptible to known EMI (such as industrial equipment or motors), attach a supplied Ferrite to the probe cable as follows:

To attach a ferrite to a probe cable (see Figure 2-5):

1. Make a loop in the cable near the connector.
2. Clamp the ferrite around half of the loop as shown.
3. As necessary, the Ferrite can be snapped open and moved to a new probe.

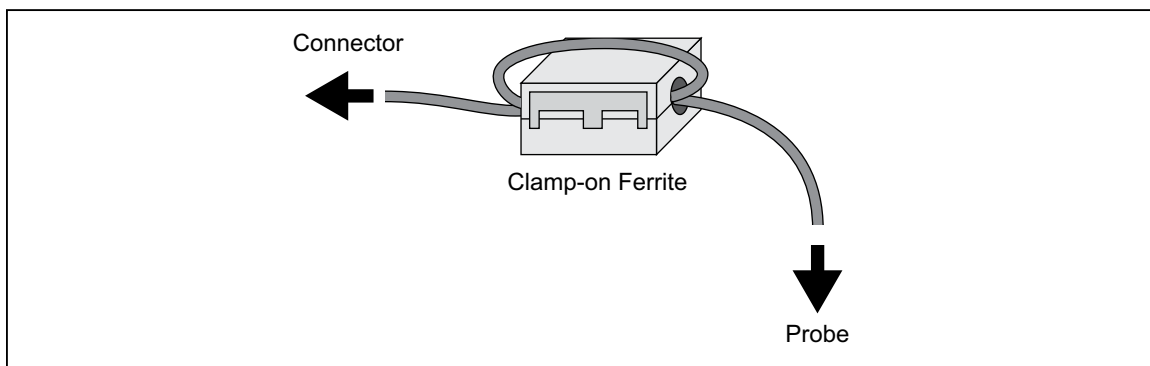

Figure 2-5. Clamp-On Ferrite Installation

gzs038.eps

### Reference PRT Connection Preparation

The REF PRT connection on the front panel attaches a reference probe to be used as a reference thermometer. Prepare the reference probe as follows:

#### 4-Wire Reference Probe Wiring Instructions

Connect a 4-wire reference probe as follows (see Figure 2-6):

1. Connect one pair of wires to pins 1 and 2.
2. Connect the other pair of wires to pins 4 and 5 (pins 1 and 5 source current and pins 2 and 4 sense the potential).
3. If a shield wire is present, connect it to 3, which is also used for the memory circuit. Pin 6 is only used for the memory circuit.

#### 2-Wire Reference Probe Wiring Instructions

Connect a 2-wire reference probe as follows (see Figure 2-6):

*Note*

*Accuracy can be significantly degraded using a 2-wire connection because of lead resistance.*

1. Connect one wire to both pins 1 and 2.
2. Connect the other wire to pins 4 and 5.
3. If a shield wire is present, connect it to pin 3, which is also used for the memory circuit. Pin 6 is only used for the memory circuit.

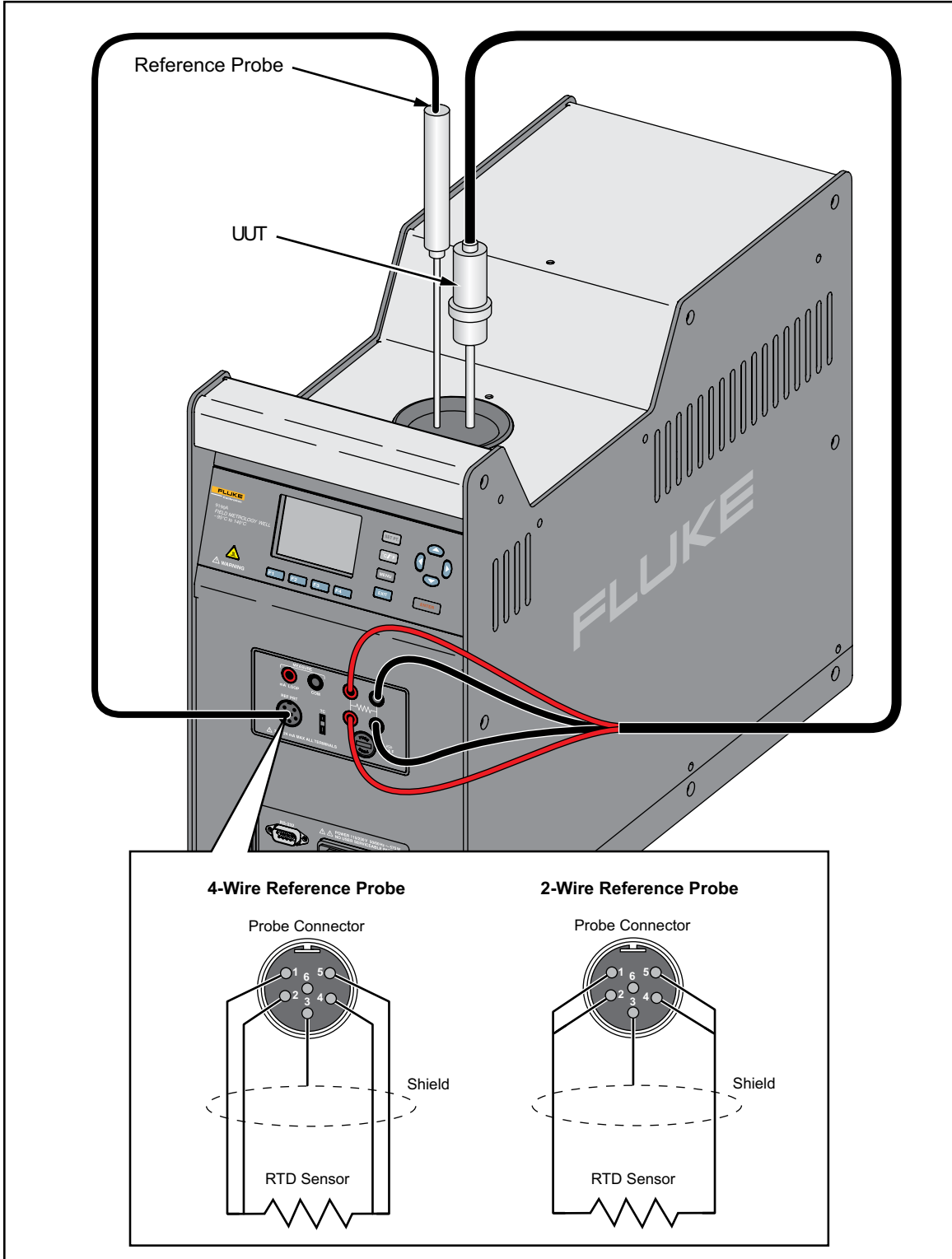

Figure 2-6. Reference Probe Wiring

gzs047.eps



### Reference Probe Input Setup

To set up a reference probe after it is connected:

1. Insert the reference probe into the Calibrator. See “Probe Insertion and Removal Procedure” on page 2-35.

*Note*

*When the probe with a programmed smart connector is connected to the REF PRT input, the probe characterization parameters are automatically transferred to the Calibrator. Additional set up is not necessary to use the probe.*

*If the reference probe does not have a smart connector, the PRT characterization must be set up. The procedure is as follows:*

2. Push **MENU**.
3. Push **F4**.
4. Push **F3**.
5. Push **F1**. If the password is requested, enter the correct password.
7. Enter serial number to identify the Reference Probe. Push **◀** and **▶** to highlight a digit then push **▲** to increase the digit or push **▼** to decrease the digit.
8. Push **ENTER** to save the serial number.
9. Enter the calibration date of the Reference Probe.
10. Select the PRT characterization for Probe Type. Push **▶** to select then push **ENTER** to save.

*Note*

*If the Reference Probe was calibrated and characterized in accordance with ITS-90, select ITS-90. The PRT characterization coefficients that are shown depend on the Probe Type that was selected. If ITS-90 is selected, the associated coefficients are a, b, c, a4, and b4. Coefficients a, b, and c characterize the Reference Probe above 0 °C. Unused coefficients must be set to 0.*

*For example, if the PRT calibration report provides values labeled a8 and b8, enter the a8 value for a, the b8 value for b, and set c to 0. If the Reference Probe was calibrated below 0 °C, enter the a4 and b4 coefficient values on the calibration report in for a4 and b4 in the Calibrator.*

After the Reference Probe is setup, it can be used to correct the control temperature of the Calibrator. To set up the Reference Probe to be the primary sensor:

1. Push **MENU**.
2. Push **F1**.
3. Push **F1** again.
4. Highlight **CONTROL SENSOR** and push **▶** to change it to **REFERENCE**. See “Temperature Setup Menu (TEMP SETUP)” on page 2-11.
5. Push **ENTER** to save.

### PRT/RTD Connection Preparation

The correct wiring for the 4-wire PRT/RTD is shown on the Product. See Figure 2-7 for an illustration on how to wire a 2-wire, 3-wire, or 4-wire PRT/RTD.

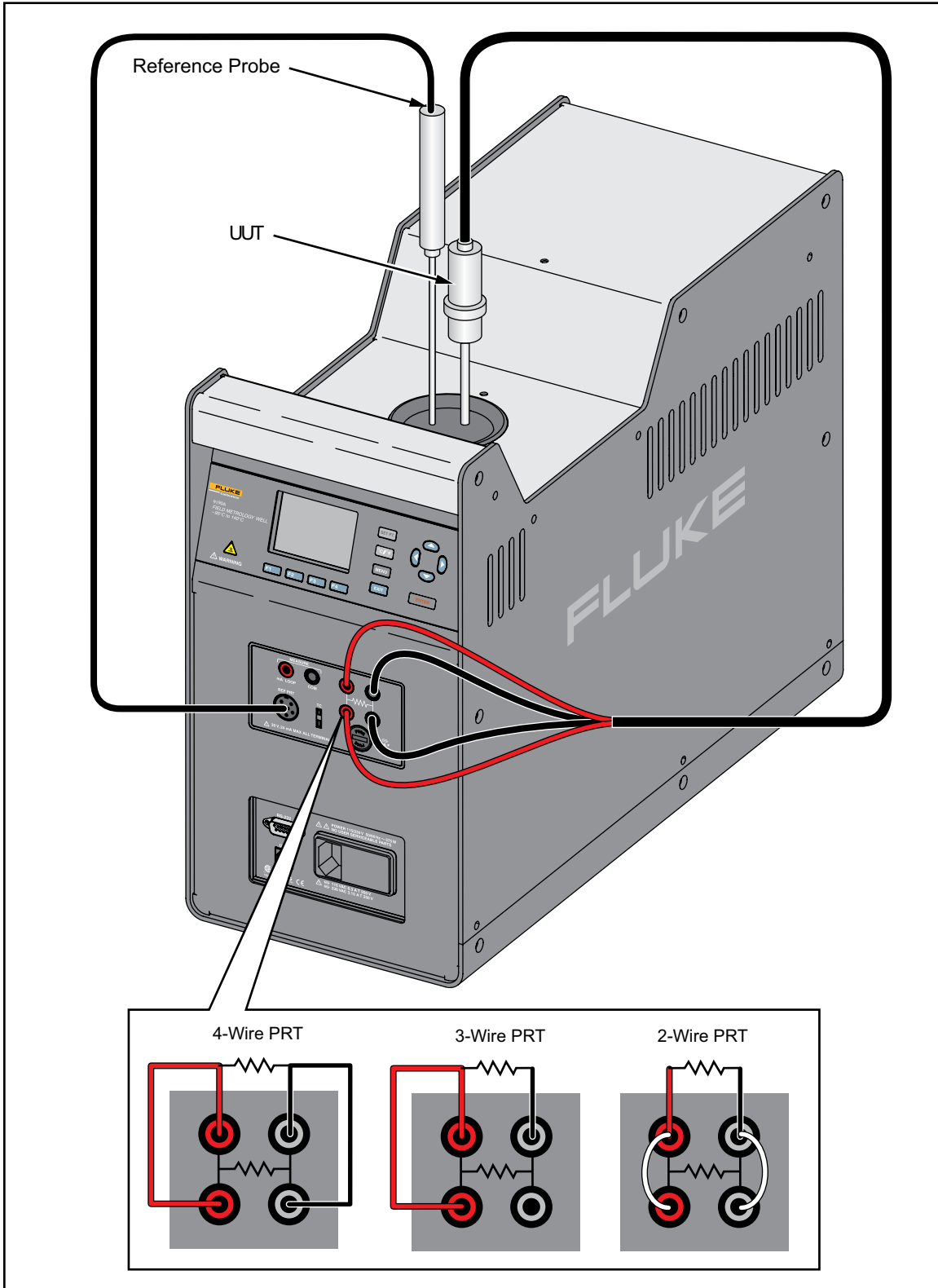

Figure 2-7. PRT/RTD Probe Setup

gzs044.eps

## Operation

### Insert Installation and Removal Procedure

#### Warning

**For safe operation and maintenance of the product, do not remove inserts when the block temperature indicator is illuminated.**

To install the insert:

1. Remove the rubber well insulation cap.
2. Stand the insert upright.
3. Lock the insert tool into the attachment holes.
4. Pick up the insert and slowly and carefully lower the insert into the well.

To remove the insert:

1. Let the Calibrator cool to below 50 °C and make sure the high temperature indicator is not illuminated.
2. Use the insert tool to lift the insert from the well. Put the insert on a metal or ceramic fiber surface or container made to set hot materials on.

#### *Note*

*If the insert has not been cleaned periodically (see “Clean the Insert” in Chapter 4), hard-water deposits can form on the insert and make it difficult to remove. If the insert cannot be removed, try to remove the insert as follows:*

- a. Put the Calibrator in a cold environment that is less than 21 °C.
  - b. Use the procedure in “Set the Temperature SETPOINT Manually” on page 2-36 to set the temperature to 100 °C.
  - c. When the temperature is between 50 °C and 70 °C, use the insert tool to lift the insert from the well. Put the insert on a metal or ceramic fiber surface or container made to set hot materials on.
  - d. If the insert cannot be removed, turn off the Calibrator and contact Fluke Calibration (see “Contact Fluke Calibration” in Chapter 1).
3. Put the rubber well insulation cap back on the well.

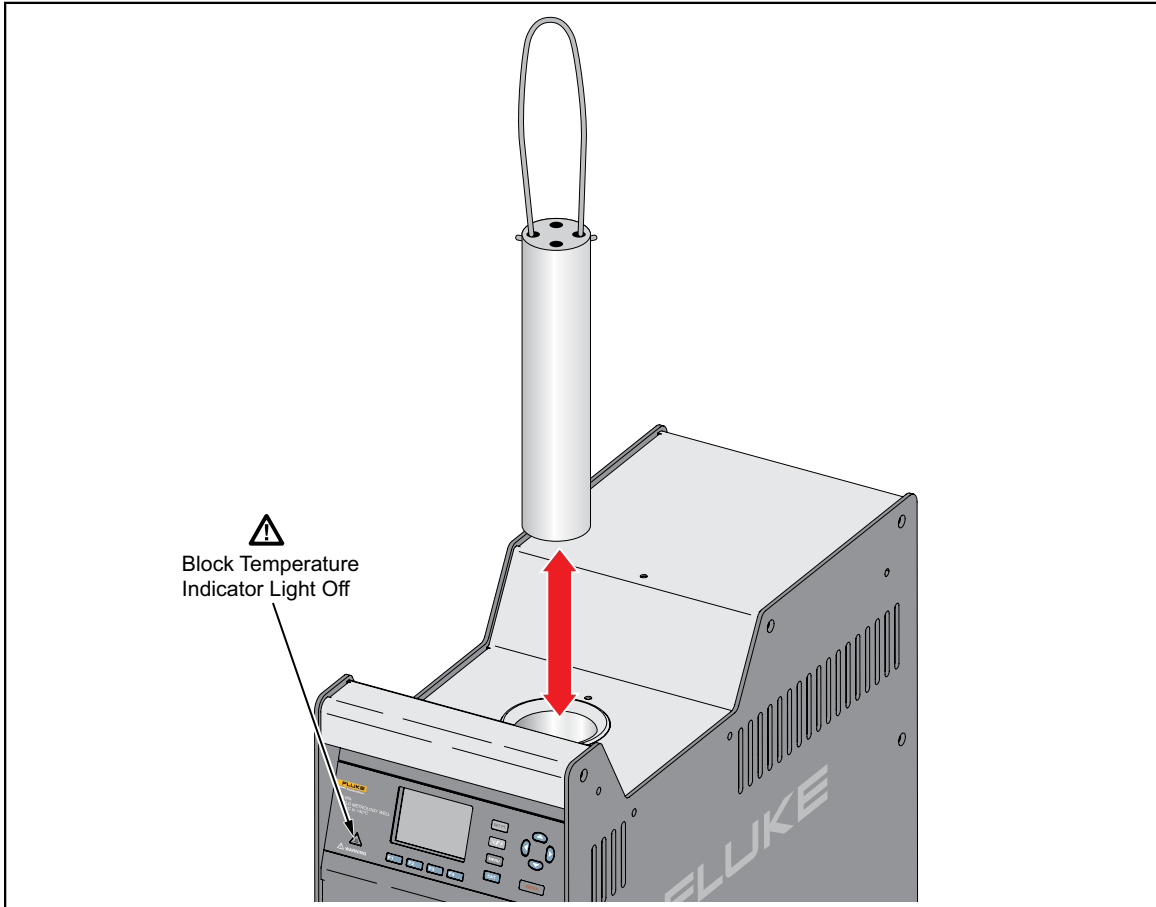

Figure 2-8. Insert Installation and Removal

gzs045.eps

## Probe Insertion and Removal Procedure

### ⚠ Caution

To prevent possible damage to probes, make sure all probes put into the furnace are rated for the temperature range used in the calibration procedure.

### Note

*Use a metal or ceramic fiber surface or container is used to set hot probes on.*

*A solid (unstirred) mass, as in a furnace, can have heat loss through the probe stem. The loss changes between probes and temperatures.*

For the best stable temperature and minimum gradient, put sample probes into the full depth of the well. Variation on equipment, probe dimension, and configuration can have an effect on temperature stability and gradients. At higher temperatures, temperature stability and gradients between test wells are equivalent. But the length of time for the wells to become stable is much longer.

Temperature changes at lower temperatures are slow. This is because high integration values are necessary to keep the controller stable (1,200 seconds) at the lower temperatures.

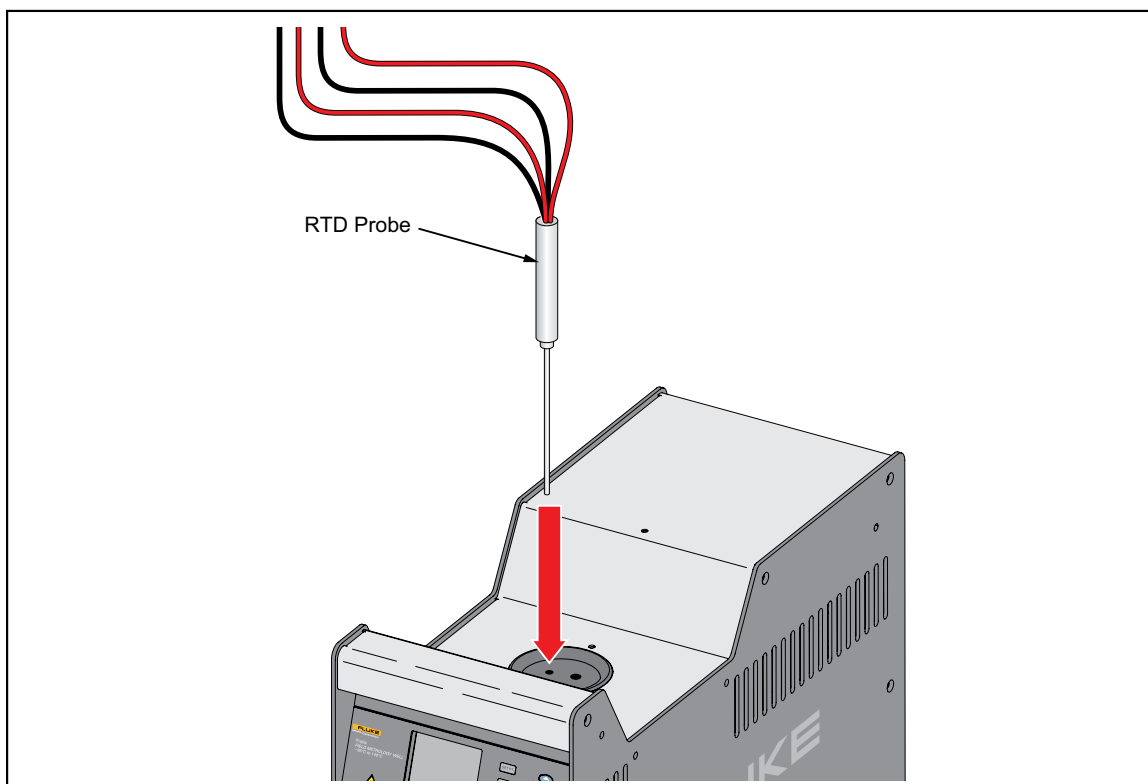

Figure 2-9. Probe Insertion

gzs043.eps

## Set Temperature

A set temperature value is referred to as a “SETPOINT”. The Calibrator uses the SETPOINT value to know what temperature to heat or cool to. Use the procedures in the subsequent sections to manually set a SETPOINT, load a SETPOINT preset, or change a SETPOINT preset.

### Set the Temperature SETPOINT Manually

To adjust the Calibrator temperature SETPOINT manually (see Figure 2-10):

1. Push **SET PT.**.
2. Push **ENTER**.
3. Push **◀** and **▶** to highlight a digit then push **▲** to increase the digit or push **▼** to decrease the digit.
4. Push **ENTER** twice to save the SETPOINT temperature and start the Calibrator.

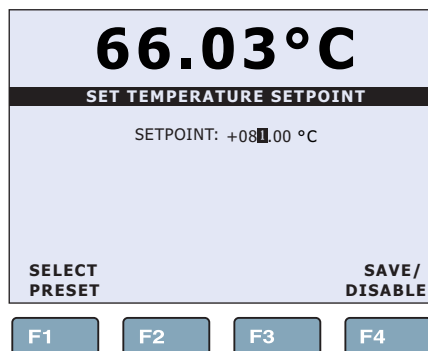

Figure 2-10. Set Temperature SETPOINT

gzs035.eps

### Set the Temperature with a Preset SETPOINT

The Calibrator stores eight user-configured preset SETPOINT temperatures to help quickly set a temperature. To change a SETPOINT preset see “Change a SETPOINT Preset” on page 2-37.

To load and use a preset SETPOINT (see Figure 2-11):

1. Push **SET PT.** on the Main screen.
2. Push **F1**.
3. Push **◀** or **▶** to move between presets (1 through 8).
4. Push **ENTER** to select a preset.

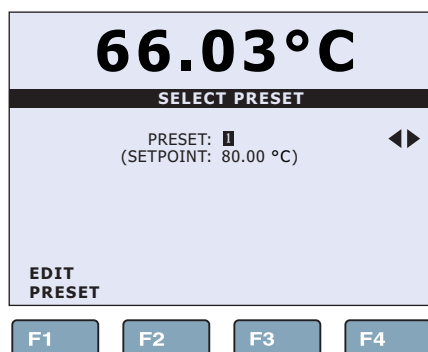

Figure 2-11. Preset Selection

gzs034.eps

### Change a Preset SETPOINT

To change a preset SETPOINT (see Figure 2-12):

1. Push **SET PT** on the Main screen.
2. Push **F1**.
3. Push **F1**.
4. Push **▲** or **▼** to move between presets (1 through 8). Highlight the preset to change then push **ENTER**.
5. Push **◀** and **▶** to highlight a digit then push **▲** to increase the digit or push **▼** to decrease the digit.
6. Push **ENTER** to save the preset.

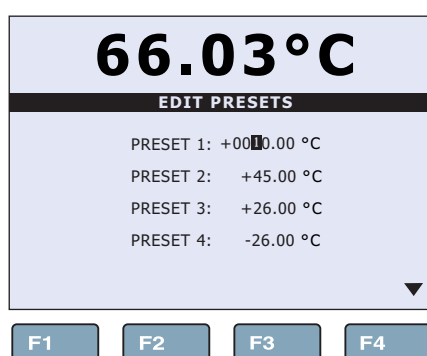

Figure 2-12. Edit SETPOINT Preset

gzs036.eps

### Cancel or Stop Temperature Change

To cancel or stop temperature change:

1. Push **SET PT** on the Main screen.
2. Push **F4**.

### Set a Soft Cutout

Soft Cutout is an upper-heat limit that protects the probes. The Hard Cutout protects the Calibrator and it cannot be changed (set by factory).

To set a Soft Cutout (see Figure 2-13):

1. Push **MENU**.
2. Push **F1**.
3. Push **F2** (if security is set to high, enter password).
4. Push **ENTER** to select the Soft Cutout.
5. Push **◀** and **▶** to highlight a digit then push **▲** to increase the digit or push **▼** to decrease the digit.
6. Push **ENTER** to save the Soft Cutout.

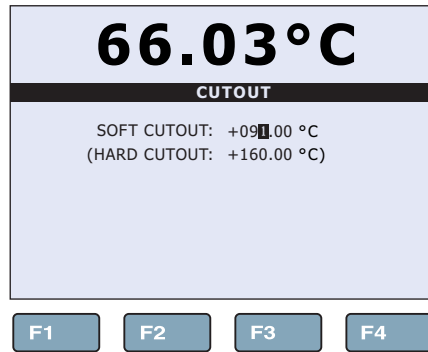

Figure 2-13. Soft Cutout

gzs037.eps

### Reset an Over-Temperature Cutout

If the Soft or Hard Cutout is exceeded, the Calibrator enters Cutout Mode and must be reset.

To exit Cutout mode and reset the Calibrator:

1. Let the Calibrator cool to below the Soft Cutout limit.
2. After cooled, push **SET PT.** followed by **ENTER** to reset the Calibrator.

### Programs (Automated Tests)

The Program menu (PROG MENU) supplies access to the automated and manual Program selections (see “Program Setup” on page 2-15). A Program is an automated test that can be configured and run on an instrument.

#### Run a Program

To run a Program:

1. Push **MENU**.
2. Push **F2**.
3. Push **F1**.
4. Push **▶** to change the **TEST STATUS** to **RUN**.
5. Push **ENTER** to save.

#### Stop a Program

To stop a Program:

1. Push **MENU**.
2. Push **F2**.
3. Push **F1**.
4. Push **▶** to change the **TEST STATUS** to **OFF**.
5. Push **ENTER** to save.



# Chapter 3

## Remote Operation

Title	Page
Introduction.....	3-3
Remote Operation Setup.....	3-3
RS-232 Remote Serial Interface.....	3-4
Wiring.....	3-4
Communication Setup.....	3-5
USB Remote Interface.....	3-6
Wiring.....	3-6
Communication Setup.....	3-6
Remote Operation Commands.....	3-7
Overview of Command Structures.....	3-7
Commands by Function or Group.....	3-7
Alphabetical List of Serial Commands.....	3-13



## Introduction

Remote operation of the Product from a computer is done with commands through the RS-232 digital interface or a serial USB interface. To control the Calibrator remotely, the computer sends SCPI (Standard Commands and Programmable Instruments) commands. These commands let the user change and control all parameters remotely such as SETPOINT temperatures, cutouts, and programs.

This chapter supplies information on how to set up the remote connection to the PC, followed by command line information.

## Remote Operation Setup

The Calibrator has an RS-232 and USB interface on the Power and Remote Interface Panel (see Table 3-1).

### Note

*To prevent noise on the signal wires, use a shielded, low resistance cable between the Product and PC.*

**Table 3-1. Power and Remote Interface Panel**

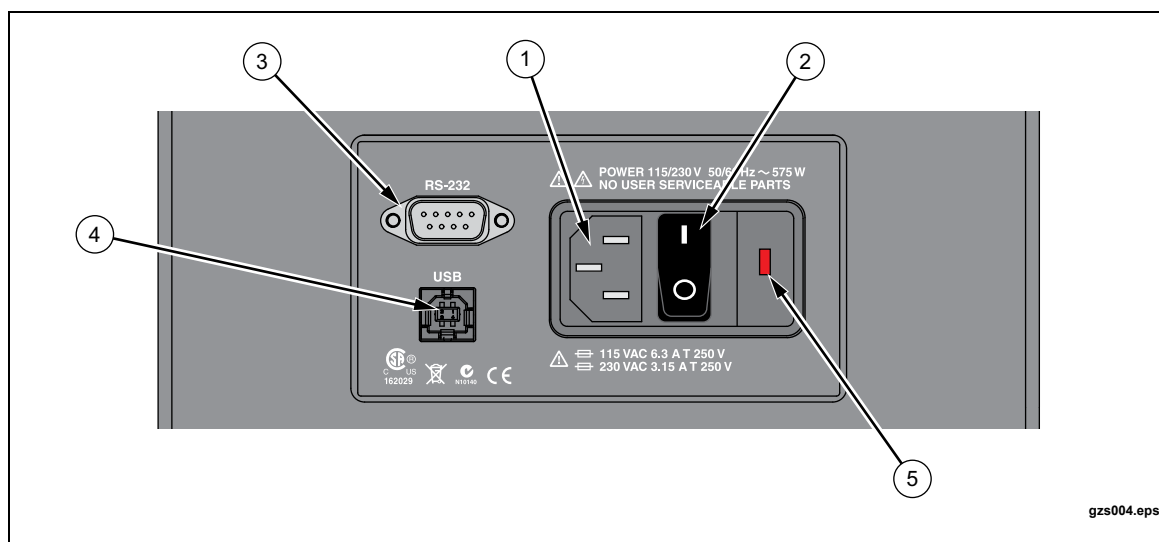

Item	Name	Function
①	Mains Power Cord Receptacle	Receptacle for the mains power cord. Use an AC mains supply appropriate for the voltage range and region of use.
②	Power Switch	Turn on (I) and turn off (O) the Calibrator.
③	9-pin Subminiature Serial Connector (RS-232)	Transmits measurements and remotely controls the operation of the instrument. See Chapter 3, "Remote Operation".
④	USB Serial Connector	Transmits measurements and remotely controls the operation of the instrument. See Chapter 3, "Remote Operation".
⑤	Fuse	Product fuse. See Chapter 4 for fuse replacement instructions.

### RS-232 Remote Serial Interface

Use the instructions in the subsequent sections to wire and configure a RS-232 Remote Serial Interface.

#### Wiring

Wire the RS-232 Remote Serial Interface connection as follows:

1. Wire the remote serial interface cable as shown in Figure 3-1.

#### Note

To prevent noise on the signal wires, use a shielded, low resistance cable between the Product and PC.

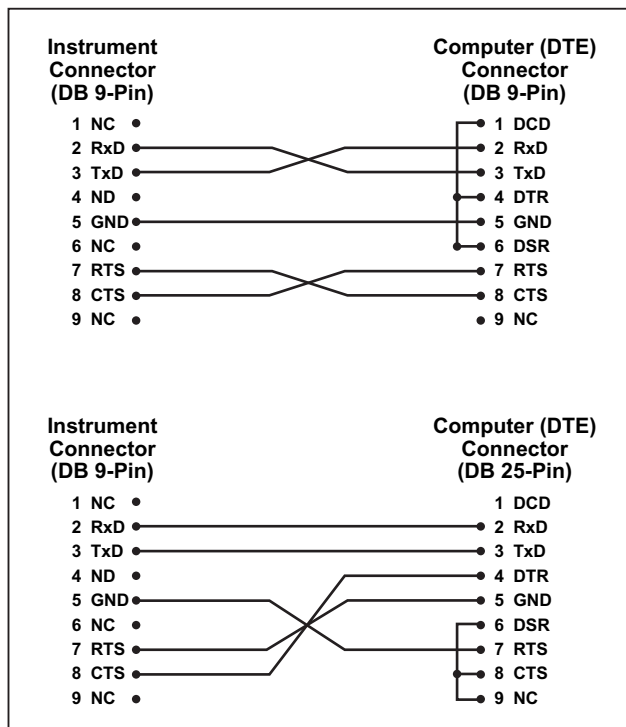

Figure 3-1. RS-232

gzs048.eps

2. Connect the DB-9 connector wired for the instrument to the 9-pin Subminiature Serial Connector (RS-232) on the Power and Remote Interface Panel (see Table 3-1).
3. Connect the DB-9 or DB-25 connector wired for the computer to the 9-pin or 25-pin serial port on the computer.

### Communication Setup

To use the RS-232 Remote Serial Interface, the Calibrator must be configured to communicate with the computer. Configuration is done in the Communication Setup menu on the Calibrator.

**Table 3-2. Communication Setup Menu**

Item	Function
①	<b>BAUD RATE</b> is the serial communication transmission rate or baud rate. BAUD may be set to 1200, 2400, 4800, 9600, 19200, or 38400 baud.
②	<b>LINEFEED</b> turns on or turns off transmission of a line feed character (LF, ASCII 10) after transmission of any carriage-return.

Set up communications as follows:

1. Push **MENU**.
2. Push **F3**.
3. Push **F1**.
4. Push **F2**.
5. Highlight **BAUD RATE** and push **ENTER**.
6. Push **⬅** or **➡** to change the **BAUD RATE** (see item ① in Table 3-2).

*Note*

*Set the BAUD RATE to the baud rate that the computer serial port is configured for.*

7. Push **ENTER** to save.

### USB Remote Interface

Use the instructions in the subsequent sections to wire and configure a USB Remote Interface.

### Wiring

The Calibrator comes with a standard USB cable. The USB cable has a 1394 connector (Calibrator connection) on one end and a standard USB connector on the other (computer connection).

To use the USB interface for remote operation, a driver needs to be installed on the computer. After the driver is installed and the Calibrator is connected to the computer, the USB connection appears as a virtual COM port in the PC communication software (for example, MS Hyper-terminal). The driver is included on the CD that shipped with the Calibrator. If the CD is lost, or a updated driver is necessary, go to

<http://www.ftdichip.com/Drivers/VCP.thm>.

### Communication Setup

To use the USB remote interface, the Calibrator must be configured to communicate with the computer. Configuration is done in the Communication Setup menu on the Calibrator.

Table 3-3. Communication Setup Menu

Item	Function
①	<b>BAUD RATE</b> is the serial communication transmission rate or baud rate. BAUD may be set to 1200, 2400, 4800, 9600, 19200, or 38400 baud.
②	<b>LINEFEED</b> turns on or turns off transmission of a line feed character (LF, ASCII 10) after transmission of any carriage-return.

Setup communications as follows:

1. Push **MENU**.
2. Push **F3**.
3. Push **F1**.
4. Push **F2**.
5. Highlight **BAUD RATE** and push **ENTER**.
6. Push **4** or **0** to change the **BAUD RATE** (see item ① in Table 3-2).

*Note*

*Set the BAUD RATE to the baud rate that the computer serial port is configured for.*

7. Push **ENTER** to save.

## Remote Operation Commands

### Overview of Command Structures

The Calibrator accepts commands for setting parameters, executing functions or responding with requested data. These commands are in the form of strings of ASCII-encoded characters. The Field Metrology Well command syntax conforms to SCPI-1994. One notable exception is that compound commands are not allowed as explained below.

Commands consist of a command header and, if necessary, parameter data. All commands must be terminated with either a carriage return (ASCII 0D hex or 13 decimal) or new line character (ASCII 0A hex or 10 decimal).

Command headers consist of one or more mnemonics separated by colons (:). Mnemonics may use letter characters, the underscore character (\_), and possibly numeric digits as well. Commands are not case sensitive. Mnemonics often have alternate forms. Most mnemonics have a long form that is more readable and a short form consisting of three or four characters that is more efficient.

A mnemonic can end with a numeric suffix that specifies one of a set of independent function blocks such as input channel data paths. If a numeric suffix is omitted when a particular block must be specified, an error is generated (“Header suffix out of range”).

Query commands are commands that request data in response. Query commands have a question mark (?) immediately following the command header. Responses to query commands are generated immediately and placed in the output buffer. Responses are then transmitted automatically to the PC. Responses are lost if not read before the next command is received.

Some commands require parameter data to specify values for one or more parameters. The command header is separated from the parameter data by a space (ASCII 20 hex or 32 decimal). Multiple parameters are separated by a comma(,).

The Calibrator does not allow compound commands (multiple commands per line separated with semicolons). All commands are sequential. The execution of each command is completed before subsequent commands are processed.

Some settings are unconditionally password protected or conditionally password protected. When protected, a command cannot be used to change the setting without first providing the password. The password is entered with the SYST:PASS:CEN command.

### Commands by Function or Group

In this section, the commands are arranged into the these groups:

- **Calibration Commands** – commands for Field Metrology Well calibration parameters.
- **Main Screen Commands** – commands for parameters displayed on the main screen.
- **Program Commands** – commands for program setup and status.
- **Reference Commands** – commands for accessing reference thermometer parameters.
- **UUT Commands** – commands for accessing UUT parameters.
- **Setup Commands** – commands for setting up communication, display, password, measure, and operation parameters.
- **System Commands** – commands to report and change the status of the instrument.
- **Temperature Commands** – commands for control temperature and cutout functions.

Table 3-4. Commands by Function or Group

Group	Screen Parameter	Command	Password Protection Group	Read/Write
Calibration - Controller	TEMP PB	SOUR:LCON:PBAN	Unconditional	R/W
	TEMP INT	SOUR:LCON:INT	Unconditional	R/W
	TEMP DER	SOUR:LCON:DER	Unconditional	R/W
	CALDATE	CAL:DATE:UNIT	Unconditional	R/W
Calibration – Heat Source	TEMP 1	SOUR:SENS:CAL:PAR1	Unconditional	R/W
	TEMP 2	SOUR:SENS:CAL:PAR2	Unconditional	R/W
	TEMP 3	SOUR:SENS:CAL:PAR3	Unconditional	R/W
	GRAD 1	SOUR:SENS:CAL:GRAD1	Unconditional	R/W
	GRAD 2	SOUR:SENS:CAL:GRAD2	Unconditional	R/W
	GRAD 3	SOUR:SENS:CAL:GRAD3	Unconditional	R/W
	TEMP 1	SOUR:SENS:CAL:TEMP1	N/A	R
	TEMP 2	SOUR:SENS:CAL:TEMP2	N/A	R
	TEMP 3	SOUR:SENS:CAL:TEMP3	N/A	R
Calibration – Reference <sup>[-P]</sup>	REF1C0	SENS1:CAL:PAR1	Unconditional	R/W
	REF1C100	SENS1:CAL:PAR2	Unconditional	R/W
	INPUT CAL DATE	CAL:DATE:MOD	Unconditional	R/W
Note: [-P] – “-P” Model Only				



**Table 3-4. Commands by Function or Group (cont.)**

Group	Screen Parameter	Command	Password Protection Group	Read/Write
Calibration – UUT – TC <sup>[-P]</sup>	TCC0	SENS2:CAL:PAR1	Unconditional	R/W
	TCC100	SENS2:CAL:PAR2	Unconditional	R/W
	TCCRJ	SENS2:CAL:PAR3	Unconditional	R/W
	INPUT CAL DATE	CAL:DATE:MOD	Unconditional	R/W
Calibration – UUT-mA	mAC4	SENS2:CAL:PAR4	Unconditional	R/W
	mAC20	SENS2:CAL:PAR6	Unconditional	R/W
	INPUT CAL DATE	CAL:DATE:MOD	Unconditional	R/W
Main Screen	(none)	SOUR:SENS:DATA	N/A	R
	SETPT	SOUR:SPO	N/A	R/W
	SETPOINT 1	SOUR:LIST:SPO1	N/A	R/W
	SETPOINT 2	SOUR:LIST:SPO2	N/A	R/W
	SETPOINT 3	SOUR:LIST:SPO3	N/A	R/W
	SETPOINT 4	SOUR:LIST:SPO4	N/A	R/W
	SETPOINT 5	SOUR:LIST:SPO5	N/A	R/W
	SETPOINT 6	SOUR:LIST:SPO6	N/A	R/W
	SETPOINT 7	SOUR:LIST:SPO7	N/A	R/W
	SETPOINT 8	SOUR:LIST:SPO8	N/A	R/W
	STAB	SOUR:STAB:DAT	N/A	R
	STAB graph	SOUR:STAB:TEST	N/A	R
	(none)	OUTP2:DATA	N/A	R
Main Screen <sup>[-P]</sup>	REF	CALC1:DATA	N/A	R
Main Screen <sup>[-P]</sup>	REF TEMP	READ, MEAS, FETC	N/A	R
UUT <sup>[-P]</sup>	TC-n, P100, mA	CALC2:DATA	N/A	R
Program – Run	TEST STATUS	PROG:STAT	N/A	R/W
Program - List	(none)	PROG:CAT	N/A	R
Program - Select	(none)	PROG:TYP	N/A	R/W
Program - Setup	TEST ID	PROG:IDEN	N/A	R/W
	(none)	PROG:MEM:COUN	N/A	R
Erase Tests	ERASE TESTS	PROG:MEM:CLEA	Unconditional	W
Note: [-P] – “-P” Model Only				

Table 3-4. Commands by Function or Group (cont.)

Group	Screen Parameter	Command	Password Protection Group	Read/Write
Ramp & Soak	RAMP/SOAK SETUP	PROG:SEQ:CAT	N/A	R
	SETPOINT n	PROG:SEQ:PAR SPOn	Conditional	R/W
	SOAK TIME	PROG:SEQ:PAR DWEL	Conditional	R/W
	SETPOINTS	PROG:SEQ:PAR POIN	Conditional	R/W
	NO CYCLES	PROG:SEQ:PAR CYCL	Conditional	R/W
	PASS TOLERANCE	PROG:SEQ:PAR PTOL	Conditional	R/W
	DIRECTION	PROG:SEQ:PAR DIR	Conditional	R/W
Test – Results Main Screen	PRINT TEST	PROG:MEM:PRINT	N/A	W
	ERASE TESTS	PROG:MEM:CLEA	Unconditional	W
Reference - List <sup>[-P]</sup>	PROBE TYPE	CALC1:CONV:CAT	N/A	R
Characterization Parameters - Active List (-P model only)	(none)	CALC1:CONV:PAR:CAT	N/A	R
	CAL DATE	CALC1:CONV:DATE	Conditional	R/W
	PROGRAM	CALC1:CONV:PROG	Unconditional	W
Reference – Setup <sup>[-P]</sup>	PROBE TYPE: ITS-90	CALC1:CONV:NAME ITS-90	Conditional	R/W
Reference – Setup <sup>[-P]</sup>	PROBE TYPE: CVD	CALC1:CONV:NAME CVD	Conditional	R/W
Reference – Setup <sup>[-P]</sup>	PROBE TYPE: IEC	CALC1:CONV:NAME IEC-751	Conditional	R/W
Reference – Setup <sup>[-P]</sup>	CONV TYPE: RESISTANCE	CALC1:CONV:NAME RES	Conditional	R/W
	SERIAL	CALC1:CONV:SNUM	Conditional	R/W
Note: [-P] – “-P” Model Only				

**Table 3-4. Commands by Function or Group (cont.)**

Group	Screen Parameter	Command	Password Protection Group	Read/Write
ITS90 <sup>[-P]</sup>	RTPW	CALC1:CONV:PAR:VAL RTPW	Conditional	R/W
	A	CALC1:CONV:PAR:VAL A7	Conditional	R/W
	B	CALC1:CONV:PAR:VAL B7	Conditional	R/W
	C	CALC1:CONV:PAR:VAL C7	Conditional	R/W
	A4	CALC1:CONV:PAR:VAL A4	Conditional	R/W
	B4	CALC1:CONV:PAR:VAL B4	Conditional	R/W
CVD <sup>[-P]</sup>	R0	CALC1:CONV:PAR:VAL R0	Conditional	R/W
	ALPHA	CALC1:CONV:PAR:VAL AL	Conditional	R/W
	DELTA	CALC1:CONV:PAR:VAL DE	Conditional	R/W
	BETA	CALC1:CONV:PAR:VAL BE	Conditional	R/W
	RESISTANCE	SENS1:DATA	N/A	R
Reference – Test Algorithm <sup>[-P]</sup>	TEST CALC	CALC1:CONV:TEST	N/A	R
UUT <sup>[-P]</sup>	RES, mA, mV	SENS2:DATA	N/A	R
	SENSOR	SENS2:FUNC	N/A	R/W
List <sup>[-P]</sup>	RTD TYPE	CALC2:CONV:CAT RTD	N/A	R
	TC TYPE	CALC2:CONV:CAT TC	N/A	R
	RTD TYPE: RESISTANCE	CALC2:CONV:NAME 0	N/A	R/W
	RTD TYPE: PT100(385)	CALC2:CONV:NAME 1	N/A	R/W
	RTD TYPE: PT100(3926)	CALC2:CONV:NAME 2	N/A	R/W
	RTD TYPE: PT100(JIS)	CALC2:CONV:NAME 3	N/A	R/W
	RTD TYPE: NI-120	CALC2:CONV:NAME 4	N/A	R/W
	TC-C	CALC2:CONV:NAME C	N/A	R/W
	TC-E	CALC2:CONV:NAME E	N/A	R/W
	TC-J	CALC2:CONV:NAME J	N/A	R/W
	TC-K	CALC2:CONV:NAME K	N/A	R/W
	TC-L	CALC2:CONV:NAME L	N/A	R/W
	TC-M	CALC2:CONV:NAME M	N/A	R/W
TC-N	CALC2:CONV:NAME N	N/A	R/W	
<p>Note: [-P] – “-P” Model Only</p>				

Table 3-4. Commands by Function or Group (cont.)

Group	Screen Parameter	Command	Password Protection Group	Read/Write
List <sup>[-P]</sup>	TC-R	CALC2:CONV:NAME R	N/A	R/W
	TC-S	CALC2:CONV:NAME S	N/A	R/W
	TC-T	CALC2:CONV:NAME T	N/A	R/W
	TC-U	CALC2:CONV:NAME U	N/A	R/W
	mV	CALC2:CONV:NAME MV	N/A	R/W
UUT-mA <sup>[-P]</sup>	LOOP POWER	INP2:MAMP:LPOW	N/A	R/W
UUT-RTD <sup>[-P]</sup>	WIRES	INP2:RTD:WIR	N/A	R/W
UUT – Test Algorithm <sup>[-P]</sup>	TEST CALC	CALC2:CONV:TEST	N/A	R
Setup - Communication	BAUD RATE	SYST:COMM:SER:BAUD	N/A	R/W
	LINEFEED	SYST:COMM:SER:LIN	N/A	R/W
Setup - Display	LANGUAGE	SYST:LANG	N/A	R/W
	DECIMAL	SYST:DEC:FORM	N/A	R/W
	KEY AUDIO	SYST:BEEP:KEYB	N/A	R/W
Setup - Password	PASSWORD (Disable)	SYST:PASS:CDIS	Unconditional	W
	PASSWORD (Enable)	SYST:PASS:CEN	Unconditional	W
Status	(none)	SYST:PASS:CEN:STAT	N/A	R
	USER PASSWORD	SYST:PASS:NEW	Unconditional	W
	PROTECTION	SYST:PASS:PROT	N/A	R/W
Setup – Date/Time	DATE	SYST:DATE	Unconditional	R/W
	TIME	SYST:TIME	Unconditional	R/W
System - Setup	°C/°F key	UNIT:TEMP	N/A	R/W
Heat Enable	(none)	OUTP:STAT	N/A	R/W
	(none)	SYST:KLOC	Conditional	R/W
	(none)	SYST:CONF:MOD	N/A	R
System - Information	(none)	SYST:ERR	N/A	R
	(all)	*IDN	N/A	R
	(none)	*CLS	N/A	W
	(none)	*OPT	N/A	R
	FW VER	SYST:COD:VERS	N/A	R
	(none)	SYST:BEEP:IMM	N/A	W
Note: [-P] – “-P” Model Only				

**Table 3-4. Commands by Function or Group (cont.)**

Group	Screen Parameter	Command	Password Protection Group	Read/Write
Temperature – Cutout	HARD CUTOUT	SOUR:PROT:HCUT	N/A	R
	SOFT CUTOUT	SOUR:PROT:SCUT:LEV	Conditional	R/W
Reset	(none)	SOUR:PROT:CLE	N/A	W
Trip State	(none)	SOUR:PROT:TRIP	N/A	R
Temperature - Setup	SCAN RATE	SOUR:RATE	N/A	R/W
	STABLE LIMIT	SOUR:STAB:LIM	N/A	R/W
	STABLE ALARM	SOUR:STAB:BEEP	N/A	R/W
Temperature – Setup <sup>[-P]</sup>	CONTROL SENSOR	SOUR:SENS:ROUT {0   1 }	N/A	R/W
Note: [-P] – “-P” Model Only				

### **Alphabetical List of Serial Commands**

Each command description provides the structure (long and short format), a description of the command purpose, a command example, an example of what the command returns (as applicable to query commands), and notes specific to the command. The following apply to each group of commands:

- Numeric data, specified by the mnemonic, <num>, uses ASCII characters to represent numbers. Numbers may contain a plus or minus (+ or -) sign, decimal point (.), and exponent (E or e) with its sign. If a fractional component is received when only an integer is required, the number is rounded to the nearest integer without any resulting error message. The mnemonics DEF, MIN, and MAX are often acceptable for the default, minimum, and maximum value respectively. Unit suffixes, such as V or OHM, can be appended to numeric parameters and are accepted without error but ignored.
- Unrecognized commands or commands with incorrect syntax or invalid parameters generate error messages in the error queue.
- Upper case letters designate syntax that is required when issuing the command. Lower case letters are optional and may be omitted.
- <> indicates a required parameter.
- [ ] indicates optional parameters.
- ( ) indicates a group of parameters that must be used together.
- For query commands, specifying the MIN, MAX, or DEF parameter causes the instrument to respond with the minimum, maximum, or default setting respectively.
- For set commands, specifying the MIN, MAX, or DEF parameters causes the instrument to use the minimum, maximum, or default setting respectively.
- ‘|’ indicates alternate parameter values.
- <n> indicates a number is required.
- <num> indicates numeric value is required.
- <prog> indicates a program number (SEQ<n> or SWIT<n>) is required.

- <bool> indicates a Boolean value (0 or 1) is required. The mnemonics OFF and ON are also accepted for 0 and 1, respectively.
- <conv> indicates a conversion mnemonic is required.
- <param> indicates a parameter name is required.
- <seri> indicates a serial number is required.
- <res> indicates a resistance value is required.
- <volt> indicates a voltage value is required.
- <unit> indicates a temperature unit is required.
- <temp> indicates a temperature °C/F is required.
- <pass> indicates a password is required.
- <port> indicates a port number is required.
- <label> indicates an eight character label is required.
- <year> indicates a four digit number is required.
- <month> indicates a one or two digit number is required.
- <day> indicates a one or two digit number is required.
- <hour> indicates a one or two digit number is required.
- <minute> indicates a one or two digit number is required.
- <second> indicates a one or two digit number is required.
- <baud> indicates a valid baud number is required.

**\*CLS**

Clear the status registers.

Example: \*CLS

Response: None

**\*IDN?**

Gets manufacturer, model number, serial number and firmware version of the product.

Example: \*IDN?

Response: HART, 9190A, A79002, 1.00

**\*OPT?**

Read the product configuration, reference hardware enabled (1) or not (0) (see SYST:CONF:MOD). This command is a read only command and returns the state of the reference functionality (0, 1).

Example: \*OPT?

Response: 1

**CAL:DATE:MOD[?] [<year>,<month>,<day>] (-P model only)**

*Note*

*This command is unconditionally protected, that requires a password to set it.*

Read or set the calibration date for the -P Module (INPUT CALibration DATE). The entered values are all numeric and “yyyy” is a four digit year (2000-2135), “mm” is a two digit month (1-12), and “dd” is a two digit day (1-31).

Read Example: CAL : DATE : MOD ?

Response: 2007, 05, 24

Set Example: CAL : DATE : MOD 2007, 12, 30

**CAL:DATE:UNIT[?] [<year>,<month>,<day>]**

*Note*

*This command is unconditionally protected, that requires a password to set it.*

Read or set the calibration date for the heat portion of the Calibrator. The entered values are all numeric and “yyyy” is a four digit year (2000-2135); default 2007, “mm” is a two digit month (1-12), and “dd” is a two digit day (1-31).

Read Example: CAL : DAT : UNIT ?

Response: 2007, 05, 24

Set Example: CAL : DAT : CAL 2006, 12, 30

**CALC1:CONV:CAT? (-P model only)**

Read the list of reference probe characterization methods: “CVD, I90, IEC, RES”. Supplies the list of PRT/RTD characterization methods available.

Example: CALC1 : CONV : CAT ?

Response: "CVD" , " I90" , " IEC" , " RES"

**CALC1:CONV:DATE[?] [<yyyy,mm,dd>] (-P model only)**

*Note*

*This command is unconditionally protected, that requires a password to set it.*

Read or set the INFO-CON probe calibration date in yyyy,mm,dd format.

Year Range = {2000 – 2135}; Default: 2007

Month Range = {1 – 12}; Default: 1

Day Range = {1 – 31}; Default: 1

Read Example: CALC1 : CONV : DATE ?

Response: 2007, 10, 09

Set Example: CALC1 : CONV : DATE 2007, 09, 06

**CALC1:CONV:NAME[?][n] (-P model only)**

*Note*

*This command is unconditionally protected, that requires a password to set it.*

Read or set the reference probe characterization method. “n” is an alpha numeric value the represents: CVD, I90, IEC, or RES.

Range={ITS90, CVD, IEC, RES} or 0-3, Default:ITS90.

Read Example: CALC1 : CONV : NAME ?

Response: CVD

Set Example: CALC1 : CONV : NAME I90

**CALC1:CONV:PAR:CAT? (-P model only)**

Read the list of active reference probe characterization parameter names for the current reference probe type.

Example: CALC1 : CONV : PAR : CAT?

Response: "RTPW" , "A" , "B" , "C" , "A4" , "B4"

**CALC1:CONV:PAR:VAL[?] par[,<n>] (-P model only)***Note*

*This command is unconditionally protected, that requires a password to set it.*

Read or set a reference probe characterization parameter. "par" is a parameter identified as follows: ITS90: RTPW, A7, B7, C7, A4, B4; or CVD: AL, DE or BE. "n" may be some real number or an exponential value such as -1.234567e-5 for ITS-90.

ITS-90 Ranges: {RTPW, A7, B7, A4, B4} or 0 - 5

- RTPW = 1.0 to 200 ohms
- Coefficients =  $\pm 0.010$

Defaults:

- RTPW = 100
- All ITS-90 coefficients = 0.00000
- CVD Ranges/Defaults: {R0, AL, DE, BE} or 0 - 3
- R0 = 1.0 to 200.00 ohms
- R0 Default = 100.00
- AL Range = 0.1 to 0.9
- AL Default = 0.00385055
- BE Range = 0.0 to 1.0
- BE Default = 0.10863
- DE Range = 0.0 to 2.0
- DE Default = 1.499786

Read Example: CALC1 : CONV : PAR : VAL? RTPW

Response: 100.4545

Set Example: CALC : CONV : PAR : VAL A7, 0.00385075

**CALC1:CONV:PROG (-P model only)***Note*

*This command is unconditionally protected, that requires a password to set it.*

Program the INFO-CON probe with the current probe settings.

Example: CALC1 : CONV : PROG



**CALC1:CONV:SNUM[?] <ser\_num> (-P model only)**

*Note*

*This command is unconditionally protected, that requires a password to set it.*

Read or enter a reference probe serial number. “ser\_num” character range equals {0-9, A-Z, ‘-’}, up to 10 characters in length with a minimum of 1 character length. Default: “0”

When a blank space is entered, any characters after the blank are dropped. For example, change S/N 1234-5678 to S/N TEST1. Enter TEST1<Blank Space>678. The serial number will drop the last three characters and enter the S/N TEST1.

Read Example: CALC1 : CONV : SNUM?

Response: 1234

Set Example: CALC1 : CONV : SNUM 1560-D

**CALC1:CONV:TEST[?] <n>**

Test the conversion algorithm from resistance (ohms) to temperature (°C or °F). “n” is the value to be converted (ohms). Entry for “n” is required for converted output.

Range = {0-500};

Default = 100.

Read Example: CALC1 : CONV : TEST? 100.000

Response: 0.0100

**CAL1:DATA? (-P model only)**

Reads the reference sensor Temperature. The returned value will be in degrees °C (°F) if a temperature value is returned. The value can be a resistance if the conversion selection is RESISTANCE.

Example: CALC1 : DAT?

Response: 325

**CALC2:CONV:CAT? <func> (-P model only)**

Read the list of UUT probe characterization names. “func” is the UUT device. “func” is not required and defaults to the selected device based on the setting of <SENS2:FUNC>.

Range = {RTD, TC, MA},

Default = RTD (if no previous selection), else current selection.

Example 1: CALC2 : CONV : CAT? TC

Response 1: "C", "E", "J", "K", "L", "M", "N", "R", "S", "T", "U", "mV"

If SENS2:FUNC is set to RTD and the command is sent without the function:

Example 2: CALC2 : CONV : CAT?

Response 2: "PT\_A385", "PT\_A392", "PT\_JIS", "NI\_120", "RES"

**CALC2:CONV:NAME[?] n] (-P model only)**

Read or set the UUT device characterization scheme. Must be consistent with the selected Function and device. For RTD: “n” is the RTD type as follows: PT\_A385; PT\_A392; PT\_JIS; NI\_120; or RES. For TC; “n” is the thermocouple type as follows: C; E; J; K; L; M; N; R; S; T; U; or mV. Default: RTD, PT\_A385. Command responds with the selected UUT probe characterization method; RES, I90, IEC, RES, mV, or mA.

Read Example: CALC2 : CONV : NAME?

Response: RTD

Set Example: CALC2 : CONV : NAME NI\_120

***CALC2:CONV:TEST? n,[rj] (-P model only)***

Test the conversion algorithm from the UUT input. For thermocouple input, “rj” is the reference junction temperature. If this is not indicated, it is assumed to be 0 °C.

Example: CALC2 : CONV : TEST? 100.0

Response: 0.0000

***CALC2:DATA? (-P model only)***

Read the UUT sensor Temperature. The returned value is in degrees C (°F) if a temperature value is returned. Value may be resistance, mV, or mA depending on the selected SENS function and conversion selection.

Example: CALC2 : DATA?

Response: 325

***INP2:MAMP:LPOW[?] [0|1] (-P model only)***

Read or set UUT module mA source where [0] is Passive and [1] enables Loop Power.

Default = 0 (Passive).

Read Example: INP2 : MAMP : LPOW?

Response: 1

Set Example: INP2 : MAMP : LPOW 1

***INP2:RTD:WIR[?] [n] (-P model only)***

Read or set the UUT module number of wires in RTD. “n” is the number of wires.

Range = { 2, 3, 4 }

Default = 4 wires.

Read Example: INP2 : RTD : WIR?

Response: 3

Set Example: INP2 : RTD : WIR 4

***OUTP:STAT[?] [0|1]***

Reads or sets the active heating or cooling output status. A “0” is returned if the output status is off, and a “1” is returned if the output status is on.

Read Example: OUTP : STAT?

Response: 0

Set Example: OUTP : STAT 1

***OUTP:DATA?***

Returns the percent heating or cooling power.

Example: OUTP : DATA?

Response: 18.0

***PROG:CAT?***

A catalog list of all define programs: Ramp & Soak = SEQ.

Example: PROG : CAT?

Response: "SEQ" , "ASW" , "MSW"

**PROG:IDEN[?] [n]**

Read or set the program identifier.

Character range = {0 – 9, A – Z, ‘-‘}, up to 12 characters, minimum 1 character: Default: “0”.

Read Example: PROG : IDEN?

Set Example: TEST-1

**PROG:MEM:CLE (-P Model only)**

*Note*

*This command is unconditionally protected, that requires a password to set it.*

Erase all test reports stored in NVMemory.

Example: PROG : MEM : CLE

**PROG:MEM:COUN? (-P Model only)**

Read the test report count. Provide the count for the number of test reports currently stored in memory.

Example: PROG : MEM : COUN? 6

**PROG:MEM:PRIN [n] [ALL] (-P Model only)**

Prints one or all test reports. “n” indicates the test report to be printed and 1 is the earliest test.

Example: PROG : MEM : PRINT 1

**PROG:SEQ:CAT?**

This command provides a list of the parameters for the Ramp and Soak test.

Example: PROG : SEQ : CAT?

Response: “SPOn” , “DWELL” , “DIR” , “POIN” , “CYCL” , “PTOL”

**PROG:SEQ:PAR? par[,<n>]**

Read or set a program parameter for Ramp & Soak tests.

Range = {SPOn, DWELL, DIR, POIN, CYCL, PTOL}.

Set Example: PROG : SEQ : PAR cycle, 8

**Table 3-5. PROG:SEQ:PAR Parameters**

Parameter	Minimum	Maximum	Default
SPO[n]*	1	8	1
DWEL	1	100	15
POIN	1	8	8
CYCL	1	999	1
PTOL	0.01	99.9	1.00
DIR	0 (up)	1 (U/D)	0

\*Read Only, must be <= # of setpoints (POIN) Read Example: PROG:SEQ:PAR? dwell Response: 25

**PROG:STAT[?] [0|1]**

Read or set the execution state for the selected Program (Off=0, Run=1, Default = 0). If the selected program is not running then a value of 0 is returned otherwise a 1 is returned.

Read Example: PROG:STAT?

Response: 0

Set Example: PROG:STAT 1

**PROG:TYPE[?] [<prog>]**

Read or select a program to run where “prog” is a name, SEQ, ASW, or MSQ.

Default = SEQ.

Read Example: PROG:TYPE?

Response: SEQ

Set Example: PROG:TYPE ASW

**READ?, MEAS? or FETC? (-P model only)**

Read the Reference sensor temperature, °C or °F. If the external reference probe is enabled, the reference temperature is returned otherwise, 0.0 is returned.

Example: READ?

Response: 264.262

**SENS1:CAL:PAR<n>[?][cal] (-P model only)**

*Note*

*This command is unconditionally protected, that requires a password to set it.*

Read or set a reference input calibration parameter. “n” is a value of 1 or 2 corresponding to the calibration parameters REF1C0 and REF1C100 respectively. “cal” is a real number used as the calibration offset for the respective parameter.

REF1C0 Range = {-1.0 to 1.0} REF1C100

Range = {-2.0 to 2.0} Defaults (all): 0.0000

Read Example: SENS1:CAL:PAR1?

Response: 0.2

Set Example: SENS1:CAL:PAR2 0.092

**SENS1:DATA? (-P model only)**

Read the reference input resistance. This command returns the resistance in ohms of the reference probe.

Example: SENS1:DATA?

Response: 199.9366

***SENS2:CAL:PAR<n>[?] [cal] (-P model only)***

*Note*

*This command is unconditionally protected, that requires a password to set it.*

Read or set the UUT input calibration parameter for the selected function. “n” is an integer 1-6. PAR1=TCC0, PAR2=TCC100, PAR3=TCCRJ, PAR4=mAC4, and PAR6=mAC22 respectively. “cal” is a real number used as the calibration offset for the respective parameter.

UUT input commands to verify or set TCC0 (PAR1), TCC100 (PAR2), TCCRJ

(PAR3) for the thermocouple (TC) function calibration parameters and mAC4 (PAR4), and mAC20 (PAR6) for the mili-amp (mA) function calibration parameters.

Range:

TC = ± 10.00 (mV)  
mA = ± 4.00 (mA)

Default:

TC = ± 0.00 (mV)  
mA = ± 0.00 (mA)

Read Example: SENS2 : CAL : PAR1 ?

Response: 0 . 2

Set Example: SENS2 : CAL : PAR2 0 . 092

***SENS2:DATA? (-P model only)***

Read the UUT input. The returned value depends on the set function. PRT/RTD will be in resistance, TC will be in mV, mA will be in mA. This command returns the UUT input in ohms for the PRT/RTD function, mV for the thermocouple function, and mA for the current loop function.

Example: SENS2 : DATA?

Response: 0 . 03

***SENS2:FUNC[?] [par] (-P model only)***

Read or set the UUT Sense Function (device) selection. “par” is the selected device and is entered as RTD, TC or MA.

Default = RTD. This command reads or sets the UUT Sense Function as, RTD, TC, or mA.

Read Example: SENS2 : FUNC?

Response: RTD

Set Example: SENS2 : FUNC TC

***SOUR:LCON:DER[?] [n]***

*Note*

*This command is unconditionally protected, that requires a password to set it.*

Read or set the main control loop derivative time in seconds. The main zone derivative is the derivative time in seconds that the instrument’s PID controller uses for main zone control.

Range = {Min: 0.0, Max: 99.9}

Read Example: SOUR : LCON : DER?

Response: 1 . 5

Set Example: SOUR : LCON : DER 5

**SOUR:LCON:INT[?] [n]**

*Note*

*This command is unconditionally protected, that requires a password to set it.*

Read or set the main control loop integral time in seconds. The main zone integral is the integration time in seconds that the instrument's PID controller uses for main zone control.

Range = {10.0-999.9}

Read Example: SOUR:LCON:INT?

Response: 20.0

Set Example: SOUR:LCON:INT 10

**SOUR:LCON:PBAN[?] [n]**

*Note*

*This command is unconditionally protected, that requires a password to set it.*

Read or set the main control loop proportional band in °C.

Range = {1.0-99.9}

Read Example: SOUR:LCON:PBAN?

Response: 1.5

Set Example: SOUR:LCON:PBAN 7

**SOUR:LIST:SPO<i>[?] [n]**

Read or set a main temperature preset SETPOINTS.

Read example: SOUR:LIST:SPO6?

Response: 25.00

Set Example: SOUR:LIST:SPO6 100.00

**SOUR:PROT:HCUT?**

Read the hard cutout temperature set-point in °C or °F. Returns the current value of the hard cutout SETPOINT

Read Example: SOUR:PROT:HCUT?

Response: 140

**SOUR:PROT:CLEA**

Reset the cutout to enable the system. If the Calibrator exceeds the temperature set in the soft cutout menu or if it exceeds the maximum operating temperature, a cutout condition occurs. If this happens, the Calibrator enters cutout mode and will not actively heat or cool until the user issues this command to clear the cutout or resets the Calibrator. See Chapter 2.

Example: SOUR:PROT:CLEA

Response: This command has no response.

**SOUR:PROT:SCUT:LEV[?] [n]**

*Note*

*This command is conditionally protected, that requires a password to set it.*

Read or set the soft cutout SETPOINT. The soft cutout should be set to protect the temperature limits of the instruments under test. “n” is an integer.

Range = {-125 to 160}

Read Example: SOUR : PROT : SCUT : LEV?

Response: 125

Set Example: SOUR : PROT : SCUT : LEV 105

**SOUR:PROT:TRIP?**

Read the temperature cutout tripped state. A value of 0 is returned if the cutout set point has not been reached. Otherwise a value of 1 is returned and the cutout set point has been reached.

Range = {0, 1}; 0 = No Cutout; 1 = Cutout.

Example: SOUR : PROT : TRIP?

Response: 0

**SOUR:RATE[?] [n]**

Read or set the control temperature rate of change (Scan Rate), °C or °F per minute. The response to this command starts out high initially and decreases as the SETPOINT is reached.

Range = {Min: 0.10, Max: 500.00} Default: 100.00.

Read Example: SOUR : RATE?

Response: 0.531

Set Example: SOUR : RATE 1.26

**SOUR:SENS:CAL:GRAD<x>[?] [n]**

*Note*

*This command is unconditionally protected, that requires a password to set it.*

Read or set the axial gradient control parameter, where “x” is a numeric value that shows the parameter. [1] = GRAD1 = GRAD 1, [2] = GRAD2 = GRAD 2, [3] = GRAD3. “n” is a real number ranging from -1.0 to 1.0 entered as a ratio of the main heater power. The top zone heater reacts as a ratio of the mains heater power to control the axial gradient.

Read Example: SOUR : SENS : CAL : GRAD2?

Response: 0.05

Set Example: SOUR : SENS : CAL : GRAD2 0.08

**SOUR:SENS:CAL:PAR<x>[?] [n]**

*Note*

*This command is unconditionally protected, that requires a password to set it.*

Read or set a control temperature calibration parameter. “x” is a numeric value that shows the parameter. [1] = PAR1=Temp 1, PAR2=Temp 2, PAR3=Temp 3. “n” is the entered value of the parameter. Range = ±50.00; Defaults: 0.000. The Chapter 4 for more information.

Read Example: SOUR : SENS : CAL : PAR1?

Response: 0.0

Set Example: SOUR : SENS : CAL : PAR2 0.02

***SOUR:SENS:CAL:TEMP<x>?***

Read the required calibration temperature (°C) that corresponds to a calibration parameter. “x” is a numeric value indicating the parameter [1] = TEMP1, [2] = TEMP2, AND [3] = TEMP3.

Range = {1-3}; Default = 1.

Example: SOUR : SENS : CAL : TEMP1 ?

Response: 40

***SOUR:SENS:DATA? [TEMP]***

Read the control temperature, °C or °F. The current control temperature is returned if the above or if TEMP is appended to the end of the example.

Example: SOUR : SENS : DATA? or SOUR : SENS : DATA? TEMP

Response: 30.285°C (current control temp)

***SOUR:SENS:DATA? [RES]***

Read the control sensor resistance. When RES is appended to the end of the example above, the internal sensor resistance is returned.

Example: SOUR : SENS : DATA? RES

Response: 111.28

***SOUR:SENS:ROUT {0 | 1}***

Enable/disable the external control sensor.

***SOUR:SPO[?] [n]***

This command reads or sets the value of the control SETPOINT in the temperature unit set.

Range = {Min -110.00, Max 140.00} Default = 25.00

Read Example: SOUR : SPO?

Response: 50.000

Set Example: SOUR : SPO 100.00

***SOUR:STAB:BEEP[?] [n]***

Enable or disable the audible stability alert.

[0] is disable, [1] is enable beep.

Default:1 (Enable Beep).

Read Example: SOUR : STAB : BEEP?

Response: 1

Set Example: SOUR : STAB : BEEP 0

***SOUR:STAB:DAT?***

Read the control temperature stability, °C or °F. The controller stability is returned.

Example: SOUR : STAB : DAT?

Response: 0.306



***SOUR:STAB:LIM[?] [n]***

Read or set the control temperature stability limit, °C or °F. “n” is a positive real value.

Range = {0.01 to 9.99 (°C)}; Default: 0.05 (°C).

Read Example: SOUR : STAB : LIM?

Response: 0 . 05

Set Example: SOUR : STAB : LIM 0 . 03

***SOUR:STAB:TEST?***

Read the temperature stability test results. A value of 0 is returned if the controller is not stable at the current SETPOINT. Otherwise a value of 1 is returned if the controller is stable at the current SETPOINT.

Stable = 1; Unstable = 0.

Example: SOUR : STAB : TEST?

Response: 0

***SYST:BEEP:IMM***

Beep the system beeper. The system beeper should make an audible sound in response to this command.

Example: SYST : BEEP : IMM

***SYST:BEEP:KEYB[?] [n]***

Read or set the keyboard beep function.

0=Off, 1=On. Default: 1.

Read Example: SYST : BEEP : KEYB?

Response: 1

Set Example: SYST : BEEP : KEYB 1

***SYST:CODE:LANG?***

Read the language set option: 1: European; 2: Asian.

European: ENGLISH (default), FRENch, GERMan, PORTuguese, SPANish, RUSSian

Asian: ENGLISH (default), CHINese, JAPANese, KORean

Example: SYST : CODE : LANG?

Response: 2

***SYST:CODE:VERS?***

Read the main code version. Supplies the user with the version of the main processor code.

Example: SYST : CODE : VERS?

Response: 1 . 10

***SYST:COMM:SER:BAUD[?] [<baud>]***

Read or set serial interface baud rate where “baud” is a standard baud rate value.

Range baud = {1200, 2400, 4800, 9600, 19200, and 38400}; Default: 9600.

Read Example: SYST : COMM : SER : BAUD? Response: 2400

Set Example: SYST : COMM : SER : BAUD 9600

**SYST:COMM:SER:LIN[?] [n]**

Set serial interface linefeed enable. “n” is a value 1 or 0.

[0] = LF OFF, [1] = LF ON; Default: 1 (OFF).

Read Example: SYST:COMM:SER:LIN?

Response: 0

Set Example: SYST:COMM:SER:LIN 1

**SYST:CONF:MOD?**

Read the presence of the -P module.

[0] if no -P sensor module, [1] if -P sensor card is installed

Example: SYST:CONF:MOD?

Response: 1

**SYST:DATE[?] [<year>,<month>,<day>] (-P model only)**

*Note*

*This command is conditionally protected, that requires a password to set it.*

Read or set the System Date Setting with numbers separated by commas (yyyy,mm,dd).

Read Example: SYST:DATE?

Response: 2007,05,24

Set Example: SYST:DATE 2007,05,24

**SYST:DEC:FORM[?] [n]**

Read or set the decimal format. “n” is period [0], comma [1]. Default: 0 (Period)

Read Example: SYST:DEC:FORM?

Response: 0

Set Example: SYST:DEC:FORM 1

**SYST:ERR?**

Read the most resent error from the error queue. This command response reports the errors in the error queue.

Example: SYST:ERR?

Response: command protected

**SYST:KLOC[?] [n]**

*Note*

*This command is unconditionally protected, that requires a password to set it.*

Locks or unlocks the system keypad that restricts control to only through the serial interface (RS-232 port) or the keypad.

[0] = unlock, and [1] = lock. Default: 0 (Unlock).

Read Example: SYST:KLOCK?

Response: 1

Set Example: SYST:KLOC 1

**SYST:LANG <lang>**

Set the display language. The available languages are dependent upon which version of the product is supplied. The version is dependent upon the final destination and configuration.

European: ENGLISH (default), FRENch, GERMAN, PORTuguese, SPANish, RUSSian

Asian: ENGLISH (default), CHINese, JAPANese, KORean

Example: SYST:LANG SPAN

**SYST:LANG:CAT?**

Read the available display languages. The available languages are dependent upon which version of the product is supplied. The version is dependent upon the final destination and configuration.

European: ENGLISH (default), FRENch, GERMAN, PORTuguese, RUSSian, SPANish

Asian: ENGLISH (default), CHINese, JAPANese, KORean

Example European: SYST:LANG:CAT?

Response: "ENGL" , "FREN" , "SPAN" , "PORT" , "GERM" , "RUSS"

**SYST:PASS:CDIS**

Disable access to password protected setting commands. This command disables the system password protection.

Example: SYST:PASS:CDIS

Response: This command has no response.

**SYST:PASS:CEN [n]**

This command enables the system password. This password needs to be enabled in order to use the conditionally protected commands. When the power of the instrument is cycled, system password protection is disabled. "n" is a four digit password.

Range = {0000 – 9999}; Default: 1234.

Example: SYST:PASS:CEN 1234

Response: This command has no response.

**SYST:PASS:CEN:STAT?**

Read the access state of password protected setting commands. This command reports the current status of the system password.

Example: SYST:PASS:CEN:STAT?

Response: 0

**SYST:PASS:NEW <n>|DEF***Note*

*This command is unconditionally protected, that requires a password to set it.*

Set the password, where "n" is the new four digit password.

Range = {0000 – 9999}; Default: 1234.

Example: SYST:PASS:NEW 1234

Response: This command has no response.

***SYST:PASS:PROT[?] [0|1]***

Read or set password protection level.

[0] = low, [1] = high

Read Example: SYST:PASS:PROT?

Response: 0

Set Example: SYST:PASS:PROT 1

***SYST:TIME[?] [<hh,mm,ss> (-P model only)]****Note*

*This command is conditionally protected, that requires a password to set it.*

Read or set the System Time <hh,mm,ss> (24 hr time only).

Range: hh = {0 – 23}, mm = {0 – 59}, ss = {0 – 59}

Example: SYST:TIME?

Response: 23, 51, 05

Set Example: SYST:TIME 14, 15, 05

***UNIT:TEMP[?] [n]***

Read or set the display temperature units, where “n” is a character “C” or “F”.

Default: C.

Read Example: UNIT:TEMP?

Response: C

Set Example: UNIT:TEMP F

# Chapter 4

## Calibration

	Title	Page
Introduction.....		4-3
Temperature Source Calibration.....		4-3
Fundamentals.....		4-4
Terminology.....		4-5
Calibration Equipment.....		4-6
Temperature Source Specifications.....		4-6
Environmental Conditions.....		4-6
Temperature Source Calibration Procedure.....		4-6
UUT and Equipment Setup.....		4-6
As Found Data Collection.....		4-8
Uniformity Alignment 1st Iteration.....		4-9
Uniformity Alignment 2nd Iteration.....		4-10
Uniformity Alignment 3rd Iteration.....		4-10
Accuracy Alignment.....		4-12
As Left Accuracy.....		4-13
As Left Uniformity.....		4-13
As Left Stability.....		4-14
Guard Bands.....		4-14
9190A Input Panel Calibration.....		4-15
Fundamentals.....		4-15
Terminology.....		4-15
Calibration Equipment.....		4-16
Environmental Conditions.....		4-17
Input Panel Calibration Procedure.....		4-17
Input Panel Calibration/Tests.....		4-17
Readout Specifications.....		4-17
Reference Accuracy Test.....		4-17
UUT PRT 4-Wire Test.....		4-18
UUT PRT 3-Wire Test.....		4-19
Reference Accuracy Alignment.....		4-20
UUT Thermocouple Calibration.....		4-21
Thermocouple Accuracy Test.....		4-21
Thermocouple Reference Junction Accuracy Test.....		4-22
Thermocouple Reference Junction and Accuracy Alignment.....		4-22
Thermocouple Accuracy Alignment.....		4-23
4-20 mA Input Calibration.....		4-23
4-20 mA Accuracy Test.....		4-23
24 V Source Test.....		4-24
4-20 mA Accuracy Alignment.....		4-24



## **Introduction**

This chapter contains calibration procedures for the Calibrator.

*Note*

*The Calibrator is referred to as the UUT (unit under test) in the calibration procedures in this Chapter.*

## **Temperature Source Calibration**

Figure 4-1 shows a flow chart of the calibration procedure.

*Note*

*For assistance with the calibration process, contact an Authorized Service Center. See “How to Contact Fluke Calibration” in Chapter 1.*

*This procedure is to be considered a general guideline. Each laboratory should write their own procedure based on their equipment and their quality program. Each procedure should be accompanied by an uncertainty analysis also based on the laboratory’s equipment and environment.*

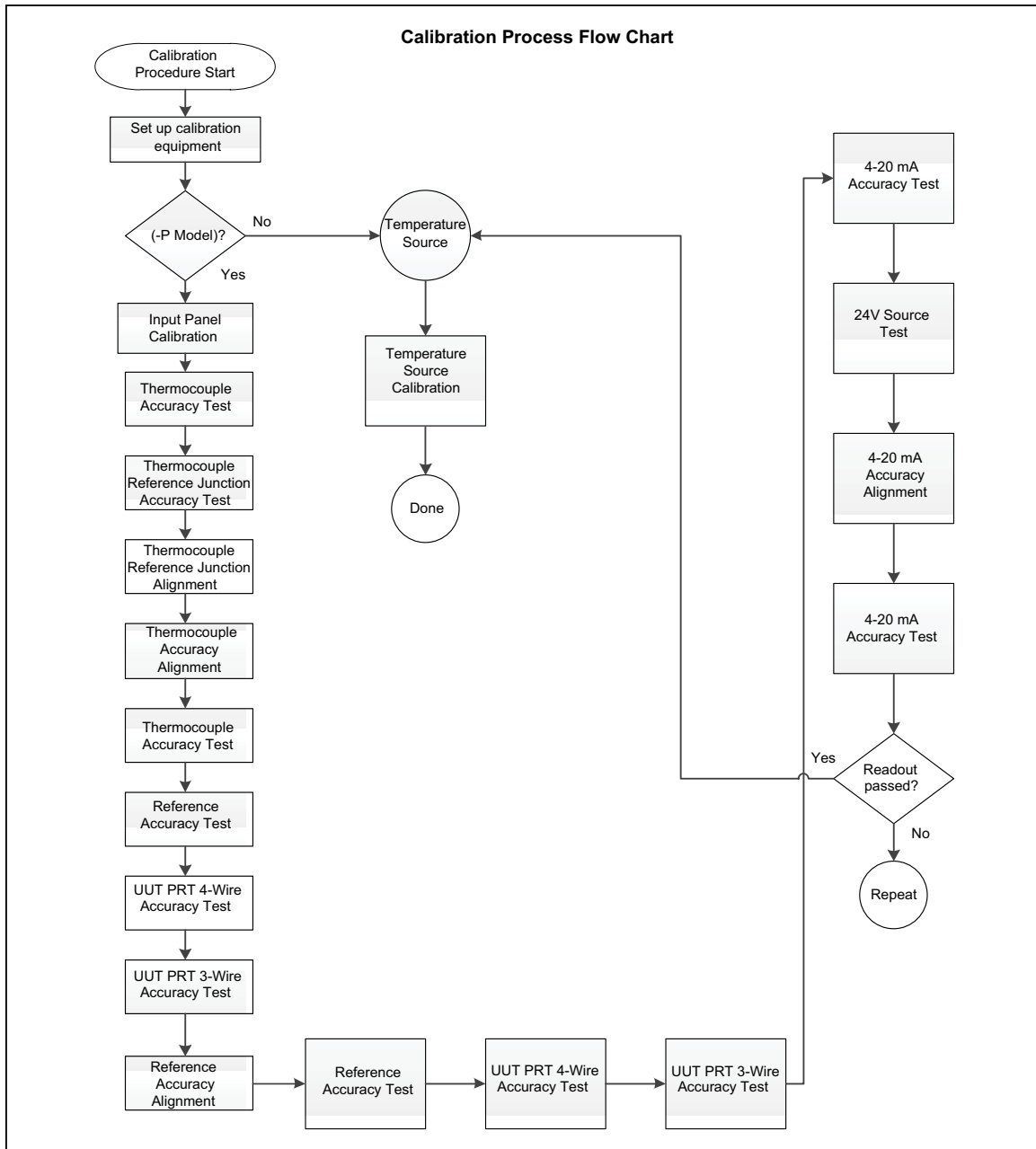

Figure 4-1. Calibration Procedure

gzs051.eps

**Fundamentals**

1. Only personnel that are qualified should calibrate the product.
2. Input panel calibration or temperature source calibration may be optional and depends on UUT configuration and customer requirement.



**Terminology**

Table 4-1 lists the terms that are used throughout this procedure.

**Table 4-1. Calibration Terminology**

Term	Definition
UUT	Unit under test (for this procedure, this is the 9190A)
Test Sleeve Insert	A cylindrical aluminum insert with drilled probe holes that fits into the UUT.
Readout	Electronic device that can measure the probe resistance and convert it to temperature.
PRT	Platinum Resistance Thermometer (also referred to as a temperature probe).
Primary PRT or Primary Reference	The temperature probe that is placed in the insert front hole at 0 mm. (Probe is bottomed out in the front-insert hole.) See Figure 4-2.
Secondary PRT or Secondary Ref	The temperature probe that is placed in the insert rear hole at 30 mm up from the bottom of the Insert. The Reference Probe bottoms out at 30 mm in the rear insert hole. Figure 4-2.
As Found Data	Data taken on the UUT before it is adjusted.
As Left Data	Data taken on the UUT after it is adjusted.
SETPOINT	Target temperature value the UUT controls to.
Axial Uniformity Error or Uniformity Error	The difference in temperature at one height in the UUT temperature block to a different height in the temperature block along the vertical axis.

### Calibration Equipment

The equipment in Table 4-2 is required to complete the calibration procedure.

**Table 4-2. Calibration Equipment**

Primary Reference		
Classifications	Minimum Use Specifications	Suggested Equipment
Readout	20 ppm	Fluke Calibration 1560 with a 2560 SPRT Module
PRT	0.008 °C at 0 °C	5628 Secondary Standard PRT with R <sub>TPW</sub> Calibration

Secondary Reference		
Classifications	Minimum Use Specifications	Suggested Equipment
Readout	20 ppm	Fluke Calibration 1560 with a 2560 SPRT Module
PRT	0.008 °C at 0 °C	5628 Secondary Standard PRT with R <sub>TPW</sub> Calibration
Aluminum Insert		Two, 0.25 inch diameter x 6.25 inch deep holes

### Temperature Source Specifications

See specifications in Chapter 1.

### Environmental Conditions

Laboratory environmental conditions required to complete this procedure:

- Temperature range: 23 °C ± 4 °C. Temperature needs to be stable when calibration is in progress.
- Low wind and draft area.
- Ambient relative humidity: below 60 %

### Temperature Source Calibration Procedure

#### UUT and Equipment Setup

Put the primary PRT and the secondary PRT in the Insert as shown in Figure 4-2. Elevate the secondary PRT 30 mm off the bottom of the Insert.

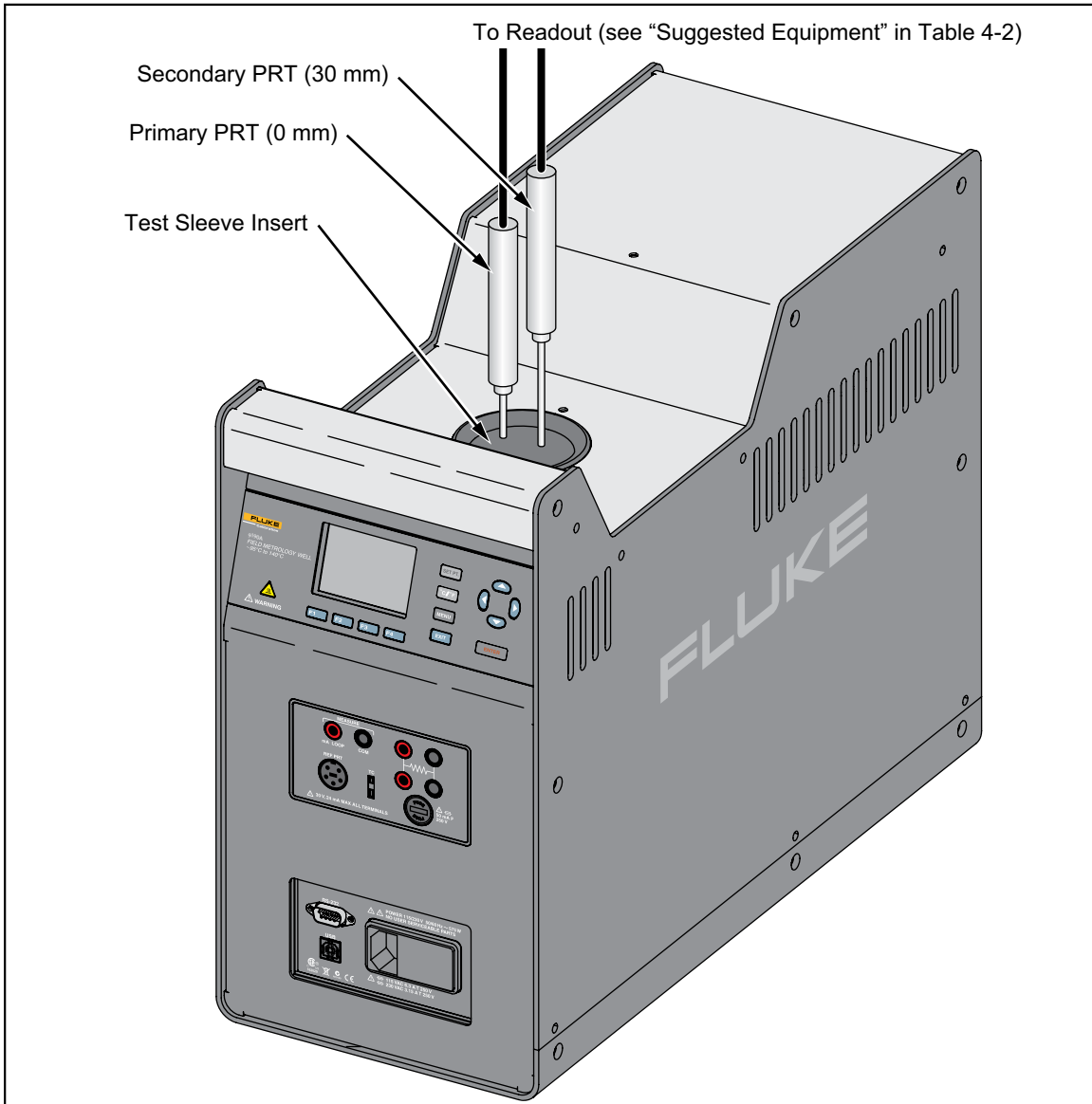

**Figure 4-2. Test Sleeve Orientation**

gzs052.eps

Connect both PRTs to the readout. It is best to make simultaneous measurements of both the primary and secondary PRT when PRT data is measured from the readout. If the readout only has one input channel, take the primary PRT readings back to back with the secondary PRT without delay.

A remote connection to the product is required to complete this procedure. Use the instructions in Chapter 3 “Remote Operation” to set up the remote connection to the UUT.

**As Found Data Collection**

If As Found data is not needed, do not perform this procedure and start the Uniformity Alignment 1<sup>st</sup> Iteration procedure on page 4-9.

Collect the data as follows:

1. Set the UUT SETPOINT temperature to 140 °C. Monitor the UUT Stability Status indicator to make sure the temperature is stable.
2. Let the UUT to soak at the 140 °C SETPOINT for 45 minutes after the Stability Status indicator shows that the temperature is stable (flat line). Take 40 measurements from the primary PRT and the secondary PRT simultaneously. Calculate the average temperature and  $2\sigma$  (2 x standard deviation) of the measurements taken. Also calculate the uniformity error as follows:

$$\text{Uniformity Error} = \text{PRT secondary} - \text{PRT primary}$$

Enter the results in Table 4-3 and Table 4-4. Compare the results to the specifications in Chapter 1.

3. Continue to record the temperature of the primary reference probe for 30 minutes and compute the standard deviation and multiply by two. Enter the result in Table 4-5. Compare the result to the specification.

Repeat the As Found Data Collection procedure for each of the other SETPOINT temperatures listed in Table 4-3, Table 4-4, and Table 4-5.

**Table 4-3. As Found Accuracy Results**

UUT SETPOINT °C	Number of Samples	Average PRT Primary Reading °C	Error: PRT Primary – SETPOINT °C	Specification (±°C)	2σ PRT Primary	2σ Limit (over the 40 samples)
140 °C	40			0.200 °C		0.02 °C
100 °C	40			0.200 °C		0.02 °C
25 °C	40			0.200 °C		0.02 °C
0 °C	40			0.200 °C		0.02 °C
–45 °C	40			0.200 °C		0.02 °C
–95 °C	40			0.200 °C		0.02 °C

**Table 4-4. As Found Uniformity Results**

UUT SETPOINT °C	Number of Samples	Average PRT Secondary Reading °C	Average PRT Primary °C	Uniformity Error °C = PRTsec-PRTprim	Specification °C
140 °C	40				0.05 °C
100 °C	40				0.05 °C
25 °C	40				0.05 °C
0 °C	40				0.05 °C
-45 °C	40				0.05 °C
-95 °C	40				0.05 °C

**Table 4-5. As Found Stability Specifications**

SETPOINTS °C	Stability	2σ Spec (±°C)	Soak Time (minutes)	Duration (minutes)
140 °C		0.015 °C	45	30
0 °C		0.015 °C	45	30
-95 °C		0.015 °C	45	30

**Uniformity Alignment 1st Iteration**

Perform the 1<sup>st</sup> Uniformity Alignment as follows:

1. Set the UUT SETPOINT temperature to -90 °C and engage the temperature control.
2. Monitor the Stability Status indicator to ensure the heat source is stable. Let the UUT soak at the -90 °C SETPOINT for 45 minutes after the Stability Status indicator shows that the temperature is stable (flat line). Measure the ACTUAL gradient, which is the temperature of the secondary PRT (30 mm probe) minus the temperature of the primary PRT (0 mm probe). Take the average of 40 samples for each of the probes. Calculate as follows:

$$ACTUAL\ grad = T_{30} - T_0$$

3. Query the UUT gradient sensor reading with this serial command:

SOUR : SENS : GRAD : DATA?

4. Repeat this 40 times to get an average of the gradient sensor reading. This value is called "UUT grad". Calculate the Error with this formula:

$$ERROR_1 = UUT\ grad - ACTUAL\ grad$$

5. If the magnitude of ERROR<sub>1</sub> is less than 0.012, skip to the next Gradient calibration temperature and repeat the Uniformity Alignment 1<sup>st</sup> Iteration procedure.

6. Query the UUT GRAD 1 calibration parameter as follows:

SOUR : SENS : CAL : GRAD1?

7. Grad 1 is associated with UUT block temperature -90 °C. Calculate the new Grad 1 calibration parameter as follows:

$$New_{GRAD\ 1} = GRAD\ 1 - ERROR_1$$

- Enter the  $New_{GRAD1}$  calibration parameter into the UUT from the front panel: **MENU > SYSTEM MENU > CALIB > CAL POINTS** or send the  $New_{GRAD1}$  calibration parameter to the UUT with these serial commands:

```
SYST:PASS:CEN <password>
```

```
SOUR:SENS:CAL:GRAD1 <New_GRAD 1>
```

- Let the UUT soak at the -90 °C SETPOINT for 45 minutes after the change to the  $New_{GRAD1}$  parameter.

### Uniformity Alignment 2nd Iteration

Perform the 2<sup>nd</sup> uniformity alignment as follows:

- With the UUT still at -90 °C from the previous Uniformity Alignment 1<sup>st</sup> Iteration procedure, measure the ACTUAL gradient, which is the temperature of the secondary PRT (30 mm probe) minus the temperature of the primary PRT (0 mm probe). Take the average of 40 samples for each of the probes. Calculate as follows:

$$ACTUAL\ grad = T_{30} - T_0$$

- Query the UUT gradient sensor reading with this serial command:

```
SOUR:SENS:GRAD:DATA?
```

- Repeat this 40 times to get an average of the gradient sensor reading. This value is called "UUT grad". Calculate the Error with this formula:

$$ERROR_1 = UUT\ grad - ACTUAL\ grad$$

- If the magnitude of  $ERROR_1$  is less than 0.012, skip to the next Gradient calibration temperature and repeat the Uniformity Alignment 1<sup>st</sup> Iteration procedure.

- Query the UUT GRAD 1 calibration parameter with this command:

```
SOUR:SENS:CAL:GRAD1?
```

- Grad 1 is associated with UUT block temperature -90 °C. Calculate the new Grad 1 calibration parameter as follows:

$$New_{GRAD1} = GRAD\ 1 - ERROR_1$$

- Enter the  $New_{GRAD1}$  calibration parameter into the UUT from the front panel: **MENU > SYSTEM MENU > CALIB > CAL POINTS** or send the  $New_{GRAD1}$  calibration parameter to the UUT with these serial commands:

```
SYST:PASS:CEN <password>
```

```
SOUR:SENS:CAL:GRAD1 <New_GRAD 1>
```

- Let the UUT soak at the -90 °C SETPOINT for 45 minutes after the change to the  $New_{GRAD1}$  parameter.

### Uniformity Alignment 3rd Iteration

Perform the 3<sup>rd</sup> uniformity alignment as follows:

- With the UUT still at -90 °C from the previous Uniformity Alignment 2<sup>nd</sup> Iteration procedure, measure the ACTUAL gradient, which is the temperature of the secondary PRT (30 mm probe) minus the temperature of the primary PRT (0 mm probe). Take the average of 40 samples for each of the probes. Calculate as follows:

$$ACTUAL\ grad = T_{30} - T_0$$

- Query the UUT gradient sensor reading with this serial command:

SOUR : SENS : GRAD : DATA?

3. Repeat this 40 times to get an average of the gradient sensor reading. This value is called “UUT grad”. Calculate the Error with this formula:

$$ERROR_1 = UUT\ grad - ACTUAL\ grad$$

4. If the magnitude of  $ERROR_1$  is less than 0.012, skip to the next Gradient calibration temperature and repeat the Uniformity Alignment 1<sup>st</sup> Iteration procedure.
5. Query the UUT GRAD 1 calibration parameter with this serial command:

SOUR : SENS : CAL : GRAD1?

6. Calculate the new Grad 1 calibration parameter as follows:

$$New_{GRAD\ 1} = GRAD\ 1 - 0.7 \times ERROR_1$$

7. Enter the  $New_{GRAD\ 1}$  calibration parameter into the UUT from the front panel: **MENU > SYSTEM MENU > CALIB > CAL POINTS** or send the  $New_{GRAD\ 1}$  calibration parameter to the UUT with these serial commands:

SYST : PASS : CEN <password>

SOUR : SENS : CAL : GRAD1 <New\_GRAD 1>

8. Let the UUT soak at the -90 °C SETPOINT for 45 minutes after the change to the GRAD1 parameter.
9. With the UUT still at -90 °C from the previous Uniformity Alignment 3<sup>rd</sup> Iteration procedure, measure the ACTUAL gradient, which is the temperature of the secondary PRT (30 mm probe) minus the temperature of the primary PRT (0 mm probe). Take the average of 40 samples for each of the probes. Calculate as follows:

$$ACTUAL\ grad = T_{30} - T_0$$

10. Query the gradient sensor reading from the UUT , with this serial command:

SOUR : SENS : GRAD : DATA?

11. Repeat this 40 times to get an average of the gradient sensor reading. This value is called “UUT grad”. Calculate the Error with this formula:

$$ERROR_1 = UUT\ grad - ACTUAL\ grad$$

12. If the magnitude of  $ERROR_1$  is less than 0.012, skip to the next Grad cal temperature. If the magnitude of the error is still greater than 0.012, contact an authorized Fluke Calibration Service Center (see Chapter 1).

13. Repeat the Uniformity Alignment 1<sup>st</sup> Iteration procedure for the SETPOINT temperatures listed below:

- 0 °C
- 140 °C

### Accuracy Alignment

An Accuracy Alignment is a measurement of the UUT block temperature and then comparing the error between what the primary PRT measures and what the UUT shows. This is done for the three different temperatures specified.

Perform the Accuracy Alignment as follows:

- Let the UUT soak at the 140 °C SETPOINT for 45 minutes. Send this serial command to read the UUT display temperature:

SOUR : SENS : DATA ?

- Take the average of 40 samples of the UUT display temperature ( $UUT_{DISP\_TEMP}$ ). Take the average of 40 samples from the primary PRT ( $ACTUAL_{TEMP}$ ). Calculate as follows:

$$NEW_{OFFSET3} = OLD_{OFFSET3} - (ACTUAL_{TEMP} - UUT_{DISP\_TEMP})$$

$OLD_{OFFSET3}$  = the current accuracy offset parameter stored in the UUT for the 140 °C point.

- Enter the  $NEW_{OFFSET3}$  value calibration parameter into the UUT from the front panel: **MENU > SYSTEM MENU > CALIB > CAL POINTS > TEMP\_3** or send these serial commands:

SYST : PASS : CEN <password>

SOUR : SENS : CAL : PAR3 XXX.XXX

- Repeat the procedure for these UUT block temperatures:
  - 0 °C
  - 90 °C
  - 0 °C
- Measure the 0 °C point twice, once descending in temperature, and once ascending in temperature.
- Take the average of the two 0 °C data sets for the ( $Block_{TEMP}$ ) value when calculating the accuracy offset parameter. Use this equation:

$$NEW_{OFFSET2} = OLD_{OFFSET2} - \frac{ACTUAL_{TEMP} - (UUT_{DISP\_TEMP\ UP} + UUT_{DISP\_TEMP\ DOWN})}{2}$$

- Use Table 4-6 to determine the correct calibration parameter to adjust for each of the SETPOINT temperatures.

**Table 4-6. Accuracy Calibration Parameter Serial Commands**

Temperature	Calibration Parameter	Serial Command
-90 °C	TEMP <sub>1</sub>	SOUR : SENS : CAL : PAR1 [ ? ]
0 °C	TEMP <sub>2</sub>	SOUR : SENS : CAL : PAR2 [ ? ]
140 °C	TEMP <sub>3</sub>	SOUR : SENS : CAL : PAR3 [ ? ]



**As Left Accuracy**

Take primary PRT data at each of the UUT SETPOINT temperatures listed in Table 4-7. Let the UUT stabilize and then soak for 45 minutes for each of the temperatures.

**Table 4-7. As Left Accuracy Specifications**

UUT SETPOINT °C	Number of Samples	Average PRT Primary Reading °C	Error: PRT Primary – SETPOINT °C	Specification (±°C)	2σ PRT Primary	2σ Limit (over the 40 samples)
140 °C	40			0.200 °C		0.02 °C
100 °C	40			0.200 °C		0.02 °C
25 °C	40			0.200 °C		0.02 °C
0 °C	40			0.200 °C		0.02 °C
–45 °C	40			0.200 °C		0.02 °C
–95 °C	40			0.200 °C		0.02 °C

**As Left Uniformity**

The final uniformity data found in step 11 of the Uniformity Alignment 3<sup>rd</sup> Iteration can be used for the As Left uniformity data. Use the data from the final iteration for each of the three different temperatures.

**Table 4-8. As Left Uniformity Results**

UUT SETPOINT °C	Number of Samples	Average PRT Secondary °C	Average PRT Primary °C	Uniformity Error °C = PRTsec - PRTprim	Specification °C
140 °C	40				0.05 °C
100 °C	40				0.05 °C
25 °C	40				0.05 °C
0 °C	40				0.05 °C
–45 °C	40				0.05 °C
–95 °C	40				0.05 °C

**As Left Stability**

Take stability data at the temperatures listed in Table 4-9. Compare the results to the specification. The data can be taken after the accuracy data is taken in As Left Accuracy for each of the temperatures listed in Table 4-9.

**Table 4-9. As Left Stability Specifications**

SETPOINT °C	2 $\sigma$	Spec ( $\pm$ °C)	Soak time min	Duration min
140 °C		0.015 °C	45	30
0 °C		0.015 °C	45	30
-95 °C		0.015 °C	45	30

**Guard Bands**

Guard bands are used to make sure the UUT is calibrated to a level better than the actual specification. This compensates for any drift that can occur over the calibration interval. If drift does occur, the unit would still be in specification. The guard bands can be applied differently to the As Found specification and the As Left specification. Typically the As Left guard band is tighter than the As Found guard band. Guard band limits are determined by the user and are decided by criteria such as:

- Calibration interval
- Environmental conditions
- Unit performance

## 9190A Input Panel Calibration

### Note

*For assistance with the calibration process, contact an Authorized Service Center. See “How to Contact Fluke Calibration” in Chapter 1.*

*This procedure is to be considered a general guideline. Each laboratory should write their own procedure based on their equipment and their quality program. Each procedure should be accompanied by an uncertainty analysis also based on the laboratory’s equipment and environment.*

Figure 4-1 shows a flow chart of the calibration procedure.

### Fundamentals

1. Only personnel that are qualified should calibrate the product.
2. Input panel calibration or temperature source calibration may be optional and depends on UUT configuration and customer requirement.

### Terminology

If the optional process version (-P model) was purchased, the 9190A has an additional input panel that requires routine calibration. The optional process version (-P model) is also referred to as the Input panel (see -P Option Panel in Chapter 2).

Table 4-10 lists the terms that are used throughout this procedure.

**Table 4-10. Calibration Terminology**

Term	Definition
UUT	Unit under test (for this procedure, this is the 9190A)
Test Sleeve Insert	A cylindrical aluminum insert with drilled probe holes that fits into the UUT.
Readout	Electronic device that can measure the probe resistance and convert it to temperature.
PRT	Platinum Resistance Thermometer (also referred to as a temperature probe).
Primary PRT or Primary Reference	The temperature probe that is placed in the insert front hole at 0 mm. (Probe is bottomed out in the front-insert hole.) See Figure 4-2.
Secondary PRT or Secondary Ref	The temperature probe that is placed in the insert front hole at 30 mm. The Reference Probe bottoms out at 30 mm in the rear insert hole. Figure 4-2.
As Found Data	Data taken on the UUT before it is calibrated.
As Left Data	Data taken on the UUT after it is calibrated.
SETPOINT	Target temperature value the UUT controls to.
Axial Uniformity Error or Uniformity Error	The difference in temperature at one height in the UUT temperature block to a different height in the temperature block along the z axis. The Axial Uniformity is referred to as the Vertical Gradient.

### Calibration Equipment

The equipment in Table 4-11 is required to complete the calibration procedure.

**Table 4-11. External Reference Calibration Equipment Specifications**

Classification	Minimum Use Specifications
Four-Wire Resistors	See Table 4-12
Voltage/Current Source	Voltage: $\pm 6$ ppm + 0.6 $\mu$ V Amperage: $\pm 40$ ppm + 80 nA
Ice Point	25 °C, Stability: $\pm 0.02$ °C
Readout	Accuracy: 0.0025 °C
Probe	0.02 °C at 25 °C
Thermocouples	0.025 °C at 25 °C Type E characterized wire at 25 °C

**Table 4-12. Standard Resistor Specifications**

Resistance ( $\Omega$ )	$U_{S1}$ (k=1)		$U_{S2}$ (k=1)		$U_T$ (k=1)	$U_T$ (k=2)
	Reference Resistor Uncertainty (ppm)	Reference Resistor Uncertainty ( $\Omega$ )	TCR Uncertainty (ppm)	TCR Uncertainty ( $\Omega$ )	Total Uncertainty ( $\Omega$ )	
0	--	0.000040	--	--	0.00004	0.00008
25	1.80	0.000045	0.3	0.0000075	0.000045	0.00009
100	2.00	0.00020	0.3	0.00003	0.000205	0.00041
200	2.65	0.00053	0.3	0.00006	0.00055	0.0011
400	2.65	0.00106	0.3	0.00012	0.0011	0.0022

### Environmental Conditions

Laboratory environmental conditions required to complete this procedure:

- Temperature range: 23 °C ±4 °C
- Ambient relative humidity: below 60 %

### Input Panel Calibration Procedure

#### Input Panel Calibration/Tests

##### Notes

- *The inputs on the Input panel can be calibrated in any order. When a calibration of a input is started, finish the procedure before another input calibration is started.*
- *Before thermocouple tests are started, the instrument must be turned on and the heat source set to 25.0 °C for at least 30 minutes to allow sufficient time for warm-up.*
- *Thermocouple tests requires the technician to connect or disconnect the voltage source and Type E TC probes.*

#### Readout Specifications

See Chapter 1 for the Input panel specifications.

#### Reference Accuracy Test

The Reference Accuracy Test is used to collect As Found, Alignment, and As Left data (see Table 4-13).

##### Note

*All Reference Accuracy Tests are to be performed in Ohms.*

**Table 4-13. Reference Probe and UUT PRT Input Process**

#	Test Name	Nominal(s) $\Omega$	Notes
1	Reference Accuracy Test	0, 25, 100, 200, 400	As Found/Alignment data - Reference input
2	UUT PRT 4-wire Accuracy Test	100	As Found data – UUT input
3	UUT PRT 3-wire Accuracy Test	100	As Found data – UUT input
4	Reference Accuracy Alignment	-	Calculate offsets with Alignment data
5	Reference Accuracy Test	0, 25, 100, 200, 400	As Left data – Reference input
6	UUT PRT 4-wire Accuracy Test	100	As Left data – UUT input
7	UUT PRT 3-wire Accuracy Test	100	As Left data – UUT input

1. Turn on the PRT reference input on the Calibrator (see “Reference Probe Input Setup” in Chapter 2).
2. Set the instrument conversion type for the PRT reference input to resistance.
3. Connect the short (0  $\Omega$ ).
4. Let readout stabilize for 70 seconds.

5. Take resistance measurements from the reference probe input at a 2-second interval. Take a minimum of 40 samples.
6. Connect the 25  $\Omega$  resistor.
7. Let readout stabilize for 70 seconds.
8. Take resistance measurements from the reference probe input at a 2-second interval. Take a minimum of 40 samples.
9. Connect the 100  $\Omega$  resistor.
10. Let readout stabilize for 70 seconds.
11. Take resistance measurements from the reference probe input at a 2-second interval. Take a minimum of 40 samples.
12. Connect the 200  $\Omega$  resistor.
13. Let readout stabilize for 70 seconds.
14. Take resistance measurements from the reference probe input at a 2-second interval. Take a minimum of 40 samples.
15. Connect the 400  $\Omega$  resistor.
16. Let readout stabilize for 70 seconds.
17. Take resistance measurements from the reference probe input at a 2-second interval. Take a minimum of 40 samples.
18. Calculate the average of the measurements taken. Record these results.
19. Calculate the error with the formula below where actual is the calibrated resistance value of the standard resistor. Record this result.  
$$Error = Average - Actual$$
20. Compare the error with the specification to determine the status. Record the result.

### **UUT PRT 4-Wire Test**

The UUT PRT 4-Wire Test is used to collect As Found and As Left data.

#### *Note*

*All Reference Accuracy Tests are to be performed in Ohms.*

Perform the UUT PRT 4-Wire Test as follows:

1. Connect the 100  $\Omega$  resistor in the 4-wire UUT configuration (see Figure 4-3).
2. Set the instrument to take UUT measurements from the PRT input.
3. Set the instrument to 4-wire mode for the UUT PRT input.
4. Set the instrument conversion type for the UUT PRT input to resistance.
5. Let the readout stabilize for 20 seconds.
6. Take resistance measurements from the UUT PRT input at a 2-second interval. Take a minimum of 40 samples.
7. Calculate the average of the measurements taken. Record these results.

8. Calculate the error with the formula below where actual is the calibrated resistance value of the standard resistor. Record this result.  
$$\text{Error} = \text{Average} - \text{Actual}$$
9. Compare the error with the spec to determine the status. Record the result.

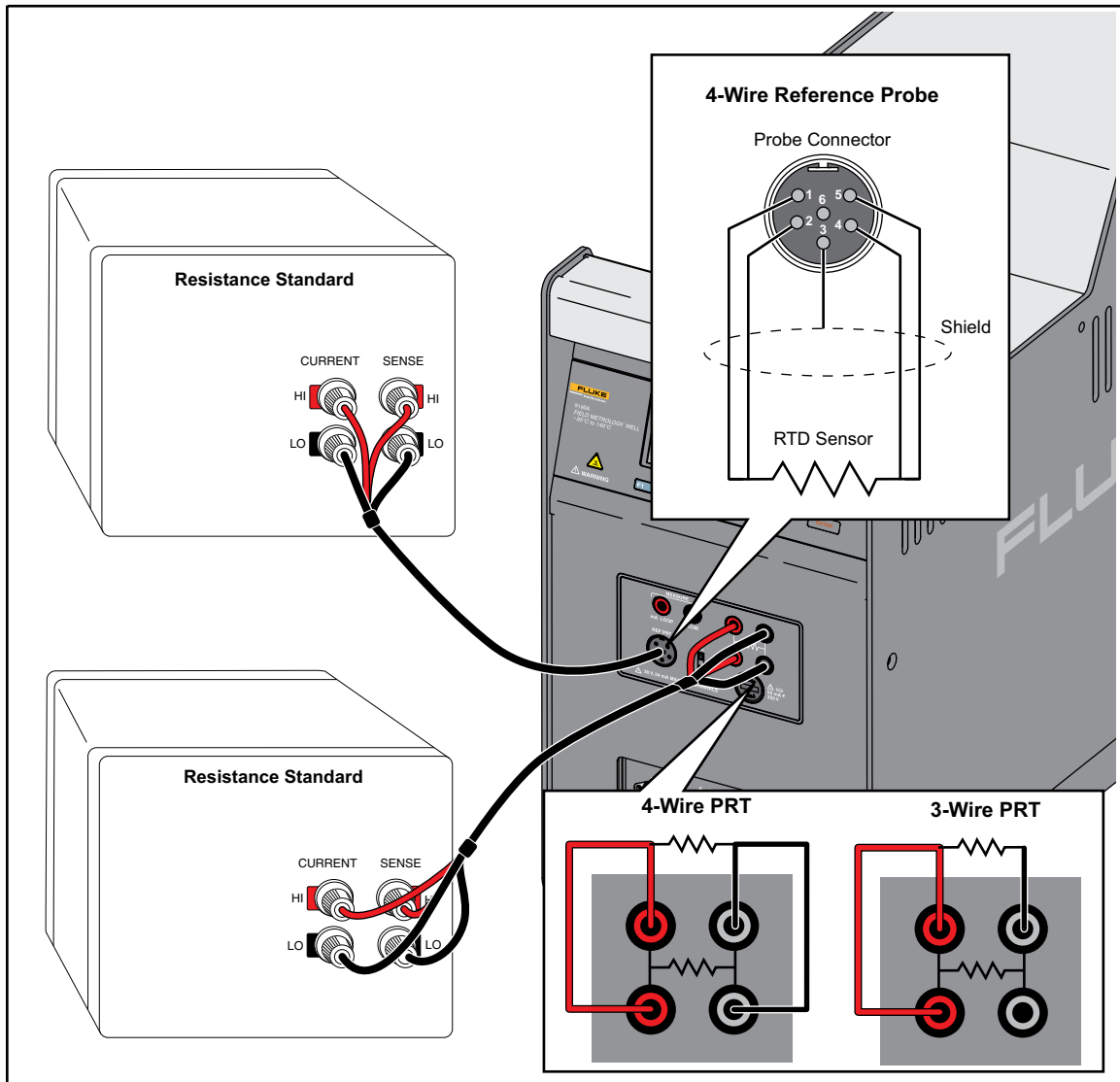

Figure 4-3. 4-Wire Setup

gzs054.eps

### UUT PRT 3-Wire Test

The UUT PRT 3-Wire Test is used to collect As Found and As Left data.

#### Note

*All Reference Accuracy Tests are to be performed in Ohms.*

Perform the UUT PRT 3-Wire Test as follows:

1. Connect the 100  $\Omega$  resistor in the 3-wire UUT configuration (see Figure 4-3).
2. Set the instrument to take UUT measurements from the PRT input.
3. Set the instrument to 3-wire mode for the UUT PRT input.

4. Set the instrument conversion type for the UUT PRT input to resistance.
5. Let the readout stabilize for 20 seconds.
6. Take resistance measurements from the UUT PRT input at a 2-second interval. Take a minimum of 40 samples.
7. Calculate the average of the measurements taken. Record these results.
8. Calculate the error with the formula below where actual is the calibrated resistance value of the standard resistor. Record this result.  
$$Error = Average - Actual$$
9. Compare the error with the spec to determine the status. Record the result.

### Reference Accuracy Alignment

The Reference Accuracy Alignment process calculates new offsets to be programmed into the instrument for the reference probe input to correct for measured errors at specific points over the resistance range of the input.

Perform the Reference Accuracy Alignment as follows:

1. Locate the results of the Reference Accuracy Tests.
2. Use the calculated errors and the previous (current) offset values and calculate the new offset values for each reference accuracy parameter with the formulas below:  
$$REFIC0_{new} = REFIC0_{previous} - error0 \text{ ohms}$$
$$REFIC100_{new} = REFIC100_{previous} + (0.625 \times error0 \text{ ohms}) - (0.5 \times error100 \text{ ohms}) - (0.125 \times error400 \text{ ohms})$$
3. Enter the new offset values into the instrument.
4. Let the readout stabilize for 70 seconds before a measurement is made.
5. Take As Left data for the Reference Accuracy Test, UUT PRT 4-wire Accuracy Test and UUT 3-wire Accuracy Tests.



*UUT Thermocouple Calibration*

Table 4-14 shows the order of the tests to be performed on the UUT thermocouple input.

**Table 4-14. Thermocouple Input Testing Process**

#	Test Name	Nominal(s) mV	Notes
1	Thermocouple Accuracy Test	-10, 0, 50, 100	As Found/Alignment data
2	Thermocouple Reference Junction Accuracy Test	25 °C	As Found/Alignment data
3	Thermocouple Reference Junction Alignment	-	Calculate reference junction offset with Alignment data
4	Thermocouple Accuracy Alignment	-	Calculate offsets with Alignment data
5	Thermocouple Reference Junction Accuracy Test	25°C	As Left data
6	Thermocouple Accuracy Test	-10, 0, 50, 100	As Left data

*Thermocouple Accuracy Test*

The Thermocouple Accuracy Test is used to collect As Found, Alignment, and As Left data.

Perform the Thermocouple Accuracy Test as follows:

1. Connect the voltage source.
2. Turn on the TC reference in the UUT.
3. Set the instrument conversion type for the UUT thermocouple input to mV.
4. Turn on and set the voltage source to -10 mV.
5. Let the readout stabilize for a minimum of 20 seconds.
6. Take a minimum of 40 samples at a 2-second interval.
7. Turn on and set the voltage source to 0 mV.
8. Let the readout stabilize for a minimum of 20 seconds.
9. Take a minimum of 40 samples at a 2-second interval.
10. Turn on and set the voltage source to 50 mV.
11. Let the readout stabilize for a minimum of 20 seconds.
12. Take a minimum of 40 samples at a 2-second interval.
13. Turn on and set the voltage source to 100 mV.
14. Let the readout stabilize for a minimum of 20 seconds.
15. Take a minimum of 40 samples at a 2-second interval.
16. Calculate the average of the measurements taken.
17. Record the data as appropriate for the type of calibration or step in the process.

### Thermocouple Reference Junction Accuracy Test

The Thermocouple Cold Junction Accuracy Test is used to collect As Found, Alignment, and As Left data.

#### Note

*The Thermocouple Reference Junction Accuracy Test requires the use of a Type-E thermocouple. This thermocouple must be put in a heat source and controlled at a constant 25 °C throughout the duration of the test.*

*All Thermocouple Reference Junction Accuracy Tests are to be performed in °C.*

Perform the Thermocouple Cold Junction Accuracy Test as follows:

1. Connect the Type-E thermocouple to the thermocouple UUT connector on the instrument.
2. Set the instrument to take UUT measurements from the thermocouple input.
3. Set the instrument conversion type for the UUT thermocouple input to TC-E.
4. Let the readout stabilize for 20 seconds.
5. Take temperature measurements from the UUT thermocouple input at a 2-second interval for a minimum of 40 samples.
6. Calculate the average of the measurements taken. Record these results.
7. Calculate the error with the formula below. Record this result.  
$$Error = Average - Nominal$$
8. Compare the error with the specification to determine the status. Record the result.

### Thermocouple Reference Junction and Accuracy Alignment

The Thermocouple Reference Junction and Accuracy Alignment process calculates a new offset to be programmed into the instrument for the UUT thermocouple reference junction to correct for the measured error at 25 °C.

Perform the Thermocouple Reference Junction and Accuracy Alignment as follows:

1. Locate the results of the Thermocouple Reference Junction Accuracy Test.
2. Use the calculated errors and the previous (current) offset value, and calculate the new offset value for the thermocouple reference junction accuracy parameter with the formula below:  
$$TCCRJ_{new} = TCCRJ_{previous} - Error \ 25 \ ^\circ C$$
3. Enter the new offset values into the instrument.
4. Let the readout stabilize for 20 seconds before a measurement is made.
5. Take As Left data with the steps outlined in the Thermocouple Reference Junction Accuracy Test.

### Thermocouple Accuracy Alignment

The Thermocouple Accuracy Alignment process calculates new offsets to be programmed into the instrument for the UUT thermocouple input to correct for measured errors at specific points over the voltage range of the input.

Perform the Thermocouple Accuracy Alignment as follows:

1. Locate the results of the Thermocouple Accuracy Tests.
2. With the calculated errors and the previous (current) offset values, calculate the new offset values for each thermocouple accuracy parameter with the formulas below:

$$TCC0_{new} = TCC0_{previous} - error0mV$$

$$TCC100_{new} = TCC100_{previous} - (1.0 \times error50mV) - (0.5 \times error100mV)$$

3. Enter the new offset values into the instrument.
4. Let the readout stabilize for 20 seconds after the new offset values are entered before a measurement is made.
5. Take As Left data with the steps outlined in the Thermocouple Accuracy Test.

### 4-20 mA Input Calibration

Table 4-15 shows the basic sequence of tests to be performed on the 4-20mA input.

**Table 4-15. 4-20 mA Input Calibration Steps**

#	Test Name	Nominal(s) mA	Notes
1	4-20 mA Accuracy Test	0, 4, 12, 20, 22	As Found/Alignment data
2	4-20 mA Accuracy Alignment	-	Calculate offsets with Alignment data
3	4-20 mA Accuracy Test	0, 4, 12, 20, 22	As Left data
4	24 V Source Test	24 volts	Functional test

### 4-20 mA Accuracy Test

The 4-20 mA Accuracy Test is used to collect As Found, Alignment, and As Left data.

*Note*

*All 4-20 mA Accuracy Tests are to be performed in mA.*

Perform the 4-20 mA Accuracy Test as follows:

1. Connect the current source to the 4-20 mA UUT input connector.
2. Set the 4-20mA input to take UUT measurements.
3. Set the mA input LOOP POWER setting to DISABLED.
4. Set the current source to supply 0 mA.
5. Let the readout stabilize for 20 seconds.
6. Take mA measurements from the UUT mA input at a 2-second interval. Take a minimum of 40 samples.
7. Set the current source to supply 4 mA.
8. Let the readout stabilize for 20 seconds.

9. Take mA measurements from the 4-20 mA input at a 2-second interval. Take a minimum of 40 samples.
10. Set the current source to supply 12 mA.
11. Let the readout stabilize for 20 seconds.
12. Take mA measurements from the UUT mA input at a 2-second interval. Take a minimum of 40 samples.
13. Set the current source to supply 20 mA
14. Let the readout stabilize for 20 seconds.
15. Take mA measurements from the UUT mA input at a 2-second interval. Take a minimum of 40 samples.
16. Set the current source to supply 22 mA
17. Let the readout stabilize for 20 seconds.
18. Take mA measurements from the UUT mA input at a 2-second interval. Take a minimum of 40 samples.
19. Calculate the average of the measurements taken. Record these results.
20. Calculate the error with the formula below. Record this result.  
$$\text{Error} = \text{Average} - \text{Nominal}$$
21. Compare the error with the spec to determine the status. Record the result.

#### 24 V Source Test

The 24 V Source Test is used to collect As Found and As Left data.

##### *Note*

*All 24V Source Tests are to be performed in mA.*

Perform the 24 V Source Test as follows:

1. Connect the current source to the 4-20 mA UUT input connector.
2. Set the 4-20mA input to take UUT measurements.
3. Set the mA input LOOP POWER setting to ENABLE.
4. Connect the 1200  $\Omega$  resistor to the voltage source.
5. Set the voltage source to supply 24 volts.
6. Let the readout stabilize for 30 seconds.
7. Take 40 voltage measurements from the UUT 4-20 mA input at a 2-second interval.
8. Calculate the average of the measurements taken. Record these results.
9. Compare the average with the specifications to determine the status. Record the result. Expected voltage is 18.00 V, with a specification of +/-1.8 V.

#### 4-20 mA Accuracy Alignment

The 4-20 mA Accuracy Alignment process calculates new offsets to be programmed into the instrument for the UUT 4-20mA input to correct for measured errors at specific points over the current range of the input.

Perform the 4-20 mA Accuracy Alignment as follows:

1. Locate the results of the 4-20mA Accuracy Tests.
2. Use the calculated errors and the previous (current) offset values and calculate the new offset values for each 4-20mA accuracy parameter with the formulas below:

$$MAC4_{new} = MAC4_{previous} - error4mA$$

$$MAC22_{new} = MAC22_{previous} - (0.915 \times error12mA) - (0.5 \times error22mA)$$

3. Enter the new offset values into the instrument.
4. Let the readout stabilize for 20 seconds after the new offset values are entered before a measurement is made.
5. Take As Left data with the 4-20 mA Accuracy Test and the 24 V Source Test.



# Chapter 5

## *Maintenance and Troubleshooting*

<b>Title</b>	<b>Page</b>
Introduction.....	5-3
Maintenance.....	5-3
Clean the Product .....	5-3
Moisture Removal .....	5-3
Clean the Insert.....	5-3
Change the Fuses.....	5-3
User-Replaceable Parts and Accessories .....	5-5
Troubleshooting.....	5-5





## Introduction

This chapter supplies information on how to service the Calibrator.

### Note

*The Calibrator is referred to as the UUT (unit under test) in the calibration procedures in this Chapter.*

## Maintenance

### Clean the Product

Clean the Product surfaces with a damp cloth and mild detergent. Make sure liquids do not go into the Product.

### Moisture Removal

When the Calibrator is run at a temperature below 0 °C for a long period of time, moisture can build up in the well. This moisture needs to be removed from the well.

To remove the moisture from the well and the insert probe holes:

1. Remove the rubber well insulator.
2. Set a 100 °C SETPOINT (see Chapter 2).
3. Cool the unit back to ambient.
4. Clean the insert (see “Clean the Insert”).

### Note

*Before you clean or decontaminate the Product with a procedure not recommended by Fluke Calibration, speak with a Service Center associate for more information.*

### Clean the Insert

The insert must be removed and cleaned regularly to prevent the buildup of hard-water deposits. Hard-water deposits can make it difficult to remove the insert from the Calibrator. If the insert is stuck in the well, use the special instructions in the “Insert Installation and Removal Procedure” in Chapter 2.

To clean the insert, remove the insert with the removal procedure in Chapter 2. After the insert is cool, wipe the insert with a cloth.

### Change the Fuses

The Calibrator has a product fuse that protects from overcurrent and a circuit fuse to protect the 4-20 mA input.

### Warning

**To prevent possible electrical shock, fire, or personal injury, use only specified replacement parts.**

To replace the fuses (see Figure 5-1):

1. Disconnect the mains-power cord from the power-entry module.
2. Open the power entry module or the 4-20 mA fuse holder and remove the fuse holder.
3. Replace the fuses with exact replacements as indicated in the specifications in Chapter 1.

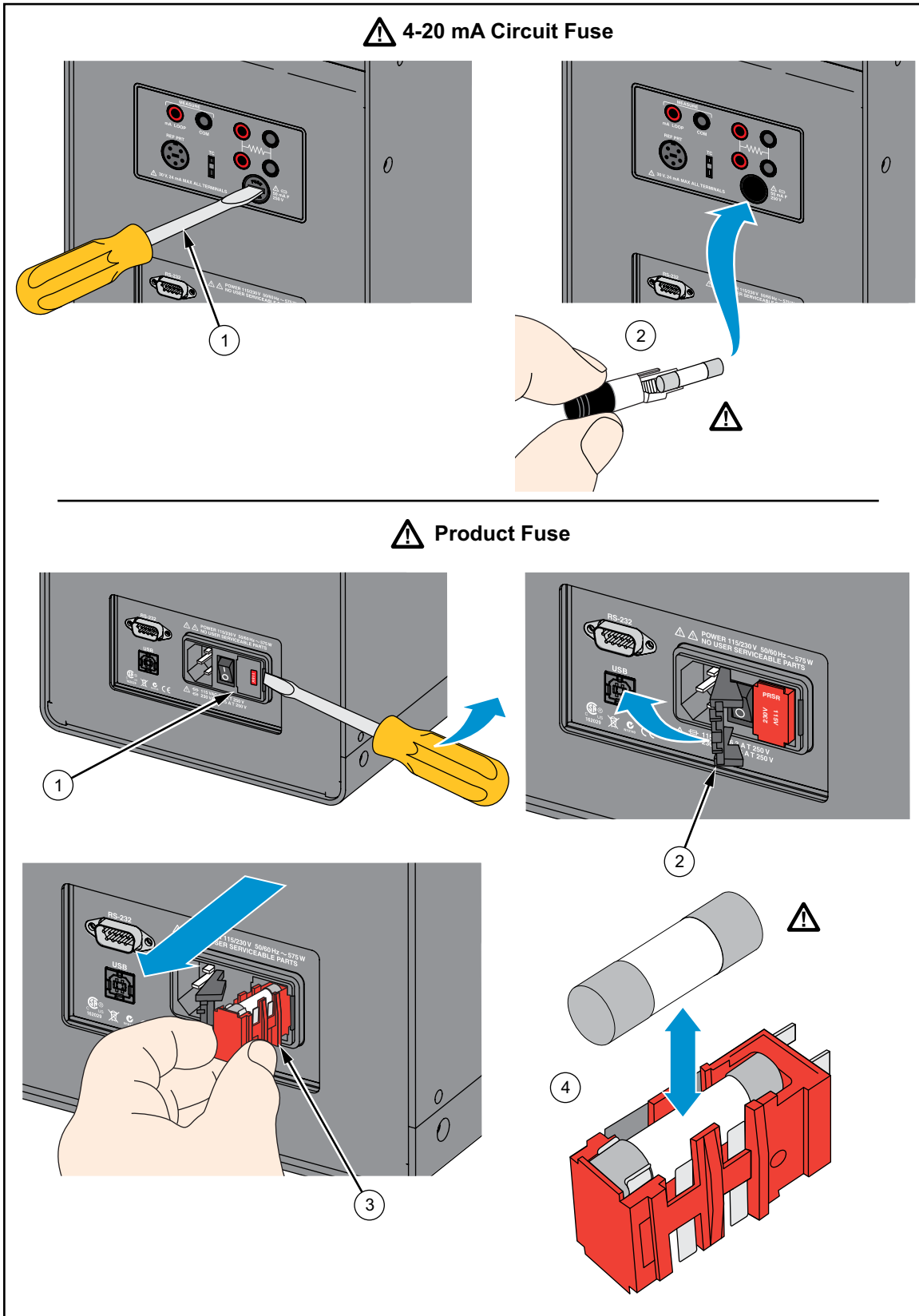

Figure 5-1. Change the Product Fuses

gzs050.eps

## User-Replaceable Parts and Accessories

Table 5-1 lists the part numbers of each user-replaceable part or accessory for the Product.

**Table 5-1. User-Replaceable Parts and Accessories**

Name	Part Number
9190-INSX Insert (X=A, B, C, D, E, or F)	Contact Fluke Calibration
6-foot Mains Power Cord	Contact Fluke Calibration
USB Cable	3724037
Getting Started Manual	4106657
Product CD that contains manuals and remote interface driver files	4106640
9930 Interface-it Calibration Software and Users Guide	3751278
Well Insulator Cap	Contact Fluke Calibration
Insert Removal Tool	2123363
Clamp-on Ferrites (-P model only)	2404659
6-pin DIN Connector (-P model only)	3707630
Test Lead Kit (-P model only)	2530650
115 V regional voltage product fuse (6.3 A, T 250 V)	2476694
230 V regional voltage product fuse (5x20, 3.15 A, T 250 V)	2476701
Input-Panel Fuse (5x20, 50 mA, F 250 V)	3719614

## Troubleshooting

In the event that the Product functions abnormally, Table 5-2 can help find and solve the problem. Several possible problem conditions are described with likely causes and solutions. If a problem occurs, please read this section carefully and attempt to understand and solve the problem. If the Product seems faulty or the problem cannot otherwise be solved, contact an Authorized Service Center for assistance. Be sure to have the instrument model number, serial number, and voltage available.

Table 5-2. Troubleshooting Chart

Problem	Causes and Solutions
The instrument does not turn on.	<p><b>Cause:</b> Check the fuses.</p> <p><b>Solution:</b> If a fuse blows, it could be because of a power surge or a component failure. Replace the fuse once. DO NOT replace the fuse with one of a higher current rating. Always replace the fuse with one of the same rating, voltage, and type. If the fuse blows a second time, it is likely caused by failure of a component part.</p> <p><b>Cause:</b> Power Cord.</p> <p><b>Solution:</b> Check that the power cord is plugged in and connected to the instrument.</p> <p><b>Cause:</b> AC Mains Power.</p> <p><b>Solution:</b> Insure the circuit that supplies power to the instrument is on.</p>
Blank display. The instrument powers up and the fan turns on, but the display is blank.	<p><b>Cause:</b> Contrast.</p> <p><b>Solution:</b> Check the screen contrast. Toggle the down arrow key to see if the screen contrast darkens.</p> <p>If the contrast is not the issue, contact an Authorized Customer Service Center.</p>
The instrument heats or cools slowly.	<p><b>Cause:</b> Scan Rate.</p> <p><b>Solution:</b> Check the Scan Rate settings. The Scan Rate may be set at too low a rate per minute for the current application.</p>
The display shows an abnormal temperature.	<p><b>Cause:</b> The sensor is disconnected, open or shorted.</p> <p><b>Solution:</b> Please contact a Service Center for further instructions.</p>
The display shows CUTOUT.	<p><b>Cause:</b> Cutout limit was exceeded.</p> <p><b>Solution:</b> If the Metrology Well exceeds the temperature set in the soft cutout menu, or if it exceeds the maximum operating temperature of the instrument, a cutout condition occurs. If this happens, the unit enters cutout mode and will not actively heat or cool until the user issues the command to clear the cutout or resets the instrument. See “Reset an Over-Temperature Cutout” in Chapter 2.</p>
Temperature readout is not the actual temperature of the temperature block or incorrect temperature reading on the display.	<p><b>Cause:</b> Operating Parameters.</p> <p><b>Solution:</b> Check to make sure all operating parameters for the Product, reference thermometer, and/or probe parameters match the Report of Certification that was sent with the instrument and/or probe.</p> <p><b>Cause:</b> Electrical Interference.</p> <p><b>Solution:</b> Look for sources of electrical interference, such as motors, welders, generating equipment nearby, or ground loops. Try shielding wires, removing ground loops, or changing location. See “Clamp-on Ferrites” in Chapter 2.</p>

**Table 5-2. Troubleshooting Chart (cont.)**

Problem	Causes and Solutions
Probes stuck in the well at low temperatures.	<p><b>Cause:</b> Moisture.</p> <p><b>Solution:</b> If the Product has been used at low temperatures for extended periods of time, moisture could possibly have built up in the well that formed ice. Set the temperature high enough to melt ice to remove probes. Set the SETPOINT to +100 °C and let the moisture evaporate out of the system.</p>
Insert stuck in well.	<p><b>Cause:</b> If maintenance has not been performed on the insert as described in the Maintenance Section and the insert cleaned periodically, hard water build-up on the insert may cause it to stick.</p> <p><b>Solution:</b> Use the special removal instructions in the “Insert Installation and Removal Procedure” in Chapter 2.</p> <p>If this does not remove the insert, contact an Authorized Service Center.</p>
Password needed.	<p><b>Cause:</b> Password is required to change certain parameters.</p> <p><b>Solution:</b> Enter password. The password by default is 1234.</p>
<b>-P Model Only</b>	
The Ref Probe shows an abnormal temperature or “.....”.	<p><b>Solution:</b> Check the Probe type setting in the Reference Probe Setup menu is correct. Check all associated parameters. Check that the 4 probe wires are connected and not shorted inside of the connector.</p>
RTD shows an abnormal temperature or “.....”.	<p><b>Solution:</b> Check the RTD type setting in the RTD Setup menu is correct. Check all associated parameters for the current RTD type. Check that the number of wires setting is correct for the number wires actually used. If using a 2-wire RTD, make sure that the unused RTD inputs are shorted to the used RTD inputs as shown in the manual. Using a 3-wire setting on a 4-wire probe can cause errors of 0.01 Ω to 0.1 Ω. Check that the probe wires are not shorted or open.</p>
Thermocouple shows an abnormal temperature or “.....”.	<p><b>Solution:</b> Check the TC type setting in the TC Setup menu is correct for the TC used. Make sure the TC wires are not loose in the connector or shorted.</p>
mA reading does not read.	<p><b>Solution:</b> Check to see if the device under test needs loop power. If it does, enable Loop Power in the mA Setup menu. Make sure the mA fuse is good. It is located on the front panel just under the RTD inputs.</p>
The Ref, RTD, TC, or mA Reading is abnormal or noisy.	<p><b>Cause:</b> Wrong Calibration Parameters. The problem may be that the wrong calibration parameters are loaded into the 9190A.</p> <p><b>Solution:</b> Check the parameters in the instrument against the parameters listed on the Report of Calibration for both the REF and UUT.</p> <p>Electrical Interference. Strong radio frequency radiation from sources such as radio transmitters, welders, and large electric motors may change the reading. Move the instrument to another location away from the source of interference. See “Clamp-on Ferrites” in Chapter 2.</p>
The current REF and UUT measurement will not display.	<p>Please contact an Authorized Customer Service Center for further instructions.</p>

