

User's Manual 96065, 96066 Clamp-on Probe

This manual describes the safety precautions for using the clamp-on probe and the clamp-on probe specifications. For details on its handling procedure, see the user's manual of the measuring instrument that the clamp-on probe will be used with.

4th Edition : March 2019 (YMI)
All Rights Reserved, Copyright © 2015, Yokogawa Test & Measurement Corporation
Printed in Japan



IM 96065-01EN
4th Edition

Checking the Package Contents

After receiving the product and opening the package, check the items described below. If the wrong items have been delivered, if items are missing, or if there is a problem with the appearance of the items, contact your nearest YOKOGAWA dealer.
Check that the product that you have received is the same product that you ordered.

For reference, the model name, suffix code, and specifications of the products are listed below.

Clamp-on Probe		Accessories	
Model	Description	Name	Notes
96065	Clamp-on Probe 1000 A	Cable marker	6 pieces (3 x 2): For 96065
96066	Clamp-on Probe 3000 A	Output cable	For 96066
		Accessory is not covered by warranty of this instrument.	

* For products whose suffix code contains "Z," an exclusive manual may be included.
Please read it along with the standard manual.

Accessories (Manuals)





Manual No.	Notes
IM 96065-01EN	This manual.
IM 96065-92Z1	A manual for China.
PIM 113-01Z2	Contact information of Yokogawa offices worldwide is provided.

* The clamp-on probe comes with the these manuals. Please keep them in a safe place.
The "-EN" in the manual number is the language code.





Safety Precautions

This product is designed to be used by a person with specialized knowledge.
The general safety precautions described herein must be observed during all phases of operation.
If the instrument is used in a manner not specified in this manual, the protection provided by the instrument may be impaired.
YOKOGAWA assumes no liability for the customer's failure to comply with these requirements.
This manual is an essential part of the product; keep it in a safe place for future reference.

The following symbols are used on this instrument.

-  Warning: handle with care. Refer to the user's manual or service manual.
This symbol appears on dangerous locations on the instrument which require special instructions for proper handling or use. The same symbol appears in the corresponding place in the manual to identify those instructions.
-  Indicates a Instrument with double or reinforced insulation.
-  Indicates that application around and removal from UNINSULATED HAZARDOUS LIVE conductors, which may render arc discharge, electric shock, or electric burn, is prohibited.
-  Indicates alternating current.

French

-  Avertissement: À manipuler délicatement. Toujours se reporter aux manuels d'utilisation et d'entretien. Ce symbole a été apposé aux endroits dangereux de l'instrument pour lesquels des consignes spéciales d'utilisation ou de manipulation ont été émises. Le même symbole apparaît à l'endroit correspondant du manuel pour identifier les consignes qui s'y rapportent.
-  Équipement protégé par une double isolation ou une isolation renforcée.
-  Ne pas enserrer ou retirer de conducteurs NON ISOLÉS sous TENSION DANGEREUSE prouvant entraîner un choc électrique, une brûlure, ou un arc électrique
-  Indique courant alternatif.

Failure to comply with the precautions below could lead to injury or death or damage to the instrument.

WARNING

- This instrument is designed exclusively for the CW500 or the like products. Do not use the instrument for devices other than the specified CW500 products.
- Do not use the instrument if there is a problem with its physical appearance.
- Never make measurement on a circuit in which the electrical potential exceeds AC 600 V in the measurement category III using 96066.
- Never make measurement on a circuit in which the electrical potential exceeds AC 300 V in the measurement category IV and AC 600 V in the measurement category III using 96065.
- Do not operate the instrument in the presence of flammable gasses or vapors. Doing so is extremely dangerous.
- Do not make measurement when thunder rumbling. If the instrument is in use, stop the measurement immediately and remove the instrument from the measured object.
- Do not use the instrument if the instrument or your hands are wet. Otherwise, electrical shock accident may occur.
- Use insulated protective gears, such as insulated gloves, for your safety when using this instrument.
- Only qualified YOKOGAWA personnel may remove the covers and disassemble or alter the instrument.
- Do not install or use the instrument outdoors or in locations subject to rain or water.

CAUTION

- Do not step on or pinch the cord to prevent the jacket of cord from being damaged.
- The output connector shall be removed or connected without clamping a conductor. Otherwise, it may cause a failure.
- Do not expose the instrument to direct sunlight, high temperatures, humidity or dew.
- Never give shocks, such as vibration or drop, which may damage the instrument.

- Use a damp cloth and detergent for cleaning the instrument. Do not use abrasives or solvents
- This clamp sensor is not designed to be dust or waterproof. Do not use it dusty places or where the clamp sensor is likely to be wet. It may cause troubles on the clamp sensor.
- Never pinch foreign matters or give vibrations at the jointed parts of this clamp sensor. Otherwise, matching area of Jaws may be damaged and cause influences on the measurements.
- Do not bend or pull the root of the cable in order to prevent breaks in the cable.
- Never apply the current exceeding the measuring range for a long time. It may damage the clamp sensor.
- Never connect/remove the connectors while connected devices are on or clamping onto the conductor under test. Otherwise, the connected devices or clamp sensors may be damaged.
- Accurate measurement may not be obtained in the vicinity of strong magnetic fields such as transformers, high-current circuits or wireless machines.

Operating Environment Limitations

The 96065 is classified as Class A (for use in industrial environments).
Operation of this product in a residential area may cause radio interference, in which case the user will be required to correct the interference.

French

AVERTISSEMENT

- L'instrument est exclusivement conçu pour les produits le CW500. Ne pas utiliser l'instrument pour d'autres appareils que les produits CW500 indiqués.
- Ne pas utiliser l'instrument si son intégrité physique semble être compromise.
- Ne jamais effectuer de mesure de l'intensité sur un circuit dans lequel le potentiel électrique dépasse 600 V CA dans la catégorie de mesure III utilisant 96066.
- Ne jamais effectuer de mesure de l'intensité sur un circuit dans lequel le potentiel électrique dépasse 300 V CA dans la catégorie de mesure IV et 600 V CA dans la catégorie de mesure III utilisant 96065.
- Ne pas utiliser l'instrument en présence de gaz ou de vapeurs inflammables. Cela pourrait être extrêmement dangereux.
- Ne pas effectuer de mesure lorsque le tonnerre gronde. Si l'instrument est en cours d'utilisation, arrêter immédiatement la mesure et retirer l'instrument de l'objet mesuré.
- Ne pas utiliser l'instrument s'il est mouillé ou si vos mains sont mouillées. Sinon, un choc électrique peut se produire.
- Utiliser des équipements de protection isolés, tels que des gants isolés, pour votre sécurité lors de l'utilisation de cet instrument.
- Seul le personnel YOKOGAWA qualifié est habilité à retirer le capot et à démonter ou modifier l'instrument. Certains composants à l'intérieur de l'instrument sont à haute tension et par conséquent, représentent un danger.
- Ne pas installer, ni utiliser l'instrument à l'extérieur ou dans des lieux exposés à la pluie ou à l'eau.

ATTENTION

- Ne pas marcher sur le cordon et ne pas le pincer afin d'éviter que la gaine du cordon ne soit endommagée.
- Le connecteur de sortie doit être retiré ou raccordé sans serrer un conducteur. Si cette condition n'est pas respectée, cela risque de générer une défaillance.
- Ne pas exposer l'instrument aux rayons directs du soleil, à des températures élevées, à l'humidité ou à la rosée.
- Ne jamais faire de chocs, tels que des vibrations ou des chutes, qui risqueraient d'endommager l'instrument.
- Utiliser un chiffon humide et du détergent pour nettoyant l'instrument. Ne pas utiliser de produits abrasifs ou de solvants.
- Ce capteur à serrer n'est pas conçu pour être recouvert de poussière et n'est pas résistant à l'eau. Ne pas l'utiliser dans des endroits poussiéreux ou dans des endroits où le capteur à serrer risque d'être mouillé. Cela risque de perturber le fonctionnement du capteur à serrer.
- Ne jamais pincer de matières étrangères ou faire de vibrations au niveau des pièces articulées de ce capteur à serrer. En effet, cela risquerait d'endommager la zone correspondante des mâchoires et d'avoir des impacts sur les mesures.
- Ne pas plier ou tirer la base du câble afin d'éviter qu'il ne se casse.
- Ne jamais appliquer un intensité dépassant la plage de mesure pendant une longue période. Cela risque d'endommager le capteur à serrer.
- Ne jamais raccorder ou retirer les connecteurs lorsque les appareils raccordés sont allumés ou que le serrage sur le conducteur est en cours de test. En effet, cela risquerait d'endommager les appareils reliés ou les capteurs à serrer.
- Il est impossible d'obtenir une mesure précise à proximité de champs magnétiques puissants tels que des transformateurs, des circuits à haute intensité ou des machines sans fil.

Limitations relatives à l'environnement opérationnel

Le 96065 est classé dans classe A (pour utilisation dans des environnements industriels). L'utilisation de ce produit dans un zone résidentielle peut entraîner une interférence radio que l'utilisateur sera tenu de rectifier.

Conventions Used in This Manual

The notes and cautions in this manual are categorized using the following symbols.



Improper handling or use can lead to injury to the user or damage to the instrument. This symbol appears on the instrument to indicate that the user must refer to the user's manual for special instructions. The same symbol appears in the corresponding place in the user's manual to identify those instructions. In the manual, the symbol is used in conjunction with the word "WARNING" or "CAUTION."



Une manipulation ou une utilisation incorrectes risquent de blesser l'utilisateur ou d'endommager l'instrument. Ce symbole apparaît sur l'instrument pour indiquer à l'utilisateur qu'il doit se reporter au manuel de l'utilisateur afin d'y lire les instructions spécifiques correspondantes. Ce même symbole apparaît à la section correspondante du manuel de l'utilisateur pour signaler lesdites instructions. Dans le manuel de l'utilisateur, ce symbole est accompagné des termes AVERTISSEMENT et ATTENTION.

WARNING

Calls attention to actions or conditions that could cause serious or fatal injury to the user, and precautions that can be taken to prevent such occurrences.

AVERTISSEMENT

Attire l'attention sur des gestes ou des conditions susceptibles de provoquer des blessures graves (voire mortelles), et sur les précautions de sécurité pouvant prévenir de tels accidents.

CAUTION

Describes precautions that should be observed to prevent minor or moderate injury, or damage to the instrument.

ATTENTION

Attire l'attention sur des gestes ou des conditions susceptibles de provoquer des blessures légères ou d'endommager l'instrument ou les données de l'utilisateur, et sur les précautions de sécurité susceptibles de prévenir de tels accidents.

Note

Calls attention to information that is important for proper operation of the instrument.

Waste Electrical and Electronic Equipment



Waste Electrical and Electronic Equipment (WEEE)

(This directive is valid only in the EU.)

This product complies with the WEEE Directive marking requirement. This marking indicates that you must not discard this electrical/electronic product in domestic household waste.

Product Category

With reference to the equipment types in the WEEE directive, this product is classified as a "Monitoring and control instruments" product.

Do not dispose in domestic household waste. When disposing products in the EU, contact your local Yokogawa Europe B.V. office.

Authorized Representative in the EEA

Yokogawa Europe B. V. is Authorized Representative of Yokogawa Test & Measurement Corporation in the EEA for this Product. To contact Yokogawa Europe B.V., see the separate list of worldwide contacts, PIM 113-0122.

Measurement Category:

To ensure safe operation of measuring instruments, IEC 61010 establishes safety standards for various electrical environments, categorized as O to .IV, and called measurement categories.

Measurement category O (Other)

Applies to measurement of circuits that are not directly connected to a main power source.

This category applies to measurement of secondary electric circuits in equipment across a transformer.

Measurement category II

Applies to measurement of circuits, such as household electric appliances and portable electric tools, that are connected to low-voltage installations.

Measurement category III

Applies to measurement of facility circuits, such as distribution boards and circuit breakers.

Measurement category IV

Applies to measurement of power source circuits, such as entrance cables to buildings and cable systems, for low-voltage installations.

Names of Parts

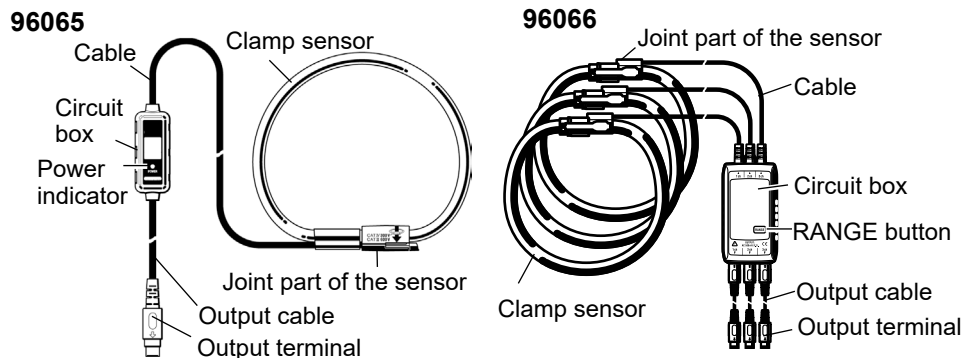

Din Plug Pin Assignment

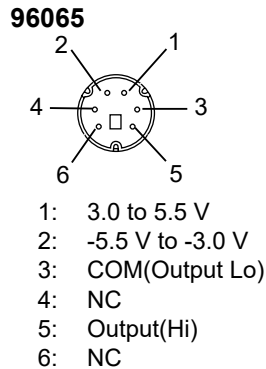

* This clamp-on probe is supplied power via an output cable. Power supply of +3.0 to +5.5 V is required between 1 and 3 of the output terminal and -3.0 to -5.5 V is required between 2 and 3 of the output terminal.

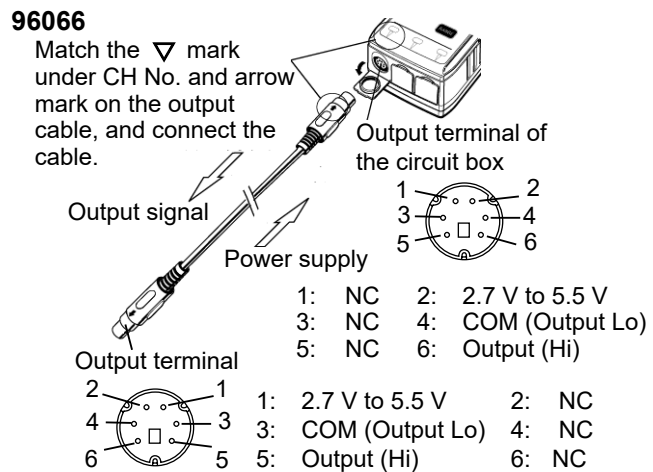

* This instrument is supplied power via an output cable. Power supply of 2.7 to 5.5 V (200 mVA) is required between 1 and 3 of the output terminal and between 2 and 4 of the output connector. Resistance between 3 and 6 of the output terminal and between 4 and 5 of the output connector is as follows. 300 A Range: 910 kΩ, 1000 A Range: 360 kΩ, 3000 A Range: 510 kΩ (Resistance cannot be measured while the instrument is powered off status.)

Specifications

Model	96065	96066
Measureable conductor size	Max. φ110 mm	Max. φ150 mm
Measurement range	AC 0 to 1000 Arms (1850 Apeak)	300 A range: 30 to 300 Arms (424 Apeak) 1000 A range: 100 to 1000 Arms (1414 Apeak) 3000 A range: 300 to 3000 Arms (4243 Apeak)
Output voltage	AC 0 to 500 mVrms (0.5 mV/A)	300 A range: AC 0 to 500 mVrms (1.67 mV/A) 1000 A range: AC 0 to 500 mVrms (0.5 mV/A) 3000 A range: AC 0 to 500 mVrms (0.167 mV/A)
Accuracy Amplitude (sine wave input)	±0.8% rdg ±0.2 mV (45 Hz to 65 Hz) ±1.5% rdg ±0.4 mV (40 Hz to 1 kHz)	±1.0% rdg (45 Hz to 66 Hz) (measuring at center of the sensor)
Accuracy Phase (sine wave input)	±2.0° or less (45 Hz to 65 Hz) ±3.0° or less (40 Hz to 1 kHz)	±1.0° or less (each measurement range, 45 Hz to 65 Hz)
Temperature and humidity range (guaranteed accuracy)	23 ±5°C, 85%RH or less (no condensation)	
Current consumption	2 mA max. (at power supply ±5 V)	15 mA (at power supply 3 V)
Rated voltage between circuit and ground	AC 600 Vrms max	
Operating temperature and humidity range	-10 to 50°C, 85% RH or less (no condensation)	0 to 50°C, 85% RH or less (no condensation)
Storage temperature and humidity range	-20 to 60°C, 85% RH or less (no condensation)	
Temperature coefficient	0.03% rdg/°C (-10 to 50°C)	In the range of 0 to 50°C and the amount of change from 23°C is ±2.5% rdg or less
Maximum allowable input	AC 1300 Arms	AC 3600 Arms(45 Hz to 65 Hz)
Output impedance	100 Ω or less	
Influence of the conductor location	Within ±1.5% rdg	
Influence of the external magnetic field	Current that flows through the conductor ±1.0% rdg or less when separated by a distance of D/4 (27 mm) from the conductor	Current that flows through the conductor ±2.0% rdg or less when separated by a distance of D/4 (37.5 mm) from the conductor
Withstand voltage	AC 5.4 kVrms / 5 seconds Between circuit and sensor.	
Environmental condition	Altitude up to 2000 m, in-door use	
Recommended calibration period	1 year	

Dimension	24 (W) × 65 (H) × 22 (D) mm (excluding projections)	61 (W) × 111 (H) × 37 (D) mm (excluding projections)
Weight	Approx. 170 g	Approx. 950 g
Cable length	Clamp sensor – circuit box: approx. 2.7 m Circuit box – output terminal: approx. 0.2 m	Clamp sensor – circuit box: approx. 2 m Circuit box – output terminal: approx. 0.1 m
Output terminal	MINI DIN 6PIN	
Accessory	User's manual, Cable marker	User's manual, Output cable
Safety standard	Compliant standards: EN 61010-1, EN 61010-2-032 Measurement category III (rated voltage between circuit and ground: 600 Vrms) Measurement category IV (rated voltage between circuit and ground: 300 Vrms) Pollution degree 2*	Compliant standards: EN 61010-1, EN 61010-2-032 Measurement category III (rated voltage between circuit and ground: 600Vrms) Pollution degree 2*
EMC	Compliant standard: EN 61326-1 Class A EMC standards of Australia and New Zealand EN 55011 Class A, Group 1	Compliant standard: EN 61326-1 ClassB, EN 61326-2-2 EMC standards of Australia and New Zealand EN 55011 Class B, Group 1
Environmental Standard	Compliant Standard: EN 50581 Monitoring and control instruments including industrial monitoring and control instruments.	

* Pollution Degree applies to the degree of adhesion of a solid, liquid, or gas that deteriorates withstand voltage or surface resistivity. Pollution degree 2 applies to normal indoor atmospheres (with only non-conductive pollution).

External Dimensions

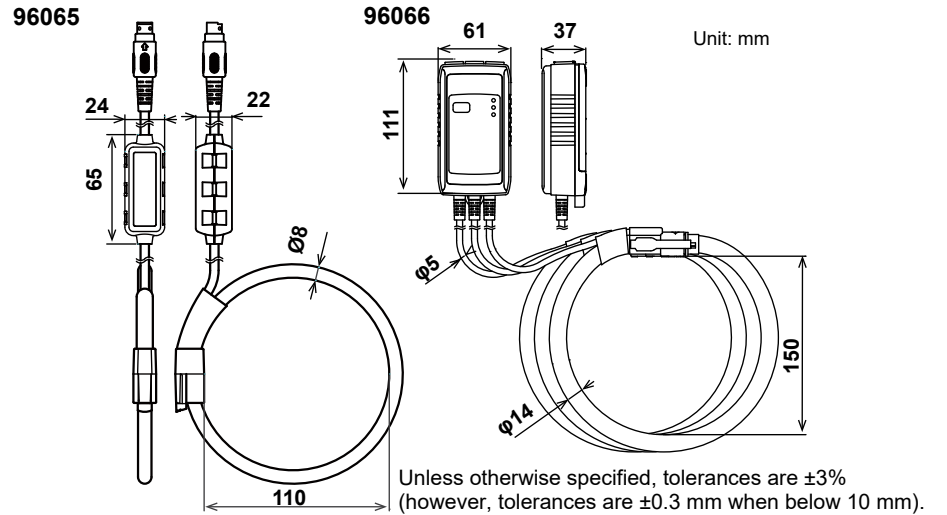

Measurement

CAUTION

- When making current measurements, keep the clamp sensor fully closed. Otherwise, accurate measurements cannot be taken.
- When disconnecting the output terminal from the measuring instrument, do so by removing the plug first and not by pulling the cord.
- Clamp onto one conductor only; measurements cannot be made when clamping single-phase (2-wire) or three-phase (3-wire) at the same time.

Measurement procedures

- Connect the output connector to the Input terminal of the measuring instrument.
- Power on the measuring instrument.
- Disconnect the joint according to the following figure.

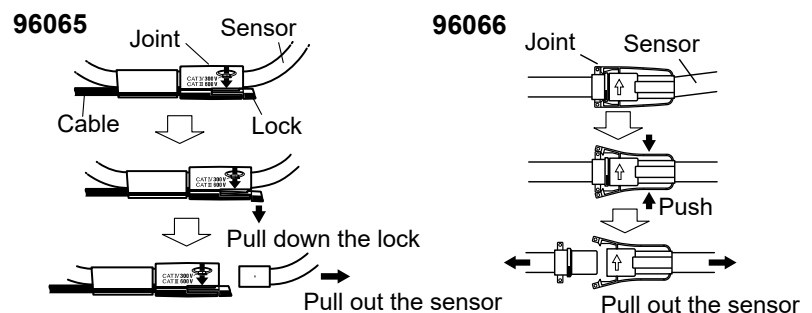

- Clamp onto one conductor under the test. When connecting the sensor with the power meter (CW500 etc.), check the direction of the guide arrow mark indicating the current flowing direction marked on the Joint of the clamp sensor to make the phase of the current under test and output voltage synchronized.

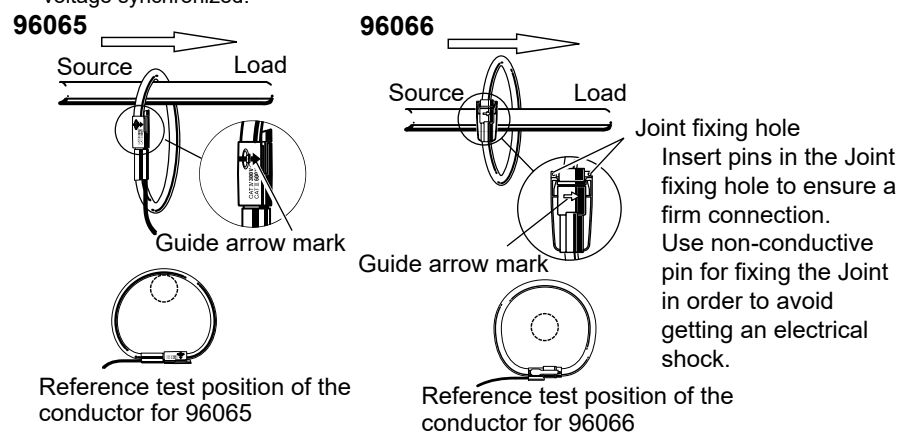

Reference test position of the conductor for 96065

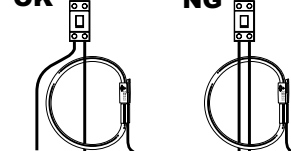

Reference test position of the conductor for 96066

Clamp onto one conductor only.

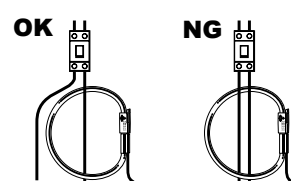

- Confirm that the Joint on the Clamp sensor is firmly locked.
- Select any desirable range (300A/ 1000A/ 3000A) with the RANGE button. When powering off the instrument once and powering on again, the range will be the one selected before powering off the instrument.