



Test Equipment Depot

99 Washington St. Melrose MA, 02176

1.800.517.8431 | 781.665.0780 (Fax)

Instructions
for

EDSYN^{INC}®

971e
LONER®

High Performance Soldering Station



Product Features

- Our newest advanced station with precise temperature control that delivers rapid heat-up and recovery times
- Innovative direct tip-to-heater design provides quicker recovery and better sensing as well as more accurate and stable temperatures at the tip
- New and modern illuminated design for better visibility and to better indicate power on/off
- Innovative handle design makes tip change quicker and easier
- Illuminated temperature graduation markings
- Easy to maintain and calibrate with external calibration access
- Modular sponge tray
- Accepts a wide variety of tips
- RoHS compliant & ESD safe
- 18 month warranty

Package Contents

- 971e** Temperature Controlled Soldering Station includes XP375 Tip
- PD528** Tool Pod
- SH235** Modular Sponge Tray with RS200 Round Cleaning Sponge
- WP556** WIGAPRY® Mini Screwdriver and Calibration Aid Tool



Front Right Side View

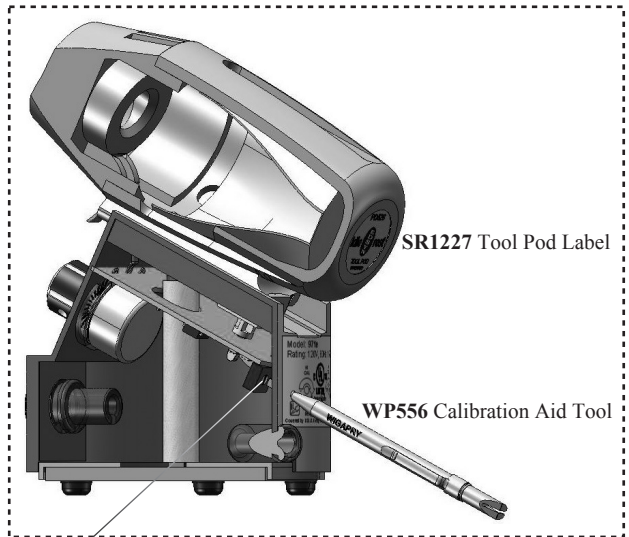

Rear Side Section View

Warning: Do not hit or tap the soldering tool. The ceramic heater element may break

Tip Care

1. Set desired temperature. Blinking Temperature Regulation Indicator means Tool is ready.
2. TIN the Tip. (apply solder)
3. Do not rub, bend or reshape the Tip.
4. Always clean the Tip by wiping it against the moist **RS200*** Sponge or **EA439** Dry Tip Cleaner and RE-TIN as needed with the **LT-1** Tip Tinner and Cleaner.



Temperature Calibration

1. Turn on power and set Temperature Control Knob to 400°F (205°C).
2. Using a clean and well tinned Tip, apply a small amount of solder on the Tip, just enough to form a bead on top of the Tip.
3. Place the center of the thermocouple wire of the **SDS100** on top of the bead.
4. Again, apply a small amount of solder on the center of the thermo-couple wire, just enough to embed the center.
5. Adjust LO-Temp Calibration Pot so the Meter will read 400°F (205°C).
6. Set Temperature Control Knob to 800°F (427°C).
7. Adjust Hi-Temp Calibration Pot so the Meter will read 800°F (427°C).

MS412

Digital Temperature
Measurement System

For a quicker calibration for more than one
station try using the **TP475** Temperature Probe











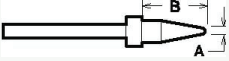

* To avoid transferring debris back to your clean tip make sure you replaces the **RS200** sponge frequently.

Changing Tip

- IMPORTANT:** Make sure your tool is cool.
- Do not twist or wiggle Tip
- Loosen RCS71 Collar by turning it counter-clockwise.
- Remove old Soldering Tip.
- Insert new Tip.
- Tighten RCS71 Collar. (should be “finger” tight only)

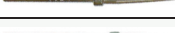
WARNING: Do not use the soldering tool if soldering tip is loose. This will cause the heater element to break.

| Soldering Tips | |  | |
|---|--|--|-----------------|
| Iron Plated for long life-Nickel and Chrome Plated for optimum heat transfer Contact Edsyn for more tip selections | | Width A | Length B |
|  | XP375 LONER Extra Performance Spade Soldering Tip | .06” (1.5mm) | .61” (15.5mm) |
|  | XP441 LONER Extra Performance Spade Soldering Tip | .20” (5.0mm) | .59” (15.0mm) |
|  | LT371LF LONER Spade Soldering Tip (Lead Free) | .03” (0.8mm) | .55” (14.0mm) |
|  | LT375LF LONER Spade Soldering Tip (Lead Free) | .06” (1.5mm) | .48” (12.2mm) |
|  | LT375 LONER Spade Soldering Tip | .06” (1.5mm) | .48” (12.2mm) |
|  | LT376 LONER Spade Soldering Tip | .12” (3.0mm) | .48” (12.2mm) |
|  | LT394 LONER Spade Soldering Tip | .07” (1.8mm) | .93” (23.6mm) |
|  | LT374 LONER Conical Soldering Tip | .03” (0.8mm) | .48” (12.2mm) |
|  | LT382 LONER Conical Soldering Tip | .02” (0.5mm) | .62” (15.8mm) |

More Tips are available at our website (www.edsyn.com) or in our General Line Catalog.

SET-UP REQUIRED FOR SPADE, CONICAL, AND EXTRA PERFORMANCE TIPS

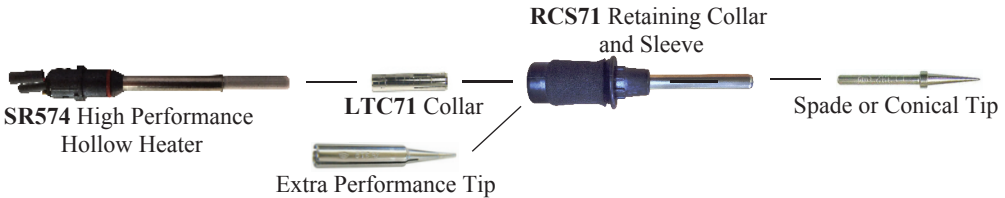

OPTIONAL:

Apply **AN112 Anti-Seize Compound** or **AN122 High Heat Anti-Seize Syringe Dispenser** to Heater and area of Tip contact.



971e

Exploded View

Tool Pod Maintenance

Replace SC581 Solder Collector

1. Hold Thermal Housing (1A) firm and turn Front Housing (1C) counter-clockwise and pull it apart.
2. Remove used Solder Debris Collector (1B) and replace with a new one.
3. Reassemble (1A) to (1C) (for correct fit line up tabs to slots)

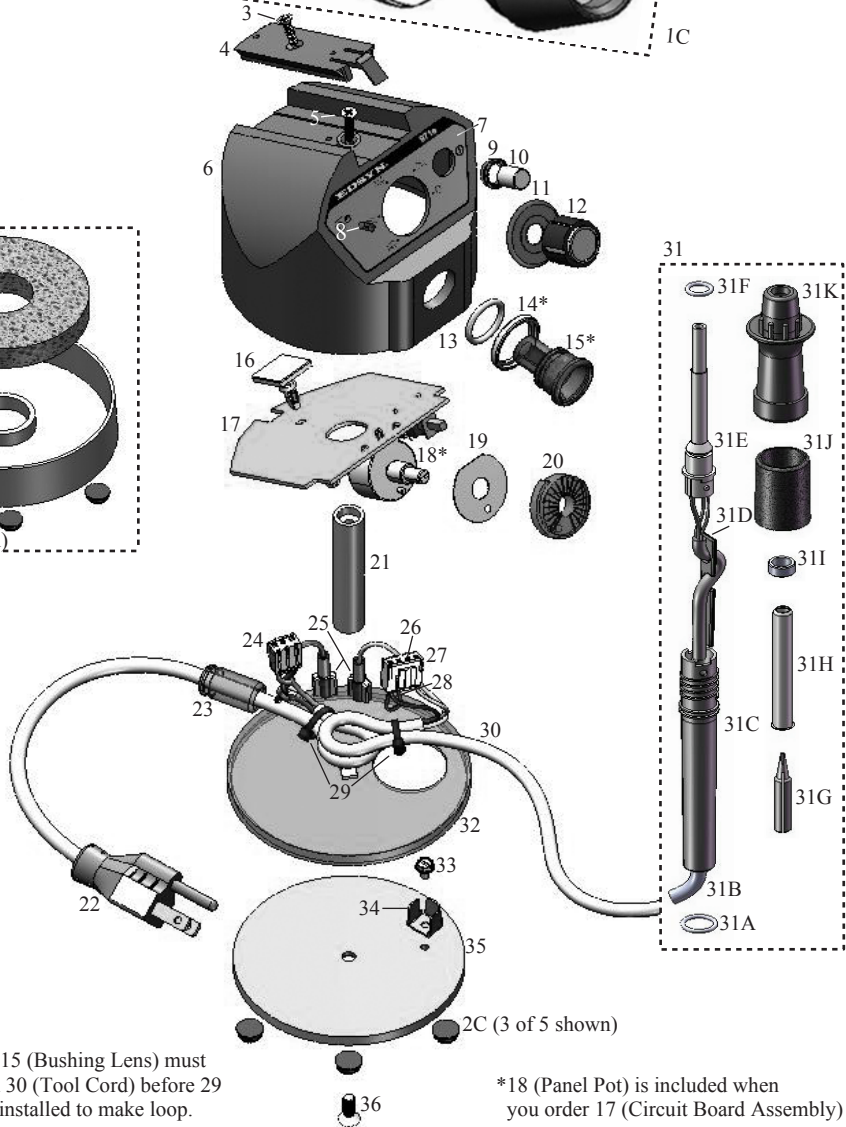
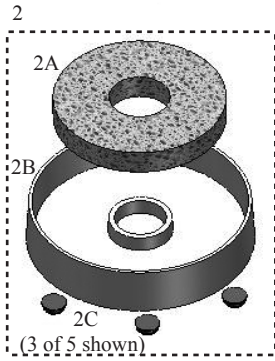
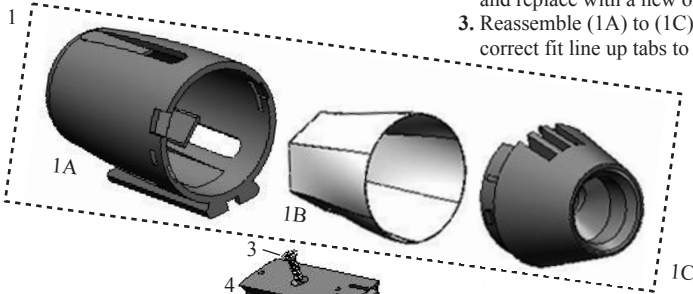

*14 (Ring) and 15 (Bushing Lens) must be installed on 30 (Tool Cord) before 29 (Cable Tie) is installed to make loop.

*18 (Panel Pot) is included when you order 17 (Circuit Board Assembly)

971e Spare Parts List

| ITEM NO. | PART NO. | DESCRIPTION | QTY. NEEDED |
|----------|---------------|---|-------------|
| 1 | PD528 | Tool Pod (includes SC581) | 1 |
| 1A | SR042 | Thermal Housing for Tool Pod | 1 |
| 1B | SC581 | Solder Debris Collector | 1 |
| 1C | SR043 | Front Housing for Tool Pod | 1 |
| 2 | SH235 | Modular Sponge Tray Holder (includes RS200 round cleaning sponge) | 1 |
| 2A | RS200 | Round Cleaning Sponge | 1 |
| 2B | SR1225 | Sponge Tray | 1 |
| 2C | SR251 | Rubber Feet (Set of 4) | 2.50 set |
| 3 | SR367 | Phillips Flat Head Screw | 1 |
| 4 | SR784 | Single Dovetail Track | 1 |
| 5 | SR772 | Phillips Flat Head Screw | 1 |
| 6 | SR1200 | Housing for Soldering Station | 1 |
| 7 | SR1420 | Front Panel Label | 1 |
| 8 | SR1226 | Front Panel Mount Light Pipe | 1 |
| 9 | SR1202 | Switch Button Lens Ring | 1 |
| 10 | SR1203 | Round Chrome Switch Cap | 1 |
| 11 | SR1205 | Dial Face Lens Cover | 1 |
| 12 | SR1204 | Black Control Knob | 1 |
| 13 | SR1208 | Silicone O-Ring | 1 |
| 14 | SR1207 | Ring for Tool Cord Bushing Lens | 1 |
| 15 | SR1206 | Tool Cord Bushing Lens | 1 |
| 16 | SR1224 | Locking PCB Support | 1 |
| 17 | SR1223 | Circuit Board Assembly | 1 |
| 18* | SR1211 | 5K Wire-Wound Panel Pot | 1 |
| 19 | SR1210 | Background Washer for Dial Face | 1 |
| 20 | SR1209 | Dial Face Lens | 1 |
| 21 | SR1212 | Base Post Enclosure | 1 |

* Included when ordering circuit board assembly

971e
Spare Parts List Cont'd.

| ITEM NO. | PART NO. | DESCRIPTION | QTY NEEDED |
|----------|---------------|--|------------|
| 22 | SR1221 | Power Cord Assembly | 1 |
| 23 | SR1222 | Power Cord Bushing Lens | 1 |
| 24 | SR432 | 3 Circuit Housing Connector (Set of 3) | .3 set |
| 25 | SR495 | Female Fully Insulated Connector (Set of 5) | .4 set |
| 26 | SR415 | Terminal Crimp (Set of 10) | .3 set |
| 27 | SR1213 | 4 Circuit Housing Connector | 1 |
| 28 | SR445 | Black Wire | .16ft |
| 29 | SR1214 | Cable Tie | 2 |
| 30 | SR059 | Tool Cord | 1 |
| 31* | SR575 | High Performance Soldering Tool, Complete Assembly | 1 |
| 31A | SR240 | O-Ring | 1 |
| 31B | SR525 | Static-Safe Silicone Black Hose | .43ft |
| 31C | SR579 | Handle | 1 |
| 31D | SR058 | Strain Relief | 1 |
| 31E | SR574 | High Performance Hollow Heater Assembly (includes Shrink Sleeving) | 1 |
| 31F | SR001 | O-Ring | 1 |
| 31G | XP375 | LONER Extra Performance Spade Soldering Tip | 1 |
| 31H | HPS82 | Retaining Sleeve | 1 |
| 31I | SR881 | Teflon Washer | 1 |
| 31J | SR063 | Vinyl Sleeve | 1 |
| 31K | SR1421 | Threaded Collar | 1 |
| 32 | SR1216 | Clear Lens Base Cover | 1 |
| 33 | SR1217 | Hex Screw | 1 |
| 34 | SR1220 | 3 Terminal Ground Lug | 1 |
| 35 | SR1218 | Metal Base | 1 |
| 36 | SR1219 | Flat Head Screw | 1 |

* Also included are items 30,29,28,27,26,15,14, and 13.

Specifications

| | |
|--------------------------------|--|
| Power Requirements | 120V, 60Hz |
| Power Rating | 15W - 220W |
| Heater Rating | 120V, 95W |
| Temperature Range | 400°F-800°F/205°C-427°C |
| Temperature Regulations | ±6°F/±3°C |
| Tip-to-Ground Voltage | |
| Leakage/Resistance | < 2mV/< 2 ohms |
| Overall Dimension | 4.11"W x 6½"H x 4"D 104 mm x 166mm x 102 mm |
| Weight | 2.12bs (.96 kg) |

Warranty

Edsyn stands behind its products. We warranty that new tools will be free from defects for 18 months from the date of purchase. During this time period Edsyn will repair or, at its option, replace the tool at no charge. This warranty does not include tips and accessories. Any tool that appears to have been deliberately abused, altered, or destroyed is not covered by this warranty.

Technical Support

Contact our Customer Service for assistance related to the purchase of this product or recommendations on a challenge that you may encounter. There are many replacement parts that are available to keep your tool in top condition. To speak to someone in Customer Service, call 818-989-2324.

©Copyright 2015 by EDSYN®, Inc. All Rights Reserved

No part of this publication, including individual icons, may be reproduced or utilized in any form or by any means without the written permission of EDSYN®, Inc.



Designed Patented & Assembled in U.S.A.



Design, color, weight, and material subject to change without notice. Components from other designs may be used with information pertaining to it, but not applicable to another use.
Labels and instructions will supersede this information.



 **Test Equipment Depot**

99 Washington St. Melrose MA, 02176

1.800.517.8431 | 781.665.0780 (Fax)

▶ Visit us at www.TestEquipmentDepot.com

Form. 971e