

Test Equipment Depot - 800.517.8431 -  
5 Commonwealth Ave, MA 01801

TestEquipmentDepot.com

# CM4141-50

## AC CLAMP METER



Read carefully before use.  
Keep for future reference.

Dec. 2021 Edition 1  
CM4141C961-00 21-12H

# HIOKI

## Instruction Manual



EN



\* 6 0 0 6 2 5 7 1 0 \*



# Contents

Introduction.....	1
Notations .....	2
Checking Package Contents .....	7
Options .....	8
Safety Information .....	11
Operating Precautions .....	12
<b>1 Overview</b> .....	<b>19</b>
1.1 Product Overview and Features .....	19
1.2 Part Names .....	20
<b>2 Making Measurements</b> .....	<b>21</b>
2.1 Inspection Before Measurement.....	21
2.2 Installing Batteries and the Z3210 Wireless Adapter .....	22
Installation procedure .....	25
2.3 Use of Test Leads.....	28
L9300 Test Lead (accessory).....	30

<b>2.4</b>	<b>Current Measurement</b> .....	<b>32</b>
	Manual hold, automatic hold .....	33
	Switching the ranges .....	36
	Maximum, minimum, average, and peak Values .....	37
	Filter function .....	38
	Inrush current (AC inrush) .....	39
<b>2.5</b>	<b>Various Other Measurement Functions</b> .....	<b>40</b>
<b>2.6</b>	<b>LCD Backlight, Automatic Power Save (APS)</b> .....	<b>44</b>
<b>2.7</b>	<b>DC High V Probe Mode</b> .....	<b>45</b>
<b>2.8</b>	<b>Wireless Communications Function (Z3210 required)</b> .....	<b>49</b>
	Using GENNECT Cross.....	49
	Z3210-to-Excel® direct data entry function (Excel® direct input function, HID function) .....	54
<b>2.9</b>	<b>Rotary Switch Combinations</b> .....	<b>58</b>
<b>3</b>	<b>Specifications</b> .....	<b>61</b>
<b>3.1</b>	<b>General Specifications</b> .....	<b>61</b>
<b>3.2</b>	<b>Input Specifications, Measurement Specifications</b> .....	<b>64</b>
<b>3.3</b>	<b>Accuracy table</b> .....	<b>72</b>

<b>4</b>	<b>Maintenance and Service</b>	<b>89</b>
4.1	Troubleshooting .....	89
4.2	Error and Operation Display .....	92
4.3	Cleaning .....	93
<b>Index</b>		<b>95</b>



## Introduction

Thank you for choosing the Hioki CM4141-50 AC Clamp Meter. To ensure your ability to get the most out of this instrument over the long term, please read this manual carefully and keep it available for future reference.

Read the separate document “Operating Precautions” carefully before using the instrument.

### Latest edition of instruction manual

The contents of this manual are subject to change, for example as a result of product improvements or changes to specifications.

The latest edition can be downloaded from Hioki’s website.

<https://www.hioki.com/global/support/download>



### Target audience

This manual has been written for use by individuals who use the product in question or who teach others to do so. It is assumed that the reader possesses basic electrical knowledge (equivalent to that of someone who graduated from the electrical program at a technical high school).

## Notations



### Trademarks

- Microsoft Excel is a registered trademark or a trademark of Microsoft Corporation in the United States and other countries.
- The Bluetooth® word mark and logos are registered trademarks owned by Bluetooth SIG, Inc. and any use of such marks by Hioki E.E. Corporation is under license. Other trademarks and trade names are those of their respective owners.





## Notations

### Safety notations







In this document, the severity levels of risk and hazard are classified as follows.

 <b>DANGER</b>	Indicates an imminently hazardous situation that, if not avoided, will result in death or serious injury.	<b>IMPORTANT</b>	Indicates information or content that is particularly important from the stand point of operating or maintaining the instrument.
 <b>WARNING</b>	Indicates a potentially hazardous situation that, if not avoided, could result in death or serious injury.		Indicates a high-voltage hazard. Failure to verify safety or improper handling of the instrument could lead to electric shock, burn injury, or death.





 <b>CAUTION</b>	Indicates a potentially hazardous situation that, if not avoided, could result in minor or moderate injury.		Indicates the presence of a hazard caused by a strong magnet. The product could interfere with the proper operation of electronic medical devices such as pacemakers.
 <b>NOTICE</b>	Indicates potential risks of damage to the supported product (or to other property).		Indicates an action that must not be performed.
			Indicates an action that must be performed.

## Symbols shown on the instrument

	Indicates the presence of a potential hazard. For more information about locations where this symbol appears on instrument components, see the “Operating Precautions” (p.12), warning messages listed at the beginning of operating instructions, and the accompanying document entitled “Operating Precautions.”
	Indicates that a dangerous voltage is generated from this terminal.
	Indicates that the product can be attached or detached while the circuit is live.
	Indicates alternating current (AC).
	Indicates direct current (DC).
	Indicates the grounding terminal.
	Indicates the instrument is protected throughout by double insulation or reinforced insulation.

## Symbols for various standards

	Indicates that the product is subject to the Waste Electrical and Electronic Equipment (WEEE) Directive in EU member nations. Dispose of the product in accordance with local regulations.
	Indicates that the product complies with standards imposed by EU directives.

## Screen display

The instrument screen displays the alphanumeric characters as follows.

A	B	C	D	E	F	G	H	I	J	K	L	M	N	O	P	Q	R	S	T	U	V	W	X	Y	Z
A	b	C	d	E	F	G	H	,	J	K	L	ñ	n	o	P	q	r	S	t	U	u	y	1	4	≡

1	2	3	4	5	6	7	8	9	0
1	2	3	4	5	6	7	8	9	0

Some displays may be different from those indicated on the left.

*OPEn* : Wire break detected

## Notations

### Accuracy labeling

Instrument accuracy is expressed by defining a percentage of the reading, a percentage of full scale, a percentage of the setting, or a limit value for errors in terms of digits.

<b>Reading (display value)</b>	Indicates the value displayed by the instrument. Limit values for reading errors are expressed as a percentage of the reading (“% rdg”).
<b>Full scale (maximum display value)</b>	Indicates the maximum display value for each measurement range. Measurement range values for the instrument indicates that maximum display value. Limit values for full-scale errors are expressed as a percentage of full scale (“% f.s.”).

### Other notations

	Indicates a buzzer sound (either intermittent or continuous).
<b>(p. )</b>	Indicates the page number to reference.
*	Indicates additional information is described below.

## Checking Package Contents

When you receive the instrument, inspect it to ensure that no damage occurred during shipment. Pay particular attention to included accessories, panel keys, and terminals. If you find any damage or discover that the instrument does not perform as indicated in its specifications, please contact your authorized Hioki distributor or reseller.

- CM4141-50  
AC Clamp Meter

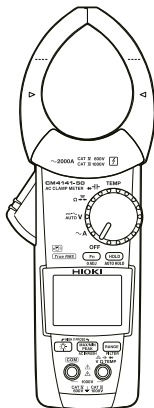

- L9300 Test Lead (p.30)



- C0203 Carrying Case



- LR03 Alkaline batteries ×2



- Instruction Manual (this manual)



- Operating Precautions (0990A907)



## Options

The options listed below are available for the instrument. To order an option, please contact your authorized Hioki distributor or reseller.

Options are subject to change. Check Hioki's website for the latest information.

### Connection cables

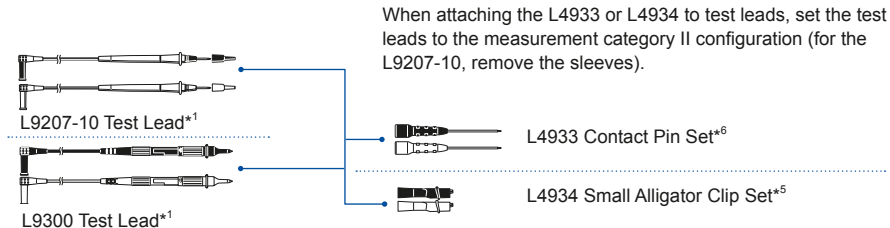

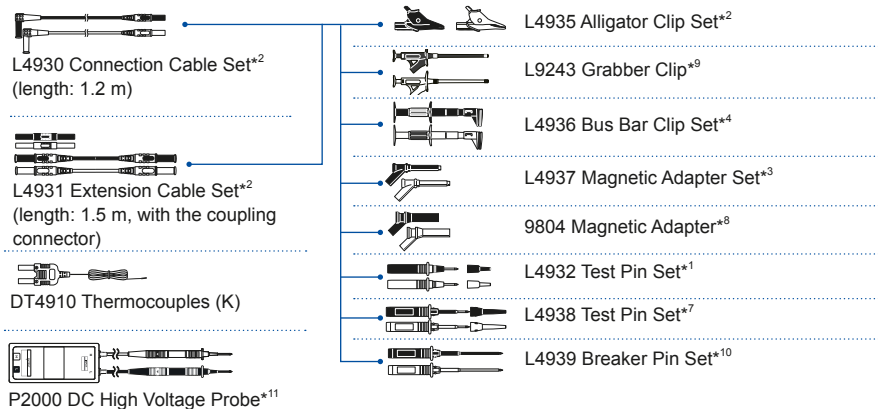

\*1: CAT IV 600 V/CAT III 1000 V/CAT II 1000 V, 10 A

\*2: CAT IV 600 V/CAT III 1000 V, 10 A

\*3: CAT III 1000 V, 2 A

\*4: CAT III 600 V, 5 A

\*5: CAT III 300 V/CAT II 600 V, 3 A

\*6: 30 V AC/60 V DC, 3 A

\*7: CAT III 600 V/CAT II 600 V, 10 A

\*8: CAT IV 1000 V, 2 A

\*9: CAT II 1000 V, 1 A

\*10: CAT III 600 V, 10 A

\*11: CAT IV 1000 V/CAT III 2000 V

## Options

### Carrying cases

The instrument, test leads, and the instruction manuals can be accommodated.

C0203 Carrying Case



C0207 Carrying Case (bag type)



### Z3210 Wireless Adapter



Connecting the Z3210 to the instrument enables the wireless communication function.

See "2.8 Wireless Communications Function (Z3210 required)" (p.49).



## Safety Information

### Measurement categories

The instrument conforms to the safety requirements for CAT III 1000 V and CAT IV 600 V measuring instruments.

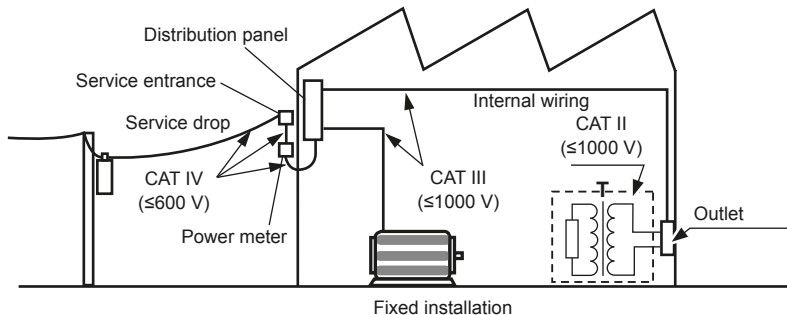

## Operating Precautions

Observe the following precautionary information to ensure that the instrument can be used safely and in a manner that allows it to perform as described in its specifications. Carefully read the separate document entitled “Operating Precautions” before use. Use of the instrument should conform not only to its specifications, but also to the specifications of all accessories, options, and other equipment in use.

### DANGER

■ **Do not touch the section beyond the barrier during operation.**

Failure to do so could cause the operator to experience an electric shock.  
See “1.2 Part Names” (p.20).



■ **Do not measure any current in excess of the derating.**

Doing so can cause overheating of the sensor, resulting in bodily injury, fire, or damage to the instrument.

See “Frequency derating” (p.65).

The maximum measurement current varies with the frequency, and the current that can be measured continuously is limited. Operating the instrument at less than this limitation is referred to as derating.

---

 **DANGER**

- **Do not apply a voltage across the measurement terminals when the resistance measurement, continuity check, diode check, capacitance measurement, or temperature measurement function is selected**

Doing so could cause an electric shock or damage the instrument. To avoid electrical accidents, turn off the circuit before measuring it.



- **Confirm that the white portion (insulation layer) inside the cable is not exposed.**

Using the instrument with a color inside its cable exposed could cause the operator to experience an electric shock.

 **WARNING**

- **Do not allow the instrument to get wet.**
- **Do not take measurements with wet hands.**

Failure to do so could cause the operator to experience an electric shock.



- **When using the instrument while connected to test leads, do not make measurements that exceed either of the ratings indicated on the instrument or on the test leads, whichever is lower.**

Using the instrument to make measurements that exceed either rating could cause the operator to experience an electric shock.

**IMPORTANT**

- Do not allow any foreign object to be caught between the facing core surfaces of the jaws.
- Do not scratch the facing core surfaces of the jaws.
- Do not touch the facing core surfaces of the jaws with your fingers.
- Do not insert any foreign object into the gap of the jaws.
- Do not drop the instrument.
- Do not subject the instrument to any shock.

Doing so may adversely affect the measurement accuracy and open/close operation.

Clamp the instrument around only one conductor. Clamping the instrument around two or more of conductors in a bundle prevents the instrument from measuring any current regardless of whether the measurement target is a single-phase or three-phase circuit.

**L4937 Magnetic Adapter Set / 9804 Magnetic Adapter**

** DANGER**



- **People with electronic medical devices such as pacemakers should not use the magnetic adapter.**
- **Keep the magnetic adapter away from the body.**

Failure to do so may affect proper operation of the electric medical devices, presenting a hazard to human life.

---

 **NOTICE**

- **Do not drop the magnetic adapter.**
- **Do not subject the magnetic adapter to mechanical shock.**

Doing so could damage the magnetic adapter.
- **Do not use the magnetic adapter in locations where it may be exposed to rainwater, dust, or condensation.**

Doing so could decompose or deteriorate the magnetic adapter. In addition, diminished magnetic adhesion cause the instrument to drop, resulting in damage to the instrument.
- **Do not bring the magnetic adapter near magnetic storage devices, such as floppy disks, magnetic cards, prepaid cards, or magnetized tickets.**
- **Do not bring the magnetic adapter near precision electronic equipment, such as computers, TV screens, or electronic wrist watches.**

Doing so could damage such devices or data stored in them.



## Operating Precautions







## 1.1 Product Overview and Features

This instrument is a clamp meter that can perform true RMS measurement of current simply by clamping it around a circuit. In addition to current, it can measure voltage, frequency, rush current, resistance, diode, capacitance, and temperature.

Installing the Z3210 Wireless Adapter (optional) to the instrument allows your mobile device to display waveforms and measure harmonics.

### Measurement function list

<b>TEMP</b>	Temperature
	Capacitance, diode
	Continuity check, resistance
	AUTO V, AC voltage, DC voltage, AC+DC voltage
	AC current

## 1.2 Part Names

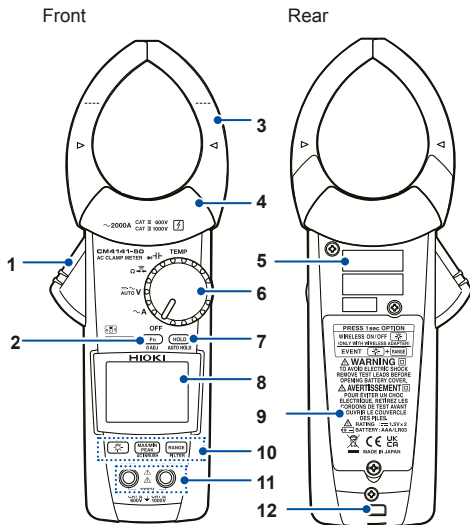

1	Operation grip
2	<b>Fn</b> key (Selects function indicated in blue lettering)
3	Jaws (p.32)
4	Barrier
5	Serial number (The serial number consists of 9 digits. The first two (from the left) indicate the year of manufacture, and the next two indicate the month of manufacture.)
6	Rotary switch
7	<b>HOLD</b> key
8	LCD
9	Battery cover
10	Operation keys
11	Measurement terminals
12	Strap hole

## 2

## Making Measurements

## 2.1 Inspection Before Measurement

Check if there is any damage to the instrument occurred during storage or shipping and verify that instrument operates normally before using it. If you find any damage, contact your authorized Hioki distributor or reseller.

2

Check	Inspection details	Check	Inspection details
<input type="checkbox"/>	The battery cover is closed and its screw has been securely tightened.	<input type="checkbox"/>	There is no damage to the test lead insulation, and neither the white sheathing nor metal conductor inside the wire are exposed.
<input type="checkbox"/>	There is no foreign matter on the measurement terminals (p.20).	<input type="checkbox"/>	The instrument is neither damaged nor cracked.
<input type="checkbox"/>	The test leads are not broken. (p.41)	<input type="checkbox"/>	No segments are missing.

OK

1 Ω or less

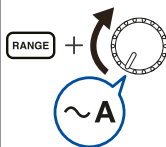
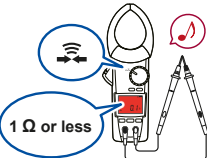

(All segments appear)

## 2.2 Installing Batteries and the Z3210 Wireless Adapter

Installing the Z3210 to the instrument enables the wireless communications function. (p.49)

### WARNING



- **Before removing the battery cover, remove the instrument from an object under measurement and set the rotary switch to the OFF position.**

Failure to do so could cause the operator to experience an electric shock. When the instrument is clamped around the object under measurement, the battery contact terminals are regarded as high-voltage parts.

## WARNING

- **After replacing the batteries or installing/removing the Z3210 Wireless Adapter, install the battery cover and tighten the screw, then use the instrument.**

Use of the instrument with the battery cover removed could result in bodily injury.



- **Secure the battery cover with the screw attached to the instrument at the time of shipment.**

Securing the battery cover with another screw could damage the instrument, resulting in bodily injury. If you have lost the screw or find that the screw is damaged, please contact your authorized Hioki distributor or reseller.

## NOTICE

- **Do not mix batteries of different ages or types.**
- **Do not use a battery whose recommended service life has expired.**
- **Do not reverse the battery polarity.**
- **Do not leave the exhausted batteries in the instrument.**

Doing so may cause the batteries to leak, damaging the instrument.



## NOTICE

- **Use the specified type of batteries only (LR03 Alkaline batteries).**
- **Remove the batteries when the instrument is not in use for an extended period of time.**



Doing so may cause the batteries to leak, damaging the instrument.

- **Before handling the Z3210, eliminate static electricity on your body by touching any metallic part, such as a doorknob.**

Failure to do so may cause static electricity to damage the Z3210.

- 
- **When the  mark blinks, the batteries will be exhausted. Replace the batteries with new ones in good time. The instrument may be turned off when the display is backlit or the buzzer sounds. After use, be sure to turn off the instrument.**
  - **Dispose of the batteries in accordance with local regulations.**

## Installation procedure

Read the precautions before performing the procedure. (p.22)

### You will need:



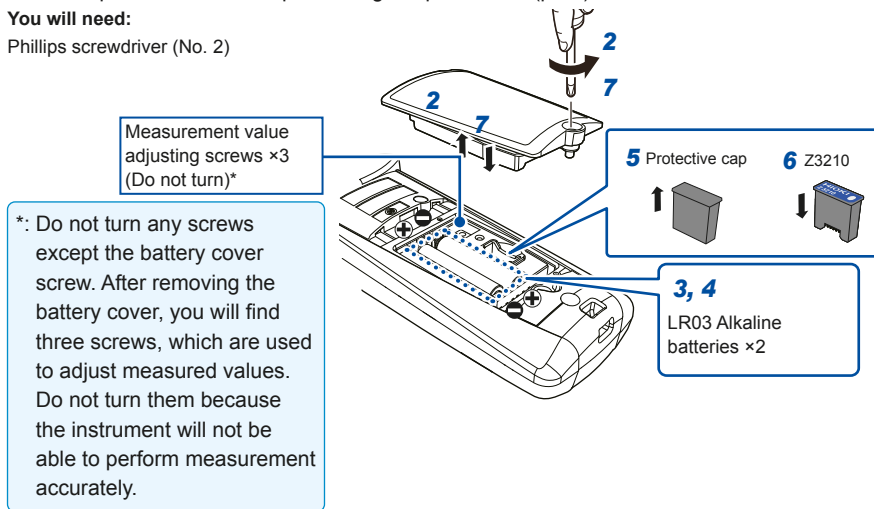

Phillips screwdriver (No. 2)



## Installing Batteries and the Z3210 Wireless Adapter

- 1 Remove the instrument from an object under measurement and set the rotary switch to the OFF position.**
- 2 Loosen the screw and remove the battery cover.**
- 3 Remove the old batteries (when replacing the batteries).**
- 4 Install fresh batteries, observing the correct polarity.**  
When installing the Z3210 Wireless Adapter, go on to step **5**.  
When not installing the Z3210 Wireless Adapter, go on to step **7**.
- 5 Remove the protective cap from the instrument.**
- 6 Install the Z3210 Wireless Adapter, observing the correct orientation.**
- 7 Reattach the battery cover and tighten the screw.**



Battery indicator	Description
	Fully charged.
	As the battery charge diminishes, black charge bars disappear, one by one, from the left of the battery indicator.
	The battery voltage is low. Replace the batteries in good time.
	(Blinks) The batteries are exhausted. Replace the batteries with fresh ones.

## 2.3 Use of Test Leads

The L9300 Test Lead (accessory) or the L9207-10 Test Lead (optional) is used for measurement. Depending on measurement locations, use Hioki's optional measurement cables. See "Options" (p.8).

### WARNING



■ **When using the instrument, use the test leads and options specified by Hioki.**

Using test leads and options other than those specified could cause bodily injury or short circuit accidents.



■ **When measuring the power line voltage, use test leads that satisfy the following conditions.**

- IEC 61010 or EN 61010 safety standard-compliant
- Rated for measurement category III or IV
- With the rated voltage higher than voltage being measured

Failure to do so could cause the operator to experience an electric shock.

The optional test leads for this instrument comply with the EN 61010 safety standard. Observe the measurement category and rated voltage indicated on the test leads during use.

 **CAUTION**

- **Do not bend the cables at temperatures of 0°C or lower. Do not pull on the cables.**



The cables can become rigid. Doing so could damage the insulation or cause a wire break, resulting in an electric shock.

- **Do not step on cords or allow them to caught between other objects.**
- **Do not touch the tips of test leads.**

## L9300 Test Lead (accessory)

See the precautions in “2.3 Use of Test Leads” (p.28) as well.

### **WARNING**



- Use the test leads with the correct measurement category displayed.
- Do not use the test leads if the metal pin is bent or the protective finger guard does not slide properly.

Doing so could cause short circuit accidents.

### Switching the measurement category

#### 1 Unlock the protective finger guard.

Rotate the grip to unlock, moving the ▷ mark along the guide line.

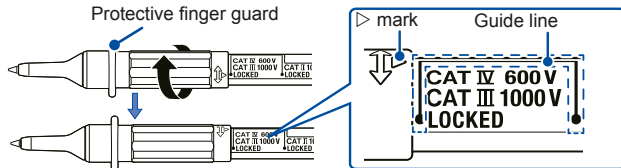

## 2 Slide the protective finger guard.

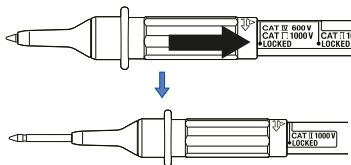

Slide the ▷ mark along the guide line.

## 3 Lock the protective finger guard.

Rotate the grip to lock, moving the ▷ mark along the guide line.

Rotate the grip until it clicks, and make sure that the ▷ mark indicates **[LOCKED]**.

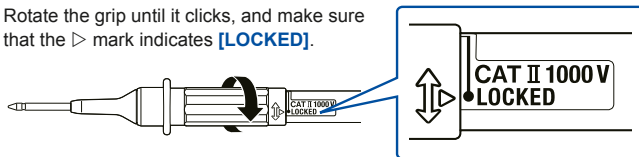

Perform the above steps to switch over from measurement category II to measurement category III or IV as well.

## 2.4 Current Measurement

- 1 Rotate the rotary switch.



- 2 Clamp the instrument around the wire.

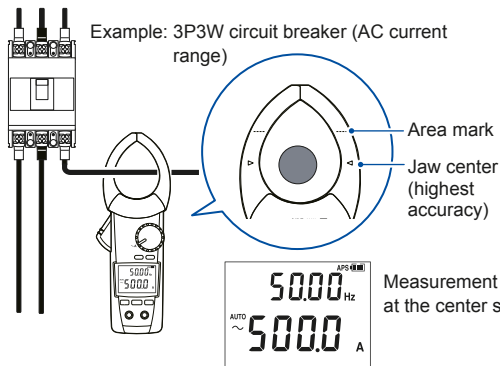

Measurement accuracy will improve when the wire is placed at the center side of the area mark. (p.71)

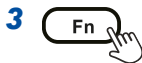

~ + Hz ↔ Hz  
(AC A) (Frequency) (Frequency)

### Frequency detection range for AC current

3 A or more (60.00 A range)  
30 A or more (600.0 A range)  
200 A or more (2000 A range)

### Range (p.36)

Default setting: Automatic ranging  
Press the **RANGE** to switch over to the manual ranging.

## Manual hold, automatic hold

### Manual hold

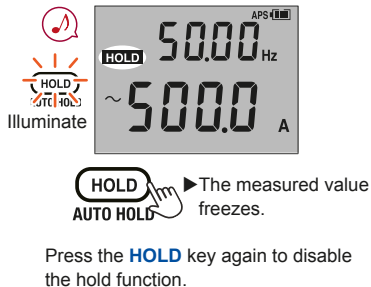

### Automatic hold

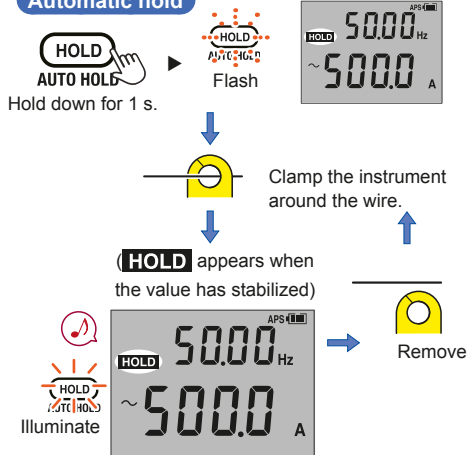

The measured value freezes automatically.

Holding down the **HOLD** key for 1 s to disable the automatic hold function.

### Automatic hold conditions

Displayed value will freeze when the following two conditions are satisfied at the same time:

- When the measured value exceeds the threshold value described in the table on the next page (voltage, current).

When the measured value is less than the threshold value described in the table on the next page (resistance, continuity check, diode).

- When the measured value fluctuation stabilizes within the fluctuation range described in the table on the next page.

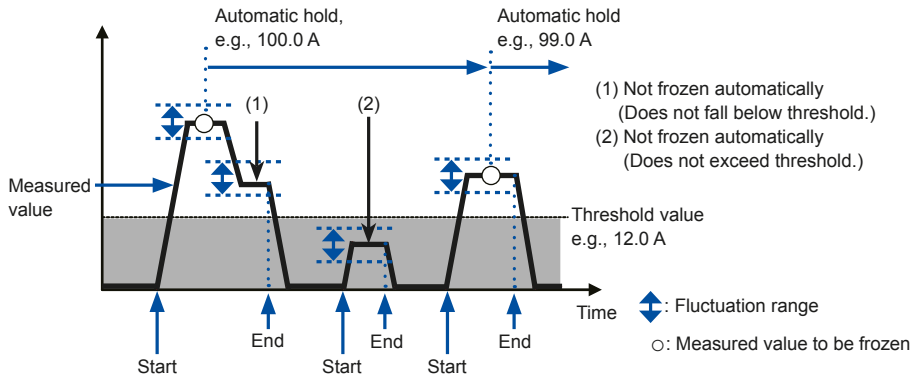



Suppose that the measured value has fallen below (voltage, current) or exceeded the threshold value (resistance, continuity check, diode) after the displayed value froze. When the two auto-hold conditions are met again after that, refreshing measured values will stop.

Measurement function* <sup>1</sup>	Fluctuation range	Threshold value
AC current	60.00 A range: within 400 counts 600.0 A range: within 400 counts 2000 A range: within 40 counts	60.00 A range: within 100 counts 600.0 A range: within 120 counts 2000 A range: within 40 counts
AUTO V* <sup>2</sup> AC voltage DC voltage* <sup>2</sup> AC+DC voltage	6.000 V, 60.00 V, 600.0 V ranges: within 120 counts 1000 V range: within 20 counts	6.000 V, 60.00 V, 600.0 V ranges: within 120 counts 1000 V range: within 20 counts
DC High V Probe Mode	600.0 V range: within 12.0 V 2000 V range: within 20 V	80.0 V 80 V
Resistance Continuity check	600.0 $\Omega$ , 6.000 k $\Omega$ , 60.00 k $\Omega$ , 600.0 k $\Omega$ , 6.000 M $\Omega$ ranges: within 100 counts	600.0 $\Omega$ , 6.000 k $\Omega$ , 60.00 k $\Omega$ , 600.0 k $\Omega$ , 6.000 M $\Omega$ ranges: within 4900 counts
Diode	1.800 V range: within 40 counts	1.800 V range: within 1460 counts

\*1: The automatic hold function does not support measurement functions not listed in this row.

\*2: Except the 600.0 mV range (Only with the manual ranging).

## Switching the ranges

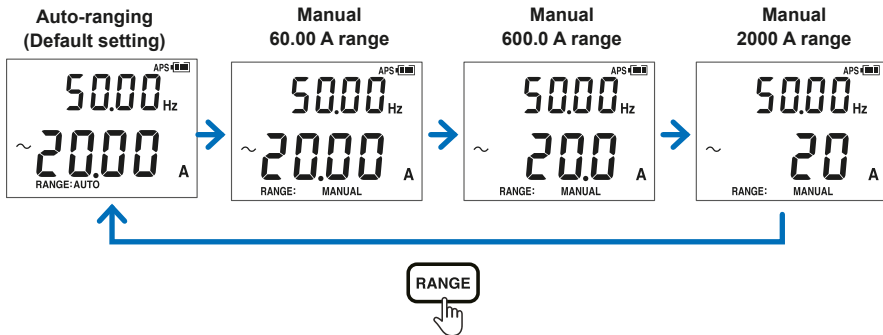

## Maximum, minimum, average, and peak Values

- 1 Clamp the instrument around the wire.



- 2 **RANGE**

See "Switching the ranges" (p.36).

In automatic ranging mode, the instrument will be automatically set to the 2000 A range.

- 3 **MAX/MIN PEAK**

MAX → MIN → AVG → **PEAK MAX** → **PEAK MIN**

- 4 **HOLD**

► The measured value freezes.

**MAX/MIN PEAK**

Hold down for 1 s.  
► Cancel

The instrument measures RMS values.

AVG indicates the average of all measured values.

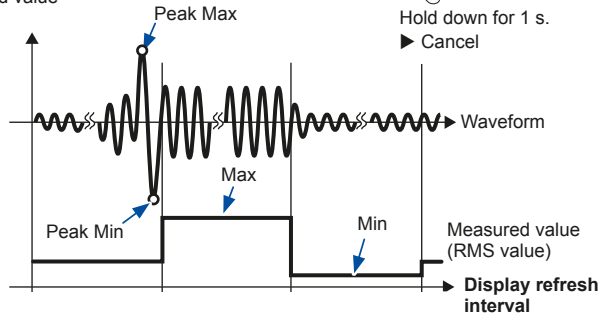

## Filter function

### Filter off

Measured value including noise

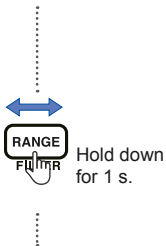

### Filter on

Measured value with reduced noise



**Frequency characteristics when the filter function is enabled (100 A input)**

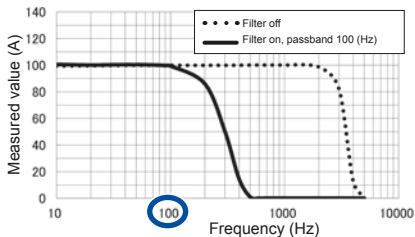

Disable the filter function when performing measurement of power supply frequencies in excess of 100 Hz, for example, on an aircraft or ship.

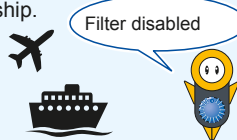

## Inrush current (AC inrush)

**1** Turn off the motor.

**2** Rotate the rotary switch.



**3** Clamp the instrument around the wire.

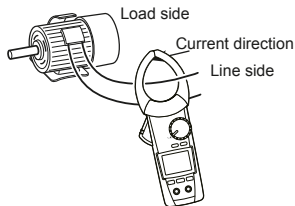

**4** Set the range.



See "Switching the ranges" (p.36).  
In automatic ranging mode, the instrument will be automatically set to the 2000 A range.

**5** Hold down for 1 s.



▶ AC Inrush on

**6** Turn on the motor.

The instrument can measure AC inrush current.  
Inrush current with DC component superimposed cannot be measured accurately.

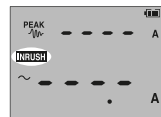
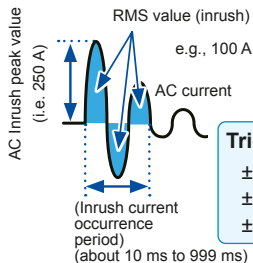

(Inrush current occurs)

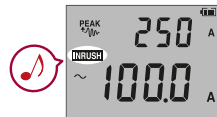

To exit AC Inrush mode

Hold down for 1 s.

**Trigger level**

±2 A peak (60.00 A range)  
±10 A peak (600.0 A range)  
±100 A peak (2000 A range)

## 2.5 Various Other Measurement Functions

### Voltage measurement

Example: Commercial power supply  
(AC voltage measurement)

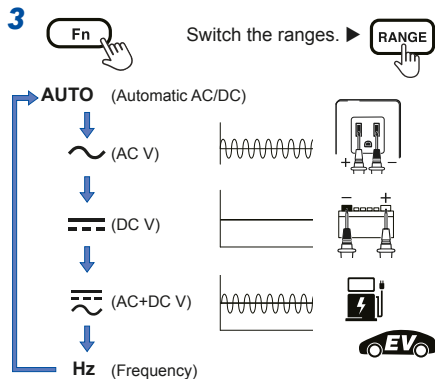
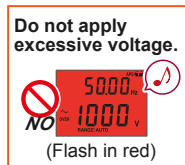
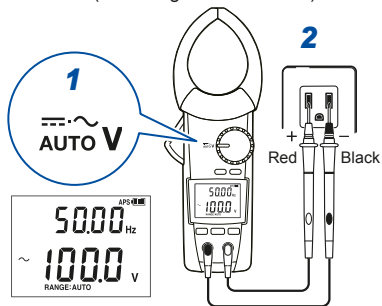

#### DC voltage polarity check (p.58)

If the measured value is negative, the buzzer will sound and the display will be backlit in red. (threshold: -10 V)

## Continuity check

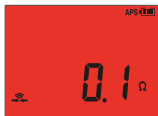
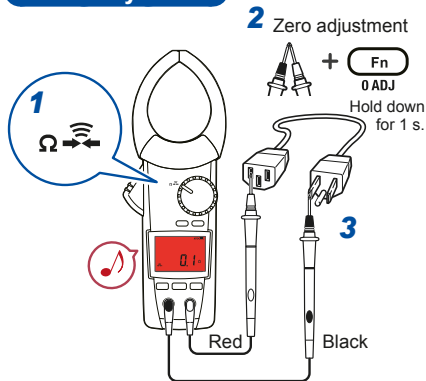

(Illuminate in red)

## Resistance measurement

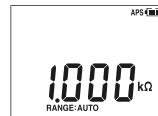
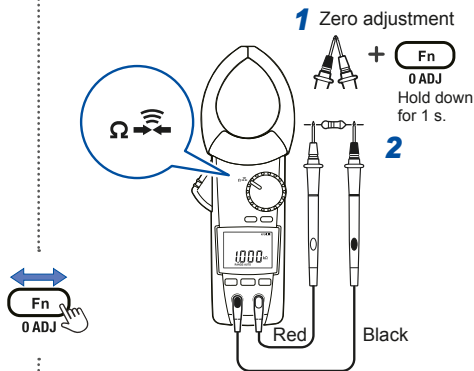

If resistance values of coils, including motors and transformers, measured with the auto-ranging fluctuate, select the range manually.

2

### Capacitance measurement

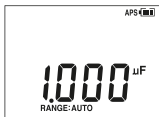
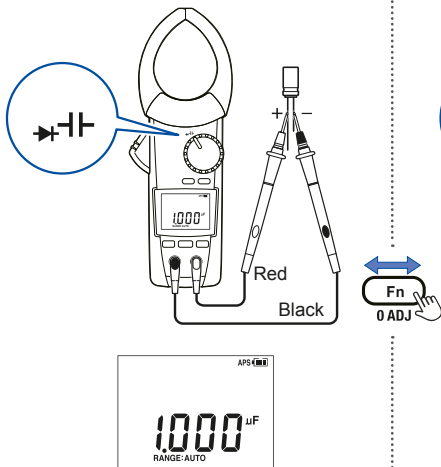

### Diode measurement

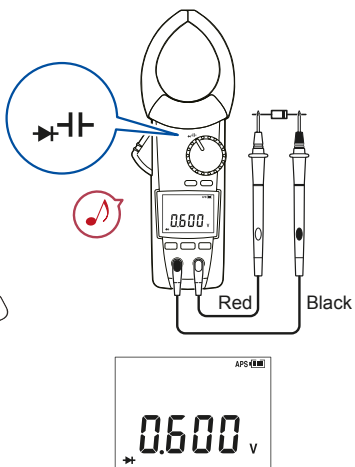

- Buzzer sound
- Intermittent sound: during forward connection (0.15 V to 1.8 V), backlight off
- Continuous sound: during forward connection (less than 0.15 V), red backlight on



**Temperature measurement**

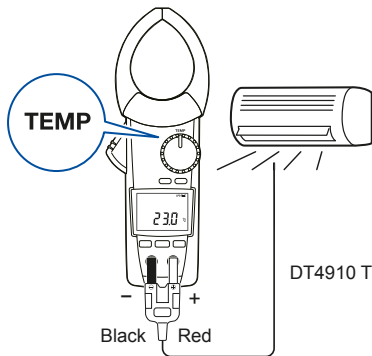

DT4910 Thermocouples (K)

**IMPORTANT**  
 Type K thermocouples exhibit a physical phenomenon known as short range ordering, which can cause inaccurate measurements in the range of 250°C to 600°C.



**OPEN** : The DT4910 is broken.

To switch the temperature units, see p.60.

## 2.6 LCD Backlight, Automatic Power Save (APS)

### LCD backlight

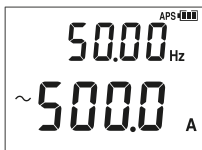

Backlight off



Backlight on  
Automatically shut off after 40 s  
of inactivity  
(Automatic shutoff is always  
enabled)

How to cancel: p.59

### Automatic power save

(Always on)

How to cancel: p.58

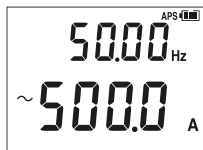

After 15 minutes  
of inactivity

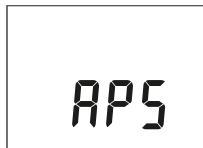

After 45 minutes  
of inactivity

The instrument is  
automatically turned off. ►

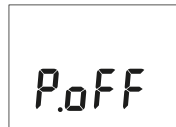

Set the rotary switch to the OFF position to restart.

## 2.7 DC High V Probe Mode

Use of the P2000 DC High Voltage Probe (optional) allows you to measure DC voltage of up to 2000 V (CATIII 2000 V, CAT IV 1000 V), such as open voltage of solar panels.

### WARNING

- **Do not use the P2000 to measure AC voltage.**



The probe cannot accurately measure AC voltage. Improper measurement could lead to electric shock. You can use the P2000 for DC voltage measurement only.

- **Do not measure voltage that exceeds 2000 V DC.**

Doing so could damage the instrument and the P2000, causing bodily injury.

- **Use the P2000 to measure voltage that exceeds 1000 V.**



Use of other probes could cause the operator to experience an electric shock.

### NOTICE

- **Connect the instrument and the P2000 together with the strap when using the L4943.**



The cables and plugs will be subjected to stress, damaging them.

## When using the L4943 Connection Cable Set\*

- 1** Disconnect the clip\* from the strap buckle\* as shown in the figure.



- 2** Attach the strap\* to the P2000.  
For details, see the P2000 Instructor manual.

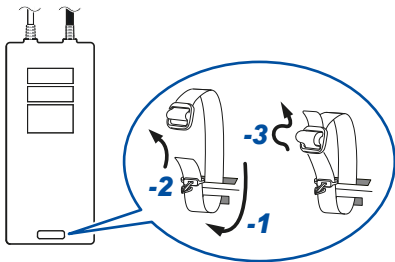

- 3** Attach the strap buckle to the instrument and connect it to the clip that you attached to the P2000 with the strap.

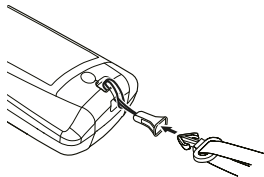

\*: Supplied with the P2000

### When using the L4930 Connection Cable Set or the L4931 Extension Cable Set (optional)

Hang the P2000 in some way, such as using a magnetic strap, not to subject the cables and the plugs to stress.

## Making Measurements

- 1** Rotate the rotary switch.



- 2** Hold down the two keys for 1 s as described below.



- ▶ DC High V Probe Mode on

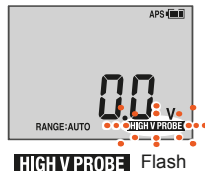

- 3** Connect the P2000 DC High Voltage Probe to the measurement terminals of the instrument.

- 4** Set the range.

- ▶ Switch the ranges.

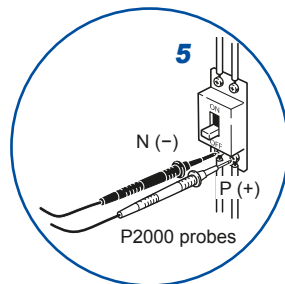
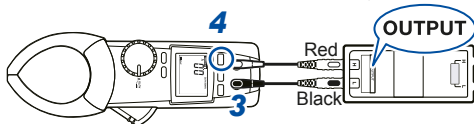

- 5** Bring the probes into contact with an object to be measured.

## DC High V Probe Mode

### **Saving the DC High V Probe mode settings**

Turn off the instrument, and then set the rotary switch to other than the OFF position while holding down the two operation keys as described below.



- The DC High V Probe mode start-up setting can be toggled between on and off.
- When the DC High V Probe mode start-up is enabled, the instrument will start in the mode you last used.

## 2.8 Wireless Communications Function (Z3210 required)

Installing the Z3210 Wireless Adapter (optional) is required.

Concurrent use of GENNECT Cross and HID function (p.54) is not available.

### Using GENNECT Cross

Enabling the wireless communications function allows you to check and record the measured data of the instrument, and create measurement reports using your mobile device. For details, see the operation guide for the GENNECT Cross app (free of charge).

GENNECT Cross special site

<https://gennect.net/en/cross/index>



- The communication distance is about 10 m with a clear line of sight. The communicable distance may vary greatly depending on the presence of an obstruction (wall or metallic shielding object) and the distance between the floor (ground) and instrument. To ensure the stable communication, make sure that the radio wave intensity is sufficient.
- GENNECT Cross is free of charge. However, the customer is responsible for the cost to download the application software and connect to the Internet when using the software.
- GENNECT Cross may not operate properly depending on the mobile device.
- The Z3210 uses the 2.4 GHz band wireless technology. When there is a device that uses the same frequency band such as a wireless LAN (IEEE 802.11.b/g/n) near your mobile device, the communication may not be established.

## Wireless Communications Function (Z3210 required)

When the instrument is placed on the floor or ground, the communication distance becomes shorter. It is recommended that you move the instrument away from the floor or ground and place it on a desk or table or hold it by hand.

### Using the wireless communications function

- 1** Connect the Z3210 Wireless Adapter (option) into the instrument. (p.22)
- 2** Install GENNECT Cross on your mobile device.
- 3** Turn on the instrument.
- 4** Enable the wireless communications function. (p.52)

When the instrument is turned on for the first time after the Z3210 has been installed, the wireless communications function will be enabled.



**5**

**Start GENNECT Cross and register the connection of the instrument.**

- When GENNECT Cross is started for the first time (when there is no registered instrument), the Instrument Settings screen appears.
- When the instrument is placed near your mobile device, its connection is registered automatically on the Instrument Settings screen of GENNECT Cross (up to eight instruments).
- Wait for 5 to 30 s until the connection of the instrument is registered after turning on the instrument. If the connection of the instrument is not registered after 1 minute has elapsed, restart GENNECT Cross and the instrument.

**6**

**Select a measurement function to perform measurement.**

**2**

Wireless Communications Function (Z3210 required)

## Toggleing the wireless communications function



Wireless communications  
function disabled

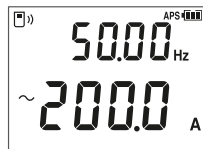

Wireless communications  
function enabled



Hold down  
for 1 s.

-  appears: Wireless communications function enabled
-  blinks: During wireless communications
- Off: Wireless communications function disabled

When the instrument is turned on for the first time after the Z3210 has been installed, the wireless communications function will be enabled.

## Event recording function

The event recording function logs the data when a measured value exceeds a desired threshold value, which can be set with GENNECT Cross. For details, see the operation guide for the GENNECT Cross app (free of charge). The number of recorded events can be checked using the instrument.



Hold down the two keys for 1 s as described above.



Event count display

- Up to 99 events can be recorded. If events has reached 99, the event recording will stops. When another event recording starts, previously recorded data will be deleted.
- Some events with a duration time of less than 400 ms may not be accurately measured, failing to detect them.\*

\*: Current frequency, voltage frequency, capacitance (400 ms to 4000 ms, depending on measured value), temperature (type K thermocouple) 2000 ms

Wireless Communications Function (Z3210 required)

## Z3210-to-Excel® direct data entry function (Excel® direct input function, HID function)

Concurrent use of GENNECT Cross and HID function is not available.

The human interface device (HID) profile, with which the Z3210 Wireless Adapter is equipped, is a profile same as that wireless keyboards use.

<b>HID ON</b>	Preparatory to data entry, open an Excel® file on your mobile device or computer and choose a cell. When the instrument's display freezes, the measured values will be entered on the cells. The use of this function with the automatic hold function enabled comes in handy. (p.33)
<b>HID OFF</b>	When you wish to use GENNECT Cross, disable the HID function.

The setting whether the HID function has been enabled or disabled will not be saved in the instrument but in the Z3210.

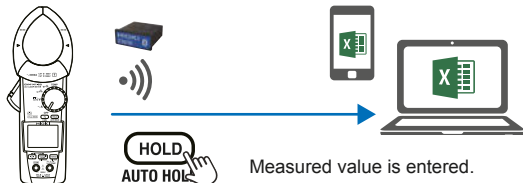

## Confirming the HID setting

- 1 Remove the test leads from the object under measurement.
- 2 Set the rotary switch to the OFF position.
- 3 Connect the Z3210 Wireless Adapter (option) into the instrument.

See “2.2 Installing Batteries and the Z3210 Wireless Adapter” (p.22).

- 4 Confirm the HID setting.

Make sure that the instrument is turned off, and then set the rotary switch to the TEMP position while holding down the **RANGE** key.

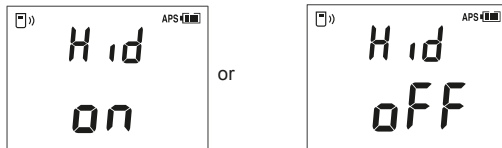
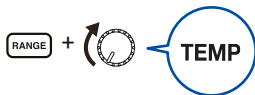

The settings stored in the Z3210 will be displayed.

### When [----] appears

Update the Z3210 firmware to the latest version using GENNECT Cross (version 1.8 or later).  
To change the HID settings, use the procedure on the following page.

To change the HID setting, use the procedure on the following page.

## Changing the HID setting

- 1 Turn off the instrument.**
- 2 Turn on the instrument while holding down the two keys as described below.**



After exhibiting the following displays, the instrument is automatically turned off.

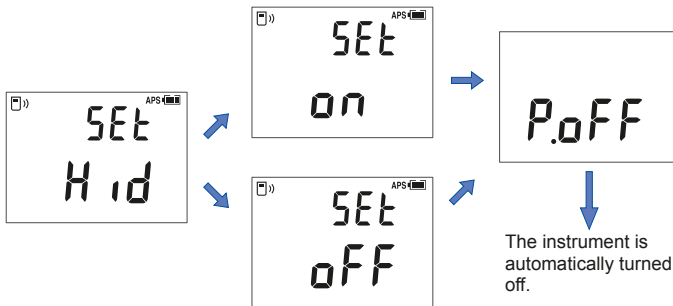

- 3 Turn on the instrument again.**  
The HID setting will be toggled.

**IMPORTANT**

**To switch over from the HID function to GENNECT Cross**

If you start GENNECT Cross without canceling the pairing between the mobile device and the instrument, GENNECT Cross may not be able to recognize the instrument as a connectible device. Follow the procedure below to reconnect the instrument to GENNECT Cross.

1. Use the **Bluetooth**<sup>®</sup> setting of your mobile device to delete the instrument.
2. Disable the Z3210's HID function. (p.56)
3. Use the Instrument Setting of GENNECT Cross to reconnect the instrument.

Check Hioki's website for the latest information.









<https://z3210.gennect.net>











Learn more here!

## 2.9 Rotary Switch Combinations



- +  Turn off the instrument, and then turn it on again while holding down one or two operation keys. (Set the rotary switch to other than the OFF position)

Setting	Reference page	Procedure	Factory-shipped setting	Saving of setting
Auto-power save (APS) function (off)	p.44	 +  Any position	On	Not saved (Every time required)
DC voltage polarity check (on/off)	p.40	 +  Any position	Off	Saved
LCD all segments display (Firmware version number, model number, serial number (only four digits), Confirming the HID setting (Z3210 required)* <sup>1</sup> )	p.21 p.55	 +  Any position	-	-
Buzzer (on/off)	-	 +  Any position	On	Saved

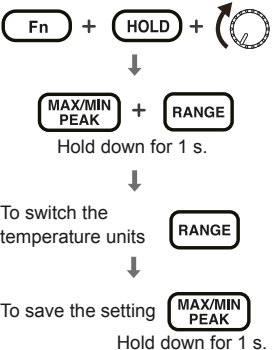

Setting	Reference page	Procedure	Factory-shipped setting	Saving of setting
Automatic backlight shutoff (on/ off)	p.44	 +  Any position	On	Saved
Saving the DC High V Probe mode settings (on/off)	p.45	 +  +  Any position	Off	Saved
Toggling the HID setting (on/off) (Z3210 required)	p.56	 +  +  Any position	-	_*2

## Rotary Switch Combinations

Setting	Reference page	Procedure	Factory-shipped setting	Saving of setting
Switching between the two temperature units: degrees Celsius and degrees Fahrenheit	p.43	 <p>           Fn + HOLD +             ↓            MAX/MIN PEAK + RANGE            Hold down for 1 s.            ↓            To switch the temperature units RANGE            ↓            To save the setting MAX/MIN PEAK            Hold down for 1 s.         </p>	Degrees Celsius	Saved

\*1: The screen display depends on the rotary switch position.

\*2: The setting whether the HID function has been enabled or disabled will be saved in the Z3210.

# 3

## Specifications

### 3.1 General Specifications

<b>Operating environment</b>	Indoor use, pollution degree 2, altitude up to 2000 m (6562 ft.)
<b>Operating temperature and humidity range</b>	-25°C to 65°C (-13°F to 149°F), 90% RH or less (no condensation)
<b>Storage temperature and humidity range</b>	-30°C to 70°C (-22°F to 158°F), 90% RH or less (no condensation, with batteries removed)

## General Specifications

<b>Dust resistance and water resistance</b>	<p>IP50 (when measuring resistance under completely dry conditions, current flowing through an insulated conductor under completely dry conditions, during storage)</p> <p>IP20 (when measuring voltage under completely dry conditions, current flowing through a hazardous live conductor under completely dry conditions)</p> <p>The protection rating for the enclosure of this instrument (defined in EN 60529) is IP50* or IP20*.</p> <p>*IP50, IP20:</p> <p>This indicates the degree of protection provided by the enclosure of the device for use in hazardous locations, entry of solid foreign objects, and the ingress of water.</p> <p>5: Protected against access to hazardous parts with wire measuring 1.0 mm in diameter. Dustproof type (The penetration of dust cannot be prevented completely, but quantities of dust that may hinder the stated operation of equipment or safety cannot penetrate the enclosure.)</p> <p>2: Protected against access to hazardous parts with fingers. The equipment inside the enclosure is protected against entry by solid foreign objects larger than 12.5 mm in diameter.</p> <p>0: The equipment inside the enclosure is not protected against the harmful effects of water.</p>
<b>Standards</b>	Safety    EN 61010 EMC        EN 61326
<b>Power supply</b>	LR03 Alkaline batteries ×2 Rated supply voltage: 1.5 V DC ×2

<b>Continuous operating time</b>	About 48 hours (without the Z3210) About 24 hours (with the Z3210 installed and wirelessly communicating) Other conditions: Measuring 100 AAC, with the LCD not backlighted, values for reference purposes at 23°C
<b>Dimensions</b>	Approx. 65W × 247H × 35D mm (2.56"W × 9.72"H × 1.38"D, The Jaw is not included in the dimensions of width and depth but in that of height.)
<b>Jaw dimensions</b>	Approx. 82Wj × 11Dj mm (3.23"W × 0.43"D, The depth dimension Dj is that of the first 44 mm of each jaw from its tip)
<b>Jaw cross-sectional minimum dimension</b>	Approx. 11 mm (0.43", indicates the depth for the first 44 mm of each jaw from its tip.)
<b>Maximum measurable conductor diameter</b>	φ55 mm
<b>Weight</b>	Approx. 300 g (10.6 oz., including batteries)
<b>Product warranty duration</b>	3 years or until the jaw open/close cycles reaches 30,000, whichever comes first
<b>Accessories</b>	p.7
<b>Options</b>	p.8

## 3.2 Input Specifications, Measurement Specifications

### (1) Basic specifications

<b>Measurable range</b>	See “3.3 Accuracy table” (p.72).	
<b>Maximum input voltage</b>	As per the frequency derating (p.65)	
<b>Maximum rated voltage</b>	Between terminals	1000 V AC (up to 1 kHz) 1000 V DC
	Line-to-earth	600 V AC (measurement category IV) 1000 V AC (measurement category III) Anticipated transient overvoltage: 8000 V
<b>Measurement method</b>	True RMS measurement	
<b>Measurement terminals</b>	COM terminal, V terminal	
<b>Coupling type</b>	AC current Current frequency AC Inrush AC voltage* <sup>1</sup> Voltage frequency	AC coupling
	Other measurement parameters	DC coupling

<b>Display refresh rate</b> <sup>*2</sup>	AC current Auto V AC voltage DC voltage AC+DC voltage	5 times/s
	Current frequency Voltage frequency Capacitance	0.5 to 5 times/s (Varies depending on the measured value)
	Temperature (Type K thermocouple)	1 time/s

\*1: Does not apply to AC detection in Auto V mode and to the AC component of AC+DC voltage mode.

\*2: Does not include range switching time.

## (2) Current measurement specifications

<b>Frequency derating</b>	3000 A AC or $6 \times 10^6$ A·Hz, whichever is lower (continuous, designed value)	
<b>Zero-display range</b>	AC current	5 counts or less

## Input Specifications, Measurement Specifications

<b>Crest factor</b>	AC current AC Inrush	60.00 A range 600.0 A range	3 (5000 counts or less) 2.5 (more than 5000 counts, 6000 counts or less)
		2000 A range	1.5 (2000 counts or less)
<b>Frequency detection input level</b>	AC current Current frequency	60.00 A range 600.0 A range	300 counts or more
		2000 A range	200 counts or more
<b>AC Inrush Trigger level</b>	AC Inrush	60.00 A range	Not less than $+2.0 A_{PEAK}$ or not more than $-2.0 A_{PEAK}$
		600.0 A range	Not less than $+10 A_{PEAK}$ or not more than $-10 A_{PEAK}$
		2000 A range	Not less than $+100 A_{PEAK}$ or not more than $-100 A_{PEAK}$
<b>Peak detection time width</b>	AC current AC Inrush	1 ms or more (with filter disabled)	

### (3) Voltage measurement specifications

<b>Overload protection</b>	1100 V DC 1100 V AC or $2 \times 10^7$ V·Hz, whichever is lower (Up to 1 minute of continuous application)
----------------------------	--



## Input Specifications, Measurement Specifications

<b>Input impedance</b>	See "3.3 Accuracy table" (p.72).		
<b>Zero-display range</b>	Auto V AC voltage AC+DC voltage	5 counts or less	
<b>Crest factor</b>	Auto V AC voltage AC+DC voltage	6.000 V range 60.00 V range 600.0 V range	3 (4000 counts or less) 2 (more than 4000 counts but 6000 counts or less)
		1000 V range	2 (750 counts or less) 1.5 (750 counts or more but 1000 counts or less)
<b>Frequency detection input level</b>	Auto V AC voltage	10% or more of each range's f.s.	
<b>CMRR<sup>*1</sup></b>	AC voltage AC+DC voltage	60 dB or more	
	DC voltage	100 dB or more	
<b>NMRR<sup>*2</sup></b>	DC voltage	60 dB or more	
<b>Peak detection time width</b>	AC voltage	1 ms or more (with filter disabled)	

\*1: Defined for 1 k $\Omega$  unbalance assuming that the input frequency is 0 Hz, 50 Hz, or 60 Hz

\*2: Defined assuming that the input frequency is 50 Hz or 60 Hz.

**(4) Other measurement parameters**

<b>Overload protection</b>	1000 V DC 1000 V AC or $2 \times 10^7$ V·Hz, whichever is lower (Up to 1 minute of continuous application)	
<b>Overload current</b>	At steady state: 30 mA or less At transient state: 1.5 A or less	
<b>Measurement current, charging current</b>	See “3.3 Accuracy table” (p.72).	
<b>Open terminal voltage</b>	DC 2.0 V or less	
<b>Continuity threshold</b>	Continuity check	$25 \Omega \pm 10 \Omega$ (continuous beep, LCD backlighted in red)
<b>Discontinuity threshold</b>	Continuity check	$250 \Omega \pm 10 \Omega$
<b>Stabilization time for reference junction compensation of instrument</b>	Temperature (Type K thermocouple)	Up to 120 minutes (Reference: when the instrument having a temperature of 23°C is left to stand in ambient environments of 65°C for 60 minutes)

**(5) DC High V Probe Mode (in combination with the P2000)\*<sup>1</sup>**

<b>Maximum rated line-to-ground voltage</b>	In conformity with the P2000's specifications
<b>Maximum rated voltage between terminals</b>	In conformity with the P2000's specifications
<b>Overload protection</b>	In conformity with the P2000's specifications
<b>Coupling type</b>	AC coupling
<b>Combinatorial measurement accuracy</b>	See "(8) DC high voltage (DC High V Probe mode)" (p.84) in "3.3 Accuracy Table."

\*1: The specifications above apply when both of the following two conditions are satisfied only: (1) the P2000 is connected, and (2) the instrument is in DC High V Probe mode.

## Input Specifications, Measurement Specifications

### (6) Accuracy specifications

<b>Accuracy guarantee conditions</b>	Accuracy guarantee duration	1 year (duration for which accuracy shown in the accuracy table is guaranteed) 3 year (duration for which 1.5 times accuracy shown in the accuracy table is guaranteed), value for reference purposes
	Accuracy guarantee duration after adjustment made by Hioki	1 year
	Accuracy guarantee temperature and humidity range	23°C ±5°C (73°F ±9°F), 90% RH or less (non-condensing)
	Accuracy guarantee of continuity check and resistance measurement assumes that zero adjustment has been performed. Temperature (Type K thermocouple) measurement requires use of the DT4910.	
<b>Input condition for accuracy table</b>	Sine wave input	
<b>Measurement accuracy</b>	See “3.3 Accuracy table” (p.72).	
<b>Temperature coefficient</b>	Add [(measurement accuracy × 0.1)/°C] to measurement accuracy (outside the temperature range of 23°C ±5°C).	

## Input Specifications, Measurement Specifications

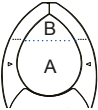
<b>Effects of conductor position*<sup>1</sup></b>	Cable diameter	Measurement area	Accuracy	Measurement area diagram
	8 mm <sup>2</sup> cross-linked polyethylene insulated vinyl sheath cable (Finished outer diameter: 8.6 mm)	Area A	Within $\pm 3.0\%$ rdg	
		Area B	Within $\pm 7.0\%$ rdg	
	8 mm <sup>2</sup> cross-linked polyethylene insulated vinyl sheath cable (Finished outer diameter: 13 mm)	Area A	Within $\pm 2.0\%$ rdg	
Area B		Within $\pm 5.0\%$ rdg		

**Effects of radiated radio-frequency electromagnetic field** Add  $\pm 2\%$  rdg at 10 V/m.

\*1: Defined assuming that 100 A current having a frequency of 55 Hz is measured, with respect to the jaw's center-point.

### 3.3 Accuracy table

#### (1) AC current

#### Measured value, maximum value, minimum value, average (rms)

Range (Automatic ranging threshold)	Accuracy guarantee range (resolution)	Accuracy guarantee frequency range	Measurement accuracy	
			Filter disabled	Filter enabled* <sup>1</sup>
60.00 A (more than 6000 counts)	1.00 A to 60.00 A (0.01 A)	45 Hz ≤ f ≤ 66 Hz	±1.5% rdg ±0.08 A	±2.0% rdg ±0.08 A
		30 Hz ≤ f < 45 Hz, 66 Hz < f < 1 kHz	±2.0% rdg ±0.10 A	±2.5% rdg ±0.10 A
600.0 A (more than 6000 counts, less than 540 counts)	1.0 A to 600.0 A (0.1 A)	45 Hz ≤ f ≤ 66 Hz	±1.5% rdg ±0.3 A	±2.0% rdg ±0.3 A
		30 Hz ≤ f < 45 Hz, 66 Hz < f < 1 kHz	±2.0% rdg ±0.5 A	±2.5% rdg ±0.5 A
2000 A (less than 540 counts)	10 A to 2000 A (1 A)	45 Hz ≤ f ≤ 66 Hz	±1.5% rdg ±3 A	±2.0% rdg ±3 A
		30 Hz ≤ f < 45 Hz, 66 Hz < f < 1 kHz* <sup>2</sup>	±2.0% rdg ±5 A	±2.5% rdg ±5 A

\*1: Accuracy not defined beyond 66 Hz.

\*2: Designed values apply beyond  $6 \times 10^5$  A·Hz.

**Peak max, peak min (zero-to-peak)**

Range	Accuracy guarantee range (resolution)	Accuracy guarantee frequency range	Measurement accuracy
60.00 A	$\pm 1.0$ A to $\pm 150.0$ A (0.1 A)	$45 \text{ Hz} \leq f \leq 66 \text{ Hz}$	$\pm 1.5\%$ rdg $\pm 0.8$ A
		$30 \text{ Hz} \leq f < 45 \text{ Hz}$ , $66 \text{ Hz} < f < 1 \text{ kHz}$	$\pm 2.0\%$ rdg $\pm 1.0$ A
600.0 A	$\pm 10$ A to $\pm 1500$ A (1 A)	$45 \text{ Hz} \leq f \leq 66 \text{ Hz}$	$\pm 1.5\%$ rdg $\pm 3$ A
		$30 \text{ Hz} \leq f < 45 \text{ Hz}$ , $66 \text{ Hz} < f < 1 \text{ kHz}$	$\pm 2.0\%$ rdg $\pm 5$ A
2000 A	$\pm 10$ A to $\pm 2840$ A (1 A)	$45 \text{ Hz} \leq f \leq 66 \text{ Hz}$	$\pm 1.5\%$ rdg $\pm 30$ A
		$30 \text{ Hz} \leq f < 45 \text{ Hz}$ , $66 \text{ Hz} < f < 1 \text{ kHz}$	$\pm 2.0\%$ rdg $\pm 50$ A

3

**(2) Current frequency**

Range (automatic ranging threshold)	Accuracy guarantee range (resolution)	Measurement accuracy
99.99 Hz (more than 9999 counts)	30.00 Hz to 99.99 Hz (0.01 Hz)	$\pm 0.1\%$ rdg $\pm 0.01$ Hz
999.9 Hz (less than 900 counts)	30.0 Hz to 999.9 Hz (0.1 Hz)	$\pm 0.1\%$ rdg $\pm 0.1 \text{ Hz}^{*1}$

\*1: Add  $\pm 0.2$  Hz if the frequency is less than 100.0 Hz.

Accuracy table

**(3) AC inrush (Inrush current)**

**Inrush current measured value (rms)\* 2**

Range	Accuracy guarantee range (resolution)	Accuracy guarantee frequency range	Measurement accuracy
60.00 A	3.00 A to 60.00 A (0.01 A)	40 Hz ≤ f ≤ 500 Hz	±5.0% rdg ±0.13 A
600.0 A	10.0 A to 600.0 A (0.1 A)	40 Hz ≤ f ≤ 500 Hz	±5.0% rdg ±1.3 A
2000 A	100 A to 2000 A (1 A)	40 Hz ≤ f ≤ 500 Hz* <sup>1</sup>	±5.0% rdg ±13 A

\*1: Designed values apply beyond  $6 \times 10^5$  A·Hz.



**AC inrush peak value (zero-to-peak)**

Range	Accuracy guarantee range (resolution)	Accuracy guarantee frequency range	Measurement accuracy
60.00 A	±3.0 A to ±150.0 A (0.1 A)	40 Hz ≤ f ≤ 500 Hz	±5.0% rdg ±1.0 A
600.0 A	±10 A to ±1500 A (1 A)	40 Hz ≤ f ≤ 500 Hz	±5.0% rdg ±10 A
2000 A	±100 A to ±2840 A (10 A)	40 Hz ≤ f ≤ 500 Hz	±5.0% rdg ±100 A

**(4) Auto V (AC/DC voltage automatic detection)**

When AC is detected: Conforms to the accuracy specifications described in “(7) AC+DC voltage” (p.81).

When DC is detected: Conforms to the accuracy specifications described in “(6) DC voltage” (p.79).

Accuracy table

(5) AC voltage

Measured value, maximum value, minimum value, average

Range (automatic ranging threshold)	Accuracy guarantee range (resolution)	Accuracy guarantee frequency range* <sup>1</sup> * <sup>2</sup>	Measurement accuracy		Input impedance* <sup>3</sup>
			Filter disabled	Filter enabled	
6.000 V (more than 6000 counts)	0.000 V to 0.299 V (0.001 V)	15 Hz ≤ f < 45 Hz	±1.5% rdg ±0.015 V	±2.0% rdg ±0.015 V	3.2 MΩ ±5%
		45 Hz ≤ f ≤ 66 Hz	±0.9% rdg ±0.013 V	±1.4% rdg ±0.013 V	
		66 Hz < f < 1 kHz	±1.5% rdg ±0.015 V	-	
	0.300 V to 6.000 V (0.001 V)	15 Hz ≤ f < 45 Hz	±1.5% rdg ±0.005 V	±2.0% rdg ±0.005 V	3.2 MΩ ±5%
		45 Hz ≤ f ≤ 66 Hz	±0.9% rdg ±0.003 V	±1.4% rdg ±0.003 V	
		66 Hz < f < 1 kHz	±1.5% rdg ±0.005 V	-	
60.00 V (more than 6000 counts, less than 540 counts)	3.00 V to 60.00 V (0.01 V)	15 Hz ≤ f < 45 Hz	±1.5% rdg ±0.05 V	±2.0% rdg ±0.05 V	3.1 MΩ ±5%
		45 Hz ≤ f ≤ 66 Hz	±0.9% rdg ±0.03 V	±1.4% rdg ±0.03 V	
		66 Hz < f < 1 kHz	±1.5% rdg ±0.05 V	-	

Range (automatic ranging threshold)	Accuracy guarantee range (resolution)	Accuracy guarantee frequency range* <sup>1</sup> * <sup>2</sup>	Measurement accuracy		Input impedance* <sup>3</sup>
			Filter disabled	Filter enabled	
600.0 V (more than 6000 counts, less than 540 counts)	30.0 V to 600.0 V (0.1 V)	15 Hz ≤ f < 45 Hz	±1.5% rdg ±0.5 V	±2.0% rdg ±0.5 V	3.0 MΩ ±5%
		45 Hz ≤ f ≤ 66 Hz	±0.9% rdg ±0.3 V	±1.4% rdg ±0.3 V	
		66 Hz < f < 1 kHz	±1.5% rdg ±0.5 V	–	
1000 V (less than 540 counts)	50 V to 1000 V (1 V)	15 Hz ≤ f < 45 Hz	±1.5% rdg ±5 V	±2.0% rdg ±5 V	3.0 MΩ ±5%
		45 Hz ≤ f ≤ 66 Hz	±0.9% rdg ±3 V	±1.4% rdg ±3 V	
		66 Hz < f < 1 kHz	±1.5% rdg ±5 V	–	

\*1: Accuracy within the frequency range of 15 Hz (inclusive) to 20 Hz (exclusive) is designed values.

\*2: Within the frequency range of less than 45 Hz, the accuracy guarantee assumes a superposed DC voltage of less than 500 V.

\*3: Defined assuming that the 50 Hz AC is input.

## Accuracy table

### Peak max, peak min

Range	Accuracy guarantee range (resolution)	Accuracy guarantee frequency range* <sup>1</sup> * <sup>2</sup>	Measurement accuracy
6.000 V	0 V to $\pm 12.00$ V (0.01 V)	15 Hz $\leq$ f < 45 Hz	$\pm 1.8\%$ rdg $\pm 0.07$ V
		45 Hz $\leq$ f $\leq$ 66 Hz	$\pm 1.5\%$ rdg $\pm 0.07$ V
		66 Hz < f < 1 kHz	$\pm 1.8\%$ rdg $\pm 0.07$ V
60.00 V	$\pm 3.0$ V to $\pm 120.0$ V (0.1 V)	15 Hz $\leq$ f < 45 Hz	$\pm 1.8\%$ rdg $\pm 0.7$ V
		45 Hz $\leq$ f $\leq$ 66 Hz	$\pm 1.5\%$ rdg $\pm 0.7$ V
		66 Hz < f < 1 kHz	$\pm 1.8\%$ rdg $\pm 0.7$ V
600.0 V	$\pm 30$ V to $\pm 1000$ V* <sup>3</sup> (1 V)	15 Hz $\leq$ f < 45 Hz	$\pm 1.8\%$ rdg $\pm 7$ V
		45 Hz $\leq$ f $\leq$ 66 Hz	$\pm 1.5\%$ rdg $\pm 7$ V
		66 Hz < f < 1 kHz	$\pm 1.8\%$ rdg $\pm 7$ V
1000 V	$\pm 50$ V to $\pm 1000$ V* <sup>4</sup> (1 V)	15 Hz $\leq$ f < 45 Hz	$\pm 1.8\%$ rdg $\pm 7$ V
		45 Hz $\leq$ f $\leq$ 66 Hz	$\pm 1.5\%$ rdg $\pm 7$ V
		66 Hz < f < 1 kHz	$\pm 1.8\%$ rdg $\pm 7$ V

\*1: Accuracy within the frequency range of 15 Hz (inclusive) to 20 Hz (exclusive) is designed values.

\*2: Within the frequency range of less than 45 Hz, the accuracy guarantee assumes a superposed DC voltage of less than 500 V.

\*3: Values of up to  $\pm 1200$  V are displayed, but accuracy is not defined for display values in excess of 1000 V (values for reference purposes).

\*4: Values of up to  $\pm 1500$  V are displayed, but accuracy is not defined for display values in excess of 1000 V (values for reference purposes).

**(6) DC voltage****Measured value, maximum value, minimum value, average**

Range (automatic ranging threshold)	Accuracy guarantee range (resolution)	Measurement accuracy	Input impedance <sup>*1</sup>
600.0 mV (more than 6000 counts)	0.0 mV to $\pm 600.0$ mV (0.1 mV)	$\pm 0.5\%$ rdg $\pm 0.5$ mV	6.7 M $\Omega$ $\pm 5\%$
6.000 V (more than 6000 counts, less than 540 counts)	0.000 V to $\pm 6.000$ V (0.001 V)	$\pm 0.5\%$ rdg $\pm 0.003$ V	6.7 M $\Omega$ $\pm 5\%$
60.00 V (more than 6000 counts, less than 540 counts)	0.00 V to $\pm 60.00$ V (0.01 V)	$\pm 0.5\%$ rdg $\pm 0.03$ V	6.1 M $\Omega$ $\pm 5\%$
600.0 V (more than 6000 counts, less than 540 counts)	0.0 V to $\pm 600.0$ V (0.1 V)	$\pm 0.5\%$ rdg $\pm 0.3$ V	6.0 M $\Omega$ $\pm 5\%$
1000 V (less than 540 counts)	$\pm 0$ V to $\pm 1000$ V (1 V)	$\pm 0.5\%$ rdg $\pm 3$ V	6.0 M $\Omega$ $\pm 5\%$

\*1: Assumes DC input.

Accuracy table

**PEAK MAX, PEAK MIN**

Range	Accuracy guarantee range (resolution)	Measurement accuracy
600.0 mV	0 mV to $\pm 1200$ mV (1 mV)	$\pm 1.0\%$ rdg $\pm 7$ mV
6.000 V	0.00 V to $\pm 12.00$ V (0.01 V)	$\pm 1.0\%$ rdg $\pm 0.07$ V
60.00 V	0.0 V to $\pm 120.0$ V (0.1 V)	$\pm 1.0\%$ rdg $\pm 0.7$ V
600.0 V	0 V to $\pm 1000$ V (1 V)	$\pm 1.0\%$ rdg $\pm 7$ V
1000 V	0 V to $\pm 1000$ V (1 V)	$\pm 1.0\%$ rdg $\pm 7$ V

## (7) AC+DC voltage

## Measured value, MAX, MIN, AVE

Range (Automatic ranging threshold)	Accuracy guarantee range (resolution)	Accuracy guarantee frequency range*1	Measurement accuracy		Input impedance*2
			Filter disabled	Filter enabled	
6.000 V (more than 6000 counts)	0.000 V to 0.299 V (0.001 V)	10 Hz ≤ f < 45 Hz	±1.5% rdg ±0.023 V	±2.0% rdg ±0.023 V	DC: 6.7 MΩ ±5% AC: 3.2 MΩ ±5%
		DC, 45 Hz ≤ f ≤ 66 Hz	±1.0% rdg ±0.023 V	±1.5% rdg ±0.023 V	
		66 Hz < f < 1 kHz	±1.5% rdg ±0.023 V	–	
	0.300 V to 6.000 V (0.001 V)	10 Hz ≤ f < 45 Hz	±1.5% rdg ±0.013 V	±2.0% rdg ±0.013 V	DC: 6.7 MΩ ±5% AC: 3.2 MΩ ±5%
		DC, 45 Hz ≤ f ≤ 66 Hz	±1.0% rdg ±0.013 V	±1.5% rdg ±0.013 V	
		66 Hz < f < 1 kHz	±1.5% rdg ±0.013 V	–	
60.00 V (more than 6000 counts, less than 540 counts)	3.00 V to 60.00 V (0.01 V)	10 Hz ≤ f < 45 Hz	±1.5% rdg ±0.13 V	±2.0% rdg ±0.13 V	DC: 6.1 MΩ ±5% AC: 3.1 MΩ ±5%
		DC, 45 Hz ≤ f ≤ 66 Hz	±1.0% rdg ±0.13 V	±1.5% rdg ±0.13 V	
		66 Hz < f < 1 kHz	±1.5% rdg ±0.13 V	–	

## Accuracy table

Range (Automatic ranging threshold)	Accuracy guarantee range (resolution)	Accuracy guarantee frequency range* <sup>1</sup>	Measurement accuracy		Input impedance* <sup>2</sup>
			Filter disabled	Filter enabled	
600.0 V (more than 6000 counts, less than 540 counts)	30.0 V to 600.0 V (0.1 V)	10 Hz ≤ f < 45 Hz	±1.5% rdg ±0.7 V	±2.0% rdg ±0.7 V	DC: 6.0 MΩ ±5% AC: 3.0 MΩ ±5%
		DC, 45 Hz ≤ f ≤ 66 Hz	±1.0% rdg ±0.7 V	±1.5% rdg ±0.7 V	
		66 Hz < f < 1 kHz	±1.5% rdg ±0.7 V	–	
1000 V (less than 540 counts)	50 V to 1000 V (1 V)	10 Hz ≤ f < 45 Hz	±1.5% rdg ±7 V	±2.0% rdg ±7 V	DC: 6.0 MΩ ±5% AC: 3.0 MΩ ±5%
		DC, 45 Hz ≤ f ≤ 66 Hz	±1.0% rdg ±7 V	±1.5% rdg ±7 V	
		66 Hz < f < 1 kHz	±1.5% rdg ±7 V	–	

\*1: Accuracy within the frequency range of 10 Hz (inclusive) to 20 Hz (exclusive) is designed values.

\*2: Defined assuming that the DC or 50 Hz AC is input.



## Peak max, peak min

Range	Accuracy guarantee range (resolution)	Accuracy guarantee frequency range* <sup>1</sup>	Measurement accuracy
6.000 V	0.00 V to $\pm 12.00$ V (0.01 V)	10 Hz $\leq f < 45$ Hz	$\pm 1.5\%$ rdg $\pm 0.07$ V
		DC, 45 Hz $\leq f \leq 66$ Hz	$\pm 1.0\%$ rdg $\pm 0.07$ V
		66 Hz $< f < 1$ kHz	$\pm 1.5\%$ rdg $\pm 0.07$ V
60.00 V	$\pm 3.0$ V to $\pm 120.0$ V (0.1 V)	10 Hz $\leq f < 45$ Hz	$\pm 1.5\%$ rdg $\pm 0.7$ V
		DC, 45 Hz $\leq f \leq 66$ Hz	$\pm 1.0\%$ rdg $\pm 0.7$ V
		66 Hz $< f < 1$ kHz	$\pm 1.5\%$ rdg $\pm 0.7$ V
600.0 V	$\pm 30$ V to $\pm 1000$ V* <sup>2</sup> (1 V)	10 Hz $\leq f < 45$ Hz	$\pm 1.5\%$ rdg $\pm 7$ V
		DC, 45 Hz $\leq f \leq 66$ Hz	$\pm 1.0\%$ rdg $\pm 7$ V
		66 Hz $< f < 1$ kHz	$\pm 1.5\%$ rdg $\pm 7$ V
1000 V	$\pm 50$ V to $\pm 1000$ V* <sup>3</sup> (1 V)	10 Hz $\leq f < 45$ Hz	$\pm 1.5\%$ rdg $\pm 7$ V
		DC, 45 Hz $\leq f \leq 66$ Hz	$\pm 1.0\%$ rdg $\pm 7$ V
		66 Hz $< f < 1$ kHz	$\pm 1.5\%$ rdg $\pm 7$ V

\*1: Accuracy within the frequency range of 10 Hz (inclusive) to 20 Hz (exclusive) is designed values.

\*2: Values of up to  $\pm 1200$  V are displayed, but accuracy is not defined for display values in excess of 1000 V (values for reference purposes).

\*3: Values of up to  $\pm 1500$  V are displayed, but accuracy is not defined for display values in excess of 1000 V (values for reference purposes).

Accuracy table

**(8) DC high voltage (DC High V Probe mode)**

**Measured value, maximum value, minimum value, average**

Range (Automatic ranging threshold)	Accuracy guarantee range (resolution)	Measurement accuracy (in combination with the P2000)	Input impedance (in combination with the P2000)
600 V (more than 6000 counts)	80.0 V to $\pm 600.0$ V (0.1 V)	$\pm 1.0\%$ rdg $\pm 0.3$ V	19.3 M $\Omega$ $\pm 2\%$
2000 V (less than 540 counts)	80.0 V to $\pm 2000$ V (1 V)	$\pm 1.0\%$ rdg $\pm 3$ V	19.3 M $\Omega$ $\pm 2\%$

**(9) Voltage frequency**

Range (Automatic ranging threshold)	Accuracy guarantee range (resolution)	Measurement accuracy
9.999 Hz (more than 9999 counts)	1.000 Hz to 9.999 Hz (0.001 Hz)	$\pm 0.1\%$ rdg $\pm 0.003$ Hz
60.00 V (more than 9999 counts, less than 900 counts)	1.00 Hz to 99.99 Hz (0.01 Hz)	$\pm 0.1\%$ rdg $\pm 0.01$ Hz
999.9 Hz (less than 900 counts)	1.0 Hz to 999.9 Hz (0.1 Hz)	$\pm 0.1\%$ rdg $\pm 0.1$ Hz <sup>*1</sup>

\*1: Add  $\pm 0.2$  Hz if the frequency is less than 100.0 Hz.

**(10) Continuity check**

Range	Accuracy guarantee range (resolution)	Measurement current	Measurement accuracy
600.0 $\Omega$	0.0 $\Omega$ to 600.0 $\Omega$ (0.1 $\Omega$ )	200 $\mu\text{A}$ $\pm 20\%$	$\pm 0.7\%$ rdg $\pm 0.5$ $\Omega$

**(11) Resistance**

Range (automatic ranging threshold)	Accuracy guarantee range (resolution)	Measurement current	Measurement accuracy
600.0 $\Omega$ (more than 6000 counts)	0.0 $\Omega$ to 600.0 $\Omega$ (0.1 $\Omega$ )	200 $\mu\text{A}$ $\pm 20\%$	$\pm 0.7\%$ rdg $\pm 0.5$ $\Omega$
6.000 k $\Omega$ (more than 6000 counts, less than 540 counts)	0.000 k $\Omega$ to 6.000 k $\Omega$ (0.001 k $\Omega$ )	100 $\mu\text{A}$ $\pm 20\%$	$\pm 0.7\%$ rdg $\pm 0.005$ k $\Omega$
60.00 k $\Omega$ (more than 6000 counts, less than 540 counts)	0.00 k $\Omega$ to 60.00 k $\Omega$ (0.01 k $\Omega$ )	10 $\mu\text{A}$ $\pm 20\%$	$\pm 0.7\%$ rdg $\pm 0.05$ k $\Omega$
600.0 k $\Omega$ (more than 6000 counts, less than 540 counts)	0.0 k $\Omega$ to 600.0 k $\Omega$ (0.1 k $\Omega$ )	1 $\mu\text{A}$ $\pm 20\%$	$\pm 0.7\%$ rdg $\pm 0.5$ k $\Omega$
6.000 M $\Omega$ (less than 540 counts)	0.000 M $\Omega$ to 6.000 M $\Omega$ (0.001 M $\Omega$ )	100 nA $\pm 20\%$	$\pm 1.0\%$ rdg 0.005 M $\Omega$

## Accuracy table

### (12) Diode

Range	Accuracy guarantee range (resolution)	Short-circuit current	Measurement accuracy
1.800 V	0.000 V to 1.800 V* <sup>1</sup> (0.001 V)	200 $\mu$ A $\pm$ 20%	$\pm$ 0.7% rdg $\pm$ 0.005 V

\*1: A series of beeps indicates forward connection (0.15 V to 1.8 V). A continuous beep is emitted and the LCD is backlighted in red if the voltage is less than 0.15 V.

### (13) Capacitance

Range (automatic ranging threshold)	Accuracy guarantee range (resolution)	Charging current	Measurement accuracy
1.000 $\mu$ F (more than 1100 counts)	0.000 $\mu$ F to 1.100 $\mu$ F (0.001 $\mu$ F)	10 nA $\pm$ 20% 100 nA $\pm$ 20% 1 $\mu$ A $\pm$ 20%	$\pm$ 1.9% rdg $\pm$ 0.005 $\mu$ F
10.00 $\mu$ F (more than 1100 counts, less than 100 counts)	0.00 $\mu$ F to 11.00 $\mu$ F (0.01 $\mu$ F)	100 nA $\pm$ 20% 1 $\mu$ A $\pm$ 20% 10 $\mu$ A $\pm$ 20%	$\pm$ 1.9% rdg $\pm$ 0.05 $\mu$ F
100.0 $\mu$ F (more than 1100 counts, less than 100 counts)	0.0 $\mu$ F to 110.0 $\mu$ F (0.1 $\mu$ F)	1 $\mu$ A $\pm$ 20% 10 $\mu$ A $\pm$ 20% 100 $\mu$ A $\pm$ 20%	$\pm$ 1.9% rdg $\pm$ 0.5 $\mu$ F
1000 $\mu$ F (less than 100 counts)	0 $\mu$ F to 1100 $\mu$ F (1 $\mu$ F)	10 $\mu$ A $\pm$ 20% 100 $\mu$ A $\pm$ 20% 200 $\mu$ A $\pm$ 20%	$\pm$ 1.9% rdg $\pm$ 5 $\mu$ F

**(14) Temperature (Type K thermocouple)**

Thermocouple type	Range	Accuracy guarantee range (resolution)	Measurement accuracy* <sup>1</sup>
K	°C	-40.0°C to 400.0°C (0.1°C)	±0.5% rdg ±3.0°C
K	°F* <sup>2</sup>	-40.0°F to 752.0°F (0.1°F)	±0.5% rdg ±5.4°F

\*1: Prescribed conditions (assuming that an ambient temperature where the instrument is left to stand stabilizes in the range of ±1°C)

\*2: The temperature unit can be switched over to Fahrenheit by a special operation on the instrument.

Accuracy table

## 4

## Maintenance and Service

## 4.1 Troubleshooting

Problem	Cause	Remedy
The instrument is indicating an abnormal measured value.	The measured value is lower than the lower limit value of the measuring range.	Wrap the wire around the jaw one or more times. Wrapping the wire $n$ times can increase the displayed value by $(n + 1)$ times.
	The tips of the jaw open.	Close the jaw tips.
	The jaw is damaged.	The instrument with its jaw damaged cannot measure current accurately. Have the instrument repaired.
	Displayed values can frequently fluctuate due to induction potential even with no input. This, however, is not a malfunction.	

## Troubleshooting

Problem	Cause	Remedy
<p><b>Measured value differ from those of another clamp-on current.</b></p>	<p>Measured waveforms contain a component that falls outside the frequency characteristics range.</p>	<p>Measured waveforms contain a component that falls outside the frequency characteristics. If the jaw is damaged or cracked, it will not be able to measure current accurately.</p>
	<p>The instrument, which uses the true RMS method, can accurately measure distorted waveforms. When measuring a distorted waveform, the measured value will differ from a clamp-on current meter that uses the averaging method.</p>	
<p><b>The current value is larger than expected.</b> <b>A current value is displayed even with no input.</b></p>	<p>There is a transformer or high-current circuit that emits a strong magnetic field near the instrument. Otherwise, there is a wireless device that emits a strong electric field.</p>	<p>Perform measurement keeping the instrument away from such equipment.</p>
<p>The instrument's jaw emits sound (vibration).</p>	<p>Greater than or equal to 500 A of AC current is being measured.</p>	<p>The jaw may emit sound (vibration); however, there is no effect on the measurement.</p>
<p>The measured value does not appear.</p>	<p>The test leads have a break.</p>	<p>Check the continuity of the test leads. (p.41) If a break is found, replace the test leads.</p>



<b>Problem</b>	<b>Cause</b>	<b>Remedy</b>
No measured value is displayed even when the test lead tips are	The test leads are not inserted all the way.	Insert the test leads all the way.
Zero adjustment is impossible.	Zero adjustment was performed leaving the instrument clamped around a measurement target.	If you wish to measure current, remove the instrument from a measurement target to perform zero adjustment.

If problems cannot be resolved even after you have implemented such remedies, have the instrument repaired.

## 4.2 Error and Operation Display

Error display	Description	Remedy
v.up	The instrument's firmware is being upgraded.	Do not remove the batteries until the upgrade completes.
Err 001	ROM error Program	When the error appears on the display, it is necessary to repair the instrument. Please contact your authorized Hioki distributor or reseller.
Err 002	ROM error Adjustment data	
Err 004	Memory error	
Err 005	ADC error Hardware malfunction	
Err 008	Z3210 communication error The Z3210 is malfunctioning or is not properly connected	<p>Perform the following steps. (p.25)</p> <ul style="list-style-type: none"> <li>• Disconnect and then reconnect the Z3210.</li> <li>• If you have another Z3210, replace the unit in question with that one.</li> </ul> <p>If the error continues to be displayed, the instrument needs to be repaired. Please contact your authorized Hioki distributor or reseller.</p>

## 4.3 Cleaning

### NOTICE



- **If the instrument becomes dirty, wipe the instrument clean with a soft cloth moistened with water or a neutral detergent.**

Never use solvents such as benzene, alcohol, acetone, ether, ketone, thinners or gasoline. Doing so could deform and discolor the instrument.

#### IMPORTANT

**Keep the the facing core surfaces of the jaws clean by gently wiping them with a soft dry cloth.**

Dirt on the facing core surfaces of the jaws can adversely affect the measurement accuracy.

4

Wipe the LCD gently with a soft, dry cloth.

Cleaning

# Index

## A

---

AC+DC voltage.....	81
AC current .....	35, 72
AC Inrush.....	39
AC voltage.....	35, 76
Automatic hold.....	33, 34
Automatic power save .....	44
Auto V.....	19, 35, 75
Average value.....	37

## B

---

Backlight.....	24, 44, 59
Buzzer .....	24, 40, 58

## C

---

Continuity check .....	35, 41, 85, 90
Current.....	32, 65

## D

---

DC High V Probe Mode.....	45
DC voltage.....	79
Diode .....	35, 42, 86
DT4910 Thermocouples (K) .....	9, 43

## E

---

Error display .....	92
Event recording function.....	53
Excel® direct entry function.....	54

## F

---

Filter.....	38
Flashing red backlight.....	40
Fluctuation .....	89
Frequency.....	32, 40, 73

## G

---

GENNECT Cross.....	49
--------------------	----

## Index

### H

---

HID ..... 54

### I

---

Inrush current ..... 39, 74

### J

---

Jaws ..... 15, 20

### L

---

L9300..... 30

### M

---

Manual hold ..... 33

Maximum value ..... 37

Measurement function ..... 19, 35, 40

Minimum value ..... 37

### N

---

Noise ..... 38

### P

---

Peak value ..... 37

Polarity check ..... 40, 58

### R

---

Range ..... 36

Red backlight..... 41

Resistance..... 35, 41, 85

Rotary switch combinations..... 58

### S

---

Serial number ..... 20

### T

---

Temperature ..... 43, 87

Test leads ..... 7, 8, 28, 91

### V

---

Voltage..... 40, 66

**W**

---

Wire break .....	21, 43
Wireless Adapter .....	22, 49
Wireless communications.....	49

**Z**

---

Z3210 .....	22, 49
Zero adjustment.....	41, 91





## Warranty Certificate

# HIOKI

Model	Serial number	Warranty period Three (3) years from date of purchase ( ___ / ___ / ___ )
-------	---------------	--

Customer name: \_\_\_\_\_  
Customer address: \_\_\_\_\_

### Important

- Please retain this warranty certificate. Duplicates cannot be reissued.
- Complete the certificate with the model number, serial number, and date of purchase, along with your name and address. The personal information you provide on this form will only be used to provide repair service and information about Hiko products and services.

This document certifies that the product has been inspected and verified to conform to Hiko's standards. Please contact the place of purchase in the event of a malfunction and provide this document, in which case Hiko will repair or replace the product subject to the warranty terms described below.

### Warranty terms

1. The product is guaranteed to operate properly during the warranty period (three [3] years from the date of purchase). If the date of purchase is unknown, the warranty period is defined as three (3) years from the date (month and year) of manufacture (as indicated by the first four digits of the serial number in YYYYMM format).
2. If the product came with an AC adapter, the adapter is warranted for one (1) year from the date of purchase.
3. The accuracy of measured values and other data generated by the product is guaranteed as described in the product specifications.
4. In the event that the product or AC adapter malfunctions during its respective warranty period due to a defect of workmanship or materials, Hiko will repair or replace the product or AC adapter free of charge.
5. The following malfunctions and issues are not covered by the warranty and as such are not subject to free repair or replacement:
  - 1. Malfunctions or damage of consumables, parts with a defined service life, etc.
  - 2. Malfunctions or damage of connectors, cables, etc.
  - 3. Malfunctions or damage caused by shipment, dropping, relocation, etc., after purchase of the product
  - 4. Malfunctions or damage caused by inappropriate handling that violates information found in the instruction manual or on precautionary labeling on the product itself
  - 5. Malfunctions or damage caused by a failure to perform maintenance or inspections as required by law or recommended in the instruction manual
  - 6. Malfunctions or damage caused by fire, storms or flooding, earthquakes, lightning, power anomalies (involving voltage, frequency, etc.), war or unrest, contamination with radiation, or other acts of God
  - 7. Damage that is limited to the product's appearance (cosmetic blemishes, deformation of enclosure shape, fading of color, etc.)
  - 8. Other malfunctions or damage for which Hiko is not responsible
6. The warranty will be considered invalidated in the following circumstances, in which case Hiko will be unable to perform service such as repair or calibration:
  - 1. If the product has been repaired or modified by a company, entity, or individual other than Hiko
  - 2. If the product has been embedded in another piece of equipment for use in a special application (aerospace, nuclear power, medical use, vehicle control, etc.) without Hiko's having received prior notice
7. If you experience a loss caused by use of the product and Hiko determines that it is responsible for the underlying issue, Hiko will provide compensation in an amount not to exceed the purchase price, with the following exceptions:
  - 1. Secondary damage arising from damage to a measured device or component that was caused by use of the product
  - 2. Damage arising from measurement results provided by the product
  - 3. Damage to a device other than the product that was sustained when connecting the device to the product (including via network connections)
8. Hiko reserves the right to decline to perform repair, calibration, or other service for products for which a certain amount of time has passed since their manufacture, products whose parts have been discontinued, and products that cannot be repaired due to unforeseen circumstances.

**HIOKI E.E. CORPORATION**

<http://www.hioki.com>

18-07 EN-3





