

# a3004 FC

## Wireless DC Clamp

Quick Reference Guide

99 Washington Street  
Melrose, MA 02176

800.517.8431

TestEquipmentDepot.com

**Warning**

To prevent possible electrical shock, fire, or personal injury, read the "a3004 FC Safety Sheet" before you use this Product.

**mAmps**

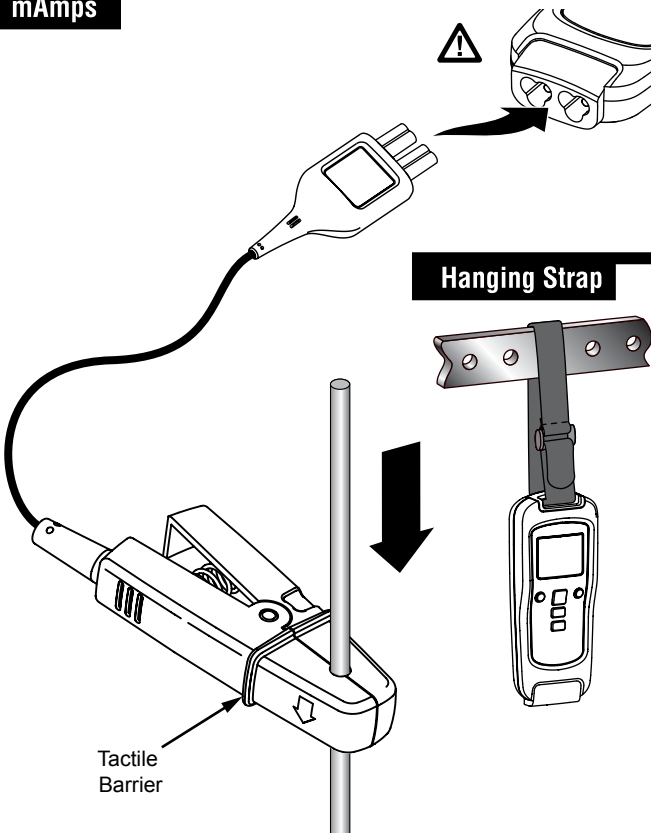

**On / Off**

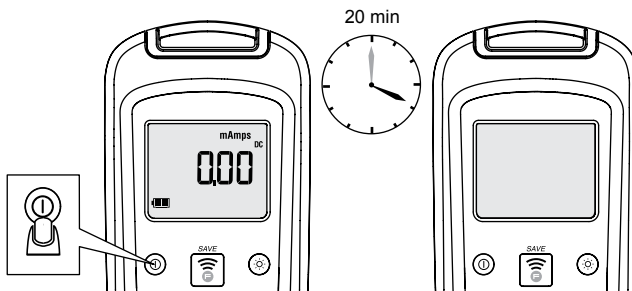

1 <b>OFF</b>	2 LOG + 1 1 2	3 LOG x2
4 <b>PoFF</b>	5 	6 mAmps DC 2.30 ∞

**Backlight**

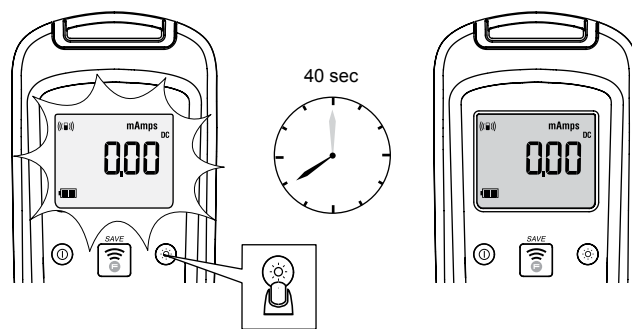

1 <b>OFF</b>	2 LOG + 1 1 2	3 LOG x3	4 <b>LoFF</b>
5 	6 mAmps DC 2.88	7 	8 mAmps DC 2.88 ∞

**DCM (3000 FC Optional)**

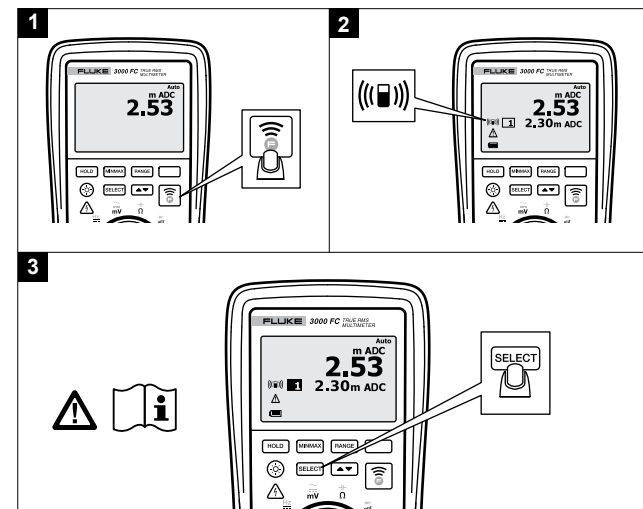

**ZERO**

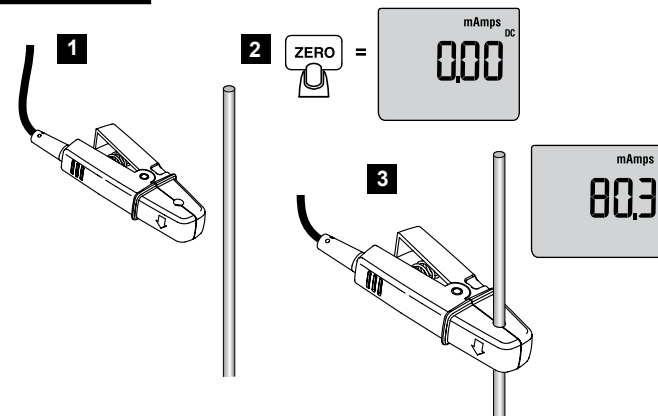

**Battery**

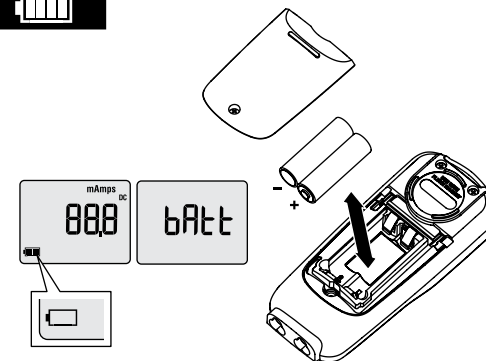

LOG

iOS/Android

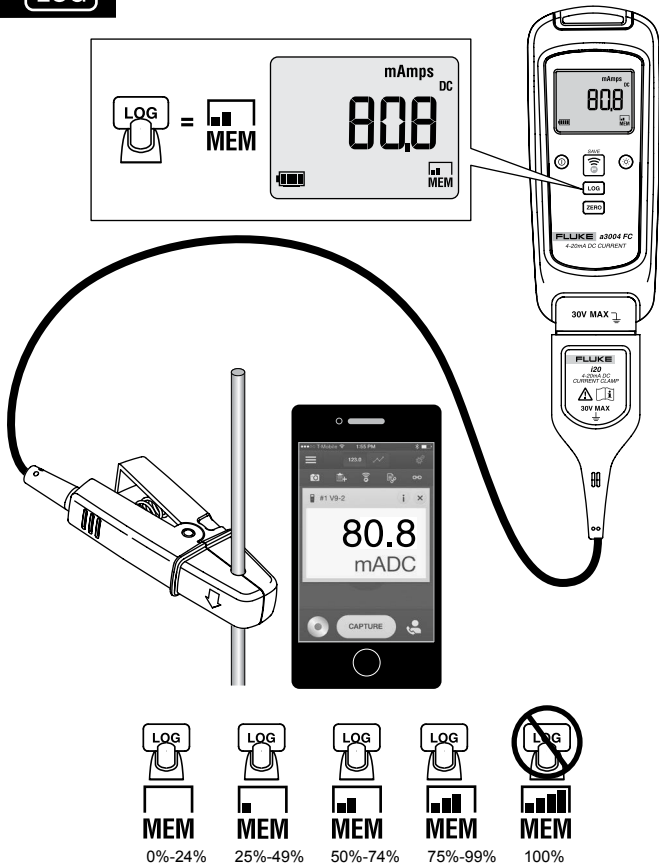

### Fluke Connect™ Bluetooth® Connection to FC Tools

