

AD-1690

Leak Tester

INSTRUCTION MANUAL



5 Commonwealth Ave
Woburn, MA 01801
Phone 781-665-1400
Toll Free 1-800-517-8431

 Visit us at www.TestEquipmentDepot.com



© 2009 A&D Company Ltd. All rights reserved.

No part of this publication may be reproduced, transmitted, transcribed, or translated into any language in any form by any means without the written permission of A&D Company Ltd.

The contents of this manual and the specifications of the instrument covered by this manual are subject to change for improvement without notice.

CONTENTS

1. INTRODUCTION	2
1.1. Compliance	2
2. FEATURES	3
3. PART NAMES • CONSTITUTION	4
3.1. Main unit.....	4
3.2. Accessories	4
4. CONFIRMING BEFORE USE	5
5. MEASUREMENT PREPARATION	7
6. KEY OPERATION	8
7. MEASUREMENT	9
8. CHANGING THE JUDGMENT CONDITION	11
9. FUNCTION	14
10. MAINTENANCE AND NOTES	17
11. RS-232C INTERFACE	21
12. SPECIFICATIONS	22
12.1. Optional accessories and Sold separately	23
12.2. Dimensions	23

1. INTRODUCTION

This manual describes how the AD-1690 Leak Tester works and how to get the most out of it in terms of performance.

Read this manual thoroughly before using the Leak Tester and keep it at hand for future reference.

1.1. Compliance

Compliance with FCC Rules

Please note that this equipment generates, uses and can radiate radio frequency energy. This equipment has been tested and has been found to comply with the limits of a Class A computing device pursuant to Subpart J of Part 15 of FCC rules. These rules are designed to provide reasonable protection against interference when the equipment is operated in a commercial environment. If this unit is operated in a residential area, it may cause some interference and under these circumstances the user would be required to take, at his own expense, whatever measures are necessary to eliminate the interference.

(FCC = Federal Communications Commission in the U.S.A.)

Compliance with EMC Directives

 This device features radio interference suppression in compliance with valid EC Regulation 2004/108/EEC.



A&D INSTRUMENTS

A&D Instruments Ltd
23 Woodlands Way
Widdowson Business Park
Abingdon, Oxfordshire
OX13 1DY United Kingdom
Tel: +44(0)1235 560400
Fax: +44(0)1235 560406
Email: info@aandl.co.uk
Internet: <http://www.aandl.co.uk>
eMail No: 030 526 1770 95

CE

A & D Instruments Ltd. hereby declare that the following Weighing product conforms to the requirements of the council directives on ...
Electromagnetic Compatibility (EMC) 2004/108/EC and Low Voltage Equipment (LVD) 2006/95/EC
provided that they bear the CE mark of conformity.

AD-1690

Standards applicable :
EN61326-1:2006 Electrical equipment for measurement, control and laboratory use. Part I General requirements.

CE Mark first applied 25 June 2010
Signed for A&D Instruments in Oxford England 12 October 2010

Achille Galliena
Managing Director



Clearly Better Value

Copyright © 2010 A&D Instruments Ltd. Registered Office: 23 Woodlands Way, Abingdon, Oxford OX13 1DY

2. FEATURES

- This Leak Tester judges a leak by a pressure change, after the initial pressure is set inside the instrument, to a maximum of $-20\text{kPa} \pm 4\text{kPa}$.

The Leak Tester can verify a leak in a small instrument easily (Example: Micro pipette. etc).

The amount, -20kPa , attained by evacuating the air with the Leak Tester, is approximately 0.2 atmospheres (based on atmospheric pressure at sea level).

(100kPa is approximately 1 atmosphere (based on atmospheric pressure at sea level).)

- This Leak Tester is a tool for judging leakage, and it can not measure pressure values accurately. The Leak Tester displays -20kPa as a reference pressure and measures leakage as a pressure change from this amount.

- This Leak Tester is designed to test the leakage of a pipette or dispenser and prevent foreign particle from invading the Leak Tester when evacuating the air at the nozzle of the instrument.

This Leak Tester is protected against invading dust by an air filter located on the main unit bottom side.

- The accessories provide attachments for three different pipettes tip sizes. You can select an attachment where the tip and pipette size match up. With the Micro pipette, the available test capacity is up to $10000 \mu\ell$.

3. PART NAMES - CONSTITUTION

3.1. Main unit

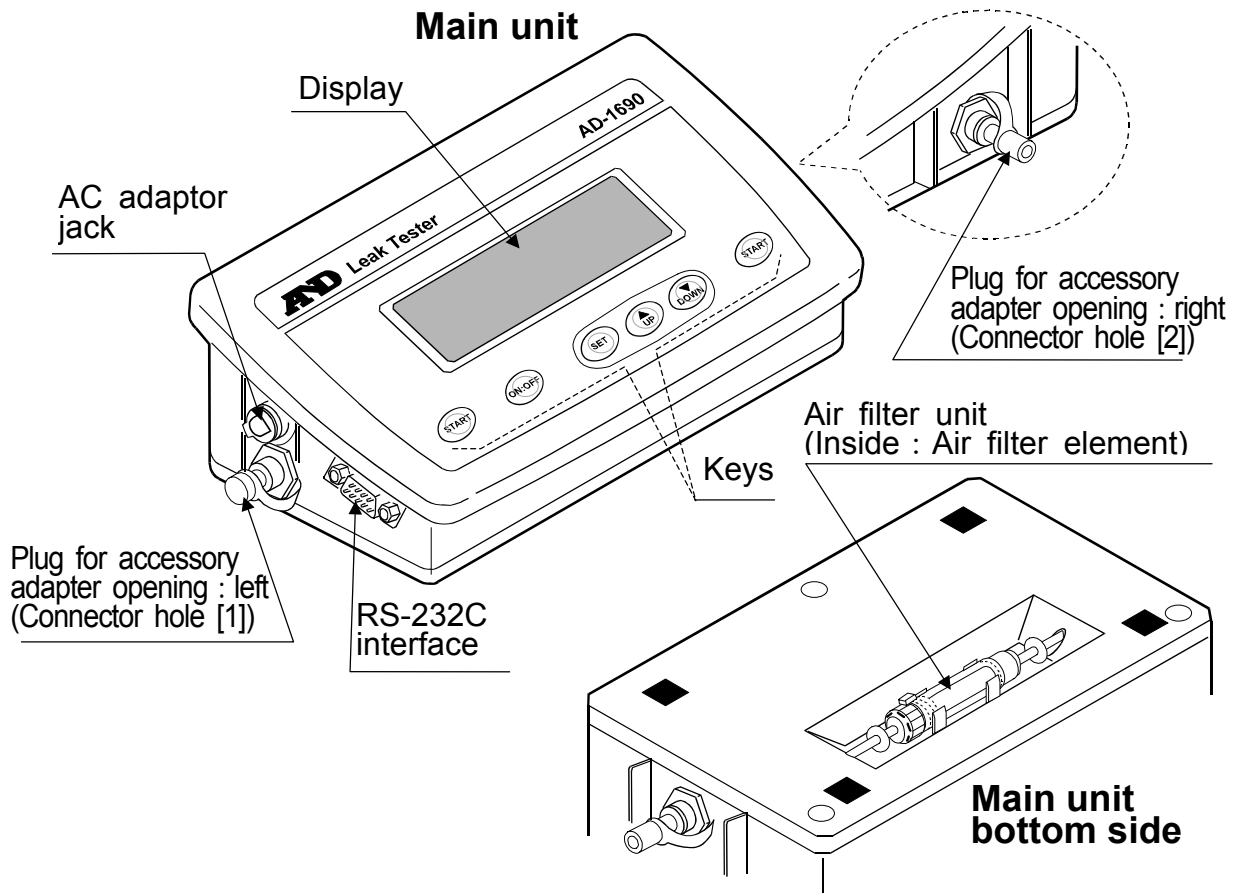

3.2. Accessories

Power supply adapter

Note

Please confirm that the AC adapter type is correct for your local voltage and receptacle type.

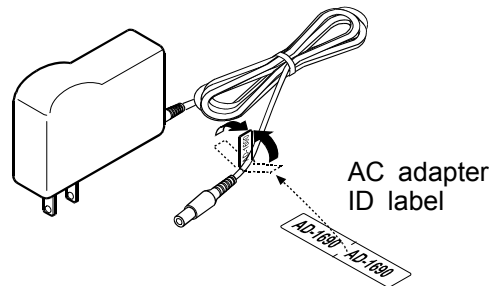

Adapter and Attachment

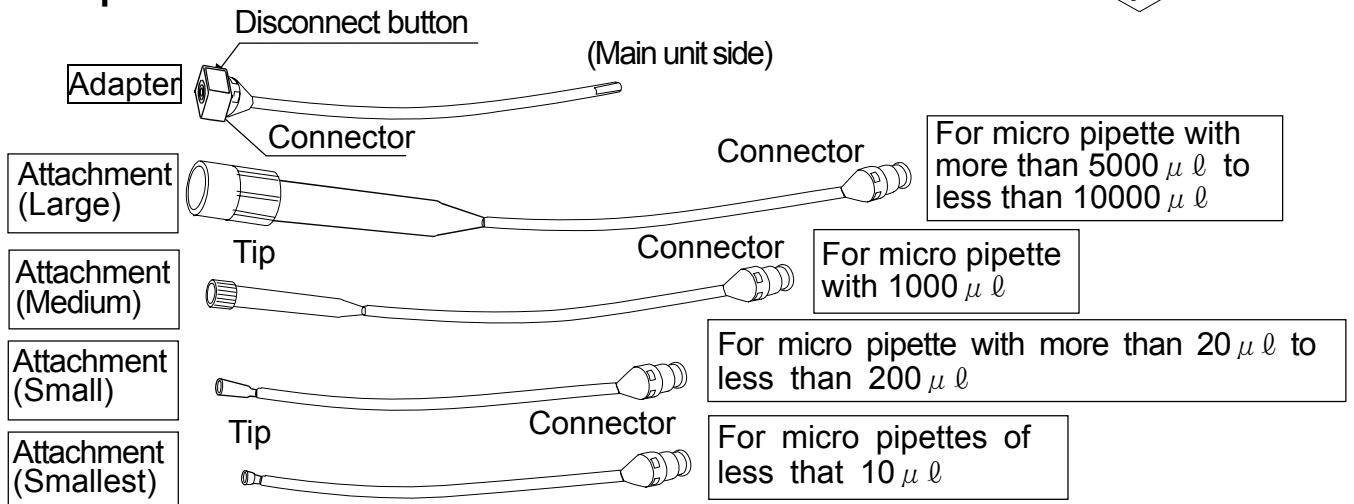

4. CONFIRMING BEFORE USE

(1) Confirming the main unit

With following state, confirm that the right and left air plugs (○ parts) are pushed in the connector holes firmly.

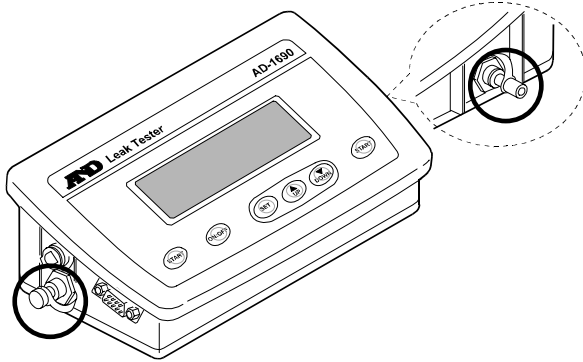

Confirm that the filter unit is installed in the holder located on the main unit bottom side correctly.

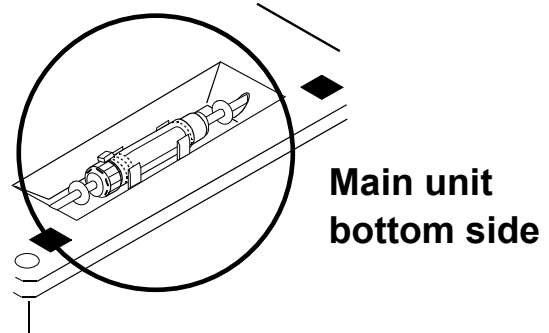

(2) Confirming the operation

1. Connecting the ac adapter to the main unit
Open the AC adapter jack cover located on the side of the main unit, insert the AC adapter plug into the AC adapter jack. Plug the AC adapter into an appropriate electrical outlet.

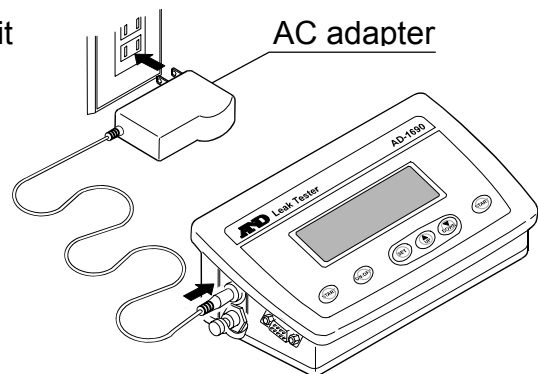

Note

- Please confirm that the AC adapter type is correct for your local voltage and receptacle type.
- The AC adapter plug is protected against dust and may be difficult to insert. When inserting the plug, turn the plug while pushing on it.

2. Main unit conformation

Press the **ON:OFF** key. The display is "REDY" (that means READY) and the Leak Tester is in the measurement standby mode.

With the right and left air plugs installed, press the **START** key.

When displaying "PASS" after operating the pump, the instrument is operating normally.

When displaying "FR IL", confirm that the right and left air plugs, and the filter unit located on the main unit bottom side are connected correctly.

When not solving the "FR IL" display, there may be a leak inside Leak Tester. Contact the local A&D dealer for service.

After confirming, return the inside pressure of the Leak Tester to atmospheric pressure by removing either the right or left air plug. (If an air plug is not removed, the pressure inside the instrument remains in a state of vacuum.) When not starting another measurement immediately, reconnect the air plugs and close the cover on the AC adapter jack, to avoid dust from invading the main unit.

5. MEASUREMENT PREPARATION

(1) Connecting the adapter (tube) to the main unit

Remove the air plug located on either side of the main unit. Connect the tube of the adapter to the main unit.

* The air plugs and the adapter tube are connected by a coupling having a lock function. When removing the air plug or tube, while pushing on the release ring located on the connector opening (1), pull it out (3) after pushing the air plug or tube lightly (2).

Removing the air plug

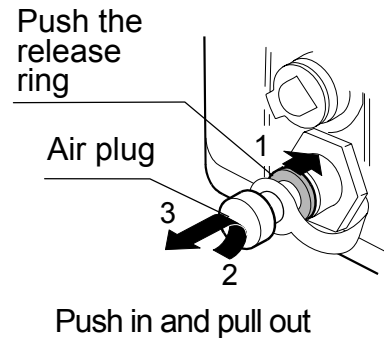

* When connecting, confirm that the air plug or adapter tube is pushed in the connector hole firmly.

Connecting the adapter

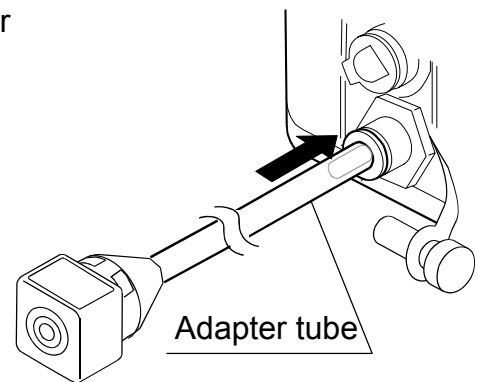

(2) Connecting the attachment (pipette side)

The accessory attachments provided have three different pipettes tip sizes. Select the attachment in order that the tip and pipette size match up, then connect the attachment to the adapter.

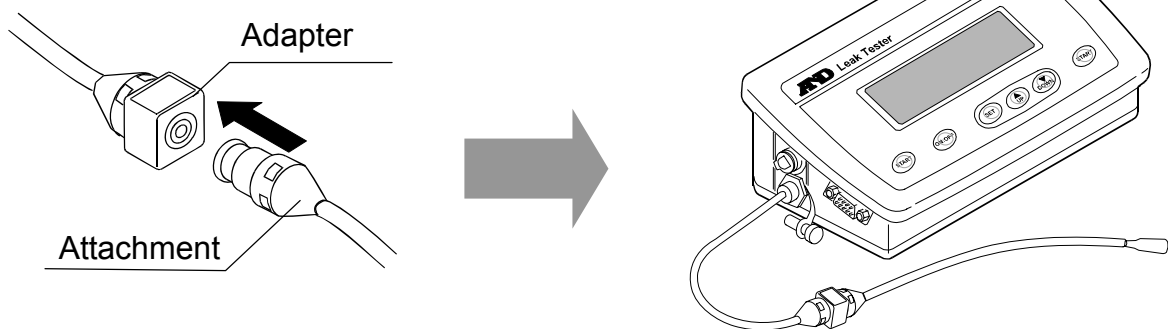

When the pipette does not match up with the attachment provided, replace the tip of the attachment with a tip that matches the pipette.

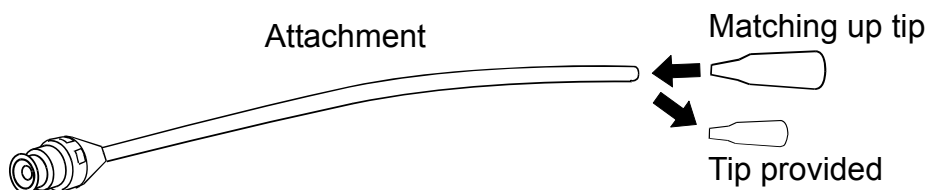

* When replacing the attachment, remove it by pushing the disconnect button (blue part).

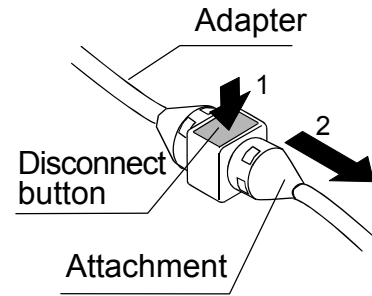





(3) Connecting the ac adapter to the main unit

Open the AC adapter jack cover located on the side of the main unit, insert the AC adapter plug into the AC adapter jack. Plug the AC adapter into an appropriate electrical outlet.

Note

- Please confirm that the AC adapter type is correct for your local voltage and receptacle type.
- The AC adapter plug is protected against dust and may be difficult to insert. When inserting the plug, turn the plug while pushing on it.

6. KEY OPERATION

Key	Description
	Turns the power supply of the main unit on and off.
	These keys are in two positions, to the right and left. These two keys have same function. Start (or stop) the measurement.
	Enter into the setting mode by pressing and holding for 2 seconds. Store the setting condition that was changed by pressing.
	When setting the mode, change the setting value (the quantity of pressure change and monitor time of the leak judgment condition). When using “UP”, the value is increased. When using “DOWN”, the value is decreased.

7. MEASUREMENT

(1) Power supply

Press the **ON:OFF** key (The display is “display all”). After displaying the setting value (quantity of pressure change and monitor time for leak judgment), the display is “REDY” (that means READY) and is in the measurement standby mode.

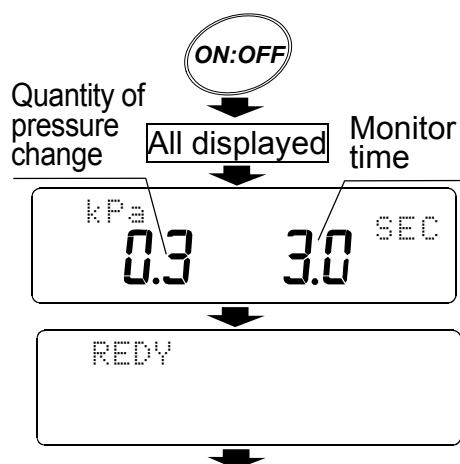

(2) Starting measurement

Connect the test pipette to the tip of the attachment securely.

Press **START** key. The main unit starts the measurement by operating the pump, evacuating the air to -20kPa . (“TEST” display)

When -20kPa is reached, the pump stops.

* -20kPa is approximately 0.2 atmospheres that means that the air has been partially evacuated.

* While stabilizing the inside pressure, the display may change by 0.1 to 0.2 kPa.

The main unit measures the quantity of the pressure changed by the monitor time set. (“MEAS” display)

* Factory setting: monitor time is 3 seconds, quantity of pressure changed is $+0.3\text{kPa}$.

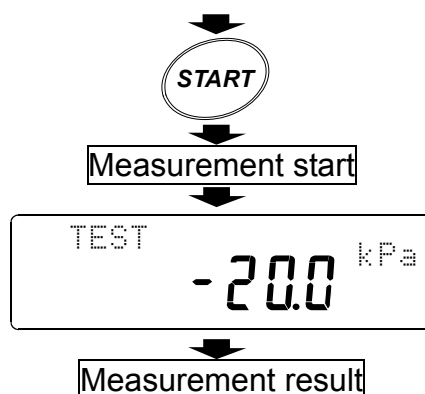
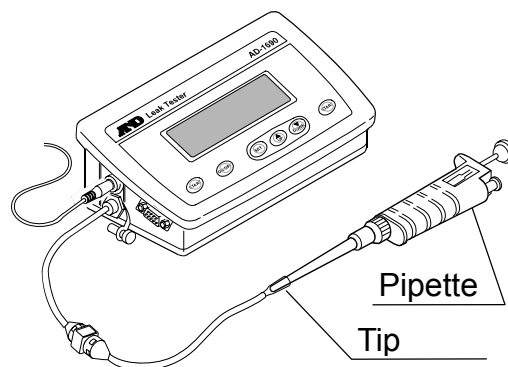

(3) Measurement result

When the quantity of pressure change with leakage is in less than the setting value, the Leak Tester judges that there is no leak and displays “PASS” (normal).

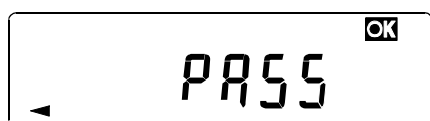

When the pressure, with any leakage does not reach -20kPa or when the quantity of pressure change is over the setting value after reaching -20kPa , the Leak Tester judges that there is a leak and displays “*FAIL*” (abnormality).

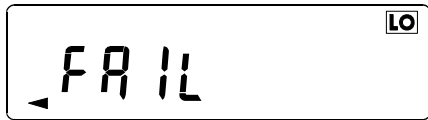

When pressing the **START** key, while in the middle of a measurement, the measurement stops and “*STOP*” is displayed.

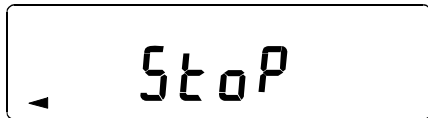

When pressing the **START** key again, the Leak Tester judges the measurement result (“*PASS*”/“*FAIL*”) after operating the pump again.

When finishing the measurement, remove the pipette from the tip of the attachment.
If the pipette has the ejector (for releasing the tip), remove the pipette by operating the ejector.

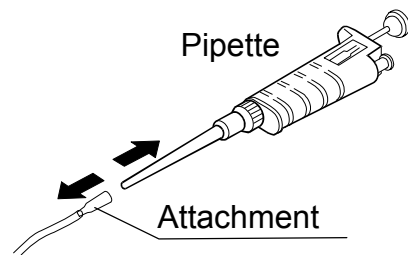

When measuring another pipette, press the **START** key again after connecting the pipette to be measured (return to “(2) Starting measurement”). The leak tester starts the measurement. At this time, the display is the measurement result.

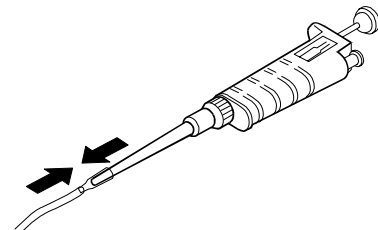

* When kept in a state of having the air evacuated, in the case of not removing the pipette, the pump does not operate again.

(4) Measurement end

When finishing the pipette measurement, Press the **ON:OFF** key to turn the power supply off. (After “*OFF*” is displayed, the power supply turns off.) Then, disconnect the AC adapter from the main unit.

For storing, refer to “10. MAINTENANCE AND NOTES”.

8. CHANGING THE JUDGMENT CONDITION

You can change “quantity of pressure change” and “monitor time” if necessary to set the conditions for judging if there is a leak or no leak.

When canceling the setting halfway, press the **ON:OFF** key to turn the power supply off.

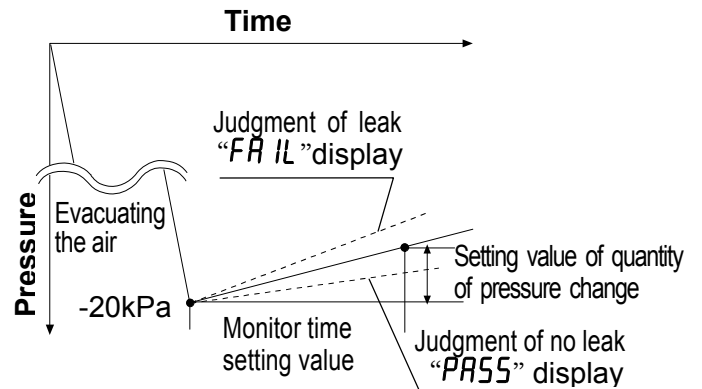

(1) Changing the setting value

When “REDY” *(that means READY) or the measurement result* is displayed, press and hold the **SET** key (Approx. 2 seconds).

The main unit displays the setting value of the quantity of pressure change flashing (left side of the display) and the monitor time (right side of the display).

* Refer to “(1), (3)” of “7. MEASUREMENT”.

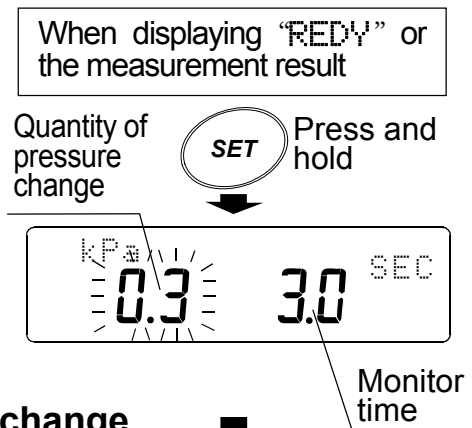

(2) Changing the quantity value of pressure change

After evacuating the air, when the pressure changing is more than the setting value, the Leak Tester judges a leak and “FAIL” is displayed.

The Leak Tester judges the leak by the quantity value of pressure change of the pressure increase. (Unit: kPa)

Changing the minimum value is by 0.1kPa.

(Factory setting : 0.3 kPa)

Change the value by using the **UP** or **DOWN** key.

* The value displayed with the “○” mark (left side of the display) is the value in memory. But, while changing the displayed value, the “○” mark turns off.

Press the **SET** key to store the value.

(The “○” mark turns on, at the left side of the display)

After the quantity value of pressure change stops flashing, the monitor time value (right side of the display) is flashing.

* If the quantity value of pressure change is insufficient when measuring, "FAIL" may be displayed by changing the measurement system pressure (Leak Tester, adapter, attachment).

(3) Changing the monitor time

The leak tester judges the leak by the monitor time. (Unit: second)

Changing the minimum value is by 0.5 seconds.

(Factory setting : 3.0 seconds)

Change the value by using the **UP** or **DOWN** key.

* The value displayed with the "○" mark (left side of the display) is the value in memory. But while changing the displayed value, the "○" mark is turned off.

Press the **SET** key to store the value.

After setting finish, "SET End" is displayed for approximately 1 second. (the "End" is flashing)

(4) End of setting

The Leak Tester returns to the measurement standby mode by non-operation, or by pressing the **SET** key, to memorize the setting value changed with "(2), (3)" above.

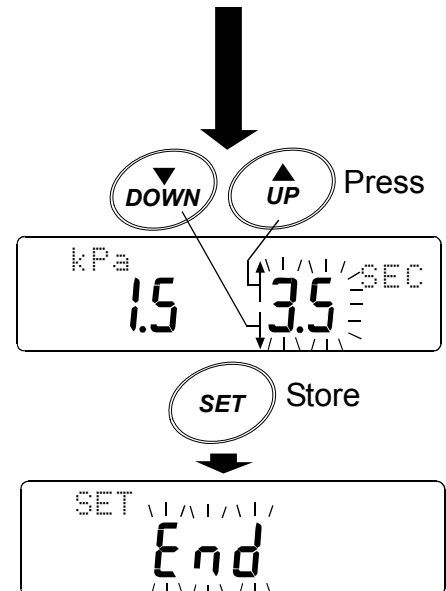

(5) Initializing the setting value

When displaying* “End” of (3), press the **DOWN** key at once.

* Refer to “(3) Changing the monitor time”.

After displaying “in it”, “in it no” is displayed.

If you want to initialize, press the **UP** or **DOWN** key to change to “Go”, and press the **SET** key.

After the setting value returns to the value initialized (quantity of pressure change: 0.3kPa, monitor time: 3.0 seconds), the display returns to measurement standby mode (“REDY” display).

If you do not want to initialize, when displaying the “no”, press the **SET** key. The display returns to measurement standby mode (“REDY” display) after displaying “End”.

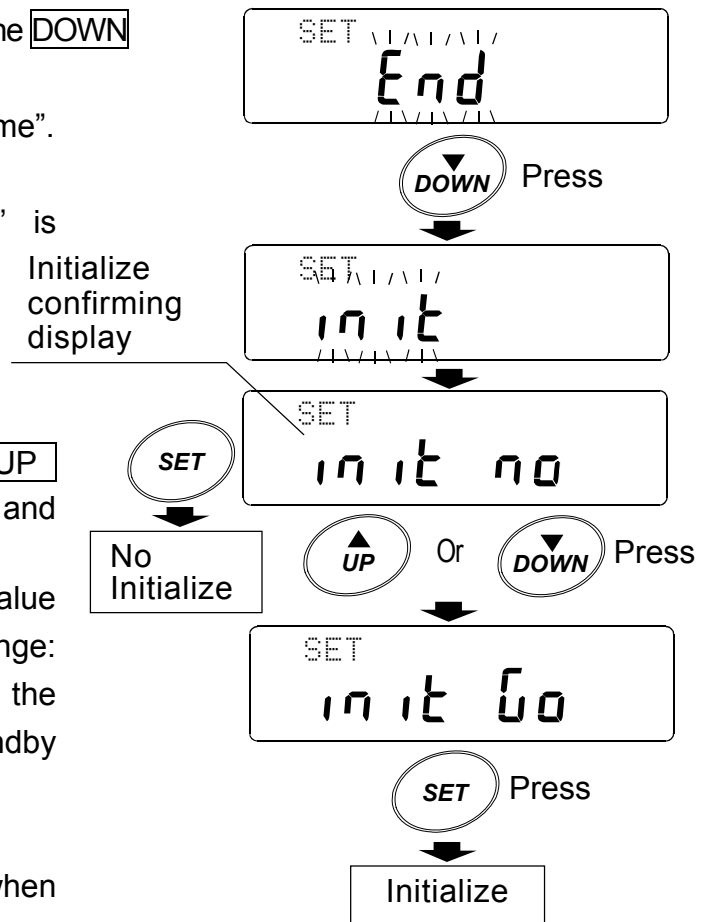

9. FUNCTION

Set the function by the following procedure.

(1) Entering the function

With the power turned off, press and hold the **SET** key and press the **ON:OFF** key, to turn the power on. After displaying "SELECT", "rESULT" (flashing) is displayed.

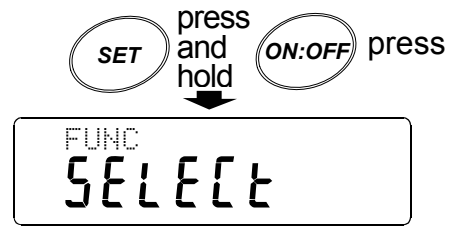

(2) Selecting the mode of the function (item)

Press the **UP** or **DOWN** key to select the item of the function. (Refer to figure on the left below)

(3) Entering the setting mode

Press the **SET** key to enter the setting mode with the item selected. (Refer to figure on the right below)

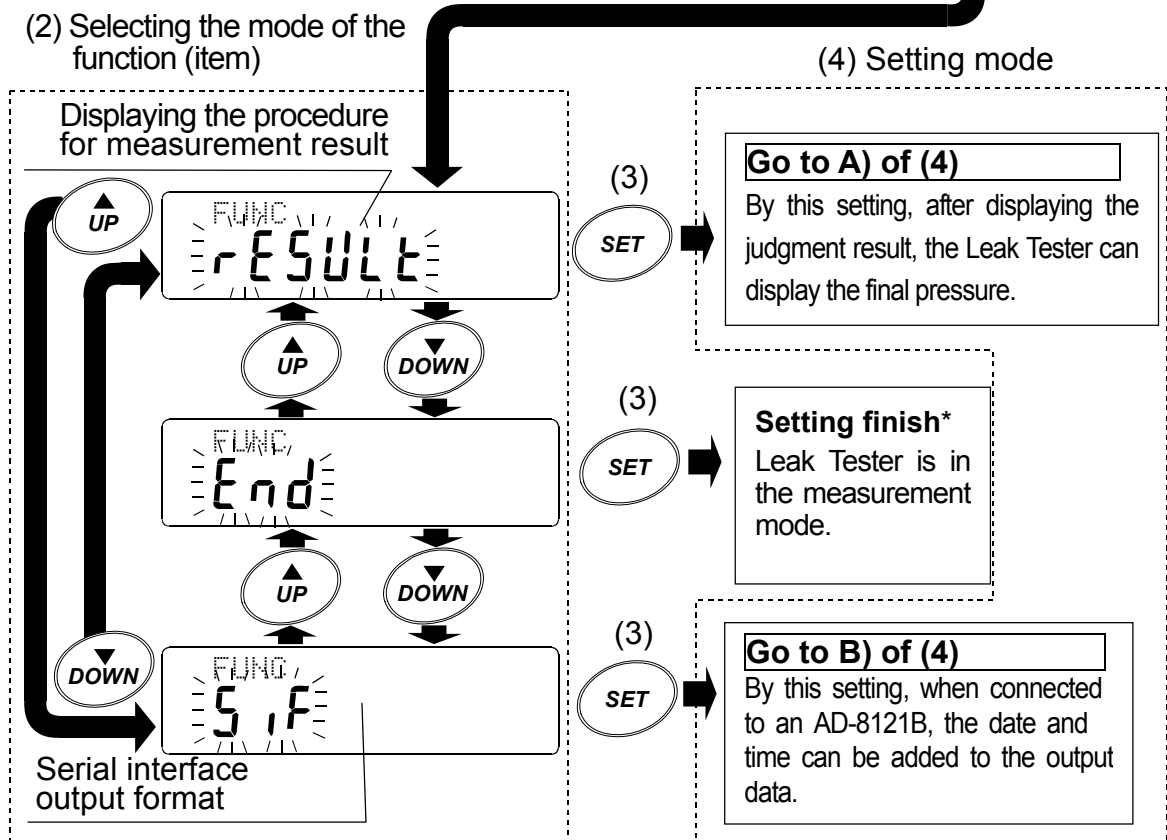

* Press the **SET** key while "End" is flashing.

(4) Setting mode

A) Selecting the procedure for measurement result

- The *SEt* procedure is displayed.

- Press the **UP** or **DOWN** key to select either *SEt off* or *SEt on*.

SEt off : After measurement, Leak Tester display the only judgment result (*PASS* or *FAIL*).

SEt on : After measurement, Leak Tester display the final pressure after displaying the judgment result.

PASS OK

↓ Approx. 1 second

PASS OK
- 19.8 kPa

- Press the **SET** key to store the setting.
The display is in the next setting mode.

(*SIF* or *End*)

* Factory setting: *SEt off*

Continued from (3 on page 13)

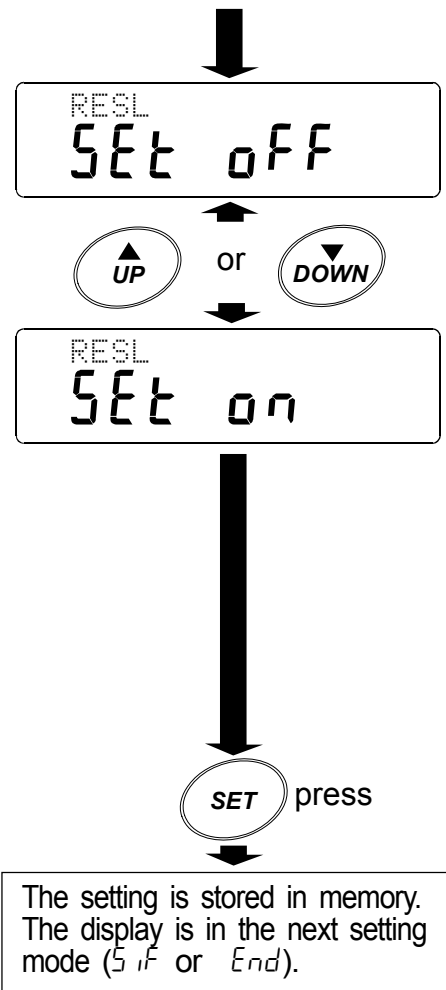

B) Setting the output format of the serial interface

- The *tYPE* procedure is displayed.

- Press the **UP** or **DOWN** key to select either *tYPE 0* or *tYPE 1*.

tYPE 0 : The setting to connect the Leak Tester to either an AD-1688, PC, or AD-8121B.

tYPE 1 : The setting to output the date and time by an AD-8121B.

(The date and time are added before each data set)

- Press the **SET** key to store the setting.
The display is in the next setting mode.

(*rESULT* or *End*)

* Factory setting: *SEt off*

Continued from (3 on page 13)

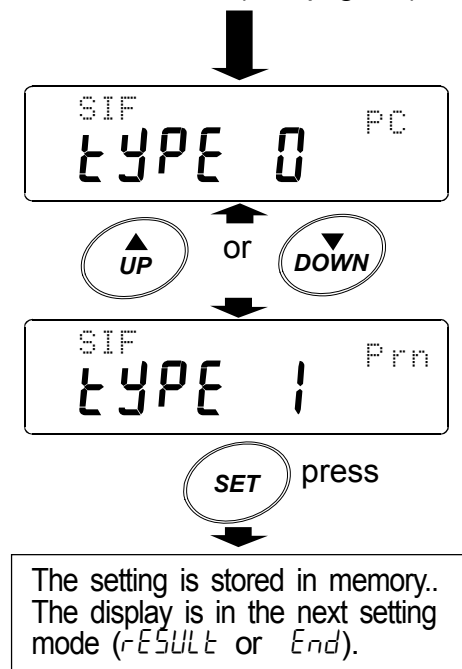

■ Print sample

TYPE 0:

sample printed with AD-8121B

```
Setting Info.  
00.3kPa/03.0s  
PASS -19.9kPa  
FAIL -03.5kPa
```

TYPE 1:

sample printed with AD-8121B

```
DATE 2010/02/26  
TIME 16:31:13  
Setting Info.  
00.3kPa/03.0s  
  
DATE 2010/02/26  
TIME 16:31:29  
PASS -19.9kPa  
  
DATE 2010/02/26  
TIME 16:32:08  
FAIL -03.5kPa
```

- * The date and time of the print sample use the internal clock of the AD-8121B. Set the AD-8121B date and time if necessary.
- * The AD-1690 can send a special code for printing the date and time. Therefore, set to "*TYPE 0*", when connecting the AD-1690 to instruments other than the AD-8121B.

■ Setting of the AD-8121B

When using with either *TYPE 0* or *TYPE 1*, set the AD-8121B to MODE3.

10. MAINTENANCE AND NOTES

(1) Removing the attachment

After measurement, remove the pipette and accessory by the following procedure. When storing the main unit, allow of the Leak Tester to equalize to atmospheric pressure.

1. Remove the pipette from the attachment.

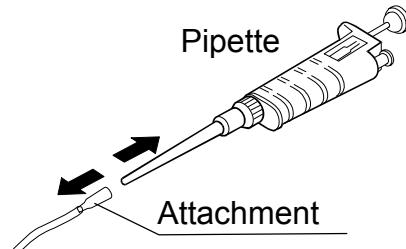

2. Remove the attachment from the adapter.

At this time, if the attachment is still connected to a pipette, the inside pressure of the Leak Tester will not return to atmospheric pressure.

(2) Storing

When storing the leak tester, avoid dust from invading the main unit and connector tube (adapter, attachment).

Close the cover of the AC adapter jack.

1) Adapter

Dust can not enter the main unit when connected to the accessory adapter.

The connector has the airlock function. Therefore, the Leak Tester is protected from invading dust. But if the connector part of the adapter becomes dirty, dust may invade at the next measuring.

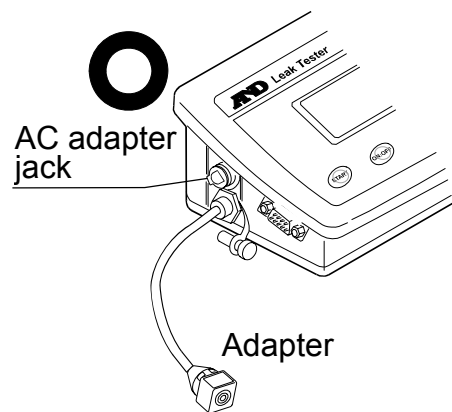

2) If the attachment is connected to the adapter, dust may invade through the attachment. When storing, remove the attachment.

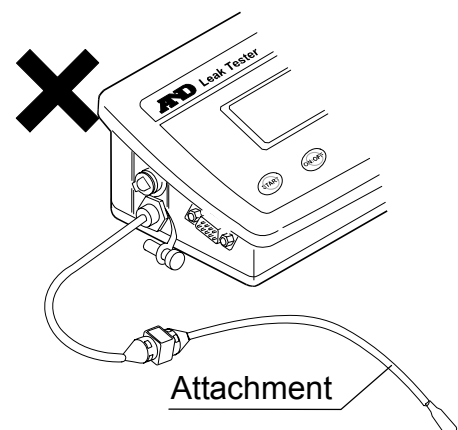

3) Main unit

Push the cover in the AC adapter jack and push the air plug in the connector hole (right and left side), so that dust can not invade the main unit.

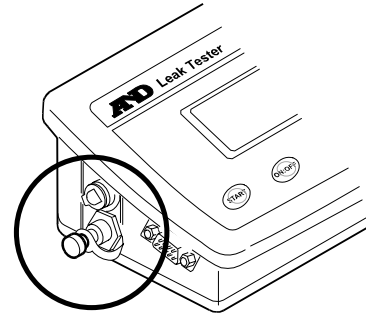

4) Storing the attachment and adapter

Store the adapter and attachments in the sealed bag. They will be protected from invading dust.

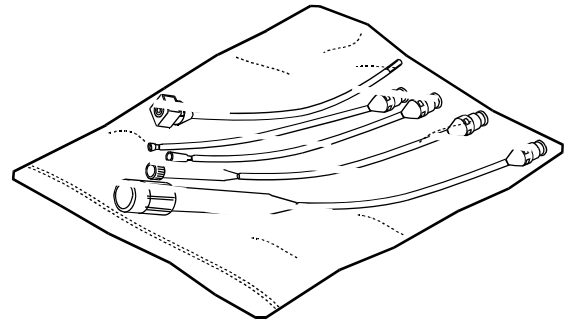

(3) Exchanging the filter

The inside of the main unit is protected from invading dust by the air filter located on the main unit bottom side.

Check the main unit regularly, replace the filter element or filter unit if necessary.

Turn the power supply of the main unit off by removing the AC adapter. And after returning the inside of the leak tester to atmospheric pressure by removing the pipette, follow this procedure.

1) Removing the filter unit

Invert the main unit and remove the filter unit from the holder.

Pull the tubes out from both sides of the filter unit.

(At this time, while pushing the release ring lightly, pull the tube out after pushing it in lightly.)

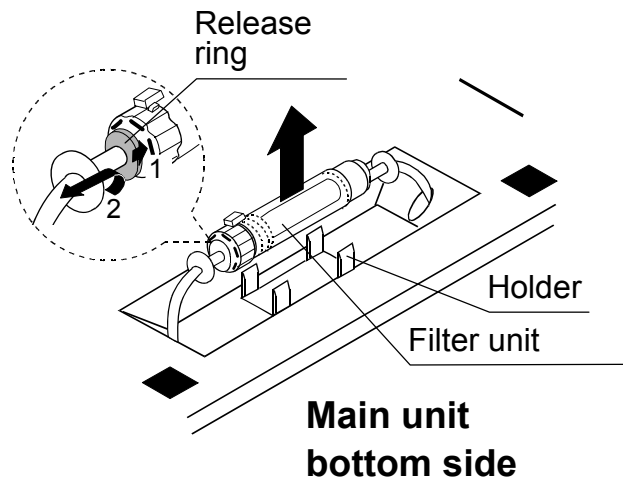

2) Replacing the filter element

When replacing only the filter element, follow this procedure:

1. Slide the red slide lock located on the filter unit in opposite direction of the arrow.

2. Turn the coupling in a counterclockwise direction (180 degrees).

3. Remove the coupling from the filter cover. Remove the old filter element from the coupling.

4. Clean the dust from inside the filter cover, if necessary.

5. After connecting the new filter element to the coupling, insert it into the filter cover. Last, turn the coupling in a clockwise direction.

6. Confirm that the positioning of the detent located on the coupling and the slide lock match up and slide the slide lock in the direction arrow. Confirm that the coupling is securely locked.

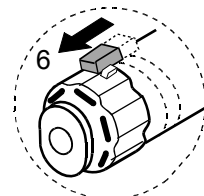
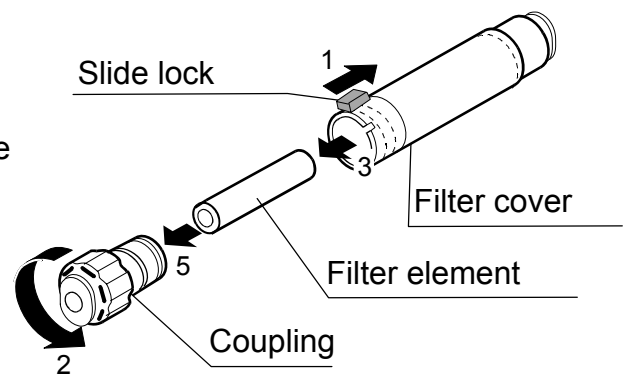

3) Installing the filter unit

Install the filter unit with the filter element replaced, or with a new filter unit, into the main unit following this procedure:

1. Connect the tubes to the both sides of the filter unit.

At this time, be careful that the direction of the filter unit is correct (Refer figure at the right). When inserting, do not turn the tube.

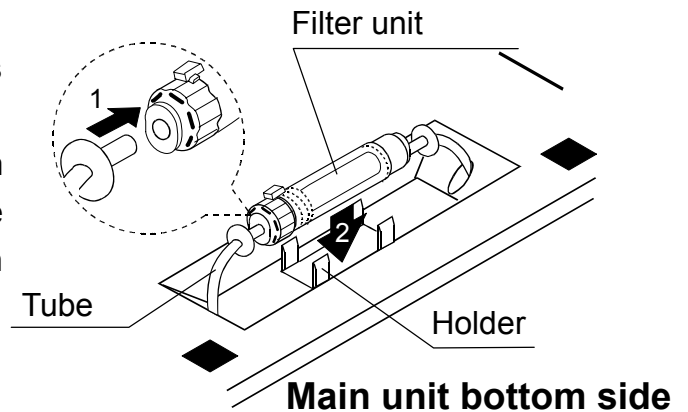

2. Install the filter unit into the holder.

* If particles of dust invade the tube, they may cause trouble. When replacing the filter, be careful that no dust invades the instrument.

(4) Note

1. Checking the Leak Tester (main unit)

- Insert the adapter into the connector opening, and insert the air plug into the connector opening on the other side.
- Turn the power supply of the main unit on. Press the **START** key.
- When detecting leakage inside of the main unit, the main unit displays "FR IL".
- When displaying "FR IL", confirm that the each of the connector parts, filter unit are securely connected.

When displaying "FR IL" after this operation, contact the local A&D dealer for service.

2. Size of the instrument measured

The object instrument is up to an inside capacity of about 50 ml.

The Leak Tester can test the leakage of a pump, container or plumbing that have a capacity less than about 50 ml.

3. The tip that is connected to the attachment end is a consumable.

When the attachment tip is worn, damaged or not matching up with the pipette, replace it with a new tip.

4. The internal leak quantity, of the Leak Tester, may increase due to dust invasion.

In this case, change the setting of the pressure change value to within possibility.

11. RS-232C INTERFACE

(1) Interface specification

The Leak Tester can output the data to an AD-8121B (compact printer: sold separately), AD-1688 (weighing data logger) or a personal computer. etc.

This model is a DCE device. Connect the Leak Tester to a personal computer (DTE), using a straight through cable.

Transmission system : EIA RS-232C (Connector type: D-Sub9 pin (male))
 Transmission form : Asynchronous, bi-directional, half duplex
 Data format : Baud rate : 2400 bps
 : Data bits : 7 bits
 : Parity : Even(Data bits 7 bits)
 : Stop bit : 1 bit
 : Code : ASCII

Example: Connected to an AD-8121B

AD-8121B

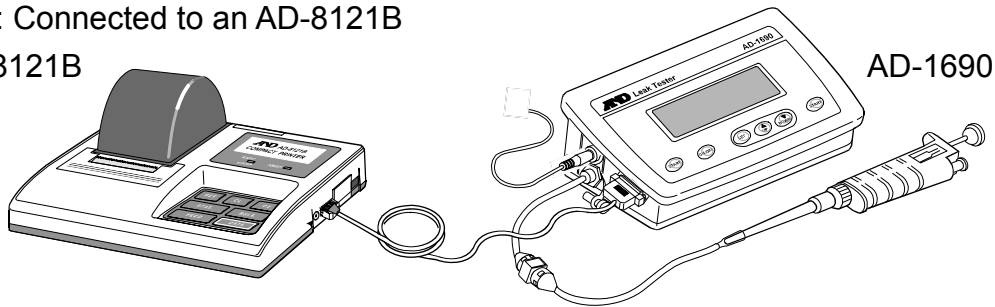

* Set the mode of the AD8121B to “MODE 3”.

The AD8121B can print the example of “(2) Output format” (next page).

Pin connections

Pin No.	Signal name	Direction	Description
1	—	—	Internally used
2	TXD	Output	Transmit data
3	RXD	Input	Receive data
4	—	—	Internally used
5	SG	—	Signal ground
6	DSR	Output	Data set ready
7	RTS	Input	Request to send
8	CTS	Output	Permission to send
9	—	—	Internally used

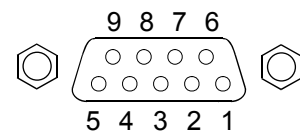

Screw: inch #4-40

The names are the DTE side other than the TXD and RXD.

(2) Output format

- Output of the setting value

When turning the power supply on, the present setting information is output.

S	e	t	t	i	n	g		I	n	f	o	.				CR	LF
0	0	.	3	k	P	a	/	0	3	.	0	s	CR	LF			

When changing the setting value, the new setting information is output.

S	e	t	t	i	n	g		C	h	a	n	g	e	d		CR	LF
0	0	.	3	k	P	a	/	0	3	.	0	s	CR	LF			

- Output of the measurement result

When finishing the measurement, the data is output one time.

When PASS: the judgment result "PASS" is output and the measurement pressure value.

P	A	S	S		-	1	9	.	9	k	P	a	CR	LF
---	---	---	---	--	---	---	---	---	---	---	---	---	----	----

When FAIL: the judgment result "FAIL" is output and the measurement pressure value.

F	A	I	L		-	1	8	.	5	k	P	a	CR	LF
---	---	---	---	--	---	---	---	---	---	---	---	---	----	----

Or

F	A	I	L		L	o	w						CR	LF
---	---	---	---	--	---	---	---	--	--	--	--	--	----	----

When not evacuating the air to -20kPa caused by many leaks.

12. SPECIFICATIONS

Pressure of evacuating the air	-20kPa ± 20% (Fixed)
Capacity pressure changing of Inside instrument	+0.2kPa / 10 seconds
Leak judgment condition	Setting value of quantity of pressure change: +0.1~+20kPa (Minimum change value: 0.1kPa, variable)
	Monitor time: 1.0 second~ (Minimum change value: 0.5 second, variable)
Pump driving time	~6 seconds
Dimensions	(W) 231mm × (D) 126mm × (H) 78mm
Weight of the main unit	Approx. 570g
Attachment	(Large) For micro pipette with more than 5000 μℓ to less than 10000 μℓ (Medium) For micro pipette with 1000 μℓ (Small) For micro pipette with more than 20 μℓ to less than 200 μℓ (Smallest) For micro pipettes of less than 10 μℓ * When your pipette and the attachment tip size do not match up, replace the attachment tip with a suitable sized tip.

12.1. Optional accessories and Sold separately

Optional accessories

- AD-1690-01 Replacement tube set

This set consists of the adapter (one piece) and the attachments (one piece each of Large / Medium / Small / Smallest)

- AD-1690-02 Replacement filter set

This set consists of a filter unit (one piece) and filter elements (ten pieces)

- AD-1690-015 Carrying case

An optional carrying case for the AD-1690 Leak Tester and AC adapter, with additional space for an AD-1682 Rechargeable battery (sold separately).

Sold separately

- AD-1682 Rechargeable battery

For using the Leak Tester where there is no power supply (Example: pipette use site .etc)

12.2. Dimensions

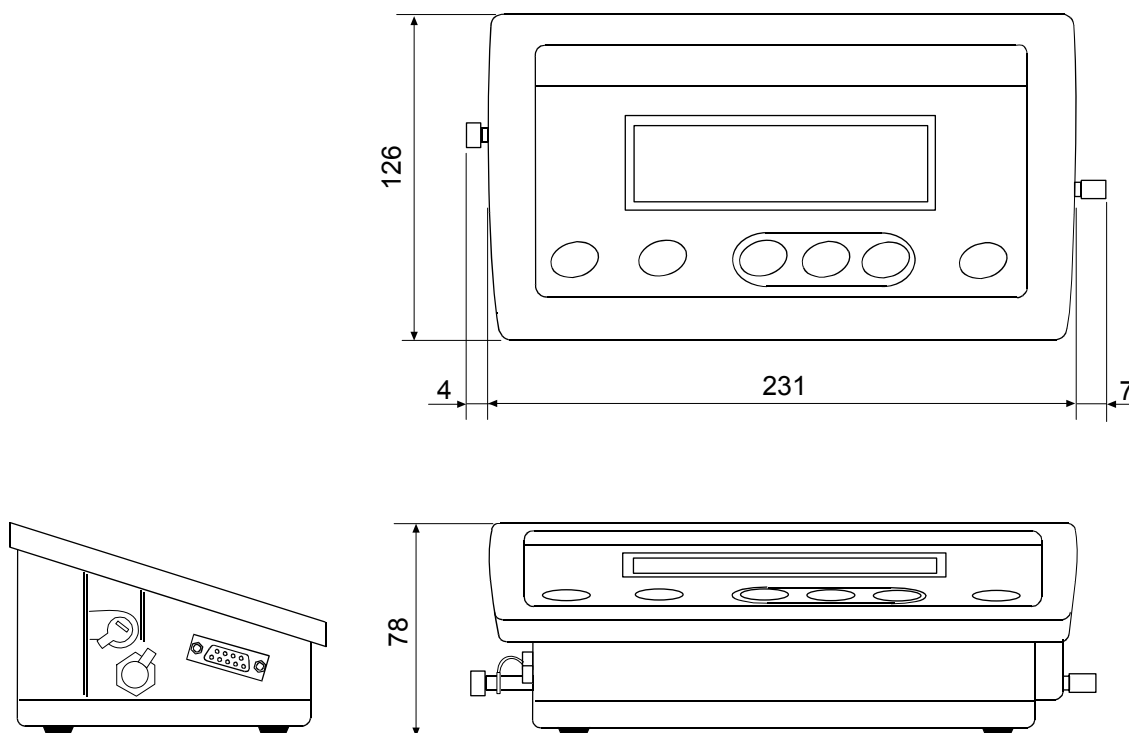

Unit: mm