

User Manual  
ENGLISH



# Clamp-On Meter Model 407



## CLAMP-ON METERS

Measure Up  
WITH AEMC INSTRUMENTS



Copyright© Chauvin Arnoux®, Inc. d.b.a. AEMC® Instruments. All rights reserved.

No part of this documentation may be reproduced in any form or by any means (including electronic storage and retrieval or translation into any other language) without prior agreement and written consent from Chauvin Arnoux®, Inc., as governed by United States and International copyright laws.

This documentation is provided **as is**, without warranty of any kind, express, implied, or otherwise. Chauvin Arnoux®, Inc. has made every reasonable effort to ensure that this documentation is accurate; but does not warrant the accuracy or completeness of the text, graphics, or other information contained in this documentation. Chauvin Arnoux®, Inc. shall not be liable for any damages, special, indirect, incidental, or inconsequential; including (but not limited to) physical, emotional or monetary damages due to lost revenues or lost profits that may result from the use of this documentation, whether or not the user of the documentation has been advised of the possibility of such damages.

# Statement of Compliance

Chauvin Arnoux®, Inc. d.b.a. AEMC® Instruments certifies that this instrument has been calibrated using standards and instruments traceable to international standards.

We guarantee that at the time of shipping your instrument has met the instrument's published specifications.

**An NIST traceable certificate may be requested at the time of purchase, or obtained by returning the instrument to our repair and calibration facility, for a nominal charge.**

The recommended calibration interval for this instrument is 12 months and begins on the date of receipt by the customer. For recalibration, please use our calibration services.

**Serial #:**

**Catalog #:** 2139.51 \_\_\_\_\_

**Model #:** 407

Please fill in the appropriate date as indicated:

Date Received:

Date Calibration Due: \_\_\_\_\_











\_\_\_\_\_



---

# TABLE OF CONTENTS

---

<b>1. INTRODUCTION</b>	<b>8</b>
1.1 INTERNATIONAL ELECTRICAL SYMBOLS	8
1.2 DEFINITION OF MEASUREMENT CATEGORIES (CAT)	8
1.3 PRECAUTIONS FOR USE	9
1.4 RECEIVING YOUR SHIPMENT	10
1.5 ORDERING INFORMATION	10
1.5.1 Accessories	10
1.5.2 Replacement Parts	10
<b>2. PRODUCT FEATURES</b>	<b>11</b>
2.1 FRONT OF INSTRUMENT	12
2.2 ROTARY SWITCH	13
2.3 FUNCTION BUTTONS	14
2.4 DISPLAY	15
2.4.1 Display Symbols	15
2.4.2 Measurement Capacity Exceeded (OL)	17
2.5 TERMINALS	17
<b>3. FUNCTION BUTTONS</b>	<b>18</b>
3.1  BUTTON	18
3.2  YELLOW (SECOND FUNCTION) BUTTON	18
3.3  BUTTON	19
3.4  BUTTON	20
3.5  BUTTON	20
3.5.1 Normal Mode	20
3.5.2 MAX/MIN Mode + Activation of the HOLD Mode	21
3.5.3 Access to True InRush® Mode (  set switch to  )	22
3.6  BUTTON	22
3.6.1 Normal Mode	23
3.6.2 Harmonic Order Display (  or  +  )	23
3.6.3 Hz Function + Activation of the HOLD Mode	24

**4. USE..... 25**

- 4.1 INSTALLING THE BATTERIES..... 25
- 4.2 TURNING ON THE INSTRUMENT ..... 25
- 4.3 TURNING OFF THE INSTRUMENT ..... 26
- 4.4 CONFIGURATION ..... 26
  - 4.4.1 Auto Power Off..... 26
  - 4.4.2 Current Threshold for True InRush® Measurement..... 26
  - 4.4.3 Recording Duration ..... 27
  - 4.4.4 Erasing Recordings from Memory..... 27
  - 4.4.5 Default Configuration..... 27
- 4.5 VOLTAGE MEASUREMENT (V)..... 28
- 4.6 CONTINUITY TEST ..... 29
- 4.7 RESISTANCE MEASUREMENT  $\Omega$ ..... 30
- 4.8 CURRENT MEASUREMENT (A)..... 30
  - 4.8.1 AC Measurement..... 31
  - 4.8.2 DC or AC+DC Measurement..... 32
- 4.9 CURRENT OR OVERCURRENT (TRUE INRUSH®) MEASUREMENT ..... 34
- 4.10 POWER MEASUREMENT W, VA, VAR AND PF..... 35
  - 4.10.1 Single-Phase Power Measurement ..... 35
  - 4.10.2 Balanced 3-Phase Power Measurement..... 37
  - 4.10.3 Four Quadrant Diagram..... 38
- 4.11 ENERGY METERING MEASUREMENT ..... 39
- 4.12 FREQUENCY MEASUREMENT (HZ)..... 42
  - 4.12.1 Frequency Measurement (V) ..... 42
  - 4.12.2 Frequency Measurement (A) ..... 43
- 4.13 TOTAL HARMONIC DISTORTION (THD) MEASUREMENT AND HARMONICS ORDER DISPLAY ..... 44
  - 4.13.1 THD (V) Measurement..... 44
  - 4.13.2 THD (A) Measurement..... 45
  - 4.13.3 Individual Harmonics and Frequency of the Fundamental from DC to the 25th ..... 46
- 4.14 RECORDING ..... 46

4.15 CONNECTING TO A COMPUTER.....	47
4.15.1 Bluetooth Connection.....	47
4.15.2 Bluetooth Connection .....	47
4.16 BLUETOOTH ON/OFF .....	48
4.17 RECORDING DATA.....	48
4.17.1 Starting a Recording Session.....	48
4.17.2 Stopping a Recording Session.....	49
4.18 DOWNLOADING RECORDED DATA .....	49
4.19 ERASING DATA FROM MEMORY.....	49
4.20 DATA STORAGE .....	49
4.20.1 Trend Measurements.....	49
4.20.2 Recording with Memory Cleared.....	49
4.20.3 Recording with a Partial or Full Memory .....	49
4.20.4 Memory Filled During Recording Session.....	50
4.21 DATAVIEW® INSTALLATION .....	50

**5. SPECIFICATIONS ..... 51**

5.1 REFERENCE CONDITIONS.....	51
5.2 SPECIFICATIONS UNDER THE REFERENCE CONDITIONS .....	51
5.2.1 DC Voltage Measurement .....	51
5.2.2 AC Voltage Measurement .....	52
5.2.3 AC+DC Voltage Measurement .....	52
5.2.4 DC Current Measurement .....	53
5.2.5 AC Current Measurement .....	53
5.2.6 AC+DC Current Measurement .....	54
5.2.7 True InRush® Measurement .....	54
5.2.8 Crest Factor (CF) Calculation.....	55
5.2.9 RIPPLE in DC Calculation.....	55
5.2.10 Continuity Measurement.....	55
5.2.11 Resistance Measurement .....	56
5.2.12 Active DC Power Measurements.....	56
5.2.13 Active AC Power Measurements .....	57
5.2.14 Active AC+DC Power Measurements.....	58
5.2.15 Apparent AC Power Measurement .....	58
5.2.16 Apparent AC+DC Power Measurement.....	58

5.2.17 Measurement of Reactive AC Power .....	59
5.2.18 Measurement of Reactive AC+DC Power.....	59
5.2.19 Calculation of the Power Factor (PF).....	60
5.2.20 Calculation of the Displacement Power Factor (DPF)....	60
5.2.21 Frequency Measurements.....	61
5.2.21.1 Voltage .....	61
5.2.21.2 Current .....	61
5.2.22 Specifications in THDr .....	61
5.2.23 Specifications in THDf.....	62
5.2.24 Harmonic Measurement Specifications .....	62
5.3 ENVIRONMENTAL CONDITIONS .....	63
5.4 MECHANICAL SPECIFICATIONS .....	63
5.5 POWER SUPPLY .....	63
5.6 COMPLIANCE WITH INTERNATIONAL STANDARDS .....	63
5.7 ENVIRONMENTAL VARIATIONS.....	64
<b>6. MAINTENANCE .....</b>	<b>65</b>
6.1 WARNING .....	65
6.2 CLEANING .....	65
6.3 BATTERY REPLACEMENT .....	65
6.4 REPAIR AND CALIBRATION .....	66
6.5 TECHNICAL ASSISTANCE .....	66
6.6 LIMITED WARRANTY .....	67
6.6.1 Warranty Repairs.....	67

---











# 1. INTRODUCTION

---

Thank you for purchasing an AEMC® Instruments **Model 407 Clamp-On Meter**.

For best results from your instrument and for your safety, read the enclosed operating instructions carefully and comply with the precautions for use. Only qualified and trained operators should use this product.

## 1.1 INTERNATIONAL ELECTRICAL SYMBOLS

	Signifies that the instrument is protected by double or reinforced insulation.
	<b>CAUTION - Risk of Danger!</b> Indicates a <b>WARNING</b> . Whenever this symbol is present, the operator must refer to the user manual before operation.
	Indicates a risk of electric shock. The voltage at the parts marked with this symbol may be dangerous.
	Application or withdrawal authorized on conductors carrying dangerous voltages. Type A current sensor as per IEC 61010-2-032.
	Low Battery Indicator
	Indicates Important information to acknowledge
	This product complies with the Low Voltage & Electromagnetic Compatibility European directives (73/23/CEE & 89/336/CEE).
	In the European Union, this product is subject to a separate collection system for recycling electrical and electronic components in accordance with directive WEEE 2012/19/EU.
	AC - Alternating current
	AC and DC - Alternating and direct current
	Ground/Earth

## 1.2 DEFINITION OF MEASUREMENT CATEGORIES (CAT)

**CAT IV:** Corresponds to measurements performed at primary electrical supply (< 1000 V).

*Example: primary overcurrent protection devices, ripple control units, and meters.*

**CAT III:** Corresponds to measurements performed in the building installation at the distribution level.

*Example: hardwired equipment in fixed installation and circuit breakers.*

**CAT II:** Corresponds to measurements performed on circuits directly connected to the electrical distribution system.

*Example: measurements on household appliances and portable tools.*



## 1.3 PRECAUTIONS FOR USE

This instrument complies with safety standards IEC-61010-1 and 61010-2-032 for voltages of 1000 V in CAT IV at an altitude of less than 6500 ft (2000 m), indoors, with a degree of pollution not exceeding 2. These safety instructions are intended to ensure the safety of persons and proper operation of the device.

- The operator and/or the responsible authority must carefully read and clearly understand the various precautions to be taken in use.
- If this instrument is used other than as specified, the protection it provides may be compromised, thereby endangering you.
- Do not use the instrument in an explosive atmosphere or in the presence of flammable gases or fumes.
- Do not use the instrument on networks of which the voltage or category exceeds those mentioned.
- Do not exceed the rated maximum voltages and currents between terminals or with respect to earth.
- Do not use the instrument if it appears to be damaged, incomplete, or not properly closed.
- Before each use, check the condition of the insulation on the leads, housing, and accessories. Any element of which the insulation is deteriorated (even partially) must be set aside for repair or scrapped.
- Use leads and accessories rated for voltages and categories at least equal to those of the instrument. If not, an accessory of a lower category lowers the category of the combined Clamp + accessory to that of the accessory.
- Observe the environmental conditions of use.
- Do not modify the instrument and only use factory replacement parts. Repairs and adjustments must be done by approved qualified personnel.
- Replace the batteries as soon as the  symbol appears on the display of the unit. Disconnect all leads before opening the battery compartment cover.
- Use personal protective equipment when conditions require.
- Keep your hands away from the unused terminals of the instrument.
- When handling the test probes, alligator clips, and clamp ammeters, keep your fingers behind the physical guard.
- As a safety measure, and to avoid repeated overloads on the inputs of the device, configuration operations should only be performed when the device is disconnected from all dangerous voltages.

## 1.4 RECEIVING YOUR SHIPMENT

Upon receiving your shipment, make sure that the contents are consistent with the packing list. Notify your distributor of any missing items. If the equipment appears to be damaged, file a claim immediately with the carrier and notify your distributor at once, giving a detailed description of any damage. Save the damaged packing container to substantiate your claim.

## 1.5 ORDERING INFORMATION

**Clamp-On Meter Model 407** ..... **Cat. #2139.51**  
*Includes set of 2 color-coded silicone insulated test leads, test probes and alligator clips, hard carrying case, (4) 1.5 V AA batteries, Bluetooth adapter, safety information sheet and a USB drive supplied with product user manual and DataView® software.*

### 1.5.1 Accessories

Multi-purpose Canvas Pouch..... **Cat. #2119.48**  
Set of (2) 5 ft (1.5 m) Needle Tip Color-coded (Red/Black) Leads w/ 4 mm Right-angle Plug (600 V CAT IV w/shield on Needle Tip, 1000 V CAT II w/o shield)..... **Cat. #2154.74**

### 1.5.2 Replacement Parts

Hard Carrying Case ..... **Cat. #2139.73**  
Lead - Set of (2) Color-coded Silicone Test Leads (Red/Black) 5 ft w/ 4 mm straight/right angle banana plugs ..... **Cat. #5000.94**  
Probe - Black Test Probe ..... **Cat. #5000.97**  
Probe - Red Test Probe..... **Cat. #5000.98**  
Safety Alligator Clip (Black) ..... **Cat. #5000.99**  
Safety Alligator Clip (Red)..... **Cat. #5100.00**

---

## 2. PRODUCT FEATURES

---

The Clamp-On Meter Model 407 is a 10,000-count professional electrical measuring instrument that combines the following functions:

- Current measurement
- Inrush current / overcurrent (True InRush®) measurement
- Voltage measurement
- Frequency measurement
- Harmonic distortion (THD) measurement
- Harmonic rank value (A and V) up to the 25th
- Continuity test with buzzer
- Resistance measurement
- Power (W, VA, var and PF) and Energy measurements
- Crest Factor (CF), the Displacement Power Factor (DPF) and RIPPLE measurement
- Recording of data in memory; wireless transfer via Bluetooth to a PC

## 2.1 FRONT OF INSTRUMENT

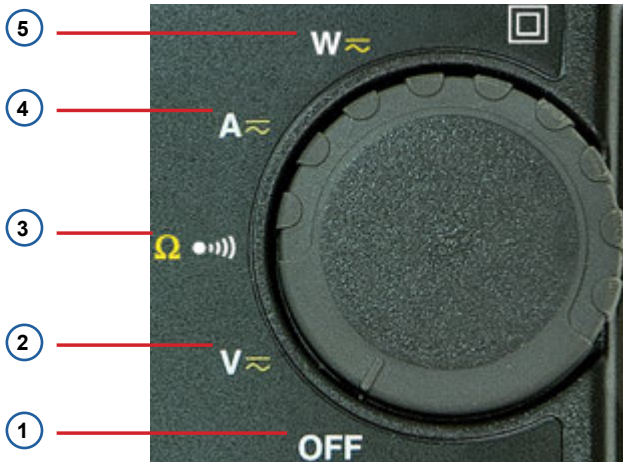

Figure 1

Item	Designation	See §
1	Jaws with centering marks (see connection principles)	4.5 to 4.13
2	Physical Guard	-
3	Rotary Function Switch	2.2
4	Function Buttons	3
5	Backlit Display	2.4
6	Input Terminals	2.5
7	Trigger	-

## 2.2 ROTARY SWITCH

The rotary switch has five positions. To access the **V $\sim$** ,  **$\Omega$  ●)))**, **A $\sim$** , and **W $\sim$**  functions, set the switch to the desired function. The functions are described in the table below.



**Figure 2**

Item	Function	See §
1	OFF mode – Turns the clamp-on meter off	4.3
2	AC, DC, AC+DC voltage measurement (V)	4.5
3	Continuity test ●)))	4.6
	Resistance measurement $\Omega$	4.7
4	AC, DC, AC+DC current measurement (A)	4.8
5	Power measurements (W, var, VA) AC, DC, AC+DC	4.10
	Power factor (PF), displacement power factor (DPF), and Energy Calculation	

## 2.3 FUNCTION BUTTONS

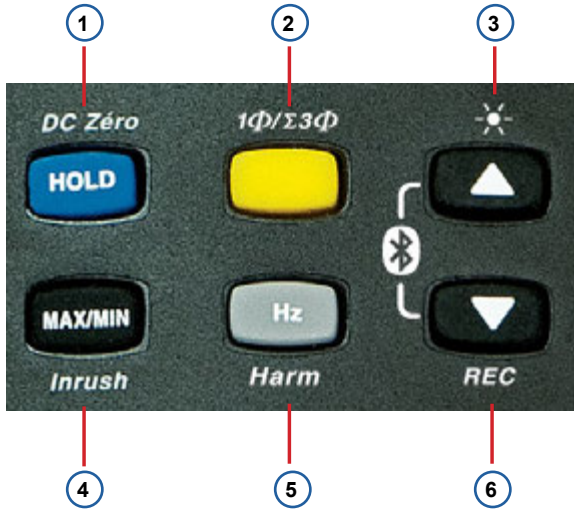

Figure 3

Item	Designation	See §
1	Holds the last value on the display Zero correction ADC/AAC+DC/WDC/WAC+DC	3.1 4.8.2
2	Selects the type of measurement and configuration functions (AC, DC, AC+DC) Selection of single-phase or 3-phase measurement	3.2
3	Enables/disables display backlighting Scrolls up the of orders of harmonics or of pages of results in W, MAX/MIN/PEAK Enables/disables Bluetooth wireless transfer (in combination with 6)	3.3
4	Enables/disables the MAX/MIN/PEAK mode Enables/disables the True InRush® mode in A	3.5
5	Measures frequency (Hz), total harmonic distortion (THD), and orders of harmonics Enables/disables the energy metering mode	3.6
6	Scrolls down the orders of harmonics or of pages of results in W, MAX/MIN/PEAK Enables/disables recording of current data in memory Enables/disables Bluetooth wireless transfer (in combination with 3)	3.4

## 2.4 DISPLAY

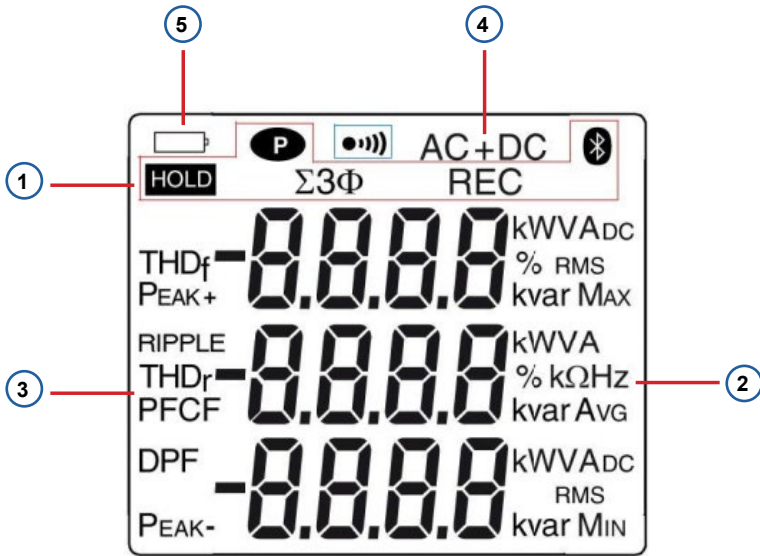





Figure 4

Item	Function	See §
1	Mode selection display	3
2	Active measurement value and unit display	4.5 to 4.13
3	Display of the MAX/MIN/PEAK modes	4.10
4	Type of measurement (AC or DC)	3.2
5	Low battery indication	6.2

### 2.4.1 Display Symbols

Symbol	Description
<b>AC</b>	Alternating current or voltage
<b>DC</b>	Direct current or voltage
<b>AC+DC</b>	Alternating and Direct current
<b>HOLD</b>	Storage of the values and display HOLD
<b>RMS</b>	RMS value
<b>Max</b>	Maximum DC or RMS value
<b>Min</b>	Minimum DC or RMS value

Symbol	Description
<b>AVG</b>	Means RMS value
<b>Peak+</b>	Maximum peak value
<b>Peak-</b>	Minimum peak value
<b><math>\Sigma 3\Phi</math></b>	Balanced total three-phase power measurement
<b>V</b>	Volt
<b>Hz</b>	Hertz
<b>W</b>	Active power
<b>A</b>	Ampere
<b>%</b>	Percentage
<b><math>\Omega</math></b>	Ohm
<b>m</b>	Milli- prefix
<b>k</b>	Kilo- prefix
<b>var</b>	Reactive power
<b>VA</b>	Apparent power
<b>PF</b>	Power factor
<b>DPF</b>	Displacement power factor ( $\cos \varphi$ )
<b>CF</b>	Crest factor
<b>RIPPLE</b>	Ripple (in DC)
<b>THDf</b>	Total harmonic distortion with respect to the fundamental
<b>THDr</b>	Total harmonic distortion with respect to the true RMS value of the signal
<b>REC</b>	Recording in memory
	Bluetooth wireless communication
	Continuity test
	Auto Power Off disabled
	Low battery indicator



### 2.4.2 Measurement Capacity Exceeded (OL)

The **OL** (Over Load) symbol is displayed when the display capacity is exceeded.

## 2.5 TERMINALS

The terminals are used as follows:

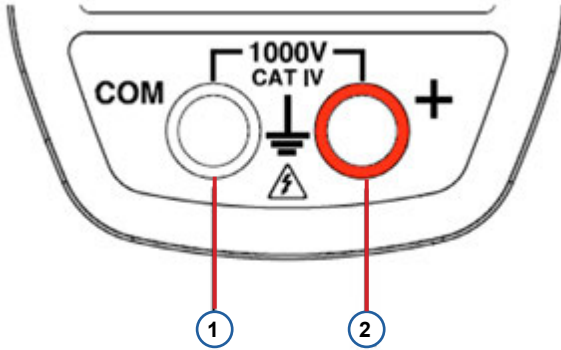

*Figure 5*

Item	Function
1	COM (black) Input Terminal Jack
2	+ Positive (red) Input Terminal Jack

## 3. FUNCTION BUTTONS







The buttons respond differently to short, long, and sustained presses.

In this section, the  icon represents the possible positions located on the rotary switch for each button's functionality.

### 3.1 BUTTON

The function of this button is to:

- Store and look up the last values acquired specific to each function (**V**, **A**, **Ω**, **W**) according to the specific modes previously activated (**MAX/MIN/PEAK**, **Hz**, **THD**). The present display is then maintained while the detection and acquisition of new values continues.
- Perform automatic zero correction in ADC/AC+DC and WDC/AC+DC (see § 4.8.2).

Successive presses on 		Function
short	   	<p><b>First Press:</b> Holds the last value displayed</p> <p><b>Second Press:</b> Returns to normal display mode (the value of each new measurement is displayed)</p>
long (> 2 sec)	ADC AAC+DC WDC WAC+DC	<p>Performs automatic zero correction (see 4.8.2)</p> <p><b>NOTE:</b> This mode operates if the MAX/MIN/PEAK or HOLD modes (short press) are first deactivated.</p>

See § 2.5.3 and § 2.6.3 for the  button functionality in combination with the  and  buttons.







### 3.2 YELLOW (SECOND FUNCTION) BUTTON

This button is used to select the type of measurement (AC, DC, AC+DC) and the second functions marked in yellow next to the relevant positions of the rotary switch.

It can also be used to modify the default values in the configuration mode (see § 4.4).









**NOTE:**  is invalid in the **MAX/MIN/PEAK** and **HOLD** modes.

Successive presses on 		Function
short		- Selects AC, DC OR AC+DC. Depending on your choice, the screen displays AC, DC OR AC+DC
		- Toggles the continuity  and Ohm $\Omega$ modes
long (> 2 sec)		- Displays the total three-phase power of a balanced system ( $\Sigma 3\Phi$ is displayed) - Press again to return to the display of the single-phase power ( $\Sigma 3\Phi$ is off)

### 3.3 BUTTON

This button is used to:















- Scroll up through the order of harmonics or successive pages
- Activate the backlighting
- Activate the Bluetooth function

Successive presses on 		Function
short		- Scrolls through the various pages of measurement results, depending on the function and possibly the active mode (MAX/MIN/PEAK or THD/Harmonics)
long (> 2 sec)		- Enables/disables the backlighting of the display <b>NOTE:</b> The backlight turns off automatically after 2 min.
combined with the  button		- Activates Bluetooth wireless communication - The  symbol is displayed <b>NOTE:</b> Activation of the Bluetooth mode automatically stops the recording of the data.

### 3.4 BUTTON

This button is used to:

- Scroll down through the orders of harmonics or successive pages
- Activate the recording of the data
- Activate the Bluetooth function

Successive presses on 		Function
short	  	- Scrolls through the various pages of measurement results, depending on the function and possibly the active mode (MAX/MIN/PEAK or THD/Harmonics)
long (> 2 sec)	   	- Enables/disables the recording of the data - The <b>REC</b> symbol is then displayed <b>NOTE:</b> When the recording memory is full, the REC symbol flashes.
combined with the  button	   	- Activates Bluetooth wireless communication - The  symbol is the displayed <b>NOTE:</b> Activation of the Bluetooth mode automatically stops the recording of the data.

### 3.5 BUTTON





#### 3.5.1 Normal Mode

This button activates the detection of the **MAX**, **MIN**, **PEAK+** and **PEAK-** or **AVG** values of the measurements generated.





MAX and MIN are the extreme mean values in DC and the extreme RMS values in AC. Peak+ is the maximum instantaneous peak and Peak- is the minimum instantaneous peak.

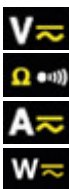

**NOTE:** In this mode, the **Auto Power Off** function of the device is automatically disabled. The  symbol is displayed on the screen.

Successive presses on 		Functions
short		<ul style="list-style-type: none"> <li>- <b>First press:</b> Activates detection of the MAX/MIN/AVG and PEAK values and displays MAX/AVG and MIN values</li> <li>- <b>Second press:</b> Displays the PEAK+, AVG, and PEAK- values (on a second screen)</li> <li>- <b>Third press:</b> Displays MAX/AVG and MIN values without exiting from the mode (the values already detected are not erased)</li> </ul> <p><b>NOTE:</b> Depending on the mode, AC or DC, the crest factor (CF), harmonics, frequency, and RIPPLE are also available.</p>
		<ul style="list-style-type: none"> <li>- Activates the detection of MAX/MIN/ AVG values</li> <li>- Displays the MAX, MIN and AVG value successively</li> <li>- Returns to the display of the present measurement without exiting from the mode (the values already detected are not erased)</li> </ul>
long (> 2 sec)		<ul style="list-style-type: none"> <li>- Exits the MAX/MIN/PEAK mode. The values previously recorded are then erased</li> </ul> <p><b>NOTE:</b> If the HOLD function is enabled, it is not possible to exit from the MAX/MIN/ PEAK mode. The HOLD function must first be disabled.</p>

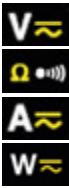
### 3.5.2 MAX/MIN Mode + Activation of the HOLD Mode

Successive presses on 		Function
short		<ul style="list-style-type: none"> <li>- Displays the MAX, AVG, MIN and PEAK+, AVG, PEAK- values detected before the  button was pressed.</li> <li>- When the  button is pressed, the last value is held on the display.</li> </ul>









**NOTE:** The **HOLD** function does not interrupt the acquisition of new MAX/MIN/PEAK values.

### 3.5.3 Access to True InRush® Mode ( set switch to )

This button allows measurement of the True InRush® current (starting current, or overcurrent in steady-state operation) for AC or DC current only.



**NOTE:**  is not operational for AC+DC current.

Successive presses on 		Function
long (> 2 sec)		<ul style="list-style-type: none"> <li>- <b>First press:</b> Enters the True InRush® mode</li> <li>- <b>Inrh</b> is displayed for 3 sec (the backlighting blinks)</li> <li>- The triggering threshold is displayed for 5 sec (the backlighting is steady)</li> <li>-  is displayed and the <b>A</b> symbol flashes (the backlighting turns off).</li> <li>- After detection and acquisition, the Inrush current measurement is displayed, after the calculations stage  (backlighting turns off)</li> </ul> <p><b>NOTE:</b> The <b>A</b> symbol flashes to indicate <b>surveillance</b> of the signal.</p> <ul style="list-style-type: none"> <li>- <b>Second press:</b> Exits the True InRush® mode (returns to simple current measurement)</li> </ul>
short (< 2 sec) <b>NOTE:</b> A short press is functional only if a True InRush® value has been detected.		<ul style="list-style-type: none"> <li>- Displays the PEAK+ value of the current</li> <li>- Displays the PEAK- value of the current</li> <li>- Displays the RMS True InRush® current</li> </ul> <p><b>NOTE:</b> The <b>A</b> symbol is displayed during this sequence.</p>











### 3.6 BUTTON

This button is used to display the frequency measurements of a signal, of the power, and of the level and orders of harmonics.









**NOTE:** This button is not functional in the DC mode.





### 3.6.1 Normal Mode

Successive presses on 		Function
short	 	<p>Displays:</p> <ul style="list-style-type: none"> <li>- The frequency of the signal, the RMS measurement, and the DC component</li> <li>- The crest factor CF, the RMS measurement, and the DC component</li> </ul>
long (> 2 sec)	 	<ul style="list-style-type: none"> <li>- Enters or exits the THD calculation and display mode</li> <li>- Displays the THDf, the THDr, and the RMS value</li> <li>- The  and  buttons are used to display each order of harmonic (25 orders, from h01 to h25), with the associated harmonic distortion (with respect to the fundamental) and the RMS value of order hxx</li> </ul> <p><b>NOTE:</b> Order <b>hdC</b> (displayed in the DC and AC+DC modes) is the DC component; order <b>h01</b> is the fundamental.</p>
		<ul style="list-style-type: none"> <li>- Starts/Stops the energy metering mode</li> <li>- Displays the various energy parameters</li> <li>- The  and  buttons are used to display the status and energy metering measurement results pages</li> </ul>

### 3.6.2 Harmonic Order Display or +

Successive presses on 		Function
short	 	<ul style="list-style-type: none"> <li>- <b>First press:</b> Displays the frequency of the harmonic order previously selected using the  and  buttons, instead of order hxx</li> <li>- <b>Second press:</b> Restores the display of order (hxx or hdC)</li> </ul>

### 3.6.3 Hz Function + Activation of the HOLD Mode

<b>Successive presses on</b> 		<b>Function</b>
short	 	- Stores and displays the frequency with the RMS value and the DC component, then on a 2nd consecutive page, the crest factor <b>NOTE:</b> The values displayed are those measured before the  button is pressed.



---

## 4. USE

---

### 4.1 INSTALLING THE BATTERIES

Insert the batteries supplied with the device as follows:

1. Using a screwdriver, unscrew the battery compartment cover (1) from the back of the housing.
2. Insert the (4) 1.5 V AA batteries supplied (2), observing polarities.
3. Close the battery compartment cover and screw it onto the housing.

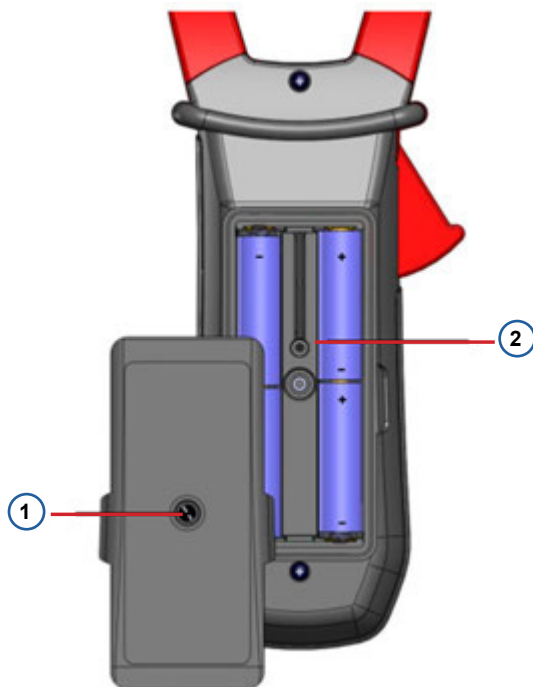

**Figure 6: Battery Compartment**

### 4.2 TURNING ON THE INSTRUMENT

- With the rotary switch set in the OFF position, turn the switch to the desired function. The display lights (all symbols) for a few seconds (see § 2.4), then the screen of the function chosen is displayed.
- The clamp-on meter is now ready to make measurements.

## 4.3 TURNING OFF THE INSTRUMENT

The clamp-on meter can be turned off in two way.

- Manually - Turn the switch to the OFF position.
- Automatically - After ten min with no activity, the instrument will turn OFF. Thirty (30) sec before the device is switched off, an audible signal sounds intermittently. To re-activate the device, press any button or turn the rotary switch.

## 4.4 CONFIGURATION

As a safety measure, and to avoid repeated overloads on the inputs of the meter, configuration operations should only be performed when the meter is disconnected from all dangerous voltages.

### 4.4.1 Auto Power Off

The Auto Power Off feature is enabled by default. To disable it, perform the following:

1. In the OFF position, hold the **HOLD** button down while turning the switch to **V $\approx$**  until the **full screen** display ends and a beep is emitted. The **P** symbol is displayed.
2. When the **HOLD** button is released, the device is in the voltmeter function in the normal mode.
3. To return to Auto Power Off, turn the meter OFF and then back ON.

### 4.4.2 Current Threshold for True InRush® Measurement

To configure the triggering current threshold of the True InRush® measurement:

1. In the OFF position, hold the **MAX/MIN PEAK** button down while turning the switch to **A $\approx$**  until the **full screen** display ends and a beep is emitted. The display will indicate the percentage overshoot to apply to the measured current to determine the measurement triggering threshold. The value stored by default is 10 %, representing 110 % of the established current measured. The possible values are (5, 10, 20, 50, 70, 100, 150 and 200) %.
2. To change the threshold, press the **[ ]** button. The value flashes; each press on the **[ ]** button displays the next value. To record the chosen threshold, apply a long press (> 2 sec) on the **[ ]** button. A confirmation beep is emitted.

To exit from the configuration mode, turn the switch to another setting. The chosen threshold is stored and a double beep is emitted.





**NOTE:** The starting (Inrush) current measurement triggering threshold is fixed at 1 % of the least sensitive range.

This value is 1 % of 99.99 A or 1 A. This threshold is not adjustable.

---

### 4.4.3 Recording Duration



To configure the triggering current threshold of the True InRush® measurement:

1. In the OFF position, hold the  button down while turning the switch to  until the end of the **full screen** display and the emission of a beep, to enter the configuration mode. The display will then indicate the recording interval.



**NOTE:** The default value is 60 sec. Possible values range from ( 1 to 600) sec (10 mins).

---

2. To change the recording interval, press the  button. The right-hand digit blinks. Each press on the  button increments its value. To go to the next digit, apply a long press (> 2 sec) to the  button.
3. When the desired unit is displayed, turn the switch to another setting. The unit chosen is stored and a double beep is emitted.



### 4.4.4 Erasing Recordings from Memory

To erase a recording from memory, perform the following:





**NOTE:** Make sure there is no voltage on the input terminals.

---

1. In the OFF position, hold the  button down while turning the switch to  .
2. The device emits a beep after erasing the records in memory. The **rSt** and **rEC** symbols are displayed.
3. The device then switches to normal continuity measurement.

### 4.4.5 Default Configuration

To reset the clamp-on meter to its default parameters (factory configuration):

1. In the OFF position, hold the  button down while turning the switch to  , until the **full screen** display ends and a beep is emitted. The **rSt** symbol is displayed.
2. After 2 sec, the clamp-on meter emits a double beep, then all of the digital symbols of the screen are displayed until the  button is released. The default parameters are then restored:
  - Recording interval = 60 sec
  - Continuity detection threshold = 40 Ω
  - True InRush® triggering threshold = 10 %

## 4.5 VOLTAGE MEASUREMENT (V)

To measure voltage, proceed as follows:

1. Set the switch to **V** .
2. Connect the black lead to the **COM** terminal and the red lead to the **+** terminal.
3. Connect the test probes or the alligator clips to the circuit to be measured. The device selects AC or DC automatically according to which measured value is larger. The AC or DC symbol displays blinking in auto detect mode.

To select AC, DC or AC+DC manually, press the  button to toggle between them. The symbol corresponding to the choice will then display.

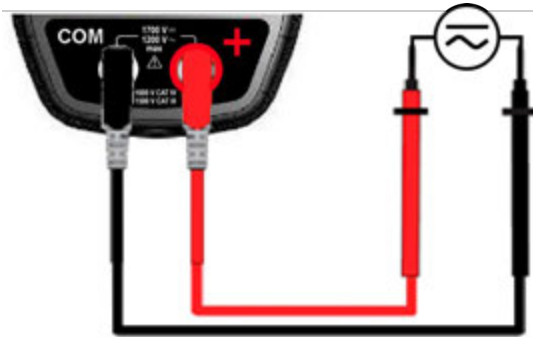

The measured value is displayed:

In DC:

Display	Quantity
1st row	Voltage V RMS
2nd row	DC RIPPLE in %
3rd row	DC voltage component, V DC

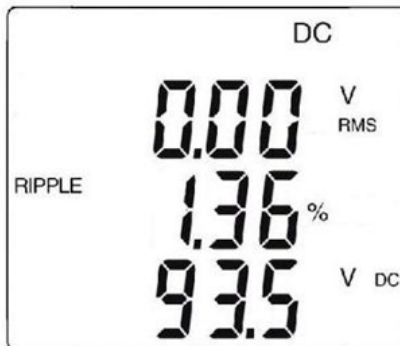

**In AC and AC+DC:**

Display	Quantity
1st row	Total RMS voltage V RMS or TRMS
2nd row	Crest factor (CF)
3rd row	DC voltage component, V DC



**4.6 CONTINUITY TEST (•••))**



**WARNING:** Before performing the test, make sure that the circuit is **OFF** and all capacitors have been discharged.

1. Set the rotary switch to ; the (•••)) symbol is displayed.
2. Connect the black lead to the **COM** terminal and the red lead to the **+** terminal.
3. Connect the test probes or the alligator clips to the circuit or component to be measured.

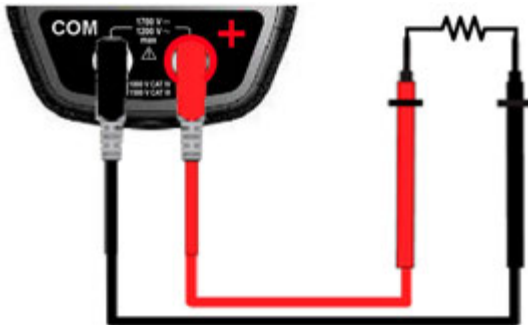

An audible signal is emitted if there is continuity and the measured value is displayed on the screen.

## 4.7 RESISTANCE MEASUREMENT $\Omega$



**WARNING:** Before making a resistance measurement, make sure that the circuit is off and all capacitors have been discharged.

1. Set the switch to  $\Omega$  and press the button. The  $\Omega$  symbol is displayed.
2. Connect the black lead to the **COM** terminal and the red lead to the **+** terminal.
3. Connect the test probes or the alligator clips to the circuit or component to be measured.

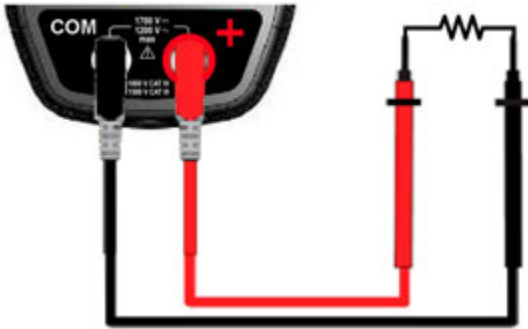

The measured value is displayed on the screen.

## 4.8 CURRENT MEASUREMENT (A)

The jaws are opened by pressing the trigger on the body of the meter. The arrow on the jaws of the clamp-on meter (see the following diagram) should point in the presumed direction of current flow, from the generator to the load. Make sure that the jaws have closed correctly after clamping around the conductor.





**NOTE:** The measurement results are optimal when the conductor is centered in the jaws (aligned with the centering marks).

The device selects AC or DC automatically according to which measured value is larger. The AC or DC symbol displays blinking in auto detect mode.

### 4.8.1 AC Measurement

For an AC current measurement, proceed as follows:

1. Set the switch to **A** , and select AC by pressing the  button. The AC symbol is displayed.

Clamp the jaws around the conductor to be measured. The device selects AC or DC automatically.

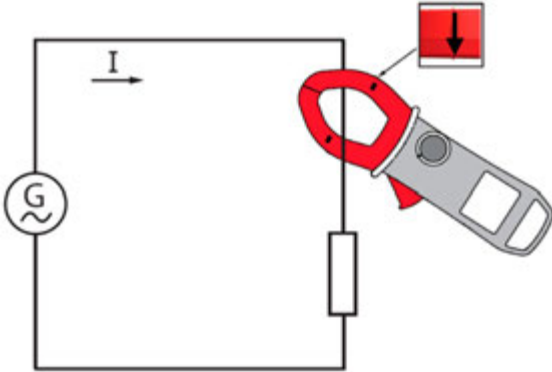

The measured values are displayed on the screen.

Display	Quantity
1st row	RMS current A RMS
2nd row	Crest factor (CF)
3rd row	DC current component A DC

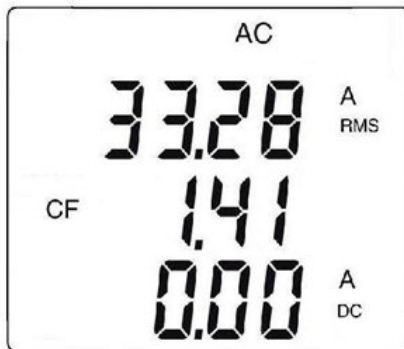

## 4.8.2 DC or AC+DC Measurement

Set the switch to **A $\approx$**  and select **DC** if the display does not indicate **0**; the DC zero must be corrected first.

### Step 1: Correction of DC Zero

**Important:** The clamp must not be closed on the conductor during the DC zero correction. Hold the clamp in the same position during the whole procedure so that the correction value will be exact.

Press the **HOLD** button until the device emits a double beep and displays a value near **0**. The correction value is stored until the clamp is powered down.



**NOTE:** The correction is effected only if the value displayed is  $< \pm 20$  A, otherwise the value displayed blinks and is not stored. The clamp must be recalibrated (see § 6.4).

---

### Step 2: Make a Measurement

1. The switch is set to **A $\approx$** . Select **DC** or **AC+DC** by pressing the **YELLOW** button until the desired choice is reached.
2. Clamp the jaws around the conductor to be measured.

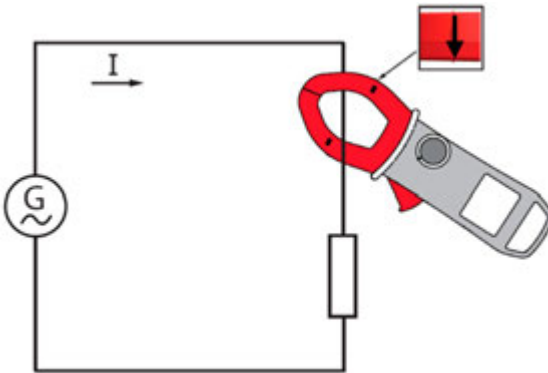

The measured values are displayed:



**In DC:**

Display	Quantity
1st row	Current A RMS
2nd row	DC RIPPLE in %
3rd row	DC current component A DC

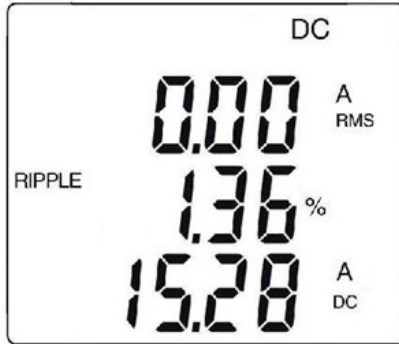

**In AC and AC+DC:**

Display	Quantity
1st row	Total RMS current A RMS or TRMS
2nd row	Crest factor (CF)
3rd row	DC current component, A DC

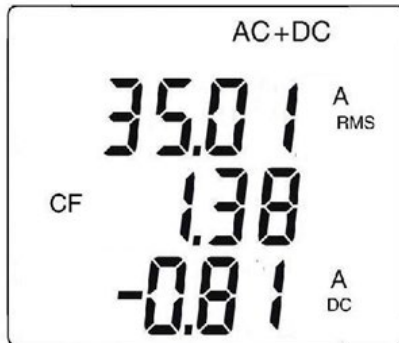

## 4.9 CURRENT OR OVERCURRENT (TRUE INRUSH®) MEASUREMENT



**NOTE:** The measurement can be made only in AC or DC mode (AC+DC mode disabled).

To measure a starting current or overcurrent, proceed as follows:

1. Set the switch to **A**, correct the **DC zero** (see § 4.8.2), then clamp the jaws around the conductor to be measured.
2. Perform a long press on the **MAX/MIN PEAK** button. The **InRh** symbol is displayed, along with the triggering threshold. The clamp then awaits detection of the True InRush® current. **----** is displayed and the **A** symbol flashes.
3. After detection and acquisition for 100 ms, the RMS value of the True InRush® current is displayed. Pressing the **MAX/MIN PEAK** button will display the **PEAK+/PEAK-** values subsequently.
4. A long press on the **MAX/MIN PEAK** button or a change of function on the rotary switch will exit the True InRush® mode.



**NOTE:** The triggering threshold in A is 20 A if the initial current is zero (starting of installation). For an established current (overload in an installation) see § 4.4.2.

Display	Quantity
1st row	Inrh
2nd row	True Inrush value in A
3rd row	Triggering threshold in A

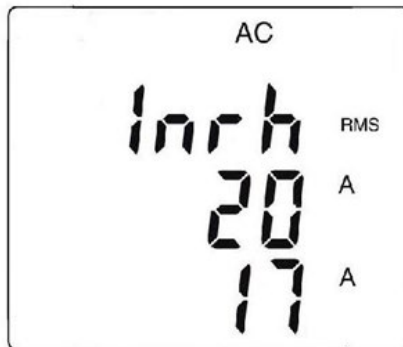

## PEAK:

Display	Quantity
1st row	Inrh
2nd row	PEAK+ OR PEAK- value in A
3rd row	Triggering threshold in A

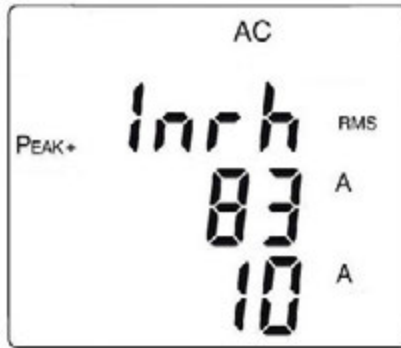

### 4.10 POWER MEASUREMENT W, VA, VAR AND PF

This measurement is possible in single-phase or in balanced 3-phase.



**NOTE:** If performing DC or AC+DC power measurements, correct the DC zero in current first (see § 4.8.2).

For the power factor (PF) and VA and var, the measurements possible are only available in AC or AC+DC modes.

#### 4.10.1 Single-Phase Power Measurement

1. Set the switch to **W** and select **VA**, **var**, or **PF** by pressing the **Hz** button until the desired choice is reached.
2. The device automatically displays **AC+DC**. To select AC, DC, or AC+DC, press the **Hz** button until the desired choice is reached.
3. Connect the black lead to the **COM** terminal and the red lead to the **+** terminal.

4. Connect the test probes or the alligator clips of the black lead on the neutral (N), then those of the red lead on the L phase.
5. Clamp around only the corresponding conductor, respecting the direction.

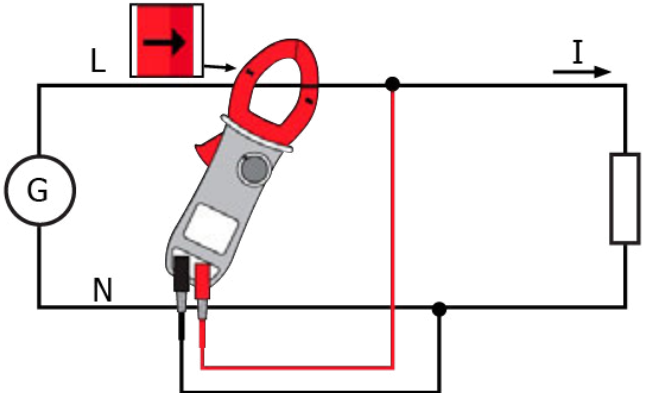

The measurement is displayed on screen.

Display	Quantity
1st row	Active power W (DC, AC or AC+DC)
2nd row	Reactive power var (AC or AC+DC)
3rd row	Apparent power VA (AC or AC+DC)



## 4.10.2 Balanced 3-Phase Power Measurement

1. Set the switch to **W<sub>R</sub>**.
2. Press the **Σ3Φ** button until the **Σ3Φ** symbol is displayed.
3. The device automatically displays **AC+DC**. To select AC, DC, or AC+DC, press the **AC/DC** button until the desired choice is reached.
4. Connect the black lead to the **COM** terminal and the red lead to the **+** terminal.
5. Connect the leads and the clamp to the circuit as follows:

If the red lead is connected to...	...and the black lead is connected to	...then the clamp is on the conductor of the
L1 phase	L2 phase	L3 phase
L2 phase	L3 phase	L1 phase
L3 phase	L1 phase	L2 phase



**NOTE:** The arrow on the jaws of the clamp (see the diagram below) must point in the presumed direction of flow of the current from the source (producer) to the load (consumer).

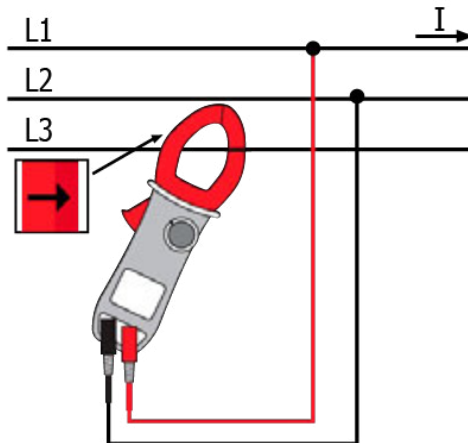

The measurement is displayed on screen.



**NOTE:** The 3-phase power on a balanced 4-wire network can also be measured by proceeding in the same way, or by proceeding as for the measurement on a single-phase network, then multiplying the value by three.

### 4.10.3 Four Quadrant Diagram

In order to correctly determine the sign of the active and reactive powers, refer to the diagram below, which determines:

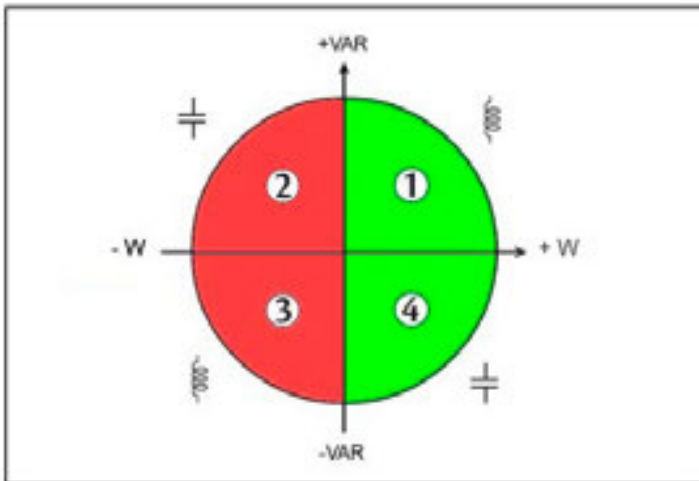

- positive active power (W) = power consumed
- negative active power = power generated
- reactive power (var) and active power of the same sign = inductive power
- reactive power and active power of opposite signs = capacitive power



## 4.11 ENERGY METERING MEASUREMENT

The Energy Metering measurement is available in **W** for the AC and AC+DC quantities. The energy meters start and totalize the various types of energy (the eight energy meters - 4 meters of energy consumed and 4 meters of energy generated - are started).

To measure the energy metering, proceed as follows:

1. Set the switch to **W** .
2. Press the  (long press). Start-up screen 1 in the Energy Metering mode appears. The display reads **Counting Off**.



3. Connect the black lead to the **COM** terminal and the red lead to the **+** terminals.
4. Place the test probes or the alligator clips of the black lead on the neutral (**N**), then those of the red lead on the **L** phase.
5. Clamp around only the corresponding conductor, respecting the direction of current flow (see § 4.10).
6. To start the metering, press the  button. The display reads **Counting On**.

The metering sequence is as follows:



**The status of each meter is:**

- On <=> metering in operation
- Off <=> metering stopped (values of the meters 0)
- Stop <=> metering stopped (values of the meters preserved)

Hour meter page:

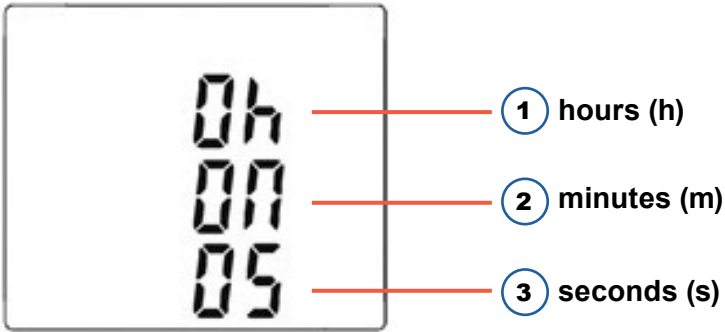

The duration of the metering uses the following format: **XXXh** (for hours) **XXm** (for minutes) **XXs** (for seconds).



**NOTE:** Beyond 999 h 59 m 59 s **--h--m--s** is displayed, but the internal metering duration keeps running correctly.

View of the set of screens concerning Energy measurement by short presses on **▲** or **▼** buttons:

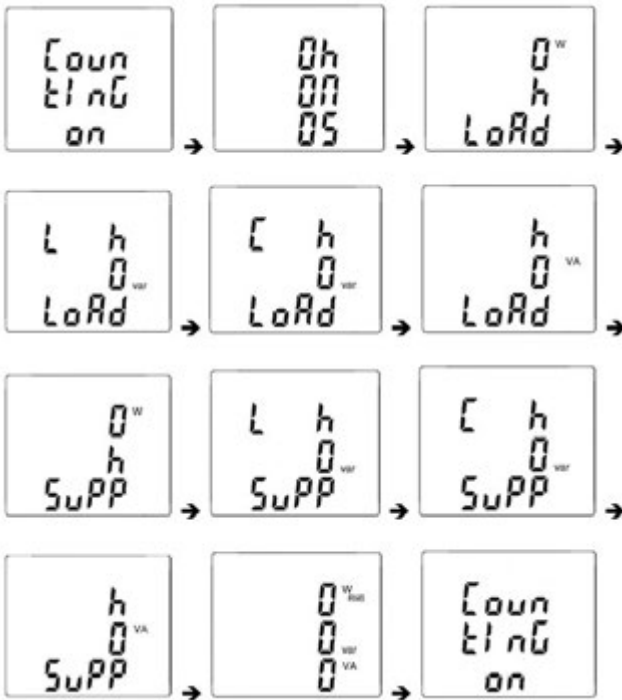



## Conventions:

**Load** designates the consumed energy by the load (W+)

**Load C** designates the capacitive reactive energy (W+ and var-)

**Load L** designates the inductive reactive energy (W+ and var+)

**Supp** designates the energy generated by the load (W-)

**Supp C** designates the capacitive reactive energy (W- and var-)

**Supp L** designates the inductive reactive energy (W- and var+)

7. To access the screens concerning the energies received by the load (**Load side**), press the  button to view each screen that has the term **LoAd** at the bottom of the screen.

The sequence of use is as follows:

I- Load h W ---> Load L h VAR ---> Load C h VAR ---> Load h VA ---> I  
| <-----|

### Example of LoAd side screen:

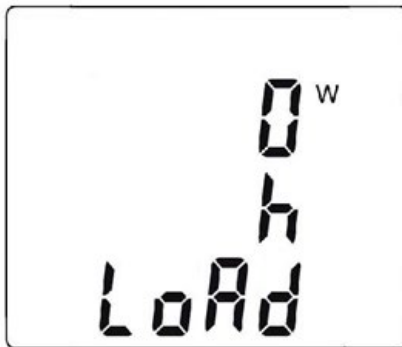

8. To access the screens concerning the energies generated by the load and therefore received by the source (**Supply side**), press the  button to view the screens that have the term **SuPP** at the bottom of the screen.

The sequence of use is as follows:

I - Supp h W ---> Supp L h VAR ---> Supp C h VAR ---> Supp h VA ---> I  
| <-----|

## Example of SuPP side screen:



The energy displays use the following formats:



- [000.1 ; 999.9]
- [1.000 k ; 9999 k]
- [10.0 M ; 999 M]
- [1.00 G ; 999 G]

## 4.12 FREQUENCY MEASUREMENT (HZ)

The frequency measurement is available in **V**, **W** and **A** for AC and AC+DC measurements. The measurement is based on a count of zero crossings (positive-going edges).

### 4.12.1 Frequency Measurement (V)

To measure the frequency in voltage, proceed as follows:

1. Set the switch to **V**  and press the **Hz**  button. The **Hz** symbol is displayed.
2. Select AC by pressing the  button until the desired choice is reached.
3. Connect the black lead to the **COM** terminal and the red lead to the **+** terminal.

4. Connect the test probes or the alligator clips to the circuit to be measured.

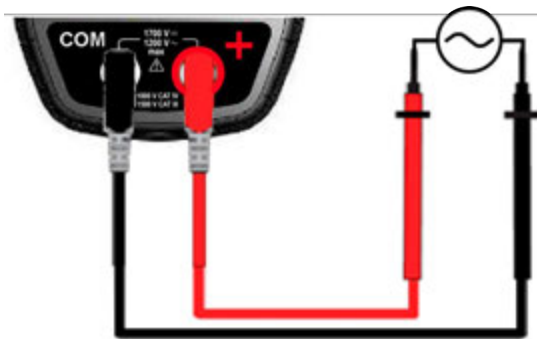

The measured value is displayed on the screen.

#### 4.12.2 Frequency Measurement (A)

1. Set the switch to **A** and press the **Hz** button. The **Hz** symbol is displayed.
2. Select AC or AC+DC by pressing the **Hz** button until the desired choice is reached.
3. Clamp the jaws around the conductor to be measured.

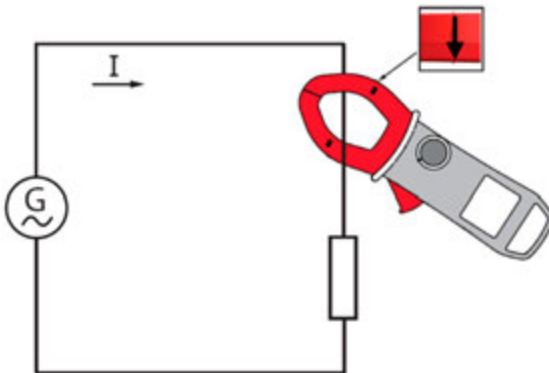

The measured value is displayed on the screen.

## 4.13 TOTAL HARMONIC DISTORTION (THD) MEASUREMENT AND HARMONICS ORDER DISPLAY

The device measures the total harmonic distortion with respect to the fundamental (THD<sub>f</sub>), the total harmonic distortion with respect to the true RMS value of the signal (THD<sub>r</sub>) in voltage and in current, then the level (with respect to the fundamental), frequency, and RMS value of each order of harmonic.

The frequency of the fundamental is determined by digital filtering and FFT for the network frequencies of (50, 60, 400 and 800) Hz.

### 4.13.1 THD (V) Measurement

1. Set the switch to **V** and press and hold (> 2 sec) the **Hz** button. The **THD<sub>f</sub>**, **THD<sub>r</sub>** and **V RMS** symbols are displayed.
2. Connect the black lead to the **COM** terminal and the red lead to the **+** terminal.
3. Place the test probes or the alligator clips on the terminals of the circuit to be measured.

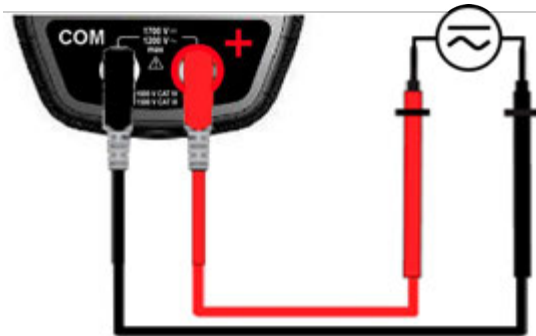

The measured value is displayed on the screen

### 4.13.2 THD (A) Measurement

1. Set the switch to **A** and press and hold (> 2 sec) the **Hz** button. The **THD<sub>f</sub>**, **THD<sub>r</sub>** and **A RMS** symbols are displayed.



**NOTE:** First press the **Hz** button to place the meter in AC current measurement mode.

2. Apply the clamp to only the conductor concerned.

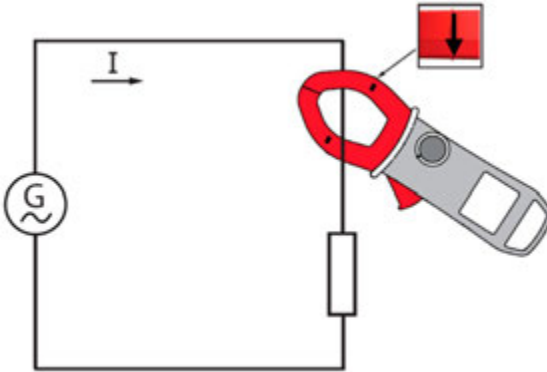

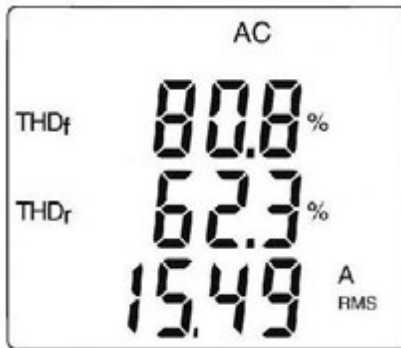

The measured value is displayed on the screen



### 4.13.3 Individual Harmonics and Frequency of the Fundamental from DC to the 25th

In the context of measurement of the THDs in voltage (§ 4.13.1) and in current (§ 4.13.2):

1. Press the  button. Order **hdC** is displayed (DC component), only in DC or AC+DC. The harmonics of higher orders are displayed sequentially as the  button is pressed repeatedly. The  button can be pressed to return to the previous order.

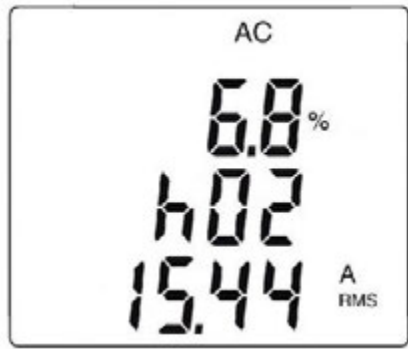

2. The  button can be pressed to display the frequency of the order of harmonic concerned.

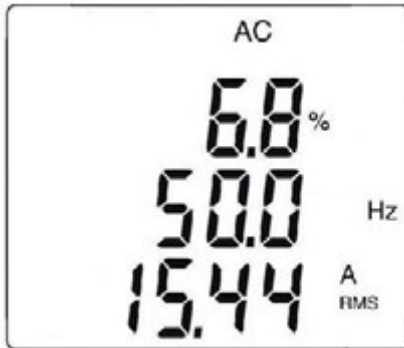

### 4.14 RECORDING

The power meter allows recording of the data/measurements using the **REC** function. The default recording interval is 60 secs. It can be configured (see § 4.4.3) from 1 sec to 600 sec (10 mins).

1. First, select the function to be measured using the rotary switch, then apply a long press (> 2 s) to the  button. The **REC** symbol is displayed. Recording of the measurement starts. The data recorded is in the format: **MAX value – AVG Value – MIN Value – Unit – Mode** (AC or AC+DC).



**NOTE:** The meter does not record pure DC measurements.

- To stop recording, apply a long press (> 2 sec) to the button. The **REC** symbol disappears.



**NOTE:** Recording is interrupted automatically when the memory of the device is full (**REC** symbol is flashing) or Bluetooth wireless communication is activated (§ 4.15).

Type of data	Max number of records	Max recording time at 1 sec intervals	Max recording time at 600 sec (10 min) intervals
V, A, $\Omega$	1000	16 m	160 h
W	200	3 m	35 h
THD	300	5 m	55 h
Harmonics	470	8 m	80 h

## 4.15 CONNECTING TO A COMPUTER

### 4.15.1 Bluetooth Connection

The Model 407 is equipped with Bluetooth connectivity for downloading, displaying and deleting recorded data in the instrument's memory.

The instrument is supplied with a Bluetooth USB adapter for use with computers without Bluetooth capability. If this is the case, connect the adapter to an available USB port on your computer. The default Windows driver will automatically install the device.

The instrument must be paired to the computer before connecting to the DataView® software (see § 4.21). The pairing procedure varies depending on your operating system, Bluetooth equipment and driver software.



**NOTE:** The information in the following sections is only necessary the first time an instrument is connected, or when the Bluetooth USB adapter has been removed then reconnected.

### 4.15.2 Bluetooth Connection

The following steps are for pairing using Windows 7.

- In the active measurement function, press the and buttons simultaneously. The symbol will appear in the upper right corner of the display.
- Connect the supplied Bluetooth USB Adapter into an available USB port. Windows will install any necessary drivers automatically.
- A Bluetooth symbol (similar to this: ) will appear in the system tray at the bottom of your screen once the driver is installed.

4. Right click on the icon and select **Add a Device**.
5. In the **Add a Device** window, select the instrument you wish to connect and select **Next**.



**NOTE:** Depending on the Bluetooth setup and operating system, it may be necessary to enter a passkey to finalize the instrument connection. If so, the default passkey is **0000**.

---



6. If asked for a pairing code select **Enter the Device's pairing code**.
7. Enter the pairing code as shown below and select **Next**.
8. Once the instrument has been successfully added to the computer, a window will be displayed. Select **Close**.
9. You should see the Device listed in the Bluetooth devices window.
10. Launch the DataView® PowerPad Control Panel by clicking the  icon in the DataView folder placed on the desktop during software installation. Refer to § 4.21 for DataView® software installation. The instrument should automatically connect if only one power meter is paired. If more than one instrument is paired, select the instrument you wish to connect to from the drop-down list in the connection window.
11. Selecting **OK** will establish the connection between the power meter and the DataView® software. It is now possible to view the instrument status and downloaded data. If data is present in the instrument's memory, the software will automatically start downloading once connected.

## 4.16 BLUETOOTH ON/OFF

Bluetooth can only be turned on or off when the instrument is not recording.

To enable the Bluetooth press the  and  buttons simultaneously. The

 symbol should appear in the upper right corner of the display. To disable

Bluetooth press the  and  buttons simultaneously; the  symbol will turn OFF.

## 4.17 RECORDING DATA

### 4.17.1 Starting a Recording Session



**NOTE:** A new recording cannot be started if the memory is full or if the Bluetooth is active.

---

1. Configure the instrument as described in § 4.4.
  2. Select the measurement function to be recorded using the rotary switch and connect the instrument to the measurement source.
  3. Press the **REC** button for > 2 sec to start a recording.
  4. The **REC** indication will remain solid when there is available memory or it will blink if the memory is full.
  5. If the memory is partially full then it is possible to start another recording. The duration of the recording will depend on the available memory.
-



## 4.17.2 Stopping a Recording Session

1. Press and hold the **REC** button for > 2 secs.
2. The **REC** indication will not be displayed if a recording is not active.



## 4.18 DOWNLOADING RECORDED DATA

Recorded measurements stored in the instrument are transferred to a computer via the download command in the DataView® PowerPad Control Panel.

## 4.19 ERASING DATA FROM MEMORY

Erasing data from the instrument's memory can be performed in two ways.

### Erasing Memory using the button and rotary switch:

1. Turn the instrument **OFF**.
2. Press and hold the  button while rotating the rotary switch to the **Ω** position.
3. Release the  button when **RST REC** is displayed to erase the memory.

### Erasing Memory using the DataView® PowerPad Control Panel:

1. Connect the instrument to the computer and launch the PowerPad Control Panel. (**NOTE:** this is different from the PowerPad III Control Panel.)
2. Select **View Recorded Data** from the Instrument menu.
3. In the **Recorded Data in Instrument** window, select the **Select All** button and click on **Delete All** to erase the memory.

## 4.20 DATA STORAGE

The Model 407 captures Trend measurements at a user specified interval.

### 4.20.1 Trend Measurements

The Model 407 stores the measurement of each of the inputs. In addition, the user can define the storage rate and type of measurement.

### 4.20.2 Recording with Memory Cleared

When a recording starts, the power meter will continue to record until one of the following occurs:

- The memory becomes full.
- A manual press of the **REC** button for > 2 sec is performed.
- The battery voltage is not sufficient to keep the instrument powered.

### 4.20.3 Recording with a Partial or Full Memory

It is possible to have more than one recording provided as there is sufficient memory. The duration of the additional recording will depend on the sample rate of the recording, amount of memory left and type of recording.

## 4.20.4 Memory Filled During Recording Session

If the memory becomes full, the **REC** indication on the display will blink. It will be necessary to download and erase the memory before a new recording can be started.

## 4.21 DATAVIEW® INSTALLATION

1. **Insert** the USB drive that comes with the instrument into a USB port on your computer.
2. If Autorun is enabled, an AutoPlay window appears on your screen. **Click Open folder to view files** to display the DataView folder. If Autorun is not enabled or allowed, use Windows Explorer to locate and open the USB drive labeled **DataView**.
3. When the DataView folder is open, **Double-click** the file **Setup.exe** in the root directory.
4. The Setup screen appears. This enables you to select the language version of the setup program. You can also select additional install options (each option is explained in the Description field). Make your selections and **Click Install**.
5. **Click OK** to confirm setup. The InstallShield Wizard screen appears. This program leads you through the DataView® install process. As you complete these screens, be sure to **check PowerPad** when prompted to select features to install.
6. When the InstallShield Wizard finishes installing DataView®, the Setup screen appears. **Click Exit** to close. The DataView folder appears on your computer desktop.
7. Open the DataView folder on your desktop. This displays a list of icons for DataView and/or the Control Panel(s) installed.
8. Open the PowerPad Control Panel by **Clicking** the  icon.
9. In the menu bar at the top of the screen, select **Help**. In the drop-down menu that appears, **Click** the option **Help Topics**. This opens the PowerPad Control Panel Help system. Find and follow the instructions for connecting the instrument to the computer.

For instructions about using DataView® with the instrument, consult the PowerPad Control Panel Help system.

## 5. SPECIFICATIONS

### 5.1 REFERENCE CONDITIONS

Quantities of Influence	Reference Conditions
Temperature:	23 °C ± 2 °C
Relative humidity:	(45 to 75) %
Supply voltage:	6.0 V ± 0.5 V
Frequency range of the applied signal:	(45 to 65) Hz
Sine wave:	pure
Peak factor of the applied alternating signal:	$\sqrt{2}$
Position of the conductor in the clamp:	centered
Adjacent conductors:	none
Alternating magnetic field:	none
Electric field:	none

### 5.2 SPECIFICATIONS UNDER THE REFERENCE CONDITIONS

Accuracy is expressed in  $\pm (x \% \text{ of the reading (R)} + y \text{ counts (ct)})$ .

#### 5.2.1 DC Voltage Measurement

Measurement Range	(0.00 to 99.99) V	(1000 to 999.9) V	1000 V <sup>(1)</sup>
Specified Measurement Range	(0 to 100) % of the measurement range		
Accuracy	(0.00 to 9.99) V $\pm (1 \% R + 10 \text{ cts})$ (10.00 to 99.99) V $\pm (1 \% R + 3 \text{ cts})$	$\pm (1 \% R + 3 \text{ cts})$	
Resolution	0.01 V	0.1 V	1 V
Input Impedance	10 M $\Omega$		

(1) Above 1000 V, a repetitive beep indicates that the voltage being measured is greater than the safety voltage for which the device is guaranteed. The display indicates **OL**.

## 5.2.2 AC Voltage Measurement

Measurement Range	(0.15 to 99.99) V	(100.0 to 999.9) V	1000 V RMS 1400 V peak <sup>(1)</sup>
Specified Measurement Range <sup>(2)</sup>	(0 to 100) % of the measurement range		
Accuracy	(0.15 to 9.99) V ± (1 % R + 10 cts) (10.00 to 99.99) V ± (1 % R + 3 cts)	± (1 % R + 3 cts)	
Resolution	0.01 V	0.1 V	1 V
Input Impedance	10 M Ω		

- (1) Above 1000 V (RMS), a repetitive beep indicates that the voltage being measured is greater than the safety voltage for which the device is guaranteed. The display indicates **OL**.  
Bandwidth in AC = 3 kHz.
- (2) Any value between zero and the min threshold of the measurement range (0.15 V) is forced to show **-----** on the display.

### Specific Specifications in MAX/MIN mode (from 10 Hz to 1 kHz, and from 0.30 V in AC):

- Accuracy: add 1 % R to the values of the table above.
- Capture of the extreme: approximately 100 ms.

## 5.2.3 AC+DC Voltage Measurement

Measurement Range <sup>(2)</sup>	(0.15 to 99.99) V	(100.0 to 999.9) V	1000 V RMS <sup>(1)</sup> 1400 V peak
Specified Measurement Range	(0 to 100) % of the measurement range		
Accuracy	(0.15 to 9.99) V ± (1 % R + 10 cts) (10 to 99.99) V ± (1 % R + 3 cts)	± (1 % R + 3 cts)	
Resolution	0.01 V	0.1 V	1 V
Input Impedance	10 M Ω		

- (1) The display indicates **OL** above 1000 V (1400 V in PEAK mode).  
Above 1000 V (DC or RMS), a repetitive beep indicates that the voltage being measured is greater than the safety voltage for which the device is guaranteed.  
Bandwidth in AC = 3 kHz.
- (2) Any value between zero and the min threshold of the measurement range (0.15 V) is forced to show **-----** on the display.

**Specific Specifications in MAX/MIN mode in Voltage  
(from 10 Hz to 1 kHz in AC and AC+DC):**

- Accuracy: add 1 % R to the values of the previous table.
- Capture of the extreme: approximately 100 ms.

**Specific Specifications in PEAK mode in voltage  
(from 10 Hz to 1 kHz  
in AC and AC+DC):**

- Accuracy: add 1.5 % R to the values in the previous table.
- PEAK capture time: 1 ms min to 1.5 ms max.

**5.2.4 DC Current Measurement**

Measurement Range <sup>(2)</sup>	(0.00 to 99.99) A	(100.0 to 999.9) A	(1000 to 1500) A <sup>(1)</sup>
Specified Measurement Range	(0 to 100) % of the measurement range		
Accuracy	± (1 % R + 10 cts)	± (1 % R + 3 cts)	
Resolution	0.01 A	0.1 A	1 A

(1) The display indicates **+OL** above 1500 A.

(2) The residual current at zero depends on the remanence. It can be corrected by the **DC zero** function of the **HOLD** button.

**5.2.5 AC Current Measurement**

Measurement Range <sup>(2)</sup>	(0.15 to 99.99) A	(100.0 to 999.9) A	1000 A <sup>(1)</sup>
Specified Measurement Range	(0 to 100) % of the measurement range		
Accuracy	± (1 % R + 10 cts)	± (1 % R + 3 cts)	
Resolution	0.01 A	0.1 A	1 A

(1) The display indicates **OL** above 1500 A (in PEAK mode).

The - and + signs are not displayed.

Bandwidth in AC = 2 kHz

(2) In AC, any value between zero and the min threshold of the measurement range (0.15 A) is forced to show **-----** on the display.

Residual current at zero < 150 mA.

## 5.2.6 AC+DC Current Measurement

Measurement Range <sup>(2)</sup>	(0.15 to 99.99) A	(100.0 to 999.9) A	AC: 1000 A DC or PEAK: (1000 to 1500) A <sup>(1)</sup>
Specified Measurement Range	(0 to 100) % of the measurement range		
Accuracy <sup>(2)</sup> (zero corrected)	± (1 % R + 10 cts)	± (1 % R + 3 cts)	
Resolution	0.01 A	0.1 A	1 A

(1) The display indicates **+OL** above 1500 A (in PEAK mode).

The - and + signs are not displayed.

Bandwidth in AC = 2 kHz

(2) In AC, any value between zero and the min threshold of the measurement range (0.15 A) is forced to show **-----** on the display.

Residual current at zero:

-In DC: depends on the remanence. This can be corrected by the **DC zero** function of the **HOLD** button.

-In AC: < 150 mA

### Specific Specifications in MAX/MIN mode (from 10 Hz to 1 kHz in AC and AC+DC):

- Accuracy: add 1 % R to the values of the table above.
- Capture of the extreme: approximately 100 ms.

### Specific characteristics in PEAK mode in current (from 10 Hz to 1 kHz in AC and AC+DC):

- Accuracy: add 1.5 % R to the values in the tables above.
- PEAK capture time: 1 ms min to 1.5 ms max.

## 5.2.7 True InRush® Measurement

Measurement Range	(10 to 1000) AAC	(10 to 1500) AAC
Specified Measurement Range	(0 to 100) % of the measurement range	
Accuracy	± (5 % R + 5 cts)	
Resolution	1 A	

### Specific specifications in PEAK mode in True InRush® (from 10 Hz to 1 kHz in AC):

- Accuracy: add ± (1.5 % R + 0.5 A) to the values in the table above.
- PEAK capture time: 1 ms min to 1.5 ms max.

## 5.2.8 Crest Factor (CF) Calculation

Measurement Range	(1.00 to 3.50)	(3.51 to 5.99)	(6.00 to 10.00)
Specified Measurement Range (from 5 V or 5 A)	(0 to 100) % of the measurement range		
Accuracy (zero corrected in ADC)	$\pm (2 \% R + 2 \text{ cts})$	$\pm (5 \% R + 2 \text{ cts})$	$\pm (10 \% R + 2 \text{ cts})$
Resolution	1 ct		



**NOTE:** Peak values limited to 1500 V or 1500 A.

## 5.2.9 RIPPLE in DC Calculation

Measurement Range	(0.1 to 99.9) %	(100.0 to 1000)%
Specified Measurement Range (from 3 ADC and 2 VDC)	(2 to 100) % of the measurement range	(0 to 100) % of the measurement range
Accuracy	$\pm (5 \% R + 10 \text{ cts})$	
Resolution	0.1	



**NOTE:** If one of the terms for the calculation of the RIPPLE is displayed as **OL**, or **forced to zero**, the RIPPLE displayed is an indeterminate value, **-----**.

## 5.2.10 Continuity Measurement

Measurement Range	(0.0 to 999.9) $\Omega$
Open-circuit Voltage	$\leq 3.6 \text{ V}$
Measurement Current	550 $\mu\text{A}$
Accuracy	$\pm (1 \% R + 5 \text{ cts})$
Buzzer Triggering Threshold	40 $\Omega$

## 5.2.11 Resistance Measurement

Measurement Range <sup>(1)</sup>	(0.0 to 999.9) Ω	(100.0 to 999.9) Ω	(1000 to 9999) Ω	(10.00 to 99.99) kΩ
Specified Measurement Range	(1 to 100) % of the measurement range		(0 to 100) % of the measurement range	
Accuracy	± (1 % R + 10 cts)		± (1 % R + 5 cts)	
Resolution	0.1 Ω		1 Ω	10 Ω
Open-circuit Voltage	≤ 3.6 V			
Measurement Current	550 μA		100 μA	10 μA

(1) Above the maximum display value, the display unit indicates **OL**.  
The - and + signs are not displayed.

### Specific Specifications in MAX/MIN mode:

- Accuracy: add 1 % R to the values of the previous table.
- Capture of the extreme: approximately 100 ms.

## 5.2.12 Active DC Power Measurements

Measurement Range <sup>(2)</sup>	(0 to 9999) W	(10.00 to 99.99) kW	(100.0 to 999.9) kW	(1000 to 3000) kW <sup>(1)</sup>
Specified Measurement Range	(1 to 100) % of the measurement range	(0 to 100) % of the measurement range		
Accuracy <sup>(3)</sup>	1000 A ± (2 % R + 10 cts) (1000 to 1500) A ± (2.5 % R + 10 cts)	1000 A ± (2 % R + 3 cts) (1000 to 1500) A ± (2.5 % R + 3 cts)		
Resolution	1 W	10 W	100 W	1000 W

- (1) Display of **OL** or **± OL**  
Above 1500 kW in single-phase (1000 V x 1500 A).
- (2) Any applied voltage greater than 1000 V causes the emission of an intermittent alarm beep to report a dangerous overload.
- (3) The measurement result may be affected by an instability linked to the current measurement (approximately 0.1 A).  
Example: For a power measurement made at 10 A, the instability of the measurement will be 0.1 A/10 A or 1 %.



### 5.2.13 Active AC Power Measurements

Measurement Range <sup>(2) (4)</sup>	(5 to 9999) W	(10.00 to 99.99) kW	(100.0 to 999.9) kW	(1000) kW <sup>(1)</sup>
Specified Measurement Range	(1 to 100) % of the measurement range	(0 to 100) % of the measurement range		
Accuracy <sup>(3) (7)</sup>	1000 A ± (2 % R + 10 cts)	1000 A ± (2 % R + 3 cts)		
Resolution	1 W	10 W	100 W	1000 W

- (1) Display of **OL** above 1000 kW in single-phase (1000 V x 1000 A).  
Bandwidth in AC in voltage = 3 kHz, in current = 2 kHz
- (2) and (3) of the previous § apply.
- (4) Any power measured less than 5 W is regarded as zero and causes the display of dashes **----**.
- If the voltage is less than 0.15 V or if the current is less than 0.15 A, the power measured is regarded as zero and causes the display of **----**.
- (7) In balanced three-phases, with deformed signals (THD and harmonics), uncertainties are guaranteed since  $\Phi > 30^\circ$ . Additional errors are following, depending of THD:  
Add +1 % for 10 % < THD < 20 %  
Add +3 % for 20 % < THD < 30 %  
Add +5 % for 30 % < THD < 40 %

**NOTE 5:** The active powers are positive for power consumed and negative for power generated.

**NOTE 6:** The signs of the active and reactive powers and power factor are defined by the four-quadrant rule:

The diagram below sums up the signs of the power as a function of the phase angle between V and I:

- |                            |                          |
|----------------------------|--------------------------|
| Quadrant 1: Active power P | sign + (power consumed)  |
| Quadrant 2: Active power P | sign - (power generated) |
| Quadrant 3: Active power P | sign - (power generated) |
| Quadrant 4: Active power P | sign + (power consumed)  |

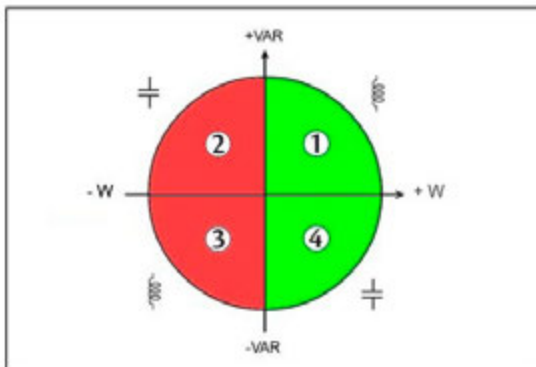

## 5.2.14 Active AC+DC Power Measurements

Measurement Range <sup>(2) (4)</sup>	(5 to 9999) W	(10.00 to 99.99) kW	(100.0 to 999.9) kW	(1000 to 1500) kW <sup>(1)</sup>
Specified Measurement Range	(1 to 100) % of the measurement range	(0 to 100) % of the measurement range		
Accuracy <sup>(3)</sup>	1000 A ± (2 % R + 10 cts) (1000 to 1500) A	1000 A ± (2 % R + 3 cts) (1000 to 1500 A) ± (2.5 % R + 3 cts)		
Resolution	1 W	10 W	100 W	1000 W

(1) Display of **OL** above 1500 kW in single-phase (1000 V x 1500 A)  
Bandwidth in AC in voltage = 3 kHz, in current = 2 kHz

(2), (3), (4), 5, 6 and (7) of previous § apply.

## 5.2.15 Apparent AC Power Measurement

Measurement Range <sup>(2) (4)</sup>	(5 to 9999) VA	(10.00 to 99.99) kVA	(100.0 to 999.9) kVA	kVA <sup>(1)</sup>
Specified Measurement Range	(1 to 100) % of the measurement range	(0 to 100) % of the measurement range		
Accuracy <sup>(3)</sup>	± (2 % R + 10 cts)	± (2 % R + 3 cts)		
Resolution	1 VA	10 VA	100 VA	1000 VA

(1) Display of **OL** above 1000 kVA in single-phase (1000 V x 1000 A).  
Bandwidth in AC in voltage = 3 kHz, in current = 2 kHz

(2), (3) and (4) of previous § apply.

## 5.2.16 Apparent AC+DC Power Measurement

Measurement Range <sup>(2) (4)</sup>	(5 to 9999) VA	(10.00 to 99.99) kVA	(100.0 to 999.9) kVA	(1000 to 1500) kVA <sup>(1)</sup>
Specified Measurement Range	(1 to 100) % of the measurement range	(0 to 100) % of the measurement range		
Accuracy <sup>(3)</sup>	1000 A ± (2 % R + 10 cts) (1000 to 2000) A ± (2.5 % R + 10 cts)	1000 A ± (2 % R + 3 cts) (1000 to 2000 A) ± (2.5 % R + 3 cts)		
Resolution	1 VA	10 VA	100 VA	1000 VA

(1) Display of **OL** above 1500 kVA in single-phase (1000 V x 1000 A)  
Bandwidth in AC in voltage = 3 kHz, in current = 2 kHz

(2), (3) and (4) of previous § apply.

## 5.2.17 Measurement of Reactive AC Power

Measurement Range <sup>(2) (4)</sup>	(5 to 9999) var	(10.00 to 99.99) kvar	(100.0 to 999.9) kvar	1000 kvar <sup>(1)</sup>
Specified Measurement Range	(1 to 100) % of the measurement range	(0 to 100) % of the measurement range		
Accuracy <sup>(3) (7)</sup>	± (2 % R + 10 cts)	± (2 % R + 3 cts)		
Resolution	1 var	10 var	100 var	1 kvar

(1) Display of **OL** above 1000 kvar in single-phase (1000 V x 1000 A).

Bandwidth in AC in voltage = 3 kHz, in current = 2 kHz

(2), (3) and (4) of previous § apply.

(7) Measurement stabilization ~ 8 sec

**NOTE 5:** In single-phase, the sign of the reactive power is determined by the phase lead or lag between the V and I signs, while in balanced three-phase, it is determined by the calculation on the samples.



**NOTE 6:** - Signs of reactive powers according to the four-quadrant rule (§ 5.2.12):

Quadrant 1: Reactive power Q      sign +  
 Quadrant 2: Reactive power Q      sign +  
 Quadrant 3: Reactive power Q      sign -  
 Quadrant 4: Reactive power Q      sign -

## 5.2.18 Measurement of Reactive AC+DC Power

Measurement Range <sup>(2) (4)</sup>	(5 to 9999) var	(10.00 to 99.99) kvar	(100.0 to 999.9) kvar	(1000 to 1500) kvar <sup>(1)</sup>
Specified Measurement Range	(1 to 100) % of the measurement range	(0 to 100) % of the measurement range		
Accuracy <sup>(3) (7)</sup>	1000 A ± (2 % R + 10 cts) (1000 to 2000) A ± (2.5 % R + 10 cts)	1000 A ± (2 % R + 3 cts) (1000 to 2000 A) ± (2.5 % R + 3 cts)		
Resolution	1 var	10 var	100 var	1 kvar

(1) Display of **OL** above 1500 kvar in single-phase (1000 V x 1500 A)

Bandwidth in AC in voltage = 3 kHz, in current = 2 kHz

(2), (3), (4), 5, 6 and (7) previous § apply.

### Specific characteristics in MAX/MIN mode in power (from 10 Hz to 1 kHz in AC and AC+DC):

- Accuracy: add 1 % R to the values in the table above.
- Capture time: approximately 100 ms

## 5.2.19 Calculation of the Power Factor (PF)

Measurement Range <sup>(1)</sup>	0.0 to + 1.00	
Specific Measurement Range	(0 to 50) % of the measurement range	(50 to 100) % of the measurement range
Accuracy <sup>(2)</sup>	± (3 % R + 3 cts)	± (2 % R + 3 cts)
Resolution	0.01	

(1) If one of the terms in the calculation of the power factor is displayed as **OL**, or **forced to zero**, the display of the power factor is an indeterminate value **----**.

(2) In balanced three-phases, with deformed signals (THD and harmonics), uncertainties are guaranteed since  $\Phi > 30^\circ$ . Additional errors are following, depending of THD:  
 Add +1 % for 10 % < THD < 20 %  
 Add +3 % for 20 % < THD < 30 %  
 Add +5 % for 30 % < THD < 40 %



**NOTE:** The PF is always positive.

### Specific characteristics in MAX/MIN mode (from 10 Hz to 1 kHz):

- Accuracy: add 1 % R to the values in the table above.
- Capture time: approximately 100 ms.

## 5.2.20 Calculation of the Displacement Power Factor (DPF)

Measurement Range <sup>(1)</sup>	(0.0 to + 1.00)
Specific Measurement Range (from 1 AAC)	(0 to 100) % of the measurement range
Accuracy <sup>(2) (3)</sup>	± (5 % R + 2 cts)
Resolution	0.01

(1) If one of the terms in the calculation of the DPF is displayed as **OL**, or **forced to zero**, the display of the DPF is an indeterminate value **----**.

(2) of the previous § applies.

(3) Measurement stabilization ~ 8 sec.



**NOTE:** The DPF is always positive.

### Specific characteristics in MAX/MIN mode (from 10 Hz to 1 kHz):

- Accuracy: add 1 % R to the values in the table above.
- Capture time: approximately 100 ms.

## 5.2.21 Frequency Measurements

### 5.2.21.1 Voltage

Measurement Range <sup>(1)</sup>	(5.0 to 999.9) Hz	(1000 to 9999) Hz	(10.00 to 19.99) kHz
Specified Measurement Range	(1 to 100) % of the measurement range	(0 to 100) % of the measurement range	
Accuracy	± (0.4 % R + 1 ct)		
Resolution	0.1 Hz		

### 5.2.21.2 Current

Measurement Range <sup>(1)</sup>	(5.0 to 1999) Hz
Specified Measurement Range	(1 to 100) % of the measurement range
Accuracy	± (0.4 % R + 1 ct)
Resolution	0.1 Hz

(1) In MAX/MIN mode, the operating range is limited to 1 kHz.

If the level of the signal is too low (< 10 % of the range, or  $V < 8\text{ V}$  or  $I < 9\text{ A}$ ) or if the frequency is less than 5 Hz, the device cannot determine the frequency and displays **----**.

### Specific Specifications in MAX/MIN mode

(from 10 Hz to 1 kHz in Voltage and from 10 Hz to 1 kHz in Current):

- Accuracy: add 1 % R to the values of the table above.
- Capture of the extreme: approximately 100 ms.

## 5.2.22 Specifications in THDr

Measurement Range	(0.0 to 100) %
Specified Measurement Range	(0 to 100) % of the measurement range
Accuracy	± (5 % R ± 2 cts) in voltage ± (5 % R ± 5 cts) in current
Resolution	1 %

### 5.2.23 Specifications in THDf

Measurement Range	(0.0 to 100) %
Specified Measurement Range	(0 to 100) % of the measurement range
Accuracy	$\pm (5 \% R \pm 2 \text{ cts})$ in voltage $\pm (5 \% R \pm 5 \text{ cts})$ in current
Resolution	1 %



**NOTE:** The display is **----** if the input signal is too low ( $V < 8 \text{ V}$  or  $I < 9 \text{ A}$ ) or if the frequency is less than 5 Hz.

#### Specific characteristics in MAX/MIN mode in THD (from 10 Hz to 1 kHz):

- Accuracy: add 1 % R to the values in the table above.
- Capture time of the extreme: approximately 100 ms

### 5.2.24 Harmonic Measurement Specifications

Measurement Range in Voltage	Per § 4.2.2 and § 4.2.3
Measure Range in Current	Per § 4.2.5 and § 4.2.6
Harmonic Range	AC: harmonics of orders 1 to 25 AC+DC: all orders from 1 to 25, plus the DC component
Frequency Analysis Band	- 0 to 25 times the fundamental frequency, from among the network frequencies 50 Hz, 60 Hz, and 400 Hz - 0 to 12 times the fundamental frequency of an 800 Hz network
Stability of the Current and Voltage Display	$\pm (1 \% R \pm 2 \text{ cts})$
Accuracy on the RMS value of the harmonic (zero corrected in ADC)	Level >10 % and order <13: $\pm (5 \% R \pm 2 \text{ cts})$ Level >10 % and order >13: $\pm (10 \% R \pm 2 \text{ cts})$ Level <10 % and order <13: $\pm (10 \% R \pm 2 \text{ cts})$ Level <10 % and order >13: $\pm (15 \% R \pm 2 \text{ cts})$



**NOTE:** The display is **----** if the input signal is too low ( $V < 8 \text{ V}$  or  $I < 9 \text{ A}$ ) or if the frequency is less than 5 Hz.

#### Specific characteristics in MAX/MIN mode in THD (from 10 Hz to 1 kHz):

- Accuracy: add 1 % R to the values in the table above.
- Capture time of the extreme: approximately 100 ms

### 5.3 ENVIRONMENTAL CONDITIONS

Conditions	Operating	Storage
Temperature	(-4 to +131) °F (-20 to +55) °C	(-40 to +158) °F (-40 to +70) °C
Relative Humidity (RH)	≤ 90 % up to 131 °F (55 °C)	≤ 90 % up to 158 °F (70 °C)

### 5.4 MECHANICAL SPECIFICATIONS

Housing	Rigid polycarbonate shell with over-molded elastomer covering; UL94 V1
Jaws	Polycarbonate Opening: 1.9 in (48 mm) Clamping diameter: 1.9 in (48 mm)
Screen	LCD display unit Blue backlighting Dimension: 1.6 x 1.9 in (41 x 48 mm)
Dimension	(10.7 x 3.6 x 1.6) in (272 x 92 x 41) mm
Weight	1.32 lbs (600 g) with the batteries



### 5.5 POWER SUPPLY

Batteries	(4) 1.5 V AA LR6
Battery Life	> 350 h (without backlighting and Bluetooth)
Auto Power OFF	After 10 min with no switch and/or button activity

### 5.6 COMPLIANCE WITH INTERNATIONAL STANDARDS

Electric safety	Compliant with standards IEC-61010-1, IEC-61010-2-30, and IEC-61010-2-32:1000 V CAT IV.
Electromagnetic compatibility	Compliant with standard EN-61326-1 Classification: residential environment
Mechanical Strength	Free fall: 2 m (in accordance with standard IEC-68-2-32)
Level of protection of the housing	Housing: IP54 (per standard IEC-60529) Jaws: IP40

## 5.7 ENVIRONMENTAL VARIATIONS

Condition of influence	Range of influence	Measurement influenced	Influence		
			Typical	MAX	
Temperature	(-4 to +131) °F (-20 to +55) °C	V AC	-	0.1 % R/10 °C	
		V DC	0.1 % R/10 °C	0.5 % R/10 °C + 2 cts	
		A*	1 % R/10 °C*	1.5 % R/10 °C + 2 cts*	
		$\Omega$ 	-	0.1 % R/10 °C + 2 cts	
		W AC	-	0.2 % R/10 °C + 2 cts	
		W DC	0.15 % R/10 °C	0.3 % R/10 °C + 2 cts	
Humidity	(10 to 90) % RH	V	≤ 1 ct	0.1 % R + 1 ct	
		A	-	0.1 % R + 2 cts	
		$\Omega$ 	0.2 % R	0.3 % R + 2 cts	
		W	0.25 % R	0.5 % R + 2 cts	
Frequency	10 Hz to 1 kHz (1 to 3) kHz (10 to 400) Hz 400 Hz to 1 kHz	V	1 % R + 1 ct 8 % R + 1 ct	1 % R + 1 ct 9 % R + 1 ct	
		A	1 % R + 1 ct 4 % R + 1 ct	1 % R + 1 ct 5 % R + 1 ct	
		Position of the conductor in the jaws (f≤400 Hz)	A-W	2 % R	4 % R + 1 ct Full-scale
		Adjacent conductor carrying a current of 150 A DC or RMS	A-W	40 dB	30 dB
Conductor enclosed by the clamp	(0 to 500) A DC or RMS	V	< 1 ct	1 ct	
Application of a voltage of the clamp	(0 to 1000) V DC or RMS	A-W	< 1 ct	1 ct	
Peak factor (1)	1.4 to 3.5 limited to 1500 A peak 1400 V peak	A (AC-AC+DC)	1 % R	3 % R + 1 ct	
		V (AC-AC+DC)	1 % R	3 % R + 1 ct	
PF (inductive and capacitive)	0.7 and I ≥ 5 A	W	0.5 % R	1 % R + 1 ct	
	0.5 and I ≥ 10 A			3 % R + 1 ct	
	0.2 and I ≥ 20 A			8 % R + 1 ct	

\*Note in Temperature: Influence specified until 1000 Adc



---

## 6. MAINTENANCE

---

### 6.1 WARNING

- Remove the test leads on any input before opening the case.
- Do not operate the clamp-on meter without a battery case cover.
- To avoid electrical shock, do not attempt to perform any servicing unless you are qualified to do so.
- To avoid electrical shock and/or damage to the instrument, do not get water or other foreign agents into the probe.

### 6.2 CLEANING

- Disconnect everything connected to the device and set the switch to **OFF**.
- Use a soft cloth moistened with soapy water. Rinse with a damp cloth and dry quickly using a dry cloth or forced air.
- Dry completely before putting back into use.

### 6.3 BATTERY REPLACEMENT

The  symbol indicates that the batteries are low. When this symbol appears on the display unit, the batteries must be replaced. The measurements and specifications are no longer guaranteed.

To replace the batteries, proceed as follows:

1. Disconnect the measurement leads from the input terminals.
2. Set the switch to OFF.
3. Using a screwdriver, unscrew the battery compartment cover from the back of the housing (see § 3.1).
4. Remove the used batteries and replace them with (4) 1.5 V AA batteries, observing the polarities.
5. Close the battery compartment cover and screw it onto the housing.

## 6.4 REPAIR AND CALIBRATION

To ensure that your instrument meets factory specifications, we recommend that the instrument be sent back to our factory Service Center at one-year intervals for recalibration or as required by other standards or internal procedures.

**(Or contact your authorized distributor.)**

Contact us for the costs for repair, standard calibration, and calibration traceable to N.I.S.T.



**NOTE:** You must obtain a CSA# before returning any instrument.

---

## 6.5 TECHNICAL ASSISTANCE

If you are experiencing any technical problems or require any assistance with the proper operation or application of your instrument, please call, e-mail or fax our technical support team.

## 6.6 LIMITED WARRANTY

The instrument is warranted to the owner for a period of three years from the date of original purchase against defects in manufacture. This limited warranty is given by AEMC® Instruments, not by the distributor from whom it was purchased. This warranty is void if the unit has been tampered with, abused, or if the defect is related to service not performed by AEMC® Instruments.

**Please print the online Warranty Coverage Information for your records.**

### **What AEMC® Instruments will do:**

If a malfunction occurs within the warranty period, you may return the instrument to us for repair, provided we have your warranty registration information on file or a proof of purchase. AEMC® Instruments will repair or replace the faulty material at our discretion.

**Caution: To protect yourself against in-transit loss, we recommend that you insure your returned material.**



**NOTE:** You must obtain a CSA# before returning any instrument.

---



03/24  
99-MAN 100367 v11