

User Manual
ENGLISH



PowerPad® IV Model 8345



POWERPAD IV
Class A

POWER QUALITY ANALYZER

Measure Up
WITH AEMC INSTRUMENTS



Copyright© Chauvin Arnoux®, Inc. d.b.a. AEMC® Instruments. All rights reserved.

No part of this documentation may be reproduced in any form or by any means (including electronic storage and retrieval or translation into any other language) without prior agreement and written consent from Chauvin Arnoux®, Inc., as governed by United States and International copyright laws.

This documentation is provided **as is**, without warranty of any kind, express, implied, or otherwise. Chauvin Arnoux®, Inc. has made every reasonable effort to ensure that this documentation is accurate; but does not warrant the accuracy or completeness of the text, graphics, or other information contained in this documentation. Chauvin Arnoux®, Inc. shall not be liable for any damages, special, indirect, incidental, or inconsequential; including (but not limited to) physical, emotional or monetary damages due to lost revenues or lost profits that may result from the use of this documentation, whether or not the user of the documentation has been advised of the possibility of such damages.

Statement of Compliance

Chauvin Arnoux[®], Inc. d.b.a. AEMC[®] Instruments certifies that this instrument has been calibrated using standards and instruments traceable to international standards.

We guarantee that at the time of shipping your instrument has met the instrument's published specifications.

An NIST traceable certificate may be requested at the time of purchase, or obtained by returning the instrument to our repair and calibration facility, for a nominal charge.

The recommended calibration interval for this instrument is 12 months and begins on the date of receipt by the customer. For recalibration, please use our calibration services.

Serial #:

Catalog #: ~~2136.35 / 2136.36 / 2136.37~~

Model #: 8345

Please fill in the appropriate date as indicated:

Date Received:

Date Calibration Due: _____



Chauvin Arnoux[®], Inc.
d.b.a AEMC[®] Instruments

TABLE OF CONTENTS

1. INTRODUCTION	10
1.1 INTERNATIONAL ELECTRICAL SYMBOLS.....	10
1.2 DEFINITION OF MEASUREMENT CATEGORIES (CAT)	10
1.3 PRECAUTIONS FOR USE 	11
1.4 RECEIVING YOUR SHIPMENT	11
1.5 ORDERING INFORMATION.....	12
1.5.1 Accessories.....	12
1.5.2 Replacement Parts	13
1.6 CHARGING THE BATTERY	13
1.7 CHOOSING A LANGUAGE FOR THE DISPLAY.....	14
2. PRODUCT FEATURES	15
2.1 DESCRIPTION.....	15
2.1.1 Recording Functions.....	15
2.1.2 Display Functions.....	16
2.1.3 Measurement Functions	17
2.1.4 Configuration Functions	17
2.2 OVERALL VIEW	18
2.3 MEASUREMENT TERMINALS.....	19
2.4 SIDE CONNECTORS.....	19
2.5 BATTERY	20
2.6 DISPLAY UNIT.....	20
2.7 ON/OFF BUTTON.....	21
2.8 KEYPAD	21
2.8.1 Mode Buttons (Purple Buttons).....	21
2.8.2 Navigation Buttons	22
2.8.3 The Other Buttons	22
2.8.4 The Function Buttons (8 Yellow Buttons)	22
2.9 INSTALLING THE COLOR CODES.....	22
2.10 MEMORY CARD	23
2.11 STAND.....	24
2.12 MAGNETIZED HOOK (OPTIONAL).....	24
3. CONFIGURATION	25
3.1 NAVIGATION.....	25
3.2 INPUT KEYBOARD.....	26
3.3 USERS.....	26

3.4 CONFIGURING THE INSTRUMENT	27
3.4.1 Lock Configuration	28
3.4.2 Language	28
3.4.3 Date and Time	29
3.4.3.1 Manual Mode	29
3.4.3.2 GPS Mode	29
3.4.3.3 NTP Mode	30
3.4.4 Display	31
3.4.4.1 Colors of the Voltage Curves	31
3.4.4.2 Colors of the Current Curves	31
3.4.4.3 Screen Brightness and Auto-Off	31
3.5 MEMORY (SD CARD, USB DRIVE)	31
3.6 INFORMATION	33
3.7 COMMUNICATION	33
3.7.1 Ethernet Link	34
3.7.2 Wi-Fi Access Point (WAP) Link	35
3.7.3 Wi-Fi Link	35
3.7.4 Email	36
3.7.5 DataViewSync™	36
3.8 UPDATING THE EMBEDDED SOFTWARE	37
3.9 CONFIGURING THE MEASUREMENT	38
3.9.1 Calculation Methods	39
3.9.1.1 Nominal Values	39
3.9.1.2 Real Time Values	40
3.9.1.3 Waveform Mode	40
3.9.1.4 Harmonic Mode	41
3.9.1.5 MSV Template	42
3.9.2 The Distribution Network and the Type of Connection	42
3.9.3 Sensors and Ratios	47
3.9.3.1 Voltage Ratio	47
3.9.3.2 Current Sensors	48
3.9.3.3 Reversing the Current	49
3.10 CONFIGURING RECORDINGS	49
3.10.1 Quick Programming of a Recording  (QuickStart)	49
3.10.2 Trend Mode	50
3.10.3 Transient Mode	51
3.10.3.1 Voltage Thresholds	51
3.10.3.2 Current Thresholds	52
3.10.3.3 Shock Wave Thresholds	52
3.10.3.4 Rapid Capture Configuration	52
3.10.4 Inrush Current Mode	53
3.10.5 Alarm Mode	53

3.10.6 Energy Mode	55
3.10.6.1 Energy Basic Tariff	55
3.10.6.2 Energy Specific Tariffs	55
3.10.7 Monitoring Mode	56
3.10.8 Flagging	56
4. OPERATION	57
4.1 TURNING THE INSTRUMENT ON	57
4.2 NAVIGATION	57
4.2.1 Keypad	57
4.2.2 Touch Screen	57
4.2.3 Remote User Interface	57
4.3 CONFIGURATION	59
4.4 CONNECTIONS	59
4.4.1 Single-Phase Network	59
4.4.2 Split-Phase Network	59
4.4.3 Three-Phase Network	60
4.4.4 Connection Procedure	60
4.5 INSTRUMENT FUNCTIONS	61
4.5.1 Measurements	61
4.5.2 Screenshot	61
4.5.3 Help	62
4.6 TURNING THE INSTRUMENT OFF	62
4.7 SAFETY STATUS	62
5. WAVEFORM	63
5.1 DISPLAY FILTER	63
5.2 ROOT MEAN SQUARE (RMS) FUNCTION	64
5.3 TOTAL HARMONIC DISTORTION (THD) FUNCTION	65
5.4 CREST FACTOR (CF) FUNCTION	66
5.5 MIN-MAX FUNCTION	66
5.6 SUMMARY FUNCTION	67
5.7 PHASOR FUNCTION	69
6. HARMONIC	71
6.1 DISPLAY FILTER	73
6.2 EXAMPLES OF SCREENS	73
7. POWER	75
7.1 DISPLAY FILTER	75
7.2 EXAMPLES OF SCREENS	75

- 8. ENERGY..... 77**
 - 8.1 DISPLAY FILTER..... 77
 - 8.2 EXAMPLES OF SCREENS 78
- 9. TREND MODE 79**
 - 9.1 START OF A RECORDING..... 79
 - 9.2 THE LIST OF RECORDINGS..... 80
 - 9.3 READING A RECORDING 81
- 10. TRANSIENT MODE 84**
 - 10.1 START OF A RECORDING..... 84
 - 10.2 THE LIST OF RECORDINGS..... 85
 - 10.3 READING A RECORDING 85
- 11. INRUSH CURRENT MODE 89**
 - 11.1 START OF A CAPTURE 89
 - 11.2 THE LIST OF CAPTURES 90
 - 11.3 READING A CAPTURE..... 91
 - 11.3.1 RMS Values..... 91
 - 11.3.2 Instantaneous Values..... 92
- 12. ALARM MODE 94**
 - 12.1 START OF AN ALARM RECORDING..... 94
 - 12.2 THE LIST OF ALARM RECORDINGS 95
 - 12.3 STARTING AN ALARM RECORDING..... 96
- 13. MONITORING MODE..... 97**
 - 13.1 STARTING A MONITORING RECORDING 97
 - 13.2 THE LIST OF MONITORING RECORDINGS..... 100
 - 13.3 READING A MONITORING RECORDING 100
- 14. SCREENSHOTS..... 101**
 - 14.1 TAKING A SCREENSHOT 101
 - 14.2 MANAGING THE SCREENSHOTS 101
 - 14.2.1 Display of a Screenshot..... 102
- 15. HELP..... 103**
- 16. APPLICATION SOFTWARE 104**
 - 16.1 OBTAINING THE SOFTWARE..... 104
- 17. TECHNICAL SPECIFICATIONS..... 105**
 - 17.1 REFERENCE CONDITIONS..... 105

17.2 ELECTRICAL SPECIFICATIONS	108
17.2.1 Input Voltage Specifications	108
17.2.2 Current Input Specifications.....	108
17.2.3 Bandwidth and Sampling	108
17.2.4 Instrument Specifications (Without Current Sensors)	109
17.2.4.1 Currents and Voltages	109
17.2.4.2 Power and Energy	113
17.2.4.3 Quantities Associated with Power Values.....	116
17.2.4.4 Harmonics.....	116
17.2.4.5 Current and Voltage Ratios	120
17.2.5 Specifications of the Current Sensors	121
17.2.6 Uncertainty of the Real-Time Clock	122
17.3 MEMORY CARD	122
17.4 POWER SUPPLY	123
17.4.1 Battery	123
17.4.2 External Power Supply.....	124
17.4.3 Battery Life	124
17.5 DISPLAY CONDITIONS	125
17.6 ENVIRONMENTAL CONDITIONS	125
17.7 MECHANICAL SPECIFICATIONS.....	126
17.8 COMPLIANCE WITH INTERNATIONAL STANDARDS	126
17.8.1 Electrical Safety.....	126
17.8.2 Standard IEC 61000-4-30, Class A	127
17.8.3 Standards IEC 62053-22 (Active Energy) and IEC 62053-24 (Reactive Energy)	127
17.8.3 Measurement Uncertainties and Ranges	128
17.8.4 Markings per IEC 62586-1	129
17.9 ELECTROMAGNETIC COMPATIBILITY (EMC)	129
17.10 RADIO EMISSIONS	130
17.11 GPL CODE	130
18. MAINTENANCE.....	131
18.1 CLEANING THE HOUSING	131
18.2 SENSOR MAINTENANCE.....	131
18.3 BATTERY PACK REPLACEMENT.....	131
18.4 MEMORY CARD	133
18.5 UPDATING THE FIRMWARE	133
18.6 REPAIR AND CALIBRATION	134
18.7 TECHNICAL ASSISTANCE	134
18.8 LIMITED WARRANTY.....	135
18.8.1 Warranty Repairs	135











19. APPENDICES	136
19.1 NOTATION	136
19.2 AGGREGATIONS IN TREND MODE	137
19.3 FORMULAS	138
19.3.1 RMS Values	138
19.3.2 Peak Values	138
19.3.3 Crest Factor	138
19.3.4 Definitions Relating to Harmonics	139
19.3.5 Effective Value Harmonic and Inter-Harmonics Subgroup.....	139
19.3.6 Levels of Harmonics and Interharmonics	140
19.3.7 Level of Unbalances	140
19.3.8 Mains Signaling Voltages (MSV)	141
19.3.9 Level of Harmonic Group Distortion	141
19.3.10 Distortion	142
19.3.11 K Factor and Harmonic Loss Factor.....	142
19.3.12 Power Frequency	142
19.3.13 DC Component.....	142
19.3.14 Active Power (P).....	143
19.3.15 Fundamental Active Power (P_f).....	143
19.3.16 Fundamental Reactive Power (Q_f).....	143
19.3.17 Harmonic Active Power (P_H)	144
19.3.18 DC Power (P_{DC}).....	144
19.3.19 Apparent Power (S).....	144
19.3.20 Non-Active Power (N).....	144
19.3.21 Distorting Power (D)	145
19.3.22 Power Factor (PF), Power Factor of Fundamental (PF1)	145
19.3.23 Tangent.....	145
19.4 FLICKER.....	146
19.5 SOURCES OF DISTRIBUTION SUPPORTED BY INSTRUMENT.....	146
19.6 HYSTERESIS.....	146
19.6.1 Voltage Swell Detection	147
19.6.2 Voltage Dip and Voltage Interruption Detection	147
19.7 MINIMUM SCALE WAVEFORMS AND RMS VALUES	147
19.8 FOUR-QUADRANT DIAGRAM	148
19.9 TRANSIENT CAPTURE TRIGGERING MECHANISM.....	148
19.10 TRIGGERING MECHANISM SHOCK-WAVE CAPTURES ..	149
19.11 CONDITIONS OF CAPTURE INRUSH CURRENT MODE ..	149
19.12 POSSIBLE CAUSES FOR A STOPPED RECORDING	150
19.13 GLOSSARY	151
19.14 UNIT PREFIXES	156

1. INTRODUCTION

Thank you for purchasing an AEMC® Instruments **PowerPad® IV Model 8345**.

For best results from your instrument and for your safety, read the enclosed operating instructions carefully and comply with the precautions for use. Only qualified and trained operators should use this product.

1.1 INTERNATIONAL ELECTRICAL SYMBOLS

	CAUTION - Risk of Danger! Indicates a WARNING . Whenever this symbol is present, the operator must refer to the user manual before operation.
	Indicates a risk of electric shock. The voltage at the parts marked with this symbol may be dangerous.
	Indicates Important information to acknowledge
	This product complies with the Low Voltage & Electromagnetic Compatibility European directives.
	Ground/Earth
	USB socket
	SD Card
	Kensington anti-theft lock
	Ethernet connector (RJ45)
	The product has been declared recyclable.
	In the European Union, this product is subject to a separate collection system for recycling electrical and electronic components in accordance with directive WEEE 2012/19/EU.

1.2 DEFINITION OF MEASUREMENT CATEGORIES (CAT)

- CAT IV:** Corresponds to measurements performed at primary electrical supply (< 1000 V).
Example: primary overcurrent protection devices, ripple control units, and meters.
- CAT III:** Corresponds to measurements performed in the building installation at the distribution level.
Example: hardwired equipment in fixed installation and circuit breakers.
- CAT II:** Corresponds to measurements performed on circuits directly connected to the electrical distribution system.
Example: measurements on household appliances and portable tools.

1.3 PRECAUTIONS FOR USE

This instrument complies with safety standard IEC/EN 61010-2-030 or BS EN 61010-2-030. The leads comply with IEC/EN 61010-031 or BS EN 61010-031. The current sensors comply with IEC/EN 61010-2-032 or BS EN 61010-2-032 for up to 600 V in CAT IV.

Failure to observe the precautions for use may create a risk of electric shock, fire, explosion, or destruction of the instrument and installations.

- Only competent and accredited personnel may perform troubleshooting or metrological checks
- The operator and responsible authority must read and understand the various precautions to take before and during use
- The operator must have knowledge and awareness of electrical hazards when using this instrument
- Do not use the instrument in an unspecified manner; otherwise, the protection that the instrument provides may become compromised and endanger you
- Do not use the instrument on networks that exceed the instrument's specifications for voltage or category
- Do not use the instrument if it seems to be damaged, incomplete, or improperly closed
- Do not use the instrument without its battery
- Before each use, check the condition of the insulation on the leads, housing, and accessories. Any item with deteriorated insulation (even partially) must be set aside for repair or scrapping
- Ensure that your instrument is completely dry before use. If it is wet, you must dry it completely before connecting or using it
- Use only the supplied leads and accessories. If you use any leads or accessories with lower voltage or category ratings, you are limited to lowest voltage or category rating
- Use personal protection equipment when appropriate
- Keep your hands away from the instrument's terminals
- Keep your fingers behind the physical guards when handling the leads, test probes, and alligator clips
- Use only the manufacturer-provided power supply unit and battery pack because these items have specific safety components
- At hazardous voltages, certain current sensors must not be placed on or removed from bare conductors. Please refer to each sensor's data sheet and comply with their handling instructions

1.4 RECEIVING YOUR SHIPMENT

Upon receiving your shipment, make sure that the contents are consistent with the packing list. Notify your distributor of any missing items. If the equipment appears to be damaged, file a claim immediately with the carrier and notify your distributor at once with a detailed description of any damage. Save the damaged packing container to substantiate your claim.

1.5 ORDERING INFORMATION

PowerPad® IV Model 8345 (No Probes) Cat. #2136.35
Includes meter, extra-large tool bag, internal carrying pouch, hand strap, USB cable, five 10 ft black voltage leads with alligator clips, twelve color-coded input ID markers, power adapter (PA32ER) with US power cord, two 6 ft stackable leads, two 10 ft black voltage leads with alligator clips for power adapter PA32ER, SD Card, one power plug adaptor for PA32ER, 5.8 A·h Li-ion battery pack, quick start guide, and USB drive with DataView® software and user manual.

PowerPad® IV Model 8345 w/ 4 MA194-24-BK Sensors..... Cat. #2136.36
Includes meter, extra-large tool bag, internal carrying pouch, hand strap, four MA194-24-BK sensors, USB cable, five 10 ft black voltage leads with alligator clips, twelve color-coded input ID markers, power adapter (PA32ER) with US power cord, two 6 ft stackable leads, two 10 ft black voltage leads with alligator clips for power adapter PA32ER, SD Card, one power plug adapter for PA32ER, 5.8 A·h Li-ion battery pack, quick start guide, and USB drive with DataView® software and user manual.

PowerPad® IV Model 8345 w/ 4 193-24-BK AmpFlex® Sensors... Cat. #2136.37
Includes meter, extra-large tool bag, internal carrying pouch, hand strap, four 193-24-BK AmpFlex® sensors, USB cable, five 10 ft black voltage leads with alligator clips, twelve color-coded input ID markers, power adapter (PA32ER) with US power cord, two 6 ft stackable leads, two 10 ft black voltage leads with alligator clips for power adapter PA32ER, SD Card, one power plug adapter for PA32ER, 5.8 A·h Li-ion battery pack, quick start guide, and USB drive with DataView® software and user manual.

1.5.1 Accessories

AC/DC Current Probe Model MR193-BK **Cat. #2140.28**
AC Current Probe Model MN93-BK..... **Cat. #2140.32**
AC Current Probe Model SR193-BK **Cat. #2140.33**
AmpFlex® Model 193-24-BK..... **Cat. #2140.34**
AmpFlex® Model 193-36-BK **Cat. #2140.35**
AC Current Probe Model MN193-BK..... **Cat. #2140.36**
MiniFlex® Sensor Model MA193-10-BK..... **Cat. #2140.48**
MiniFlex® Sensor Model MA193-14-BK..... **Cat. #2140.50**
AC Current Probe Model MN94..... **Cat. #2140.81**
AC/DC Current Probe Model E94..... **Cat. #2140.82**
Magnetic Hook for use with PowerPad® IV Model 8345..... **Cat. #5100.16**
Calibration Interface Adapter for Data Logger
Models L104, L564, PowerPad® and PEL Series..... **Cat. #6000.07**

1.5.2 Replacement Parts

Carrying Bag.....	Cat. #2133.76
Lead - Set of five, 10 ft (3 m) Black Leads w/ five Black Alligator Clips.....	Cat. #2140.43
Lead - One 10 ft (3 m) Black Lead w/ one Black Alligator Clip.....	Cat. #2140.44
Cable - Replacement 10 ft USB Cable.....	Cat. #2136.80
Sensor - MiniFlex® Sensor Model MA194-24-BK.....	Cat. #2140.80
Battery - 5.8 A·h 61.9 W·h Li-ion Battery Pack.....	Cat. #2960.47
Adapter - Replacement Power Plug Adapter for PA32ER.....	Cat. #5100.14
Adapter - Replacement 1000 V PA32ER Power Supply for Model 8345.....	Cat. #5100.15

1.6 CHARGING THE BATTERY

Before using the instrument, you must fully charge the battery.

1. Remove the plastic film preventing the connection between the battery and instrument. To do this, refer to § 18.3, which explains how to remove the battery from the instrument.
2. Connect the power cord to the power supply unit.
3. Plug the power cord into an outlet.
4. Open the elastomer cover that protects the power socket
5. Connect the power supply's 4-point connector to the instrument

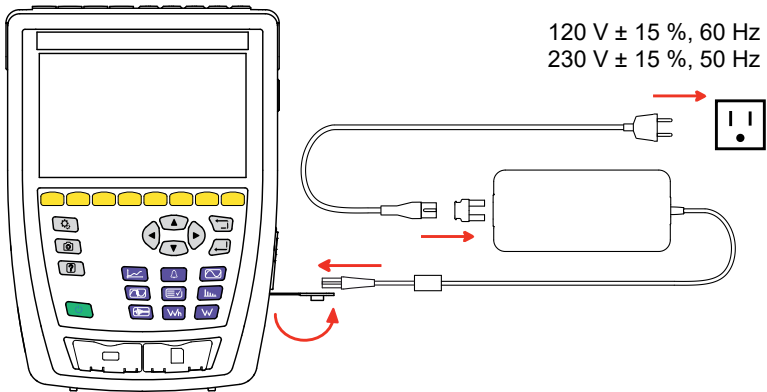





The ON/OFF button  will blink while charging, and the display unit will indicate the charging status.

When the battery is fully depleted, the charging time is approximately 6 hours.

The ON/OFF button  will glow steady green when the battery is fully charged.

1.7 CHOOSING A LANGUAGE FOR THE DISPLAY

You must choose a language for the display before using the instrument. The Model 8345 has more than 20 languages available from which to choose.

1. Press the ON/OFF button  to turn the instrument on.
2. Press the configuration button .
3. Press the second yellow function button .
4. Then, press  to open the language menu.
5. Choose your desired language from the list that appears

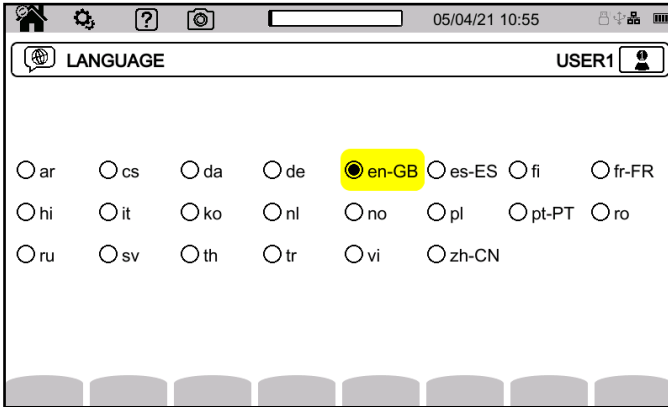

2. PRODUCT FEATURES

2.1 DESCRIPTION

The PowerPad® IV Model 8345 is a portable, three-phase power quality analyzer that complies with the standards governing the methods of power quality measurement, IEC 61000-4-30, Class A.

The Model 8345 can be used to:

- Measure RMS values, powers, and disturbances of power distribution networks
- Take snapshots of the main specifications of three-phase networks
- Track variations of different parameters over time

The Model 8345 has a wide array of features that include the following:

- Less than 0.1 % uncertainty for voltage measurements and less than 1 % uncertainty for current measurements
- Large selection of current sensors for measurements that range from a few milliamperes to several kiloamperes
- Built-in rechargeable battery
- Compact and impact-resistant housing
- Large, color, touch-screen graphic display unit
- Up to three user profiles
- SD card for storing a large quantity of measurements and photographs that can be read directly on a PC. You can also use a USB drive (optional)
- Communication via USB, Wi-Fi, or Ethernet
- Remote control from a PC, tablet, or smartphone via the remote user interface (VNC)
- Application software for processing recorded data and generating reports

2.1.1 Recording Functions

The Model 8345 has recording functions for various measurements and calculations:

- RMS values of AC voltages up to 1000 V between terminals. Using ratios, the instrument can reach hundreds of gigavolts
- RMS values of AC currents up to 10,000 A (neutral included). Using ratios, the instrument can reach hundreds of kiloamperes
- Detection of current sensor types and powering of the sensor, if necessary
- DC component of voltages and currents (neutral included)
- RMS voltage and current over minimum and maximum half-cycles (neutral excluded)
- Direct, inverse, and zero sequence voltages and current unbalance
- Inrush current for motor start-up applications
- Peak values of voltages and currents (neutral included)
- (50 and 60) Hz network frequency

- Current and voltage crest factors (neutral included)
- Harmonic loss factor (FHL) for application to transformers in the presence of harmonic currents
- K factor (FK) for application to transformers in the presence of harmonic currents
- 40 alarms per user profile
- Log of events, such as voltage dips, voltage swells, interruptions, transients, rapid voltage changes (RVC), and synchronization
- Total harmonic distortion of currents and voltages (neutral excluded) referred to the fundamental (THD in %f)
- Total harmonic distortion of currents and voltages (neutral included) referred to the AC RMS value (THD in %r)
- Active, reactive (capacitive and inductive), non-active, distorting, and apparent power, per phase and total (neutral excluded)
- Power factor (PF) and displacement factor (DPF or $\cos \varphi$) (neutral excluded)
- Distorting RMS value (d) for currents and voltages (neutral excluded)
- Short-term flicker of voltages (P_{st}) (neutral excluded)
- Long-term flicker of voltages (P_{lt}) (neutral excluded)
- Active, reactive (capacitive and inductive), non-active distorting, and apparent energy, per phase and total (neutral excluded)
- Energy valuation (€, \$, £, etc.) with a basic rate and 8 special rates
- Current and voltage harmonics (neutral included) up to order 63: RMS value, percentages referred to the fundamental (%f) (neutral excluded) or to the total RMS value (%r), minimum and maximum, and harmonic sequence level
- Apparent harmonic power (neutral excluded) up to order 63: percentages referred to the fundamental apparent power (%f) or to the total apparent power (%r), minimum and maximum of one order level
- Current and voltage interharmonics up to order 62 (neutral included)
- Synchronization with UTC with a choice of time zone
- Monitoring mode to check the compliance of the voltages
- Information signals on the CPL (MSV)

2.1.2 Display Functions

The Model 8345 has functions to display the following:

- Waveforms for voltages and currents
- Bargraphs of voltage and current harmonics
- Screenshots
- Instrument information, such as the serial number, software version, MAC, Ethernet, USB, Wi-Fi addresses, and more
- Recordings for trends, alarms, transients, and inrush currents

2.1.3 Measurement Functions

The trend recording (data logging) function offers the following features:

- Time-stamping
- Programming the recording's beginning and end
- Representation, in barcharts or curves, of mean values for many parameters as a function of time, with or without the MIN-MAX
- 4 configurations per user profile

The transients function offers the following features:

- Transient detection and recording for a chosen duration and on a chosen date (the number of transients is limited by the SD card's size)
- Programming of the transient recording's beginning and end
- Recording of 4 complete cycles in the 8 acquisition channels (one recording before the transient-triggering event and three after)
- Possibility of capturing shock waves up to 12 kV over a duration of 1 ms

The alarm function offers the following features:

- A list of alarms recorded as a function of the thresholds programmed in the configuration menu (up to 20,000 alarms)
- Programming the session's beginning and end
- 40 alarms per user profile

The inrush current function displays the following useful parameters for studying motor start-up:

- Instantaneous values of the current and voltage at the cursor's position
- Absolute maximum instantaneous current and voltage over the starting event
- Half-cycle RMS current and voltage (neutral excluded) at the cursor's location
- Maximum half-cycle RMS current and voltage (over the starting event)
- Instantaneous network frequency at the cursor's position
- Maximum, mean, and minimum instantaneous network frequency over the entire starting event
- Time of motor start-up
- Monitoring function: trend, transient and alarm recording

2.1.4 Configuration Functions

The Model 8345 has configuration functions used to:

- Set the date and time
- Adjust the brightness
- Choose the colors of the curves
- Manage the screen's auto-off
- Choose the night mode display
- Choose the language

- Choose the calculation methods: whether non-active quantities are broken down, the unit of energy, the K factor calculation's coefficients, the reference for levels of harmonics, and the calculation of PLT (sliding window or not)
- Choose the distribution system: single-phase, two-phase, or three-phase with or without neutral
- Choose the connection method: standard, 2 elements, or 2½ elements
- Configure the recordings, alarms, inrush currents, and transients
- Erase the data (total or partial)
- Display the current sensors: detected, not detected, not managed, simulated, or impossible to simulate (2-element connection method)
- Adjust the voltage and current ratios, transduction ratios, and sensitivity
- Configure the communication links (Wi-Fi, Ethernet)

2.2 OVERALL VIEW

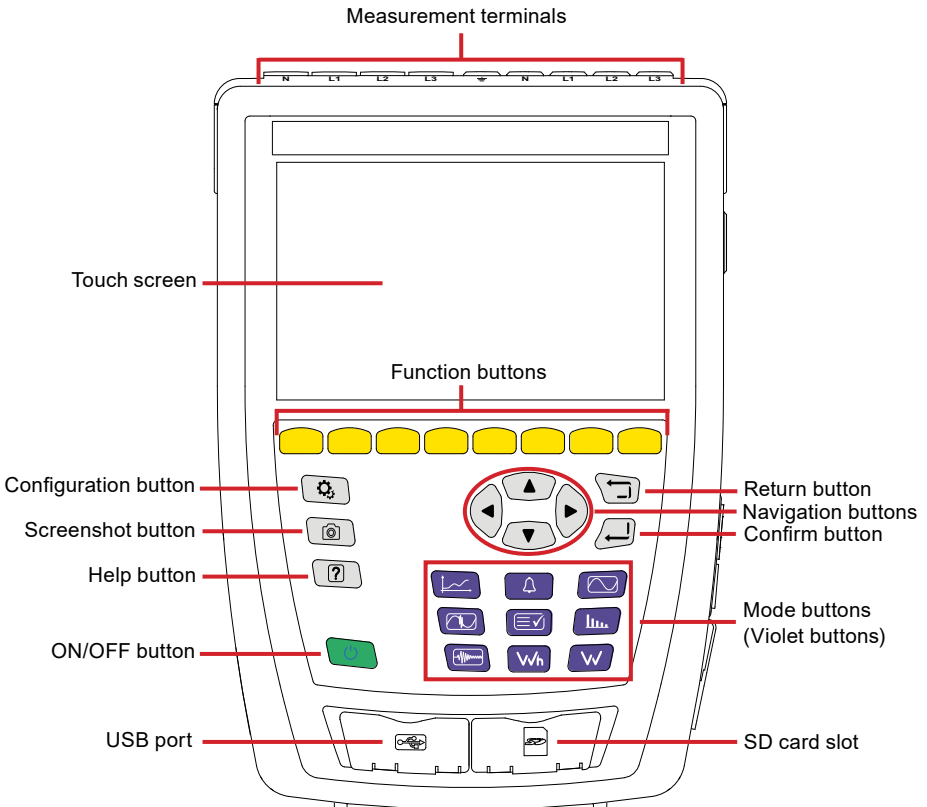

2.3 MEASUREMENT TERMINALS

4 current input terminals
(for current sensors)

5 voltage input terminals

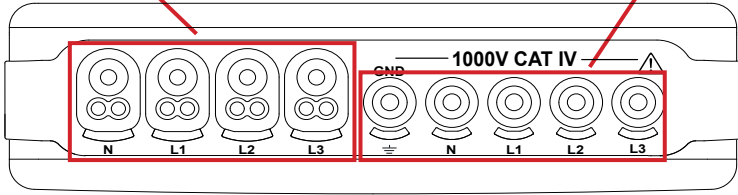



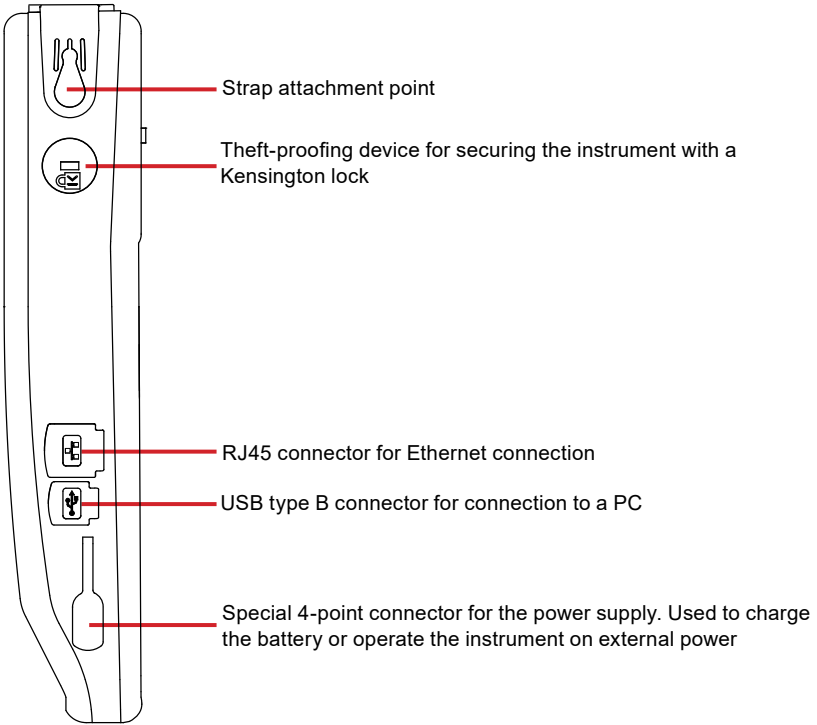



2.4 SIDE CONNECTORS



2.5 BATTERY

The instrument can operate on battery power or wall power. While the battery charges, the instrument can operate on wall power. The battery contributes to the operator's safety, so **do not use the instrument without its battery.**

The instrument's display has a battery indicator icon that shows the battery's status and remaining charge.

	Indicates that the battery is fully charged or that the new battery's charge is unknown
 ,  ,  , or 	Indicates the battery charge level
	Indicates that the battery is fully discharged. You will need to charge the battery completely
 (one bar blinking)	Indicates that the battery is charging

A message will be displayed if the remaining charge of the battery is too low to ensure correct operation of the instrument.

If you do not connect the instrument to an external power source, the instrument will turn off one minute after the message is displayed.

2.6 DISPLAY UNIT



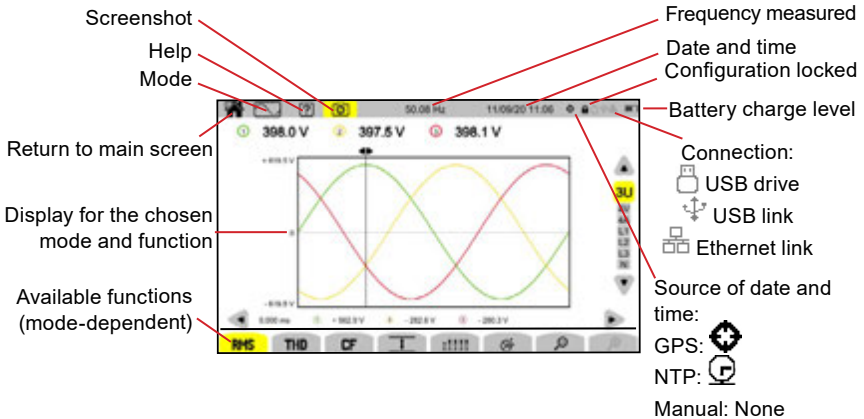

The Model 8345 has a large, color, touch-screen display unit (WVGA).

At the top of the screen, the status bar reports the instrument's status.



An example of a typical screen is below.



2.7 ON/OFF BUTTON

- Use the  button to turn the instrument ON. The  button will blink orange while the instrument is turning on.
- When the battery is charging, the  button will blink green. The button will show steady green when the battery is fully charged.
- If the instrument's power is cut off suddenly or automatically, a message will be displayed the next time it is turned on.
- Press the  button again to turn the instrument off
- The instrument will request confirmation if it is recording or metering energy, (even if metering is suspended), recording transients or alarms, or capturing an inrush current.
- If the power-off command is confirmed, the recordings will finalize, and the instrument will turn OFF. Recordings will automatically resume the next time that the instrument turns on.
- If the instrument is off while connected to external power, the battery will charge.











NOTE: If the display freezes and the instrument does not turn off by pressing the  button, you can force it to turn off by holding the  button for 10 seconds. If the instrument is forced to turn off, any in-progress recordings on the SD card could be lost.



2.8 KEYPAD

2.8.1 Mode Buttons (Purple Buttons)



These nine buttons are used to access specific modes:

Button	Function	See §
	Waveform mode	§ 5
	Harmonics mode	§ 6
	Power mode	§ 7
	Energy mode	§ 8
	Trend mode	§ 9
	Transient mode	§ 10
	Inrush Current mode	§ 11
	Alarm mode	§ 12
	Monitoring mode	§ 13

2.8.2 Navigation Buttons

Button	Function
	Directional buttons
	Confirm button
	Return button

2.8.3 The Other Buttons

Button	Function	See §
	Configuration button	§ 4
	Screenshots button	§ 14
	Help button	§ 15

2.8.4 The Function Buttons (8 Yellow Buttons)

The functions of the yellow buttons depend on the selected mode and context. A button's function for each screen is shown at the bottom of the display.

2.9 INSTALLING THE COLOR CODES

To identify the cords and the input terminals, you can color-code them using the colored markers provided with the instrument.

1. Break off the sector and insert it into the two holes near the terminal. The large sectors are for the current terminals, and the small sectors are for the voltage terminals
2. Clip two rings of the same color onto the ends of the cord that will connect to the terminal.

You have 12 sets of different-colored markers to match the instrument with the color codes in effect.

Large sectors for current terminals

Small sectors for voltage terminals

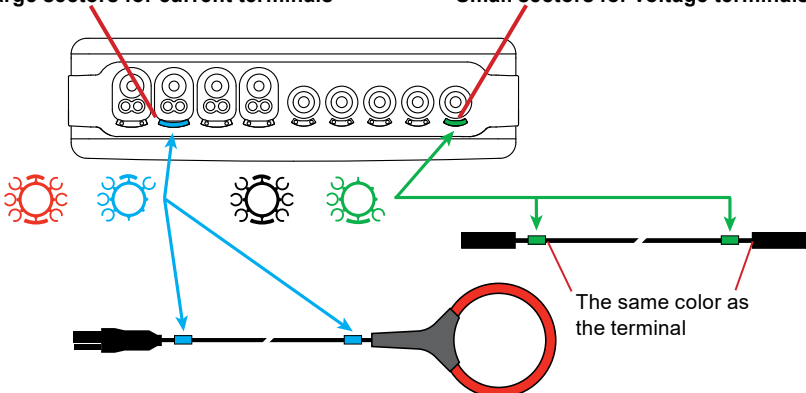

2.10 MEMORY CARD

The instrument is delivered with a formatted SD card that is essential for recording measurements.

The instrument accepts SD (SDSC), SDHC, and SDXC memory cards in FAT16, FAT32, or exFAT format.

To install a new SD card, you will need to:

1. Open the protective cover marked SD.
2. Press on the SD card to remove it from its slot. The red indicator will turn off.
3. Slide the new SD card into the slot until you feel a click. The red indicator will turn on.
4. Then close the SD card protective cover.

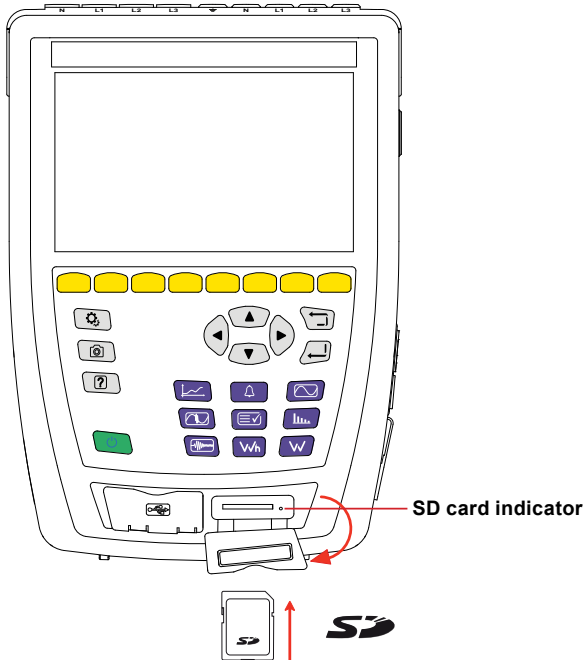

NOTE: Lock the SD card by sliding the tab to the LOCK position when you remove it from the instrument. Unlock the SD card by sliding the tab away from the LOCK position before inserting it into the instrument.

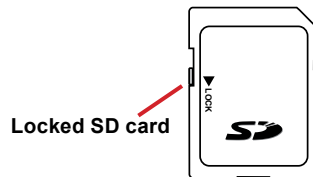
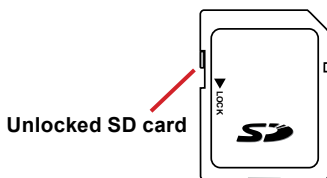

2.11 STAND

The back of the instrument has a retractable stand to hold it at a 60 ° angle.

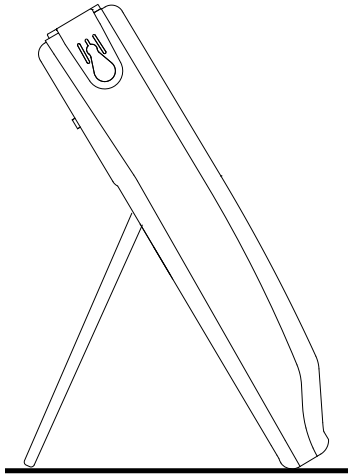

NOTE: Do not insert the leads into the terminals while the instrument is supported by the stand, or the stand could become damaged. The stand is designed only for viewing the display and interacting with the interface from different angles.

2.12 MAGNETIZED HOOK (OPTIONAL)

The magnetized hook can suspend the instrument from the top of a door or attach it to a metallic surface.

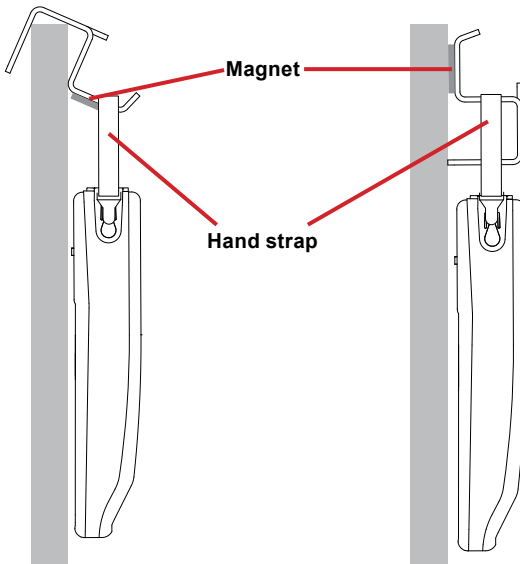

3. CONFIGURATION



NOTE: You must configure your instrument before use.

The configuration screen allows you to set up specific configurations for the instrument's parameters and every measurement mode.

To configure the instrument



To configure the measurements and recordings



User



To lock the configuration

To change user

- Press the  button to access the configuration screen
- Press the  button to configure the measurements
- Press the  button to configure the instrument

3.1 NAVIGATION

The Model 8345's screens are available using the navigation buttons or touch screen.

1. To configure the instrument, use the navigation buttons (◀, ▶, ▲, ▼) or the touch screen to select and modify the parameters.
2. Use the  button to confirm the highlighted selection.
3. Use the  button to cancel or to return to the previous screen.

If you are wearing gloves, we recommend using the navigation buttons instead of the touch screen.

3.2 INPUT KEYBOARD

When a text entry is required, the instrument displays a virtual keyboard. The available characters depend on the context.

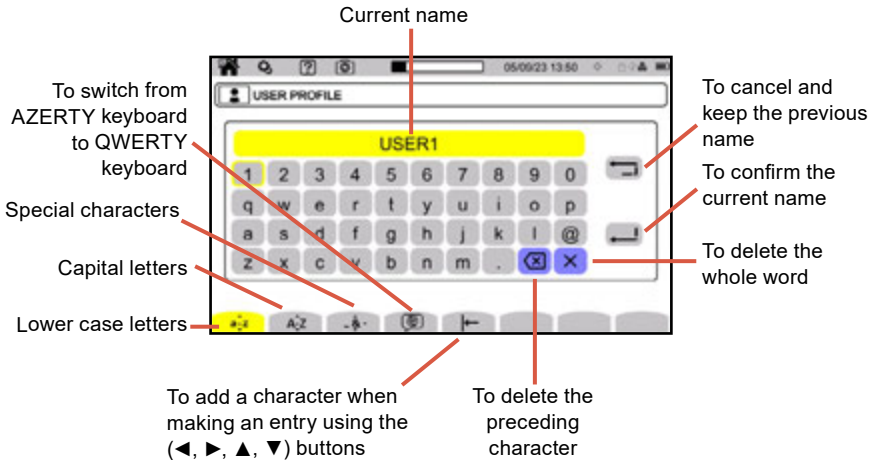

3.3 USERS

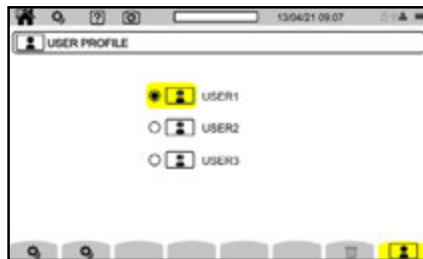

The Model 8345 allows three different users to configure the instrument and measurements. The configuration for each user profile is saved, so multiple users can use the Model 8345 without reconfiguring the instrument for each user.

1. Press  on a configuration screen to access the user profiles and select your user number.



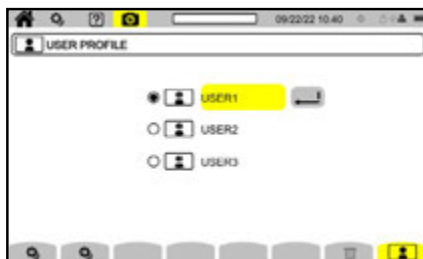

2. Press . The USER PROFILE screen displays the confirm button icon next to the first user profile being selected (see below image). Use the (▲, ▼) directional buttons, to select a different user profile.

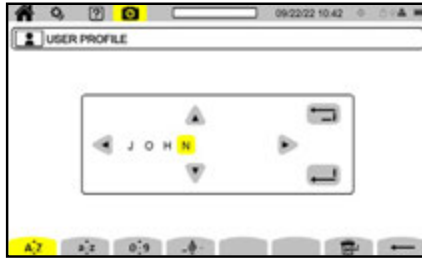

3. Press  to access the details of the user profile. Use the (◀, ▶) directional buttons to select the user name field, and press  again to enable the field name. Now you can edit the name.



4. Enter your desired username (up to 8 characters long) using upper- and lower-case letters (A-Z), numbers (0-9), and symbols (@, -, _, and .), all accessible by the touch screen.
5. Press  to erase the previous character.
6. Press  to erase the selected character and all following characters.
7. Press  to submit the change and return to the USER PROFILE screen which now shows the updated name entered followed by the confirm icon.

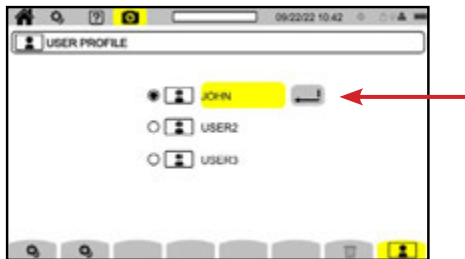



3.4 CONFIGURING THE INSTRUMENT



NOTE: Except for the display and language, the instrument's configuration cannot be changed if the instrument is recording or metering energy, (even if metering is suspended), recording transients or alarms, or capturing an inrush current.

3.4.1 Lock Configuration

Once your instrument is configured, you can lock the configuration by pressing  and entering a password.

The symbol  indicates configuration is locked

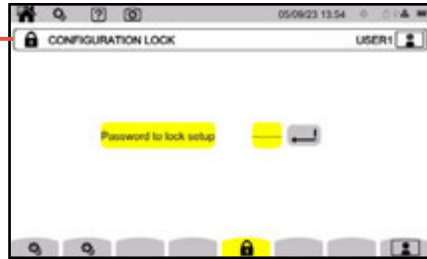

No further configuration parameters can be modified.



NOTE: Keep your password safe, as you will no longer be able to configure your instrument without your password.

To unlock configuration, press  again and enter the password.

If you do forget your password, you can unlock the instrument using PowerPad® IV software, provided it is connected via USB.

3.4.2 Language



1. Press  on the setup screen to enter the language selection screen.



2. Use the navigation buttons or touch screen to highlight the language for your instrument.
3. To confirm the selected language, use the  button or the touch screen to select the desired language option.

Refer to § 1.7 for more information.

3.4.3 Date and Time

- Press  to set the date and time
- Press  to choose from 73 available time zones

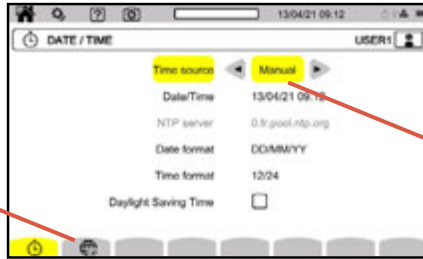

The time can be set automatically (GPS or NTP) or by hand

Choice of time zone



Choose one of the 73 time zones proposed

- For **Time source**, choose between NTP server, GPS, and Manual for your desired method to set the date and time
- For **Date/Time**, enter the date and time if on Manual mode; otherwise, this field is grayed out and view only
- For **NTP server**, enter the NTP server address that you would like to use to set the date and time
- For **Date format**, select your desired date format from MM/DD/YY, DD/MM/YY, and YY/MM/DD
- For **Time format**, choose whether to display time in 12 h or 24 h format
- For **Daylight Saving Time**, check the box to apply Daylight Saving Time

3.4.3.1 Manual Mode

This mode allows the date and time to be entered manually. For Class A internal clock accuracy and drift (according to IEC 61000-4-30), select the GPS Mode.

3.4.3.2 GPS Mode

The GPS mode is necessary to guarantee that your instrument is Class A (per IEC 61000-4-30). The instrument must have access to the GPS satellites at least once to receive the date and time. The instrument could take up to 15 minutes to synchronize.

The instrument will maintain accuracy in the following situations, even if the satellites are no longer accessible.

Satellites in View	Maximum Drift (Class A)	Drift (Model 8345)
None	± 1 s / 24 h	± 24 ms / 24 h
One or more	± 16.7 ms vs UTC at all times	± 60 ns / 1 s corrected at all times

To avoid time discontinuities, you cannot set the time automatically when a recording is in progress.

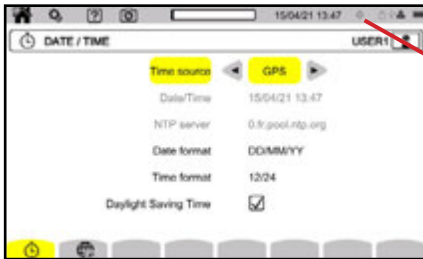

Status of time synchronization via GPS

The satellite reception status is indicated by an icon (📶) in the status bar.

GPS Synchronization	Not Synchronized		Synchronized	
	None	One or more	None	One or more
None	📶	📶	📶	📶
No recording	📶	📶	📶	📶
Recording in progress	📶	📶	📶🔒	📶🔒

After 40 days with no exposure to a GPS satellite, the synchronization icon (📶) will change to unsynchronized (📶).

3.4.3.3 NTP Mode



Time synchronization by NTP:
 📶 Not synchronized
 📶 Synchronized
 📶🔒 Synchronized and recording in progress

1. If you choose time synchronization by NTP, enter the address of the NTP server in the NTP server field (Example: 0.fr.pool.ntp.org).
2. Select your country's time zone.
3. Connect the instrument to the server via Ethernet connector or Wi-Fi.

The time synchronization status is indicated by an icon (📶) in the status bar.

3.4.4 Display

- Press  to open the configuration menu for the display

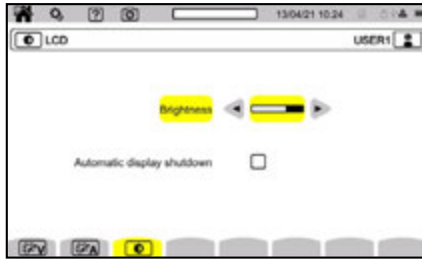

3.4.4.1 Colors of the Voltage Curves

1. Press  to choose the colors of the voltage curves.
2. Choose a color for each of the 3 phases and neutral.

In night mode, the background changes from white to black.

3.4.4.2 Colors of the Current Curves

1. Press  to choose the colors of the current curves.
2. Choose one color for each of the 4 current inputs.



In night mode, the background changes from white to black.

3.4.4.3 Screen Brightness and Auto-Off



You can activate or deactivate the screen's auto-off. If activated, the screen will automatically turn off after 10 minutes with no user action, which helps prolong battery life. If a recording is in progress, the screen will not automatically turn off.

- Select  to adjust the screen's brightness and auto-off
- Press any button to turn the screen back on

3.5 MEMORY (SD CARD, USB DRIVE)



Access to the contents of the memory (SD card or USB drive) are in the instrument configuration menu. Press the  button then the second function button .

All recordings are saved in the external memory. Select  to access external memory.

The screen indicates the content of the SD card  or USB drive .

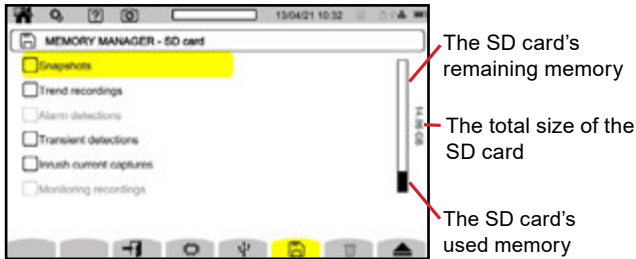
The bars at the top and at the right side of the screen show the SD card's used space in black and the remaining space in white. The SD card's total size is to the right of the bar.



1. Press  to manage the external memory's content.
2. To view an item in detail, select it and press .
3. Press  to eject the SD card or USB drive.







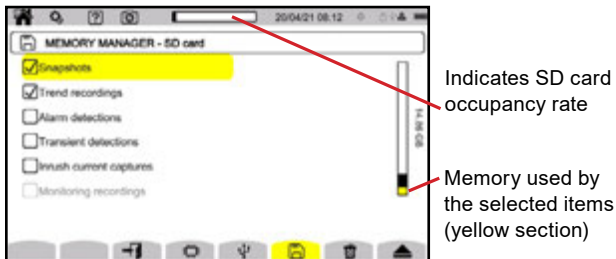

NOTE: You must eject the SD card before removing it from the instrument; otherwise, you risk losing its content.

When the SD card is removed, the red SD card present indicator will turn off and the  symbol will be displayed in the status bar.



You can erase all or part of the memory's content.



1. Select the items from memory that you would like to erase. Once selected, the display will indicate each item's size to the right of the selected item on the same line. The yellow bar at the right side of the screen indicates the total memory used by the selected items.
2. To view a selected item in detail, press .
3. Press  to erase the selection. The instrument will request confirmation .
4. Press  to confirm or  to abort.
 - To delete other user profiles, press . Deleting a user profile is the equivalent of returning it to the factory configuration.
 - To copy all or part of the SD card's contents to a USB drive, press .

3.6 INFORMATION



Information about the instrument can be found in the instrument configuration.

Press the  button then the second function button .

Select  to view information about the instrument.

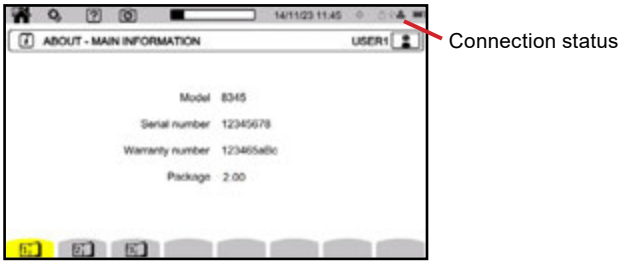
The instrument's connection status is indicated in the top right of the display.



The information pages (, , , etc.) allow you to look up complete information about the instrument, such as:

- warranty number
- serial number
- software and hardware versions
- MAC, Ethernet, and Wi-Fi addresses



3.7 COMMUNICATION

The instrument can communicate:

- via USB
- via Wi-Fi
- via an Ethernet connection

It can also send emails when alarm setpoints are exceeded.

Communication configuration can be found in the instrument configuration.

Press the  button then the second function button .

Select  to open the network configuration menu of the instrument.



The following screen will be displayed:



Connection status



Press to enable connection via an Ethernet connection



Press to enable configuration of the Wi-Fi access point (WAP)



Press to enable Wi-Fi connection





Press to configure email



Press to connect to the DataViewSync™



NOTE: Only one link (Ethernet, Wi-Fi or Wi-Fi access point) can be activated at a time.

For example, if you want to activate a Wi-Fi link while an Ethernet link is already activated, the instrument suggests you turn OFF the Ethernet link by displaying . Confirm with the  button or cancel by pressing any other button.

You can also stop a link manually by pressing .

3.7.1 Ethernet Link

The  symbol indicates that the link is active.

The  symbol indicates that the link is inactive and that it can be activated.

To modify a link, it must be stopped by pressing .

- Press  in the screen's bottom right to deactivate an active link. Once deactivated, the link can be modified.

If no link is active, no action is needed.

- Press  to activate the link.

- For **DHCP** (Dynamic Host Configuration Protocol), select whether to update the IP address automatically or manually.

If selected, the instrument will request the IP address and other parameters from a DHCP server and will generate an IP address automatically if no DHCP server replies.

If deselected, you must assign the IP address and parameters manually.

3.7.2 Wi-Fi Access Point (WAP) Link

The instrument creates a local Wi-Fi network that allows it to connect to a PC, smartphone or tablet.

To select an access point operating frequency



Select the security type:

- **WPA2-PSK** secure protocol and enter the password
- **Open** without password

Press  to activate the link.

3.7.3 Wi-Fi Link

The Wi-Fi link allows connection of the instrument to an existing Wi-Fi network.



Choose your network by clicking on SSID.

The instrument shows you all available Wi-Fi networks.

If you do not see your network, press  to search.



If it is a hidden network, enter its name.



To select the **SSID** or network name, use the   buttons or the touch screen.



NOTE: Only one link (Ethernet, Wi-Fi or Wi-Fi access point) can be activated at a time. As a result, the display of networks available for connection does not work (SSID grayed out) if another type of link is already activated.

The  symbol indicates that the link is active.

The  symbol indicates that the link is inactive and that it can be activated.

- To change a link, it must be stopped by pressing . Press  in the screen's bottom right to deactivate an active link before modifying the link.
- Uncheck DHCP to select manual and modify the parameters. Then press  to reactivate the link.

If no link is active, no action is needed.

- For **SSID**, choose the network to connect to the instrument.
- If your network is not shown, press  to search for available networks.
- For **Password**, enter the password for the selected SSID, if required.
- For **DHCP** (Dynamic Host Configuration Protocol), select whether to update the IP address automatically or manually.

- If selected, the instrument will request the IP address and other parameters from a DHCP server and will generate an IP address automatically if no DHCP server replies.
- If deselected, you must assign the IP address and parameters manually.
- Press  to activate the link.

3.7.4 Email

Enter the email address for notifications if an alarm threshold is exceeded. The instrument must be connected to DataViewSync™.



Enables checking operation of the DataViewSync™ link by sending a test email to the configured email address

For **Recipient**, enter an email address to receive notifications if an alarm threshold is exceeded

3.7.5 DataViewSync™

DataViewSync™ is a protocol used for communication between two peripherals located in two distinct sub-networks, like a PC and measuring instrument. Each peripheral connects to DataViewSync™, and DataViewSync™ links the two peripherals together.



- This screen displays the instrument identifier (warranty number).
- You can choose the password.
- There is a password for each user.



NOTE: We recommend utilizing DataViewSync™ for configuring test measurements, and directly connecting to a PC for generating reports involving large packets of data.

- The **Device name** is the device's serial number. It is used by DataViewSync™ to connect to the device and cannot be changed.
- The **Password** must contain at least 12 characters, including an upper case letter, a lower case letter, a number and a special character. If the password does not comply with these guidelines, it will be displayed in red. To change the password, you must disconnect the instrument from DataViewSync™ and therefore stop the active connection (deactivate the active link).

- Connection to DataViewSync™ is automatic as soon as an Ethernet, Wi-Fi or Wi-Fi access point link is activated. When the connection is made, the ✓ symbol is displayed above the  button.
- The connection to DataViewSync™ will be used to launch a remote measurement campaign.
- To connect to the instrument, you will need to enter its identifier and password.

3.8 UPDATING THE EMBEDDED SOFTWARE

As updates for the Model 8345 become available, you are able to update the embedded software via the update screen.

Press  in the instrument configuration menu to open the update screen for the embedded software.



Refer to § 18.5 for more information about the firmware updates.

When the instrument locates updated software on the USB drive or SD card, the instrument will display information about the updated version and ask if you would like to install.

For example, if the SD card has an update, the instrument will locate it and display the following screen.



Press . The instrument will shut down. The next time it starts up, it will boot into a mode specifically for software updates.

If it does not reboot into the software updates mode, turn the instrument OFF, and restart while holding down the  and  buttons until the below Recovery screen appears.



From the update screen shown below, select the method to use to update the software. Select:



to update from the AEMC® Instruments web site via Ethernet link





to update from the SD card



to update from USB drive



When the update method has been selected, press  to download the file (this may take several minutes). When file download has completed, press  to begin the update.

3.9 CONFIGURING THE MEASUREMENT



NOTE: The measurement configurations cannot be altered if the configuration is locked, the instrument is recording or metering energy (even if metering is suspended), recording transients or alarms, or capturing inrush currents.

Before making measurements, you must specify the following:

- Calculation methods
- Distribution network
- Type of connection
- Voltage ratios
- Current sensors, their ranges, and their ratios
- Values to record in Trend mode
- Triggering levels for the transient and inrush current capture modes
- Alarm thresholds for Alarm mode
- Units and ranges for Energy mode
- Monitoring mode's parameters (using the application software)

3.9.1 Calculation Methods

Press the **X=** button to determine the calculation methods.

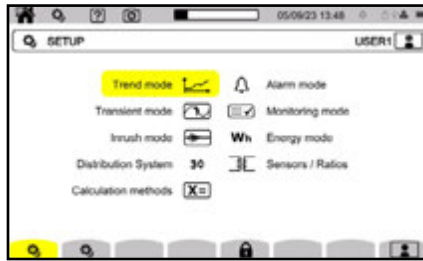

3.9.1.1 Nominal Values

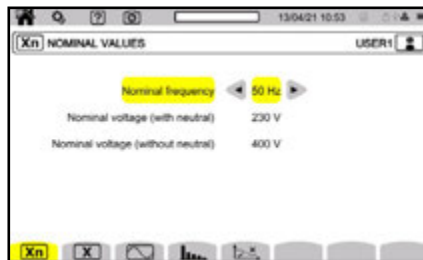

Xn to specify the nominal values.

- The nominal frequency (50 or 60) Hz
- The nominal voltage
- The nominal voltage between phases



NOTE: Single-phase and phase-to-phase voltage ratings can be set independently. Remember to set them both correctly.

- Press the **Xn** button to configure the nominal values.
- For **Nominal frequency**, choose either (50 or 60) Hz.
- For **Nominal voltage (with neutral)**, enter the nominal voltage (with neutral) to use in measurements and calculations.
- For **Nominal voltage (without neutral)**, enter the nominal voltage (without neutral) to use in measurements and calculations.



The nominal voltage configured here is the Nominal System Voltage (U_n) and not the Nominal Declared Input Voltage (U_{din}) on the instrument's terminals. It is possible to configure U_n between 50 V and 650 kV, but **U_{din} must never exceed 1000 V between phases and 400 V between Phase and Neutral.**

In the case of medium-voltage or high-voltage networks, a step-down transformer may be located between the network and measuring instrument. The uncertainty on the step-down transformer's ratio affects the measurement's accuracy. The measurement is guaranteed only when $U_{din} = U_n$ and the ratio is equal to 1.

3.9.1.2 Real Time Values

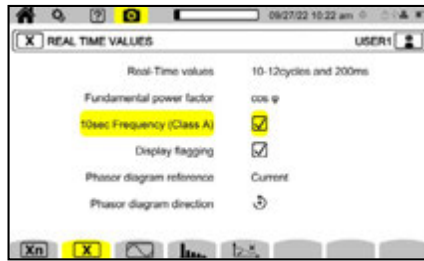
- Press the  button to configure the real-time values.



- For **Real-Time values**, choose either 10/12 cycles and 200 ms or 150/180 cycles and 3 s. This choice will apply to the value's calculation and display in most modes.
- For **Fundamental power factor**, choose DPF, PF1, or $\cos \varphi$ for the display.
- For **10sec Frequency (Class A)**, select whether to include the calculation of the frequency over 10 s (per IEC 61000-4-30 Class A) or not. If you are only measuring current, deactivate this choice.
- For **Display flagging**, choose whether or not display flagging is activated.
- When activated, all quantities that undergo voltage dips, voltage swells, and interruptions will be reported (see § 3.10.8).
- For **Phasor Diagram Reference**, choose between current and voltage.
- For **Phasor Diagram Direction**, choose between  (clockwise) and .

3.9.1.3 Waveform Mode

- Press the  button to configure the parameters of waveform mode.

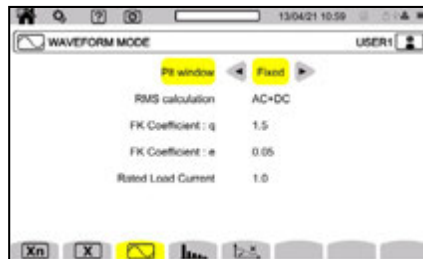

- For **Long Term Flicker window**, select the P_{it} flicker calculation method.
- If **Sliding** is selected, the P_{it} is calculated every 10 minutes. The first value will be available 2 hours after the instrument turns on because P_{it} requires 12 values of P_{st} .
- If **Fixed** is selected, the P_{it} is calculated every 2 hours.
- For **RMS Calculation**, select the method to use for RMS calculation.

- For **FK Coefficient: q**, choose a value between 1.5 and 1.7 to use for the K factor calculation. The exponential constant q depends on the type of winding and the frequency.
- A value of 1.7 is suitable for transformers where the conductor cross sections are round or square.
- A value of 1.5 is suitable for transformers where the low-voltage windings are in foil form.
- For **FK Coefficient : e**, choose a value between 0.05 and 0.10 for the K factor calculation.
- The e value represents the ratio of Eddy current losses at the fundamental frequency to resistive losses at the reference temperature.
- The default values for the FK coefficients (q = 1.7 and e = 0.10) are suitable for most applications.
- **Rated Load Current:** Is a transformer parameter that is used in the calculation of the K factor.

3.9.1.4 Harmonic Mode

- Press the **Harmonics** button to configure the parameters of harmonic mode.

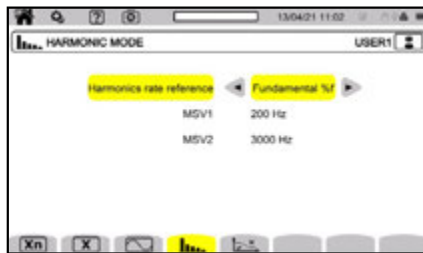

- For **Harmonics rate reference**, select either fundamental (%f) or RMS (%r).
- For **MSV1**, input a value for the first flagging frequency.
- For **MSV2**, input a value for the second flagging frequency.
- The MSV duration (1 to 120) s. This is the duration during which the MSV is examined to determine its maximum value, from the moment the threshold was crossed.
- The MSV threshold (0 to 15) % nominal voltage. The nominal voltage is that defined in § 3.9.1. This may be a phase-neutral voltage (V) or a phase-phase voltage (U) depending on the type of connection.

The MSV duration and threshold apply to both monitored MSV frequencies. As soon as the threshold is crossed, the voltage concerned (MSV1, MSV2 or both) is monitored for the requested duration. The maximum will be recorded in the event log.

3.9.1.5 MSV Template

- Press the  button to configure the curve of maximum MSV voltages as a function of the frequency.

There are 5 modifiable preset points to define the curve. This curve will be displayed with the MSV versus frequency curve.

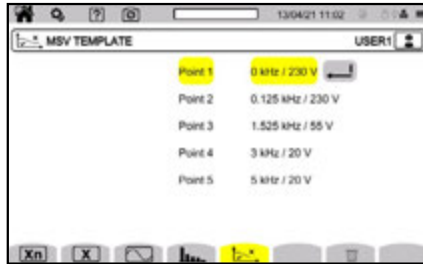

3.9.2 The Distribution Network and the Type of Connection

- Select **3Φ** to choose the connection of the instrument according to the distribution network.

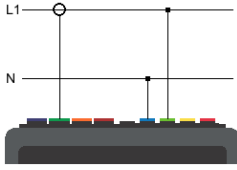
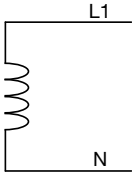
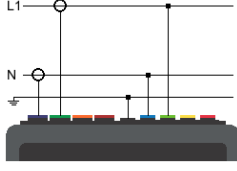
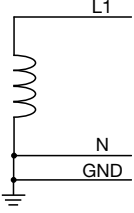

Each distribution system corresponds to one or more network types.

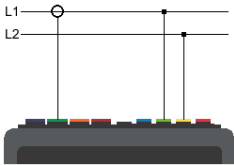
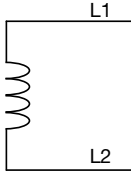
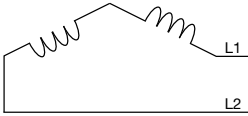
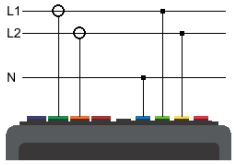
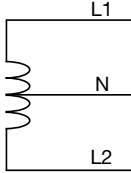
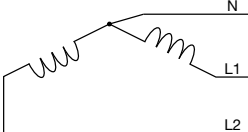
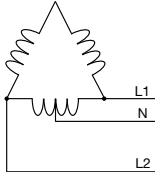
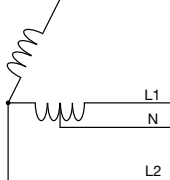
Distribution System	Network	Electrical Diagram
 <p>Single-phase 2 wires (L1 and N)</p>	Single-phase 2 wires with neutral without earth	
 <p>Single-phase 3 wires (L1, N, and earth)</p>	Single-phase 3 wires with neutral and earth	

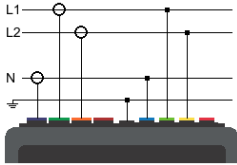
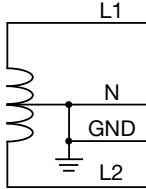
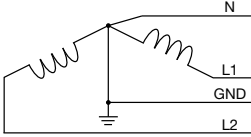
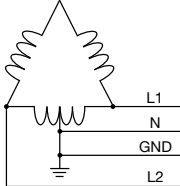
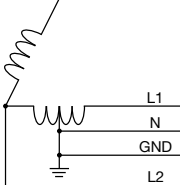
Distribution System	Network	Electrical Diagram
 <p data-bbox="200 365 313 446">Split-phase 2 wires (L1 and L2)</p>	<p data-bbox="501 207 614 256">Split-phase 2 wires</p>	
	<p data-bbox="495 370 620 443">Three-phase 2 wires in open star</p>	
 <p data-bbox="184 912 330 993">Split-phase 3 wires (L1, L2, and N)</p>	<p data-bbox="492 529 623 634">Split-phase 3 wires with neutral without earth</p>	
	<p data-bbox="492 699 623 829">Split-phase 3 wires in open star with neutral without earth</p>	
	<p data-bbox="474 883 641 1013">Split-phase 3 wires in high leg delta with neutral without earth</p>	
	<p data-bbox="447 1075 668 1205">Split-phase 3 wires in open high leg delta with neutral without earth</p>	

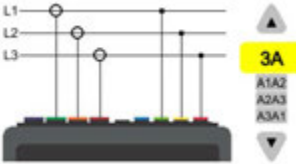
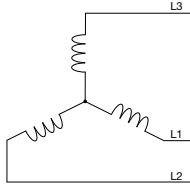
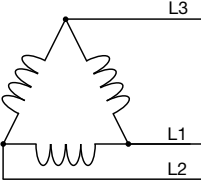
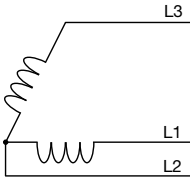
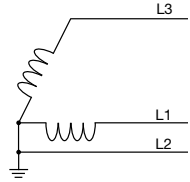
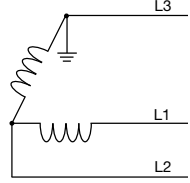
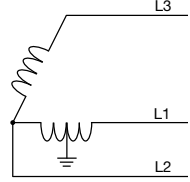
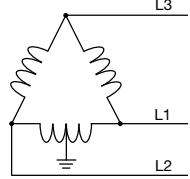
Distribution System	Network	Electrical Diagram
 <p data-bbox="153 591 360 670">Split-phase 4 wires (L1, L2, N, and earth)</p>	<p data-bbox="451 201 666 277">Split-phase 4 wires with neutral and earth</p>	
	<p data-bbox="451 386 666 488">Three-phase 4 wires in open star with neutral and earth</p>	
	<p data-bbox="451 581 666 683">Three-phase 4 wires in high leg delta with neutral and earth</p>	
	<p data-bbox="451 787 666 889">Three-phase 4 wires in open high leg delta with neutral and earth</p>	

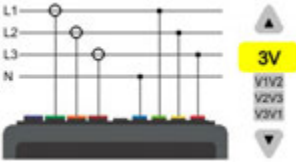
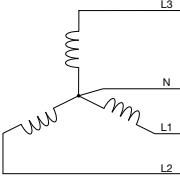
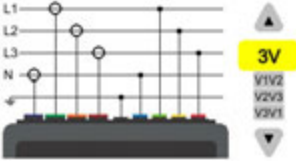
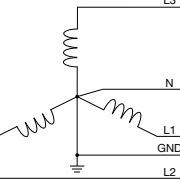
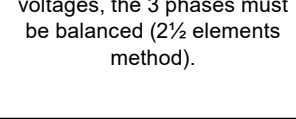
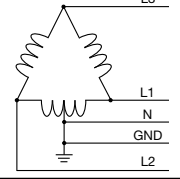
Distribution System	Network	Electrical Diagram
 <p data-bbox="181 610 334 686">Three-phase 3 wires (L1, L2, and L3)</p> <p data-bbox="107 696 402 800">Indicate the current sensors that will be connected: all 3 sensors (3A) or only 2 (A1 and A2, A2 and A3, or A3 and A1).</p> <p data-bbox="107 808 407 912">If 3 sensors are connected, the calculation will be completed by the 3 wattmeters with virtual neutral method.</p> <p data-bbox="107 920 405 997">If 2 sensors are connected, the calculation will be done by the Aron method.</p> <p data-bbox="107 1005 405 1135">For a 2-sensor connection, the third sensor is not needed if the other two sensors are identical (same type, same range, and same ratio).</p> <p data-bbox="107 1143 405 1214">Otherwise, the third sensor must be connected for current measurements.</p>	<p data-bbox="495 196 620 272">Three-phase 3 wires in star</p>	
	<p data-bbox="485 404 630 451">Three-phase 3 wires in delta</p>	
	<p data-bbox="495 583 620 659">Three-phase 3 wires in open delta</p>	
	<p data-bbox="476 745 639 876">Three-phase 3 wires in open delta with link to earth between phases</p>	
	<p data-bbox="476 938 639 1070">Three-phase 3 wires in open delta with link to earth on the phase</p>	
	<p data-bbox="447 1159 668 1235">Three-phase 3 wires in open high leg delta</p>	
	<p data-bbox="476 1352 639 1429">Three-phase 3 wires in high leg delta</p>	

Distribution System	Network	Electrical Diagram
 <p>Three-phase 4 wires (L1, L2, L3, and N)</p> <p>Indicate which voltages will be connected: all 3 voltages (3V) or only 2 (V1V2, V2V3, or V3V1).</p> <p>If you connect only 2 voltages, the 3 phases must be balanced (2½ elements method).</p>	<p>Three-phase 4 wires with neutral without earth</p>	
 <p>Three-phase 5 wires (L1, L2, L3, N, and earth)</p> <p>Indicate which voltages will be connected: all 3 (3V) or only 2 (V1V2, V2V3, or V3V1).</p> <p>If you connect only 2 voltages, the 3 phases must be balanced (2½ elements method).</p>	<p>Three-phase 5 wires in open high leg delta with neutral without earth</p>	
 <p>Three-phase 5 wires (L1, L2, L3, N, and earth)</p> <p>Indicate which voltages will be connected: all 3 (3V) or only 2 (V1V2, V2V3, or V3V1).</p> <p>If you connect only 2 voltages, the 3 phases must be balanced (2½ elements method).</p>	<p>Three-phase 5 wires in star with neutral and earth</p>	
 <p>Three-phase 5 wires in open high leg delta with neutral and earth</p>	<p>Three-phase 5 wires in delta with neutral and earth</p>	

3.9.3 Sensors and Ratios

- Press $\boxed{\text{F}}$ to select the voltage ratios and current sensor's ratios and range.

3.9.3.1 Voltage Ratio

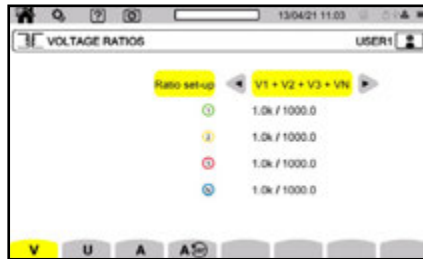

Voltage ratios are used when the voltages are too high for the instrument and voltage transformers are used to lower them. The ratio lets you display the true voltage and use it in the calculations.

To choose the voltage ratios, select **V** for phase-to-neutral voltages (neutral included) or **U** for phase-to-phase voltages (neutral excluded).

- **4V 1/1 or 3U 1/1**: every channel has the same ratio.
- **4V or 3U**: every channel has the same ratio to be programmed.
- **3V+VN**: every channel has the same ratio; the neutral has a different ratio.
- **V1+V2+V3+VN or U1+U2+U3**: every channel has a different ratio.

For ratios, the primary voltages are expressed in V and can be assigned a multiplier factor.

- nothing = x1,
- k = x 1,000,
- M = x 1,000,000

Secondary voltages are expressed in V.





To avoid calculations, you can use a multiplier $1/\sqrt{3}$ for both the primary voltages and secondary voltages.



NOTE: The ratios for single voltages **V** and the ratios for composite voltages **U** can be set separately. Don't forget to set these two ratios if you intend to measure these two types of voltage.

3.9.3.2 Current Sensors

■ Select **A** in function bar to choose the ratios and ranges of the current sensors. The instrument will automatically display the detected current sensor models. The different current sensors are:

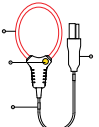
	MN93 clamp (200 A)	
	MN193 clamp (100 A) MN193 clamp (5 A)	■ [1 to 60,000] / {1; 2; 5}
	SR193 clamp (1000 A)	
	MR193 clamp (1000 A)	
	E94 clamp	Choice of sensitivity: ■ sensitivity 10 mV/A, range 100 A ■ sensitivity 100 mV/A, range 10 A
	AmpFlex® 193	■ Choice of range: ■ (0.10 to 100.0) A ■ (1.0 to 1000) A ■ 10 A to 10.00 kA
	MiniFlex® MA194-24-BK	Choice of range: ■ (0.10 to 100.0) A ■ (1.0 to 1000) A ■ 10 A to 10.00 kA

Current ratios are used (only for the sensors concerned) when the currents are too high for the instrument and current transformers are used to lower them. The ratio allows you display the true current and use it in the calculations.

- **4A:** every channel has the same ratio
- **4A+AN:** every channel has the same ratio; the neutral has a different ratio
- **A1+A2+A3+AN:** every channel has a different ratio

For the ratio, the primary current cannot be less than the secondary current.

When two current sensors of the same type and same ratio are connected in a three-phase, three-wire setup, the instrument will simulate the third sensor and give it the same specifications as the other sensors. The connection configuration must indicate which sensors will be present. Then, the instrument will show the third sensor as simulated.

This menu will only appear for the sensors referenced in the previous table.

3.9.3.3 Reversing the Current

If your current sensors are connected and you notice that one or more sensors are not correctly oriented during the measurement, you can easily reverse them without physically reorienting them.

- Press **A**  to reverse a current sensor.

3.10 CONFIGURING RECORDINGS



Before taking recordings, the following settings must be defined or adapted:

- The values to be recorded, in the trend mode.
- The triggering levels for the transient and inrush current capture modes.
- The alarm thresholds, for the alarm mode.
- The units and the ranges for the energy mode.
- The parameters of the monitoring mode (using the PowerPad® IV application software).

Recording mode settings can also be changed within each recording mode.



NOTE: The recording configuration cannot be changed if the configuration is locked or if the instrument is recording, counting energy (even if counting is suspended), recording transients, alarms or capturing inrush current.

3.10.1 Quick Programming of a Recording (QuickStart)

For repeated recordings of trends, transients, alarms and inrush current, it is possible to pre-configure certain recording parameters using the quick configuration  (QuickStart).

These parameters are:

- duration
- choice of one of the four possible configurations (for trend recordings)
- maximum number of events to be recorded (for transient and alarm recordings)
- aggregation period (for trend recordings)
- name of the recording

In this way, you can quickly start a recording without having to program the date and time for the start and end of the recording.

The recording will start:

- in the next 10 seconds for inrush mode
- at the end of the current minute + one minute for trend, transient, alarm and monitoring modes

3.10.2 Trend Mode

The Trend mode  is used to record different quantities for a specified duration. Every quantity that the instrument measures can be recorded.

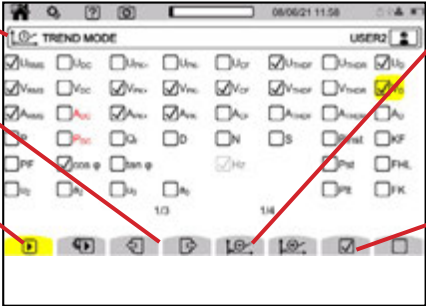

Configuration in progress

The quantities to record are on 3 pages

Choose the quantities to record

There are 4 possible programmable configurations, $\uparrow\text{O}$, $\uparrow\text{O}$, $\uparrow\text{O}$ and $\uparrow\text{O}$. To change from one to the other, use the $\uparrow\text{O}$ or $\downarrow\text{O}$ button.

Select or deselect all the page's parameters

- Press  to configure the Trend mode.
- Select the quantities to record. The frequency (Hz) is always selected.

For more information about these quantities, refer to the glossary in § 19.13.

Red quantities are incompatible with the configuration, or the current sensors used, and cannot be recorded.

Pages 2 and 3 concern the recording of harmonics and inter-harmonics. For each of these quantities, you can select the orders of the harmonics or inter-harmonics to record (between 0 and 127) and, if desired, select to record the odd-numbered harmonics only.



19/09/23 09:52

19/09/23 09:53

001 → 009

000 → 005

000 → 127

001 → 126

000 → 126

Odd only

Odd only

Odd only

2/3 1/4 3/3 1/4

Levels of harmonics of order 01 will be displayed only when they concern values stated in %r.

For repeated recordings, press the  (QuickStart) button, which can be used to set the recording's length, setup, recording period, and name.



- For **Duration**, enter the trend recording's duration between 1 min and 2 hr.
- For **Set-up**, choose a configuration from four user-defined configurations.
- For **Period**, choose the recording period from the 19 available options between 200 ms and 2 h.
- For **Name**, enter the recording's name (up to 8 characters long) using capital letters (A-Z), numbers (0-9), and symbols (&, _, and -).

3.10.3 Transient Mode

The Transient mode  is used to record voltage or current transients for a specified duration. It can also record fast transients (surges) if the hookup includes an earth connection.

- Select  to configure the Transient mode.

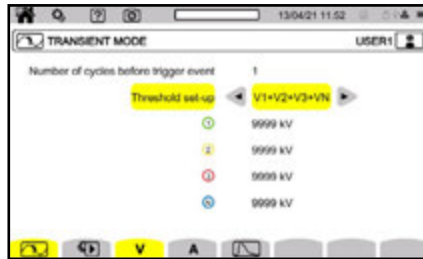

3.10.3.1 Voltage Thresholds

- Press **V** to configure the voltage thresholds.
- For **Number of cycles before trigger event**, choose the number of cycles between 1 and 3 that will occur before the transient recording is triggered.
- For **Threshold set-up**, define the relationship between the thresholds and voltage inputs. You can enter thresholds from 0 V to 9999 kV.
 - If **4V** is selected, every voltage input has the same threshold, so there is only one threshold to configure.
 - If **3V+VN** is selected, every voltage input has the same threshold, but the neutral has a different threshold. There are two thresholds to configure.
 - If **V1+V2+V3+VN** or **U12+U23+U31** is selected, every voltage input and the neutral have different thresholds, so there are four thresholds to configure.

3.10.3.2 Current Thresholds

- Select **A** to configure the current thresholds.
- For **Number of cycles before trigger event**, choose the number of cycles between 1 and 4 that will occur before the transient recording is triggered.
- For **Threshold set-up**, define the relationship between the thresholds and current inputs. You can enter thresholds from 0 mA to 9999 kA.
 - If **4A** is selected, every current input has the same threshold, so there is only one threshold to configure.
 - If **3A+AN** is selected, every current input has the same threshold, but the neutral has a different threshold. There are two thresholds to configure.
 - If **A1+A2+A3+AN** is selected, every voltage input and the neutral have different thresholds, so there are four thresholds to configure.

3.10.3.3 Shock Wave Thresholds

- Select  to configure the voltage thresholds of shock waves with respect to earth.
- For **Threshold set-up**, define the relationship between the thresholds and voltage inputs. You can enter thresholds from 0 V to 2000 MV.
 - If **4VE** is selected, every voltage input has the same threshold, so there is only one threshold to configure.
 - If **3VE+VNE** is selected, every voltage input has the same threshold. The neutral has a different threshold, so there are two thresholds to configure.
 - If **V1E+V2E+V3E+VNE** is selected, every voltage input and the neutral have different thresholds, so there are four thresholds to configure.

3.10.3.4 Rapid Capture Configuration

For repeated recordings, press the  (QuickStart) button, which can be used to set:

- For **Duration**, enter the length of the capture between 1 min and 99 d.
- For **Max count**, enter the maximum number of transients in the capture between 1 and 1000.
- For **Name**, enter the capture's name (up to 8 characters long) using capital letters (A-Z), numbers (0-9), and symbols (&, _, and -).

3.10.4 Inrush Current Mode

The Inrush Current mode  is used to capture inrush currents.

- Select  to configure the inrush current mode.

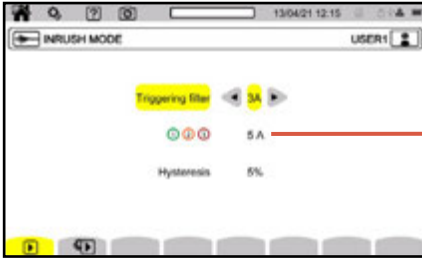

The threshold takes into account the present current, in order to detect the appearance of an additional current

- For **Triggering filter**, determine whether the inrush current threshold will apply to all 3 current inputs (3 A) or only one of them (A1, A2, or A3).
- Enter a current threshold between 0 mA to 9999 kA for the selected current inputs. The threshold detects the appearance of an additional current by accounting for the current present.
- For **Hysteresis**, choose from (0 to 100) % for the capture's hysteresis.

The first threshold triggers the capture, and the hysteresis stops the capture.



NOTE: For more information about the hysteresis, refer to § 19.6. Setting the hysteresis to 100 % is equivalent to not having a stop threshold.

For repeated recordings, press the  (QuickStart) button, which can be used to set:

- For **Duration**, enter the length of the capture between 1 min and 99 d.
- For **Max count**, you cannot modify this field. It is grayed-out because the number of captures is always 1.
- For **Name**, enter the capture's name (up to 8 characters long). The name can include capital letters (A-Z), numbers (0-9), and symbols (&, _, and -).

3.10.5 Alarm Mode

The Alarm mode  is used to monitor one or more quantities, either in absolute value or in signed value. Whenever a quantity crosses the user-defined threshold, the instrument will record information about the occurrence.

Alarm active or not

Monitored quantity

Period of calculation of the quantity

Channels to monitor

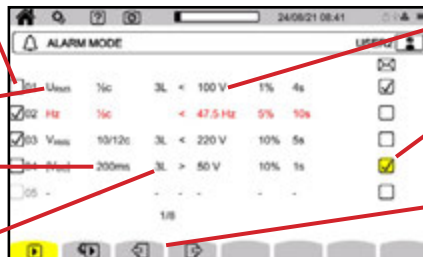

Threshold, hysteresis, and duration of the overshoot

An email is sent when the threshold is crossed

8 pages of 5 alarms each

The instrument can save up to 40 possible alarms.

1. Select  to configure the alarms.
2. Select the quantities and parameters to monitor.
 - The order of the harmonic (between 0 and 63) for U-h, V-h, A-h, U-ih, V-ih, and A-ih only.
 - The value's period of calculation.

For AC signals:

1/2 c: 1 cycle every half-cycle. The value is measured over one cycle, starting at a passage through zero of the fundamental component and refreshed every 1/2 cycle.

10/12 c: 10 cycles for 50 Hz (42.5 to 57.5) Hz or 12 cycles for 60 Hz (51 to 69) Hz

150/180 c: 150 cycles for 50 Hz (42.5 to 57.5) Hz, or 180 cycles for 60 Hz (51 to 69) Hz

10 s

For DC signals:

200 ms

3 s

- The channel(s) to monitor. The Model 8345 will propose a list according to your specified connection.
 - 3L:** each of the 3 phases
 - N:** the neutral
 - 4L:** each of the 3 phases and the neutral
 - The alarm's direction (< or >). Depending on the measured quantity, the direction may be imposed by the instrument.
 - The threshold.
 - The hysteresis: (1, 2, 5, or 10) %.
 - The minimum duration of the threshold overshoot.
3. Then, choose whether to activate the alarm or not by selecting the checkbox.

For more information about these quantities, please refer to the glossary in § 19.13.

You can also choose to have an email sent when the alarm is triggered. If there are several alarms, they can be grouped in a single email to limit the rate of emails to a maximum of one email every 5 minutes.

To specify an email address, refer to § 3.7.4



NOTE: If an alarm configuration line is red, that quantity is not available.

For repeated recordings,  (QuickStart) can be used to set:

- The duration of the capture (between 1 minute and 99 days).
- The maximum number of alarms (between 1 and 20,000).
- The name of the recording.

3.10.6 Energy Mode

The Energy mode **W_h** is used to calculate the energy consumed or produced during a specified time period.

- Select **W_h** to configure the Energy mode.



3.10.6.1 Energy Basic Tariff

- Select **(\$)** to configure the parameters for the basic tariff.
- For **Displayed energy unit**, select the energy unit to use in the calculations. You can choose from W·h, Joule, Toe (nuclear), Toe (non-nuclear), and BTU.
- For **Currency**, press the **(€\$£)** button to access the currency symbol options and then enter the currency symbols to use in the calculations.
- For **Base tariff (kWh⁻¹)**, enter the base tariff rate (per kWh) to use in the calculations.

3.10.6.2 Energy Specific Tariffs

- Select **[Grid]** to define up to 8 specific tariff rates (for example off-hours).
You can define up to 8 different ranges and activate them or not .



- For **Enabled**, select whether the specific tariff configured on the screen will be used in the calculations.
- For **Days**, select the days when the specific tariff will apply.
- For **Start**, specify when the specific tariff will begin on the selected days.
- For **Duration**, specify how long the specific tariff will apply.
- For **Tariff (kWh⁻¹)**, enter the specific tariff rate to use for the configured parameters on the current page.
- Use the page left and page right buttons to access the different specific tariff configuration pages.

3.10.7 Monitoring Mode

The Monitoring mode  is used to check the voltage's conformity for a specified duration. Each monitoring recording contains a trend record, transients record, alarm detection, log of events, and statistical analysis of a set of measurements.

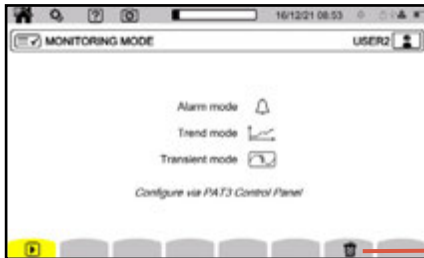

Allows the current configuration to be deleted and replaced by the default configuration (that of the EN 50160-BT standard). It is not possible to modify the configuration if a recording is in progress.

- Press the  button to access Monitoring mode.
- Use the PowerPad® IV application software to configure the Monitoring mode.

3.10.8 Flagging

Flagging concerns voltage dips, voltage swells, and interruptions.

- Use the application software to configure the flagging  parameters.

If a voltage is flagged, every voltage-dependent quantity is reported because they have been calculated from a flagged quantity.

Flagging  prevents a single event from being reported several times in different forms, like counting a single voltage dip as both a dip and a frequency variation.

The triggering thresholds are specific to the different standards that define the voltage specifications provided by public distribution networks (EN 50160, IEC 62749, etc).

Furthermore the instrument can be configured to monitor the supply voltage for compliance with EN 50160 using the Power Analyzer application software (see § 16). The monitoring configuration allows for adjustment of thresholds, hysteresis and durations.

4. OPERATION

4.1 TURNING THE INSTRUMENT ON

- To turn the instrument on, press the  button

The Model 8345 will display a start-up screen before displaying the waveform screen.



4.2 NAVIGATION

You can use the buttons, touch screen, or remote user interface (VNC) to navigate the instrument's menus.

4.2.1 Keypad

Refer to § 2.8 for descriptions of the buttons.

The yellow function buttons change according to the mode, current screen, and context. The active button is highlighted in yellow.

4.2.2 Touch Screen

Every instrument function is available using the touch screen.



- Press the  button to open the following screen.







4.2.3 Remote User Interface

You can use a PC, tablet, or smartphone to control the instrument remotely.

Via Ethernet connection





1. Connect the instrument to the PC using an Ethernet cable (see § 2.4).
2. Press the  button to enter the mode configuration screen.
3. Then, press the second yellow function button or  to enter the instrument configuration screen.

4. Press  to enter the network configuration screen.
5. Press  to enter the Ethernet link screen.
6. Check that the link is active. If it is active, the display will be shaded and will show  in the bottom right. If it is inactive, the display will show  in the bottom right, and you will have to check the physical connection between the Ethernet cable, instrument, and PC.
7. Record the IP address.

Via Wi-Fi connection

1. Share a Wi-Fi connection with a tablet or smartphone.
2. On the tablet or smartphone, enter your instrument's IP address into a web browser's address bar.

To locate the instrument's IP address for Wi-Fi connections

1. Press the  button to enter the mode configuration screen.
2. Then, press the second yellow function button or  to enter the instrument configuration screen.
3. Then, press  to enter the network configuration screen.
4. Then, press  to enter the Wi-Fi link screen.
5. Choose the Wi-Fi network connected to your tablet or smartphone.
6. Check that the link is active. If it is active, the display will be shaded and will show  in the bottom right.
7. Record the IP address.



NOTE: Only one link (Ethernet or Wi-Fi) can be activated at a time.

Starting a remote session

1. Enter your instrument's IP address into a browser to activate the remote session (VNC).
2. In the left-hand tab, click **Fullscreen** to adjust display window's size on your screen.
3. Click **Settings** to configure the VNC session parameters.
4. Then, select **Shared Mode** to control the instrument or **View Only** to view the instrument's screen only.
5. Click **Settings** again to close the configuration menu.
6. Then, click **Connect**. You will see the Model 8345's screen on your connected device's screen.

4.3 CONFIGURATION

Before making any measurement, remember to specify the:

- connection type (§ 3.4.2)
- current sensors, the voltage ratio, and the current ratio (§ 3.4.3)
- calculation method, if necessary (§ 3.9.1)

For the recording modes, remember to specify the:

- quantities to record
- recording's start time
- recording's duration
- recording conditions

4.4 CONNECTIONS

1. Ensure that the leads and sensors are correctly color-coded (see § 2.9).
2. Then, connect them to the circuit as shown by the following screens.

4.4.1 Single-Phase Network

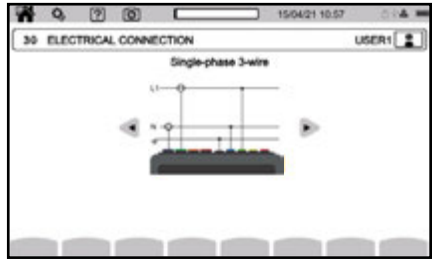
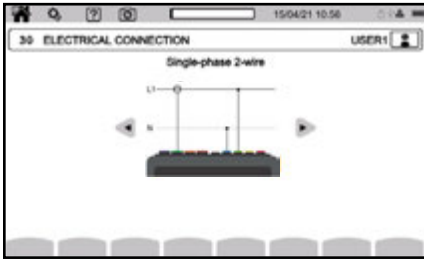

4.4.2 Split-Phase Network

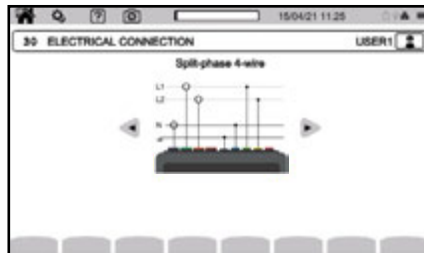
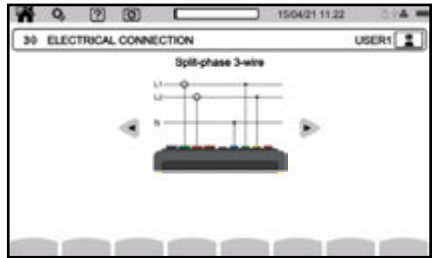
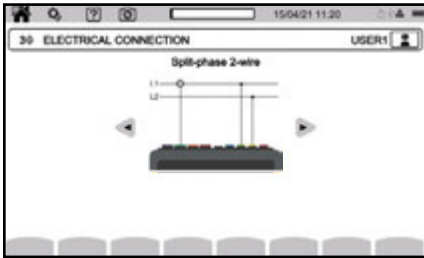

4.4.3 Three-Phase Network

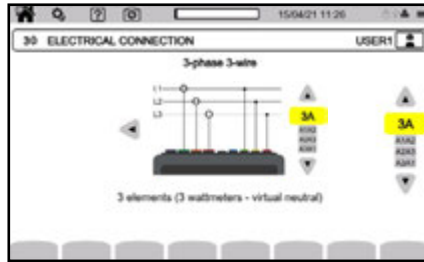

- For three-phase, 3-wire networks, indicate the current sensors that will be connected: all 3 sensors (3A) or only 2 (A1 and A2, A2 and A3, or A3 and A1).
- For three-phase, 4-wire and 5-wire networks, indicate the voltage sensors that will be connected: all 3 sensors (3V) or only 2 (V1 and V2, V2 and V3, or V3 and V1).

4.4.4 Connection Procedure

Depending on the network, not every terminal or sensor needs to be connected.



NOTE: The unused terminals must be connected to the N terminal; otherwise, phantom voltages will occur on the open channels. If the N terminal is not used, connect it to the GND terminal.

The following procedure helps minimize connection errors.

1. Connect the earth lead between the \perp terminal and the network earth.
2. Connect the neutral lead between voltage terminal N and the network neutral.
3. Connect the neutral current sensor to the current terminal N and then clamp the neutral cable.
4. Connect the phase L1 lead between voltage terminal L1 and network phase L1.
5. Connect the phase L1 current sensor to current terminal L1 and then clamp the phase L1 cable.
6. Connect the phase L2 lead between voltage terminal L2 and network phase L2.
7. Connect the phase L2 current sensor to current terminal L2 and then clamp the phase L2 cable.
8. Connect the phase L3 lead between voltage terminal L3 and network phase L3.
9. Connect the phase L3 current sensor to current terminal L3 and then clamp the phase L3 cable.

If you connect a current sensor in reverse, you can correct the connection directly in the configuration.





- Press , , and then (see § 3.9.3.3).





Disconnecting the instrument from the network:









1. Disconnect in the reverse order of connection and always end by disconnecting the earth, neutral, or both.
2. Disconnect the leads from the instrument.

4.5 INSTRUMENT FUNCTIONS

4.5.1 Measurements

There are 4 possible real-time modes: waveform , harmonics , power , and energy .







There are 5 possible recording modes: trend , transients , inrush currents , alarms , and network monitoring .

1. Ensure that the instrument's configuration is correct for the desired measurements.
2. Then, you can make the following measurements:
 - View a signal's waveforms 
 - View a signal's harmonics 
 - View power measurements 
 - Meter energy 
 - Record a trend 
 - Record transients 
 - Capture an inrush current 
 - Detect alarms 
 - Monitor a network 

Some functions cannot be run simultaneously:

- The real-time modes (waveform, harmonics, power, and energy) can be activated while recordings are in progress.
- If an inrush current capture is in progress, you cannot start the recording of a trend, transients, alarms, or monitoring.
- If a recording of a trend, transients, alarms, or monitoring is in progress, you cannot start an inrush current capture.

4.5.2 Screenshot

1. To record a screenshot, hold the  button, or click on the  icon in the status bar.
2. Release the  button or  icon when the  symbol turns black . If you release the button or icon before the symbol turns black, no screenshot will be recorded.

The screenshots are recorded on the SD card in directory 8345\Photograph.

Real-time screens that vary, like curves or metering, are captured in bursts of up to 5 snapshots, so you can choose the best screenshot for your needs.

The screenshot also records measurements and waveform data that can be used with PowerPad® IV application software.

4.5.3 Help

- Press the help button  at any time for information about the functions and symbols used for the in-progress display mode.

4.6 TURNING THE INSTRUMENT OFF

- To turn the instrument off, press the  button.

The instrument will request confirmation if it is recording or metering energy (even if metering is suspended), recording transients, recording alarms, or capturing inrush current.

If you confirm the Power-off command, the recordings will be finalized and the instrument will turn off.

If the instrument turns on before the scheduled end of any recording sessions, these sessions will resume automatically.

4.7 SAFETY STATUS

If there is an overload on the inputs, the instrument will change to safety status. Safety status is indicated by a red line under the status bar.

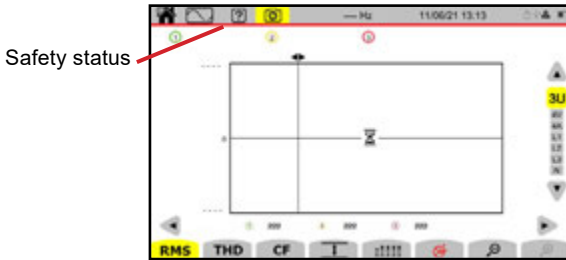

The red line indicates that the sum of all voltage inputs exceeds $1450 V_{\text{crest}}$. This condition is not reached with signals ranging up to $1000 V_{\text{RMS}}$; however, **if you accidentally connect the 3 voltage inputs to the same phase, the sum of the voltage inputs will exceed the safety threshold.**

When the overload has been eliminated, the safety status will disappear after approximately 10 seconds, and you can use your instrument normally again.

5. WAVEFORM

The Waveform mode screen is the initial screen when the instrument turns on.

- Press the  button to enter waveform mode.

Display of voltages or currents with saturation indicators







Cursor

Selected display filter

Values at the cursor's position

Functions

Waveform mode displays voltage curves, current curves, and values calculated from the voltage and currents (except harmonics, powers, and energies).

Waveform mode Functions	
RMS	Displays curves and RMS values
THD	Displays curves and harmonic distortion
CF	Displays curves and crest factor
	Displays the maximum (MAX), RMS, minimum (MIN), positive peak (PK+), and negative peak (PK-) values in table form
	Displays the RMS, DC, THD, CF, P _{inst} , P _{st} , P _{lt} , FHL, FK, and KF values in table form
	Displays the phasor diagram of the signals
	Reduces or increases the time scale of the curves

- To move the time cursor, use the ◀ ▶ buttons.
- To change the display filter, use the ▲ ▼ buttons. The available display filters depend on the chosen distribution network and connection type.

5.1 DISPLAY FILTER

The available display filters depend on the distribution system and connection.

Connection	Display filter	Display filter for function 
Single-phase, 2 wires Split-phase, 2 wires	L1	L1
Single-phase, 3 wires	2V, 2A, L1, N	2V, 2A, L1
Split-phase, 3 wires	U, 2V, 2A, L1, L2	2V, 2A, L1, L2
Split-phase, 4 wires	U, 3V, 3A, L1, L2, N	2V, 2A, L1, L2
Three-phase, 3 wires	3U, 3A	3U, 3A
Three-phase, 4 wires	3U, 3V, 3A, L1, L2, L3	3U, 3V, 3A, L1, L2, L3
Three-phase, 5 wires	3U, 4V, 4A, L1, L2, L3, N	3U, 3V, 4A, L1, L2, L3

5.2 ROOT MEAN SQUARE (RMS) FUNCTION

The RMS function displays the signals measured over a period and their RMS values averaged over 200 ms or 3 s, depending on the configuration. The configuration is explained in detail in § 3.9.1.2.

- Press the **RMS** button to access the RMS function screen.
- To move the cursor, use the ◀ ▶ buttons. You can use the cursor to check the instantaneous values along the displayed curves.
- To change the display filter, use the ▲ ▼ buttons.
- To increase or decrease the time scale of the curves, use the 🔍 🔍 buttons.

The channel numbers (1) are saturation indicators. A solid circle (1) indicates that the channel is full or that one or more channels used to calculate it is full.

The 🚩 symbol near a channel number indicates that a measurement has been flagged, so the voltage and all quantities that depend on it are doubtful. The 🚩 symbol concerns voltage dips, voltage swells, interruptions, and rapid voltage changes. The associated current channel and the associated combined voltages are also flagged. For example, if V1 is flagged, then A1, U1, and U3 will also be marked.

RMS 3U Display Filter

The **3U** display filter displays the instantaneous curves of phase-to-phase voltages and their RMS values.

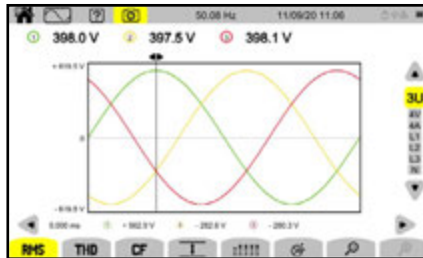

RMS 4V Display Filter

The **4V** display filter displays the instantaneous curves of phase-to-neutral voltages and their RMS values.

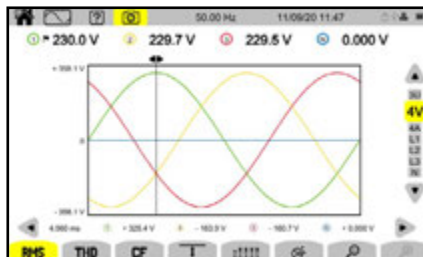

RMS 4A Display Filter

The **4A** display filter displays the instantaneous curves of currents and their RMS values.

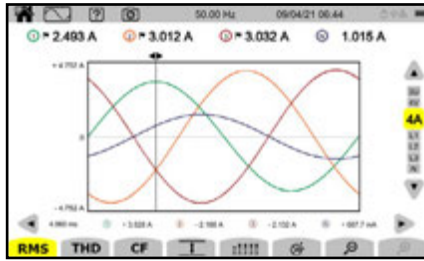

RMS L3 Display Filter

The **L3** display filter displays the instantaneous phase 3 voltage curves, current curves, and their RMS values.

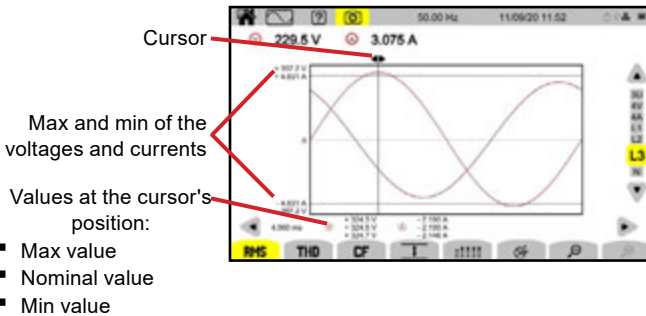

There are 3 curves that are often superimposed: the maximum curve, the nominal curve, and the minimum curve.

The L1, L2, and N display filters are similar but concern phase 1, phase 2, and the neutral.

5.3 TOTAL HARMONIC DISTORTION (THD) FUNCTION

The THD function displays the signals measured over a period and their total harmonic distortion.

- Press the **THD** button to access the THD function screen

The THD is displayed with either the RMS value of the fundamental (%f) or the RMS value without DC (%r), depending on your configuration (see § 3.9.1).

The harmonic distortion rates on the neutral are always calculated in relation to the RMS value without reference DC (%r).

The THD function screens are similar to the RMS screens and depend on the selected display filter.

5.4 CREST FACTOR (CF) FUNCTION

The CF function displays the measured signals and their crest factors.

- Press the **CF** button to access the CF function screen.

The CF function screens are similar to the RMS screens and depend on the selected display filter.

5.5 MIN-MAX FUNCTION

The MIN-MAX function displays the voltage's and current's RMS, maximum (MAX), minimum (MIN), positive peak (PK+), and negative peak (PK-) values.

- Press the  button to access the MIN-MAX function screen.



NOTE: The instrument will begin searching for the extreme values when it is switched on. To reset the values, press the  button.

- To change the display filter, use the   buttons. The available display filters depend on the chosen distribution network and connection type.

The instrument will display  if a value cannot be calculated. For example, no value can be calculated because the instrument is not connected to the network.



3U Display Filter

The **3U** display filter displays the extreme values of phase-to-phase voltages.

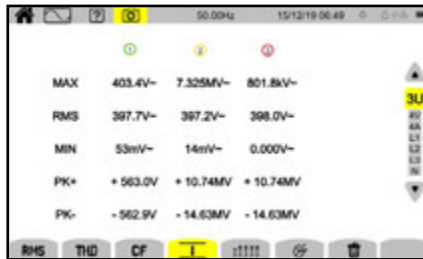

4V Display Filter

The **4V** display filter displays the extreme values of phase-to-neutral voltages.

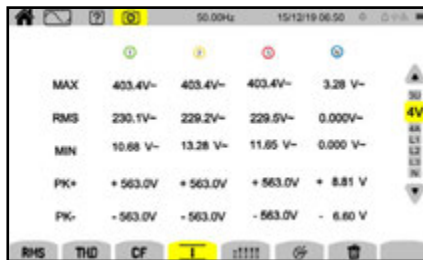

4A Display Filter

The **4A** display filter displays the extreme values of the currents.



L1 Display Filter

The **L1** display filter displays the extreme values of the voltage and current of phase 1.



The **L2**, **L3**, and **N** display filters are similar but concern phase 2, phase 3, and the neutral.

5.6 SUMMARY FUNCTION

The summary function displays values for the voltage and current inputs that depend on the selected distribution network, connection type, and display filter.

- Press  to enter the summary function screen.

Displayed Values	
For voltages	RMS value
	DC component
	Total harmonic distortion referred to the RMS value of the fundamental (THD %f)
	Total harmonic distortion referred to the RMS value without DC (THD %r)
	Crest factor (CF)
	Short-term instantaneous flicker (P_{inst})*
	Short-term flicker (P_{st})
Long-term flicker (P_{lt})	

Displayed Values	
For currents	RMS value
	DC component
	Total harmonic distortion referred to the RMS value of the fundamental (THD %f)
	Total harmonic distortion referred to the RMS value without DC (THD %r)
	Total harmonic distortion referred to the RMS value without DC (THD %r)
	Crest factor (CF)
	Harmonic loss factor (FHL)
	K factor (FK)
	K-factor (KF)

*Additional information about the flicker is available in § 19.4.

Depending on the display filter, not every listed parameter will be displayed.



NOTE: The calculations will begin when the instrument turns on.

If a value cannot be calculated, the instrument will display **-----**. For example, no value can be calculated because the instrument is not connected to the network.

- To change the display filter, use the ▲ ▼ buttons. The available display filters depend on the chosen distribution network and connection type.

4V Display Filter

The **4V** display filter displays the data of the phase-to-neutral voltages.

RMS	228.3 V ⁻	232.4 V ⁻	236.0 V ⁻	5.069 V ⁻
DC	+0.103 V ⁻	+0.150 V ⁻	+0.210 V ⁻	-0.106 V ⁻
THD	2.7 %f	5.4 %f	2.7 %f	
THD	2.7 %r	5.4 %r	2.7 %r	4.5 %r
CF	1.374	1.418	1.451	1.569
P _{inst}	0.014	0.017	0.016	
P _{st}	0.143	0.156	0.148	
PI	0.121	0.133	0.129	

The energy calculation starts at fixed times: 00.00, 00.10, 00.20, 00.30, 00.40, 00.50, 01.00, 01.10, etc. If you switch your instrument on at 08.01, the first P_{st} value will be displayed at 08.20.

The calculation of the P_{It} starts at fixed times: 00.00, 02.00, 04.00, 06.00, 08.00, 10.00, 12.00, etc. If you switch your instrument on at 08.01, the first P_{It} value will be displayed at 12.00 in the case of a fixed window and at 10.10 in the case of a sliding window.

Only calculations completed with the fixed window are recognized by IEC standard 61000-4-30.

4A Display Filter

The **4A** display filter displays the extreme values of the currents.

The DC value is only displayed if the current sensor is able to measure direct current.



L2 Display Filter

The **L2** display filter displays the voltage and current data of phase 2.

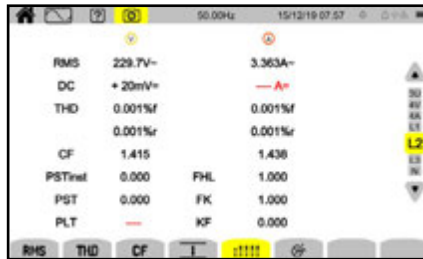

The **L1**, **L3**, and **N** display filters are similar but concern phase 1, phase 3, and the neutral.

5.7 PHASOR FUNCTION

The phasor function displays the phasor diagram of the signals, the absolute values of the voltages or current, the phase difference between voltages or between currents, and the unbalance ratio or inverse unbalance ratio of the voltages or current.

- Press the button to access the phasor function screen.
- To change the display filter, use the buttons. The available display filters depend on the chosen distribution network and connection type.

3U Display Filter

The **3U** display filter displays the phasor diagram of the phase-to-phase voltages. U1 is the reference.

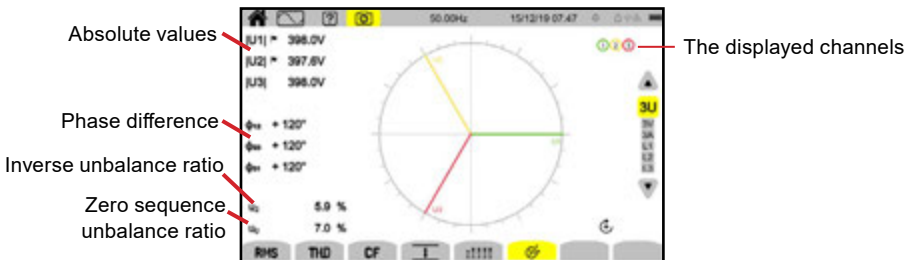

3V Display Filter

The **3V** display filter displays the phasor diagram of the currents and the phase-to-neutral voltages. V1 is the reference.

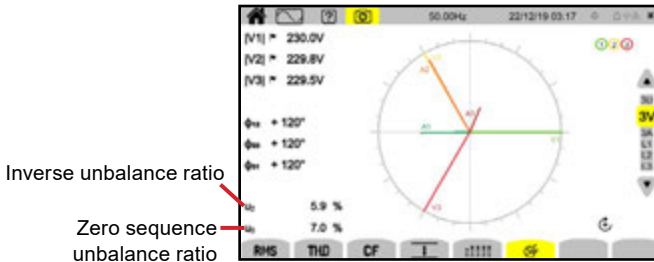

3A Display Filter

The **3A** display filter displays the phasor diagram of the currents and the phase-to-neutral voltages. A1 is the reference.

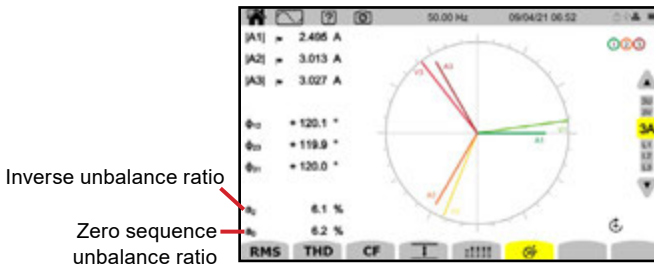

The choice of current or voltage as reference can be changed in the configuration as mentioned in § 3.9.1.

L3 Display Filter

The **L3** display filter displays the phasor diagram of the phase 3 voltage and current. A3 is the reference.

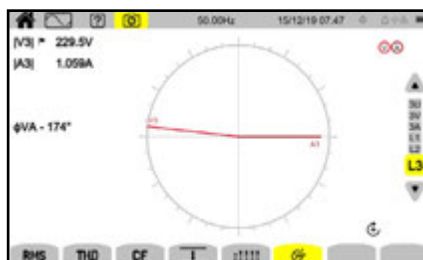

The choice of current or voltage as reference can be changed in the configuration as mentioned in § 3.9.1.

The **L1** and **L2** display filters are similar but concern phase 1 and phase 2.

6. HARMONIC

The voltages and currents can be analyzed as sum of sine waves at the network frequency and multiples thereof. Each multiple is a harmonic of the signal that is characterized by its frequency, amplitude, and phase difference with respect to the fundamental frequency (network frequency).

An interharmonic occurs when one of the frequencies of the sine waves is not a multiple of the fundamental frequency.

The Harmonics mode  displays a bargraph that represents the harmonics of the voltage, current, and mains signaling voltage (MSV).

The bargraph helps determine the harmonic currents produced by nonlinear loads and analyze the problems that arise from these harmonics as a function of their order, like the overheating of neutrals, conductors, motors, and more.

The Model 8345 displays harmonics up to rank 127 and inter-harmonics up to rank 126. Harmonics and inter-harmonics are calculated in accordance with standard IEC 61000-4-7 (see § 19 - Appendices).

- Press the  button to access the Harmonics mode screen.

Display of the harmonic distortion rate and distorting voltage with indication of saturation

Cursor

To move the cursor to the preceding harmonic

To move back to the preceding 32 harmonics

Functions

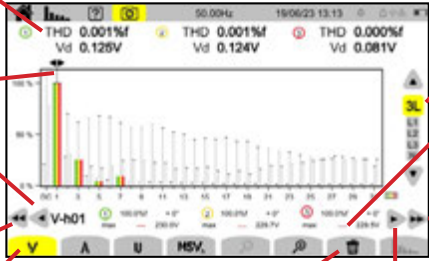

Display Filter.

Values at the position of the cursor

To move forward to the next 32 harmonics





Resetting of the maximum values



To move the cursor to the next harmonic

- Press **V** to display:
 - The harmonics of the phase-to-neutral voltages listed order-by-order.
 - The total harmonic distortion referred to either the RMS value of the fundamental (%f) or the RMS value without DC (%r), depending on the configuration (see § 3.9.1).
 - The distorting phase-to-neutral voltages.

For each cursor position, the following values are displayed:

- The harmonic or inter-harmonic ratio (expressed in %f or %r).
- The phase difference with respect to the first harmonic (fundamental).
- The maximum value reached by the harmonic or inter-harmonic ratio (expressed in %f or %r).
- The amplitude of the harmonic or inter-harmonic.

- Press **A** to display:
 - The harmonics of the currents listed order-by-order.
 - The total harmonic distortion referred to either the RMS value of the fundamental (%f) or the RMS value without DC (%r), depending on the configuration (see § 3.9.1).
 - The distorting currents.
- Press **U** to display:
 - The harmonics of the phase-to-phase voltages listed order-by-order.
 - The total harmonic distortion referred to either the RMS value of the fundamental (%f) or the RMS value without DC (%r), depending on the configuration (see § 3.9.1).
 - The distorting phase-to-phase voltages.
- Press **MSV** to display the spectral level (curve) and RMS values at the configured MSV1 and MSV2 frequencies (see § 3.9.1).
- Press   to stretch or shrink the scale of the bargraph.
- Press  to view/hide interharmonics when the display filter concerns only one phase (L1, L2, L3, or N).
- Press , with the **MSV** function active to view/hide the limits profile for the level of V or U according to the configured frequency (see § 3.9.1).

The channel numbers  are saturation indicators. The circle's interior will be colored  when the measured channel is full or at least one channel used to calculate it is full.

- To move the harmonic order's cursor, use the ◀ ▶ buttons. To move the cursor by an entire screen (32 harmonics), use ◀◀ or ▶▶.

If there are more harmonics when you reach the last harmonic of the screen, you will go to the second screen.

- To change the display filter, use the ▲ ▼ buttons. The available display filters depend on the chosen distribution network and connection type.



NOTE: The calculation of the harmonics starts when the instrument turns on. To reset the values, press the  button.

6.1 DISPLAY FILTER

The available display filters depend on your selected connection:

Connection	Display filter for V	Display filter for A	Display filter for U	Display filter for MSV
Single-phase 2 wires	L1	L1	-	L1 on V
Single-phase 3 wires	L1, N	L1, N	-	L1 on V
Split-phase 2 wires	-	L1	L1	L1 on U
Split-phase 3 wires	2L, L1, L2	2L, L1, L2	L1	L1, L2 on V L1 on U
Split-phase 4 wires	2L, L1, L2, N	2L, L1, L2, N	L1	L1, L2 on V L1 on U
Three-phase 3 wires	-	3L, L1, L2, L3	3L, L1, L2, L3	L1, L2, L3 on U
Three-phase 4 wires	3L, L1, L2, L3	3L, L1, L2, L3	3L, L1, L2, L3	L1, L2, L3 on V and U
Three-phase 5 wires	3L, L1, L2, L3, N	3L, L1, L2, L3, N	3L, L1, L2, L3	L1, L2, L3 on V and U

6.2 EXAMPLES OF SCREENS

V Function with the 3L Display Filter

Information about harmonic number 3 at the cursor's position:

- Level (%f or %r)
- Phase difference with respect to the harmonic of order 1
- Maximum
- Amplitude of harmonic 3

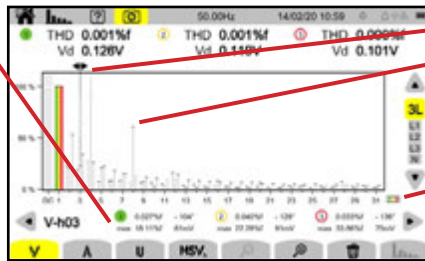

Cursor

Envelope of the maximum harmonics

Second page of harmonics (higher harmonics)

A Function with the N Display Filter

Information about harmonic number 0 (DC) at the cursor's position:

- Level (%r)
- Maximum
- Amplitude

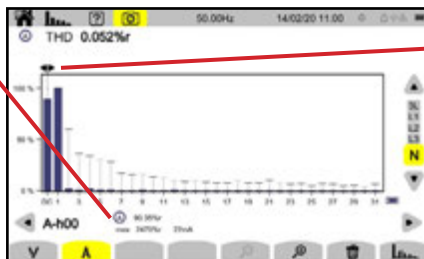

Cursor

The period displayed by the bargraphs is either 200 ms or 3 s, depending on the selected configuration (see § 3.9.1).

U function with the L1 Display Filter

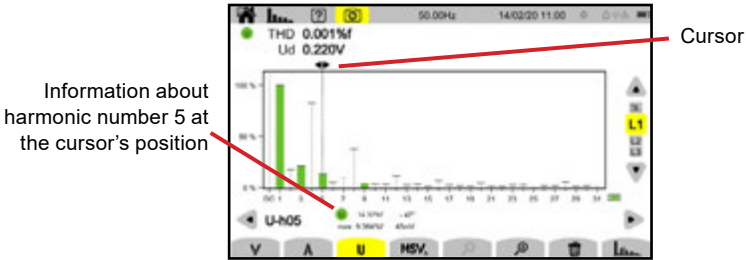

U and Inter-harmonic Function with the L2 Display Filter

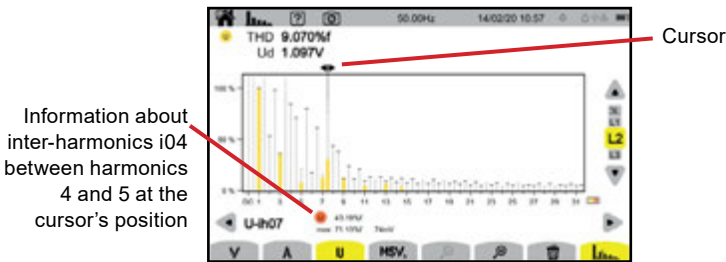

- To exit from the function, press the button again.

MSV-V Function with the L1 Display Filter

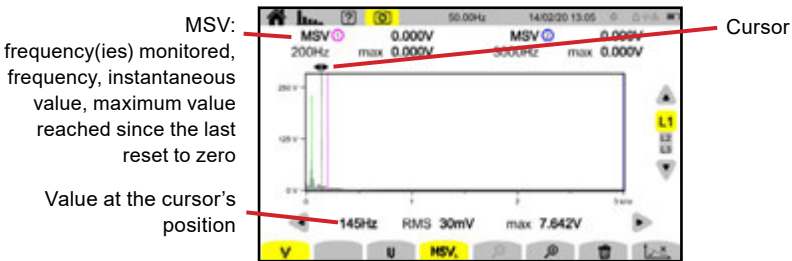

The MSV-U Curve Function with the L1 Display Filter

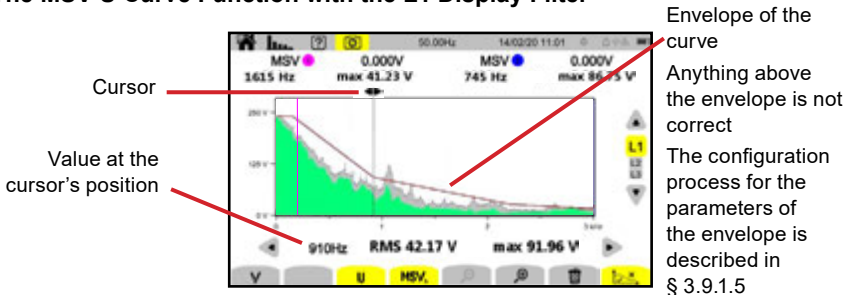

- To exit from the MSV function, press the **MSV** button again.

7. POWER

The Power mode **W** displays power measurements (**W**) and power factor calculations (**PF**).

- Press the **W** button to access the Power mode screen.

7.1 DISPLAY FILTER

The available display filters depend on the selected connection.

Connection	Display filter
Single-phase, 2 wires Single-phase, 3 wires Split-phase, 2 wires	L1
Split-phase, 3 wires Split-phase, 4 wires	2L, L1, L2, Σ
Three-phase, 3 wires	Σ
Three-phase, 4 wires Three-phase, 5 wires	3L, L1, L2, L3, Σ

The Σ filter is used to obtain the value on the whole system (all phases).

7.2 EXAMPLES OF SCREENS

A few examples of the Power mode screens for a three-phase, 5-wire connection are below.

- To change the display filter, use the \blacktriangle \blacktriangledown buttons. The available display filters depend on the chosen distribution network and connection type.

W Function with the 3L Display Filter

P: active power

P_{DC}: DC power (if a DC current sensor is connected)

Q_r: reactive power

D: distorting power

N: non-active power

S: apparent power

Functions

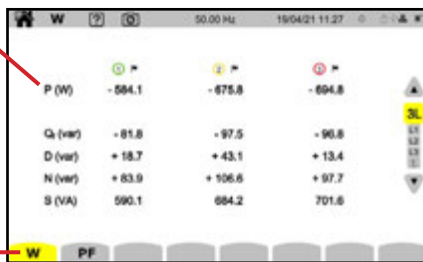

Selected display filter

PF Function with the 3L Display Filter

PF: power factor = P/S

DPF or PF1 or

cos ϕ : fundamental power factor

The name is chosen in the configuration (see § 3.9.1)

tan ϕ : tangent of the phase difference

ϕ_{VA} : phase difference of the voltage with respect to the current.

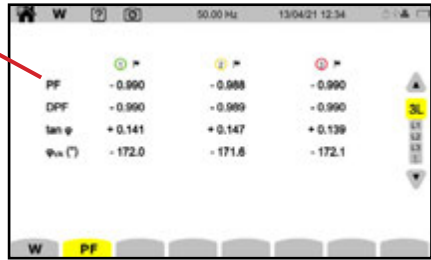

L1 Display Filter

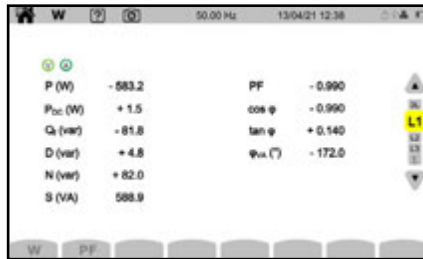

Σ Display Filter

Sum of the powers in the three channels.



8. ENERGY

The Energy mode **Wh** is used to meter generated and consumed energy over a period and indicate the corresponding price.

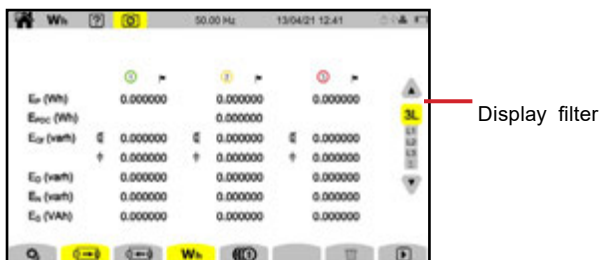

- Press the **Wh** button to access the Energy mode screen.
- Press to access the energy configuration. To change the configuration, there must not be any in-progress or suspended metering. The zero must be reset.
- Press to view the energy consumed by the load when a display filter showing multiple inputs is selected. If a display filter showing a single input is selected, the function buttons are grayed out and the screen automatically shows the consumed energy.
- Press to view energy produced by the source when a display filter showing multiple inputs is selected. If a display filter showing a single input is selected, the function buttons are grayed out and the screen automatically shows the produced energy.
- Press **Wh** to view the amount of energy produced or consumed.
- Press to view the calculated price of the energy produced or consumed using the tariffs set in the energy configuration mode.
- Press to reset the energy metering to zero.
- Press to start energy metering.
- Press to suspend energy metering.

8.1 DISPLAY FILTER

The display filter depends on the selected connection:

Connection	Display filter
Single-phase, 2 wires Single-phase, 3 wires Split-phase, 2 wires	L1
Split-phase, 3 wires Split-phase, 4 wires	2L, L1, L2, Σ
Three-phase, 3 wires	Σ
Three-phase, 4 wires Three-phase, 5 wires	3L, L1, L2, L3, Σ

The Σ filter can obtain the calculation on the whole system (all phases).

8.2 EXAMPLES OF SCREENS

- To change the display filter, use the ▲ ▼ buttons. The available display filters depend on the chosen distribution network and connection type.
- Press the ▶ button to start energy metering.

Wh Function with the 3L Display Filter

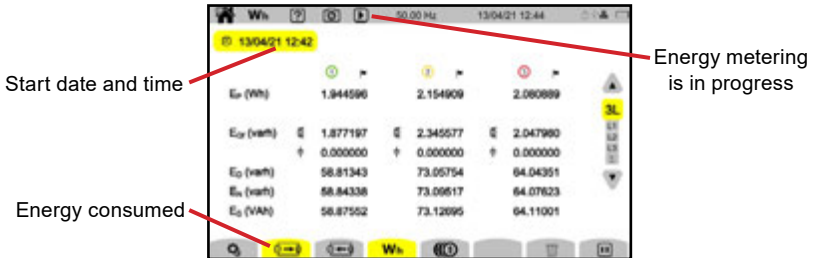

Wh Function with the L1 Display Filter

- E_p : active energy
- E_{PDC} : DC energy (if a DC current sensor is connected)
- E_{Qf} : reactive energy (inductive part $\frac{1}{2}$ and capacitive part $\frac{1}{2}$)
- E_D : distorting energy
- E_N : non-active energy
- E_S : apparent energy

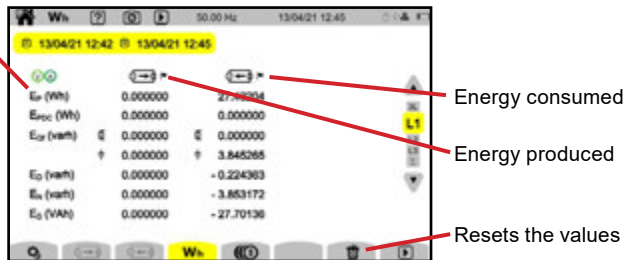

⌘ Function with the Σ Display Filter

- Sum of energies on three channels
- Currency chosen in the configuration (see § 3.4.8)

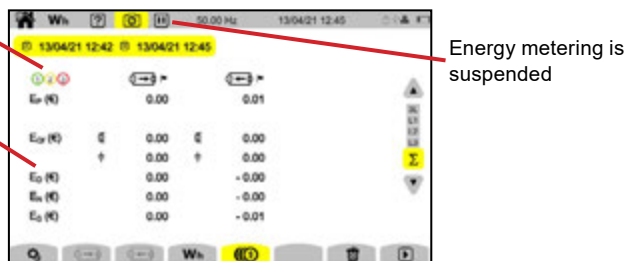

9. TREND MODE

The Trend mode  records the evolution of the quantities selected in the configuration (see § 3.10.2) for a specified duration.

The number of trend recordings is limited only by the SD card's capacity.

- Press the  button to access the Trend mode screen.

The home screen will display a list of the previously-completed recordings. If no recordings have been completed, this list will be empty.



9.1 START OF A RECORDING

- Press  to schedule a recording.

QuickStart mode to start trend recording programmed in configuration (§ 3.10.2) at the end of the current minute + one minute.

To modify the list of recorded quantities

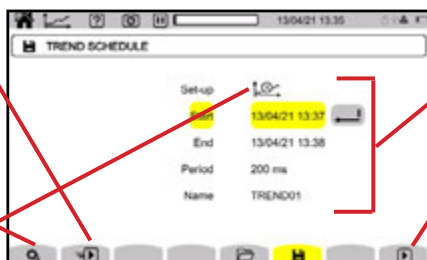

To configure a recording



To start the configured recording on the configured date

- For **Set-up**, select one of the four configured lists of quantities to record from the trend recording configuration. The  function button allows you to configure the lists of quantities to record.
- For **Start**, specify when the recording will begin.





NOTE: Recording start time is adjustable at the earliest, at the end of the current minute + one minute.

- For **End**, specify when the recording will end.
- For **Period**, specify the recording period from one of the 19 options between 200 ms and 2 h. The recording period determines the measurement resolution. If the recording period exceeds the entire recording's duration, the instrument will change the end date to accommodate the recording period.
- For **Name**, enter the recording's name (up to 8 characters long) using capital letters (A-Z), numbers (0-9), and symbols (&, _, and -).
- Press the  function button to start the trend recording programmed in the configuration (§ 3.10.2) at the end of the current minute plus one minute.

- Press the  button to start the recording at the programmed date and time.
- Press the  button to suspend the in-progress recording.



- The  symbol to the right of the camera icon indicates that a recording has been programmed.
- The  symbol to the right of the camera icon indicates that a recording is in progress.
- The  symbol to the right of the camera icon indicates that the in-progress recording is suspended.

To comply with IEC 61000-4-30, trend recordings must be performed with:

- A frequency measurement over 10 seconds
- VRMS, URMS, and ARMS selected

9.2 THE LIST OF RECORDINGS

- Press  to view the previous recordings.

Each entry in the recording list includes the recording's name, start date, start time, end date, and end time.



To view the different pages



- Press  to erase the selected recording.

If the end date is red, the recording encountered either a power supply problem or a write error on the SD card and could not continue to the planned end date.

Use the help button  to learn what each error number means.

To erase all trend recordings, refer to § 3.5.

9.3 READING A RECORDING

- Select a recording from the list, and press the confirm  button to open.
- To change the display filter, use the \blacktriangle \blacktriangledown buttons. The available display filters depend on the chosen distribution network and connection type.
- To move the cursor, use the \blacktriangleleft \blacktriangleright buttons. The cursor allows you to view the values along the displayed curves.
- Use the   buttons to stretch or shrinks the time scale. The selected aggregation period and the recording's duration determine the different zoom possibilities.

The first data is available at the end of the recording period.

The  indicator reports that a problem was encountered during recording. If a quantity could not be recorded correctly, this symbol is displayed above the quantities.



NOTE: When a recording's duration is more than one day, it may take up to ten seconds to display the curves.

Order 5 current harmonics (A-h05) for a 3L display filter

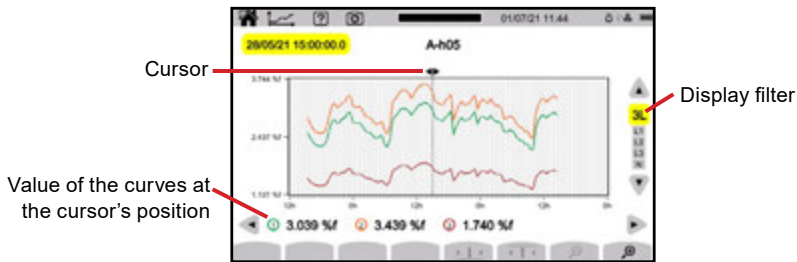

Phase-to-Neutral Voltages (Vrms) for an L3 Display Filter

Whenever a value is recorded for each phase, the instrument will record the minimum single-cycle RMS value and maximum single-cycle RMS value.

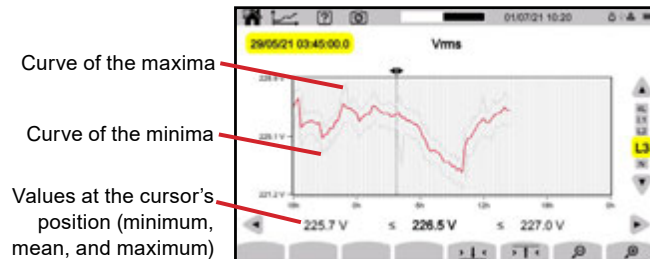

- Press \blacktriangleright \uparrow \blacktriangleleft to zoom on the maximum of the curve of the maxima.
- Press \blacktriangleright \downarrow \blacktriangleleft to zoom on the minimum of the curve of the minima.

Phase-to-Neutral Voltages (VRMS) for an L1 Display Filter and \downarrow \leftarrow

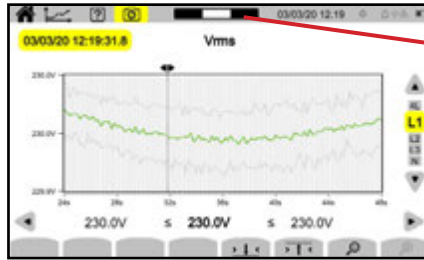

The display window's position in the recording

Active Power (P) for a Display Filter Σ

The power, like energy, is displayed in bargraph form.

Each bar's duration is either 1 s or one recording period (if longer than 1 s).

- Press the Σ button to display the active energy (E_P).

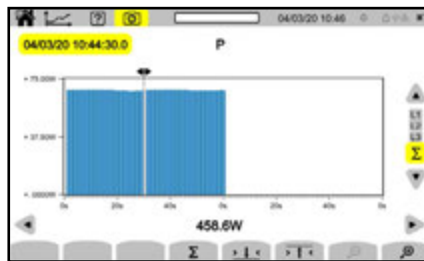

Cumulative active energy (E_P) for a Σ display filter.

1. Place the cursor at the beginning of the accumulation range.
2. Press the Σ button.
3. Move the cursor to the end of the energy accumulation range.

The cumulative total is displayed as it changes.

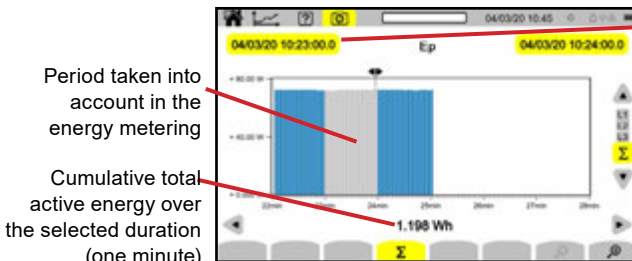

Period taken into account in the energy metering

Cumulative total active energy over the selected duration (one minute)

The cumulative total's start and end dates

Using the display filter, the cumulative total can be determined on each phase or on all of the phases combined.

Power Factor (PF) for an L1 Display Filter

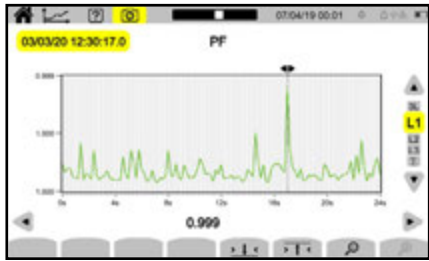

10. TRANSIENT MODE

The Transient mode  records voltage or current transients for a specified duration determined by the selected configuration (see § 3.10.3). It also records shock waves, which are very high voltages for a very short time. The trigger mechanisms are explained in § 19.9 and § 19.10.

The Model 8345 can record a large number of transients that is limited only by the SD card's capacity.

- Press the  button to access Transient mode.

The initial Transient mode screen displays a list of the previous recordings. If no recordings have been completed, this list will be empty.



10.1 START OF A RECORDING

- Press the  button to schedule a recording.

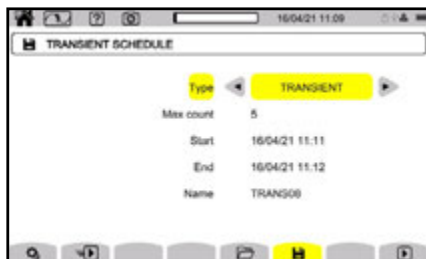







- For **Type**, determine whether the recording will concern transients, shock waves (SURGE), or both.
- For **Max count**, enter the maximum number of transients or shock waves to record between 1 and 1000.
- For **Start**, specify when the recording will begin.



NOTE: Recording start time is adjustable at the earliest, at the end of the current minute + one minute.

- For **End**, specify when the recording will end.
- For **Name**, enter the recording's name (up to 8 characters long). The name can include capital letters (A-Z), numbers (0-9), and symbols (&, _, and -).
- Press the  button to start the recording at the programmed time, if the SD card has enough space.

- Press the  button to start recording a transient programmed in the configuration (§ 3.10.3) at the end of the current minute plus one minute.
- Press the  button to suspend the in-progress recording.
- Press the  button to adjust the voltage, current, or shock wave thresholds.
- The  symbol to the right of the camera icon indicates that a recording has been programmed.
- The  symbol to the right of the camera icon indicates that a recording is in progress.
- The  symbol to the right of the camera icon indicates that the in-progress recording is suspended.

10.2 THE LIST OF RECORDINGS

- Press  to view the completed recordings.
 - Each entry in the recording list includes the recording's name, start date, start time, end date, and end time.

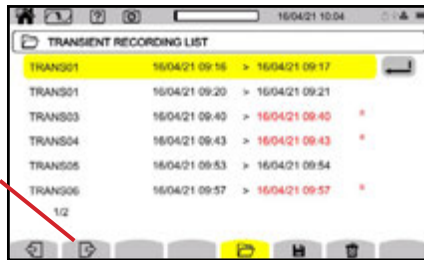

To view different pages

- Press  to erase the selected recording.

If the end date is red, the recording could not continue to the planned end date because of:

- A power supply problem (the instrument turned off due to low battery)
- The maximum number of transients was reached
- A write error on the SD card

Use the help button  to learn what the error message means.

To erase all recordings of transients, refer to § 3.5.

10.3 READING A RECORDING



Channel that triggered the transient

To view different pages

1. Select a recording from the list.
2. Press the confirm button  to open.
3. Press the ▼ button.
4. Use the ▲ ▼ buttons to change the display filter. The available display filters depend on the chosen distribution network and connection type.

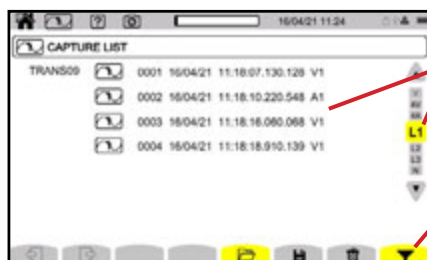

Display Filter	Description
▼	Displays all of the transients
4V	Displays transients triggered by an event in one of the voltage channels
4A	Displays transients triggered by an event in one of the current channels
L1, L2, or L3	Displays the transients triggered by a voltage or current event in phase L1, L2, or L3
N	Displays transients triggered by a voltage or current event in the neutral

5. Confirm by pressing the ▼ button again.



Only the transients triggered by an event on the L1 phase are displayed

The display filter is active

- Select a transient from the list, and press the confirm button  to open.
- Use the ◀ ▶ buttons to move the cursor. The cursor allows you to view the values along the displayed curves.
- Use the ▲ ▼ buttons to change the display filter. The available display filters depend on the chosen distribution network and connection type.
- Use the   buttons to stretch and shrink the time scale.

Transient Event in all of the Voltage Channels

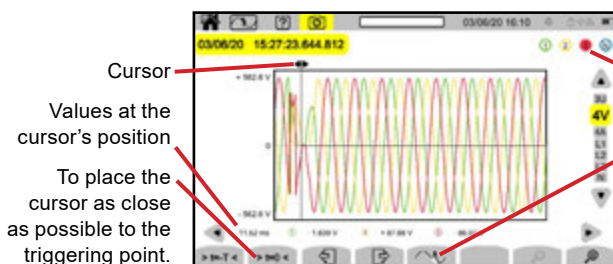

Cursor

Values at the cursor's position

To place the cursor as close as possible to the triggering point.

Channel that triggered the transient capture

To zoom on the event that triggered the transient capture. This button is only active on 4V and L3

Zoom on the Triggering Event



Shock waves in the Voltage Channels

If you have recorded a shock wave, it will appear in the capture list when the recording is read.

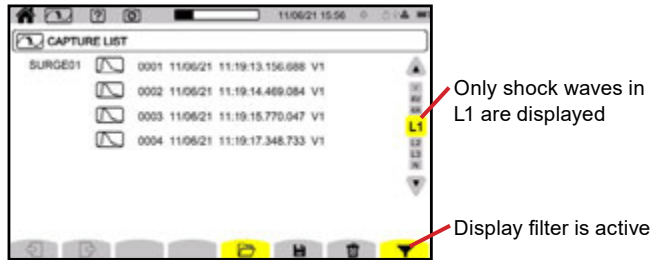

- Select a shock wave recording from the list, and press the confirm button  to open.

The screen will display the whole captured signal for a duration of 1.024 s. The triggering event is located at one quarter of the screen from the left.

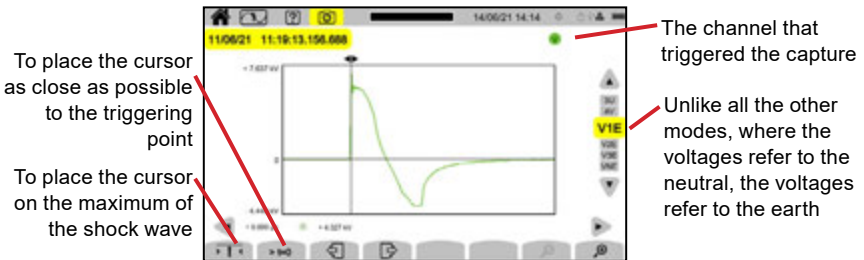

Zoom on the Triggering Event or the Maximum Value

- Press $\leftarrow \uparrow \leftarrow$ to place the cursor as close as possible to the triggering element.
- Press $\rightarrow t=0$ to place the cursor on the maximum.

Since shock waves build up quickly, these two points are often close together.

- Press 🔍 one or more times to zoom.

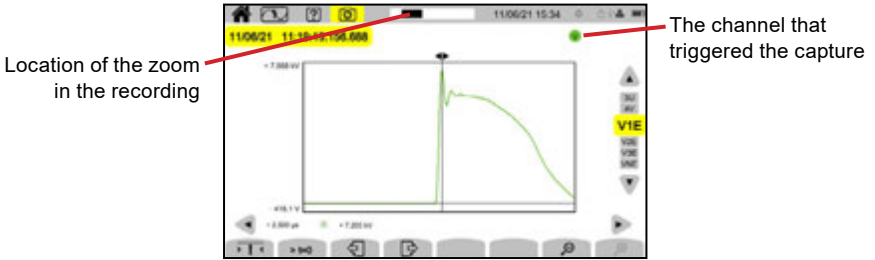

11. INRUSH CURRENT MODE

The Inrush Current mode  is used to capture and record inrush currents for a duration specified by the selected configuration (see § 3.10.4). Capture conditions are explained in § 19.11.



The Model 8345 can record a large number of inrush current captures that is limited only by the SD card's capacity.

- Press the  button to access Inrush Current mode.

The inrush current's initial screen will display a list of the previous captures. If no captures have been completed, this list will be empty.



11.1 START OF A CAPTURE

- Press  to program a capture.
- Press the  button to start the capture of a current programmed in the configuration (§ 3.10.4) at the end of the current minute plus one minute.

QuickStart mode to start the current capture programmed in the configuration (§ 3.10.4) within the next 10 seconds

To change the current thresholds



To configure a capture

To start the screen's configured capture

- For **Type**, determine whether the recording will concern transients, shock waves (SURGE), or both.
- The **Max count** is grayed out and cannot be modified. The max count for inrush currents is 1.
- For **Start**, specify when the recording will begin.





NOTE: Capture start time is adjustable at the earliest, at the end of the current minute + one minute.

- For **End**, specify when the recording will end.
- For **Mode**, select whether the capture will concern RMS values and instantaneous values or only RMS values.

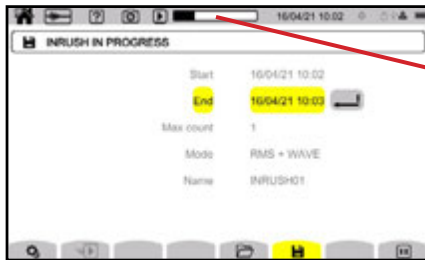
- For **Name**, enter the recording's name (up to 8 characters long). The name can include capital letters (A-Z), numbers (0-9), and symbols (&, _, and -).
- Press the  button to start the capture at the programmed time, if the SD card has enough space. An inrush current capture cannot be started at the same time as a trend, transient, alarm or monitoring recording.



The capture's progress

- Press the  button to start the capture of a current programmed in the configuration (§ 3.10.4) at the end of the current minute plus one minute.
- Press the  button to suspend the in-progress recording.
- Press the  button to change the voltage, current, or shock wave thresholds. The capture will begin recording when the current exceeds the threshold.

11.2 THE LIST OF CAPTURES

- Press  to view the captures performed.

Each entry in the recording list includes the recording's name, start date, start time, end date, and end time.



To view different pages

- Press  to erase the selected capture.

To erase all of the inrush current captures, refer to § 3.5.

If the end date is red, the recording could not continue to the planned end date because of:

- A power supply problem (the instrument turned off due to low battery)
- A write error on the SD card

To learn what the error number means, use the help button .

11.3 READING A CAPTURE

- Select the capture from the list, and press the confirm  button to open it. Captures with red end dates may be unusable.

Each entry in the capture list includes the capture's name, number of inrush current detections, start date, start time, duration, and the channel that triggered the capture.

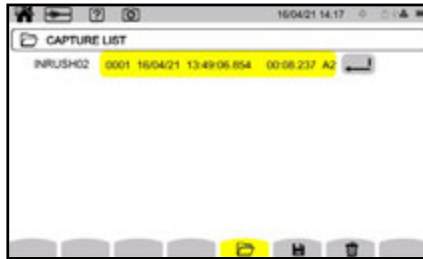

- Press the confirm button  again to display information about the capture.





- Press  to configure a new capture.

11.3.1 RMS Values

- Press the **RMS** button to view the RMS voltage and current values.
- To change the display filter, use the ▲ ▼ buttons. The available display filters depend on the chosen distribution network and connection type.

Display Filter	Description
3V	Displays the 3 phase-to neutral voltages
3U	Displays the 3 phase-to-phase voltages
3A	Displays the 3 currents
L1, L2, L3	Displays the current and voltage on phases L1, L2, and L3
Hz	Displays the evolution of the network frequency over time

The cursor allows you to view the values along the displayed curves.

- To move the cursor, use the ◀ ▶ buttons.
- To stretch or shrink the time scale, use the   buttons.



NOTE: The maximum duration of an RMS recording is 30 minutes. In this case, it can take up to about ten seconds to display the curves at the maximum duration.

Capture of Inrush Current in RMS on 3A

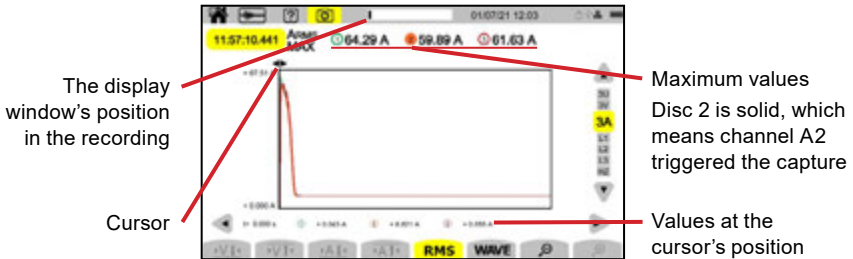

Capture of RMS Inrush Current on L2

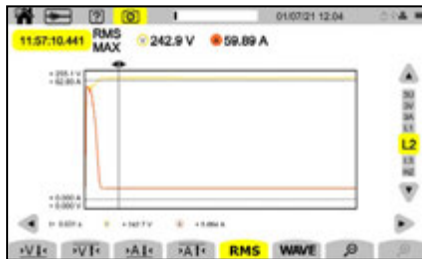

- Press $\rightarrow V \downarrow \leftarrow$ to place the cursor on the minimum voltage.
- Press $\rightarrow V \uparrow \leftarrow$ to place the cursor on the maximum voltage.
- Press $\rightarrow A \downarrow \leftarrow$ to place the cursor on the minimum current.
- Press $\rightarrow A \uparrow \leftarrow$ to place the cursor on the maximum current.

11.3.2 Instantaneous Values

- Press the **WAVE** button to view the instantaneous voltage and current values.

This recording mode displays all samples and is more precise than RMS, which only displays one value per half-cycle.

- Use the \blacktriangle \blacktriangledown buttons to change the display filter. The available display filters depend on the chosen distribution network and connection type.

Display Filter	Description
3V	Displays the 3 phase-to neutral voltages and the neutral
3U	Displays the 3 phase-to-phase voltages
3A	Displays the 3 currents and the current of the neutral
L1, L2, L3	Displays the current and voltage on phases L1, L2, and L3
N	Displays the current and voltage on the neutral

- Use the ◀ ▶ buttons to move the cursor. The cursor allows you to view the values along the displayed curves.
- Use the 🔍 ⏏ buttons to stretch or shrink the time scale.



NOTE: The maximum duration of an RMS+WAVE recording is 10 minutes. In this case, opening a **WAVE** capture may take several minutes, or even be refused by the instrument. Remove the SD card from the instrument (see § 3.5), insert it in a PC and open the capture with PowerPad® IV software (see § 16).

Capture of Instantaneous Inrush Current Values on 4A

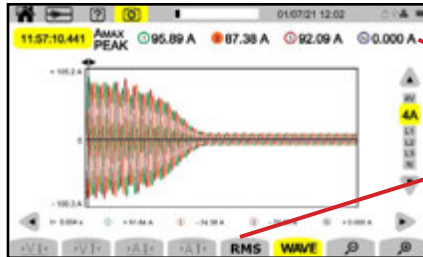

Max instantaneous absolute values

To change RMS

Capture of Instantaneous Inrush Current Values on L3

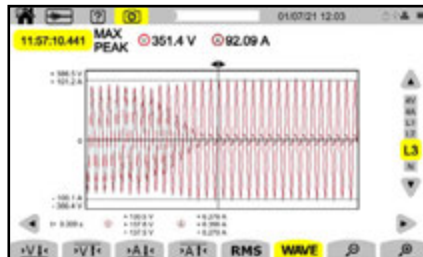

12. ALARM MODE

The Alarm mode  detects and records overshoots of the selected quantities in configuration (see § 3.10.5) for a specified duration.

The Model 8345 can record a large number of alarm recordings and is limited only by the SD card's capacity. Each alarm recording can contain up to 20,000 alarms. The max number of alarms per recording is determined in the configuration.

- Press the  button to access Alarm mode.

The Alarm mode's initial screen displays a list of previous alarm recordings. If no alarm recordings have been completed, this list will be empty.



NOTE: It is not possible to program an alarm recording if an inrush current capture is in progress.

12.1 START OF AN ALARM RECORDING

- Press  to program an alarm recording.



- Press  to modify the alarms (refer to § 3.10.5).



NOTE: Alarms deactivate when they are modified, so you must reactivate the alarms after modification.

- For **Start**, specify when the recording will begin.





NOTE: Alarm recording start time is adjustable at the earliest, at the end of the current minute + one minute.

- For **End**, specify when the recording will end.

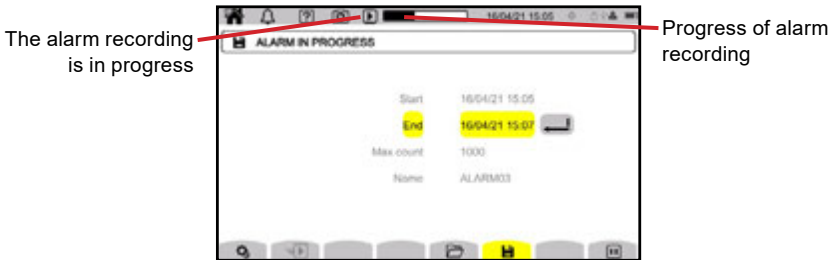
- For **Max Count**, you can have up to 20,000 alarms.
- For **Name**, enter the recording's name (up to 8 characters long). The name can include capital letters (A-Z), numbers (0-9), and symbols (&, _, and -).
- Press  to start the alarm recording at the programmed time.



- Press the  button to start an alarm recording programmed in the configuration (§ 3.10.3) at the end of the current minute plus one minute.
- Press the  button to modify the alarm recording configuration.

12.2 THE LIST OF ALARM RECORDINGS

- Press  to view the previous alarm recordings.

Each entry in the list includes the alarm recording's name, start date, start time, end date, and end time.



- Press  to erase the selected alarm recording.

To erase all of the alarm recordings, refer to § 3.5.

If the end date is red, the recording could not continue to the planned end date because of:

- A power supply problem (the instrument turned off due to low battery)
- A write error on the SD card

To learn what the error number means, use the help button .

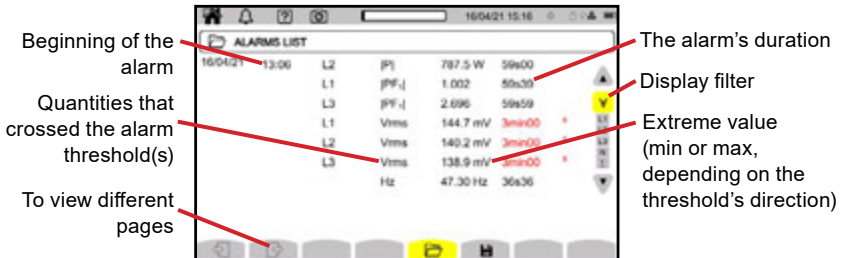

12.3 STARTING AN ALARM RECORDING

- Select an alarm recording from the list, and press the confirm button  to open.
- To change the display filter, use the ▲ ▼ buttons. The available display filters depend on the chosen distribution network and connection type.



Display Filter	Description
▼	Displays the alarms on all channels
L1, L2, L3	Displays the alarms on phase L1, L2, or L3
N	Displays the alarms on the neutral
Σ	Displays the alarms on the summable quantities, like power

If an alarm duration is red, it means that it was cut off because:

- The alarm recording ended while the alarm was in progress
- A power supply problem (the instrument turned off due to low battery)
- The recording was manually stopped ( was pressed)
- The instrument was intentionally turned off ( was pressed)
- The memory was full
- A measurement error
- An incompatibility between the monitored quantity and the instrument's configuration, like if a current sensor was removed

If the alarm was cut off due to a measurement error or an incompatibility, the extreme value will be displayed in red and include an error number.

To learn what each error number means, use the help button .

13. MONITORING MODE

The Monitoring mode  monitors electrical networks per standard EN 50160. In this mode, the Model 8345 detects:

- Slow variations
- Rapid variations and interruptions
- Voltage dips
- Temporary voltage swells
- Transients

Therefore, a monitoring recording will trigger a trend recording, a search for transients, an alarm recording, and a log of events.

The Model 8345 can record a large number of monitoring recordings that is limited only by the SD card's capacity.

- Press the  button to access Monitoring mode.



The home screen will display a list of previous monitoring recordings. If no monitoring recordings have been completed, this list will be empty.

13.1 STARTING A MONITORING RECORDING

The Monitoring mode is configured using the PowerPad® IV application software (see § 16).

1. When the software is installed and the instrument is connected, go to the **Instrument** drop-down menu at the top of the application software's screen.

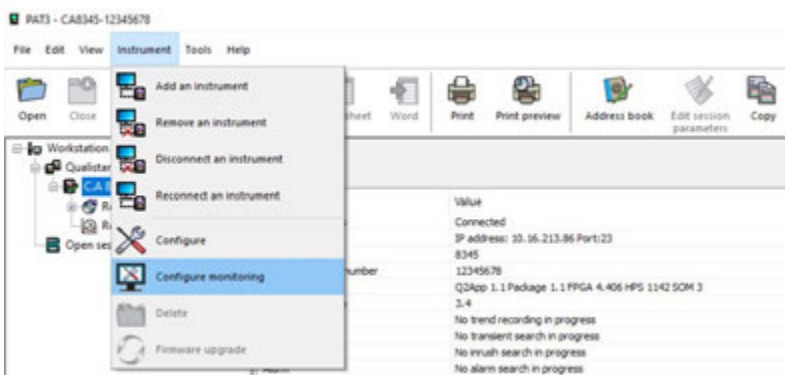

2. Select the **Configure monitoring** option.

The screenshot shows the 'Configure Instrument' window with the 'Monitoring' tab selected. The window title is 'Configure Instrument' and it has a close button (X) in the top right corner. The main content area is titled 'Monitoring' and has sub-tabs: 'Slow Variations Thresholds', 'Interruptions and Rapid voltage Changes (RVC)', 'Voltage Dips and Swells', and 'Transients'. The 'Monitoring' sub-tab is active, showing the following configuration options:

- Electrical distribution system: 3-Phase 5-wire
- Set EN 50160 defaults
- Normal voltage: Enter the nominal voltage of the distribution network: Phase-to-neutral: 230 V (50 - 650000)
- THD calculation: MAX harmonic used for THD calculation: 25
- Normal frequency: 50 Hz (radio button), 60 Hz (radio button, selected)
- Aggregation period (by default): 5 min
- Mains signaling voltage (RMS) frequencies to monitor: 200, 3000
- Mains signaling voltage (RMS) minimum threshold % of nominal voltage: 0.30 %
- Mains signaling voltage (RMS) minimum duration: 120 s
- Enter name of recording: (name is up to 8 chars and contains "A-Z", "0-9", "_", "-")
- EN50160
- Schedule a test
- Starting time: 9/28/2022 3:50 PM
- Ending time: 10/ 5/2022 3:50 PM
- Buttons: Load, Save as...

The configuration window will open with 5 tabs:

- Monitoring
 - Slow variations thresholds
 - Interruptions and Rapid Voltage Changes (RVC)
 - Voltage Dips and Swells
 - Transients
3. In the **Monitoring** tab, indicate the nominal voltage, the frequency, and the name of the file that will contain the monitoring recording.
 4. In the **Slow Variations Thresholds** tab, the maximum variations of the frequency and the voltages are already specified for one week and the duration of the monitoring recording, per the standard. You can modify the values or add quantities to monitor.
 5. In the **Interruptions and Rapid Voltage changes (RVC)** tab, keep the preset values or modify them. The values specify the duration of interruptions and rapid voltage changes (RVC), which are slower than transients.
 6. In the **Voltage Dips and Swells** tab, modify or keep the preset values that specify the levels and durations of the voltage dips and swells.

The **Transients** tab is used to configure a search for transients (see § 3.10.3).

1. Press **OK** to confirm the configuration and transfer it to the instrument.
2. Then, start the monitoring recording on the instrument by specifying its start time and duration.
 - Press  to program a monitoring recording.



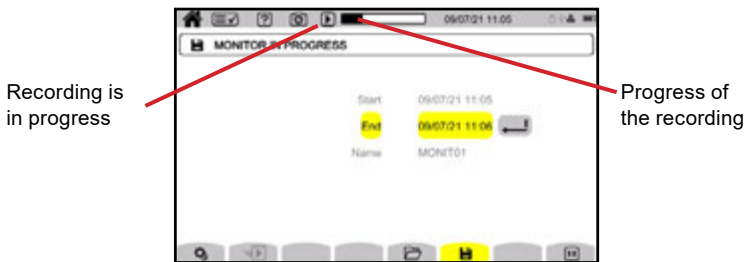

- For **Start**, specify when the recording will begin.
- For **End**, specify when the recording will end.
- For **Name**, enter the recording's name (up to 8 characters long) using capital letters (A-Z), numbers (0-9), and symbols (&, _, and -).



- The date and time of the start of the recording.



NOTE: Monitoring recording start time is adjustable at the earliest, at the end of the current minute + one minute.

- Press the  button to start the monitoring at the programmed time, if there is enough space on the SD card.
- Press the  button to start the monitoring session programmed in the configuration (§ 3.10.3) at the end of the current minute plus one minute.
- Press the  button to suspend the in-progress recording.

13.2 THE LIST OF MONITORING RECORDINGS

- Press  to view a list of the previous monitoring recordings.

Each entry in the list includes the recording's name, start date, start time, end date, and end time.



Used memory

To view different pages

- Press  to erase the selected monitoring recording.

If the end date is red, the recording could not continue to the planned end date because of:

- A power supply problem (the instrument turned off due to low battery)
- The maximum number of transients was reached
- A write error on the SD card

To learn what the error number shown means, use the help button  or refer to § 19.12.

To erase all of the monitoring recordings, refer to § 3.5.

13.3 READING A MONITORING RECORDING

- Select a monitoring recording from the list, and press the confirm button  to open.

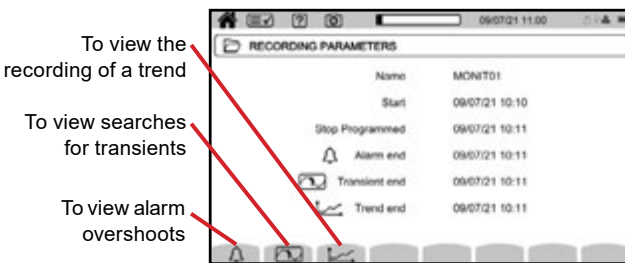

To view the recording of a trend

To view searches for transients

To view alarm overshoots

To read a trend recording, refer to § 9.3.

To read a search for transients, refer to § 10.3.

To read an alarm recording, refer to § 12.3.

The recordings are in the application software in **Recorded sessions/ Monitoring/EN50160** for slow variations, rapid changes, interruptions, voltage dips, and voltage swells.









14. SCREENSHOTS

The  button is used to take screenshots and view recorded screenshots.

The screenshots are recorded on the SD card in the directory 8345\Photograph. You can read the screenshots on a PC via the application software or an SD card reader (not provided).

14.1 TAKING A SCREENSHOT

You have two ways to take a screenshot:

- Hold the  button until the  symbol in the status bar turns yellow  and then black . Then, release the  button.
- Press the  symbol in the status bar at the top of the display unit. The  symbol in the status bar will turn yellow  and then black .

Screens that are likely to vary (curves, metering) are captured in bursts (up to five), so you can select the best screenshot for your needs.

You must wait for the screenshots to be recorded and the  symbol in the status bar to turn gray again before attempting another screenshot.

The number of screenshots that the instrument can record depends on the SD card's capacity.

Single screenshots (fixed screens) are about 150 kB, and multiple screenshots (variable screens) consume approximately 8 MB; therefore, the provided SD card can hold several thousand screenshots.

Refer to § 3.5 for the procedure to erase the SD card's contents.

14.2 MANAGING THE SCREENSHOTS

- Press the  button to enter screenshot mode.

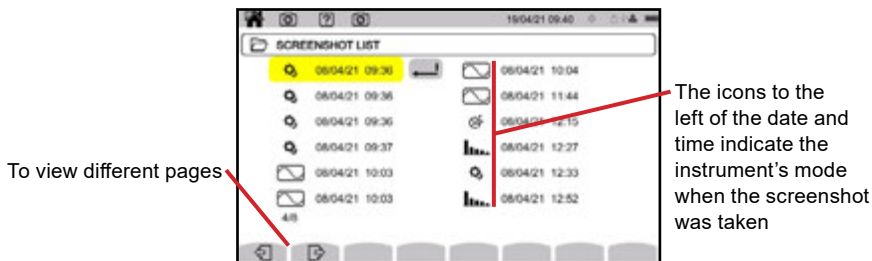

14.2.1 Display of a Screenshot

- To display a screenshot, select it and press the confirm  button
The instrument will display the selected screenshot.



15. HELP

The  button will give you information about the various button functions and symbols used for the in-progress display mode. Some modes, like Power mode, have three available help screens, while others, like Waveform mode, only have two help screens.

Examples of a help screen in Power mode are below.

- The first page indicates the possible functions for the selected mode.

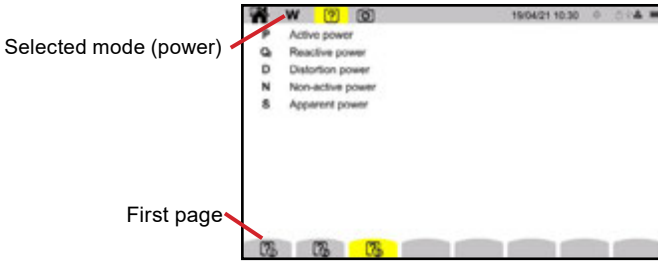

- The second page describes the display functions for the selected mode.

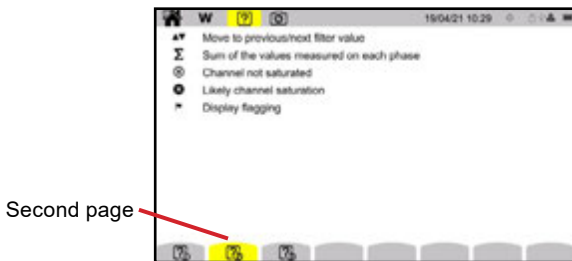

- The third page, if available, defines the symbols for the selected mode.

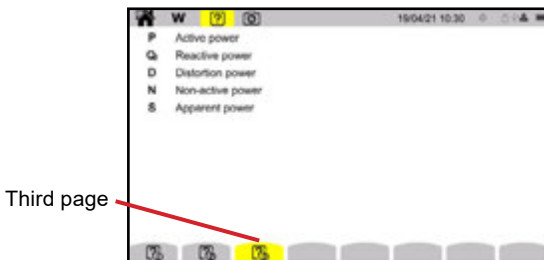

16. APPLICATION SOFTWARE

The Power Analyzer application software is used to:

- Configure the instrument and measurements
- Start and schedule measurements
- Transfer the instrument's data to a PC

The application software can also export the configuration to a file and import a configuration file.

16.1 OBTAINING THE SOFTWARE

The application software is available on the provided USB drive.

To install the software

1. Insert the USB drive into your PC. An AutoPlay window will appear. If the AutoPlay window does not appear, use your PC's file browser to locate the USB drive.

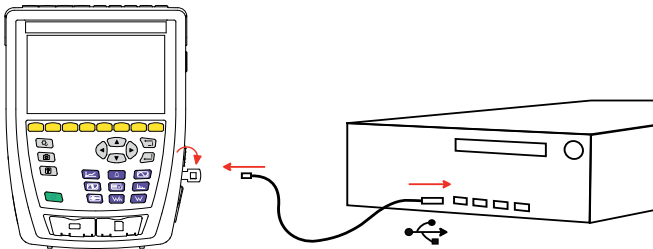

2. Run the setup.exe file.
3. Follow the instructions on your screen to finish the installation process.

To connect the instrument to your PC

1. Remove the cover that protects the instrument's USB port.
2. Connect the instrument to the PC using one of the available communication channels: Ethernet, Wi-Fi or USB (see above figure). USB. Cable provided.
3. Turn the instrument on by pressing the  button, wait for your PC to detect it.



NOTE: USB 3.1 Gen 2 Super Speed is not supported on some PCs using Windows 10 operating system. In this situation, we recommend switching to either a lower speed USB port or ethernet connection.



Every measurement recorded on the instrument can be transferred to PC. The SD card's recorded data is not erased when the recordings are transferred, unless requested.

The memory card's stored data can be read on the PC using the application software and an SD card reader (not provided). To remove the SD card from the instrument, refer to § 3.5.



NOTE: For additional information regarding the application software, refer to the help file.

17. TECHNICAL SPECIFICATIONS

The Model 8345 complies with standard IEC 61000-4-30, Class A.

17.1 REFERENCE CONDITIONS

Quantity of Influence		Reference Conditions
Environmental Conditions	Ambient temperature	23 °C ± 3 °C
	Relative humidity	(40 to 75) % RH
	Atmospheric pressure	(860 to 1060) hPa
	Electric field	< 1 V/m from (80 to 1000) MHz ≤ 0.3 V/m from (1 to 2) GHz ≤ 0.1 V/m from (2 to 2.7) GHz
	Magnetic field	< 40 A/m DC (earth's magnetic field) < 3 A/m AC (50/60 Hz)
Instrument Configuration	Voltage ratio	1
	Current ratio	1
	Voltages	Measured (not calculated)
	Current sensors	Real (not simulated)
	Auxiliary power supply voltage	230 V ± 1 % or 120 V ± 1 %
	Instrument warm up	1 h

Quantity of Influence		Reference Conditions
Electrical System Specifications	Phases	3 phases available (for three-phase systems)
	DC components of voltage and current	No
	Waveform	Sine wave
	Electrical network frequency	50 Hz \pm 0.5 Hz or 60 Hz \pm 0.5 Hz
	Voltage amplitude	$U_{din} \pm 1\%$ Phase-to-neutral voltage between 100 V and 400 V Phase-to-phase voltage between (200 and 1000) V
	Flicker	$P_{st} < 0.1$
	Voltage unbalance	$u_0 = 0\%$ and $u_2 = 0\%$ Phase modulus: $100\% \pm 0.5\% U_{din}$ Phase angles: L1: $0^\circ \pm 0.05^\circ$ L2: $-120^\circ \pm 0.05^\circ$ L3: $120^\circ \pm 0.05^\circ$
	Harmonics	$< 3\% U_{din}$
	Interharmonics	$< 0.5\% U_{din}$
	Input voltage on the current terminals for current sensors (except AmpFlex® and MiniFlex®)	30 mVRMS to 1000 mVRMS without DC $1 \text{ VRMS} \Leftrightarrow A_{nom}^{(1)}$ $30 \text{ mVRMS} \Leftrightarrow 3 \times A_{nom}^{(1)} / 100$
Input voltage on current terminals for AmpFlex® and MiniFlex® (10 kA)	11.73 mVRMS to 391 mVRMS without DC 11.73 mVRMS at 50 Hz \Leftrightarrow 300 ARMS 391 mVRMS at 50 Hz \Leftrightarrow 10 kARMS	
Electrical System Specifications (cont.)	Input voltage on current terminals for AmpFlex® and MiniFlex® (1000 A range)	1.173 mVRMS to 39.1 mVRMS without DC 1.173 mVRMS at 50 Hz \Leftrightarrow 30 ARMS 39.1 mVRMS at 50 Hz \Leftrightarrow 1000 ARMS
	Input voltage on current terminals for AmpFlex® and MiniFlex® (100 A range)	117.3 μ VRMS to 3910 μ VRMS without DC 117.3 μ VRMS at 50 Hz \Leftrightarrow 3 ARMS 3.91 mVRMS at 50 Hz \Leftrightarrow 100 ARMS
	Phase difference	0° (active power and energy) 90° (reactive power and energy)

Table 1

1. The values for A_{nom} are given in the following table.

Nominal current (A_{nom}) depending on the sensor

Current Sensor	Nominal RMS Current A_{nom} (A)	Full-Scale Technical RMS per Class A ⁽²⁾	Full-Scale Commercial RMS per Class A ⁽³⁾
AmpFlex® 193	100 A_{nom} 1000 A_{nom} 10,000 A_{nom}	(14.14 to 16.97) A (141.42 to 169.71) A (1414.21 to 1697.06) A ⁽¹⁾	30 A 300 A 3000 A ⁽¹⁾
MiniFlex® MA194-24-BK	100 A_{nom} 1000 A_{nom} 10,000 A_{nom}	(14.14 to 16.97) A (141.42 to 169.71) A (1414.21 to 1697.06) A ⁽¹⁾	30 A 300 A 3000 A ⁽¹⁾
SR193 clamp	1000 A_{nom}	(471 to 566) A	500 A
MR193 clamp	1000 A_{nom}	(471 to 566) A	500 A
MN93 clamp (200 A)	200 A_{nom}	(94.3 to 113) A	100 A
MN193 clamp (5 A)	5 A_{nom}	(1.77 to 2.12) A	2 A
MN193 clamp (100 A)	100 A_{nom}	(47.1 to 56.6) A	50 A
E94 clamp (10 mV/A)	100 A_{nom}	(47.1 to 56.6) A	50 A
E94 clamp (100 mV/A)	10 A_{nom}	(3.54 to 4.24) A	4 A

Table 2

- AmpFlex® and MiniFlex® current sensors do not guarantee Class A at full scale because they generate a signal proportional to the current's differential coefficient, and the scale factor can easily reach 3, 3.5, or 4 if the signal is not sinusoidal.*
- Calculation formulas:

Lower Value	Upper Value
$\frac{\sqrt{2}}{CF_{Class-A}} \times A_{nom}$	$1.2 \times \frac{\sqrt{2}}{CF_{Class-A}} \times A_{nom}$

The factor 1.2 follows from the instrument's current input capacity to accept 120 % of A_{nom} with a sinusoidal signal.

$$\begin{array}{lcl}
 5 \text{ A} < A_{nom} \leq 5 \text{ A} & \Rightarrow & CF_{Class-A} = 4 \\
 5 \text{ A} < A_{nom} \leq 10 \text{ A} & \Rightarrow & CF_{Class-A} = 3.5 \\
 10 \text{ A} < A_{nom} & \Rightarrow & CF_{Class-A} = 3
 \end{array}$$

- The commercial full-scale RMS value is chosen inside the technical full scale.

17.2 ELECTRICAL SPECIFICATIONS

17.2.1 Input Voltage Specifications

Range of Use	(0 to 1000) V_{RMS} phase-neutral and neutral-earth (0 to 1700) V_{RMS} phase-phase without exceeding 1000 V_{RMS} with respect to earth
Input Impedance	2 M Ω between phase and neutral 2 M Ω between neutral and earth
Permanent Overload	1200 V_{RMS} phase-neutral and neutral-earth
Temporary Overload	12,000 V_{RMS} phase-neutral and neutral-earth 278 pulses per second maximum

17.2.2 Current Input Specifications

Range of Use	0 V_{RMS} to 1 V_{RMS} with $CF = \sqrt{2}$ (except AmpFlex [®] and MiniFlex [®]) 0 V_{RMS} to $(0.391 \times f_{nom} / 50) V_{RMS}$ with $CF = \sqrt{2}$ for AmpFlex [®] and MiniFlex [®]
Input Impedance	1 M Ω (except AmpFlex [®] and MiniFlex [®]) 12.5 k Ω for AmpFlex [®] and MiniFlex [®]
Max Input Voltage	1.2 V_{RMS} with $CF = \sqrt{2}$
Permanent Overload	1.7 V_{RMS} with $CF = \sqrt{2}$

17.2.3 Bandwidth and Sampling

The instrument utilizes anti-aliasing filters, as required by IEC 61000-4-7 Ed. 2.

S/s: sample per second

spc: sample per cycle

The bandwidth and the sampling frequency (S = sample) are:

Channel Type	Bandwidth	Sampling Frequency
Voltage	88 kHz	400 kS/s
Current	20 kHz	200 kS/s
Shock Waves	200 kHz	2 MS/s

There are two streams of data used for metrology: 40 kS/s and 512 spc (samples per cycle)

Waveform - RMS:

- 3U, 4V, 4A filters: 512 spc stream
- L1, L2, L3, N filters: 512 spc stream
- Min and Max curves: 400 kS/s for V and U, 200 kS/s for I

Waveform - Min-Max:

- RMS measurements: 512 spc stream
- Min, Max measurements: 40 kS/s stream
- Pk+, Pk- measurements: 40 kS/s stream

Transients:

- 3U, 4V, 4A filters: 512 spc stream
- L1, L2, L3, N filters: 512 spc stream
- Min and Max curves: 400 kS/s for V and U, 200 kS/s for I

Shock wave: 2 MS/s / 500 ns (waveform and events), up to 12 kV

Inrush current:

- Curves: 512 spc stream
- Measurements: 40 kS/s stream (RMS $\frac{1}{2}$ measurements)

Harmonics: 512 spc stream

Power and energy: 40 kS/s stream

Trend and alarm: 512 spc or 40 kS/s, depending on the selected quantities:

- RMS values, flicker, tan ϕ , harmonics, interharmonics, unbalances, harmonic distortions: 512 spc stream
- Line frequency, power, and energy measurements: 40 kS/s stream

17.2.4 Instrument Specifications (Without Current Sensors)**17.2.4.1 Currents and Voltages**

Measurement		Measurement Range without ratio (with unity ratio)		Display Resolution (unity ratio)	Max Intrinsic Error
		Min	Max		
Frequency		42.50 Hz	69.00 Hz	10 mHz	± 10 mHz
Voltage RMS ⁽⁴⁾	phase-to-neutral	5.000 V	9.999 V ⁽¹⁾	4 digits	$\pm(0.1\% + 100$ mV)
		10.00 V	600.0 V	4 digits	$\pm(0.1\% U_{din})$
		600.1 V	1000 V	4 digits	$\pm(0.1\% + 1$ V)
	phase-to-phase	5.000 V	19.99 V ⁽¹⁾	4 digits	$\pm(0.1\% + 100$ mV)
		20.00 V	1500 V	4 digits	$\pm(0.1\% U_{din})$
		1501 V	2000 V	4 digits	$\pm(0.1\% + 1$ V)
DC Voltage	phase-to-neutral	5.000 V	999.9 V	4 digits	$\pm(0.5\% + 500$ mV)
		1000 V	1200 V ⁽²⁾	4 digits	$\pm(0.5\% + 1$ V)
	phase-to-phase	5.000 V	999.9 V	4 digits	$\pm(0.5\% + 500$ mV)
		1000 V	2400 V ⁽²⁾	4 digits	$\pm(0.5\% + 1$ V)
Distorting RMS $\frac{1}{2}$	phase-to-neutral	2.000 V	1000 V	4 digits	$\pm(0.5\% + 500$ mV)
	phase-to-phase	2.000 V	999.9 V ⁽¹⁾	4 digits	$\pm(0.5\% + 500$ mV)
		1000 V	2000 V ⁽¹⁾	4 digits	$\pm(0.5\% + 1$ V)

Measurement		Measurement Range without ratio (with unity ratio)		Display Resolution (unity ratio)	Max Intrinsic Error
		Min	Max		
Distorting Voltage	phase-to-neutral	2.000 V	999.9 V	4 digits	$\pm(1.5 \% + 500 \text{ mV})$
		1000 V	1414 V ⁽³⁾	4 digits	$\pm(1.5 \% + 1 \text{ V})$
	phase-to-phase	2.000 V	999.9 V	4 digits	$\pm(1.5 \% + 500 \text{ mV})$
		1000 V	2828 V ⁽³⁾	4 digits	$\pm(1.5 \% + 1 \text{ V})$
Instantaneous sensation of flicker (P_{inst} , P_{max})		0.000	12.00 ⁽⁵⁾	4 digits	$\pm 8 \%$
Severity of short-term flicker (P_{st})		0.000 P_{st}	12.00 P_{st} ⁽⁵⁾	4 digits	Max $\pm(5 \%; 0.05)$
Severity of long-term flicker (P_{lt})		0.000 P_{lt}	12.00 P_{lt} ⁽⁵⁾	4 digits	Max $\pm(5 \%; 0.05)$
Crest factor (CF) (voltage and current)		1.000	9.999	4 digits	$\pm(1 \% + 5 \text{ cts})$ CF < 4
					$\pm(5 \% + 2 \text{ cts})$ CF ≥ 4

1. Provided that the voltages between the individual terminals and earth do not exceed 1000 V_{RMS} .

2. Limitation of voltage inputs

3. $1000 \times \sqrt{2} \approx 1414$; $2000 \times \sqrt{2} \approx 2828$

4. Total RMS value and RMS value of the fundamental.

5. The limits specified in IEC 61000-3-3 are: $P_{st} < 1.0$ and $P_{lt} < 0.65$. Any values greater than 12 are unrealistic, and no uncertainty is specified for them.

Measurement		Measurement Range without ratio (with unity ratio)		Display Resolution (unity ratio)	Max Intrinsic Error
		Min	Max		
RMS Current Measurement ⁽⁴⁾	SR193 clamp MR193 clamp	1.000 A	47.09 A	4 digits	±(0.5 % + 200 mA)
		47.10 A	566.0 A	4 digits	±0.5 % ⁽⁶⁾
		566.1 A	1000 A	4 digits	±(0.5 % + 200 mA)
	MN93 clamp	200.0 mA	9.429 A	4 digits	±(0.5 % + 20 mA)
		9.430 A	113.0 A	4 digits	±0.5 % ⁽⁶⁾
		113.1 A	200.0 A	4 digits	±(0.5 % + 200 mA)
	E94 clamp (10 mV/A) MN193 clamp (100 A)	200.0 mA	4.709 A	4 digits	±(0.5 % + 20 mA)
		4.710 A	56.60 A	4 digits	±0.5 % ⁽⁶⁾
	E94 clamp (100 mV/A)	56.61 A	100.0 A	4 digits	±(0.5 % + 200 mA)
		20.00 mA	353.9 mA	4 digits	±(0.5 % + 2 mA)
		354.0 mA	4.240 A	4 digits	±0.5 % ⁽⁶⁾
	MN193 clamp (5 A)	4.241 A	10.00 A	4 digits	±(0.5 % + 10 mA)
		5.000 mA	176.9 mA	4 digits	±(0.5 % + 2 mA)
		177.0 mA	2.120 A	4 digits	±0.5 % ⁽⁶⁾
	AmpFlex [®] 193 MiniFlex [®] MA194-24-BK (10 kA)	2.121 A	5.000 A	4 digits	±(0.5 % + 2 mA)
		10.00 A	299.9 A	4 digits	±(0.5 % + 3 A)
		300.0 A	3000 A	4 digits	±0.5 % ⁽⁶⁾
	AmpFlex [®] 193 MiniFlex [®] MA194-24-BK (1000 A)	300.1 A	10 000 A	4 digits	±(0.5 % + 3 A)
		1.000 A	29.99 A	4 digits	±(0.5 % + 0.5 A)
		30.00 A	300.0 A	4 digits	±0.5 % ⁽⁶⁾
AmpFlex [®] 193 MiniFlex [®] MA194-24-BK (100 A)	300.1 A	1000 A	4 digits	±(0.5 % + 0.5 A)	
	100.0 mA	2.999 A	4 digits	±(0.5 % + 100 mA)	
	3.000 A	30.00 A	4 digits	±0.5 % ⁽⁶⁾	
DC Current Measurement	MR193 clamp E94 clamp (10 mV/A) E94 clamp (100 mV/A)	30.01 A	100 A	4 digits	±(0.5 % + 3 A)
		1 A	1300 A ⁽¹⁾	4 digits	±(1 % + 1 A)
		200 mA	100 A ⁽¹⁾	4 digits	±(1 % + 100 mA)
		20 mA	10 A ⁽¹⁾	4 digits	±(1 % + 10 mA)

1. Provided that the voltages between the individual terminals and earth do not exceed 1000 V_{RMS}.

4. Total RMS value and RMS value of the fundamental

6. The intrinsic uncertainty of Class A is ±1 %

Measurement		Measurement Range without ratio (with unity ratio)		Display Resolution (unity ratio)	Max Intrinsic Error
		Min	Max		
Distorting RMS $\frac{1}{2}$ ⁽⁸⁾	SR193 clamp MR193 clamp	1.000 A	1000 A	4 digits	$\pm(1\% + 1\text{ A})$
	MN93 clamp	200.0 mA	200.0 A	4 digits	$\pm(1\% + 1\text{ A})$
	E94 clamp (10 mV/A) MN193 clamp (100 A)	200.0 mA	100.0 A	4 digits	$\pm(1\% + 100\text{ mA})$
	E94 clamp (100 mV/A)	20.00 mA	10.00 A	4 digits	$\pm(1\% + 10\text{ mA})$
	MN193 clamp (5 A)	5.000 mA	5.000 A	4 digits	$\pm(1\% + 10\text{ mA})$
	AmpFlex [®] 193 (10 kA) MiniFlex [®] MA194-24-BK (10 kA)	10.00 A	10.00 kA	4 digits	$\pm(2.5\% + 5\text{ A})$
	AmpFlex [®] 193 (1000 A) MiniFlex [®] MA194-24-BK (1000 A)	10.00 A	1000 A	4 digits	$\pm(2.5\% + 5\text{ A})$
	AmpFlex [®] 193 (100 A) MiniFlex [®] MA194-24-BK (100 A)	100.0 mA	100.0 A	4 digits	$\pm(2.5\% + 200\text{ mA})$

8. RMS $\frac{1}{2}$: RMS values of the voltages measured in 1 cycle, starting at a zero crossing of the fundamental and refreshed at each half-cycle.

Measurement		Measurement Range without ratio (with unity ratio)		Display Resolution (unity ratio)	Max Intrinsic Error
		Min	Max		
Peak Current (PK) Measurement	SR193 clamp MR193 clamp	1.000 A	1414 A ⁽⁷⁾	4 digits	$\pm(1\% + 2\text{ A})$
	MN93 clamp	200.0 mA	282.8 A ⁽⁷⁾	4 digits	$\pm(1\% + 2\text{ A})$
	E94 clamp (10 mV/A) MN193 clamp (100 A)	200.0 mA	141.4 A ⁽⁷⁾	4 digits	$\pm(1\% + 200\text{ mA})$
	E94 clamp (100 mV/A)	20.00 mA	14.14 A ⁽⁷⁾	4 digits	$\pm(1\% + 20\text{ mA})$
	MN193 clamp (5 A)	5.000 mA	7.071 A ⁽⁷⁾	4 digits	$\pm(1\% + 20\text{ mA})$
	AmpFlex [®] 193 (10 kA) MiniFlex [®] MA194-24-BK (10 kA)	10.00 A	14.14 kA ⁽⁷⁾	4 digits	$\pm(3\% + 5\text{ A})$
	AmpFlex [®] 193 (1000 A) MiniFlex [®] MA194-24-BK (1000 A)	10.00 A	1414 kA ⁽⁷⁾	4 digits	$\pm(3\% + 5\text{ A})$
	AmpFlex [®] 193 (100 A) MiniFlex [®] MA194-24-BK (100 A)	100.0 mA	141.4 A ⁽⁷⁾	4 digits	$\pm(3\% + 600\text{ mA})$

Table 3

7. $3500 \times \sqrt{2} \approx 4950$; $1000 \times \sqrt{2} \approx 1414$; $200 \times \sqrt{2} \approx 282.8$; $100 \times \sqrt{2} \approx 141.4$; $10 \times \sqrt{2} \approx 14.14$;
 $10000 \times \sqrt{2} \approx 14140$; $6500 \times \sqrt{2} \approx 9192$

17.2.4.2 Power and Energy

Measurement		Measurement Range without ratio (with unity ratio)		Display Resolution ⁽¹¹⁾ (unity ratio)	Max Intrinsic Error
		Min	Max		
Active power (P) ⁽¹⁾	Without AmpFlex [®] and MiniFlex [®]	1.000 W ⁽³⁾	10.00 MW ⁽⁴⁾	4 digits ⁽⁵⁾	$\pm(1\% + 10\text{ cts})$
					$ \cos \phi \geq 0.8$
	With AmpFlex [®] and MiniFlex [®]	1.000 W ⁽³⁾	10.00 MW ⁽⁴⁾	4 digits ⁽⁵⁾	$\pm(1.5\% + 10\text{ cts})$
					$0.2 \leq \cos \phi < 0.8$
				$\pm(1\% + 10\text{ cts})$	
				$ \cos \phi \geq 0.8$	
				$\pm(1.5\% + 10\text{ cts})$	
				$0.5 \leq \cos \phi < 0.8$	

Measurement		Measurement Range without ratio (with unity ratio)		Display Resolution ⁽¹¹⁾ (unity ratio)	Max Intrinsic Error
		Min	Max		
Reactive power (Q _r) ⁽²⁾ and Non-active power (N)	Without AmpFlex [®] and MiniFlex [®]	1.000 var ⁽³⁾	10.00 Mvar ⁽⁴⁾	4 digits ⁽⁵⁾	±(1 % + 10 cts) sin φ ≥ 0.5 and THD ≤ 50 %
					±(1.5 % + 10 cts) 0.2 ≤ sin φ < 0.5 and THD ≤ 50 %
	With AmpFlex [®] and MiniFlex [®]	1.000 var ⁽³⁾	10.00 Mvar ⁽⁴⁾	4 digits ⁽⁵⁾	±(1.5 % + 10 cts) sin φ ≥ 0.5 and THD ≤ 50 %
					±(1.5 % + 20 pt) 0.2 ≤ sin φ < 0.5 and THD ≤ 50 %
Distorting power (D) ⁽⁷⁾	1.000 var ⁽³⁾	10.00 Mvar ⁽⁴⁾	4 digits ⁽⁵⁾	±(2 % S + (0.5 % n _{max} + 50 pt)) THD _A ≤ 20 %f and sin φ ≥ 0.2	
				±(2 % S + (0.7 % n _{max} + 10 cts)) THD _A > 20 %f and sin φ ≥ 0.2	
Apparent power (S)		1.000 V·A ⁽³⁾	10.00 MV·A ⁽⁴⁾	4 digits ⁽⁵⁾	±(1 % + 10 cts)
DC power (P _{DC})		1.000 W ⁽⁸⁾	6.000 MV·A ⁽⁹⁾	4 digits ⁽⁵⁾	±(1 % + 10 cts)
Power factor (PF)		-1	1	0.001	±(1.5 % + 10 cts) cos φ ≥ 0.2
Active energy (E _P) ⁽¹⁾	Without AmpFlex [®] and MiniFlex [®]	1 W·h	9,999,999 MW·h ⁽⁶⁾	up to 7 digits ⁽⁵⁾	±(1 % + 10 cts) cos φ ≥ 0.8
					±(1.5 % + 10 cts) 0.2 ≤ cos φ < 0.8
	With AmpFlex [®] and MiniFlex [®]	1 W·h	9,999,999 MW·h ⁽⁶⁾	up to 7 digits ⁽⁵⁾	±(1 % + 10 cts) cos φ ≥ 0.8
					±(1.5 % + 10 cts) 0.5 ≤ cos φ < 0.8

Measurement		Measurement Range without ratio (with unity ratio)		Display Resolution ⁽¹¹⁾ (unity ratio)	Max Intrinsic Error
		Min	Max		
Reactive energy (E_{Qf}) ⁽²⁾ and non-active energy (E_N) ⁽²⁾	Without AmpFlex [®] and MiniFlex [®]	1 var·h	9,999,999 Mvar·h ⁽⁶⁾	up to 7 digits ⁽⁵⁾	$\pm(1\% + 10 \text{ cts})$ $ \sin \phi \geq 0.5$ and THD $\leq 50\%$ $\pm(1.5\% + 10 \text{ cts})$ $0.2 \leq \sin \phi < 0.5$ and THD $\leq 50\%$
	With AmpFlex [®] and MiniFlex [®]	1 var·h	9,999,999 Mvar·h ⁽⁶⁾	up to 7 digits ⁽⁵⁾	$\pm(1.5\% + 10 \text{ cts})$ $ \sin \phi \geq 0.5$ and THD $\leq 50\%$ $\pm(1.5\% + 20 \text{ pt})$ $0.2 \leq \sin \phi < 0.5$ and THD $\leq 50\%$
Distorting energy (E_D)		1 var·h	9,999,999 Mvar·h ⁽⁶⁾	up to 7 digits ⁽⁵⁾	$\pm(2\% S + (0.5\% n_{\max} + 50 \text{ pt}))$ THD _A $\leq 20\%f$ and $ \sin \phi \geq 0.2$ $\pm(2\% S + (0.7\% n_{\max} + 10 \text{ cts}))$ THD _A $\leq 20\%f$ and $ \sin \phi \geq 0.2$
Apparent energy (E_S)		1 V·A·h	9,999,999 MV·A·h ⁽⁶⁾	up to 7 digits ⁽⁵⁾	$\pm(1\% + 10 \text{ cts})$
DC energy (E_{PDC})		1 W·h	9,999,999 MW·h ⁽¹⁰⁾	up to 7 digits ⁽⁵⁾	$\pm(1\% + 10 \text{ cts})$

Table 4

1. The uncertainties on the active power and energy measurements are greatest at $|\cos \phi| = 1$ and typical for other phase differences.
2. The uncertainties on the reactive power and energy measurements are greatest at $|\sin \phi| = 1$ and typical for other phase differences.
3. For the MN193 clamps (5 A) or adapters (5 A)
4. For the AmpFlex[®] and MiniFlex[®] and for a single-phase, 2-wire connection
5. The resolution depends on the current sensor and displayed values.
6. The energy corresponds to more than 114 years of the associated maximum power with unity ratios.
7. When the harmonic level is not zero, the highest order is n_{\max} . THD_A is the THD of the current.
8. For 100 mV/A E94 clamp.
9. The energy corresponds to more than 190 years of the maximum power P_{DC} at unit ratios.
10. The display resolution is determined by the apparent power (S) or apparent energy (E_S).

17.2.4.3 Quantities Associated with Power Values

Measurement	Measurement Range		Display Resolution	Max Intrinsic Error
	Min	Max		
Fundamental phase differences	-179 °	180 °	0.1 °	±2 °
cos φ (DPF, PF ₁)	-1	1	4 digits	±5 cts
tan φ	-32.77 ⁽¹⁾	32.77 ⁽¹⁾	4 digits	±1 ° if THD < 50 %
Voltage unbalance (u ₀)	0 %	100 %	0.1 %	±3 cts if u ₀ ≤ 10 % ±10 cts if u ₀ > 10%
Current unbalance (a ₂)	0 %	100 %	0.1 %	±10 cts

Table 5

1. $|\tan \varphi| = 32.767$ corresponds to $\varphi = \pm 88.25^\circ + k \times 180^\circ$ (with k as a natural integer)

17.2.4.4 Harmonics

Measurement	Measurement Range		Display Resolution	Max Intrinsic Error
	Min	Max		
Harmonic level of voltage (τ _n)	0 %	1500 %f 100 %r	0.1 % τ _n < 1000 %	±(2.5 % + 5 cts)
			1 % τ _n ≥ 1000 %	
Harmonic level of current (τ _n) (without AmpFlex® and MiniFlex®)	0 %	1500 %f 100 %r	0.1 % τ _n < 1000 %	±(2 % + (n × 0.2 %) + 10 cts) n ≤ 25
			1 % τ _n ≥ 1000 %	±(2 % + (n × 0.6 %) + 5 cts) n > 25

Measurement	Measurement Range		Display Resolution	Max Intrinsic Error
	Min	Max		
Harmonic level of current (τ_n) (with AmpFlex® and MiniFlex®)	0 %	1500 %f 100 %r	$T_n < 1000$ %	$\pm(2\% + (n \times 0.3\%) + 5 \text{ cts})$ $n \leq 25$
			$T_n \geq 1000$ %	$\pm(2\% + (n \times 0.6\%) + 5 \text{ cts})$ $n > 25$
Total harmonic distortion (THD) of the voltage with respect to the fundamental	0 %	999.9 %	0.1 %	$\pm(2.5\% + 5 \text{ cts})$
Total harmonic distortion (THD) of the current with respect to the fundamental (without AmpFlex® and MiniFlex®)	0 %	999.9 %	0.1 %	$\pm(2.5\% + 5 \text{ cts})$ if $\forall n \geq 1, t_n \leq (100 + n)$ [%]
				or
				$\pm(2\% + (n_{\max} \times 0.2\%) + 5 \text{ cts})$ $n_{\max} \leq 25$
Total harmonic distortion (THD) of the current with respect to the fundamental (with AmpFlex® and MiniFlex®)	0 %	999.9 %	0.1 %	$\pm(2\% + (n_{\max} \times 0.5\%) + 5 \text{ cts})$ $n_{\max} > 25$
				or
				$\pm(2.5\% + 5 \text{ cts})$ if $\forall n \geq 1, t_n \leq (100 + n^2)$ [%]
Total harmonic distortion (THD) of voltage with respect to the signal without DC	0 %	100 %	0.1 %	$\pm(2\% + (n_{\max} \times 0.3\%) + 5 \text{ cts})$ $n_{\max} \leq 25$
				or
				$\pm(2\% + (n_{\max} \times 0.6\%) + 5 \text{ cts})$ $n_{\max} > 25$
Total harmonic distortion (THD) of the current with respect to the signal without DC (without AmpFlex® and MiniFlex®)	0 %	100 %	0.1 %	$\pm(2.5\% + 5 \text{ cts})$ if $\forall n \geq 1, t_n \leq (100 + n)$ [%]
				or
				$\pm(2\% + (n_{\max} \times 0.2\%) + 5 \text{ cts})$ $n_{\max} \leq 25$
The current's total harmonic distortion (THD) with respect to the signal without DC (with AmpFlex® and MiniFlex®)	0 %	100 %	0.1 %	$\pm(2\% + (n_{\max} \times 0.5\%) + 5 \text{ cts})$ $n_{\max} > 25$
				or
				$\pm(2.5\% + 5 \text{ cts})$ if $\forall n \geq 1, t_n \leq (100 + n^2)$ [%]
				$\pm(2\% + (n_{\max} \times 0.3\%) + 5 \text{ cts})$ $n_{\max} \leq 25$
				or
				$\pm(2\% + (n_{\max} \times 0.6\%) + 5 \text{ cts})$ $n_{\max} > 25$

Measurement	Measurement Range		Display Resolution	Max Intrinsic Error
	Min	Max		
Harmonic loss factor (FHL)	1	99.99	0.01	$\pm(5\% + (n_{\max} \times 0.4\%) + 5 \text{ cts})$ $n_{\max} \leq 25$
				$\pm(10\% + (n_{\max} \times 0.7\%) + 5 \text{ cts})$ $n_{\max} > 25$
K factor (KF)	1	99.99	0.01	$\pm(5\% + (n_{\max} \times 0.4\%) + 5 \text{ cts})$ $n_{\max} \leq 25$
				$\pm(10\% + (n_{\max} \times 0.7\%) + 5 \text{ cts})$ $n_{\max} > 25$
Phase differences of harmonics (order ≥ 2)	-179 °	180 °	1 °	$\pm(1.5^\circ + 1^\circ \times (n \div 12.5))$

The highest order when the harmonic level is not zero is n_{\max}

Measurement		Measurement Range (with unity ratio)		Display Resolution (unity ratio)	Max Intrinsic Error
		Min	Max		
RMS voltage of harmonic (order $n \geq 2$)	phase-to-neutral	2 V	1000 V ⁽¹⁾	4 digits	$\pm(2.5\% + 1 \text{ V})$
				4 digits	
	phase-to-phase	2 V	2000 V ⁽¹⁾	4 digits	$\pm(2.5\% + 1 \text{ V})$
				4 digits	
Distorting voltage (RMS)	phase-to-neutral (V_d)	2 V	1000 V ⁽¹⁾	4 digits	$\pm(2.5\% + 1 \text{ V})$
				4 digits	
Distorting voltage (RMS)	phase-to-phase (U_d)	2 V	2000 V ⁽¹⁾	4 digits	$\pm(2.5\% + 1 \text{ V})$
				4 digits	

Measurement		Measurement Range (with unity ratio)		Display Resolution (unity ratio)	Max Intrinsic Error
		Min	Max		
RMS current of harmonic RMS ⁽³⁾ (order n ≥ 2)	SR193 clamp MR193 clamp	1 A	1000 A	4 digits	n ≤ 25: ±(2 % + (n x 0.2 %) + 1 A)
				4 digits	n > 25: ±(2 % + (n x 0.5 %) + 1 A)
	MN93 clamp	200 mA	200 A	4 digits	n ≤ 25: ±(2 % + (n x 0.2 %) + 1 A)
				4 digits	n > 25: ±(2 % + (n x 0.5 %) + 1 A)
	E94 clamp (10 mV/A) MN193 clamp (100 A)	200 mA	100 A	4 digits	n ≤ 25: ±(2 % + (n x 0.2 %) + 100 mA)
				4 digits	n > 25: ±(2 % + (n x 0.5 %) + 100 mA)
	E94 clamp (100 mV/A)	20 mV/A	10 A	4 digits	n ≤ 25: ±(2 % + (n x 0.2 %) + 10 mA)
				4 digits	n > 25: ±(2 % + (n x 0.5 %) + 10 mA)
	MN193A clamp (5 A)	5 mA	5 A	4 digits	n ≤ 25: ±(2 % + (n x 0.2 %) + 10 mA)
				4 digits	n > 25: ±(2 % + (n x 0.5 %) + 10 mA)
RMS current of harmonic RMS ⁽³⁾ (order n ≥ 2)	AmpFlex® 193 MiniFlex® MA194-24-BK (10 kA)	10 A	10 kA	4 digits	n ≤ 25: ±(2 % + (n x 0.3 %) + 1 A + (AfRMS ⁽²⁾ x 0.1 %))
				4 digits	n > 25: ±(2 % + (n x 0.6 %) + 1 A + (AfRMS ⁽²⁾ x 0.1 %))
	AmpFlex® 193 MiniFlex® MA194-24-BK (6500 A)	10 A	6500 A	4 digits	n ≤ 25: ±(2 % + (n x 0.3 %) + 1 A + (AfRMS ⁽²⁾ x 0.1 %))
				4 digits	n > 25: ±(2 % + (n x 0.6 %) + 1 A + (AfRMS ⁽²⁾ x 0.1 %))
	AmpFlex® 193 MiniFlex® MA194-24-BK (100 A)	100 mA	100 A	4 digits	n ≤ 25: ±(2 % + (n x 0.2 %) + 30 pt)
				4 digits	n > 25: ±(2 % + (n x 0.5 %) + 30 pt)

Measurement		Measurement Range (with unity ratio)		Display Resolution (unity ratio)	Max Intrinsic Error
		Min	Max		
Distorting current (RMS) (Ad) ⁽³⁾	SR193 clamp MR193 clamp	1 A	1000 A	4 digits	$\pm((n_{max} \times 0.4 \%) + 1 \text{ A})$
				4 digits	
	MN93 clamp	200 mA	200 A	4 digits	$\pm((n_{max} \times 0.4 \%) + 1 \text{ A})$
	MN193 clamp (100 A)	100 mA	100 A	4 digits	$\pm((n_{max} \times 0.4 \%) + 100 \text{ mA})$
	E94 clamp (10 mV/A) MN193 clamp (100 A)	200 mA	100 A	4 digits	$\pm((n_{max} \times 0.4 \%) + 100 \text{ mA})$
				4 digits	
	E94 clamp (100 mV/A)	20 mA	10 A	4 digits	$\pm((n_{max} \times 0.4 \%) + 10 \text{ mA})$
			4 digits		
MN193 (5 A)	5 mA	5 A	4 digits	$\pm((n_{max} \times 0.4 \%) + 10 \text{ mA})$	
AmpFlex® 193 MiniFlex® MA194-24-BK (10 kA)	10 A	10 kA	4 digits	$(n_{max} \times 0.4 \%) + 1 \text{ A})$	
			4 digits		
Distorting current (RMS) (Ad) ⁽³⁾	AmpFlex® 193 MiniFlex® MA194-24-BK (6500 A)	10 A	6500 A	4 digits	$\pm((n_{max} \times 0.4 \%) + 1 \text{ A})$
				4 digits	
	AmpFlex® 193 MiniFlex® MA194-24-BK (100 A)	100 mA	100 A	4 digits	$\pm(n_{max} \times 0.5 \%) + 30 \text{ pt})$
				4 digits	

Table 6

1. Provided that the voltages between the individual terminals and earth do not exceed 1000 V_{RMS}
2. RMS value of the fundamental
3. When the harmonic level is not zero, the highest order is n_{max} .

17.2.4.5 Current and Voltage Ratios

Ratio	Minimum	Maximum
Voltage	$\frac{100}{1000 \times \sqrt{3}}$	$\frac{9999900 \times \sqrt{3}}{0.1}$
Current ⁽¹⁾	1/5	60,000/1

Table 7

1. Only for the 5 A MN193 clamps and the 5 A adapters

17.2.5 Specifications of the Current Sensors

You must add the measurement error on the RMS current and phase error to any instrument error for measurements that use the current measurements: powers, energies, power factors, tangents, etc.

Sensor Type	At 50/60 Hz		
	RMS Current (A_{RMS})	Maximum Error	Maximum Error on ϕ
AmpFlex® 193	[1000 A ... 12,000 A]	$\pm(1.2 \% + 1 \text{ A})$	$\pm 0.5^\circ$
	[100 A ... 1000 A]	$\pm(1.2 \% + 0.5 \text{ A})$	
	[5 A ... 100 A]	$\pm(1.2 \% + 0.2 \text{ A})$	
	[0.1 A ... 5 A]	$\pm(1.2 \% + 0.2 \text{ A})$	-
MiniFlex® MA194-24-BK	[1000 A ... 12,000 A]	$\pm(1 \% + 1 \text{ A})$	$\pm 0.5^\circ$
	[100 A ... 1000 A]	$\pm(1 \% + 0.5 \text{ A})$	
	[5 A ... 100 A]	$\pm(1 \% + 0.2 \text{ A})$	
	[0.1 A ... 5A]	$\pm(1 \% + 0.2 \text{ A})$	-
SR193 clamp (1000 A)	[1 A ... 50 A]	$\pm 1 \%$	-
	[50 A ... 100 A]	$\pm 0.5 \%$	$\pm 1^\circ$
	[100 A ... 1200 A]	$\pm 0.3 \%$	$\pm 0.7^\circ$
MR193 clamp (1000 A)	[0.5 A ... 100 A]	$\pm(1.5 \% + 1 \text{ A})$	$\pm 2.5^\circ$
	[100 A ... 800 A]	$\pm 2.5 \%$	$\pm 2^\circ$
	[800 A ... 1000 A]	$\pm 4 \%$	$\pm 2^\circ$
MN93 clamp (200 A)	[0.5 A ... 5 A]	$\pm(3 \% + 1 \text{ A})$	-
	[5 A ... 40 A]	$\pm(2.5 \% + 1 \text{ A})$	$\pm 5^\circ$
	[40 A ... 100 A]	$\pm(2 \% + 1 \text{ A})$	$\pm 3^\circ$
	[100 A ... 240 A]	$\pm(1 \% + 1 \text{ A})$	$\pm 2.5^\circ$
MN193 clamp (100 A)	[0.2 A ... 5 A]	$\pm(1 \% + 2 \text{ mA})$	$\pm 4^\circ$
	[5 A ... 120 A]	$\pm 1 \%$	$\pm 2.5^\circ$
MN193 clamp (5 A)	[0.005 A ... 0.25 A]	$\pm(1.5 \% + 0.1 \text{ mA})$	-
	[0.25 A ... 6 A]	$\pm 1 \%$	$\pm 5^\circ$
E94 clamp (BNC) (100 A)	[0.5 A ... 40 A]	$\pm(4 \% + 50 \text{ mA})$	$\pm 1^\circ$
	[40 A ... 70 A]	$\pm 15 \%$	$\pm 1^\circ$
E94 clamp (BNC) (10 A)	[0.1 A ... 7 A]	$\pm(3 \% + 50 \text{ mA})$	$\pm 1.5^\circ$

Table 8

This table does not account for any possible distortion of the measured signal (THD) due to the current sensor's physical limitations (saturation of the magnetic circuit or the Hall effect sensor).

Limitations of the AmpFlex® and MiniFlex®

Like all Rogowski sensors, the AmpFlex® and MiniFlex® have output voltage that is proportional to the frequency. A high current at high frequency can saturate the instrument's current input.

To avoid saturation, you must meet the following condition:

$$\sum_{n=1}^{n=\infty} [n \cdot I_n] < I_{nom}$$

- The range of the current sensor is I_{nom}
- The order of the harmonic is n
- The current of the harmonic of order n is I_n

For example, the input current range of a dimmer must be one-fifth of the current range selected on the instrument. Any wave-train dimmers with a non-integer number of periods are not compatible with AmpFlex® or MiniFlex® sensors.

This requirement does not take into account the instrument's bandwidth limitation that can lead to other errors.

17.2.6 Uncertainty of the Real-Time Clock

The uncertainty of the real-time clock is 80 ppm or less when the instrument is 3-years old and used at an ambient temperature of 50 °C.

This uncertainty is 30 ppm or less for a new instrument used at an ambient temperature of 25 °C.

17.3 MEMORY CARD

The Model 8345 is delivered with a 16 GB SD card. Depending on their capacities, SD cards can store:

	SD Card Memory Capacity	
	16 GB	32 GB
Screenshots	50	50
Number of alarms	16,362	16,362
Searches for transients	210	210
Searches for shock waves	5	5
Inrush current capture, RMS+PEAK – 10 min	1	1
Trend recording of all parameters	1 recording for 40 days (3 s sampling period)	1 recording for 84 days (3 s sampling period)
Single trend recording of all parameters per EN 50160	3 days (200 ms sampling period)	6 days (200 ms sampling period)
	15 days (1 s sampling period)	30 days (1 s sampling period)
	45 days (3 s sampling period)	90 days (3 s sampling period)

The file size will increase as the recording interval decreases and the recording duration increases.

17.4 POWER SUPPLY

17.4.1 Battery

The instrument's power supply unit is a 10.9 V, 5700 mA·h, Li-ion battery pack.

Voltage	10.86 V	
Nominal capacity	5700 mA·h	
Minimum capacity	5500 mA·h	
Loss of capacity	11 % after 200 charge-discharge cycles 16 % after 400 charge-discharge cycles	
The charging current and duration depend on the power supply unit (PA40W-2 or PA32ER)	50 °F < T < 104 °F (10 °C < T < 40 °C)	PA40W-2: 1.5 A and 3 h 50 min PA32ER: 1 A and 5 h 50 min
	32 °F < T < 50 °F (0 °C < T < 10 °C)	PA40W-2: 0.75 A and 7 h 30 min PA32ER: 0.5 A and 11 h 30 min
	-4 °F < T < 32 °F (-20 °C < T < 0 °C)	PA40W-2: 0 A PA32ER: 0 A
Temperature of use	-4 °F to 140 °F (-20 °C to +60 °C)	
Recharging temperature	32 °F to 104 °F (0 °C to 40 °C)	
Storage temperature	For one month	-4 °F to 140 °F (-20 °C to +60 °C)
	For three months	-4 °F to 113 °F (-20 °C to +45 °C)
	For one year	-4 °F to 68 °F (-20 °C to +20 °C)

Remove the battery if the instrument will not be used for an extended period (see § 18.3).

17.4.2 External Power Supply

You can connect the Model 8345 to an external power supply to charge the battery or conserve battery life. The instrument can operate while charging.

The instrument has one compatible charger:

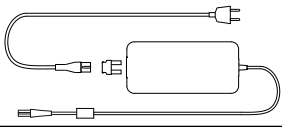
PA32ER	
	
Nominal voltage and overvoltage category	1000 V CAT IV
Input voltage	(100 to 1000) V _{AC} (150 to 1000) V _{DC}
Input frequency	(40 to 70) Hz (340 to 440) Hz
Maximum input current	2 A
Maximum input power	30 W
Output voltage	15 V \pm 7 %
Output power	30 W
Dimensions	(8.66 x 4.41 x 2.05) in (220 x 112 x 53) mm
Weight	Approximately 2 lb (930 g)
Temperature of use	(-4 to 122) °F (-20 to +50) °C from (30 to 95) % RH without condensation
Storage temperature	(-13 to 158) °F (-25 to +70) °C from (10 to 90) % RH without condensation



NOTE: To use these power supplies, please refer to their manuals.

17.4.3 Battery Life

The instrument's typical consumption is 750 mA, which includes the display, SD card, GPS, Ethernet link, Wi-Fi, and powering current sensors when necessary.

When the screen is on and the battery is fully charged, the battery life is approximately 6 hours.

If the screen is off, the battery life is approximately 10 hours.

17.5 DISPLAY CONDITIONS

The display unit is an active matrix LCD (TFT) with the following specifications:

Diagonal: 7 in (18 cm)

Resolution: 800 pixels x 480 pixels (WVGA)

Colors: 262,144 colors used for display

Backlight: LED

Field of view: 85 ° in all directions

17.6 ENVIRONMENTAL CONDITIONS

The instrument must be used in the following environmental conditions.

1 = Range of Reference: 23 °C ± 3 °C from (40 to 75) % RH

2 = Range of Use: (23 to 113) °F (-5 to +45) °C from (5 to 80) % RH
(23 to 95) °F (-5 to +35) °C from (5 to 95) % RH

3 = Range of Storage w/ Battery: (-4 to 122) °F (-20 to +50) °C from (5 to 75) % RH
(-4 to 95) °F (-20 to +35) °C from (5 to 95) % RH

4 = Range of Storage w/o Battery: (-40 to 158) °F (-40 to +70) °C from (5 to 95) % RH

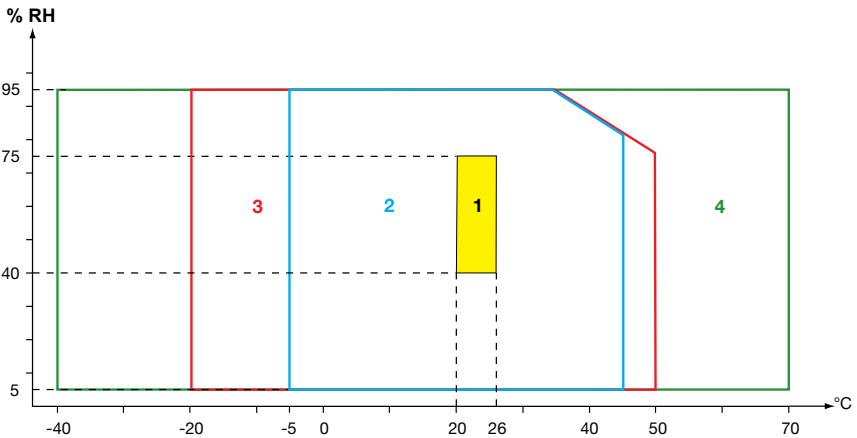

Indoor use

Operating altitude: <6562 ft <2000 m

Storage altitude: <32,808 ft <10,000 m

Degree of pollution: 3

17.7 MECHANICAL SPECIFICATIONS

Dimensions (L x D x H): (7.87 x 11.22 x 2.17) in (200 x 285 x 55) mm

Weight: 4.41 lb (2 kg)

Display unit: (5.98 x 3.58) in (152 x 91) mm

Display unit (diagonal): 7 in (178 mm)

Index of protection:

- IP54 per IEC 60529 when the five elastomer caps are closed and no leads are on the nine terminals
- IP20 on the measurement terminals when the instrument is in service
- IK06 per IEC 62262, without screen

Drop test: 1 m per IEC 60068-2-31

17.8 COMPLIANCE WITH INTERNATIONAL STANDARDS

17.8.1 Electrical Safety

The instrument complies with IEC/EN 61010-2-030 and BS EN 61010-2-030:

Measurement inputs and enclosure: 1000 V CAT IV, degree of pollution 3

Power supply input: 1000 V CAT IV, degree of pollution 3

The current sensors comply with standard IEC/EN 61010-2-032 and BS EN 61010-2-032 600 V CAT IV or 1000 V CAT III, degree of pollution 2.

The measurement leads and crocodile clips comply with standard IEC/EN 61010-031 and BS EN 61010-031, 1000 V CAT IV, degree of pollution 2.

Association with current sensors:

- Using the AmpFlex®, the MiniFlex®, and SR193 clamps creates an **instrument + current sensor** assembly rated at 600 V CAT IV or 1000 V CAT III
- Using MR193, MN193, MN193, and E94 clamps creates an **instrument + clamp** assembly rated at 300 V CAT IV or 600 V CAT III



NOTE: To protect the user, the instrument has protection impedances between the input terminals and the electronic circuit. If the user connects a USB lead to the instrument and touches the other end of the lead, the voltage and current will not endanger the user.

The devices comply with BS EN 62749 for EMF. Product intended for professional use.

17.8.2 Standard IEC 61000-4-30, Class A

All of the measurement methods, measurement uncertainties, measurement ranges, aggregations of measurements, flagging, and markings comply with the requirements of IEC 61000-4-30, edition 3.0, Amendment 1 (2021), for instruments of Class A.

The Model 8345 performs measurements and calculations for the following.

- Line frequency over 10 s
- Amplitude of the voltage for 10/12 cycles, 150/180 cycles, 10 min, and 2 h
- Voltage unbalance for 10/12 cycles, 150/180 cycles, 10 min, and 2 h
- Harmonics of voltages for 10/12 cycles, 150/180 cycles, 10 min, and 2 h
- Interharmonics of voltages for 10/12 cycles, 150/180 cycles, 10 min, and 2 h
- Minimum and maximum values of the voltage (Under/Over deviation)
- Flicker over 10 min and 2 h
- Detection of voltage dips, swells, and interruptions, in amplitude and duration
- Mains signaling voltages (MSV)
- Rapid voltage changes (RVC)
- Amplitude of the current for 10/12 cycles, 150/180 cycles, 10 min, and 2 h
- Current unbalance for 10/12 cycles, 150/180 cycles, 10 min, and 2 h
- Harmonics of currents for 10/12 cycles, 150/180 cycles, 10 min, and 2 h
- Interharmonics of currents for 10/12 cycles, 150/180 cycles, 10 min, and 2 h

All measurements are made for 10/12 cycles and synchronized with UTC time every 10 min.

Then, they are aggregated to 150/180 cycles, 10 min, and 2 h.

Class A certification has been carried out in accordance with standard IEC 62586-2 edition 2 Amendment 1 (2021).

17.8.3 Standards IEC 62053-22 (Active Energy) and IEC 62053-24 (Reactive Energy)

The CA8345 complies with the following standards:

- Active Energy EP: IEC 62053-22 Class 0.2S
- Reactive Energy EQf: IEC 62053-24 Class 0.5S

The tests are carried out using an MN94 current clamp.

17.8.3 Measurement Uncertainties and Ranges

Parameter		Measurement Range	Uncertainty	Range of Quantity of Influence
Line frequency	50 Hz network	42.5 Hz to 57.5 Hz	± 10 mHz	U _{din} ∈ [100 V; 400 V] (V) U _{din} ∈ [200 V; 1000 V] (U)
	60 Hz network	51 Hz to 69 Hz		
Supply voltage amplitude		[10 %; 150 %] U _{din}	±0.1 % U _{din}	U _{din} ∈ [100 V; 400 V] (V) U _{din} ∈ [200 V; 1000 V] (U)
Flicker	P _{inst} , P _{max}	0.2 to 12	±8 %	U _{din} ∈ [100 V; 400 V] (V) U _{din} ∈ [200 V; 1000 V] (U)
	P _{st} , P _{lt}	0.2 to 12	Max (± 5 %; 0.05)	
Voltage dips	Amplitude	[10 %; 90 %] U _{din}	±0.2 % U _{din}	U _{din} ∈ [100 V; 400 V] (V) U _{din} ∈ [200 V; 1000 V] (U)
	Beginning	-	½ cycle	
	Duration	≥½ cycle x 1 cycle	1 cycle	
Voltage swells	Amplitude	[110 %; 200 %] U _{din}	±0.2 % U _{din}	U _{din} ∈ [100 V; 400 V] (V) U _{din} ∈ [200 V; 1000 V] (U)
	Beginning	-	½ cycle	
	Duration	≥½ cycle	1 cycle	
Voltage interruptions	Beginning	-	½ cycle	U _{din} ∈ [100 V; 400 V] (V) U _{din} ∈ [200 V; 1000 V] (U)
	Duration	≥½ cycle x 1 cycle	1 cycle	
Voltage unbalance		0.5 % to 5 % (absolute)	± 0.15 % (absolute)	U _{din} ∈ [100 V; 400 V] (V) U _{din} ∈ [200 V; 1000 V] (U)
Voltage harmonics (V _{sgh} /U _{sgh})	h ∈ [0 ; 50]	[0.1 % ; 16 %] of V1/ U1 and V _{sgh} /U _{sgh} ≥ 1 % U _{din}	± 5 %	U _{din} ∈ [100 V; 400 V] (V) U _{din} ∈ [200 V; 1000 V] (U)
		[0.1 % ; 16 %] of V1/ U1 and V _{sgh} /U _{sgh} < 1 % U _{din}	± 0.05 % U _{din}	
Voltage interharmonics (V _{isgh} /U _{isgh})	h ∈ [0 ; 49]	[0.1 % ; 10 %] of V1/ U1 and V _{isgh} /U _{isgh} ≥ 1 % U _{din}	± 5 %	U _{din} ∈ [100 V; 400 V] (V) U _{din} ∈ [200 V; 1000 V] (U)
		[0.1 % ; 10 %] of V1/ U1 and V _{isgh} /U _{isgh} < 1 % U _{din}	± 0.05 % U _{din}	
Mains signaling voltages		[3 % ; 15 %] U _{din} [0 Hz; 3 kHz]	± 5 %	U _{din} ∈ [100 V; 400 V] (V) U _{din} ∈ [200 V; 1000 V] (U)
		[1 % ; 3 %] U _{din} [0 Hz; 3 kHz]	± 0.15 % U _{din}	

Parameter		Measurement Range	Uncertainty	Range of Quantity of Influence
Rapid voltage changes (RVC) $V_{RMS\frac{1}{2}}/U_{RMS\frac{1}{2}}$	Beginning	-	$\frac{1}{2}$ cycle	$U_{din} \in [100 \text{ V}; 400 \text{ V}] \text{ (V)}$ $U_{din} \in [200 \text{ V}; 1000 \text{ V}] \text{ (U)}$
	Duration	-	1 cycle	
	ΔU_{max}	$[1 \% ; 6 \%] U_{din}$	$\pm 0.2 \% U_{din}$	
	ΔU_{ss}	$[1 \% ; 6 \%] U_{din}$	$\pm 0.2 \% U_{din}$	
Amplitude of current		[10 %; 100 %] of the full-scale technical class-A RMS value of the current	$\pm 1 \%$	See the Nominal Current (A_{nom}) Table in § 17.1
Current harmonics (I_{sgh})	$h \in [0 ; 50]$	$I_{sgh} \geq 3 \% I_{nom}$	$\pm 5 \%$	I_{nom}
		$I_{sgh} < 3 \% I_{nom}$	$\pm 0.15 \% I_{nom}$	
Current Interharmonics (I_{isgh})	$h \in [0 ; 49]$	$I_{isgh} \geq 3 \% I_{nom}$	$\pm 5 \%$	I_{nom}
		$I_{isgh} < 3 \% I_{nom}$	$\pm 0.15 \% I_{nom}$	
Current unbalance (a_0, a_2)		0.5 % to 5 % (absolute)	$\pm 0.15 \%$ (absolute)	I_{nom}

Table 9

17.8.4 Markings per IEC 62586-1

The marking **PQI-A-PI** means:

PQI-A: Class A power quality instrument

P: Portable measuring instrument

I: Indoor use

17.9 ELECTROMAGNETIC COMPATIBILITY (EMC)

The instrument is in compliance with the requirements of standard IEC/EN 61326-1 or BS EN 61326-1.

- The instrument is intended for use in an industrial environment.
- The instrument is a Class A product.
- This instrument is not intended for use in residential environments and may not ensure adequate protection of radio reception in this residential environment.

For AmpFlex® and MiniFlex® sensors:

- An (absolute) influence of 2 % may be observed on the current THD measurement in the presence of a radiated electric field.
- An influence of 0.5 A may be observed on the RMS current measurement in the presence of conducted radio frequencies.
- An influence of 1 A may be observed on the RMS current measurement in the presence of a magnetic field.

17.10 RADIO EMISSIONS

The instrument complies with directive RED 2014/53/EU and FCC regulations.

The Wi-Fi module is certified in compliance with the FCC regulations under number XF6-RS9113SB.

17.11 GPL CODE

The source codes are available under GNU GPL (General Public License).

18. MAINTENANCE

Except for the batteries, the instrument contains no parts that can be replaced by untrained or unaccredited personnel. Any unapproved work or part replacement using equivalents may gravely compromise safety.

18.1 CLEANING THE HOUSING

1. Disconnect anything connected to the instrument.
2. Turn the instrument off.
3. Use a soft cloth moistened with soapy water.
4. Rinse with a damp cloth.
5. Then, dry rapidly with a dry cloth or forced air.



WARNING: Do not use alcohol, solvents, or hydrocarbons to clean the instrument or sensors.

18.2 SENSOR MAINTENANCE

The current sensors must be regularly maintained for best results and safety.

1. Use a soft cloth, moistened with soapy water.
2. Rinse with a damp cloth.
3. Dry rapidly with a dry cloth or forced air.
4. Keep the air gaps of the clamps perfectly clean.
5. Lightly oil visible metal parts to prevent rust.

18.3 BATTERY PACK REPLACEMENT

This instrument's battery is unique. It has specifically-adapted protective and safety elements. Replacing the battery with a different model creates a risk of explosion or fire. For your safety, please abide by the precautions for replacing the battery.



NOTE: Whenever the battery has been disconnected, even if it has not been replaced, it must be fully charged. This is so the instrument will know the battery's charge status (this information is lost when it disconnects).



Do not treat old batteries as household waste. Take them to the appropriate collection point for recycling.

Precautions for replacing the battery pack:

NOTE: Without a battery, the instrument's internal clock will continue to operate for at least 17 hours.

- Only use the same model of battery as a replacement.
- Do not use a battery with a damaged housing.
- Do not throw the battery into a fire.
- Do not expose the battery to a temperature exceeding 100 °C.
- Do not short-circuit the battery pack terminal.

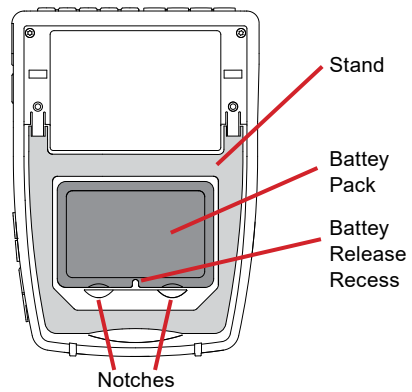

Replacing the battery pack:

1. Disconnect everything that is connected to the instrument.
2. Turn the instrument so the backside is facing you. The installed battery pack and battery release recess are exposed.
3. Insert a small flat head (slotted) screwdriver straight into the battery release recess.
4. Gently, push down on the screwdriver to release the battery pack.
5. Use the two notches to help extract the battery pack from its compartment.
6. Grab battery pack with your fingers and extract it from its compartment.
7. Install replacement battery pack. Press down until you hear the click of the locking mechanism.
8. Properly dispose of old battery pack.

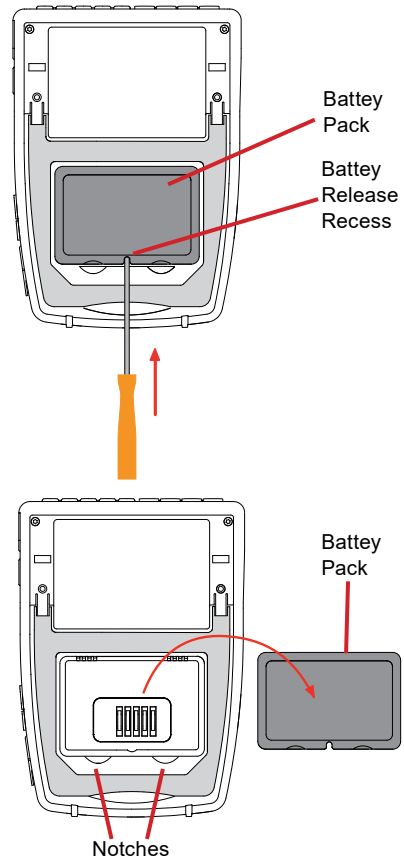

18.4 MEMORY CARD

The instrument accepts type SD (SDSC), SDHC, and SDXC memory cards.

- Lock the memory card when you remove it from the instrument.
- Unlock the SD card before putting the card back into the instrument.



1. To remove the memory card from its slot, open the elastomer cap.
2. Press down on the SD card and release to remove it from its slot.
3. To put the card back in place, insert the card into the slot until you feel it click. The red indicator will light up.
4. Then, put the elastomer cap back in place.

18.5 UPDATING THE FIRMWARE

To provide our customers the best possible service for performance and technical upgrades, AEMC® Instruments offers free software and firmware updates on our website.

You can perform the update a few different ways.

- Copy the update file to a USB drive, then insert the drive in its port in the instrument.
- Copy the update file to the SD card and insert the card in its slot in the instrument.

NOTE: The firmware update depends on its compatibility with the instrument's hardware version. The version is in the instrument configuration, as explained in § 3.8.

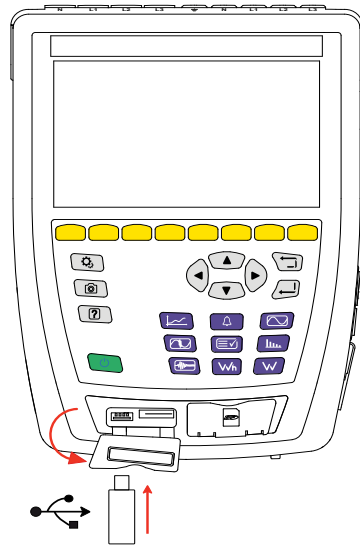

WARNING: When the firmware is updated, all configuration data, including user profiles and future scheduled recordings, is erased. Therefore, before updating the firmware, use the application software to save any data you wish to retain to a PC.

18.6 REPAIR AND CALIBRATION

To ensure that your instrument meets factory specifications, we recommend that it be sent back to our factory Service Center at one-year intervals for recalibration or as required by other standards or internal procedures.

(Or contact your authorized distributor.)

Contact us for the costs for repair, standard calibration, and calibration traceable to N.I.S.T.



NOTE: You must obtain a CSA# before returning any instrument.

18.7 TECHNICAL ASSISTANCE

If you are experiencing any technical problems or require any assistance with the proper operation or application of your instrument, please call, e-mail or fax our technical support team.

18.8 LIMITED WARRANTY

The instrument is warranted to the owner for a period of two years from the date of original purchase against defects in manufacture. This limited warranty is given by AEMC® Instruments, not by the distributor from whom it was purchased. This warranty is void if the unit has been tampered with, abused, or if the defect is related to service not performed by AEMC® Instruments.

Full warranty coverage and product registration is available on our website.

IMPORTANT WARRANTY NOTE:

By registering online within 30 days of the purchase date, your warranty will be extended to **3 years**.

Please print the online Warranty Coverage Information for your records.

What AEMC® Instruments will do:

If a malfunction occurs within the warranty period, you may return the instrument to us for repair, provided we have your warranty registration information on file or a proof of purchase. AEMC® Instruments will repair or replace the faulty material at our discretion.

18.8.1 Warranty Repairs

Caution: To protect yourself against in-transit loss, we recommend that you insure your returned material.



NOTE: You must obtain a CSA# before returning any instrument.

19. APPENDICES

This section has the formulas used to calculate the different parameters and the definitions for abbreviations.

The formulas comply with standard IEC 61000-4-30, edition 3.0, Amendment 1 (2021), for Class A instruments and comply with IEEE 1459, 2010 edition, for the power formulas.

19.1 NOTATION

Notation	Description
Y	Represents V, U, or I
L	Number of the phase or of the channel
n	Instantaneous sample index
h	Subgroup order of the harmonic or of the interharmonic
M	Total number of samples in the duration considered
N	Number of cycles
Y_L(n)	Instantaneous value of the channel L sample having index n
Y_{sghL}(h)	RMS value of order h's sub-group harmonic on channel L, Voltage/Current = square root of the sum of the squares of the RMS values of a harmonic and of the two spectral components directly adjacent to it
Y_{isghL}(h)	RMS value of order h's centred interharmonic subgroup on channel L, Voltage/Current = RMS value of all spectral components between two consecutive harmonic frequencies, not including the spectral components directly adjacent to the harmonic frequencies
I_{hL}(h)	RMS current of the harmonic of order h on channel L

Most measured quantities can be calculated from aggregations of different durations:

- 1 cycle (= 1 period = 1/frequency)
- 10/12 cycles (10 cycles for 50 Hz, 12 cycles for 60 Hz)
- 150/180 cycles (150 cycles for 50 Hz, 180 cycles for 60 Hz)
- 10 min

19.2 AGGREGATIONS IN TREND MODE

Measurements recorded in trend mode come from sources sampled in two distinct ways, which are re-aggregated into a common flow intended for trend recordings. The source flows of measurements are:

- The 40 kS/s flow (fixed sampling at 40 kHz) includes the measurements:
 - Network frequency
 - Power
 - DC valueswith S/s (samples per second)
- The 512 spc flow (adaptive sampling at 512 samples per cycle of the measured voltage, which is used for measurements (including Class A measurements) of:
 - RMS Voltages and Currents
 - Peak Voltages and Currents
 - Flicker
 - Imbalances
 - Distortions
 - Harmonics and Inter-harmonicswith spc (samples per cycle)

From these two flows, measurements are produced every 200 ms for the quantities coming from the 40 kS/s flow and every 10 cycles (50 Hz network) or 12 cycles (60 Hz network) for the quantities coming from the 512 spc flow.

These metrics are recombined, aggregated, and timestamped based on the selected aggregation period:

- 10/12 c / 200 ms
 - 10/12 cycles measurements: aggregation of 10/12 cycles over 10 seconds, 10 minutes, 15 minutes, 2 hours
 - 200 ms measurements: quantities 40 kS/s over 10 seconds, 10 minutes, 15 minutes, 2 hours
- 150/180 c / 3 s
 - 10/12 cycles measurements: aggregation of 15 measurements 10/12 cycles. For trend recordings, following the shift between 3 s intervals and 150/180 cycle intervals, an occasional aggregation may include a 10/12 cycles plus or minus. This only concerns the trend mode, the measurements displayed in real time always include 15 aggregations.
 - 200 ms measurements: aggregation of quantities 40 kS/s over 10 seconds, 10 minutes, 15 minutes, 2 hours

All measurements subject to Class A are aggregated from 10/12 cycle values (square root of the arithmetic mean of the square of the input values), regardless of the aggregation period.

Furthermore, complying with Class A, every 10 minutes round, the intervals of 10/12 cycles and 150/180 cycles are resynchronized, with overlap of the 10/12 cycle interval which ends with the new one (overlap 1) and with overlap of the 150/180 cycle interval which ends with the new one (overlap 2).

Synchronization of Aggregation Intervals for Class A (IEC 61000-4-30)

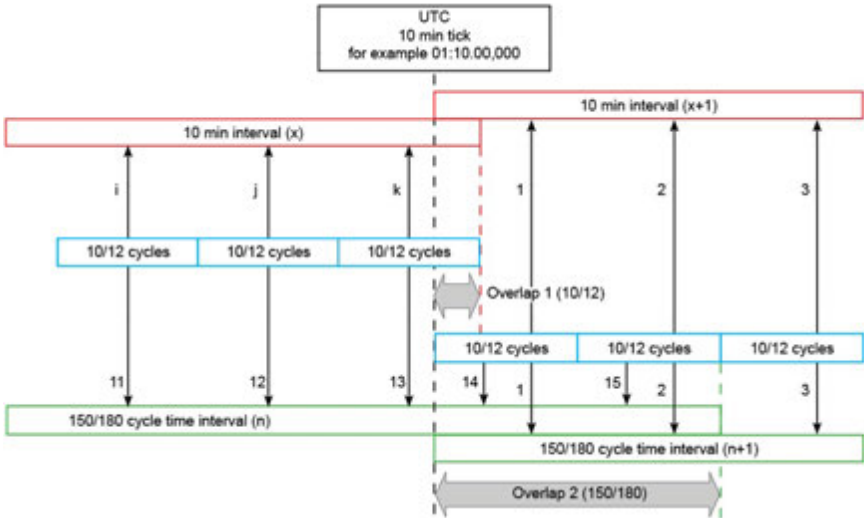

19.3 FORMULAS

19.3.1 RMS Values

The quantities are calculated in accordance with standard IEC 61000-4-30, edition 3.0, Amendment 1 (2021), § 5.2.1.

The RMS value includes the DC component.

$$Y_{RMSL} = \sqrt{\frac{\sum_{n=1}^M Y_L^2(n)}{M}}$$

19.3.2 Peak Values

$$Y_{pk+L} = \max_M(Y_L(n))$$

$$Y_{pk-L} = \min_M(Y_L(n))$$

19.3.3 Crest Factor

$$Y_{CFL} = \frac{Y_{pkL}}{Y_{RMSL}}$$

With $Y_{pkL} = \max(|Y_{pk+L}|, |Y_{pk-L}|)$

19.3.4 Definitions Relating to Harmonics

Rank of a Harmonic, h

Ratio (integer) of a harmonic frequency to the fundamental frequency of the power supply network. In relation to the analysis carried out using a Fourier Transform and a synchronization between $f_{H,1}$ and f_s (sampling frequency), the rank h of a harmonic corresponds to the spectral component: $k = h \times N$.

where k = number of the spectral component

$N = 10$ = number of periods at the fundamental frequency in the time window TN

Effective Value of a Spectral Component of Rank k, $Y_{C,k}$

In analysis of a waveform, the RMS value of a component whose frequency is a multiple (rank k) of the reciprocal of the duration of the time window.

19.3.5 Effective Value Harmonic and Inter-Harmonics Subgroup

The quantities are calculated in accordance with standard IEC 61000-4-7 edition 2.0 Amendment 1, § 5.6.

Effective value of a harmonic subgroup h:

The RMS value of a harmonic subgroup is the root of the sum of the squares of the effective values over $N = 10$ periods of the harmonic considered and the two lopest inter-harmonic lines (the inter-harmonic lines harmonics resulting from the Fourier Transform are spaced by $f/10$).

$$Y_{sgHL}(h) = \sqrt{Y_{(h \times 10) - 1, L, N}^2 + Y_{(h \times 10), L, N}^2 + Y_{(h \times 10) + 1, L, N}^2}$$

Where $Y_{k,L,N}$ = spectral component of rank k on channel L calculated over $N = 10$ periods.

Effective value of an inter-harmonic subgroup centred h:

Effective value of all spectral components between two consecutive harmonic frequencies, not including the spectral components directly adjacent to the harmonic frequencies.

By convention, the RMS value of the centred subgroup located between harmonic ranks h and h + 1 is designated by $Y_{isg,h}$, for example, the centred subgroup located between $h = 5$ and $h = 6$ is denoted by **Yisg,5**.

$$Y_{isgHL}(h) = \sqrt{Y_{(h \times 10) + 2, L, N}^2 + Y_{(h \times 10) + 3, L, N}^2 + Y_{(h \times 10) + 4, L, N}^2 + Y_{(h \times 10) + 5, L, N}^2 + Y_{(h \times 10) + 6, L, N}^2 + Y_{(h \times 10) + 7, L, N}^2 + Y_{(h \times 10) + 8, L, N}^2}$$

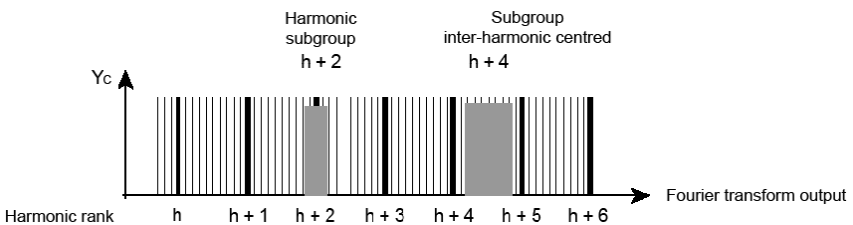

19.3.6 Levels of Harmonics and Interharmonics

The quantities are calculated in accordance with standard IEC 61000-4-7, edition 2.0 A1, Amendment 1 (2021), § 5.6.

Level of harmonics referred to the RMS value of the fundamental (%f):

$$Y_{h\%fL}(h) = \frac{Y_{sghL}(h)}{Y_{sghL}(1)}$$

Level of harmonics referred to the RMS value without DC (%r):

$$Y_{h\%rL}(h) = \frac{Y_{sghL}(h)}{Y_{Lrms}}$$

Level of interharmonics referred to the RMS value of the fundamental (%f):

$$Y_{ih\%fL}(h) = \frac{Y_{isghL}(h)}{Y_{sgL}(1)}$$

Level of interharmonics referred to the RMS value without DC (%r):

$$Y_{ih\%rL}(h) = \frac{Y_{isghL}(h)}{Y_{Lrms}}$$

Where:

h : subgroup order of the harmonic or of the inter-harmonic

L : channel number ($L_1, L_2, L_3, L_N, 1_2, 2_3, 3_1$)

$Y_{sghL}(h)$: RMS value of the sub-group harmonic of rank h of voltage/current

= square root of the sum of the squares of the RMS values of a harmonic and of the two spectral components directly adjacent to it.

$Y_{isghL}(h)$: RMS value of the centered inter-harmonic sub-group of rank h of voltage/current

= RMS value of all spectral components between two consecutive harmonic frequencies, not including the spectral components directly adjacent to the harmonic frequencies.

19.3.7 Level of Unbalances

The quantities are calculated in accordance with standard IEC 61000-4-30, edition 3.0, Amendment 1 (2021), § 5.7.1.

The supply voltage's is evaluated by the method of symmetrical components. In addition to direct component U_1 , an unbalance will add at least one of the following components: inverse component U_2 or zero sequence component U_0 .

Inverse voltage component:

$$u_2 = \frac{U_2}{U_1} \times 100\%$$

Zero sequence voltage component:

$$u_0 = \frac{U_0}{U_1} \times 100\%$$

Inverse current component:

$$a_2 = \frac{I_2}{I_1} \times 100\%$$

Zero sequence current component:

$$a_0 = \frac{I_0}{I_1} \times 100\%$$

With:

U_0	Voltage zero (or homopolar) sequence unbalance	I_0	Current zero (or homopolar) sequence unbalance
U_1	Voltage positive (or direct) sequence unbalance	I_1	Current positive (or direct) sequence unbalance
U_2	Voltage negative (or inverse) sequence unbalance	I_2	Current negative (or inverse) sequence unbalance
u_0	Voltage zero (or homopolar) sequence unbalance ratio	a_0	Current zero (or homopolar) sequence unbalance ratio
u_2	Voltage negative (or inverse) sequence unbalance ratio	a_2	Current negative (or inverse) sequence unbalance ratio

19.3.8 Mains Signaling Voltages (MSV)

The quantities are calculated in accordance with standard IEC 61000-4-30, edition 3.0, Amendment 1 (2021), § 5.10.

The voltage amplitude of the signal for a specified carrier frequency is obtained by calculating the square root of the sum of the squares of the RMS values, for 10/12 periods, of the four closest interharmonic spikes.

19.3.9 Level of Harmonic Group Distortion

The quantities are calculated in accordance with standard IEC 61000-4-7 A1, edition 2.0, Amendment 1 (2021), § 3.3.2.

$$THDG_L \% f = \sqrt{\frac{\sum_{h=2}^{63} Y_{sgHL}(h)^2}{Y_{sgHL}(1)^2}}$$

$$THDG_L \% r = \sqrt{\frac{\sum_{h=2}^{63} Y_{sgHL}(h)^2}{(Y_{sgHL}(1)^2 + \sum_{n=2}^{63} Y_{sgHL}(h)^2)}}$$

19.3.10 Distortion

$$Y_{dL} = \sqrt{\sum_{h=2}^{63} Y_{sgHL}(h)^2}$$

19.3.11 K Factor and Harmonic Loss Factor

These quantities concern only the current and are calculated in accordance with standard IEEE C57.110, 2004 edition, § B.1 and § B.2.

The K-factor (KF) is a nominal value applied to a transformer to indicate its ability to be used with loads that consume non-sinusoidal currents:

$$KF_L = \sum_{h=1}^{h_{max}} \frac{I_{HL}^2(h)}{I_R^2} x h^2$$

With I_R = nominal current of the transformer

Harmonic loss factor (FHL):

$$FHL_L = \frac{\sum_{h=1}^{h_{max}} h^2 \times I_{HL}^2(h)}{\sum_{h=1}^{h_{max}} I_{HL}^2(h)}$$

K factor (FK)

Derating of the transformer as a function of the harmonics:

$$FK_L = \sqrt{1 + \frac{e}{1+e} \left(\frac{\sum_{h=2}^{h_{max}} h^q \times I_{HL}^2(h)}{\sum_{h=1}^{h_{max}} I_{HL}^2(h)} \right)}$$

With: $e \in [0.05 ; 0.1]$ and $q \in [1.5 ; 1.7]$

19.3.12 Power Frequency

This quantity is calculated in accordance with standard IEC 61000-4-30, edition 3.0, Amendment 1 (2021), § 5.1.1.

The zero crossings method is used. The aggregation's duration depends on the instrument's configuration (10 seconds in Class A mode).

19.3.13 DC Component

Mean of the M samples Y_L .

$$Y_{DCL} = \frac{\sum_{n=0}^{M-1} Y_L(n)}{M}$$

19.3.14 Active Power (P)

This quantity is calculated in accordance with standard IEEE 1459, 2010 edition, § 3.1.2.3.

Active power, per phase:

$$P_L = \frac{\sum_{n=0}^{M-1} V_L(n) \cdot I_L(n)}{M}$$

With $V_L(n)$ and $I_L(n)$ = instantaneous values of the V or I sample having index n in channel L.

Total active power:

$$P_{\Sigma} = P_1 + P_2 + P_3$$

19.3.15 Fundamental Active Power (P_f)

This quantity is calculated in accordance with standard IEEE 1459, 2010 edition, § 3.1.2.4.

Active power of fundamental, per phase:

$$P_{fL} = \frac{\sum_{n=0}^{M-1} V_{fL}(n) \cdot I_{fL}(n)}{M}$$

With $V_{fL}(n)$ and $I_{fL}(n)$ = instantaneous fundamental voltage and current of the sample having index n in channel L.

Total active power of fundamental:

$$P_{f\Sigma} = P_{fL1} + P_{fL2} + P_{fL3}$$



NOTE: These quantities, which are used to calculate other quantities, are not displayed.

19.3.16 Fundamental Reactive Power (Q_f)

This quantity is calculated in accordance with standard IEEE 1459, 2010 edition, § 3.1.2.6.

Fundamental reactive power, per phase:

$$Q_{fL} = V_{fL} \times I_{fL} \times \sin(\varphi_{V_{fL}I_{fL}})$$

with $\varphi_{V_{fL}I_{fL}}$ = angle between V_{fL} and I_{fL} , V and I of the fundamental in channel L.

Total fundamental reactive power:

$$Q_f = Q_{fL1} + Q_{fL2} + Q_{fL3}$$

19.3.17 Harmonic Active Power (P_H)

This quantity is calculated in accordance with standard IEEE 1459, 2010 edition, § 3.1.2.5.

The harmonic active power includes the DC component.

Harmonic active power, per phase:

$$P_{HL} = P_L - P_{fL}$$

Total harmonic active power:

$$P_{H\Sigma} = P_{HL1} + P_{HL2} + P_{HL3}$$

19.3.18 DC Power (P_{DC})

DC power, per phase:

$$P_{DCL} = V_{DCL} \times I_{DCL}$$

With V_{DCL} and I_{DCL} : DC voltage and current in channel L.

Total DC power:

$$P_{DC\Sigma} = P_{DCL1} + P_{DCL2} + P_{DCL3}$$

19.3.19 Apparent Power (S)

This quantity is calculated in accordance with standard IEEE 1459, 2010 edition, § 3.1.2.7.

Apparent power, per phase:

$$S_L = V_L \times I_L$$

With V_L and I_L : RMS voltage and current of channel L.

Total apparent power:

$$S_\Sigma = S_{L1} + S_{L2} + S_{L3}$$

19.3.20 Non-Active Power (N)

This quantity is calculated in accordance with standard IEEE 1459, 2010 edition, § 3.1.2.14.

Non-active power, per phase:

$$N_L = \sqrt{S_L^2 - P_L^2}$$

Total non-active power:

$$N_\Sigma = \sqrt{S_\Sigma^2 - P_\Sigma^2}$$

19.3.21 Distorting Power (D)

Distorting power, per phase:

$$D_L = \sqrt{S_L^2 - P_L^2 - Q_{fL}^2} = \sqrt{N_L^2 - Q_{fL}^2}$$

Total distorting power:

$$D_\Sigma = \sqrt{S_\Sigma^2 - P_\Sigma^2 - Q_f^2} = \sqrt{N_\Sigma^2 - Q_f^2}$$

19.3.22 Power Factor (PF), Power Factor of Fundamental (PF1)

These quantities are calculated in accordance with standard IEEE 1459, 2010 edition, § 3.1.2.16 and § 3.1.2.15.

Power factor (PF), per phase:

$$PF_L = \frac{P_L}{S_L}$$

Total power factor (PF):

$$PF_\Sigma = \frac{P_\Sigma}{S_\Sigma}$$

Displacement Factor (DPF) or $\cos \varphi$ or Fundamental power factor (PF1), per phase:

$$DPF_L = PF_{1L} = \cos(\varphi)_L = \frac{P_{fL}}{S_{fL}}$$

Total Displacement Factor (DPF) or $\cos \varphi$ or Fundamental power factor (PF1):

$$DPF_\Sigma = PF_{1\Sigma} = \frac{P_{f\Sigma}}{S_{f\Sigma}}$$

19.3.23 Tangent

Tangent of the difference between the angle of the fundamental voltage and the angle of the fundamental current.

Tangent, per phase:

$$\tan(\varphi)_L = \frac{Q_{fL}}{P_{fL}}$$

Total tangent:

$$\tan(\varphi)_\Sigma = \frac{Q_{f\Sigma}}{P_{f\Sigma}}$$

19.4 FLICKER

The quantities are calculated in accordance with class F3 of standard IEC 61000-4-15, edition 2.0, § 4.7.3, § 4.7.4, and § 4.7.5.

Flicker measures the human perception of the effects of fluctuations in the amplitude of the voltage supplying a lamp.

These variations are caused mainly by reactive power fluctuations in the network caused by the connection and disconnection of devices.

To accurately study the effects on vision, the measurement must be made over a long enough time (10 minutes or 2 hours). Flicker can vary considerably over a short period due to the different connections and disconnections to the network.

Therefore, the Model 8345 measures:

- Instantaneous flicker P_{inst}
- The value displayed is $\max(P_{inst})$ on a 150/180-cycle aggregation. The $\max(P_{inst})$ recorded in Trend mode is calculated on the selected aggregation
- Short-term flicker P_{st}
- This is calculated over 10 minutes. This interval is long enough to minimize the transient effects of connections and disconnections and long enough to account for the deterioration of vision
- Long-term flicker P_{lt}
- This is calculated over 2 hours and accounts for devices with a long cycle. For P_{lt} , the instrument allows you to choose the calculation method (see § 3.9.1) between a fixed or sliding window. Long-term flicker is based on a 2-hour observation period

The perceived discomfort is a function of the square of the amplitude of the fluctuation multiplied by the duration of the fluctuation. The average observer's sensitivity to lighting fluctuations is greatest around 10 Hz.

19.5 SOURCES OF DISTRIBUTION SUPPORTED BY INSTRUMENT

For more information, review the connections in § 3.9.2.

19.6 HYSTERESIS

Hysteresis is a filtering principle used in Alarm mode (see § 12) and Inrush Current mode (see § 11). Carefully adjusting the hysteresis avoids a repeated change of state when the measurement oscillates around the threshold.

19.6.1 Voltage Swell Detection

At a hysteresis of 2 % for example, the reset point for a voltage swell detection will be $(100 \% - 2 \%)$, or 98 % of the threshold voltage.

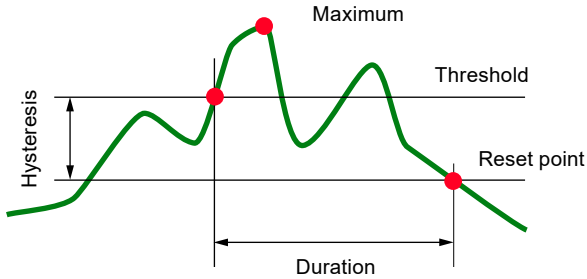

19.6.2 Voltage Dip and Voltage Interruption Detection

For a hysteresis of 2 % for example, the reset point in the context of dip detection will be $(100 \% + 2 \%)$, or 102 % of the threshold voltage.

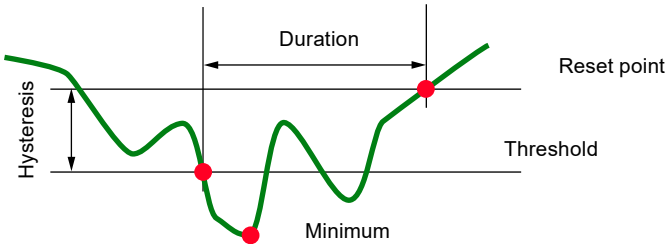

19.7 MINIMUM SCALE WAVEFORMS AND RMS VALUES

	Minimum Scale Values (Waveform mode)	Minimum RMS Values
Phase-to-earth and phase-to-phase voltages	8 V	2 V
AmpFlex® 193 (10 kA) MiniFlex® MA193 (10 kA)	80 A	10 A
AmpFlex® 193 (1 kA) MiniFlex® MA193 (1 kA)	8 A	1 A
AmpFlex® 193 (100 A) MiniFlex® MA193 (100 A)	800 mA	100 mA
SR193 clamp	8 A	1 A
MR193 clamp	8 A	1 A
MN93 clamp	2 A	200 mA
MN193 clamp (100 A)	800 mA	100 mA
E94 clamp (10 mV/A)	800 mA	100 mA

	Minimum Scale Values (Waveform mode)	Minimum RMS Values
E94 clamp (100 mV/A)	80 mA	10 mA
MN193 clamp (5 A)	40 mA	5 mA
5 A and Essailec® adapters	40 mA	5 mA

Value to be multiplied by the ratio in effect (if not unity)

Scale value = (dynamic full scale) / 2 = (Max - Min) / 2

19.8 FOUR-QUADRANT DIAGRAM

This diagram is used for power and energy measurements (see § 7 and § 8).

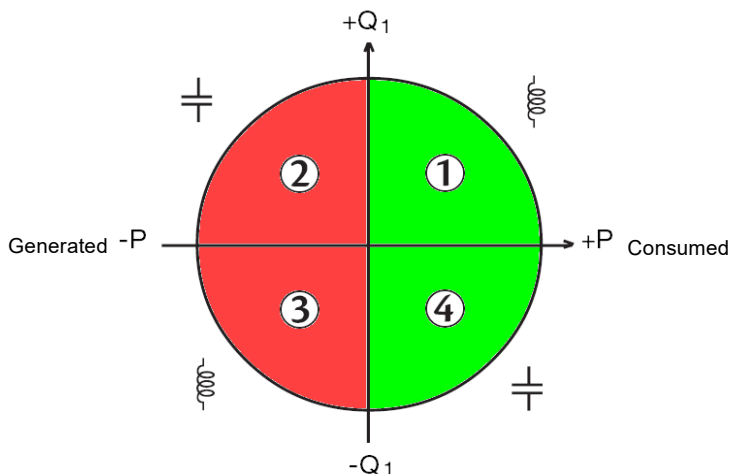

19.9 TRANSIENT CAPTURE TRIGGERING MECHANISM

When a search for transients begins, each sample is compared to the sample from the previous cycle. In standard IEC 61000-4-30, this monitoring method is called the **sliding window method**.

The previous cycle corresponds to the middle of a virtual tube; it is used as the reference. When a sample deviates from the tube, it is considered a triggering event; then, the instrument captures the representation of the transient.

The instrument records ten periods (50 Hz) or twelve periods (60 Hz), with the trigger point being positioned between (1 and 4) periods after the start of recording, depending on the programming of the **Number of cycles before trigger** parameter.

The cycle that precedes the event and the three cycles that follow it are stored in memory. The half-width of the virtual tube, for voltage or current, is equal to the threshold programmed in the Transient mode's configuration (see § 3.10.3).

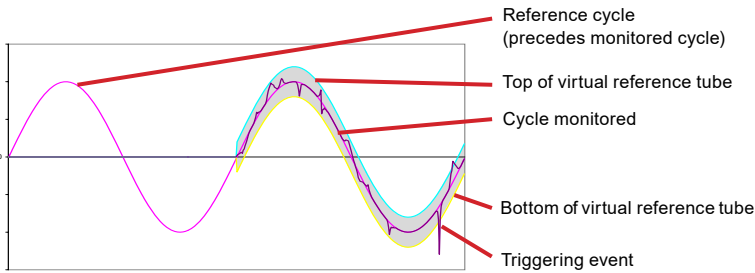

19.10 TRIGGERING MECHANISM SHOCK-WAVE CAPTURES

Unlike all other modes, where the voltages are referenced to neutral, the voltages are referenced here to earth. It is therefore not possible to record fast transients with an unearthed connection.

32 samples form a moving average to smooth the signal (i.e. a duration of $32 \times 500 \text{ ns} = 16 \text{ }\mu\text{s}$). A new sample is compared with the moving average. If the difference exceeds the programmed threshold, the sample is considered a trigger event. The representation of the surge is then captured by the instrument.

The programmed threshold is not an absolute value reached by the signal, but a voltage variation with a steep slope ($< 10 \text{ }\mu\text{s}$).

The four voltage channels (V1E, V2E, V3,E and VNE) are recorded over a period of $1024 \text{ }\mu\text{s}$. The trigger point is always positioned at the first quarter of the recording, (i.e. $256 \text{ }\mu\text{s}$) after the start of the recording.

The other information recorded is as follows:

- The channel on which the trigger occurred
- The trigger date and time
- The peak value reached
- The date and time of this peak value

19.11 CONDITIONS OF CAPTURE INRUSH CURRENT MODE

The capture is determined by a triggering event and a stop event. A capture will stop automatically in any of the following cases:

- The stop event occurs
- The recording memory is full
- The recording duration exceeds 10 minutes in RMS+WAVE mode
- The recording duration exceeds 30 minutes in RMS mode

The capture stop threshold is calculated by the following formula:

$$[\text{Stop threshold [A]}] = [\text{Triggering threshold [A]}] \times (100 - [\text{stop hysteresis [\%]}]) \div 100$$

The triggering and stop conditions of captures are below:

Filter	Triggering and stop conditions
A1	Triggering condition \Leftrightarrow [half-cycle RMS value of A1] > [Triggering threshold] Stop condition \Leftrightarrow [half-cycle RMS value of A1] < [Stop; threshold]
A2	Triggering condition \Leftrightarrow [half-cycle RMS value of A2] > [Triggering threshold] Stop condition \Leftrightarrow [half-cycle RMS value of A2] < [Stop; threshold]
A3	Triggering condition \Leftrightarrow [half-cycle RMS value of A3] > [Triggering threshold] Stop condition \Leftrightarrow [half-cycle RMS value of A3] < [Stop; threshold]
3A	Triggering condition \Leftrightarrow [the half-cycle RMS value in one of the current] channels > [Triggering threshold] Stop condition \Leftrightarrow [the half-cycle RMS value in all of the current channels] < [Stop threshold]

19.12 POSSIBLE CAUSES FOR A STOPPED RECORDING

When displaying a list of recordings (trend, transient, inrush current, alarm or monitoring), if the end date is in red, it means that the recording could not be completed to the scheduled end date. An error code is then displayed next to the red date. To find out what the error number is, use the help button .

For trend, transient, inrush current or monitoring records:

- Code 1: The recording stopped at the programmed end time.
- Code 2: Recording stopped manually.
- Code 3: Memory full.
- Code 4: Other recording error.
- Code 5: Recording stopped due to the instrument being switched off (battery level too low and no power supply).
- Code 6: The maximum number of events (transient, inrush current) has been reached.

In case of alarm records:

- Code 2: Manual stop of the recording.
- Code 4: Other recording error.
- Code 5: Memory full.
- Code 6: Recording stopped at the programmed end time.
- Code 7: Recording stopped due to the instrument being switched off (battery level too low and no power supply).
- Code 8: The maximum number of events has been reached.

19.13 GLOSSARY

\cong	AC and DC components
\sim	AC component only
\equiv	DC component only
⏏	Inductive phase shift
⏏	Capacitive phase shift
$^{\circ}$	Degree
$-.+$	Expert mode
	Absolute values
Φ_{VA}	Phase difference of the phase-to-earth voltage (phase voltage) with respect to the phase-to-earth current (line current)
Φ_{UA}	Phase difference of the phase-to-phase voltage (line voltage) with respect to the phase-to-earth current (line current). Two-phase 2-wire mode only
Σ	System value
%	Percentage
%F	Value of the fundamental as reference (percentage of the fundamental value)
%R	Total value as reference (percentage of the total value)
A	Ampere (unit) or phase-to-earth current (line current)
a₀	Current zero (or homopolar) sequence unbalance ratio
a₂	Current negative (or inverse) sequence unbalance ratio
A1	Current of phase 1
A2	Current of phase 2
A3	Current of phase 3
A·h	Current harmonic
AC	AC component (current or voltage)
A_{cf}	Crest factor of the current
A_d	Distorting RMS current
A_{DC}	DC current
A_{nom}	Nominal current of the current sensors
A_{pk+}	Maximum peak current
A_{pk-}	Minimum peak current
A_{RMS}	RMS current
A_{thd}	Total harmonic distortion of the current
A_{thdf}	Harmonic distortion of the current referred to the RMS value of the fundamental
A_{thdr}	Harmonic distortion of the current referred to the total RMS value without DC
AVG	Average value (arithmetic mean)

Bandwidth	Frequency range within which the response of an instrument is greater than minimum
BTU	British thermal unit
CF	Crest factor for current or voltage: the ratio of peak current to RMS current
Channel and phase	A measurement channel corresponds to a difference of potential between two conductors. A phase corresponds to a single conductor. In polyphase systems, a measurement channel can be between two phases, between a phase and the neutral, between a phase and the earth, or between the neutral and the earth
cos ϕ	Cosine of the phase difference of the voltage with respect to the current (displacement factor – DPF)
D	Distorting power
DC	DC component (current or voltage)
DHCP	Dynamic Host Configuration Protocol
DataViewSync®	Internet Relay Device: proprietary protocol allowing the interconnection, via a centralized server, of two devices located in different subnetworks.
Dip threshold	Voltage specified for detection of a voltage dip's beginning and end
D_{PF}	Displacement factor (cos ϕ)
E	Exa (10 ¹⁸)
E_D	Distorting energy
E_{PDC}	DC energy
E_{Qf}	Reactive energy
E_P	Active energy
E_N	Non-active energy
E_S	Apparent energy
FK	K factor calculated per IEEE C57.110: Downgrading of the transformer as a function of harmonics
FHL	Harmonic loss factor that quantifies losses due to harmonics in transformers
Flicker	Visual effect produced by voltage variations
Frequency	Number of complete voltage or current cycles in one second
Fundamental component	Component of which the frequency is the fundamental frequency
G	Giga (10 ⁹)
GPS	Global positioning system (satellite-based)
Harmonics	Voltages or currents at frequencies that are integral multiples of the fundamental frequency
Hysteresis	Amplitude difference between a threshold's forward and reset points
Hz	Hertz (unit)

Interruption	A voltage reduction in the electrical network to below the interruption threshold
J	Joule (unit)
k	Kilo (10^3)
KF	K factor calculated per IEEE C57.110. A transformer's ability to be used with loads that consume non-sinusoidal currents
L	Line (channel)
m	Milli (10^{-3})
M	Mega (10^6)
MAX	Maximum value calculated over either 10 cycles or 12 cycles depending on whether the frequency is 50 Hz or 60 Hz
MIN	Minimum value calculated over either 10 cycles or 12 cycles depending on whether the frequency is 50 Hz or 60 Hz
ms	Millisecond
MSV	Mains signaling voltage
N	Non-active power
Nominal voltage	Voltage that a network is designated or identified by
NTP	Network Time Protocol, enables time synchronization via a time server
P	Active power
P	Peta (10^{15})
P_{DC}	DC power
PF	Power factor: the ratio of active power to apparent power
PF1	Fundamental power factor
Phase	Time relation between current and voltage in AC circuits concernin
PK	The signal's maximum (+) or minimum (-) peak value over 10/12 cycles
P_{It}	Severity of long-term flicker (long-term severity) calculated over 2 h
P_{st}	Severity of short-term flicker (short-term severity) calculated over 10 min
Q_f	Reactive power
Order of a harmonic	Integer equal to the ratio of the harmonic frequency to the fundamental frequency
RMS	The root mean square (RMS) of current or voltage. Square root of the arithmetic mean of the square of the instantaneous values of a quantity during a specified interval of time (200 ms, 1 s, or 3 s)
RVC	Rapid voltage changes
S	Apparent power
S·h	Harmonics in power
T	Relative date of the time cursor
T	Tera (10^{12})
tan φ	Tangent of the voltage phase difference with respect to the current

Toe	Ton of oil equivalent (nuclear or non-nuclear)
THD	Total harmonic distortion is the percentage of harmonics in a signal, referred to the RMS value of the fundamental (%f) or to the total RMS value without DC (%r)
U	Phase-to-phase voltage or voltage between phases
u_0	Voltage zero (or homopolar) sequence unbalance ratio
u_2	Voltage negative (or inverse) sequence unbalance ratio (neutral connected) or phase-to-phase voltage (neutral disconnected)
$U_1 = U_{12}$	Phase-to-phase voltage between phases 1 and 2
$U_2 = U_{23}$	Phase-to-phase voltage between phases 2 and 3
$U_3 = U_{31}$	Phase-to-phase voltage between phases 3 and 1
U-h	Harmonics in phase-to-phase voltage
U_c	Declared supply voltage (normally $U_c = U_N$)
U_{cf}	Crest factor of the phase-to-phase voltage (line voltage)
U_d	Distorting phase-to-phase RMS voltage
U_{DC}	Phase-to-phase DC voltage
U_{din}	Declared input voltage ($U_{din} = U_c \times \text{transducer ratio}$)
Uh	Harmonic of the phase-to-phase voltage
U_{pk+}	Maximum peak phase-to-phase voltage
U_{pk-}	Minimum peak phase-to-phase voltage
U_N	Nominal network voltage

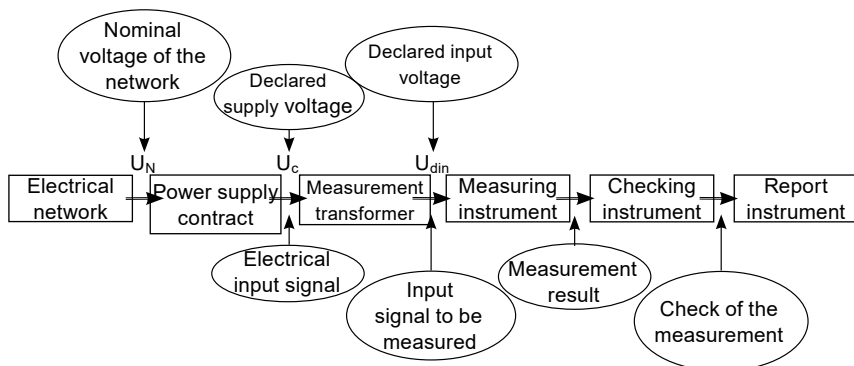

Networks that have a nominal voltage of $100\text{ V} < U_N < 1000\text{ V}$ have standard voltages of:

- Phase-to-earth voltages: (120, 230, 347 and 400) V
- Phase-to-phase voltages: (208, 230, 240, 400, 480, 600, 690 and 1000) V

Some countries have standard voltages of:

- Phase-to-earth voltages: (100, 220, 240 and 380) V
- Phase-to-phase voltages: (200, 220, 380, 415, 600 and 660) V

U_{RMS}	Phase-to-phase RMS voltage
UTC	Coordinated Universal Time
U_{thd}	Total harmonic distortion of the phase-to-phase voltage
U_{thdf}	Harmonic distortion of the phase-to-phase voltage referred to the RMS value of the fundamental
U_{thdr}	Harmonic distortion of the phase-to-phase voltage referred to the total RMS value without DC
V	Volt (unit), phase-to-earth voltage, or phase-to-neutral voltage
V1	Phase-to-earth voltage on phase 1
V2	Phase-to-earth voltage on phase 2
V3	Phase-to-earth voltage on phase 3
V·h	Harmonics in phase-to-earth voltage
V·A	Volt-ampere (unit)
V·A·h	Volt-ampere hour (unit)
var	Reactive volt-ampere (unit)
var·h	Reactive volt-ampere hour (unit)
V_{cf}	Crest factor of the phase-to-earth voltage
V_d	Distorting phase-to-earth RMS voltage
V_{DC}	Phase-to-earth DC voltage
V_{pk+}	Maximum peak value of the phase-to-earth voltage
V_{pk-}	Minimum peak value of the phase-to-earth voltage
Vh	Harmonic of the phase-to-earth voltage
V_N	Phase-to-earth voltage on the neutral
Voltage balance in polyphase electrical network	State in which the RMS values of the voltages between conductors (fundamental component) or the phase differences between successive conductors are not all equal
Voltage dip	Temporary lowering of the amplitude of the voltage at a point in the electrical network to below some specified threshold
Voltage swell	Temporary increase of the voltage magnitude at a point in the electrical system above a threshold
V_{RMS}	Phase-to-earth RMS voltage
V_{thd}	Total harmonic distortion of the phase-to-earth voltage
V_{thdf}	Harmonic distortion of the phase-to-earth voltage referred to the RMS value of the fundamental
V_{thdr}	Harmonic distortion of the phase-to-earth voltage referred to the total RMS value without DC
W	Watt (unit)
W·h	Watt-hour (unit)

19.14 UNIT PREFIXES

SI Unit Prefixes		
Prefix	Symbol:	Multiplies by
Milli-	m	10^{-3}
Kilo-	k	10^3
Mega-	M	10^6
Giga-	G	10^9
Tera-	T	10^{12}
Peta-	P	10^{15}
Exa-	E	10^{18}

NOTES:

NOTES:

NOTES:



05/24
99-MAN 100563 v07

AEMC[®] Instruments

