

■ 3-PHASE POWER QUALITY ANALYZER

8436

PowerPad®



ENGLISH

User Manual



Statement of Compliance

Chauvin Arnoux[®], Inc. d.b.a. AEMC[®] Instruments certifies that this instrument has been calibrated using standards and instruments traceable to international standards.

We guarantee that at the time of shipping your instrument has met its published specifications.

An N.I.S.T. traceable certificate may be requested at the time of purchase, or obtained by returning the instrument to our repair and calibration facility, for a nominal charge.

The recommended calibration interval for this instrument is 12 months and begins on the date of receipt by the customer. For recalibration, please use our calibration services.

Serial #: _____

Catalog #: ~~2136.43/2136.44~~ _____

Model #: ~~8436~~ _____

Please fill in the appropriate date as indicated:











Date Received: _____

Date Calibration Due: _____



Chauvin Arnoux[®], Inc.
d.b.a AEMC[®] Instruments

Thank you for purchasing a **PowerPad® III Model 8436**. For best results from your instrument and for your safety, read the enclosed operating instructions carefully and comply with the precautions for use. These products must be only used by qualified and trained users.

	WARNING, risk of DANGER! The operator must refer to these instructions whenever this danger symbol appears.
	CAUTION! Risk of electric shock. The voltage at the parts marked with this symbol may be dangerous.
	Equipment is protected by double insulation.
	USB socket.
	SD Card.
	Ground/Earth.
	Important instructions to read and to fully understand.
	Useful information or hint to read.
	The CE marking guarantees conformity with European directives and with regulations covering EMC.
	The trash can with a line through it means that in the European Union, the product must undergo selective disposal for the recycling of electric and electronic material, in compliance with Directive WEEE 2002/96/EC.

Definition of Measurement Categories (CAT)

- **CAT IV** corresponds to measurements taken at the source of low-voltage installations.
Example: power feeders, counters and protection devices.
- **CAT III** corresponds to measurements on building installations.
Example: distribution panel, circuit-breakers, machines or fixed industrial devices.
- **CAT II** corresponds to measurements taken on circuits directly connected to low-voltage installations.
Example: power supply to domestic electrical appliances and portable tools.

PRECAUTIONS FOR USE

This device is compliant with safety standard IEC 61010-2-030, the leads are compliant with IEC 61010-031, and the current sensors are compliant with IEC 61010-2-032, for voltages up to 600 V in category IV or 1000 V in category III. Failure to observe the safety instructions may result in electric shock, fire, explosion, and destruction of the instrument and of the installations.

- The operator and/or the responsible authority must carefully read and clearly understand the various precautions to be taken in use. Sound knowledge and a keen awareness of electrical hazards are essential when using this instrument.
- If you use this instrument other than as specified, the protection it provides may be compromised, thereby endangering you.
- Do not use the instrument on networks of which the voltage or category exceeds those mentioned.
- Do not use the instrument if it appears to be damaged, incomplete, or poorly closed.
- Before each use, check the condition of the insulation on the leads, housing, and accessories. Any item of which the insulation is deteriorated (even partially) must be set aside for repair or scrapping.
- Use only the leads and accessories supplied. Using leads (or accessories) of a lower voltage or category reduces the voltage or category of the combined instrument + leads (or accessories) to that of the leads (or accessories).
- Use personal protection equipment systematically.
- Keep your hands away from the terminals of the instrument.
- When handling the leads, test probes, and alligator clips, keep your fingers behind the physical guard.
- Use only the external power adaptor and battery pack supplied by the manufacturer. They include specific safety features.
- Some current sensors must not be placed on or removed from bare conductors at hazardous voltages: refer to the sensor manual and comply with the handling instructions.

CONTENTS

1. INTRODUCTION	7
1.1. DELIVERY CONDITION	7
1.2. ORDERING INFORMATION	7
1.3. ACCESSORIES	7
1.4. REPLACEMENT PARTS	7
1.5. BATTERY CHARGING	8
1.6. LANGUAGE SELECTION	9
2. DESCRIPTION	10
2.1. FUNCTIONS	10
2.1.1. MEASUREMENTS	10
2.1.2. DISPLAY FUNCTIONS	11
2.1.3. CONFIGURATION	11
2.2. INSTRUMENT INTERFACE	12
2.3. ON/OFF BUTTON	13
2.4. DISPLAY	13
2.4.1. PRESENTATION	13
2.4.2. FUNCTION BUTTONS	14
2.5. KEYPAD BUTTONS	15
2.5.1. FUNCTION (YELLOW) BUTTONS	15
2.5.2. NAVIGATION BUTTONS	15
2.5.3. MODE BUTTONS	15
2.5.4. OTHER BUTTONS	16
2.6. CONNECTORS	16
2.6.1. CONNECTION TERMINALS	16
2.6.2. SIDE CONNECTORS	17
2.7. POWER SUPPLY	17
2.8. ABBREVIATIONS	17
3. OPERATION	19
3.1. START-UP	19
3.2. CONFIGURATION	19
3.3. LEADS INSTALLATION	20
3.3.1. SINGLE-PHASE NETWORK	21
3.3.2. SPLIT-PHASE NETWORK	21
3.3.3. THREE-PHASE NETWORK	21
3.3.4. CONNECTION	22
3.4. INSTRUMENT FUNCTIONS	22
3.4.1. WAVEFORM CAPTURE	22
3.4.2. HARMONICS DISPLAY	22
3.4.3. WAVEFORM MEASUREMENTS	22
3.4.4. ALARM RECORDING	22
3.4.5. RECORDING	22
3.4.6. ENERGY MEASUREMENTS	22
4. CONFIGURATION	23
4.1. CONFIGURATION MENU	23
4.2. DISPLAY LANGUAGE	23
4.3. DATE/TIME	23
4.4. DISPLAY	24
4.4.1. BRIGHTNESS	24
4.4.2. COLORS	24
4.4.3. DISPLAY SHUTDOWN	24
4.4.4. NIGHT MODE	25
4.5. CALCULATION METHODS	25
4.5.1. NON-ACTIVE QUANTITIES CALCULATION	25
4.5.2. UNITS OF ENERGY	26
4.5.3. K FACTOR	26
4.5.4. PHASE HARMONICS	27
4.5.5. LONG-TERM FLICKER (PLT)	27
4.6. CONNECTION	28
4.7. SENSORS AND RATIOS	32
4.7.1. CURRENT SENSORS AND RATIOS	32
4.7.2. VOLTAGE RATIOS	32
4.8. CAPTURE MODE	33
4.8.1. TRANSIENT VOLTAGE THRESHOLDS	33
4.8.2. TRANSIENT CURRENT THRESHOLDS	34
4.8.3. INRUSH CURRENT THRESHOLDS	35
4.9. TREND MODE	35
4.10. ALARM MODE	37
4.11. ERASE MEMORY	38
4.12. ABOUT	39

5. WAVEFORM CAPTURE	40
5.1. TRANSIENT MODE	40
5.1.1. CONFIGURING AND STARTING A SEARCH	41
5.1.2. DISPLAYING A TRANSIENT	41
5.1.3. DELETING A SEARCH FOR TRANSIENTS	42
5.1.4. DELETE A TRANSIENT	42
5.2. INRUSH CURRENT MODE	43
5.2.1. CONFIGURING THE CAPTURE	43
5.2.2. CAPTURE PARAMETERS	44
5.2.3. TRUE RMS CURRENT AND VOLTAGE	44
5.2.4. INSTANTANEOUS INRUSH CURRENT	46
6. HARMONICS	48
6.1. PHASE-TO-NEUTRAL VOLTAGE	48
6.1.1. 3L PHASE-TO-NEUTRAL VOLTAGE HARMONICS DISPLAY SCREEN	48
6.1.2. L1 PHASE VOLTAGE HARMONICS DISPLAY SCREEN	49
6.2. CURRENT	49
6.2.1. 3L CURRENT HARMONICS DISPLAY SCREEN	49
6.2.2. L1 CURRENT HARMONICS DISPLAY SCREEN	50
6.3. APPARENT POWER	50
6.3.1. 3L APPARENT POWER HARMONICS DISPLAY SCREEN	50
6.3.2. L1 APPARENT POWER HARMONICS DISPLAY SCREEN	51
6.4. PHASE-TO-PHASE VOLTAGE	51
6.4.1. 3L PHASE-TO-PHASE VOLTAGE HARMONICS DISPLAY SCREEN	51
6.4.2. L1 PHASE-TO-PHASE VOLTAGE HARMONICS DISPLAY SCREEN	52
6.5. EXPERT MODE	52
6.5.1. PHASE-TO-NEUTRAL VOLTAGE EXPERT MODE DISPLAY SCREEN	52
6.5.2. CURRENT EXPERT MODE DISPLAY SCREEN	53
7. WAVEFORM	54
7.1. TRUE RMS	54
7.1.1. 3U RMS DISPLAY SCREEN	55
7.1.2. 4V RMS DISPLAY SCREEN	55
7.1.3. 4A RMS DISPLAY SCREEN	55
7.1.4. RMS DISPLAY SCREEN FOR THE NEUTRAL	56
7.2. TOTAL HARMONIC DISTORTION	56
7.2.1. 3U THD DISPLAY SCREEN	56
7.2.2. 4V THD DISPLAY SCREEN	56
7.2.3. 4A THD DISPLAY SCREEN	57
7.3. PEAK FACTOR	57
7.3.1. 3U CF DISPLAY SCREEN	57
7.3.2. 4V CF DISPLAY SCREEN	57
7.3.3. 4A CF DISPLAY SCREEN	58
7.4. MAX - MIN AND MEAN VOLTAGE AND CURRENT	58
7.4.1. 3U MAX-MIN DISPLAY SCREEN	58
7.4.2. 4V MAX.-MIN. DISPLAY SCREEN	59
7.4.3. 4A MAX.-MIN. DISPLAY SCREEN	59
7.4.4. L1 MAX.-MIN. DISPLAY SCREEN	59
7.4.5. NEUTRAL MAX.-MIN. DISPLAY SCREEN	60
7.5. SIMULTANEOUS DISPLAY	60
7.5.1. 3U SIMULTANEOUS DISPLAY SCREEN	60
7.5.2. 4V SIMULTANEOUS DISPLAY SCREEN	60
7.5.3. 4A SIMULTANEOUS DISPLAY SCREEN	61
7.5.4. L1 SIMULTANEOUS DISPLAY SCREEN	61
7.5.5. SCREEN FOR SIMULTANEOUS DISPLAY OF NEUTRAL	61
7.6. PHASOR DIAGRAM	62
7.6.1. 3V PHASOR	62
7.6.2. 3U PHASOR DIAGRAM DISPLAY SCREEN	62
7.6.3. 3A PHASOR DIAGRAM DISPLAY SCREEN	62
7.6.4. L1 PHASOR DIAGRAM DISPLAY SCREEN	63
8. ALARM MODE	64
8.1. ALARM MODE CONFIGURATION	64
8.2. ALARM CAMPAIGN CONFIGURATION	64
8.3. CAMPAIGNS LIST	65
8.4. ALARMS LIST	65
8.5. DELETING AN ALARM CAMPAIGN	65
8.6. ERASING ALL ALARM CAMPAIGNS	65
9. TREND MODE	66
9.1. CONFIGURING AND STARTING A RECORDING	66
9.2. TREND MODE CONFIGURATION	66
9.3. VIEWING THE RECORDING LIST	67
9.4. DELETING RECORDINGS	67
9.5. VIEWING RECORDS	67
9.5.1. RECORDING PARAMETERS	67
9.5.2. TREND GRAPHS	68

10. POWER AND ENERGY MODE	74
10.1. 3L FILTER	74
10.1.1. POWERS DISPLAY SCREEN	74
10.1.2. QUANTITIES ASSOCIATED WITH THE POWERS DISPLAY SCREEN	74
10.1.3. ENERGIES CONSUMED DISPLAY SCREEN	75
10.1.4. ENERGIES GENERATED DISPLAY SCREEN	75
10.2. FILTERS L1, L2 AND L3	75
10.2.1. POWERS AND ASSOCIATED QUANTITIES DISPLAY SCREEN	75
10.2.2. ENERGY METERS DISPLAY SCREEN	76
10.3. FILTER Σ	76
10.3.1. TOTAL POWERS AND ASSOCIATED QUANTITIES DISPLAY SCREEN	76
10.3.2. TOTAL ENERGY METERS DISPLAY SCREEN	77
10.4. START ENERGY METERING	77
10.5. STOP ENERGY METERING	78
10.6. RESET ENERGY METERING	78
11. SCREEN SNAPSHOT MODE	79
11.1. SCREEN SNAPSHOTS	79
11.2. HANDLING SCREEN SNAPSHOTS	79
11.2.1. VIEWING A SNAPSHOT	79
11.2.2. DELETING A SNAPSHOT	79
12. HELP BUTTON	80
13. DATAVIEW[®] SOFTWARE	81
13.1. INSTALLING DATAVIEW [®]	81
13.2. POWERPAD III CONTROL PANEL	82
13.3. CONNECTING TO A COMPUTER	82
14. GENERAL SPECIFICATIONS	83
14.1. ENVIRONMENTAL CONDITIONS	83
14.2. MECHANICAL CONDITIONS	83
14.3. OVERVOLTAGE CATEGORIES PER IEC 61010-1	83
14.4. ELECTROMAGNETIC COMPATIBILITY	84
14.5. POWER SUPPLY	84
14.5.1. EXTERNAL POWER SUPPLY	84
14.5.2. BATTERY POWER SUPPLY	84
14.5.3. CONSUMPTION	84
14.5.4. BATTERY LIFE	84
14.5.5. DISPLAY UNIT	84
15. FUNCTIONAL SPECIFICATIONS	85
15.1. REFERENCE CONDITIONS	85
15.2. NOMINAL CURRENT ACCORDING TO TYPE OF SENSOR	85
15.3. ELECTRICAL CHARACTERISTICS	86
15.3.1. VOLTAGE INPUT CHARACTERISTICS	86
15.3.2. CURRENT INPUT CHARACTERISTICS	86
15.3.3. BANDWIDTH	86
15.3.4. INSTRUMENT SPECIFICATIONS (EXCLUDING CURRENT SENSOR)	86
15.3.5. CURRENT SENSOR SPECIFICATIONS (AFTER LINEARIZATION)	95
15.4. CLASS B UNDER STANDARD IEC 61000-4-30	96
15.4.1. INSTRUMENT CONFORMITY	96
15.4.2. UNCERTAINTIES AND MEASUREMENT RANGES	96
15.4.3. REAL-TIME CLOCK UNCERTAINTY	96
16. MAINTENANCE	97
16.1. CLEANING THE CASING	97
16.2. SENSORS	97
16.3. BATTERY REPLACEMENT	97
16.4. MEMORY CARD	99
16.5. FIRMWARE UPDATE	100
17. POLE MOUNTING	101
REPAIR AND CALIBRATION	103
TECHNICAL AND SALES ASSISTANCE	103
LIMITED WARRANTY	103

1. INTRODUCTION

1.1. DELIVERY CONDITION



NOTE: After receiving your PowerPad® III Model 8436, charge and discharge the instrument one or two cycles to ensure the battery indicator is accurate.

Ensure the contents shipped are consistent with the packing list. Notify your distributor of any missing items. If the equipment appears damaged, file a claim immediately with the carrier and notify your distributor at once. Save the damaged packing container to substantiate your claim. Do not use equipment which is damaged or appears to be damaged.

1.2. ORDERING INFORMATION

PowerPad® III Model 8436 (No Sensors - Waterproof IP67)..... **Cat. #2136.43**
Includes extra-large tool bag, accessory pouch, 5 ft (1.5m) USB cable, five 10 ft black voltage leads with alligator clips, 110V US power cord, line power cord 110-1000V DC to 440Hz, SD-card, NiMH battery, twelve color-coded input ID markers, quick start guide, high-voltage warning/caution card, and a USB drive containing DataView® software and user manual

PowerPad® III Model 8436 (AmpFlex® - Waterproof IP67)..... **Cat. #2136.44**
Includes all items listed in Cat. #2136.43 above, as well as four water-tight IP67 AmpFlex® 196A-24-BK with documentation.

1.3. ACCESSORIES (not IP67)

10 ft USB cable.....	Cat. #2136.80
Pole Mounting Kit.....	Cat. #2137.82
AC/DC Current Probe Model SL261* (10A-100mV/A, 100A-10mV/A, BNC)	Cat. #1201.51
*Adapter - BNC Adapter (mandatory if using an SL261 w/ the 8436).....	Cat. #2140.40
AC Current Probe Model MR193-BK.....	Cat. #2140.28
AC Current Probe Model MN93-BK.....	Cat. #2140.32
AC Current Probe Model SR193-BK	Cat. #2140.33
AC Current Probe Model MN193-BK	Cat. #2140.36
MiniFlex® Sensor 10" Model MA193-10-BK	Cat. #2140.48
AC/DC Current Probe Model J93-BK.....	Cat. #2140.49
MiniFlex® Sensor 14" Model MA193-14-BK.....	Cat. #2140.50

1.4. REPLACEMENT PARTS

Extra Large Classic Tool Bag	Cat. #2133.73
Battery 9.6V NiMH.....	Cat. #2140.19
Set of 12, Color-coded Input ID Markers	Cat. #2140.45
5 ft USB cable.....	Cat. #2140.46
Lead – One 10 ft (3M) Black Lead (Waterproof cap) {Rated 1000V CAT IV} & One Black Alligator Clip {Rated 1000V CAT IV, 15A}	Cat. #2140.73
AmpFlex® Sensor 24" Model 196A-24-BK.....	Cat. #2140.75
Power Cord 110V (IP67).....	Cat. #5000.63
Line power cord 110-1000V DC to 440Hz.....	Cat. #5000.89

1.5. BATTERY CHARGING

Before first use, fully charge the battery.

120 V ± 10 %, 60 Hz
230 V ± 10 %, 50 Hz

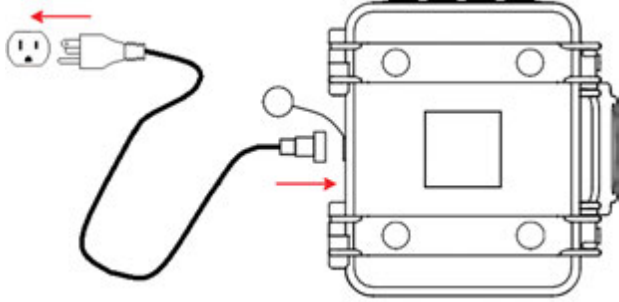

1. Remove the connector cover on the instrument (see Figure 1-1).
2. Connect the AC power cord and screw it in place.
3. Plug the power cord into a power outlet.

The  button lights; it will go out only when the plug is disconnected.

When the battery is fully discharged, charging takes approximately 5 hours.

Figure 1-1

It is also possible to charge the battery using the voltage on the voltage measurement terminals. To do this: with the connector cover removed, connect the power supply cord to the battery charging connector and the two safety-series banana plugs with rear-mounted sockets to any two of the phases (L1, L2, L3).

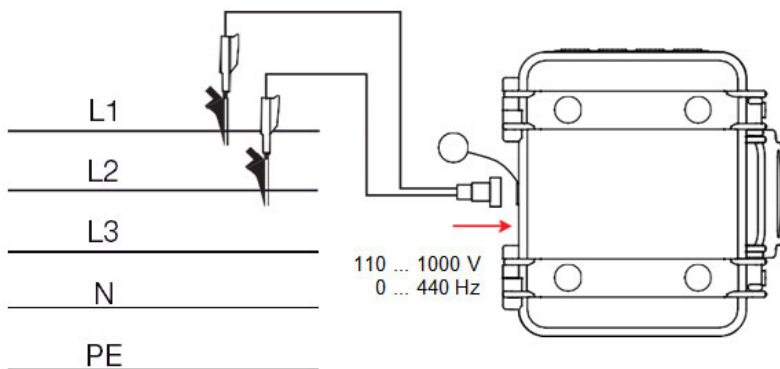

Figure 1-2

To make measurements while charging the battery, connect the measurement leads to the terminals and to the safety-series banana plugs with rear-mounted sockets.

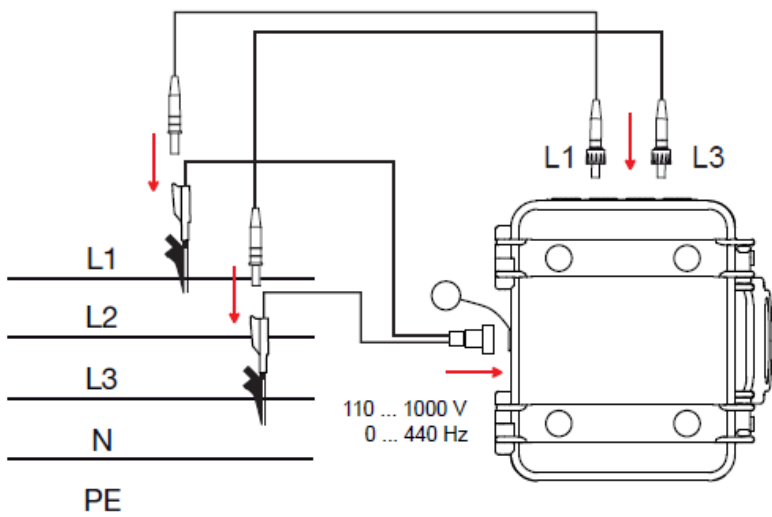

Figure 1-3

1.6. LANGUAGE SELECTION

Before using the instrument, choose the language in which you want the instrument to display its messages.

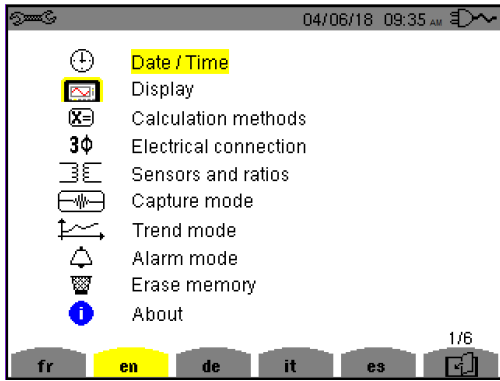





Figure 1-4

1. Press the  button to turn the instrument ON.
2. Press the Configuration  button. This displays the Configuration menu (Figure 1-4).
3. At the bottom of the screen are the language options. Press the function button that corresponds with the desired language. (The selected language appears in yellow.) If the desired language is not displayed, press the  button to view additional options.

2. DESCRIPTION

2.1. FUNCTIONS

The Model 8436 is a three-phase network analyzer with color graphic display and built-in rechargeable battery. The instrument:

- measures RMS values, powers, and perturbations of electric distribution networks
- delivers a snapshot of the principal characteristics of a three-phase network
- tracks variations of various parameters over time
- provides IP67 (watertight) operation

The measurement uncertainty of the Model 8436 is better than 1% (excluding uncertainties due to connected sensors). The instrument is also versatile, with a choice of sensors providing measurements ranging from a few mA (MN193) to several kA (AmpFlex®).

The instrument is compact and impact resistant, with a simple and easy-to-use interface. It is designed for technicians and engineers performing electrical network installation, inspection and maintenance.

2.1.1. MEASUREMENTS

The Model 8436 measures:

- RMS values of AC voltages up to 1000V between terminals. By using the ratios, the instrument can measure voltages up to hundreds of gigavolts.
- RMS values of AC currents up to 10,000A (neutral included). By using the ratios, the instrument can measure currents up to hundreds of kiloamperes.
- DC components of voltages and currents (neutral included).
- Minimum and maximum half-cycle RMS voltage and current values (excluding neutral).
- Peak voltage and current values (neutral included).
- Frequency of 50Hz and 60Hz networks.
- Current and voltage peak factors (neutral included).
- Harmonic loss factor (FHL), application to transformers in the presence of harmonic currents.
- K factor (FK), application to transformers in the presence of harmonic currents.
- Total harmonic distortion with respect to the fundamental (THD in %f) of the current and of the voltages (excluding neutral).
- Total harmonic distortion with respect to the RMS AC value (THD in %r) for the current and the voltages (neutral included).
- Active, reactive (capacitive and inductive), non-active, distortion, and apparent power, by phase and cumulative (excluding neutral).
- Power factor (PF) and displacement factor (DPF) or $\cos \Phi$ (excluding neutral).
- RMS distortion value (d) for the current and the voltages (excluding neutral).
- Short-term voltage flicker (PST) (excluding neutral).
- Long-term voltage flicker (PLT) (excluding neutral).
- Active, reactive (capacitive and inductive), non-active, distortion, and apparent energy (excluding neutral).
- Current and voltage harmonics (excluding neutral) up to order 50: RMS value, percentage referred to the fundamental, (%f) (excluding neutral), or the total RMS value (%r), minimum and maximum and sequence harmonics.
- Apparent harmonic power up to order 50 (excluding neutral): percentages referred to the fundamental apparent power (%f) or the total apparent power (%r), minimum and maximum of a rank.
- Inrush currents, starting of motors.

2.1.2. DISPLAY FUNCTIONS

- Waveforms (voltages and currents).
- Frequency bar chart (voltages and currents).
- Inrush Current function: displays parameters useful for study of the starting of a motor.
 - Instantaneous current and voltage at the instant designated by the cursor.
 - Maximum instantaneous absolute value of the current and of the voltage (over the entire starting time).
 - RMS value of the half-cycle (or lobe) of the current and voltage (excluding neutral) on which the cursor is positioned.
 - Maximum half-cycle RMS current (over the entire starting time).
 - Instantaneous network frequency at the instant designated by the cursor.
 - Maximum, mean, and minimum network frequencies (over the entire starting time).
 - Time at which starting of motor commenced.
- Screen captures (up to 50).
- Transients function. Detection and recording of transients (up to 210) between user-defined start and stop dates and times. Recording of four complete cycles (one before the triggering event and three after) in the eight acquisition channels.
- Trend recording (data logging) function. 2GB memory with date-stamping and user-defined start and stop dates for recording, with a maximum of 100 recordings. Display, in bar chart or graph form, of the means of many parameters vs. time, with or without maximum and minimum values.
- Alarm function. List of recorded alarms (up to 16,362) exceeding thresholds defined in the configuration menu. User-defined alarm monitoring start and stop times.

2.1.3. CONFIGURATION

- Date and time.
- Screen brightness.
- Graph colors.
- Management of switching off of the screen.
- Night mode.
- Calculation methods (non-active quantities broken down or not, choice of the unit of energy, choice of the coefficients of calculation of the K factor), choice of reference for the level of harmonics, PLT calculation (sliding or not).
- Distribution system (single-phase, two-phase, three-phase with or without neutral) and of the connection method (standard, 2-element method or 2½-element method).
- Recording, alarms, inrush currents, and transients.
- Data erasure (total or partial).
- Software and hardware version numbers display.
- Language setting.
- Display of current sensors detected not detected, not managed, simulated or impossible to simulate (2-element connection method). Setting of voltage and current ratio, of the transduction ratios and of the sensitivity.

2.2. INSTRUMENT INTERFACE

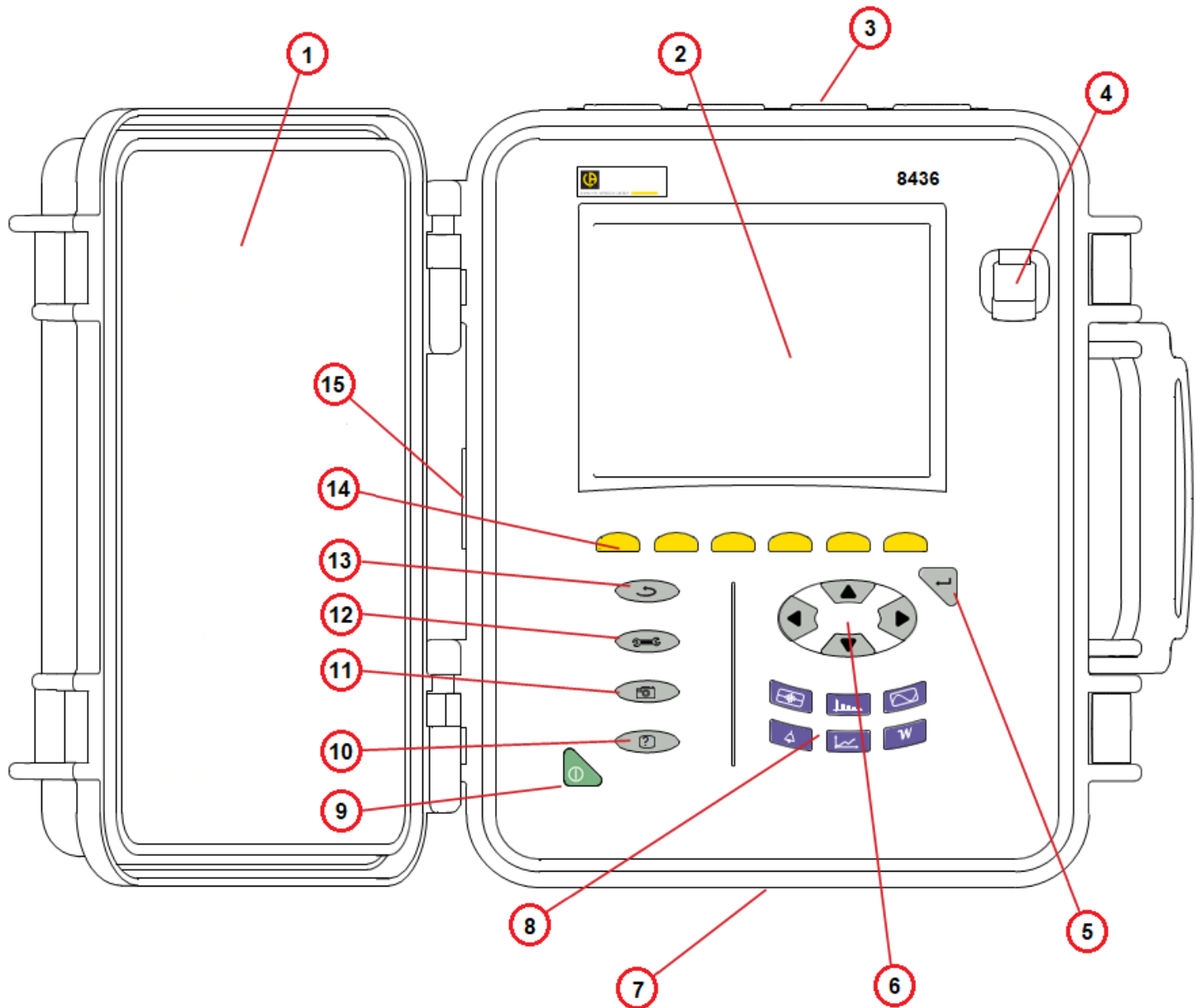



Figure 2-1

- | | | | |
|---|--|----|----------------------------|
| 1 | Cover | 9 | ON/OFF button |
| 2 | LCD display | 10 | Help button |
| 3 | Measurement connection terminals | 11 | Screen snapshot button |
| 4 | USB socket | 12 | Configuration button |
| 5 | Confirm/Enter button | 13 | Return /previous button |
| 6 | Navigation buttons | 14 | Function (yellow) buttons |
| 7 | Battery compartment and memory card slot cover | 15 | Battery charging connector |
| 8 | Mode buttons | | |

2.3. ON/OFF BUTTON

The instrument can operate either on its battery or on external power. Pressing the  button powers ON the instrument. If the instrument is shut off suddenly (line power outage in the absence of the battery) or automatically (battery low), an information message is displayed the next time it is started.

Pressing  again turns the instrument OFF. If the instrument is recording, metering energy, or searching for transients, alarms, and/or inrush current acquisition, it requests confirmation. Select **Yes** or **No** on the corresponding yellow button, then press the \leftarrow button to validate.

- **No**: recording will continue.
- **Yes**: data recorded up to that point is finalized and the instrument is turned OFF.

2.4. DISPLAY

2.4.1. PRESENTATION

The backlit 320x240 (1/4 VGA) pixel graphic screen displays all measurements with their graphs, the parameters of the unit, the graphs selected, the instantaneous values of the signals, and the type of measurement selected. When the instrument is powered ON, it initially displays the Waveform screen (see §7).

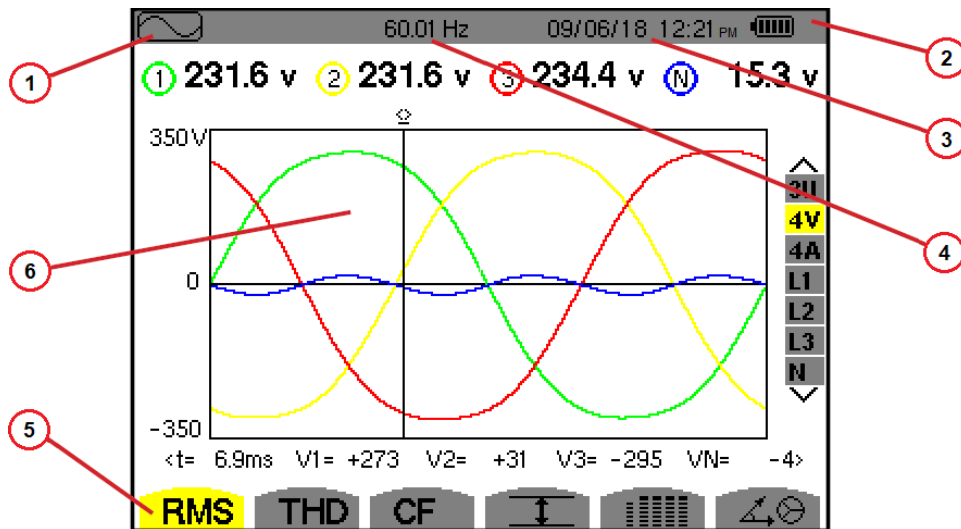

Figure 2-2

- 1 Mode icon
- 2 Battery charge level
- 3 Date/time
- 4 Frequency calculated over 1 second
- 5 Function icons
- 6 Active mode screen

Automatic display shutdown is configured via the Display Configuration Mode menu (see §4.4.3).

2.4.2. FUNCTION BUTTONS

The display uses the following icons for the yellow function buttons:

Icon	Function
V	Phase-to-neutral voltage mode.
A	Phase-to-neutral current mode.
S	Power mode.
U	Phase-to-phase voltage mode.
var	Non-active quantities.
Wh	Units of energy.
FK	K factor coefficients.
%f-%r	Reference for the level of harmonics.
PLT	Long-term flicker calculation mode.
CF	Peak factors and graphs.
RMS	RMS values and graphs.
PEAK	PEAK values and graphs.
THD	Harmonic distortion and graphs.
PF...	PF, cos Φ (DPF), tan Φ , and Φ .
W...	Powers and associated quantities (PF, cos Φ , DPF, tan Φ and Φ_{VA}).
Wh...	Energy meters.
[Σ]	Energy calculation activation/de-activation.
	Zoom in.
	Zoom out.
	Display contrast.
	Measurement channel colors.
	Screen ON/OFF.
	Night mode.
	Recording configuration mode.
	Recording look-up mode.
	Start recording.
	Rapid configuration and start of recording.
	Stop recording.
	Stop function in progress.
	Delete.
	Configuration mode

Icon	Function
	Transient list display filter activate/deactivate.
	Maximum/minimum display.
	Move the cursor to the first occurrence of the maximum phase-to-neutral voltage.
	Move the cursor to the first occurrence of the minimum phase-to-neutral voltage.
	Move the cursor to the first occurrence of the maximum phase-to-phase voltage.
	Move the cursor to the first occurrence of the minimum phase-to-phase voltage.
	Move the cursor to the first occurrence of the maximum current.
	Move the cursor to the first occurrence of the minimum current.
	Move the cursor to the first occurrence of the maximum instantaneous frequency.
	Move the cursor to the first occurrence of the minimum instantaneous frequency.
	Move the cursor to the first occurrence of the maximum of the measurement displayed.
	Move the cursor to the first occurrence of the minimum of the measurement displayed.
	Simultaneous display of all voltage and current measurements (RMS, DC, THD, CF, PST, PLT, FHL, FK).
	Select all items.
	Deselect all items.
	Transient mode.
	Inrush current mode.
	Phasor diagram.
	Move cursor to transient triggering time.
	Move the cursor to one signal period before the triggering date of the transient.
	Energies consumed by the load.
	Energies generated by the load.
	Page 1 of Help.
	Page 2 of Help.
	Page 3 of Help.
	Page 4 of Help.
	Previous configuration.
	Next configuration.
	Previous page.
	Next page.







2.5. KEYPAD BUTTONS

2.5.1. FUNCTION (YELLOW) BUTTONS

These six buttons activate the function or tool represented by the corresponding icon on the screen.







2.5.2. NAVIGATION BUTTONS

A block of four arrow buttons, a select button and a Return button are used for navigating menus.

Button	Function
	Up arrow.
	Down arrow.
	Right arrow.
	Left arrow.
	Confirm selection.
	Return.

2.5.3. MODE BUTTONS

These buttons display specific modes:

Button	Function	See
	Waveform acquisition mode, with two sub-modes: transients mode (blackouts, interference, etc.) and inrush current mode (starting of motor).	§ 5
	Harmonic graphs display mode: representation of voltage, current, and power harmonics, order by order; determination of harmonic currents produced by nonlinear loads, analysis of problems caused by harmonics according to their order (overheating of neutrals, conductors, motors, etc.).	§ 6
	Waveform display mode: display of voltage and current waveforms, display of minima and maxima of summary tables, determination of phase rotation.	§ 7
	Alarm mode: list of recorded alarms exceeding selected thresholds; recording of network blackouts with half-cycle resolution (Vrms, Arms, Urms), determination of energy consumption overshoots, monitoring of compliance with a power supply quality contract.	§ 8
	Trend mode: recording of selected parameters.	§ 9
	Power/energy mode: display of power and energy measurements.	§ 10



Three buttons are real-time mode buttons: ,  and .

In each of these modes, colored circles on a white background (for example ①) indicate channel number or type. These indicate saturation; the circle background is colored when the channel measured is potentially full (for instance ①).

When the circle corresponds to a simulated channel (for example in 4-wire three-phase with selection V1V2, 2½-element method, or in 3-wire three-phase with selection A1A2, 2-element method; see connections in §4.6), this channel is potentially full if at least one channel used in calculating it is potentially full.

Similarly, if the circle corresponds to a phase-to-phase voltage channel, it is potentially full if at least one of the phase- to-neutral voltage channels used in calculating it is potentially full.

2.5.4. OTHER BUTTONS

Button	Function	See
	Configuration.	§ 4
	Snapshot of current screen and retrieval of screens already stored.	§ 11
	Help: provides information about the currently displayed functions and symbols.	§ 12

2.6. CONNECTORS

2.6.1. CONNECTION TERMINALS

These are located on one side of the housing. Each terminal is protected by a plug. The plugs must be removed to connect the leads, then stowed in the pouch in the cover of the instrument.

To keep the instrument water- and air-tight and the terminals clean, put the plugs back on the unused terminals. The terminals let the operator:

- screw special leads in place to ensure total water-tightness
- or connect standard leads that are slightly less water-tight

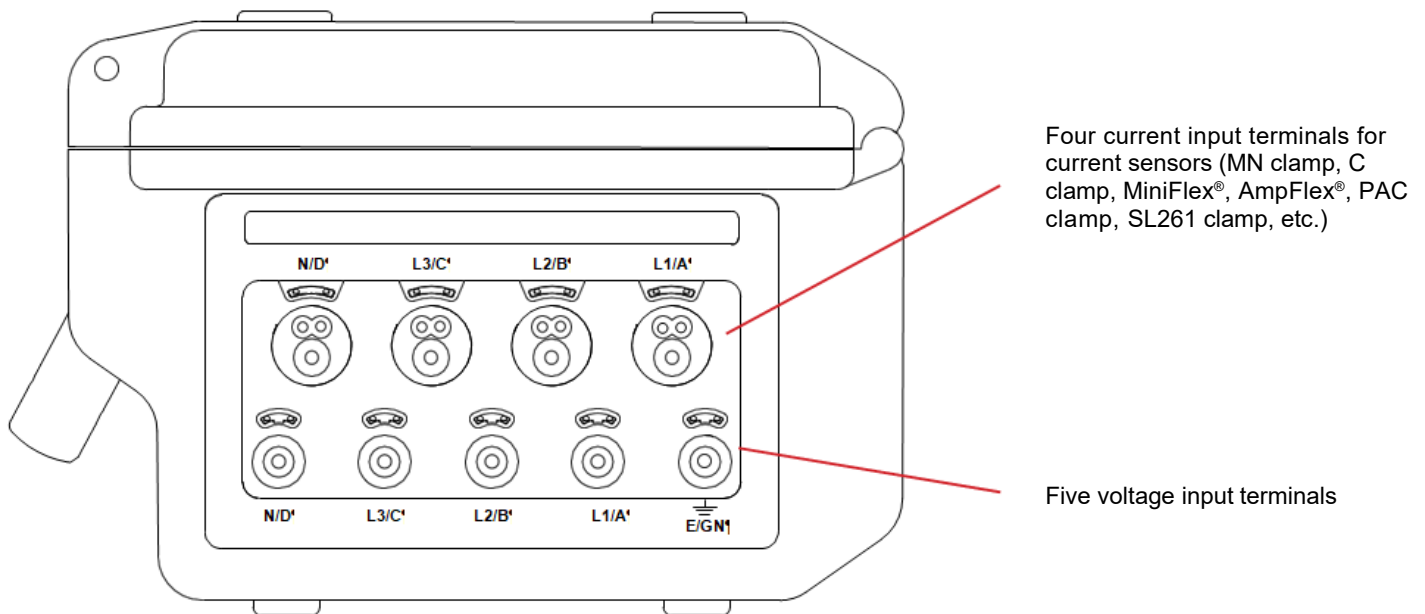

Figure 2-3

2.6.2. SIDE CONNECTORS

On the right side of the instrument is the connector used to charge the battery and operate the instrument on AC power, or supply it from the voltages on the measurement terminals.

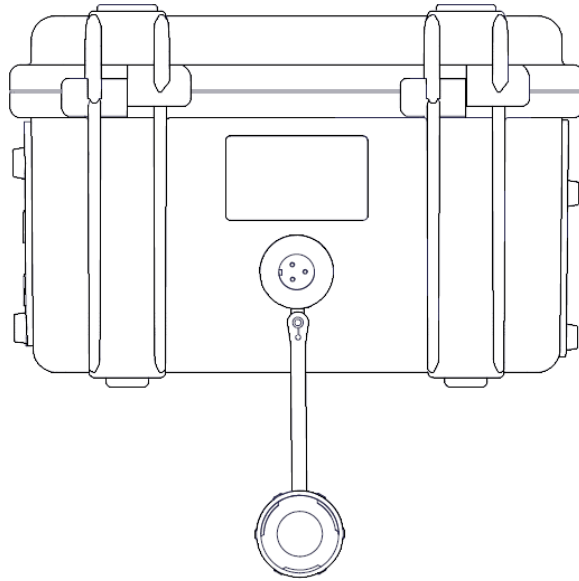

Figure 2-4

2.7. POWER SUPPLY

The battery icon in the top right corner of the screen shows the battery charge level. The number of bars is proportional to the charge level.

Icon	Description
	Battery charged
	Low battery
	Moving bars: battery charging
	Red bar: the condition of the battery is unknown because it has never been fully charged
	The instrument is connected to external power without the battery

When instrument shutdown due to low battery is imminent, a warning message is displayed:

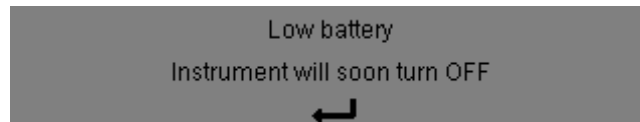

Press \leftarrow to confirm the message. If you do not connect the instrument to external power, it turns OFF one minute after this message is displayed. To avoid this, start re-charging the battery immediately.

2.8. ABBREVIATIONS

Prefixes of International System (SI) units:

Prefix	Symbol	Multiplies by
milli	m	10^{-3}
kilo	k	10^3
Mega	M	10^6
Giga	G	10^9
Tera	T	10^{12}
Peta	P	10^{15}
Exa	E	10^{18}

Symbols used by the instrument:

Symbol	Definition
\cong	AC and DC components.
\sim	AC component only.
\equiv	DC component only.
$\overset{\sim}{ }$	Inductive phase shift.
$\overset{\sim}{=}$	Capacitive phase shift.
$^{\circ}$	Degree.
-.+	Expert mode.
	Absolute value.
Σ	Sum of values.
%	Percentage.
%f	Fundamental value as reference.
%r	Total value as reference.
Φ_{VA} or Φ_{UA}	Phase shift of voltage with respect to current.
A	Current; also Ampere (unit).
A-h	Current harmonic.
Acf	Crest (peak) factor of current.
Ad	RMS distortion current.
Adc	DC current.
Apk+	Maximum peak value of current.
Apk-	Minimum peak value of current.
Arms	True RMS current.
Athdf	Total harmonic distortion of current in %f.
Athdr	Total harmonic distortion of the current with the total RMS value without DC as reference.
Aunb	Negative-sequence current unbalance rate.
AVG	Mean value (arithmetic mean).
CF	Peak factor (current or voltage).
cos Φ	Cosine of the phase shift of voltage with respect to current (DPF – fundamental power factor or displacement factor).
D	Distortion power.
DC	DC component (current or voltage).
Dh	Distortion energy.
DPF	Displacement factor (cos Φ).
FHL	Harmonic loss factor.
FK	K factor.
Hz	Frequency of network.
L	Channel (Line).
MAX	Maximum value.
MIN	Minimum value.
ms	Millisecond.

Symbol	Definition
N	Non-active power.
Nh	Non-active energy.
P	Active power.
Pdc	DC power.
Pdch	DC energy.
PEAK or PK	Maximum (+) or minimum (-) peak instantaneous value of the signal.
PF	Power factor.
Ph	Active energy.
PLT	Long-term flicker.
PST	Short-term flicker.
Q₁	Reactive power (fundamental).
Q_{1h}	Reactive energy (fundamental).
RMS	True RMS value (current or voltage).
S	Apparent power.
S-h	Apparent harmonic power.
Sh	Apparent energy.
t	Relative date of time cursor.
tan Φ	Tangent of the phase shift of voltage with respect to current.
THD	Total harmonic distortion (in %f or in %r).
U	Phase-to-phase voltage.
U-h	Phase-to-phase voltage harmonic.
Ucf	Phase-to-phase voltage crest factor.
Ud	Phase-to-phase RMS distortion voltage.
Udc	Phase-to-phase DC voltage.
Upk+	Maximum peak value of phase-to-phase voltage.
Upk-	Minimum peak value of phase-to-phase voltage.
Urms	True RMS phase-to-phase voltage.
Uthdf	Total phase-to-phase voltage harmonic distortion in %f.
Uthdr	Total phase-to-phase voltage harmonic distortion in %r.
Uunb	Negative-sequence phase-to-phase voltage unbalance rate.
V	Phase-to-neutral voltage; also Volt (unit).
V-h	Phase-to-neutral voltage harmonic.
Vcf	Voltage crest (peak) factor.
Vd	Phase-to-neutral RMS distortion voltage.
Vdc	Peak factor of the phase-to-ground voltage.
Vpk+	Maximum peak value of the phase-to-neutral voltage.
Vpk-	Minimum peak value of the phase-to-neutral voltage.
Vrms	True RMS phase-to-neutral voltage.
Vthdf	Total harmonic distortion of phase-to-neutral voltage in %f.
Vthdr	Total harmonic distortion of phase-to-neutral voltage in %r.
Vunb	Negative-sequence phase-to-ground voltage unbalance rate.

3. OPERATION

3.1. START-UP

To turn the instrument ON, press the  button.

After the software check, the home page is displayed, followed by the information screen that indicates the software version of the instrument and its serial number. The Waveform screen is then displayed:

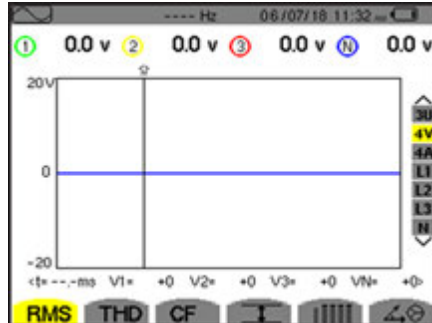











Figure 3-1

3.2. CONFIGURATION

To configure the instrument:

1. Press . The Configuration screen appears (see Figure 4-1).
2. Press  or  to select the parameter to be modified.
3. Press  to enter the selected sub-menu.
4. Use the arrow buttons ( or  and  or ) and the  button to validate. For more details, see §§4.3 to 4.10.

The following settings must be checked (and if necessary modified) for each measurement:

- Calculation methods (see §4.5).
- Distribution system (single-phase to five-wire three-phase) and connection method (2 wattmeters, 2 ½ elements, standard) (§4.6).
- Current ratios according to the type of current sensor connected (§4.7).
- Voltage ratios (§4.7).
- Triggering levels (transients mode and inrush current capture) (§4.8).
- Values to be recorded (trend mode) (§4.9).
- Alarm thresholds (§4.10).

To return to the Configuration screen from a sub-menu, press the  button.

3.3. LEADS INSTALLATION

To identify the leads and input terminals, you can mark them in accordance with the usual phase/neutral color code using the colored rings and inserts supplied with the instrument.

1. Detach the insert and place it in the hole provided for it near the terminal (large insert for a current terminal; small insert for a voltage terminal).

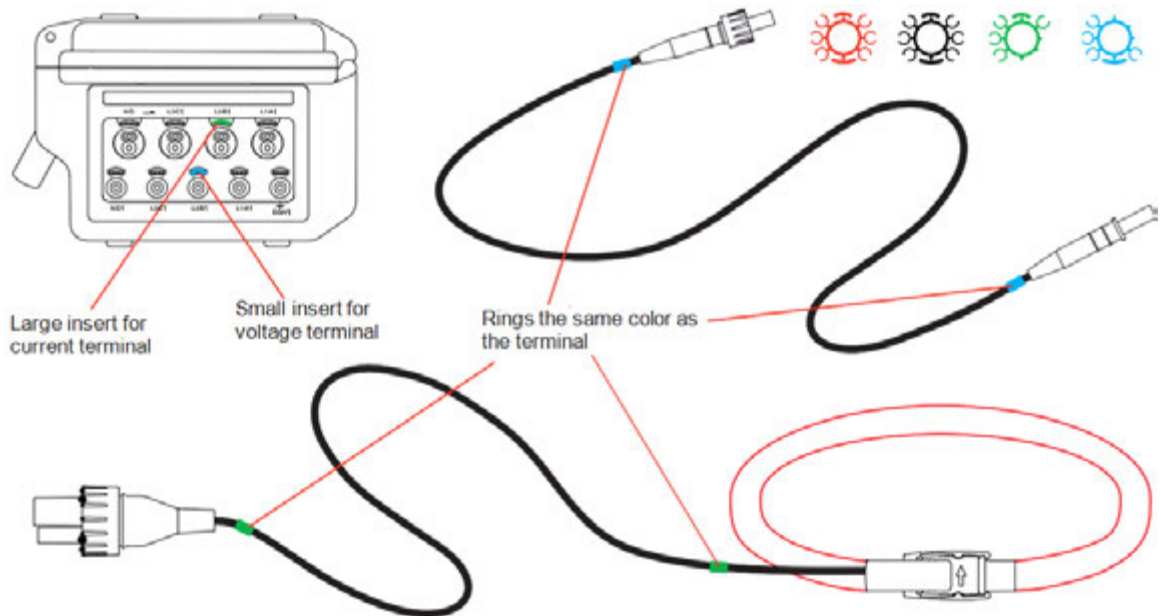

Figure 3-2

2. Clip rings of the same color to the ends of the lead you will connect to the terminal. Twelve sets of rings and inserts of different colors are provided to enable you to coordinate the instrument with any applicable phase/neutral color codes.
3. Connect the measurement leads to the instrument terminals. Be sure to define the transformation ratios of the current sensors and of the voltage inputs (see §4.7).

To make a measurement, at a minimum you must select:

- calculation method (§4.5)
- connection (§4.6)
- sensor ratios (§4.7)

The measurement leads must be connected to the electrical network to be measured as shown by the following diagrams.

3.3.1. SINGLE-PHASE NETWORK

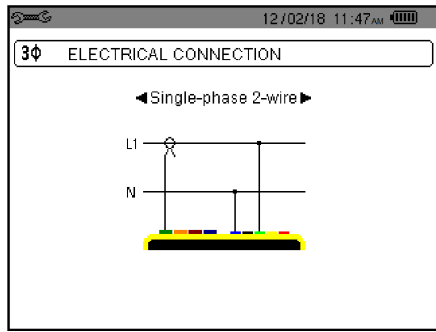

Figure 3-3 (2-wire single-phase connection)

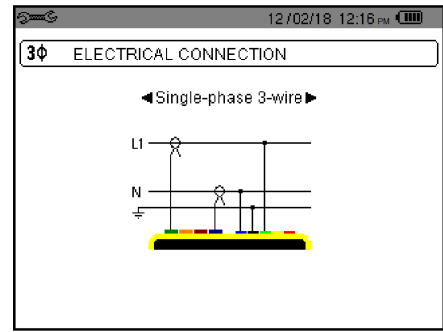

Figure 3-4 (3-wire single-phase connection)

3.3.2. SPLIT-PHASE NETWORK

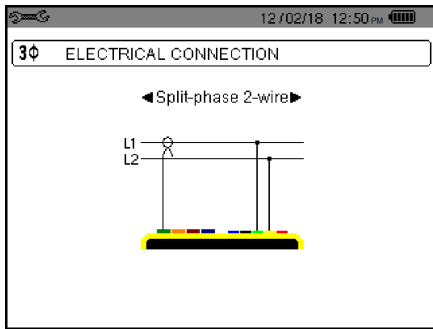

Figure 3-5 (2-wire split-phase connection)

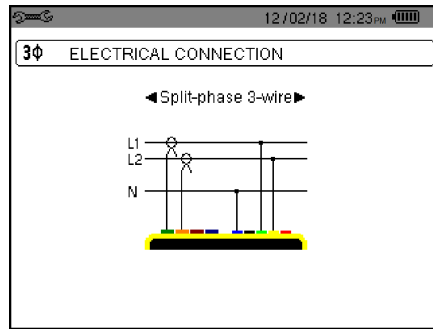

Figure 3-6 (3-wire split-phase connection)

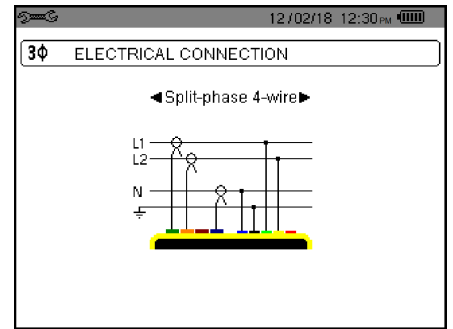

Figure 3-7 (4-wire split-phase connection)

3.3.3. THREE-PHASE NETWORK

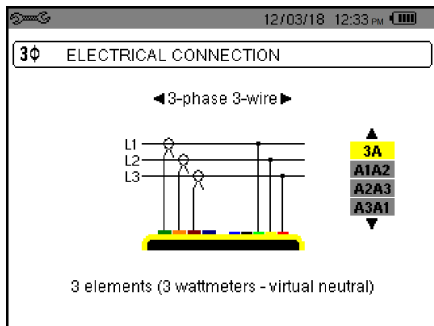

Figure 3-8 (3-wire three-phase connection)

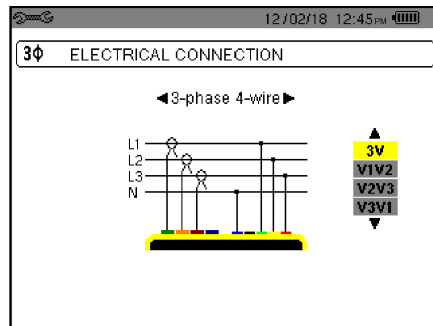

Figure 3-9 (4-wire three-phase connection)

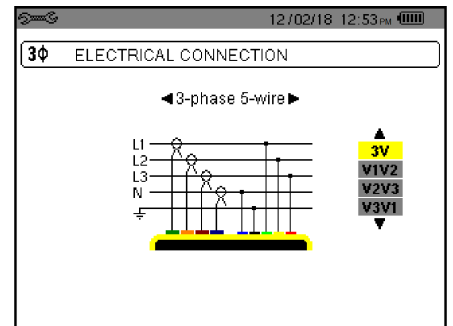

Figure 3-10 (5-wire three-phase connection)

When connecting to a three-phase network, you do not need to connect all terminals in voltage or current.

For 3-wire three-phase, indicate the current sensors that will be connected: all 3 sensors (3A) or only 2 (A1 and A2, or A2 and A3, or A3 and A1).

For 4- and 5-wire three-phase, indicate the voltages that will be connected: all 3 voltages (3V) or only 2 (V1 and V2, or V2 and V3, or V3 and V1).

3.3.4. CONNECTION

1. Turn the instrument ON.
2. Configure the instrument for the measurement to be made and the network type (see §4).
3. Connect the leads and current sensors to the instrument.
4. Connect the ground and/or neutral lead to the network ground and/or neutral (when it is distributed) and connect the corresponding current sensor.
5. Connect the L1 phase lead to the network L1 phase and connect the corresponding current sensor.
6. If applicable, repeat the procedure for phases L2 and L3, and for N.





NOTE: Complying with this procedure minimizes connection errors and saves time.

Disconnection procedure:

1. Proceed in reverse order of connection, always finishing by disconnecting the neutral (when distributed).
2. Disconnect the leads and turn the instrument OFF.

3.4. INSTRUMENT FUNCTIONS

Any screen display can be saved as a “snapshot” by pressing the  button for 3 seconds (see §11).

You can press the Help button  at any time. The Help screen will provide information about the symbols and mode currently displayed.

3.4.1. WAVEFORM CAPTURE

With the instrument powered up and connected to the network, press .

You can display the Transients mode (see §5.1) or the Inrush current mode (§5.2).

3.4.2. HARMONICS DISPLAY

With the instrument powered up and connected to the network, press .

You can display the phase-to-neutral voltage (see §6.1), current (§6.2), apparent power (§6.3) or phase-to- phase voltage (see §6.4).

3.4.3. WAVEFORM MEASUREMENTS

With the instrument powered up and connected to the network, press .

You can display the measurements of the true RMS value (see §7.1), total harmonic distortion (§7.2), peak factor (§7.3), maximum/minimum voltage and current (§7.4), multiple values simultaneously (§7.5), or phasor diagram (§7.6).

3.4.4. ALARM RECORDING

With the instrument powered up and connected to the network, press .

You can configure the alarm mode (§8.1), configure an alarm campaign (§8.2), look it up (§8.4), or erase it (§8.6).

3.4.5. RECORDING

With the instrument powered up and connected to the network, press .

You can configure and start recordings (§9.1 and §9.2). You can view (§9.5) and erase (§9.4) them.

3.4.6. ENERGY MEASUREMENTS





With the instrument powered up and connected to the network, press .



You can measure the energies consumed (§10.1.3) or generated (§10.1.4, §10.2.2, or §10.3.2).

4. CONFIGURATION

The Configuration  button displays the Configuration menu for configuring the instrument. This must be done before each new type of measurement. The configuration remains in memory, even after the instrument is turned OFF.

4.1. CONFIGURATION MENU

The arrow (, , , ) buttons let you navigate the Configuration menu and select settings. A value that can be modified is identified by arrows.

For most options, you must press the  button to confirm and apply the change. Pressing the return  button returns to the main menu from a sub-menu.

4.2. DISPLAY LANGUAGE

To select the display language, press the yellow button under the corresponding icon on the screen (Figure 4-1).

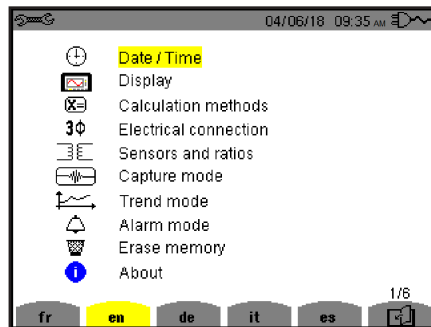



Figure 4-1

The selected language is highlighted in yellow.

4.3. DATE/TIME

The  Date/Time menu sets the instrument date and time.

1. In the Configuration screen, select the Date/Time option and press . This displays the Date/Time menu.

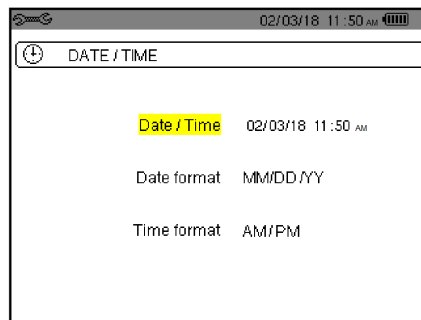









Figure 4-2

2. To change a value, press  or . To move from one field to another, press  or . To confirm, press .
3. Use these buttons to select and set the date format (DD/MM/YY or MM/DD/YY) and time format (12/24 or AM/PM). Changes take effect immediately.
4. To return to the Configuration menu, press .



NOTE: The date and time parameters cannot be changed while the instrument is recording, metering energy, or searching for transients, alarms, and/or inrush current events.

4.4. DISPLAY

The  Display menu lets you set options that affect the instrument display screen, including:

- Brightness level (§4.4.1)
- Display colors (§4.4.2)
- Automatic shutdown of screen (§4.4.3)
- Night mode (§4.4.4)

To open Display mode, select the  Display option in the Configuration screen and press \leftarrow . This opens the Brightness screen (Figure 4-3). The options at the bottom of the screen allow you to navigate to other display screens.

4.4.1. BRIGHTNESS

The  Brightness menu adjusts the brightness level of the instrument display screen.

1. At the Configuration screen, select the  Display option and press \leftarrow . This displays the Brightness screen.

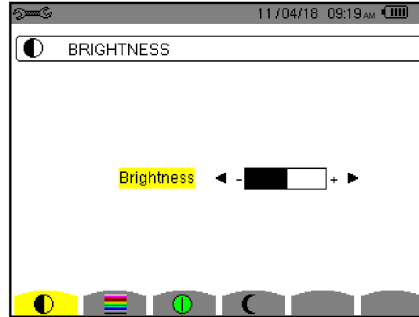



Figure 4-3

2. Use the left and right (\leftarrow \rightarrow) buttons to change the brightness.
3. To return to the Configuration menu, press .

4.4.2. COLORS

The  Colors menu defines the colors of the voltage and current graphs.

1. In the Brightness screen (Figure 4-3), press the  function button. This displays the Colors menu.

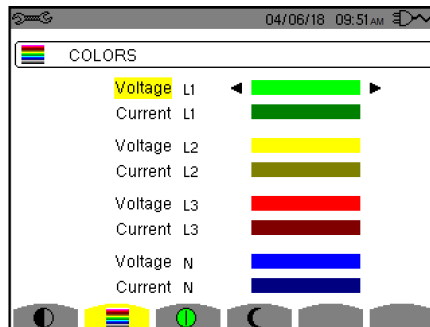





Figure 4-4

2. There are 15 colors available: green, dark green, yellow, orange, pink, red, brown, blue, turquoise blue, dark blue, very light grey, light grey, grey, dark grey, and black. Use the arrow (\uparrow , \downarrow , \leftarrow , \rightarrow) buttons to change the assignments of the colors.
3. To return to the Configuration menu, press .

4.4.3. DISPLAY SHUTDOWN

The  Display Shutdown menu defines whether or not the screen automatically turns OFF after a specific period of inactivity, to save battery power.

1. In the Brightness screen, press the  function button. This displays the Display Shutdown screen.

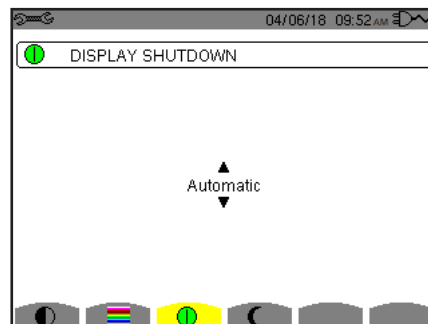



Figure 4-5

- Use the arrow (▲, ▼) buttons to choose Automatic or Never. When Automatic is selected, the display screen turns OFF after five minutes without button activity (if the instrument is powered only by its battery and if recording is in progress) and after ten minutes if no recording is in progress. The ON/OFF button blinks to indicate that the instrument is still in operation. Pressing any button on the keypad relights the screen.
- To return to the Configuration menu, press ↶.

4.4.4. NIGHT MODE

The  Night Mode menu enables night mode. In night mode, the screen colors change to light text on a dark background for easier viewing in low-light conditions.



- At the Brightness screen, press the  function button to display the Night Mode screen.



Figure 4-6

- Use the navigation buttons (▲, ▼) to activate or deactivate night mode. The screen then changes to reverse video and all colors are changed.
- To return to the Configuration menu, press ↶.

4.5. CALCULATION METHODS

The  Calculation Methods option in the Configuration menu defines:

- Breakdown or no breakdown of non-active quantities (§4.5.1)
- Unit of energy (§4.5.2)
- Coefficients of calculation for K factor (§4.5.3)
- Reference for the level of phase harmonics (§4.5.4)
- Method of calculation of long-term flicker (§4.5.5)

4.5.1. NON-ACTIVE QUANTITIES CALCULATION

The **var** Non-Active Values menu defines whether or not to break down the non-active quantities (powers and energies).

- At the Configuration screen, select  and press ↵. This displays the Non-Active Values menu.

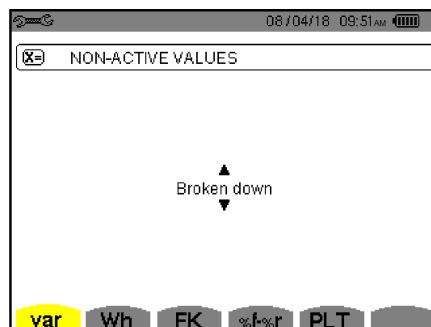

Figure 4-7

- Use the arrow (▲, ▼) buttons to select Broken down or Not broken down.
 - Broken down: Non-active power N is broken down into reactive power (fundamental) Q1 and distorting power D. Non-active energy Nh is broken down into Q1h and Dh.
 - Not broken down: Non-active power N and non-active energy Nh are displayed.
- Press ↵ to validate the selection and return to the Configuration menu.



NOTE: You cannot change this option when the instrument is recording, metering energy, and/or searching for alarms.

4.5.2. UNITS OF ENERGY

The **Wh** Energy Unit menu defines the unit of display of energies.

1. At the Non-Active Values screen (Figure 4-7), press the **Wh** function button to display the Energy Unit screen.

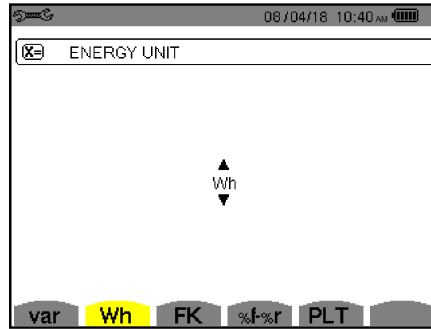

Figure 4-8

2. Use the arrow buttons (▲, ▼) to select the unit:
 - Wh: watt-hour.
 - J: joule.
 - toe (nuclear): nuclear ton oil equivalent.
 - toe (non-nuclear): non-nuclear ton oil equivalent.
 - BTU: British Thermal Unit.
3. Press ↵ to validate the selection and return to the Configuration menu.

4.5.3. K FACTOR

The **FK** menu defines the coefficients used for the calculation of Factor K.

1. At the Non-Active Values screen, press the **FK** function button to display the Transformer Factor K screen.

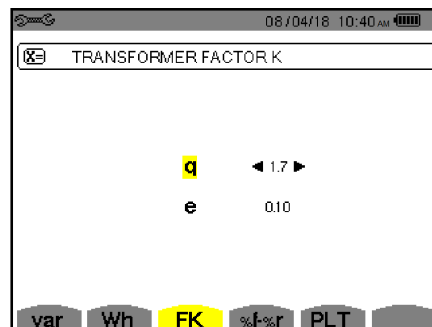

Figure 4-9

2. Use the arrow buttons (▲, ▼, ◀, ▶) to fix the value of coefficients q and e:
 - q: exponential constant that depends on the type of winding and the frequency. The value of q can range from 1.5 to 1.7. The value of 1.7 is suitable for transformers having round or square conductors, in all types of winding. The value of 1.5 is suitable for those in which the low-voltage windings are in tape form.
 - e: ratio between the losses linked to eddy currents (at the fundamental frequency) and resistive losses (both evaluated at the reference temperature). The value of e can range from 0.05 to 0.1.

The default values (q = 1.7 and e = 0.10) are suitable for most applications.

3. Press ↵ to validate the selection and return to the Configuration menu.



NOTE: You cannot change this option when the instrument is recording and/or searching for alarms.

4.5.4. PHASE HARMONICS

The %f-%r Phase Harmonic Ratios menu defines the reference for the level of harmonics of the phases.

1. At the Non-Active Values screen, press the %f-%r function button to display the Phase Harmonic Ratios screen.

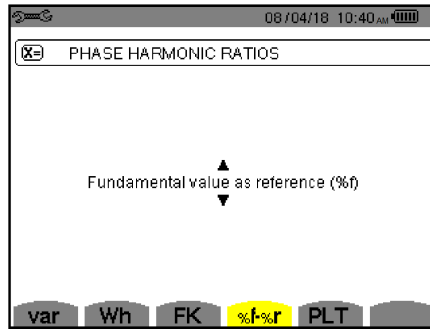

Figure 4-10

2. Use the arrow buttons (▲, ▼) to set the reference for harmonics:
 - %f: the reference is the value of the fundamental.
 - %r: the reference is the total value.
3. Press ↵ to validate the selection and return to the Configuration menu.

For the level of harmonics of the V-h, A-h, and U-h phases, the fundamental and total values are RMS values. For the level of harmonics of the S-h phases, the fundamental and total values are apparent power values.



NOTE: You cannot change this option when the instrument is recording and/or searching for alarms.

4.5.5. LONG-TERM FLICKER (PLT)

The PLT Long-Term Flicker menu defines the method used to calculate the PLT (long-term flicker).

1. At the Non-Active Values screen, press the PLT function button to display the Long-Term Flicker screen.

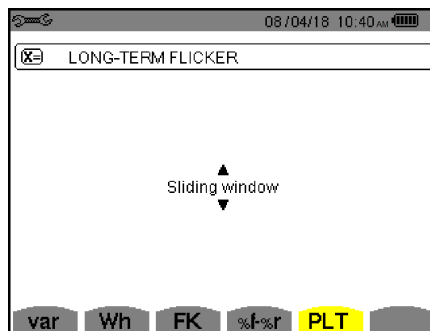

Figure 4-11

2. Use the arrow buttons (▲, ▼) to choose sliding or non-sliding.
 - Sliding: the PLT is calculated every 10 minutes. The first value is available 2 hours after the instrument is turned ON, because it takes 12 values of PST to calculate the PLT.
 - Non-sliding: the PLT is calculated every 2 hours.
3. Validate by pressing the ↵ button. The instrument returns to the Configuration menu.



NOTE: You cannot change this option when the instrument is recording and/or searching for alarms.

4.6. CONNECTION

Pressing 3ϕ Electrical Hook-up in the Configuration menu displays the Electrical Connection screen. This defines how the instrument is connected to different types of electrical networks.

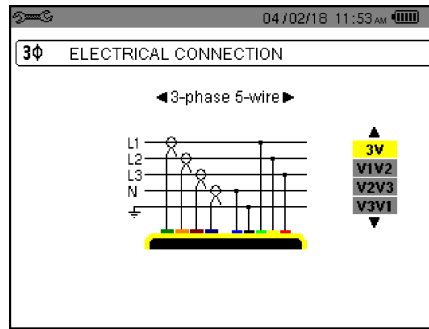
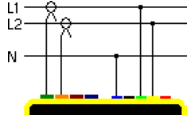
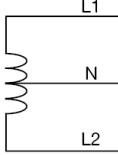
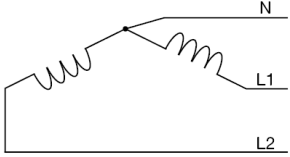
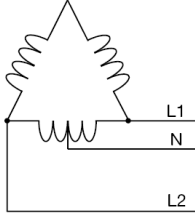
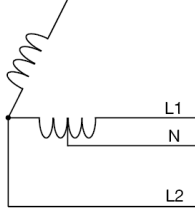
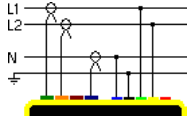
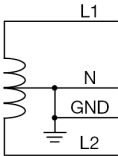
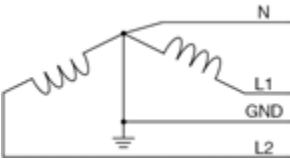
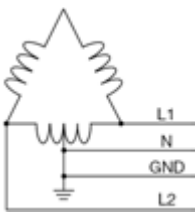
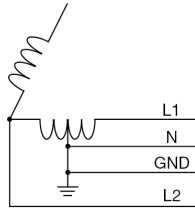

Figure 4-12

Several electrical diagrams can be selected. Use the arrow buttons (\blacktriangle , \blacktriangledown , \blacktriangleleft , \blacktriangleright) to choose a connection.

One or more types of network correspond to each distribution system.

Distribution system	Source	
Single-phase 2-wire (L1 and N) 	Single-phase 2-wire non-earthed neutral	
Single-phase 3-wire (L1, N and earth) 	Single-phase 3-wire earthed neutral	
Split-phase 2-wire (L1 and L2) 	Split-phase 2-wire	
	3-phase open star 2-wire	

Distribution system	Source	
<p data-bbox="197 483 392 539">Split-phase 3-wire (L1, L2 and N)</p> 	Split-phase 3-wire non-grounded neutral	
	3-phase open star 3-wire non-grounded neutral	
	3-phase high leg delta 3-wire non-grounded neutral	
	3-phase open high leg delta 3-wire non-grounded neutral	
<p data-bbox="181 1305 408 1361">Split-phase 4-wire (L1, L2, N and earth)</p> 	Split-phase 4-wire grounded neutral	
	3-phase open star 4-wire grounded neutral	
	3-phase high leg delta 4-wire grounded neutral	
	3-phase open high leg delta 4-wire grounded neutral	

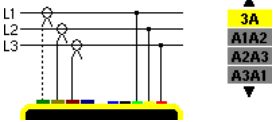
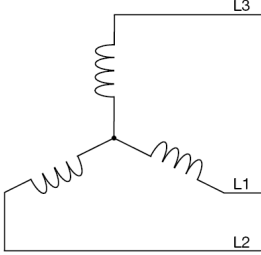
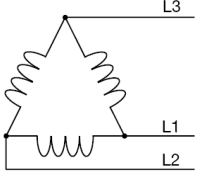
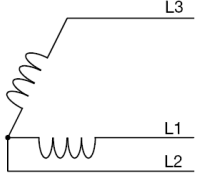
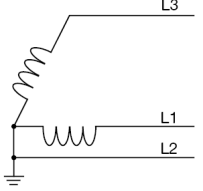
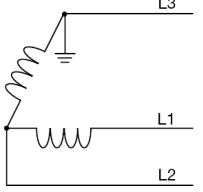
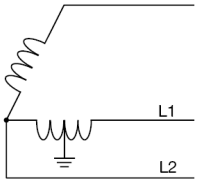
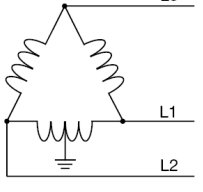
Distribution system	Source	
<p>3-phase 3-wire (L1, L2 and L3)</p>  <p>Indicate which current sensors will be connected: all 3 (3A) or only 2 (A1 and A2, or A2 and A3, or A3 and A1).</p> <p>Three-wattmeter method with virtual neutral (with 3 sensors connected) or two-wattmeter method or two-element method or Aron method (with 2 sensors connected).</p> <p>A third sensor is not necessary if two sensors of the same type, same range, and same ratio are connected. Otherwise, the third sensor must be connected to make current measurements.</p>	3-phase star 3-wire	
	3-phase delta 3-wire	
	3-phase open delta 3-wire	
	3-phase open delta 3-wire grounded junction of phases	
	3-phase open delta 3-wire grounded corner of phase	
	3-phase high leg delta 3-wire	
	3-phase open high leg delta 3-wire	

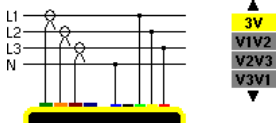
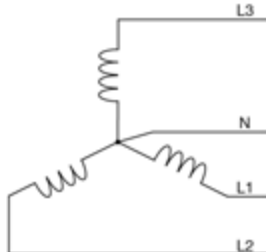
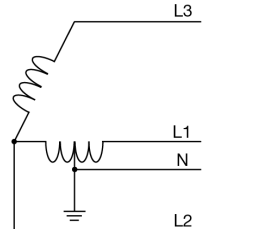
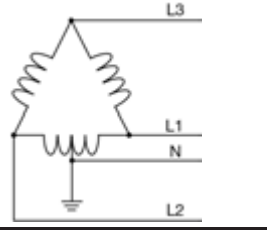
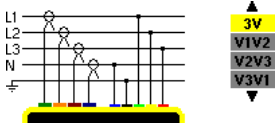
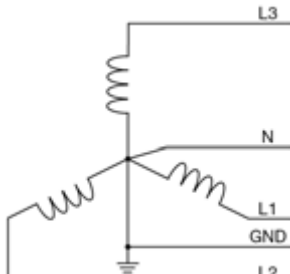
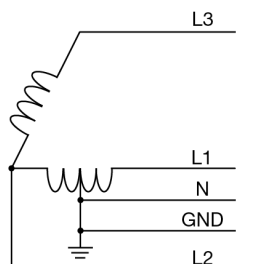
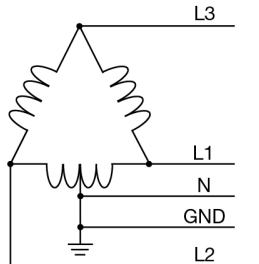
Distribution system	Source	
<p>3-phase 4-wire (L1, L2, L3 and N)</p>  <p>Indicate which voltages will be connected: all 3 (3V) or only 2 (V1 and V2, or V2 and V3, or V3 and V1).</p> <p>If only two of the three voltages are connected, the three phase voltages must be balanced (2½-element method)</p>	3-phase star 4-wire non-grounded neutral	
	3-phase open high leg delta 4-wire non-grounded neutral	
	3-phase high leg delta 4-wire non-grounded neutral	
<p>3-phase 5-wire (L1, L2, L3, N and earth)</p>  <p>Indicate which voltages will be connected: all 3 (3V) or only 2 (V1 and V2, or V2 and V3, or V3 and V1).</p> <p>If only two of the three voltages are connected, the three phase voltages must be balanced (2½-element method)</p>	3-phase star 5-wire grounded neutral	
	3-phase open high leg delta 5-wire grounded neutral	
	3-phase high leg delta 5-wire grounded neutral	

Validate the selection with the ↵ button. The instrument returns to the Configuration menu.



NOTE: You cannot change the network type when the instrument is recording, metering energy, or searching for transients, alarms, and/or inrush current acquisitions.

4.7. SENSORS AND RATIOS



NOTE: The ratios cannot be changed if the instrument is recording, metering energy, or searching for transients, alarms, and/or inrush current acquisitions.

4.7.1. CURRENT SENSORS AND RATIOS

Pressing \mathbb{E} Probes and Ratios at the Configuration menu displays a menu for defining the current sensors and ratios. It automatically displays the current sensor models detected by the instrument. If a sensor is detected but not a supported type, an error message is displayed.

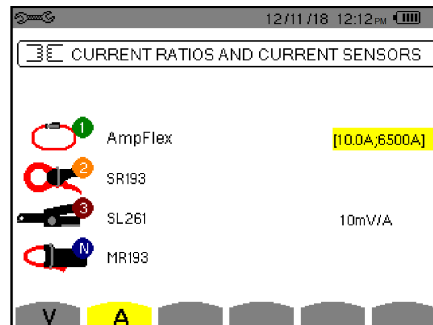

Figure 4-13

For a 3-wire three-phase set-up where only two of the three current sensors required are connected, if these two sensors are of the same type and have the same ratio, the instrument simulates the third sensor by assuming the same characteristics as the other two. The third sensor will be shown in the list as being simulated, or impossible to simulate otherwise.

Supported current sensors are:

	MN93 clamp: 200 A.
	MN193 clamp: 100 A or 5 A.
	SR193 clamp: 1000 A.
	J93 clamp : 3500 A.
	AmpFlex®: 100, 6500 or 10000 A.
	MiniFlex®: 100 or 6500 A.
	MR193 clamp: 1000 A.
	SL261 clamp: 100 A (sensitivity 10 mV/A).
	SL261 clamp: 10 A (sensitivity 100 mV/A).
	Three phase adapter: 5 A.

If an MN193 clamp (5A range), an Adapter, an AmpFlex®, a MiniFlex®, or an SL261 clamp is used, adjustment of the ratio, of the range, or of the sensitivity is proposed automatically.

Use the arrow buttons (\blacktriangle , \blacktriangledown , \blacktriangleleft , \blacktriangleright) to define the transformation ratios between the primary current (1A to 60,000A) and the secondary current (1A, 2A or 5A), then validate with the \curvearrowright button.

The primary current cannot be less than the secondary current.

4.7.2. VOLTAGE RATIOS

The Sensors and Ratios menu also lets you set voltage ratios. The option for doing this is either **U** (for setups without neutral) or **V** (for setups with neutral). Select the displayed option from the Current Ratios and Current Sensors menu (Figure 4-13).

Ratios are phase-to-neutral voltage ratios when there is a neutral, and phase-to-phase voltage ratios when there is not. The ratios settings can be different or the same for all or for some channels.

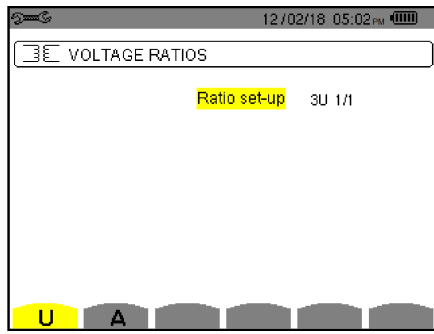

Figure 4-14 (Voltage Ratios screen without neutral)

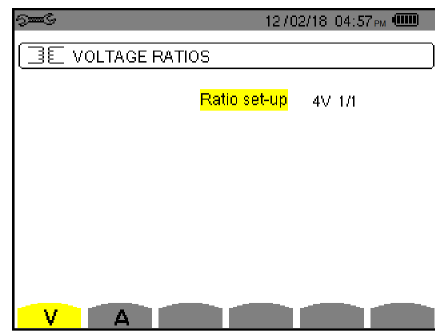

Figure 4-15 (Voltage Ratios screen with neutral)

Use the arrow buttons (▲, ▼) to choose the configuration of the ratios.

- 3U 1/1 or 4V 1/1: all channels have the same 1/1 ratio.
- 3U or 4V: all channels have the same ratio, to be configured.
 - Press the ↵ button, then use the ▲, ▼ buttons to highlight the ratio in yellow.



- Press the ↵ button, then use the ▲, ▼, ◀ and ▶ buttons to change the ratio. The primary voltage is in kV and the secondary voltage is in V



- 3V + VN: all channels have the same ratio and the neutral has a different ratio. Proceed as when there is only one ratio, but perform the operation twice.
- U1+U2+U3 or V1+V2+V3+VN: each channel has a different ratio, to be configured. Proceed as when there is only one ratio, but perform the operation several times.



Validate with the ↵ button. To return to the Configuration menu, press ↶.



NOTE: The primary and secondary voltages can each be configured with a multiplier factor of $1/\sqrt{3}$.

4.8. CAPTURE MODE

The  Capture mode is used to configure the voltage thresholds, the current thresholds of the transient mode, and the current thresholds of the inrush current mode. Selecting this option displays the Voltage Thresholds menu (Figure 4-16). On the bottom left of this screen are two function buttons:

-  defines thresholds for voltage (V or U, depending on setup) or current (A).
-  defines inrush current thresholds.

4.8.1. TRANSIENT VOLTAGE THRESHOLDS

The Voltage Thresholds menu configures the voltage thresholds. Thresholds can be configured to be the same for all channels or different for some or all of them.

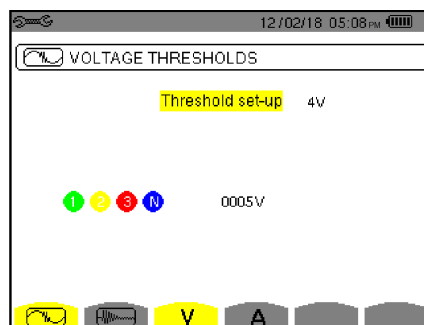



Figure 4-16

To change the voltage thresholds, press ↵. Use the arrow buttons (▲, ▼) to choose configuration of the thresholds.

- 4V or 3U: all channels have the same threshold.
 - Press the ↵ button, then use the ▲, ▼ buttons to highlight the value of the threshold in yellow.
 
 - Press the ↵ button, then use the ▲, ▼, ◀ and ▶ buttons to change the threshold. The unit can be the V or the kV.
 
- 3V + VN: all channels have the same ratio and the neutral has a different ratio. Proceed as when there is only one ratio, but perform the operation twice.
- V1+V2+V3+VN or U1+U2+U3: each channel has a different ratio, to be configured. Proceed as when there is only one ratio, but perform the operation several times.

Validate with the ↵ button. To return to the Configuration menu, press ↶.



NOTE: Transient thresholds cannot be changed if the instrument is actively searching for transients.

4.8.2. TRANSIENT CURRENT THRESHOLDS

Pressing the **A** function button in the Voltage Threshold menu (Figure 4-16) displays the Current Thresholds menu. This configures the current thresholds (independently of the current sensors detected by the instrument). Configured thresholds can be the same for all channels or different for some or all of them.

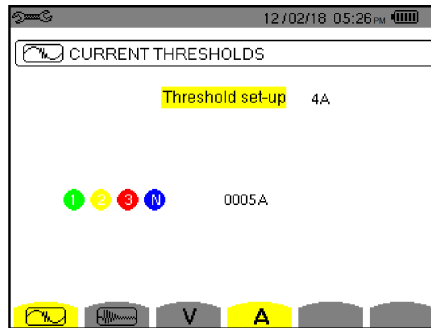



Figure 4-17

To change the current thresholds, press ↵.

Use the arrow buttons (▲, ▼) to choose the configuration of the thresholds.

- 4A: all current sensors have the same threshold.
 - Press the ↵ button, then use the ▲, ▼ buttons to highlight the value of the threshold in yellow.
 
 - Press the ↵ button, then use the ▲, ▼, ◀ and ▶ buttons to change the threshold. The unit can be the A, the kA or the mA.
 
- 3A +AN: all current sensors have the same threshold and the one connected to the neutral has a different threshold. Proceed as when there is only one ratio, but perform the operation twice.
- A1+A2+A3+AN: each current sensor has a different threshold, to be configured. Proceed as when there is only one ratio, but perform the operation several times.

Validate with the ↵ button. To return to the Configuration menu, press ↶.



NOTE: Changing the thresholds in the transient mode is impossible if the instrument is searching for transients.

4.8.3. INRUSH CURRENT THRESHOLDS

Pressing the  function button in the Voltage Threshold menu displays the Current Thresholds Setup menu. This defines the inrush current thresholds. To do this, you must configure the triggering threshold and the inrush current capture stopping threshold (triggering threshold less hysteresis).

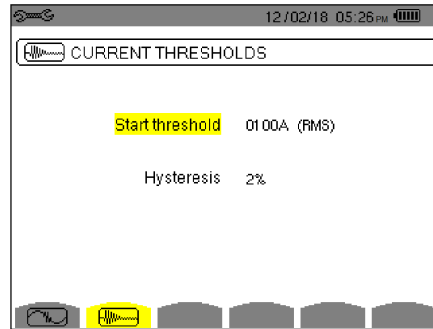



Figure 4-18

1. To change the inrush current triggering threshold, press the \leftarrow button.
2. Use the \blacktriangle , \blacktriangledown , \blacktriangleleft and \blacktriangleright buttons to change the triggering threshold. The unit can be the A, the kA, or the mA.
3. Press the \leftarrow button, then use the \blacktriangle , \blacktriangledown buttons to highlight the hysteresis in yellow.
4. Use the \blacktriangle , \blacktriangledown , \blacktriangleleft and \blacktriangleright buttons to change the hysteresis and press the \leftarrow button to validate.
5. To return to the Configuration menu, press \rightarrow .

NOTES: Configuring the hysteresis at 100% is equivalent to not having a stop threshold. Changing the thresholds in inrush current mode is not possible if the instrument is in inrush current capture mode.

4.9. TREND MODE

Selecting  Trend Mode in the Configuration menu displays the Trend Mode menu. This lets you select the measured and calculated values (Urms, Vrms, Arms, etc.) to include in recordings (, see §9).

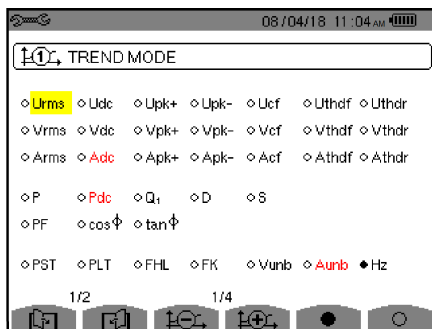

Figure 4-19 (Trend mode – first screen)

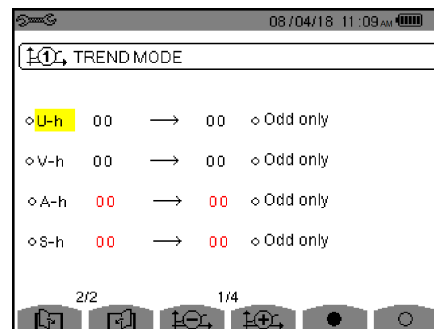







Figure 4-20 (Trend mode – second screen)

There are 4 possible programmable configurations: , , , and , independent of one another. To go from one to the other, use the  or  button.

To select the parameter to be recorded, move the yellow cursor to the parameter using the \blacktriangle , \blacktriangledown , \blacktriangleleft and \blacktriangleright buttons, then validate with the \leftarrow button. The selected parameter is identified by a red dot. The frequency (Hz) is always selected (black spot).

NOTE: Quantities displayed in red are incompatible with the configuration chosen (connection selected, sensors connected, ratios programmed, reference of the level of harmonics of the phases, breakdown of the non-active quantities). For example, if no current sensor is connected; all current quantities will be in red.

To select all parameters displayed on the page, press the  button. To deselect all parameters on the page, press the  button.

To change configuration pages, press the  or  button.

Recordable values are:

Unit	Definition
Urms	RMS phase-to-phase voltage.
Udc	RMS phase-to-neutral voltage.
Upk+	Maximum peak value of phase-to-phase voltage.
Upk-	Minimum peak value of phase-to-phase voltage.
Ucf	Crest (peak) factor of phase-to-phase voltage.
Uthdf	Harmonic distortion of the phase-to-phase voltage with the RMS value of the fundamental as reference.
Uthdr	Harmonic distortion of the phase-to-phase voltage with the total RMS value without DC as reference.
Vrms	RMS phase-to-neutral voltage.
Vdc	DC phase-to-neutral voltage.
Vpk+	Maximum peak value of the phase-to-neutral voltage.
Vpk-	Minimum peak value of the phase-to-neutral voltage.
Vcf	Crest factor of phase-to-neutral voltage.
Vthdf	Harmonic distortion of the phase-to-neutral voltage with the RMS value of the fundamental as reference.
Vthdr	Harmonic distortion of the phase-to-neutral voltage with the total RMS value without DC as reference.
Arms	RMS current.
Adc	DC current.
Apk+	Maximum peak value of the current.
Apk-	Minimum peak value of the current.
Acf	Crest factor of current.
Athdf	Harmonic distortion of the current with the RMS value of the fundamental as reference.
Athdr	Harmonic distortion of the current with the total RMS value without DC as reference.
P	Active power.
Pdc	DC power.
Q_1	Reactive power (fundamental).
N	Non-active power.
D	Distortion power.
S	Apparent power.
PF	Power factor.
$\cos \Phi$	Cosine of the phase shift of the voltage with respect to the current (displacement factor or fundamental power factor – DPF).
$\tan \Phi$	Tangent of the phase shift of the voltage with respect to the current.
PST	Short-term flicker.
PLT	Long-term flicker.
FHL	Harmonic loss factor
FK	K factor.
Vunb or Uunb	Negative-sequence phase-to-ground voltage unbalance factor (set-up with neutral). Negative-sequence phase-to-phase voltage unbalance factor (set-up without neutral).
Aunb	Negative-sequence current unbalance factor.
Hz	Network frequency.
U-h	Harmonics in phase-to-phase voltage.
V-h	Harmonics in phase-to-neutral voltage
A-h	Harmonics in current.
S-h	Harmonics in power.

The values **U-h**, **V-h**, **A-h**, and **S-h** involve the recording of harmonics of U, V, A, and S. You can select a range of orders of harmonics to be recorded (0 to 50) for each of these quantities. You can also specify that only odd harmonics within the selected range be recorded.



NOTE: The level of harmonics of order 01 will be displayed only if they involve values expressed in %r.

To change an order of harmonic:

1. Select the parameter to be recorded (identified by a red spot).
2. Move the yellow cursor to the parameter using the ▲, ▼, ◀ and ▶ buttons, then select it by pressing the ↵ button.
3. Change the value using the ▲ and ▼ buttons, then validate with the ↵ button.

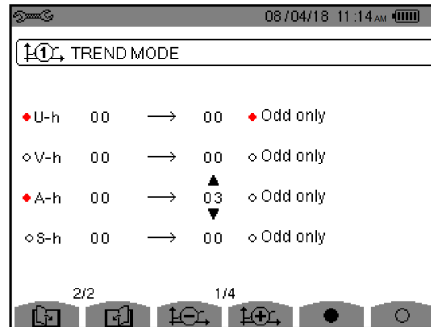

Figure 4-21



NOTE: If a recording is in progress, the associated configuration cannot be modified and the selected values are identified by black spots.

To return to the Configuration menu, press ↶.

4.10. ALARM MODE

The Alarm Mode screen defines the alarms used by the Alarm Mode function (see §7).

You can program up to 40 alarms. You can define a alarm on each of the following parameters:

Hz, Urms, Vrms, Arms, |Udc|, |Vdc|, |Adc|, |Upk+|, |Vpk+|, |Apk+|, |Upk-|, |Vpk-|, |Apk-|, Ucf, Vcf, Acf, Uthdf, Vthdf, Athdf, Uthdr, Vthdr, Athdr, |P|, |Pdc|, |Q|, | or N, D, S, |PF|, |cos Φ|, |tan Φ|, PST, PLT, FHL, FK, Vunb (or Uunb for a three-phase source without neutral), Aunb, U-h, V-h, A-h and |S-h| (see the table of abbreviations in §2.8).

To activate an alarm: Move the yellow cursor to its number using the ▲, ▼ buttons, then select it with the ↵ button. The active alarm is identified by a red spot. An alarm that is not configurable (indicated by “?”) cannot be activated.

To program the alarm: Move the yellow cursor using the ▲, ▼, ◀ and ▶ buttons, then validate with the ↵ button. Change the value, then validate again.

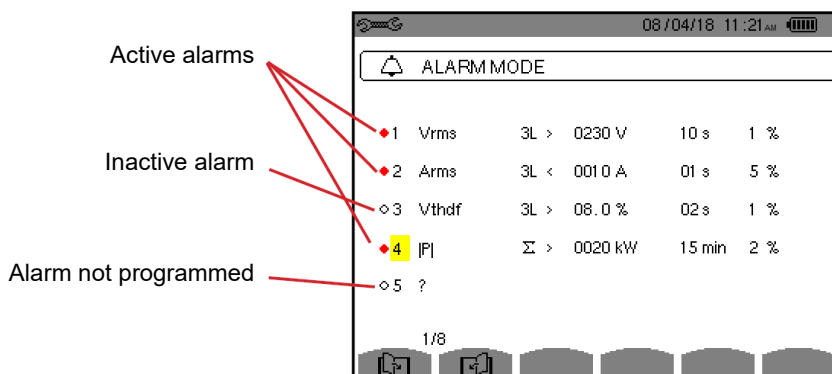





Figure 4-22

To set an alarm, select the following values:

- Type of alarm.
- Order of the harmonic (between 0 and 50), for |S-h|, A-h, U-h and V-h only.
- Target of the alarm:
 - 3L: 3 phases monitored individually
 - N: monitoring of neutral
 - 4L: 3 phases and neutral monitored individually
 - Σ : surveillance of the value of the complete system
- Direction of the alarm (>or <), for Hz, Urms, Vrms, Arms, |Udc|, |Vdc|, |Adc|, |Upk+|, |Vpk+|, |Apk+|, |Upk-|, |Vpk-| and |Apk-|.
- Triggering threshold (value and unit), for Urms, Vrms, Arms, |Udc|, |Vdc|, |Adc|, |Upk+|, |Vpk+|, |Apk+|, |Upk-|, |Vpk-|, |Apk-|, |P|, |Pdc|, |Q| or N, D and S.
- Minimum duration above or below the alarm threshold: in minutes, seconds, or also (for Vrms, Urms and Arms [excluding the neutral]) in hundredths of a second.
- Hysteresis: 1%, 2%, 5% or 10%.

To go from one page to the other, press the  or  button.

Each overshoot of an alarm will be recorded in a campaign of alarms.

 **NOTE:** Alarms appear in red if the configured quantity and/or target is incompatible with the selected configuration (connection selected, sensors connected, ratios programmed, or calculation methods chosen).

Alarms on the level of harmonics of order 01 apply only to values expressed in %r.

If a search for alarms is in progress, the activated alarms cannot be modified and are identified by black spots. However, new alarms (not yet programmed or not activated) can be activated.

To return to the Configuration menu, press .

4.11. ERASE MEMORY

The  Erase Memory menu partially or totally deletes the data recorded in the instrument.

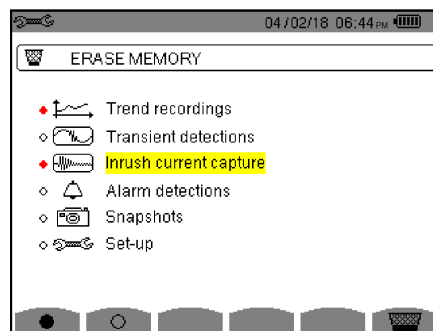









Figure 4-23

To select an item to be erased, move the yellow cursor to it using the , ,  and  buttons, then validate with the  button. The item to be erased is identified by a red spot.

To select all items, press .

To deselect all items, press .

To proceed with the erasure, press the , then confirm with the  button.

To return to the Configuration menu, press .

 **NOTE:** Which erasures are possible depends on the recordings in progress (recording, metering of energy, search for transients, alarms, and/or inrush current acquisition).

4.12. ABOUT

The  About screen displays information concerning the instrument.

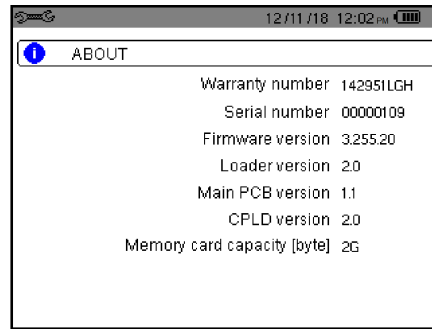



Figure 4-24

To return to the Configuration menu, press .

5. WAVEFORM CAPTURE

The  Waveform capture mode displays and captures transients and inrush currents. It contains two sub-modes:

- Transient mode (§5.1)
- Inrush current mode (§5.2)

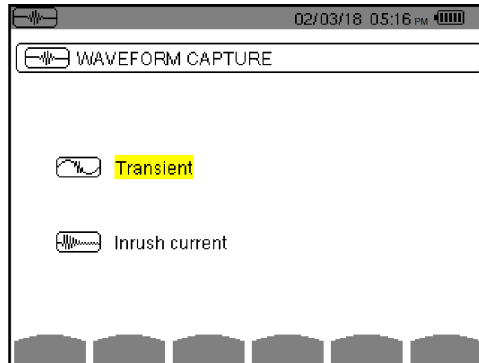



Figure 5-1

To select a sub-mode, move the yellow cursor to it using the ▲ and ▼ buttons, then validate with the ↵ button.

To return to the Waveform capture screen, press ↶.

5.1. TRANSIENT MODE

The  Transient mode is used to record transients, to look up the list of recorded searches and the list of transients they contain, or erase them. You can record up to 7 detections and 210 transients.

When the Transient mode is invoked:

- If no recording has been made, the Detection Schedule screen is displayed (Figure 5-2).
- If transients have been recorded, the Detection List is displayed (Figure 5-3).

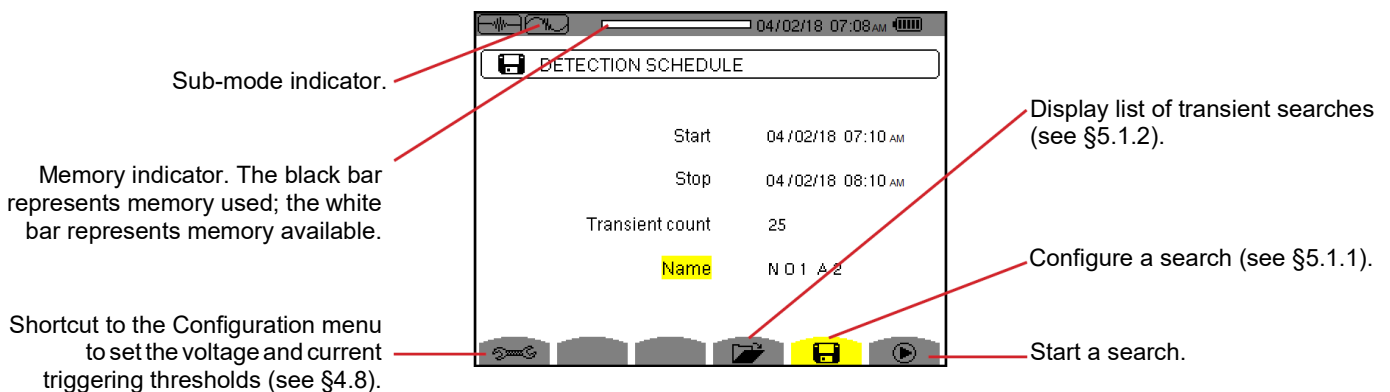

Figure 5-2

5.1.1. CONFIGURING AND STARTING A SEARCH

To configure a search for a transient, enter:

- Start date and time
- Stop date and time
- Number of transients to search for
- Name of search

To change an item, move the yellow cursor to it using the ▲ and ▼ buttons, then validate with the ↵ button. Change the value using the ▲, ▼, ◀ and ▶ buttons, then validate again.

The name can be up to 8 characters long (uppercase letters and numbers 0 through 9). Different searches can have the same name. The last 5 names assigned (in the transient, trend, and alarm modes) are kept in memory. When a name is entered, it may then be completed automatically.



NOTE: The start date and time must be later than the current date and time.
The stop date and time must be later than the start date and time.

When configuration is complete, start the search by pressing the ▶ button. The ▶ status bar icon blinks to indicate that the search has started. The ⏏ button replaces the ▶ button and can be used to stop the search before it is finished.

The message **Detection on standby** is displayed until the start time is reached. It is then replaced by the message **Detection in progress**. When the stop time is reached, the Detection Schedule screen returns with the ▶ button. You can then configure another search.

During a search for transients, only the stop date field can be modified. It is automatically highlighted in yellow.

To return to the Waveform Capture screen, press ↶.

5.1.2. DISPLAYING A TRANSIENT

To display the recorded transients, press 📄. The Detection List screen is displayed.

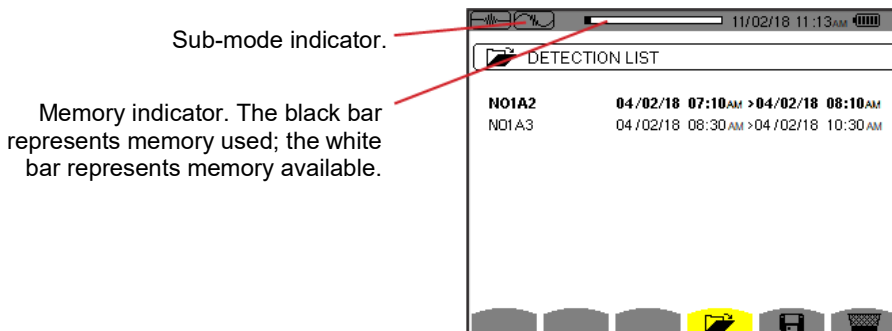

Figure 5-3

If the stop date is in red, it does not match the configured stop date, due to either:

- power supply problem (battery low or disconnection of the instrument supplied by external power only)
- the maximum number of transients has been reached, thereby ending the search

To select a search for transients, move the cursor to it using the ▲ and ▼ buttons. The selected search is bolded. Then validate with the ↵ button. The instrument then displays a list of transients.

Triggering channel of the transient.
 Transient number.
 Name of the search for transients.
 Activates or deactivates the choice of a transient list display filter.

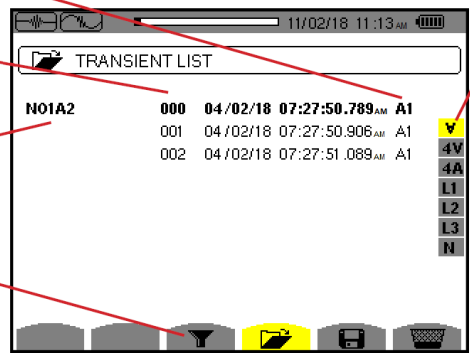

Transients display filter:
 ▼: all transients are displayed.
 V: transients triggered by an event in one of the 4 voltage channels are displayed.
 A: transients triggered by an event in one of the 4 current channels are displayed.
 1, L2, or L3: transients triggered by an event on a particular phase are displayed (voltage or current).
 I: transients triggered by an event on the neutral current or neutral voltage are displayed

Figure 5-4

To select a transient, move the cursor to it using the ▲ and ▼ buttons. The selected field is bolded. Then validate with the ↵ button. The instrument displays the transients in the form of graphs.

Location in the record of the zone displayed.
 Move the cursor to one period of the signal before the transient triggering time.
 Move the cursor to the transient triggering time.

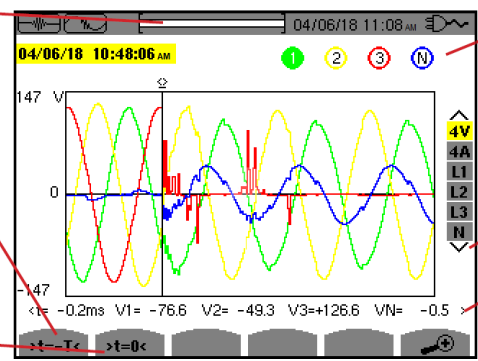

Indicates number assigned to displayed graph. In this example circle 1 is filled in to indicate channel V1 triggered capture of the transient.
 Select graphs to display.
 Instantaneous value of the signals according to the position of the cursor on the scale. To move the cursor, use the ◀ or ▶ button.

Figure 5-5



NOTE: The graphs selection filter is dynamic and depends on the selected connection. For example, the filter displays (3U, 3A) for a 3-wire three-phase set-up.

To return to the Transient list screen, press ↶.

5.1.3. DELETING A SEARCH FOR TRANSIENTS

When the list of searches for transients is displayed (see Figure 5-3), select the search to be erased. Move the cursor to it using the ▲ and ▼ buttons. The selected search is bolded. Then press the 🗑️ button. Press ↵ to validate or ↶ to cancel.



NOTE: A search for transients can be deleted only if it is not in progress.

To return to the Waveform capture screen, press the ↷ button.

5.1.4. DELETE A TRANSIENT

When the list of transients in a search is displayed (see Figure 5-4), select the transient to be erased. Move the cursor to it using the ▲ and ▼ buttons. The selected transient is bolded. Then press the 🗑️ button. Press ↵ to validate or ↶ to cancel.

To return to the Waveform capture screen, press the ↷ button.

5.2. INRUSH CURRENT MODE

The  Inrush Current sub-mode lets you capture (record) inrush currents (voltage and current waveforms, network frequency, half-cycle RMS voltages and currents except for the neutral), view, and delete the recordings.

When you open Inrush Current mode:

- If no capture has been made, the Capture Schedule screen (Figure 5-6) is displayed.
- If a capture has been made, then the Capture Parameters screen (Figure 5-7) is displayed.

5.2.1. CONFIGURING THE CAPTURE

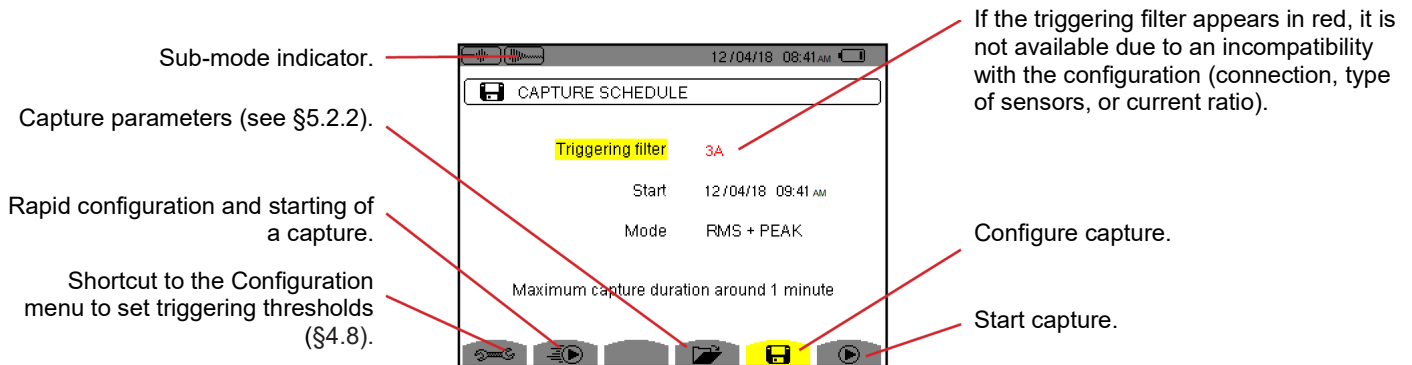



Figure 5-6

Press the  button to start recording immediately with a current threshold of 0 A and a hysteresis of 100%.



NOTE: The rapid starting of an inrush current modifies the configuration of the current threshold.

To configure a capture, enter the triggering filter (3A, A1, A2, or A3), the start date and time, and the recording mode (**RMS + PEAK** or **RMS only**).





- **RMS + PEAK** recording mode produces a trend recording of the half-period RMS values and a trend recording of the samples (envelopes and waveforms). The maximum duration of the recording depends on the frequency network and is on average about one minute.
- In **RMS only** recording mode, recording of samples is eliminated in favor of a longer maximum capture duration.

This mode records only the half-period RMS values and its maximum duration is about ten minutes.

To modify an item, move the yellow cursor to it using the ▲ and ▼ buttons, then validate with the ↵ button. Change the value using the ▲, ▼, ◀ and ▶ buttons, then validate again.



NOTE: You cannot configure an alarm campaign if an inrush current capture is in progress.

After configuration, start the capture by pressing the  button. The  status bar icon blinks to indicate that the capture has started. The  button replaces the  button and can be used to stop the capture before it is finished.



NOTE: To achieve a valid measurement, the voltage must be present and stable before starting an InRush current measurement.

The message “capture pending” is displayed until the start time is reached and the triggering conditions are satisfied. It is then replaced by the message “capture in progress.” The memory status indicator appears at the top of the screen. This indicator disappears when the capture is completed.



If the capture is completed with a stop event or if instrument recording memory is full, the capture stops automatically.



NOTE: The instrument can store only a single inrush current capture in memory. To make another capture, delete the previous one.

To return to the Waveform capture screen, press .

5.2.2. CAPTURE PARAMETERS

To display the characteristics of the capture, press . The Capture Parameters screen is displayed.

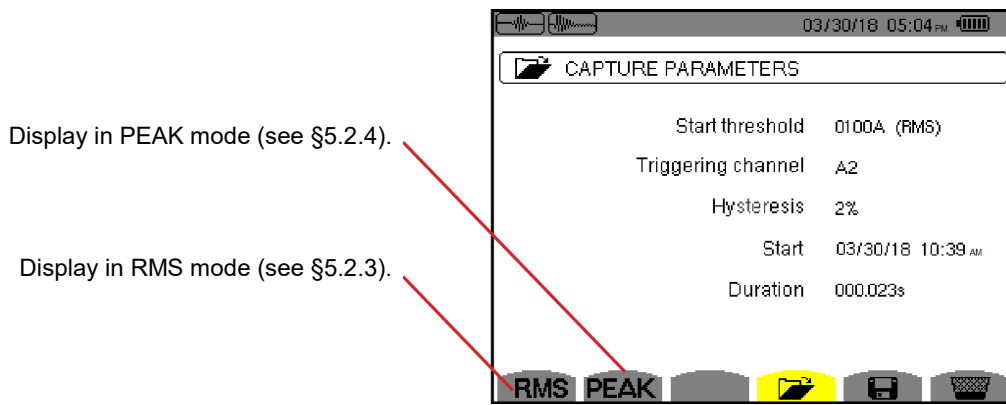

Figure 5-7

If a capture duration is displayed in red, it has been cut short due to one of the following:

- power supply problem (battery low)
- memory is full
- measurement error
- incompatibility between the quantity monitored and the configuration of the instrument (for example removal of a current sensor)

Choose the type of display, **RMS** or **PEAK**, by pressing the yellow button corresponding to the icon. The instrument then displays the graphs.

NOTE: The PEAK button is not displayed when the inrush current capture recording mode is RMS only.

5.2.3. TRUE RMS CURRENT AND VOLTAGE

The RMS mode displays the record of the trend of the true half-cycle RMS current and voltage and the frequency trend graph.

The display depends on the type of selection filter:

3V: displays the 3 voltages during the inrush current capture for set-ups with neutral.

3U: displays the 3 voltages during the inrush current capture for set-ups without neutral.

3A: displays the 3 currents during the inrush current capture.

L1, L2, L3: display the current and voltage in phases 1, 2 and 3 respectively (for set-ups with neutral only).

Hz: displays the evolution of the network frequency vs. time.

Below are three examples of display.

5.2.3.1. 3A RMS display screen for a three-phase connection with neutral

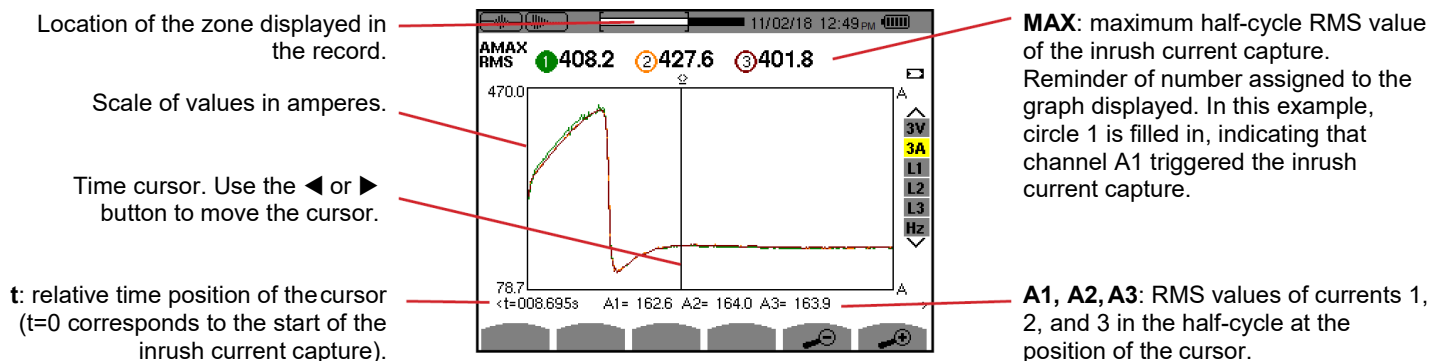

Figure 5-8

5.2.3.2. 3A RMS display screen for a three-phase connection without neutral

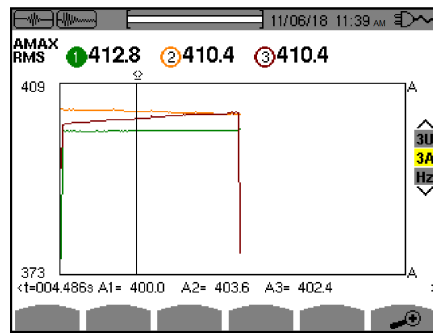
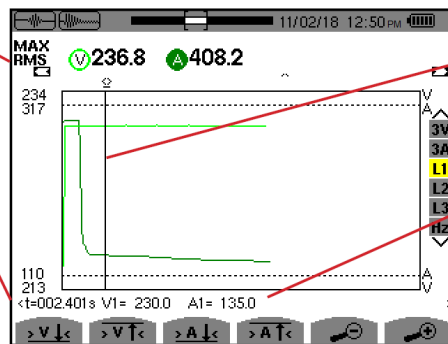

Figure 5-9

5.2.3.3. L1 RMS display screen for a three-phase connection with neutral

MAX: maximum half-cycle RMS value of the inrush current capture.

t: relative time position of the cursor (t=0 corresponds to the start of the inrush current capture).



Time cursor of the graph. Use the ◀ or ▶ button to move the cursor.

V1: RMS value of voltage 1 in the half-cycle at the position of the cursor.
A1: RMS value of current 1 in the half-cycle at the position of the cursor.

Figure 5-10

NOTE: Filters L2 and L3 display the recording of the true half-cycle RMS current and voltage of phases 2 and 3. The screen is identical to the one displayed for filter L1.

The $\overline{V} \downarrow \leftarrow$, $\overline{V} \uparrow \leftarrow$, $\overline{A} \downarrow \leftarrow$ and $\overline{A} \uparrow \leftarrow$ buttons move the cursor to the first occurrence of a minimum or maximum voltage or current value.

5.2.3.4. RMS display screen in Hz for a three-phase connection without neutral

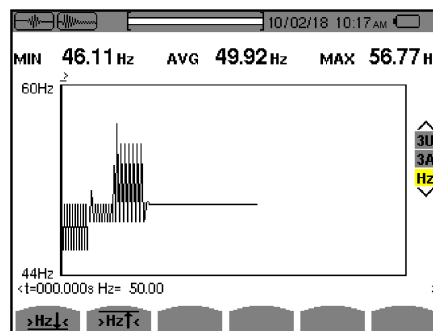

Figure 5-11

The $\overline{Hz} \downarrow \leftarrow$ and $\overline{Hz} \uparrow \leftarrow$ buttons go to the first occurrence of a minimum or maximum frequency value.

5.2.4. INSTANTANEOUS INRUSH CURRENT

PEAK mode displays the envelopes and waveforms of the inrush current capture. The PEAK display of an inrush current capture provides two possible representations:

- envelope
- waveform

The change from one of these representations to the other is automatic, as a function of the zoom level. If the zoom in is high enough, the representation is of the “waveform” type.

The display depends on the type of display filter:

4V: displays the 4 voltages during the inrush current capture for set-ups with neutral (for a waveform type display only).

3U: displays the 3 voltages during the inrush current capture for set-ups without neutral (for a waveform type display only).

4A: displays the 4 currents during the inrush current capture (for a waveform type display only).

L1, L2 or L3: display the voltage and current of phases 1, 2, and 3, respectively (only for set-ups with neutral and for a waveform type display).

N: displays the neutral current and neutral voltage during the inrush current capture (for a waveform type display only).

V1, V2, V3: displays the 3 voltages during the inrush current capture for set-ups with neutral (for an envelope type display only).

U1, U2, U3: displays the 3 voltages during the inrush current capture for set-ups without neutral (for an envelope type display only).

A1, A2, A3: displays the 3 currents during the inrush current capture (for an envelope type display only).

Below are three examples of display.

5.2.4.1. 4A PEAK display screen for a 5-wire three-phase connection

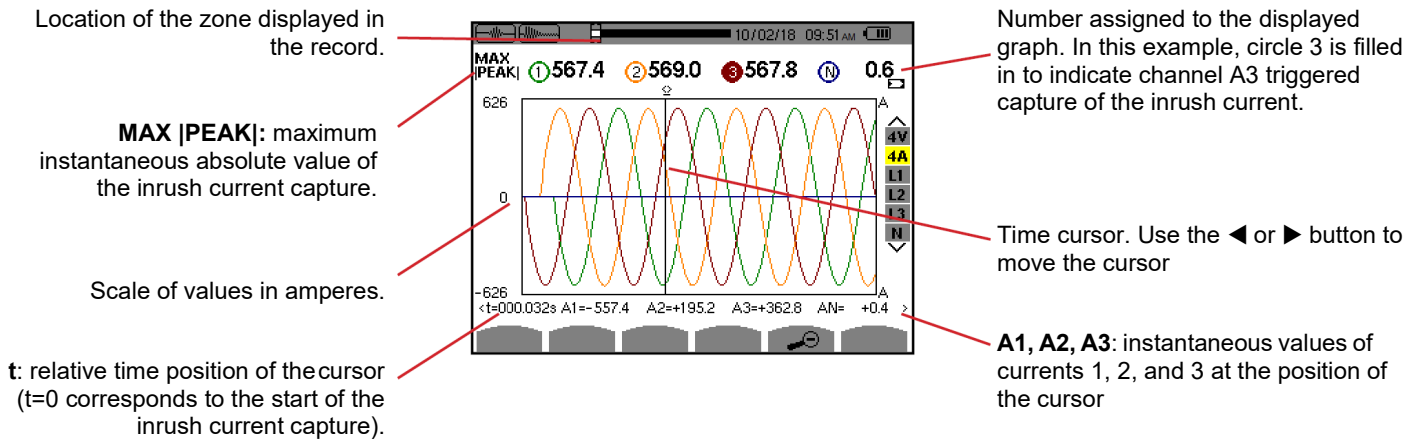

Figure 5-12

5.2.4.2. 3A PEAK display screen for a 3-wire three-phase connection

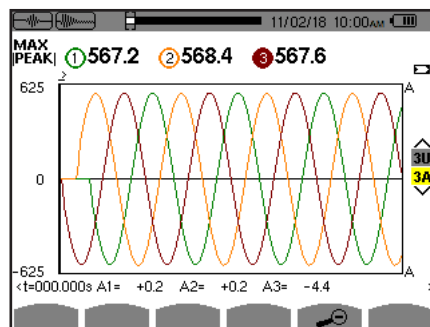

Figure 5-13

5.2.4.3. A1 PEAK display screen for a three-phase connection without neutral

In the example below, the image is zoomed out to the point the envelope type of display appears.

MAX |PEAK|: maximum instantaneous absolute value of the inrush current capture.

t: relative time position of the cursor (t=0 corresponds to the start of the inrush current capture).

A1: maximum instantaneous current of the half-cycle identified by the cursor.

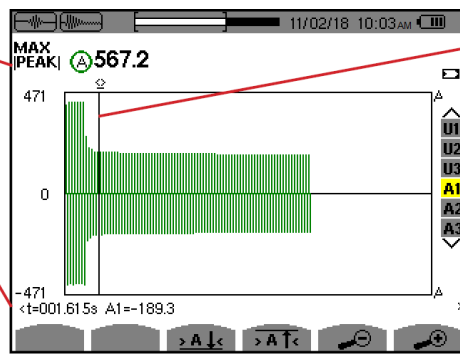

Time cursor of the graph. Use the \blacktriangleleft or \blacktriangleright button to move the cursor.

Figure 5-14

6. HARMONICS

Harmonics  mode displays harmonic levels of voltage, current, and apparent power, order by order. This lets you determine the harmonic currents produced by nonlinear loads, and analyze problems caused by harmonics according to their order (overheating of neutrals, conductors, motors, etc.).

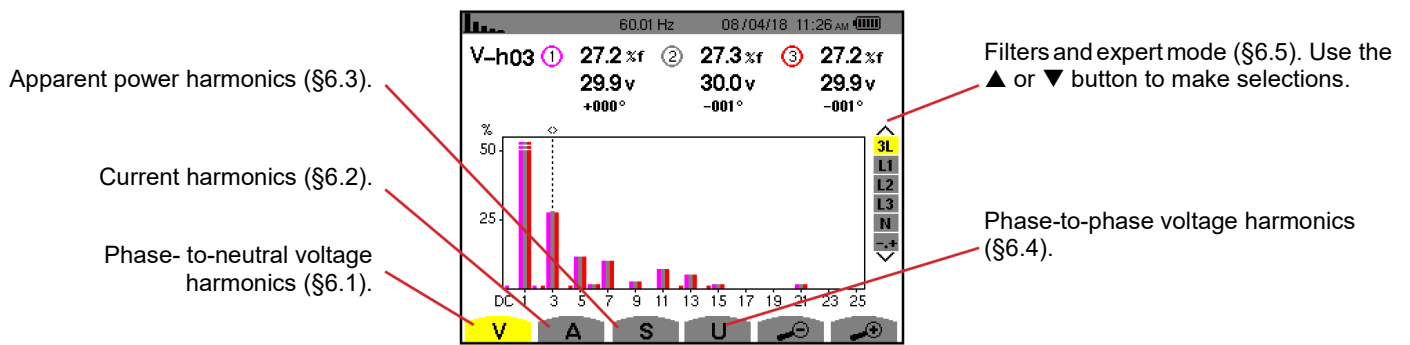

Figure 6-1

6.1. PHASE-TO-NEUTRAL VOLTAGE

The **V** sub-menu displays the harmonics of the phase-to-neutral voltage only for sources having a neutral.

The choice of graphs to be displayed depends on the type of connection (see §4.6):

- Single-phase, 2-wire: no choice (L1)
- Single-phase, 3-wire: L1, N
- Split-phase, 3-wire: 2L, L1, L2
- Split-phase, 4-wire: 2L, L1, L2, N
- Three-phase, 4-wire: 3L, L1, L2, L3, -, +
- Three-phase, 5-wire: 3L, L1, L2, L3, N, -, +

The screen captures shown as examples below are those obtained with a 5-wire three-phase connection.

6.1.1. 3L PHASE-TO-NEUTRAL VOLTAGE HARMONICS DISPLAY SCREEN

Information about the harmonic at the cursor position.

V-h03: harmonic number.

%: level of harmonics with the fundamental RMS value as reference (%f) or the (total) RMS value as reference (%r).

V: RMS voltage of the harmonic in question.

+000°: phase shift with respect to the fundamental (order 1).

Harmonic selection cursor. Use the ◀ or ▶ button to move the cursor.

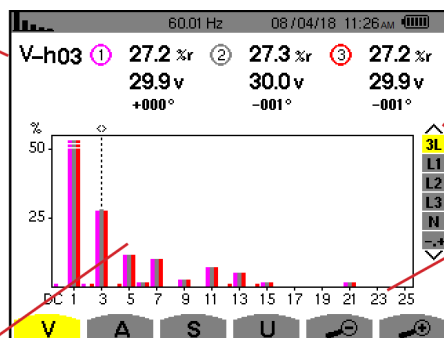

Display of 3 phases 3L, of L1, L2, L3, N, or of expert mode (three-phase connection only – see §6.5). To select the display press the ▲ or ▼ button.

Horizontal axis indicates the orders of the harmonics. The level of the harmonic is calculated as a percentage with respect to the fundamental or to the total RMS value.

DC: DC component.

1 to 25: harmonics of order 1 to 25. When the cursor exceeds order 25, orders 26 to 50 appear.

Figure 6-2

6.1.2. L1 PHASE VOLTAGE HARMONICS DISPLAY SCREEN

Information about the harmonic at the cursor position.

V-h03: harmonic number.

%: level of harmonics with the fundamental RMS value as reference (%f) or the (total) RMS value as reference (%r).

V: RMS voltage of the harmonic in question.

-143°: phase shift with respect to the fundamental (order 1).

max – min: maximum and minimum levels of the harmonic in question. They are reset when the harmonic number is changed or the \leftarrow button is pressed.

THD: total harmonic distortion.

Vd: RMS distortion voltage.

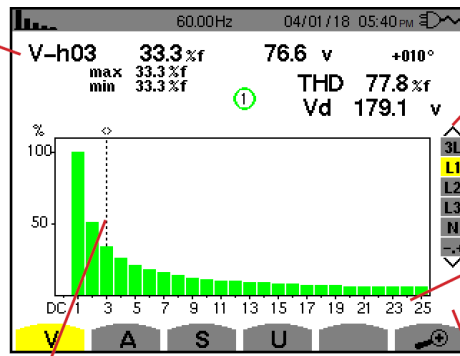

Harmonic selection cursor. Use the \leftarrow or \rightarrow button to move the cursor

Indicator of the presence of non-zero harmonics of order higher than 25

Display of the 3 phases 3L, of L1, L2, L3, N, or of the expert mode (three-phase connection only - see §6.5). To select the display press \blacktriangle or \blacktriangledown .

The horizontal axis indicates the orders of the harmonics. The level of the harmonic is given as a percentage with respect to the fundamental or to the total RMS value.

DC: DC component.

1 to 25: harmonics of order 1 to 25. When the cursor exceeds order 25, order 26 to 50 appears.

Figure 6-3

NOTES: Filters L2 and L3 display the harmonics of the phase-to-neutral voltage for phases 2 and 3, respectively. The screen is identical to the one displayed for filter L1. There is no phase shift or distortion value for the neutral channel.

6.2. CURRENT

The **A** sub-menu displays harmonics of the current.

6.2.1. 3L CURRENT HARMONICS DISPLAY SCREEN

Information about the harmonic at the cursor position.

A-h05: harmonic number.

%: level of harmonics with the fundamental RMS value as reference (%f) or the (total) RMS value as reference (%r).

A: RMS current of the harmonic in question.

+179°: phase shift with respect to the fundamental (order 1).

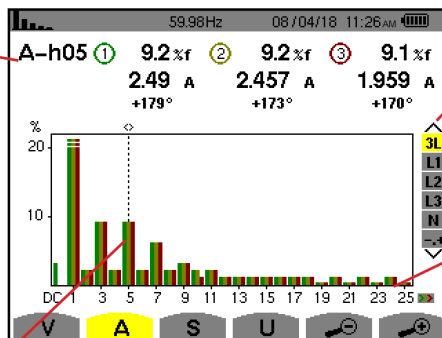

Harmonic selection cursor. Use the \leftarrow or \rightarrow button to move the cursor.

Display of the 3 phases 3L, of L1, L2, L3, N, or of the expert mode (three-phase connection only – see §6.5). To select the display press \blacktriangle or \blacktriangledown .

The horizontal axis indicates the orders of the harmonics. Harmonic level is shown as a percentage with respect to the fundamental or to the total RMS.

Rang DC: DC component.

1 to 25: harmonics of order 1 to 25. When the cursor exceeds order 25, order 26 to 50 appears.

Figure 6-4

6.2.2. L1 CURRENT HARMONICS DISPLAY SCREEN

Information about the harmonic at the cursor position.

- A-h05**: harmonic number.
- %**: level of harmonics with the fundamental RMS value as reference (%f) or the (total) RMS value as reference (%r).
- A**: RMS current of the harmonic in question.
- +178°**: phase shift with respect to the fundamental (order 1).
- max – min**: maximum and minimum levels of the harmonic. They are reset when the harmonic number is changed or the ↵ button is pressed
- THD**: total harmonic distortion.
- Ad**: RMS distortion current.

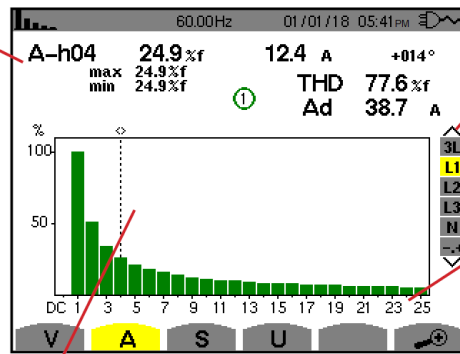

Harmonic selection cursor. Use the ◀ or ▶ button to move the cursor

Display of the 3 phases 3L, of L1, L2, L3, N, or of the expert mode (three-phase connection only - see §6.5). To select the display press ▲ or ▼.

The horizontal axis indicates the orders of the harmonics. The level of the harmonic is given as a percentage with respect to the fundamental or to the total RMS value.
Rang DC: DC component.
1 to 25: harmonics of order 1 to 25. When the cursor exceeds order 25, order 26 to 50 appears.

Figure 6-5



NOTE: Filters L2 and L3 display the current harmonics of phases 2 and 3, respectively. The screen is identical to the one displayed for filter L1.

There is no phase shift or distortion value for the neutral channel.

6.3. APPARENT POWER

The **S** sub-menu displays the harmonics of the apparent power, for all connections except 3-wire three-phase.

The horizontal axis indicates the orders of the harmonics. The bars of the bar chart above the horizontal centerline signify harmonic power consumed, those below it harmonic power generated.

6.3.1. 3L APPARENT POWER HARMONICS DISPLAY SCREEN

Information about the harmonic at the cursor position.

- S-h03**: harmonic number.
- %**: level of harmonics with the fundamental apparent power as reference (%f) or the (total) apparent power as reference (%r).
- +006°**: phase shift of the voltage harmonic with respect to the current harmonic for the order in question.
- Indicator of energy generated for this harmonic.
- Indicator of energy consumed for this harmonic.

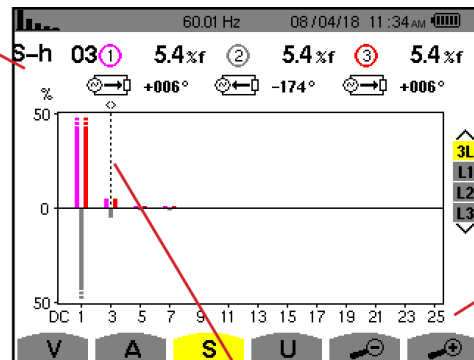

Harmonic selection cursor. Use the ◀ or ▶ button to move the cursor

Display of the 3 phases 3L, of L1, L2 or L3. To select the display press the ▲ or ▼ button

The horizontal axis indicates the orders of the harmonics. The level of the harmonic is given as a percentage of the fundamental apparent power or the (total) apparent power.
Rang DC: DC component.
1 to 25: harmonics of order 1 to 25. When the cursor exceeds order 25, order 26 to 50 appears.

Figure 6-6

6.3.2. L1 APPARENT POWER HARMONICS DISPLAY SCREEN

Information about the harmonic at the cursor position.

- S-h03**: harmonic number.
- %**: level of harmonics with the fundamental apparent power as reference (%f) or the (total) apparent power as reference (%r).
- +045°**: phase shift of the voltage harmonic with respect to the current harmonic for the order in question.
- min-max**: maximum and minimum levels of the harmonic in question. They are reset when the harmonic number is changed or the \leftarrow button is pressed.

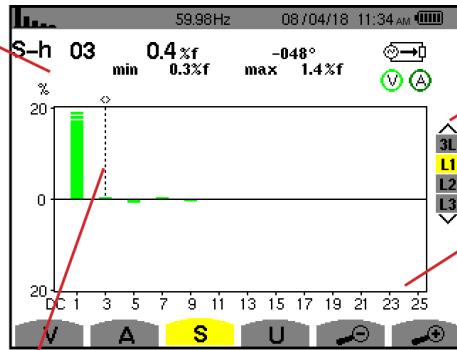

Harmonic selection cursor. Use the \leftarrow or \rightarrow button to move the cursor

Display of the 3 phases 3L, of L1, L2 or L3. To select the display press the \blacktriangle or \blacktriangledown button

Horizontal axis indicates the orders of the harmonics. The level of the harmonic is given as a percentage of the fundamental apparent power or the (total) apparent power.
Rang DC: DC component.
1 to 25: harmonics of order 1 to 25. When the cursor exceeds order 25, order 26 to 50 appears.
: Indicator of energy consumed for this harmonic

Figure 6-7

NOTE: Filters L2 and L3 display the apparent power of the harmonics for phases 2 and 3, respectively. The screen is identical to the one displayed for filter L1.

6.4. PHASE-TO-PHASE VOLTAGE

The **U** sub-menu is available for all connections except 2- or 3-wire single-phase. This sub-menu displays the harmonics of the phase-to-phase voltage.

6.4.1. 3L PHASE-TO-PHASE VOLTAGE HARMONICS DISPLAY SCREEN

Information about the harmonic at the cursor position.

- U-h03**: harmonic number.
- %**: level of harmonics with the fundamental RMS value as reference (%f) or the (total) RMS value as reference (%r).
- V**: RMS voltage of the harmonic in question.
- +000°**: phase shift with respect to the fundamental (order 1).

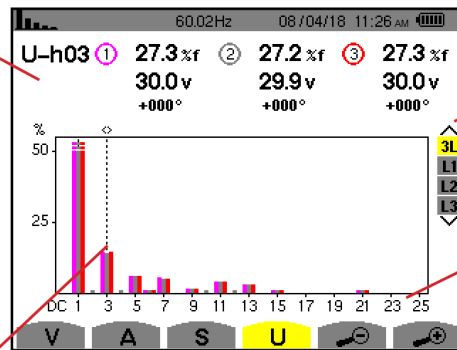

Harmonic selection cursor. Use the \leftarrow or \rightarrow button to move the cursor

Display of the 3 phases 3L, of L1, L2 or L3. To select the display press the \blacktriangle or \blacktriangledown button.

Horizontal axis indicates the orders of the harmonics. The level of the harmonic is given as a percentage with respect to the fundamental or to the total RMS value.
Rang DC: DC component.
1 to 25: harmonics of order 1 to 25. When the cursor exceeds order 25, order 26 to 50 appears

Figure 6-8

6.4.2. L1 PHASE-TO-PHASE VOLTAGE HARMONICS DISPLAY SCREEN

Information about the harmonic at the cursor position.

Uh 03: harmonic number.

%: level of harmonics with the fundamental RMS value as reference (%f) or the (total) RMS value as reference (%r).

V: RMS voltage of the harmonic in question.

+000°: phase shift with respect to the fundamental (order 1).

max – min: indicators of the maximum and minimum of the level of harmonics or by pressing the \leftarrow button.

THD: total harmonic distortion.

Ud: phase-to-phase RMS distortion voltage.

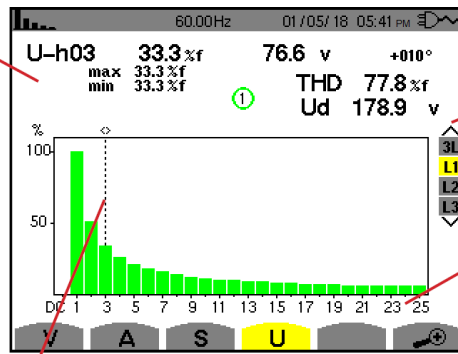

Display of the 3 phases 3L, of L1, L2 or L3. To select the display press the \blacktriangle or \blacktriangledown button.

Horizontal axis indicates the orders of the harmonics. The level of the harmonic is given as a percentage with respect to the fundamental or to the total RMS value.

Rang DC: DC component.

1 to 25: harmonics of order 1 to 25. When the cursor exceeds order 25, order 26 to 50 appears.

Harmonic selection cursor. Use the \blacktriangleleft or \blacktriangleright button to move the cursor

Figure 6-9



NOTE: Filters L2 and L3 display the phase-to-phase voltage harmonics for phases 2 and 3, respectively. The screen is identical to the one displayed for filter L1.

6.5. EXPERT MODE

Expert $\left[-;+\right]$ mode is available with a three-phase connection only. It displays the influence of the harmonics on the heating of the neutral and on rotating machines. To display Expert mode, select $\left[-;+\right]$ from a harmonics display screen by pressing the \blacktriangle or \blacktriangledown button. The selection is highlighted in yellow and the screen simultaneously displays Expert mode.

From this screen, two sub-menus are available:

- 1 **V** for three-phase set-ups with neutral or **U** for the three-phase set-up without neutral.
- 2 **A** for the expert mode in current.



NOTE: The breakdown into sequences shown below is valid only for balanced loads.

6.5.1. PHASE-TO-NEUTRAL VOLTAGE EXPERT MODE DISPLAY SCREEN

For three-phase set-ups with neutral, the **V** sub-menu displays the influence of the harmonics of the phase-to-neutral voltage on the heating of the neutral and on rotating machines.

Harmonics inducing a negative sequence.

Harmonics inducing a zero sequence.

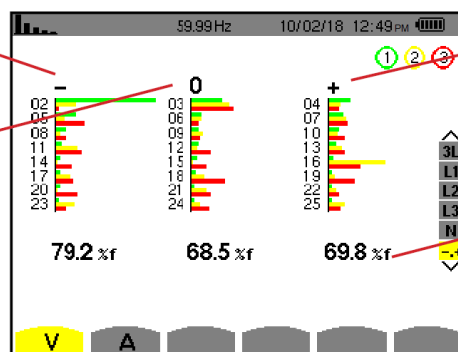

Harmonics inducing a positive sequence.

%: level of harmonics with the fundamental RMS value as reference (%f) or the (total) RMS value as reference (%r).

Figure 6-10

For three-phase set-ups without neutral, the **U** sub-menu displays the influence of the harmonics of the phase-to-phase voltage on the heating of revolving machines.

6.5.2. CURRENT EXPERT MODE DISPLAY SCREEN

The **A** sub-menu displays the influence of the harmonics of the current on the heating of the neutral and on rotating machines.

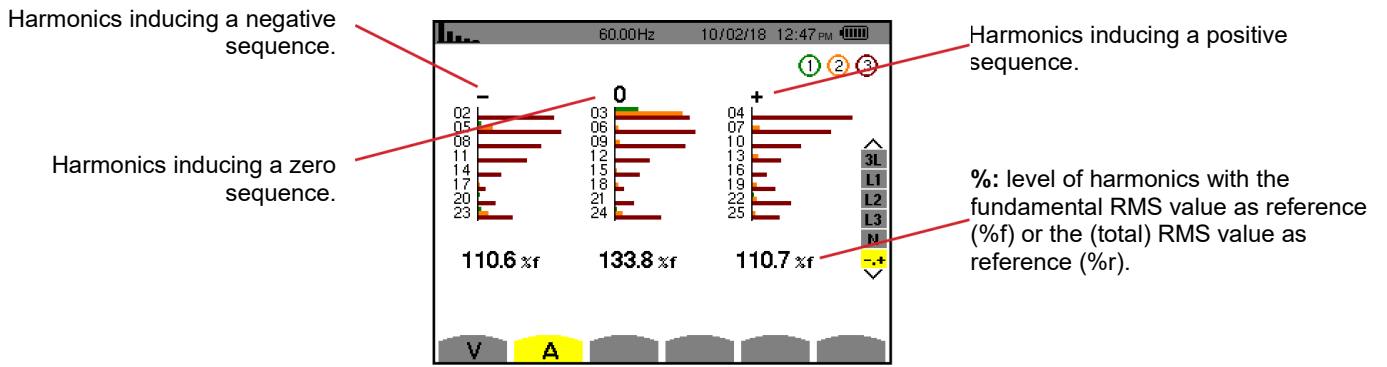



Figure 6-11

7. WAVEFORM

The Waveform  button displays current and voltage graphs, along with the values measured and those calculated from the voltages and currents (except for power, energy, and harmonics).

This is the first display screen that appears when the instrument is powered ON.

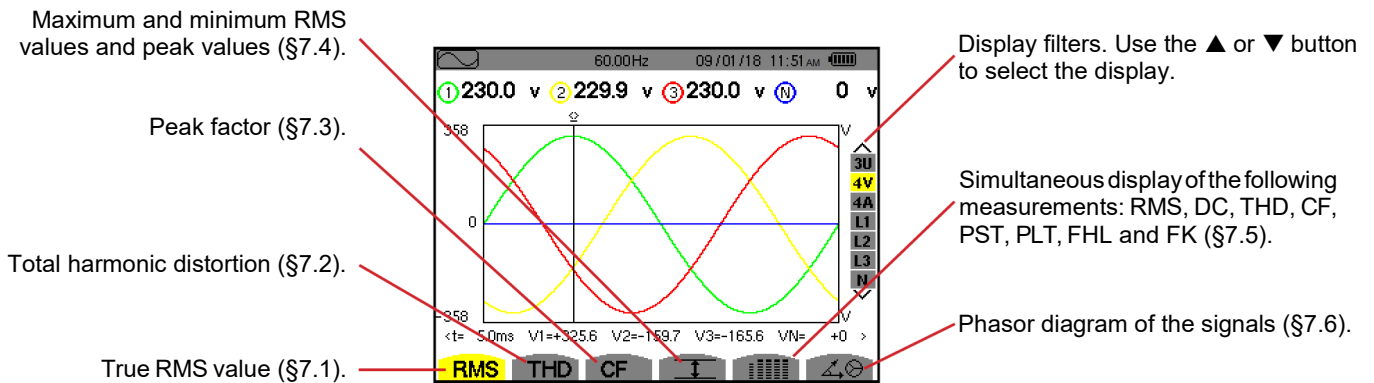













Figure 7-1

7.1. TRUE RMS

The **RMS** sub-menu displays the waveforms over one period of the signals measured and the true RMS voltage and current.

The choice of graphs to display depends on the type of connection (see §4.6):

- Single-phase, 2-wire or Split-phase, 2-wire: no choice (L1)
- Single-phase, 3-wire:
 - **RMS, THD, CF**,  and : 2V, 2A, L1, N
 - : no choice (L1)
- Split-phase, 3-wire:
 - **RMS, THD, CF**,  and : U, 2V, 2A, L1, L2
 - : 2V, 2A, L1, L2
- Split-phase, 4-wire:
 - **RMS, THD, CF**,  and : U, 3V, 3A, L1, L2 N
 - : 2V, 2A, L1, L2
- Three-phase, 3wire: 3U, 3A
- Three-phase, 4-wire: 3U, 3V, 3A, L1, L2, L3
- Three-phase, 5-wire:
 - **RMS, THD, CF**,  and : 3U, 4V, 4A, L1, L2, L3 and N
 - : 3U, 3V, 3A, L1, L2 and L3

The following examples were obtained with a three-phase 5-wire connection.

7.1.1. 3U RMS DISPLAY SCREEN

This screen displays the three phase-to-neutral voltages of a three-phase system.

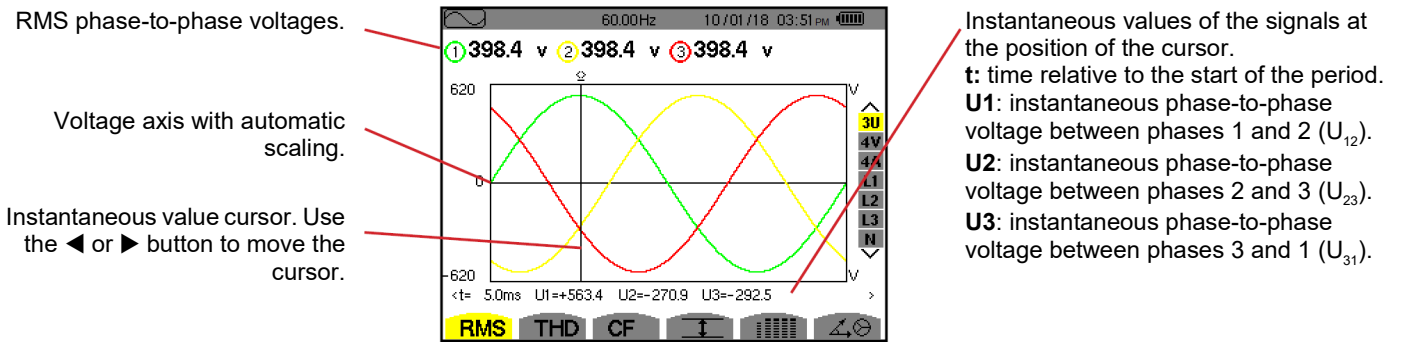

Figure 7-2

7.1.2. 4V RMS DISPLAY SCREEN

This screen displays the three phase-to-neutral voltages and the neutral-to-earth voltage of a three-phase system.

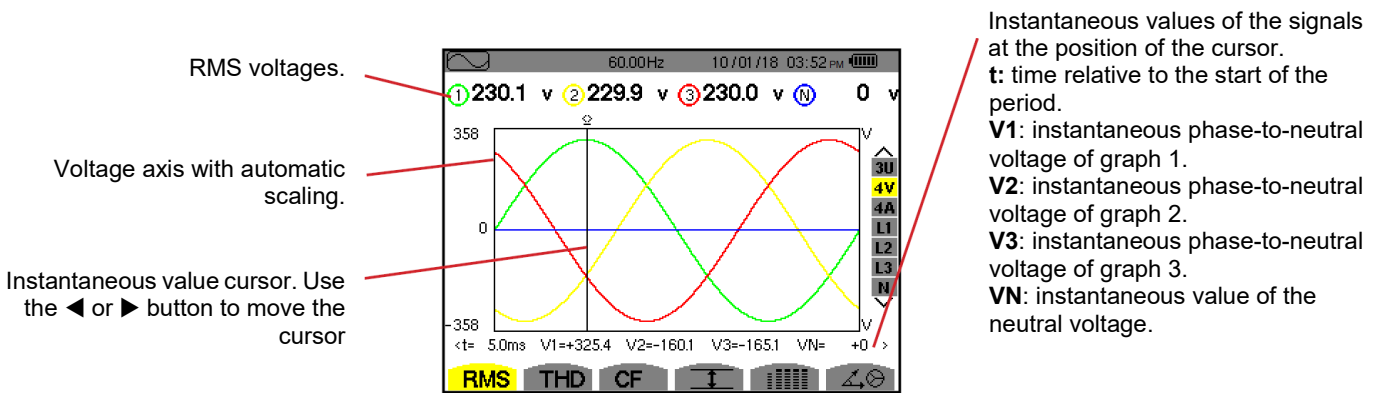

Figure 7-3

7.1.3. 4A RMS DISPLAY SCREEN

This screen displays the three phase currents and the neutral current of a three-phase system.

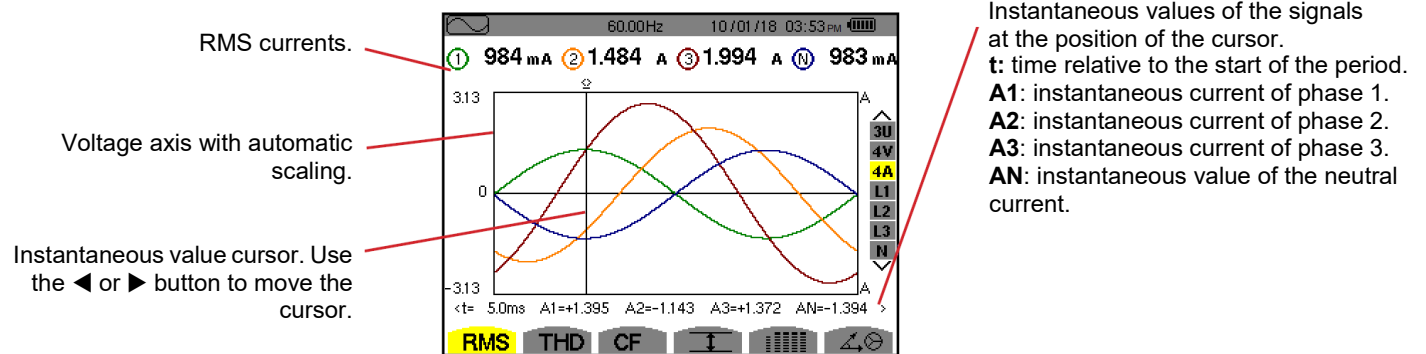

Figure 7-4

7.1.4. RMS DISPLAY SCREEN FOR THE NEUTRAL

This screen displays the neutral voltage with respect to earth and the neutral current.

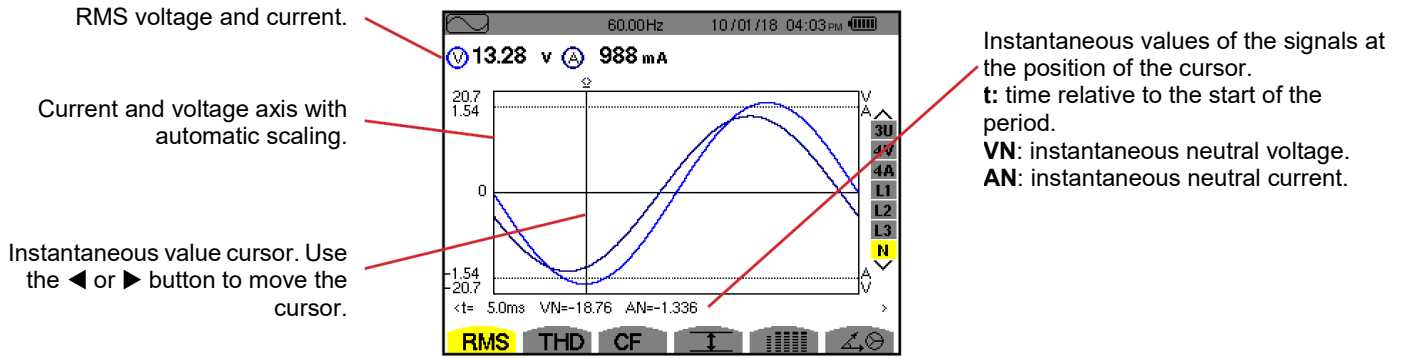

Figure 7-5



NOTE: Filters L1, L2, and L3 display the current and voltage in phases 1, 2, and 3, respectively. The screen is identical to the one displayed for the neutral.

7.2. TOTAL HARMONIC DISTORTION

The **THD** sub-menu displays the waveforms of the signals measured over one full cycle and the total voltage and current harmonic distortion. The levels are displayed either with the fundamental RMS value as reference (%f) or with the RMS value without DC as reference (%r), depending on which reference is chosen in the configuration menu.

7.2.1. 3U THD DISPLAY SCREEN

This screen displays the phase-to-phase voltage waveforms for one period and the total harmonic distortion values.

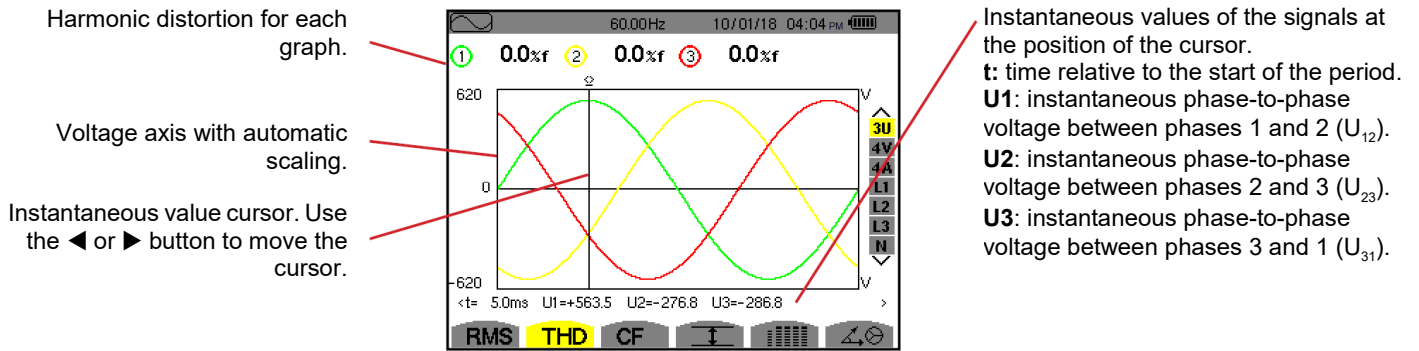

Figure 7-6

7.2.2. 4V THD DISPLAY SCREEN

This screen displays the phase-to-neutral voltage waveforms for one period and the total harmonic distortion values.

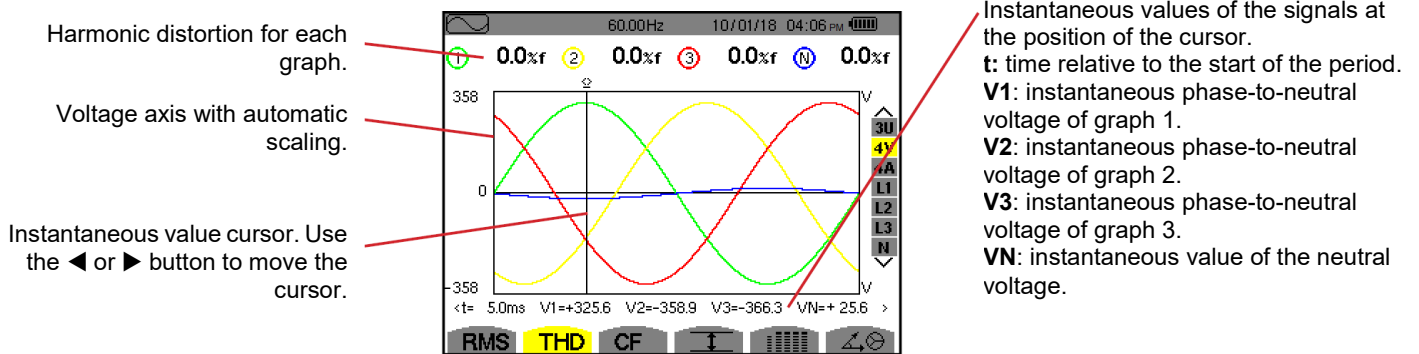

Figure 7-7

7.2.3. 4A THD DISPLAY SCREEN

This screen displays the phase current waveforms for one period and the total harmonic distortion values.

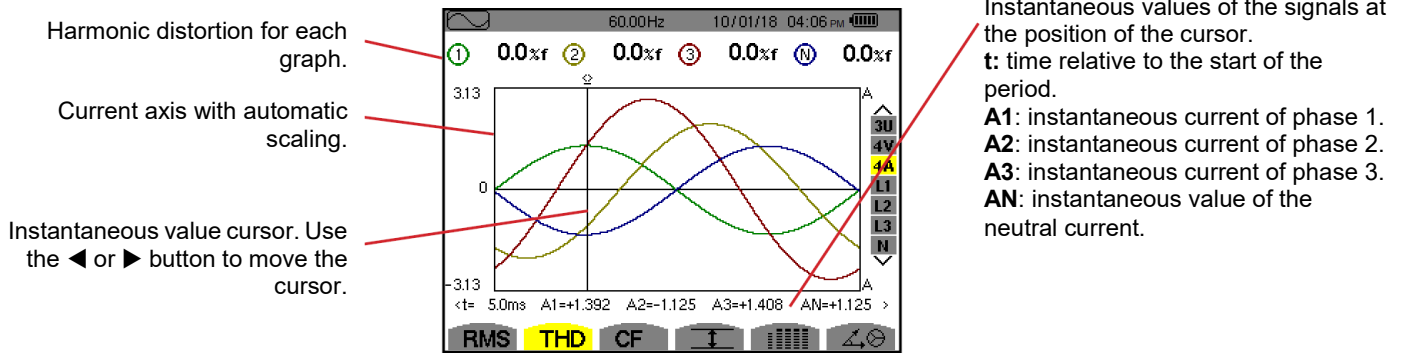

Figure 7-8

NOTE: Filters L1, L2, L3 and N display the total current and voltage harmonic distortion for phases 1, 2 and 3 and the neutral channel.

7.3. PEAK FACTOR

The CF sub-menu displays the waveforms of the signals measured over one period and the voltage and current peak factors.

7.3.1. 3U CF DISPLAY SCREEN

This screen displays the phase-to-phase voltage waveforms of one period and the peak factors.

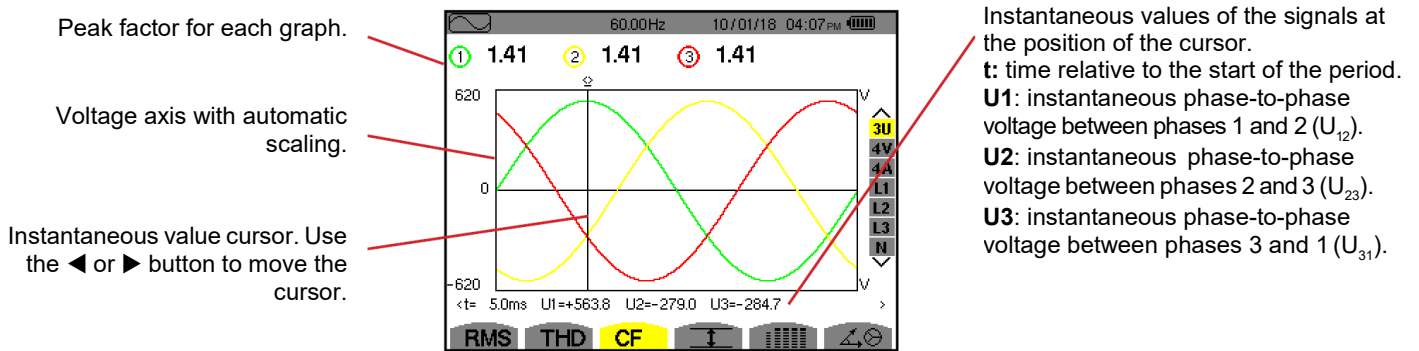

Figure 7-9

7.3.2. 4V CF DISPLAY SCREEN

This screen displays the phase-to-neutral voltage waveforms of one period and the peak factors.

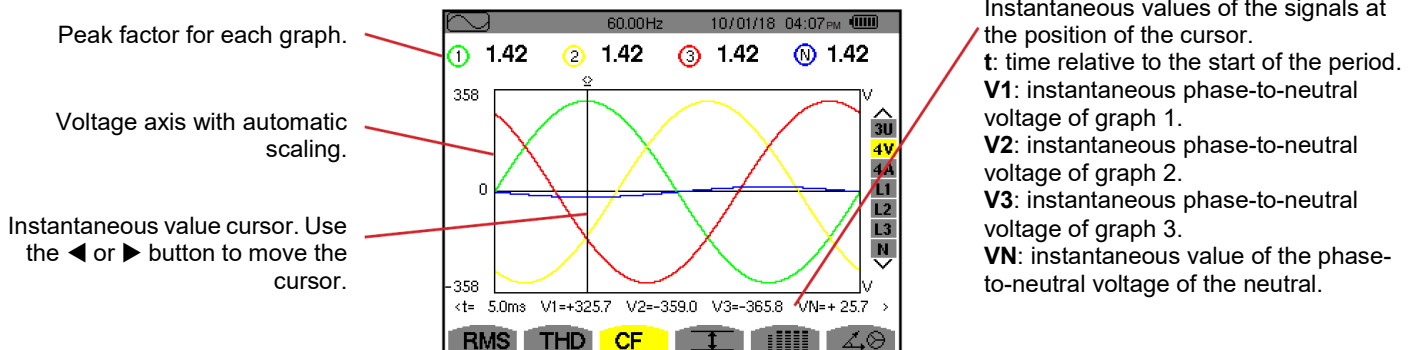

Figure 7-10

7.3.3. 4A CF DISPLAY SCREEN

This screen displays the current waveforms of one period and the peak factors.

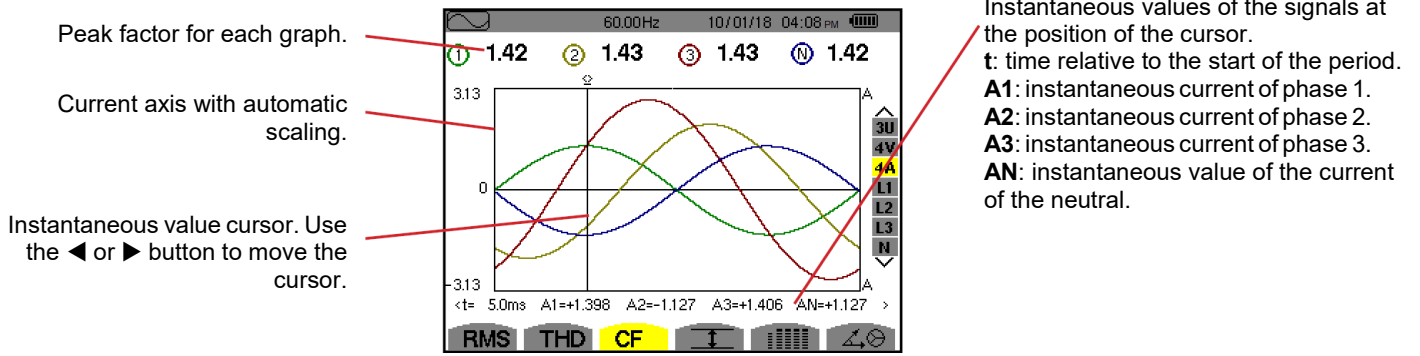

Figure 7-11



NOTE: L1, L2, L3 and N display the current and voltage peak factors for phases 1, 2 and 3, respectively and the neutral channel.

7.4. MAX - MIN AND MEAN VOLTAGE AND CURRENT

The sub-menu displays the one-second mean and half-cycle maximum and minimum RMS voltage and current and the instantaneous positive and negative peak voltage and current.



NOTE: The MAX and MIN RMS measurements are calculated every half cycle (i.e. every 10 ms for a 50-Hz signal). The measurements are refreshed every 250 ms.

The RMS measurements are calculated over one second.

7.4.1. 3U MAX-MIN DISPLAY SCREEN

This screen displays the one-second mean and half-cycle maximum and minimum RMS values and the positive and negative phase-to-phase voltage peaks.

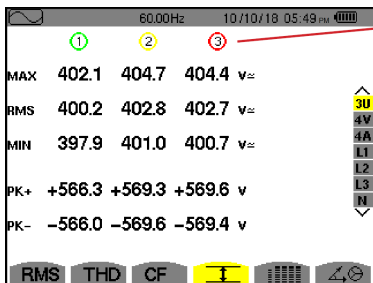

Figure 7-12

Columns of values for each graph (1, 2, and 3).

MAX: maximum RMS phase-to-phase voltage since the instrument was turned ON or since the last time the button was pressed.

RMS: true RMS phase-to-phase voltage.

MIN: minimum RMS phase-to-phase voltage since the instrument was turned ON or since the last time the button was pressed.

PK+: maximum (positive) peak phase-to-phase voltage since the instrument was turned ON or since the last time the button was pressed.

PK-: minimum (negative) peak phase-to-phase voltage since the instrument was turned ON or since the last time the button was pressed.

7.4.2. 4V MAX.-MIN. DISPLAY SCREEN

This screen displays the one-second mean and half-cycle maximum and minimum RMS values and the positive and negative peaks of the phase-to-neutral voltages and of the neutral.

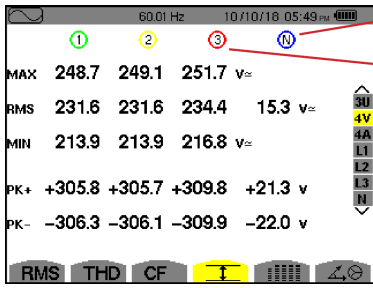

Figure 7-13

Column of values for the neutral: RMS, PEAK+ and PEAK- parameters.

Columns of values for each voltage graph (1, 2 and 3).

MAX: maximum RMS phase-to-neutral voltage since the instrument was turned ON or since the last time the ↵ button was pressed.

RMS: true RMS phase-to-neutral voltage.

MIN: minimum RMS phase-to-neutral voltage since the instrument was turned ON or since the last time ↵ was pressed.

PK+: maximum peak phase-to-neutral voltage since the instrument was turned ON or since the last time ↵ was pressed.

PK-: minimum peak phase-to-neutral voltage since the instrument was turned ON or since the last time ↵ was pressed.

7.4.3. 4A MAX.-MIN. DISPLAY SCREEN

This screen displays the one-second mean and half-cycle maximum and minimum RMS values and the positive and negative peak values of the phase and neutral currents.

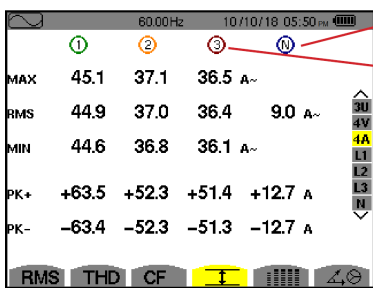

Figure 7-14

Column of values for the neutral: RMS, PEAK+ and PEAK- parameters.

Columns of values for each current graph (1, 2 and 3).

MAX: maximum RMS current since the instrument was turned ON or since the last time ↵ was pressed.

RMS: true RMS current.

MIN: minimum RMS current since the instrument was turned ON or since the last time ↵ was pressed.

PK+: maximum peak current since the instrument was turned ON or since the last time ↵ was pressed.

PK-: minimum peak current since the instrument was turned ON or since the last time ↵ was pressed.

7.4.4. L1 MAX.-MIN. DISPLAY SCREEN

This screen displays the one-second mean and half-cycle maximum and minimum RMS values and the positive and negative peaks of the phase-to-neutral voltage and of the current of phase 1.

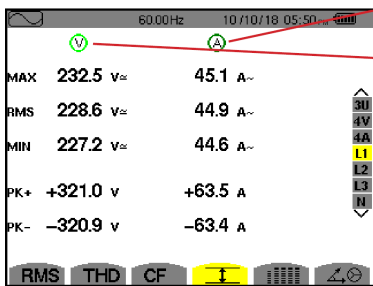

Figure 7-15

The same information as for the phase-to-neutral voltage, but for the current.

Column of voltage values.

MAX: maximum RMS phase-to-neutral voltage since the instrument was turned ON or since the last time ↵ was pressed.

RMS: true RMS phase-to-neutral voltage.

MIN: minimum RMS phase-to-neutral voltage since the instrument was turned ON or since the last time ↵ was pressed.

PK+: phase-to-neutral maximum peak voltage since the instrument was turned ON or since the last time ↵ was pressed.

PK-: phase-to-neutral minimum peak voltage since the instrument was turned ON or since the last time ↵ was pressed.



NOTE: L2 and L3 display the RMS, maximum, minimum, and mean values and the positive and negative peak values of the phase- to-neutral voltage and of the current for phases 2 and 3, respectively.

7.4.5. NEUTRAL MAX.-MIN. DISPLAY SCREEN

This screen displays the RMS values and the positive and negative peaks of the neutral relative to earth.

Column of voltage values.
RMS: true RMS voltage.
PK+: maximum peak voltage since the instrument was turned ON or since the last time the \leftarrow button was pressed.
PK-: minimum peak voltage since the instrument was turned ON or since the last time the \leftarrow button was pressed

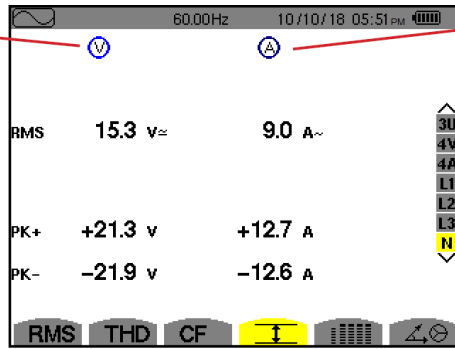

The same information as for the voltage, but for the current.

Figure 7-16

7.5. SIMULTANEOUS DISPLAY

The $\left[\text{grid icon} \right]$ sub-menu displays all of the voltage and current measurements (RMS, DC, THD, CF, PST, PLT, FHL and FK).

7.5.1. 3U SIMULTANEOUS DISPLAY SCREEN

This screen displays the RMS, DC, THD, and CF values of the phase-to-phase voltages.

Column of phase-to-phase voltages (phases 1, 2, and 3).
RMS: true RMS value calculated over 1 second.
DC: DC component.
THD: total harmonic distortion with the fundamental RMS value as reference (%f) or with the total RMS value without DC as reference (%r).
CF: peak factor calculated over 1 second.

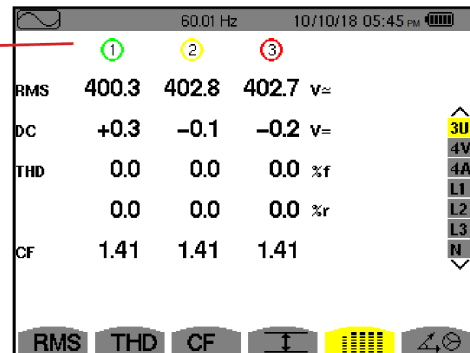

Figure 7-17

7.5.2. 4V SIMULTANEOUS DISPLAY SCREEN

This screen displays the RMS, DC, THD, CF, PST and PLT values of the phase-to-neutral voltages and of the neutral.

Column of RMS and DC values along with the CF and the THD (%r) concerning the neutral.

Column of voltages simple (phases 1, 2, and 3).
RMS: true RMS value calculated over 1 second.
DC: DC component.
THD: total harmonic distortion with the fundamental RMS value as reference (%f) or with the total RMS value without DC as reference (%r).
CF: peak factor calculated over 1 second.
PST: short-term flicker calculated over 10 minutes.
PLT: long-term flicker calculated over 2 hours.

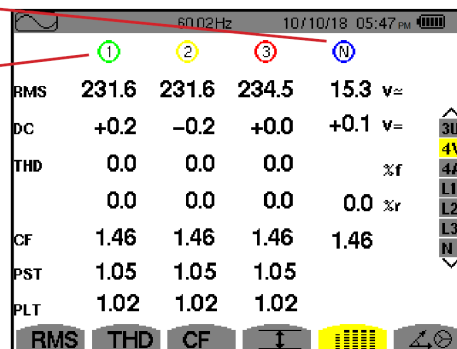

Figure 7-18

7.5.3. 4A SIMULTANEOUS DISPLAY SCREEN

This screen displays the RMS, DC (only if at least one of the current sensors can measure direct current), THD, CF, FHL and FK values of the phase and neutral currents.

Column of RMS values and (if the current sensor allows) DC values along with the CF and the THD (%) concerning the neutral.

Columns of current values (phases 1, 2 and 3).

RMS: true RMS value calculated over 1 second.

DC: DC component.

THD: total harmonic distortion with the fundamental RMS value as reference (%) or with the total RMS value without DC as reference (%r).

CF: peak factor calculated over 1 second.

FHL: harmonic loss factor. For the oversizing of transformers to allow for harmonics.

FK: K factor. Derating of the transformer as a function of the harmonics.

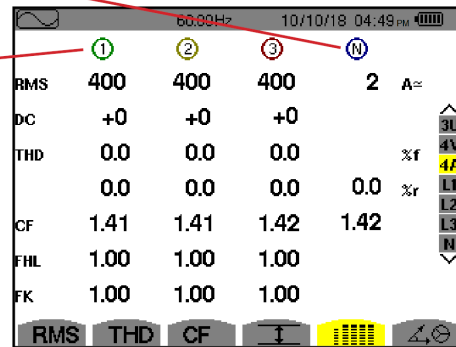

Figure 7-19

NOTE: To make it possible to adjust the zero of current sensors measuring DC, the DC values are never cancelled.

7.5.4. L1 SIMULTANEOUS DISPLAY SCREEN

This screen displays the RMS, DC, THD, and CF values of the phase-to-neutral voltage and of the current, PST and PLT of the phase-to-neutral voltage, and FHL and FK of the current for phase 1.

Column of voltage values simple.

RMS: true RMS value calculated over 1 second.

DC: DC component.

THD: total harmonic distortion with the fundamental RMS value as reference (%) or with the total RMS value without DC as reference (%r).

CF: peak factor calculated over 1 second.

PST: short-term flicker calculated over 10 minutes.

PLT: long-term flicker calculated over 2 hours.

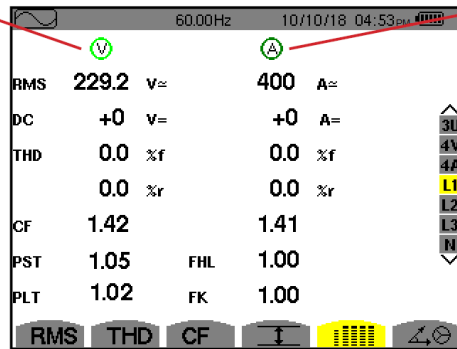

Current column.

RMS, DC (if the current sensor allows), THD and CF values.

FHL: harmonic loss factor. For the oversizing of transformers to allow for harmonics.

FK: K factor. Derating of the transformer as a function of the harmonics.

Figure 7-20

NOTE: The DC value of the current of phase 1 is displayed only if the associated current sensor can measure direct current. L2 and L3 provide the simultaneous display of the current and voltage for phases 2 and 3, respectively.

7.5.5. SCREEN FOR SIMULTANEOUS DISPLAY OF NEUTRAL

This screen displays the RMS, THD and CF voltage and current of the neutral, the DC component of the neutral voltage, and (if the current sensor allows) the DC component of the neutral current.

7.6. PHASOR DIAGRAM

The  Phasor sub-menu displays a vector representation of the fundamentals of the voltages and currents. It indicates their associated quantities (modulus and phase of the vectors) and the negative-sequence voltage and current unbalance rates.

NOTE: To allow the display of all vectors, those of which the modulus is too small to be pictured are displayed with their names followed by an asterisk (*).

7.6.1. 3V PHASOR

This screen displays a vector representation of the fundamentals of phase-to-neutral voltages and currents. It indicates their associated quantities (modulus and phase of the phase-to-neutral voltage vectors) and the negative-sequence voltage unbalance rate. The reference vector of the representation (at 3 o'clock) is V1.

Column of values for each vector (1, 2, and 3).

|V1|, |V2| and |V3|: module of the vectors of the fundamentals of the phase-to-neutral voltages (phases 1, 2 and 3).

Φ_{12} : phase angle of the fundamental of phase 1 with respect to the fundamental of phase 2.

Φ_{23} : phase angle of the fundamental of phase 2 with respect to the fundamental of phase 3.

Φ_{31} : phase angle of the fundamental of phase 3 with respect to the fundamental of phase 1.

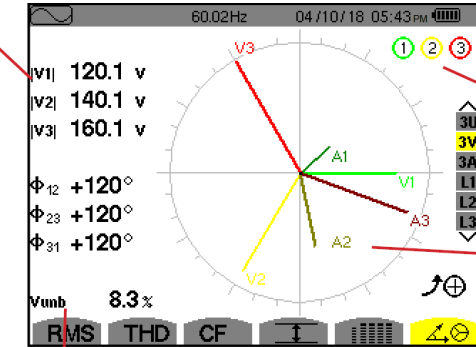

Indicators showing potential saturation of the channel.

Phasor diagram.

Vumb: negative-sequence voltage unbalance rate.

Figure 7-21

7.6.2. 3U PHASOR DIAGRAM DISPLAY SCREEN

This screen displays a vector representation of the fundamentals of the phase-to-phase voltages and of the currents. It indicates their associated quantities (modulus and phase of the phase-to-phase voltage vectors) and the negative-sequence voltage unbalance rate. The reference vector of the representation (at 3 o'clock) is U1.

The information displayed is identical to that described in §7.6.1 but relative to the phase-to-phase voltage.

7.6.3. 3A PHASOR DIAGRAM DISPLAY SCREEN

For sources having a neutral, this screen displays the vector representation of the fundamental component of the phase-to-neutral voltages and of the current. For 3-wire three-phase (source without neutral), this screen displays only the vector representation of the fundamental components of the current. It indicates their associated quantities (modulus and phase of the current vectors) and negative-sequence current unbalance rate. The reference vector of the representation (at 3 o'clock) is A1.

The information displayed is identical to that described in §7.6.1 but relative to the current.

7.6.4. L1 PHASOR DIAGRAM DISPLAY SCREEN

In the presence of the neutral, this screen displays a vector representation of the fundamentals of the phase-to-neutral voltages and the currents of one phase. It indicates their associated quantities (modulus and phase of the current and phase-to-neutral voltage vectors). The reference vector of the representation (at 3 o'clock) is the current vector.

|V1|: modulus of the vector of the fundamental of the phase-to-neutral voltage of phase 1.

|A1|: modulus of the vector of the fundamental of the current of phase 1.

Φ_{VA} : phase angle of the fundamental of the phase-to-neutral voltage of phase 1 relative to the fundamental of the current of phase 1.

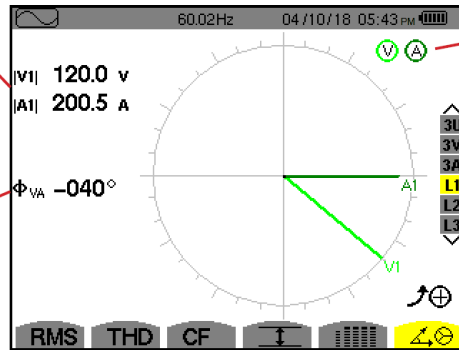

Indicators showing potential saturation of the channel.

Figure 7-22



NOTE: L2 and L3 display vector representations of the fundamentals of the phase-to-neutral voltages and the currents of phases 2 and 3, respectively. They indicate their associated quantities (modulus and phase of the current and phase-to-neutral voltage vectors of phases 2 and 3, respectively). The reference vector of the representation (at 3 o'clock) is the current vector (A2 and A3, respectively).

In the absence of the neutral (2-wire two-phase):

|U1|: modulus of the vector of the fundamental component of the phase-to-phase voltage between phases 1 and 2 (U_{12}).

|A1|: modulus of the vector of the fundamental of the current of phase 1.

Φ_{UA} : phase shift of the fundamental component of the phase-to-phase voltage between phases 1 and 2 (U_{12}) with respect to the fundamental component of the current of phase 1.

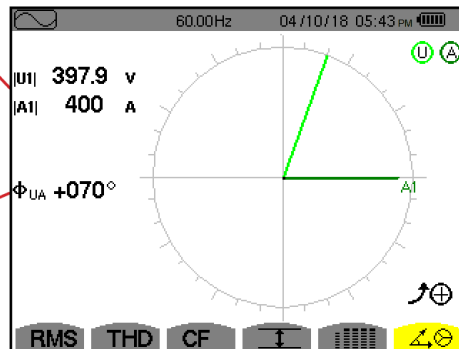

Indicators showing potential saturation of the channel.

Figure 7-23

8. ALARM MODE

The  Alarm mode detects overshoots of thresholds on each of the following parameters: Hz, Urms, Vrms, Arms, |Udc|, |Vdc|, |Adc|, |Upk+|, |Vpk+|, |Apk+|, |Upk-|, |Vpk-|, |Apk-|, Ucf, Vcf, Acf, Uthdf, Vthdf, Athdf, Uthdr, Vthdr, Athdr, |P|, |Pdc|, |Q,| or N, D, S, |PF|, |cos Φ|, |tan Φ|, PST, PLT, FHL, FK, Vunb, Uunb (for a three-phase source without neutral) Aunb, U-h, V-h, A-h and |S-h| (see the table of abbreviations in §2.8).

The alarm thresholds must be:

- configured in the Configuration / Alarm mode screen (see §4.10)
- active (marked with a red spot on that same screen)

Stored alarms can subsequently be uploaded to a computer via the DataView PowerPad III Control Panel software (see §13). You can capture over 16,000 alarms.

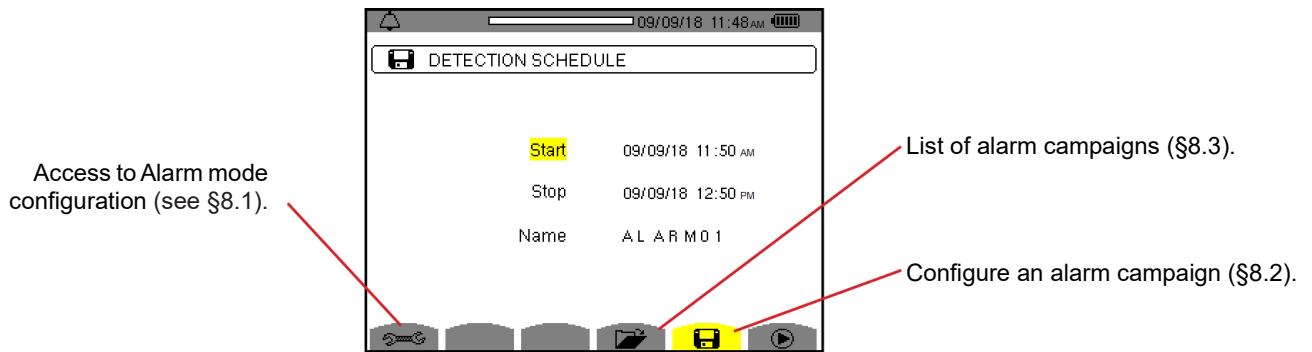







Figure 8-1

The  and  icons have the following functions:

-  Validating the programming of a campaign and starting the alarm campaign.
-  Voluntary stopping alarm campaign.

8.1. ALARM MODE CONFIGURATION





The  submenu displays the list of configured alarms (see §4.10). This shortcut button lets you define or change alarm configurations. The following information is displayed.

Press  to return to the Detection Schedule screen.

8.2. ALARM CAMPAIGN CONFIGURATION

The  Detection Schedule submenu specifies the start and stop times for an alarm campaign (see Figure 8-1).

To program an alarm campaign, enter the start date and time, the stop date and time, and the name of the campaign.

To modify an item, move the yellow cursor to it using the  and  buttons, then validate with the  button. Change the value using the  and  buttons, then validate again.





The name can be up to 8 characters long (uppercase letters and numbers 0 through 9). Several campaigns may have the same name. The last 5 names given (in the transient, trend, and alarm modes) are kept in memory. When a name is entered, it may then be completed automatically.



NOTE: The start date and time must be later than the current date and time.

The stop date and time must be later than the start date and time.

It is not possible to configure an alarm campaign if an inrush current capture is in progress.

After configuration, start the campaign by pressing the  button. The  status bar icon blinks to indicate that the campaign has started. The  button replaces the  button and can be used to stop the campaign before it is finished. Alarms in progress are recorded in the campaign if their duration is equal to or greater than their configured minimum duration.

The **Campaign on standby** message is displayed until the start time is reached. It is then replaced by the message **Campaign running**. When the stop time is reached, the Detection Schedule screen returns with the  button. You can then program another campaign.

During an alarm campaign, only the stop date field can be modified. It is automatically highlighted in yellow.

8.3. CAMPAIGNS LIST

To display the list of campaigns performed, press the  button. The Detection List screen is displayed. The list can contain up to 7 campaigns.

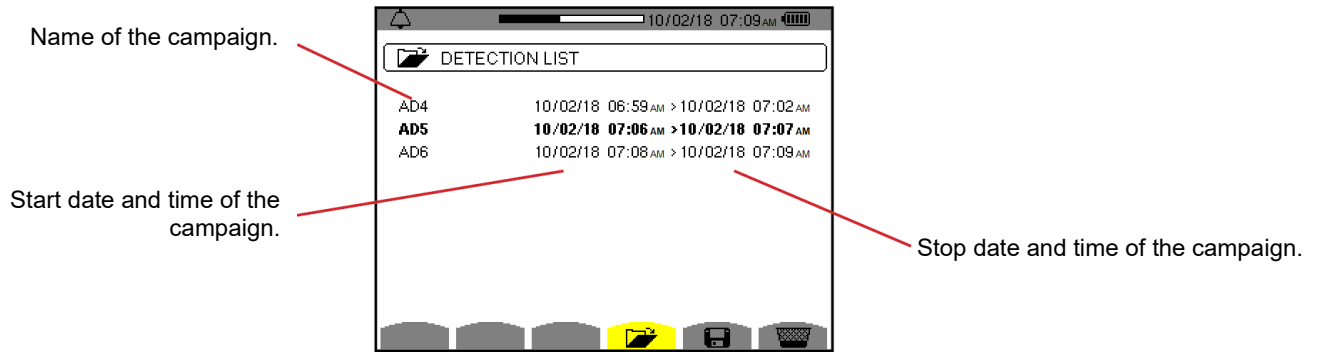

Figure 8-2

If the stop date of the campaign is in red, it does not match the stop date initially configured, either because:

- power supply problem (battery low or disconnection of the instrument supplied by mains only)
- memory is full

8.4. ALARMS LIST

To select a campaign, move the cursor to it using the ▲ and ▼ buttons. The selected name is bolded. Then select it with the ↵ button. The instrument then displays the alarms in list form.

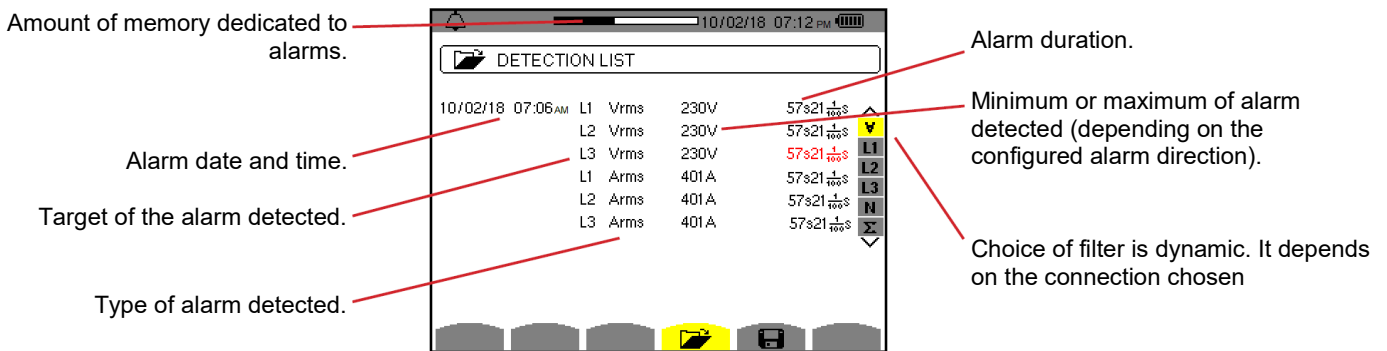



Figure 8-3

If an alarm duration is displayed in red, it was cut short due to:

- Power supply problem (battery low).
- Manual stopping campaign (by pressing ) or turning OFF the instrument (by pressing .
- Memory is full.
- Measurement error.
- Incompatibility between the quantity monitored and the configuration of the instrument (for example withdrawal of a current sensor).

In the last two cases, the minimum and maximum are also displayed in red. To return to the Detection List screen, press .

8.5. DELETING AN ALARM CAMPAIGN

When the list of campaigns performed is displayed (see Figure 8-3), select the campaign to be erased. This is done by moving the cursor to it using the ▲ and ▼ buttons. The selected campaign is bolded.

Then press the  button. Press ↵ to validate or ↶ to cancel.



NOTE: It is not possible to delete an alarm campaign in progress.

8.6. ERASING ALL ALARM CAMPAIGNS

Erasing all alarm campaigns is possible only from the Configuration menu, in the Erase Memory sub-menu (see §4.11).

9. TREND MODE

The  Trend mode records changes to parameters previously specified in the Trend Mode screen in the Configuration menu (see §4.9). This mode manages up to 2 GB of data.

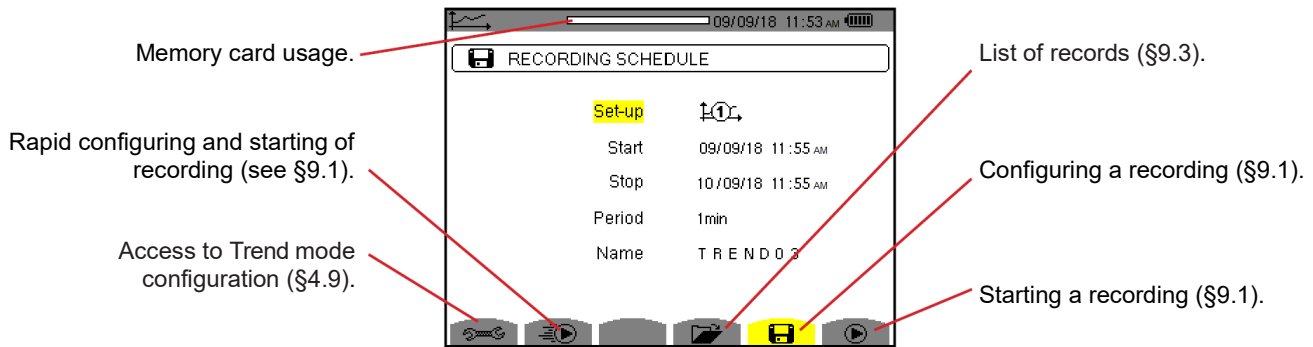











Figure 9-1

9.1. CONFIGURING AND STARTING A RECORDING

The  Recording Schedule submenu specifies the characteristics of a recording (see Figure 9-1).

To start a recording immediately, press the  button. Recording starts immediately; all measurements are recorded every second until the memory is completely full. The configuration displayed is .

To configure a recording, before starting it choose configuration  to , enter the start date and time, the stop date and time, the period, and the name of the recording.

To modify a setting, move the yellow cursor to it using the  and  buttons, then validate with the  button. Change the value using the  and  buttons, then validate again.



The Period setting is the time over which the measurements of each recorded value are averaged (arithmetic mean). Possible values are: 1 s, 5 s, 20 s, 1 min, 2 min, 5 min, 10 min and 15 min.

The name can be up to 8 characters long (uppercase letters and numbers 0 through 9). Several recordings may have the same name. The last 5 names given (in the transient, trend, and alarm modes) are kept in memory. When a name is entered, it may then be completed automatically.



NOTE: The start date and time must be later than the current date and time.

The stop date and time must be later than the start date and time.

After configuration, start recording by pressing the button. If not enough memory is available, the instrument displays a message informing you of this. The  status bar icon blinks to indicate that recording has begun. The  button replaces the  button and can be used to stop the recording before it is finished.

The **Recording on standby** message is displayed until the start time is reached. It is then replaced by the message **Recording running**. When the stop time is reached, the **Program a Record** screen returns with the  button. You can then configure a new recording.

During the recording of a trend, only the stop date field can be modified. It is automatically highlighted in yellow.

9.2. TREND MODE CONFIGURATION

The  submenu displays the list of trend recording configurations (see §4.9). This shortcut button lets you specify or modify the trend recording configurations.

9.3. VIEWING THE RECORDING LIST

The  Recording List submenu displays a list of recordings stored in the instrument memory.

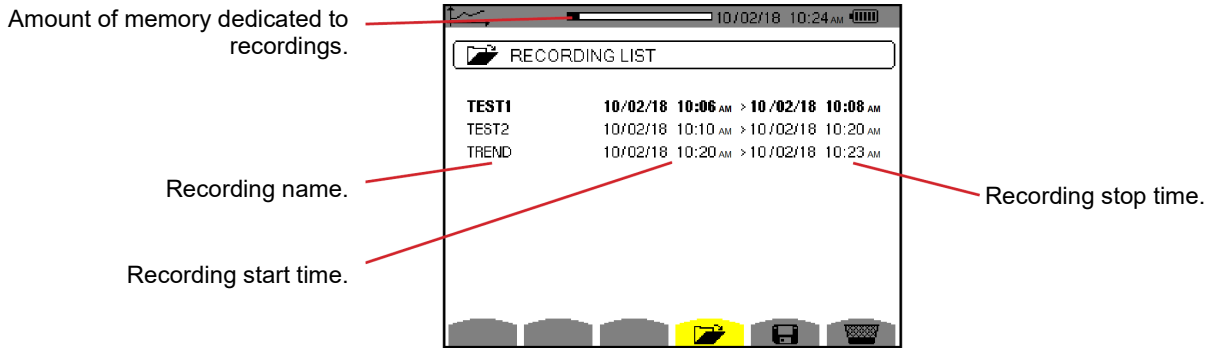



Figure 9-2

If the stop date is in red, it does not match the configured date, due to a power supply problem (battery low or disconnection of the instrument supplied by external power only).

9.4. DELETING RECORDINGS

When the list of records is displayed (see Figure 9-2), select the recording to be erased by highlighting it using the ▲ and ▼ buttons. (The selected recording is bolded.) Then press the  button. Press ← to validate or ↶ to cancel.

9.5. VIEWING RECORDS

9.5.1. RECORDING PARAMETERS

With the Recording List displayed, select a recording and press ← to open it. The Recording Parameters menu is displayed.

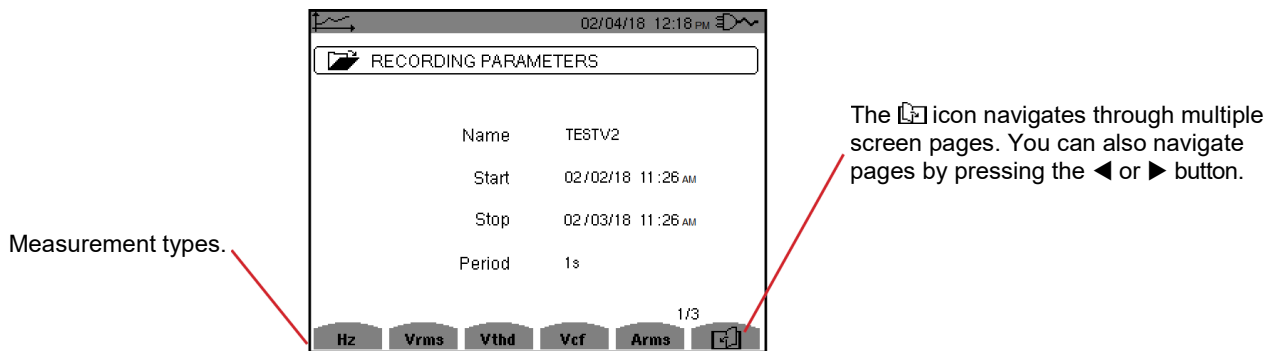

Figure 9-3

If a measurement does not appear among the tabs at the bottom of the screen, calculation of the measurement was incompatible with the selected configuration (connection, types of sensors, ratios). For example, if the configured calculation mode is Non-active Quantities not broken down (see §4.5.1), the D tab does not appear.

Press the associated function button to display the graph for a measurement.

9.5.2. TREND GRAPHS

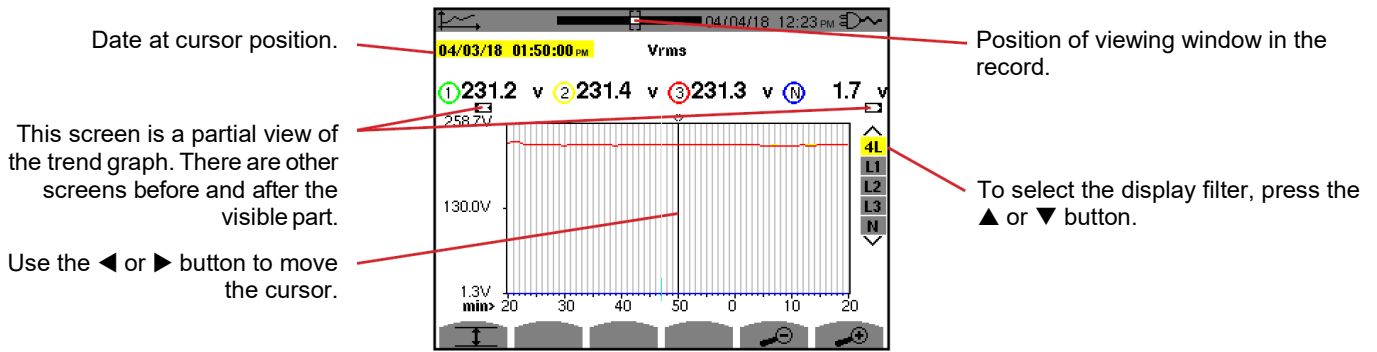

Figure 9-4

The display period of this graph is one minute. Since the period of the record is one second, each point of this graph corresponds to a value recorded in a one-second window once a minute. There is therefore a substantial loss of information (59 values out of 60), but the display is rapid.

Saturated values appear in red.

Black dashes - - - - indicate erroneous values.

Red dashes - - - - If red dashes appear when the is pressed, they indicate values that are not calculated in the MIN-MAX-AVG mode.

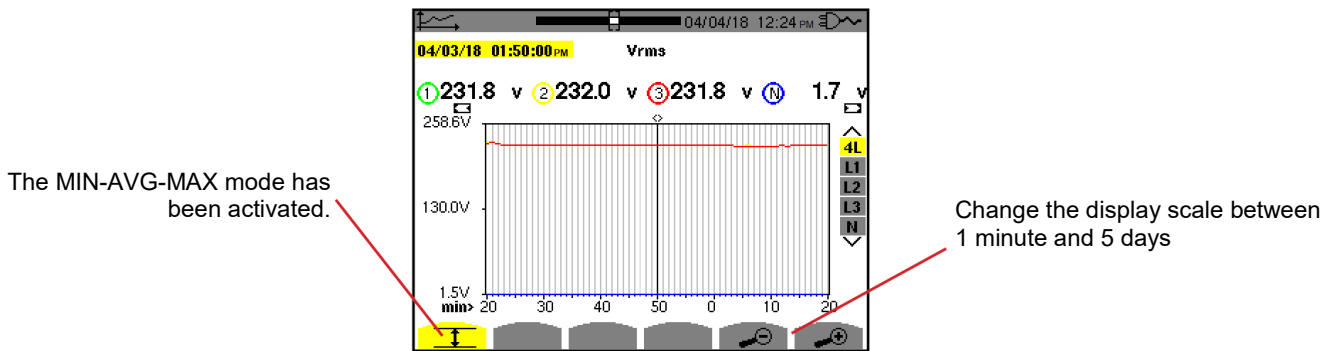

Figure 9-5

The display period of this graph is one minute. With MIN-AVG-MAX mode activated, each point of this graph represents the arithmetic mean of 60 values recorded every second. This display is therefore more precise, because there is no loss of information, but slower (see the table at the end of this section).

To stop the calculation of MIN-AVG-MAX mode, press .

NOTES: While MIN-AVG-MAX mode is being calculated, a progress bar is displayed in the status bar instead of the recording display window positioning bar.
MIN-AVG-MAX mode is not available while a trend is being recorded.

To return to the Recording Parameters screen, press .

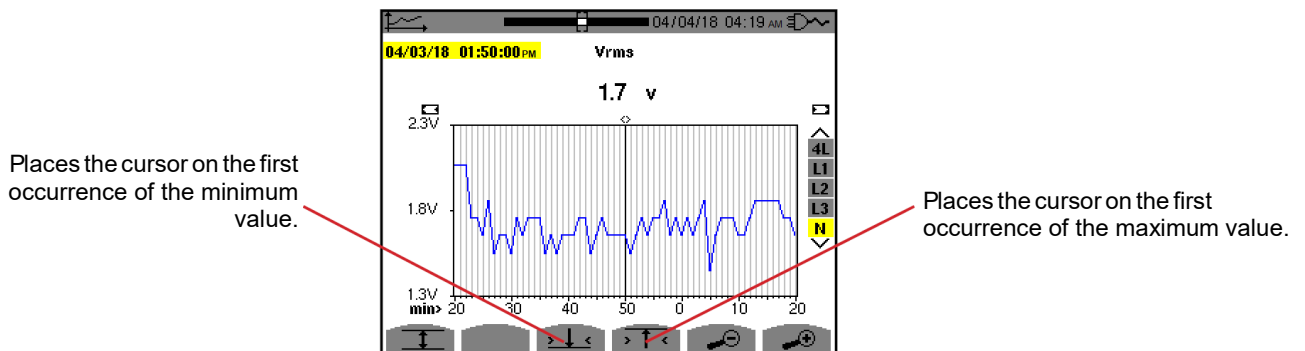

Figure 9-6

Pressing the or button automatically sets "zoom in" to the highest level (display period identical to the recording period) and de-activates the MIN-AVG-MAX mode if activated.

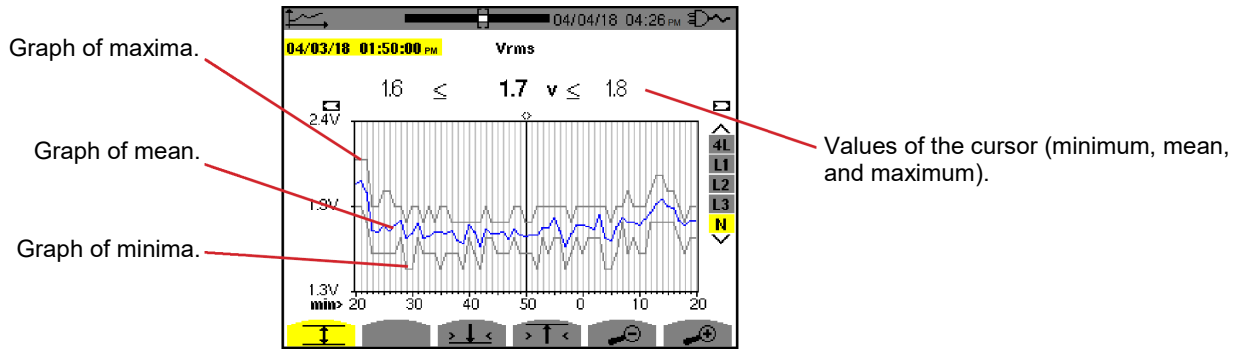

Figure 9-7

The display period of this graph is one minute. Each point of the mean graph represents the arithmetic mean of 60 values recorded every second. Each point of the graph of the maxima represents the maximum of the 60 values recorded every second. Each point of the graph of the minima corresponds to the minimum of the 60 values recorded every second. This display is therefore more precise than the previous one.

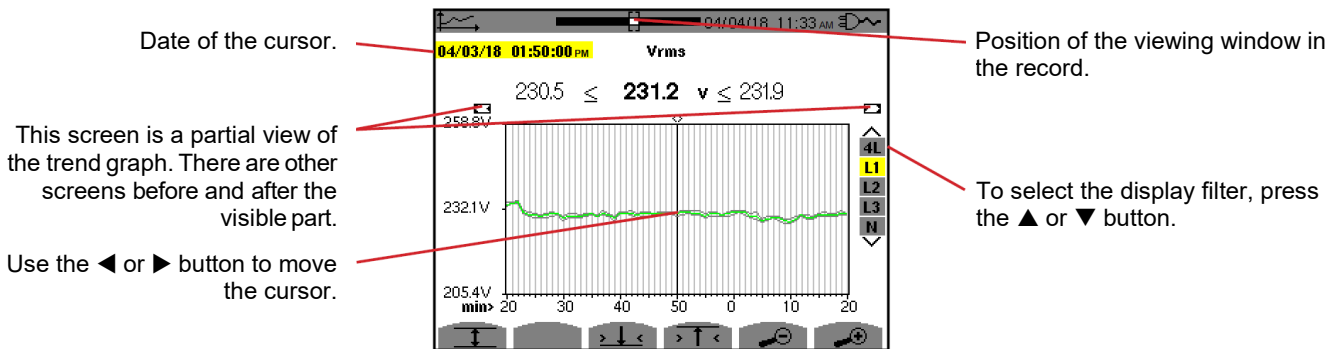

Figure 9-8

For each phase (L1, L2, and L3), at each recording of a value over one second (recording period), the instrument also records the minimum half-cycle RMS value over one second and the maximum half-cycle RMS value over one second. These are the three graphs shown in Figure 9-7.

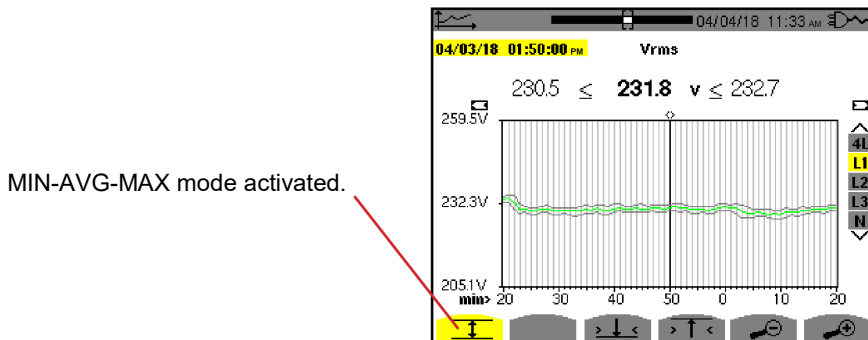

Figure 9-9

This graph differs slightly from the previous one because, with the MIN-AVG-MAX mode, there is no loss of information.

NOTE: For the quantities (P, Pdc, VAR, S, D, PF, cos Φ and tan Φ) and for a three-phase source without neutral, only the total quantities are represented.

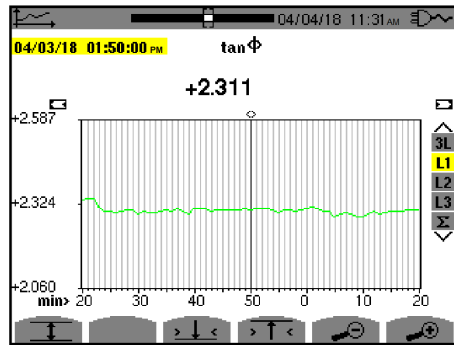

Figure 9-10

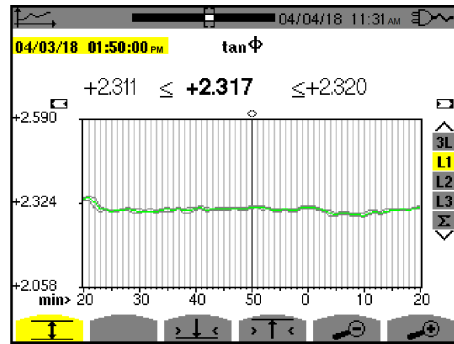
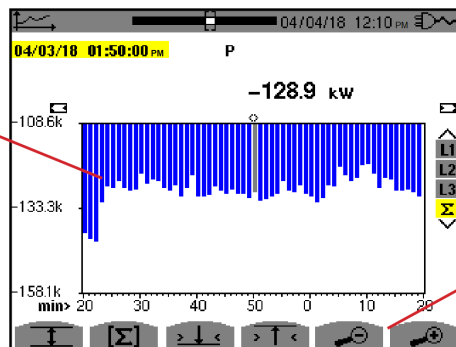

Figure 9-11

The sum of the powers of the three phases (Σ) is presented in bar graph form.



Changes the display scale between 1 minute and 5 days.

Figure 9-12

For the energy graphs, the quantities are expressed in Wh, J, toe, or BTU, depending on the configured unit (see §4.5.2).

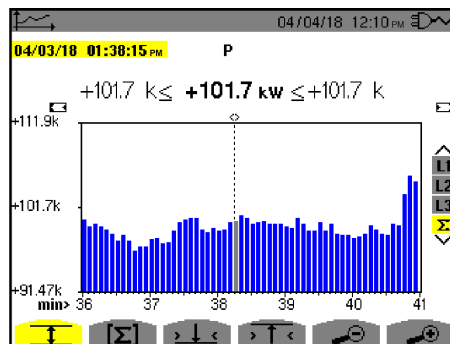

Figure 9-13

This graph differs slightly from the previous one because, with the MIN-AVG-MAX mode, there is no loss of information.

The MIN-AVG-MAX mode can be activated for the powers to display, above the graph, the mean power value at the cursor date along with the maximum and minimum power values in the display period. Note that, in contrast with the other quantities, only the bar chart of mean values is represented.

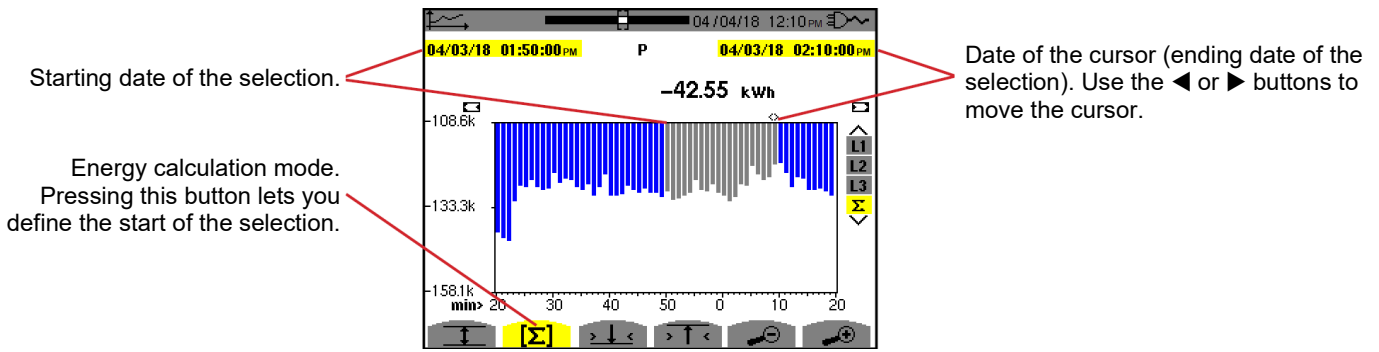

Figure 9-14

The display period of this bar chart is one minute. Since the recording period is one second, each bar of this bar chart represents a value recorded in a one-second window once a minute.

The energy calculation mode determines the sum of the powers on the selected bars.

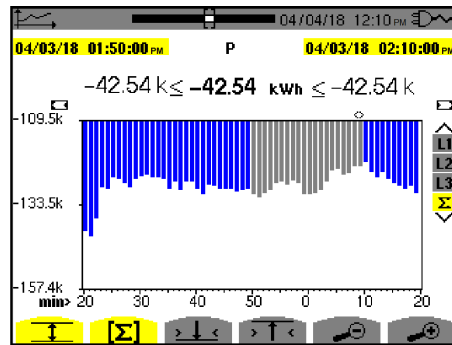

Figure 9-15

With the MIN-AVG-MAX mode activated, the display differs slightly from the previous one because there is no loss of information.

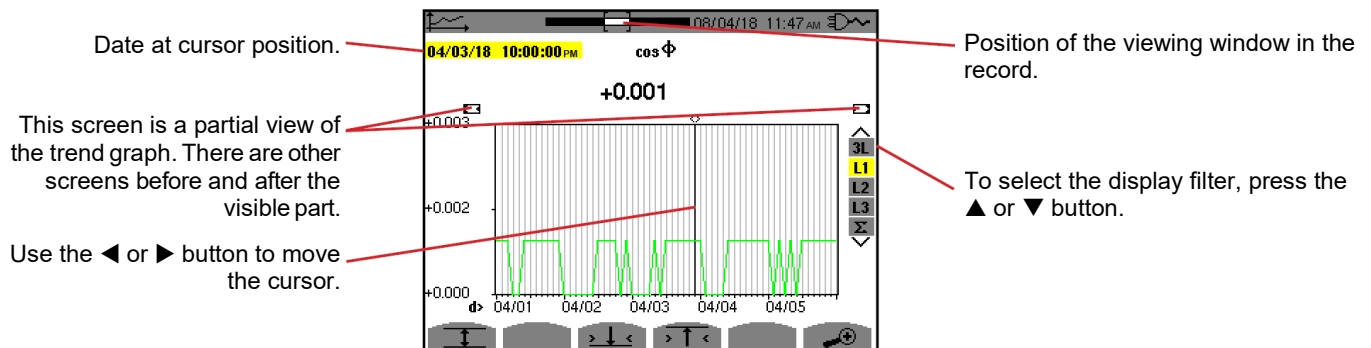

Figure 9-16

The period of display of this graph is two hours. Since the recording period is one second, each point of this graph represents a value recorded every second taken every two hours. There is therefore a substantial loss of information (7,199 out of 7,200), but the display is rapid.

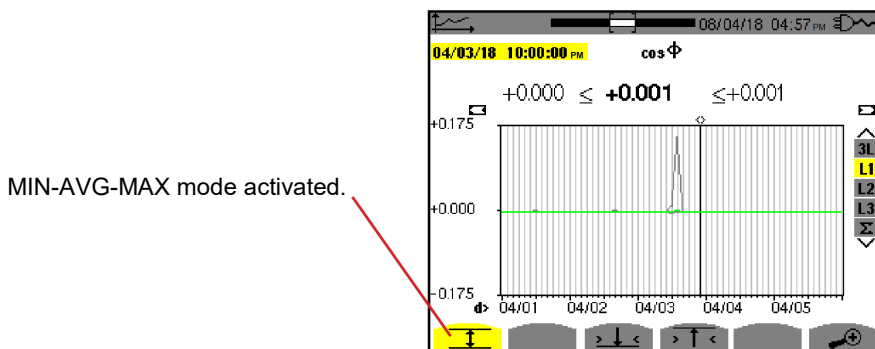

Figure 9-17

This graph differs considerably from the previous one, because MIN-AVG-MAX mode is activated. Each point of the mean graph represents the arithmetic mean of 7,200 values recorded every second. Each point of the graph of the maxima represents the maximum of the 7,200 values recorded every second. Each point of the graph of the minima corresponds to the minimum of the 7,200 values recorded every second.

This display is therefore more precise, because there is no loss of information, but slower (see the table at the end of this section).

Pressing this button stops the loading of recorded values and calculation of values displayed.

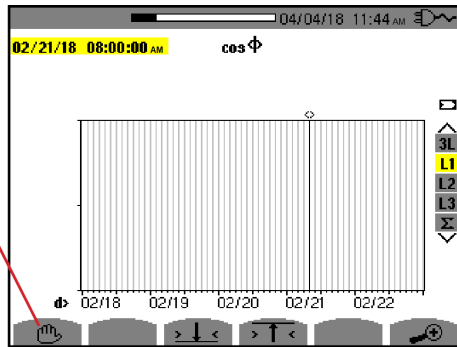

Figure 9-18

Dashes indicate that the value is not available at the cursor position because it was not calculated.

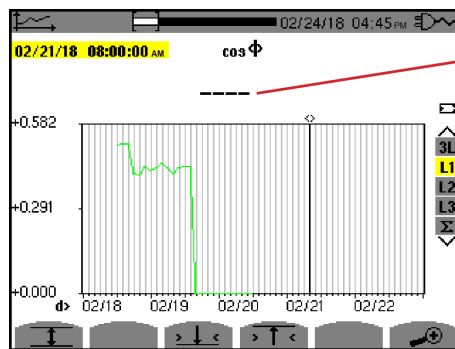
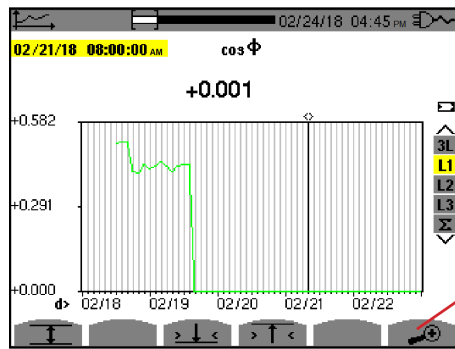

Figure 9-19

Display of the record is not complete because construction was stopped before the end.



Changes the display scale between 1 minute and 5 days.

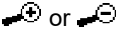

Figure 9-20

The display has not been stopped and is therefore complete.

The following table indicates the time needed to display the graph on screen as a function of the width of the display window for a recording period of one second:

Width of display window (60 points or increments)	Grid increment	Typical waiting time for display with MIN-AVG- MAX mode deactivated	Typical waiting time for display with MIN-AVG- MAX mode activated
5 days	2 hours	11 seconds	10 minutes
2.5 days	1 hour	6 seconds	5 minutes
15 hours	15 minutes	2 seconds	1 minute 15 seconds
10 hours	10 minutes	2 seconds	50 seconds
5 hours	5 minutes	1 second	25 seconds
1 hour	1 minute	1 second	8 seconds
20 minutes	10 seconds	1 second	2 seconds
5 minutes	5 seconds	1 second	1 second
1 minute	1 second	1 second	1 second

These times can be long, so the instrument provides the ability to stop the display at any time by pressing the  button. It is also possible, at any time, to press:

-  to change the scale of the display
-  to move the cursor
-  to change the display filter

But note that this may restart the loading and/or calculation of the values from the beginning.

10. POWER AND ENERGY MODE

The **W** button displays power- and energy-related measurements.

The available sub-menus depend on the filter.

- For 2- and 3-wire single-phase connections and for the 2-wire two-phase connection, only L1 is available. The filter is therefore not displayed, but the display is the same as for L1.
- For the 3-wire three-phase connection, only Σ is available. The filter is therefore not displayed, but the display is the same as for Σ .

10.1. 3L FILTER

10.1.1. POWERS DISPLAY SCREEN

The **W...** sub-menu is used to display the powers.

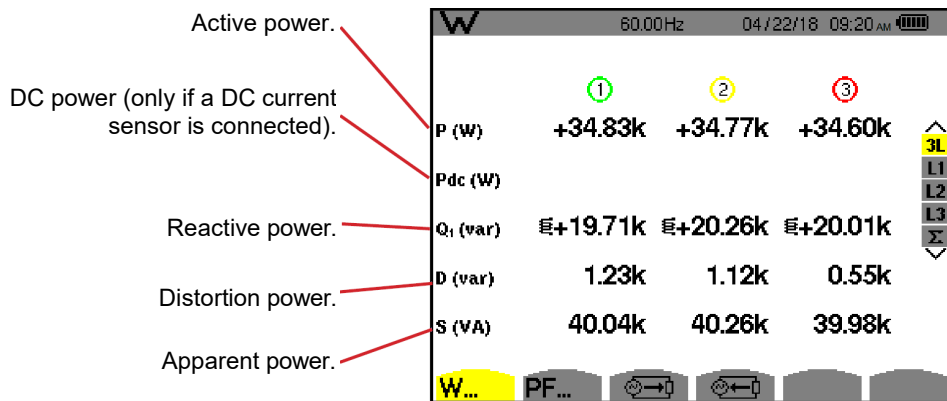

Figure 10-1



NOTE: This screen corresponds to the choice “non-active quantities broken down” in the AR tab of the Calculation Methods menu in Configuration mode. If “non-active quantities not broken down” is selected, D (distortion power) is not displayed and Q1 appears in place of N. This non-active power is unsigned and has no inductive or capacitive effect.

10.1.2. QUANTITIES ASSOCIATED WITH THE POWERS DISPLAY SCREEN

The **PF...** sub-menu... displays the quantities associated with the powers.

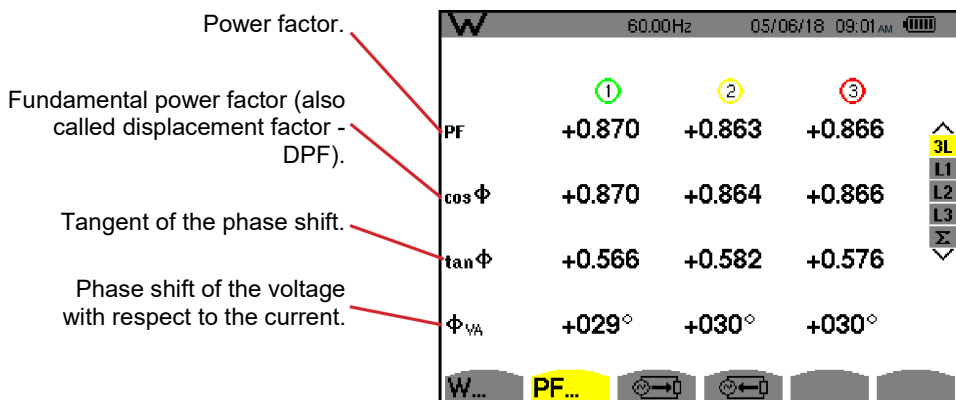

Figure 10-2

10.1.3. ENERGIES CONSUMED DISPLAY SCREEN

The sub-menu displays the meters of energy consumed by the load.

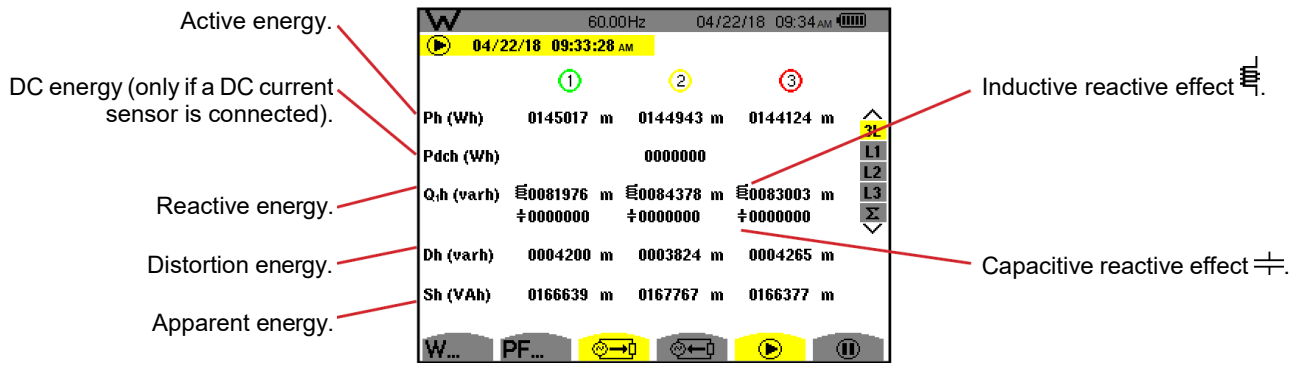

Figure 10-3



NOTE: This screen corresponds to the choice “non-active quantities broken down” in the VAR tab of the Calculation Methods menu of the Configuration mode. If “non-active quantities not broken down” is selected, Dh (distortion energy) does not appear and Q1h is replaced by Nh. This non-active energy has no inductive or capacitive effect.

10.1.4. ENERGIES GENERATED DISPLAY SCREEN

The sub-menu displays the meters of the energy generated by the load.

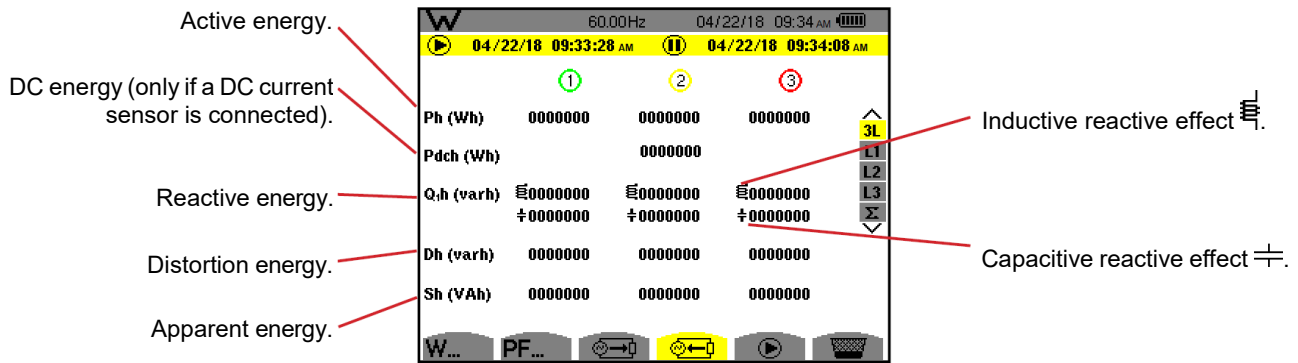

Figure 10-4



NOTE: This screen corresponds to the choice “non-active quantities broken down” in the VAR tab of the Calculation Methods menu of the Configuration mode. If “non-active quantities not broken down” is selected, Dh (distortion energy) does not appear and Q1h is replaced by Nh. This non-active energy has no inductive or capacitive effect.

10.2. FILTERS L1, L2 AND L3

10.2.1. POWERS AND ASSOCIATED QUANTITIES DISPLAY SCREEN

The **W...** sub-menu displays the powers and associated quantities.

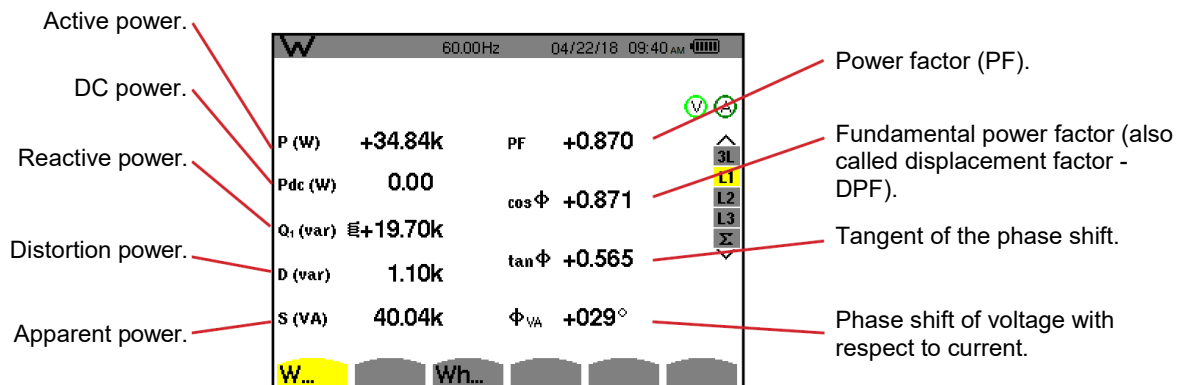

Figure 10-5



NOTE: This screen corresponds to the choice “non-active quantities broken down” in the VAR tab of the Calculation Methods menu of the Configuration mode. If “non-active quantities not broken down” is selected, D (distortion power) does not appear and Q_1 is replaced by N. This non-active power has no inductive or capacitive effect.

Filters L2 and L3 display the same information for phases 2 and 3.

Φ_{UA} is displayed for the 2-wire two-phase set-up.

10.2.2. ENERGY METERS DISPLAY SCREEN

The Wh... sub-menu displays the energy meters.

Meters of energy consumed by the load.

Active energy.

DC energy (only if a DC current sensor is connected).

Reactive energy.

Distortion energy.

Apparent energy.

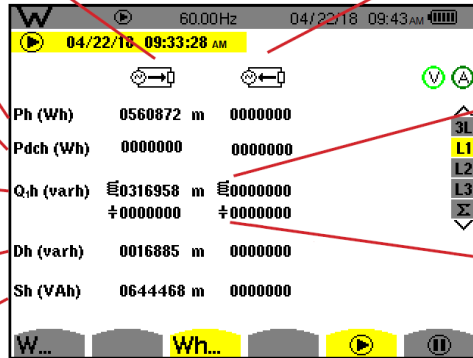

Meters of the energy generated by the load

Inductive reactive effect $\overset{+}{\underset{-}{\text{H}}}$

Capacitive reactive effect $\overset{-}{\underset{+}{\text{H}}}$

Figure 10-6



NOTE: This screen corresponds to the choice “non-active quantities broken down” in the VAR tab of the Calculation Methods menu of the Configuration mode. If “non-active quantities not broken down” is selected, Dh (distortion energy) does not appear and Q_1 is replaced by Nh. This non-active energy has no inductive or capacitive effect.

Filters L2 and L3 display the same information for phases 2 and 3.

10.3. FILTER Σ

10.3.1. TOTAL POWERS AND ASSOCIATED QUANTITIES DISPLAY SCREEN

The W... sub-menu displays the powers and associated quantities.

Total active power.

Total DC power.

Total reactive power.

Total distortion power.

Total apparent power.

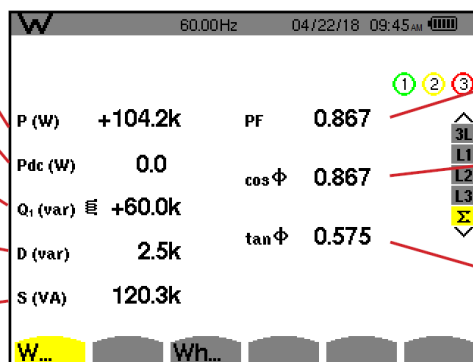

Total power factor (PF).

Total fundamental power factor (also called displacement factor - DPF).

Total tangent of the phase shift.

Figure 10-7



NOTE: This screen corresponds to the choice “non-active quantities broken down” in the VAR tab of the Calculation Methods menu of the Configuration mode. If “non-active quantities not broken down” is selected, D (distortion power) does not appear and Q_1 is replaced by N. This non-active power has no inductive or capacitive effect.

10.3.2. TOTAL ENERGY METERS DISPLAY SCREEN

The Wh... sub-menu displays the energy meters.

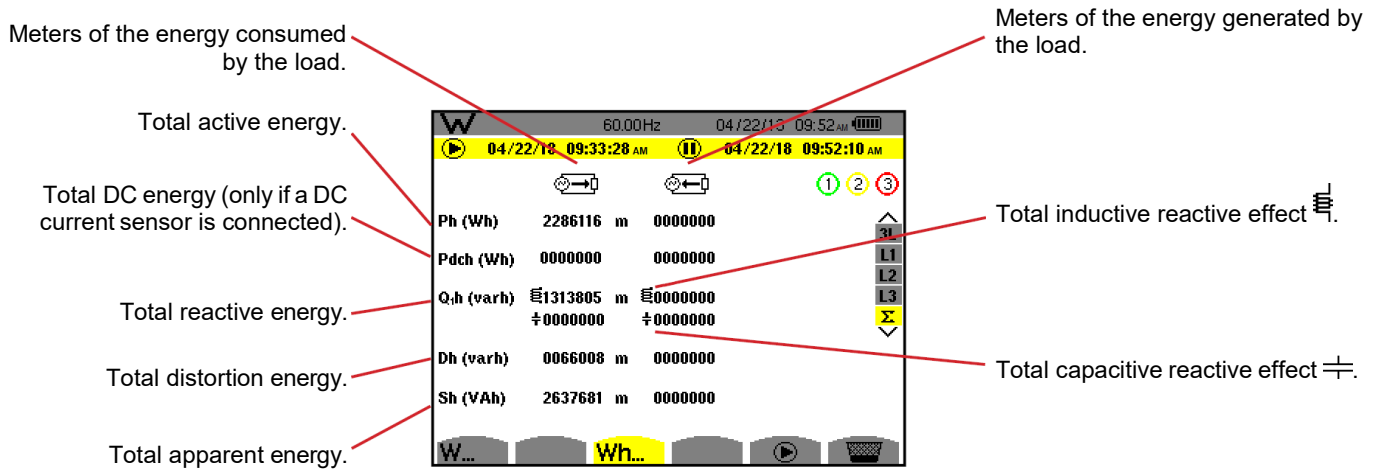

Figure 10-8

NOTE: This screen corresponds to the choice “non-active quantities broken down” in the VAR tab of the Calculation Methods menu of the Configuration mode. If “non-active quantities not broken down” is selected, Dh (distortion energy) does not appear and Q_h is replaced by Nh. This non-active energy has no inductive or capacitive effect.

For 3-wire three-phase networks, only the display of total quantities is available, the method of calculation of the powers used is the two-wattmeter method (with 2 sensors connected) or the three-wattmeter method with virtual neutral (with 3 sensors connected).

10.4. START ENERGY METERING

To start an energy metering, press the ⏸ button in an energies display screen (⏸ , ⏸ , or Wh...).

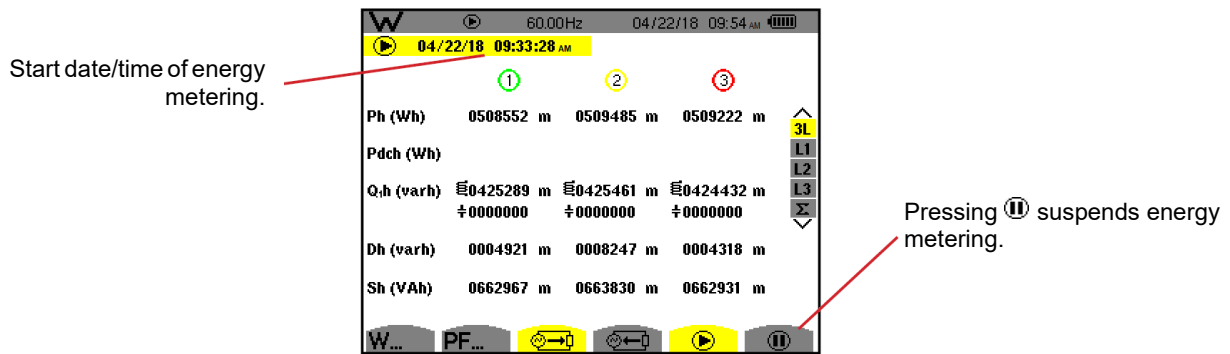

Figure 10-9

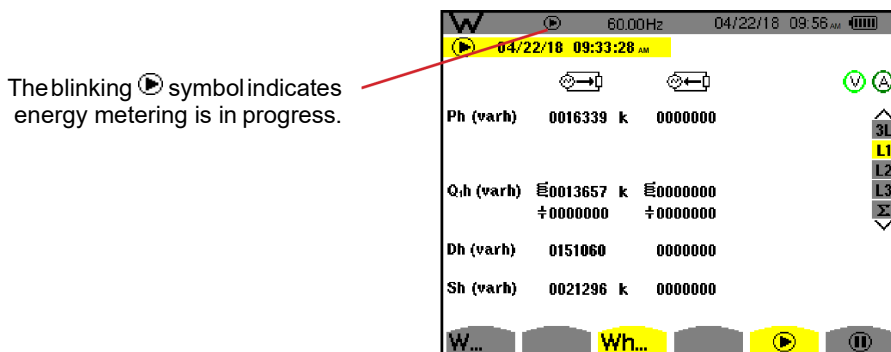

Figure 10-10

The diagram used is the 4-quadrant diagram.

NOTE: The non-nullity threshold is 11.6 kWh for non-nuclear toe and 3.84 kWh for nuclear toe.

10.5. STOP ENERGY METERING

To suspend energy metering, press **⏸**.

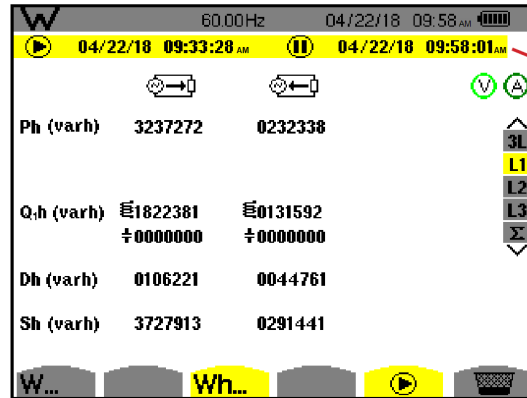

Figure 10-11

A disconnection of the metering is not definitive. It can be resumed by pressing the **▶** button again.



NOTE: If no recording is in progress, disconnecting the energy metering leads to the appearance of the blinking **▶** symbol in the status bar (in place of the **⏸** symbol). Disconnecting the energy metering also leads to the replacement of the **⏸** button by the **▶** button.











10.6. RESET ENERGY METERING



To suspend metering, press the **⏸** button. To then reset energy metering, press the **▶** button and validate with the **↵** button. All energy values (consumed and generated) are then reset.

11. SCREEN SNAPSHOT MODE

The  button can take up to 50 screen snapshots and display recorded snapshots. Saved snapshots can then be transferred to a computer running the DataView PowerPad III Control Panel.

11.1. SCREEN SNAPSHOTS

Press  for approximately 3 seconds to take a snapshot of any screen. When the snapshot is taken, the icon of the active mode (, , , , , , ) at the top of the display unit is replaced by the  icon. You can then release the  button.

The instrument can record up to 50 screen snapshots. If you attempt to record an additional snapshot, the instrument informs you that snapshots must be deleted by displaying the  icon in place of .

11.2. HANDLING SCREEN SNAPSHOTS

To enter screen snapshot mode, briefly press the  button. The instrument then displays a list of recorded screen snapshots.

Available image memory. The black bar represents memory used and the white bar represents memory available.

List of saved snapshots. Each icon represents the type of screen recorded, followed by the date and time of the snapshot.

Icons for browsing screen pages.

Display list of screen snapshots.

Delete a screen snapshot.

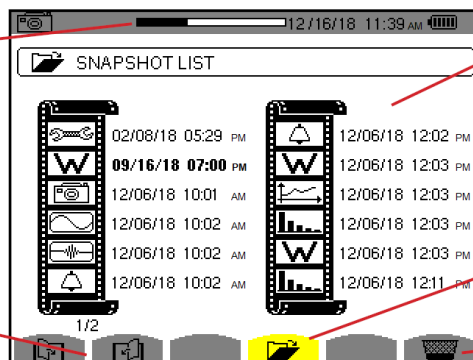















Figure 11-1





11.2.1. VIEWING A SNAPSHOT

To view a snapshot, select it in the list of screen snapshots using the , ,  and  buttons. The date and time of the selected snapshot are bolded.



Press  to display the selected snapshot. The  icon is displayed, alternating with the icon for the mode that was active when the snapshot was taken (, , , , , , )

Press  to return to the list of screen snapshots.

11.2.2. DELETING A SNAPSHOT

To delete a snapshot, select it in the list of screen snapshots using the , ,  and  buttons. The date and time of the selected snapshot are bolded.

Press the  button and validate by pressing . The snapshot is removed from the list.

To cancel the deletion, press  instead of .

12. HELP BUTTON

The  button provides information about the button functions and symbols used in the current display mode. The following is an example of Help information displayed:

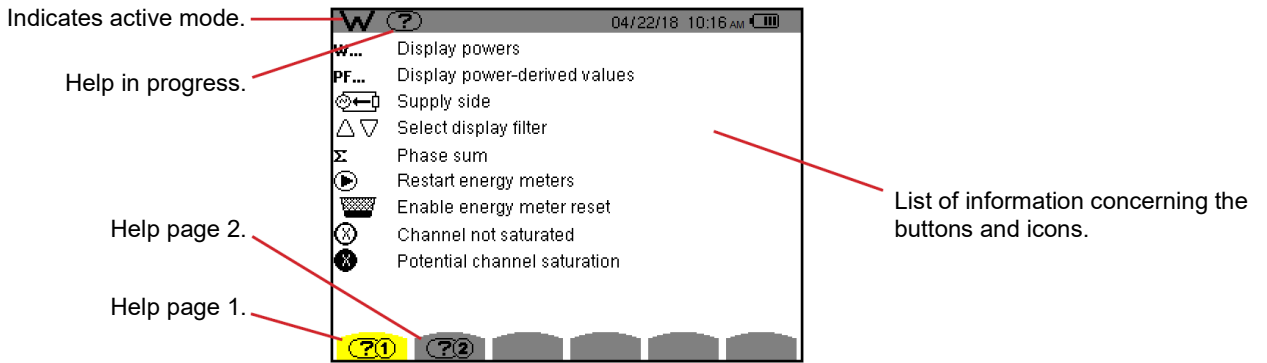

Figure 12-1

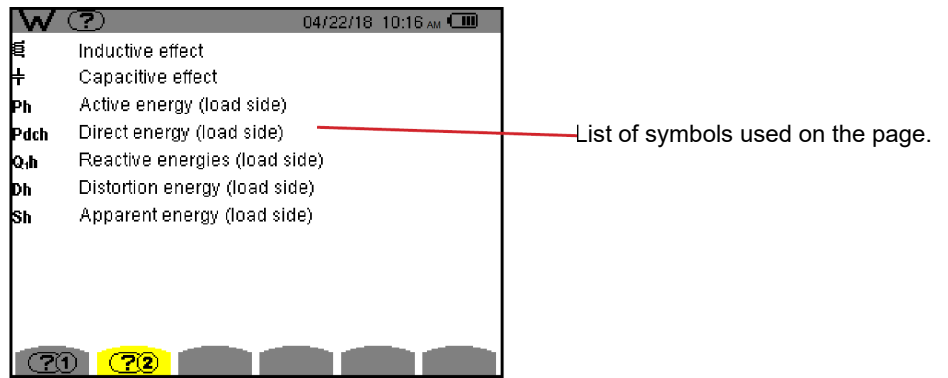



Figure 12-2

13. DATAVIEW® SOFTWARE

The DataView® PowerPad III Control Panel software supplied with the instrument is used to transfer the data recorded in the instrument to a computer.

13.1. INSTALLING DATAVIEW®



 **DO NOT CONNECT THE INSTRUMENT TO THE COMPUTER BEFORE INSTALLING THE SOFTWARE AND DRIVERS.**

 **NOTE:** When installing, the user must have Administrative access rights during the installation. The user's access rights can be changed after the installation is complete. DataView® must be reinstalled for each user in a multi-user system.

When you purchase the instrument, the product package includes a USB drive containing DataView program files. To begin installation:

1. Insert the DataView drive into an available USB port on your computer.
If Autorun is enabled, an AutoPlay window appears on your screen. Click "Open folder to view files" to display the DataView folder.
If Autorun is not enabled or allowed, use Windows Explorer to locate and open the USB drive labeled "DataView."
2. When the DataView folder is open, find the file Setup.exe located in the USB drive root directory and double-click it to run the installation program.
3. The DataView setup screen appears. In the upper left corner of the screen, choose the language version of the Setup interface. (All Setup screens and dialogs will immediately appear in the selected language.) In the lower left corner are the available installation options. In addition to the DataView software, you can select "Adobe Reader." This links to the Adobe web site where you can download the latest version of Reader. This program is required to view DataView .pdf documents. The option Firmware Upgrades links to the website where you can check for new firmware updates for the instrument. Finally, User Manuals displays a list of .pdf files contained in the USB drive that accompanies DataView. (DataView also comes with a Help system that is installed with the program files.) To install DataView, select DataView in the Options list and click Install.
4. After a few moments a screen appears asking you whether or not you want to allow the DataView Setup program to make changes to your computer. Click OK.
5. Select the language version of DataView you want to install (English, French, or Spanish) then click Next. (By default, the language selected in step 3 is highlighted.)
6. You are now prompted to select the software you want to install. Each AEMC product family has its own specially designed Control Panel. If you are performing a Complete install, by default all available Control Panels are selected (a check mark next to a Control Panel indicates it is selected). Control Panels take up disk space on the computer; so unless you have other types of AEMC instruments, we recommend that you select PowerPad III and deselect the rest. You should also check the option DataView Core, which is a requirement if you plan to create DataView reports.
After you finish selecting and deselecting Control Panels and/or DataView Core, click Next.
7. The Setup program now informs you that it is ready to install DataView. If you want to review any of your previous selections, click the Previous button to return to earlier screens. Otherwise, click Install to begin installation.
8. The InstallShield program installs the selected software. If an earlier version of the software is already installed on your computer, for each selected program the InstallShield program will:
 - (a) Ask you to confirm the installation of the program. Click Next.
 - (b) Display a status bar indicating the progress of the installation.
 - (c) Inform you when the program is installed. Click Finish to install the next selected program.If the software is not installed (or if the installed software is the same version as the selected software), the software is installed without requesting confirmation.

When all programs are installed, a message appears informing you of this. Click Finish to return to the Setup screen.

9. You can now select additional Setup options to install (see step 3 above). When finished, click Exit.
10. The DataView folder now appears on your computer desktop. This contains the DataView icon  along with the PowerPad III Control Panel icon  and the icon(s) for any other AEMC product Control Panel(s) you installed.

13.2. POWERPAD III CONTROL PANEL

Clicking the PowerPad III Control Panel icon  opens the PowerPad III Control Panel:

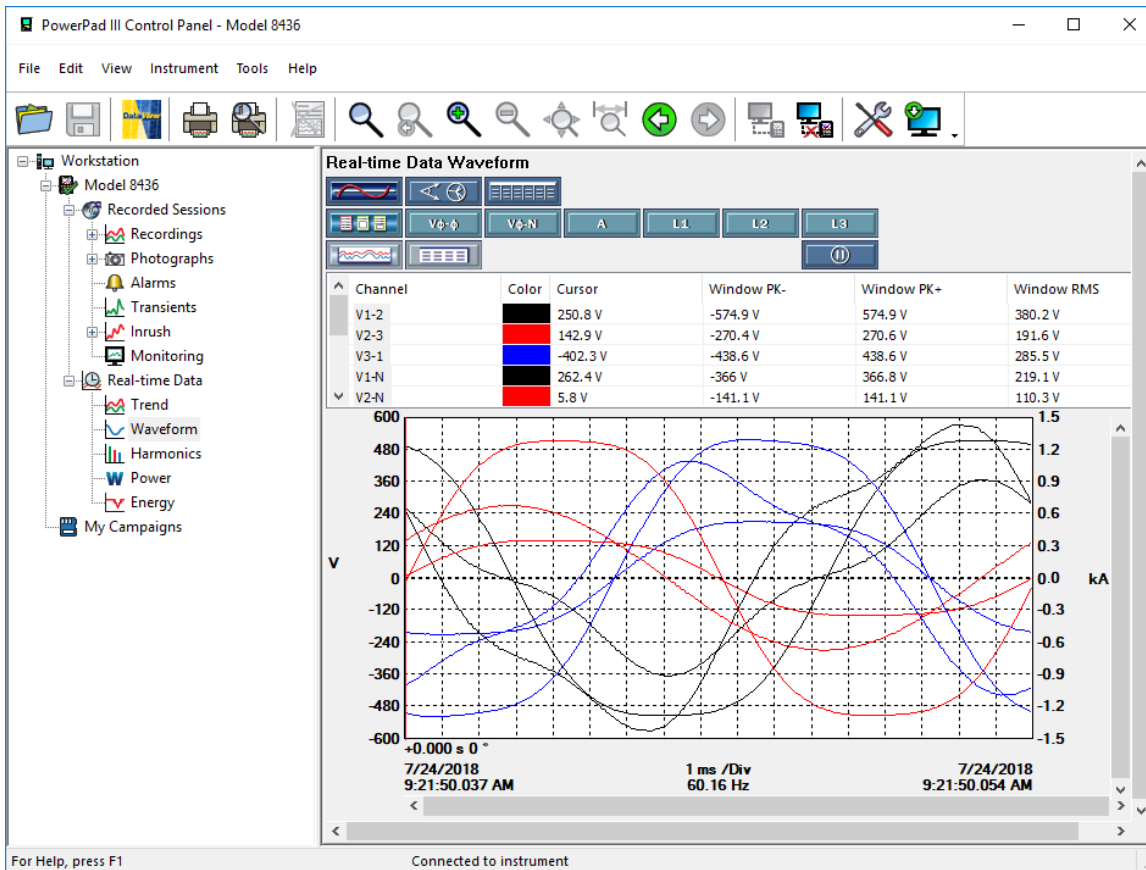

Figure 13-1

In general, core DataView features are for creating, viewing, editing, and storing DataView reports; while the PowerPad III Control Panel is for connecting to, configuring, viewing measurements on, and downloading data from the instrument. You can access all DataView features through either the DataView icon or the Control Panel icon. For users who interact with PowerPad III instruments, we recommend primarily using the PowerPad III Control Panel. However, there are situations where using the core DataView icon may be more convenient for some users, such as when viewing multiple archived reports from different AEMC product families.

For further information about using the PowerPad III Control Panel, consult the Help system that comes with the product. Access this Help by (1) pressing F1, or (2) clicking the option Help in the PowerPad III Control Panel's menu bar at the top of the screen.

13.3. CONNECTING TO A COMPUTER

Before you can use the PowerPad III Control Panel to communicate with your instrument, you must establish a connection between the instrument and the computer. To begin, ensure that you have installed DataView with the PowerPad III Control Panel. Also ensure that the instrument is connected to the computer via the provided USB cable. When you make this connection, drivers are installed as part of the DataView installation process.

If you need assistance during the connection process, press the Help button.

After the instrument is successfully connected, consult the PowerPad III Control Panel Help system for instructions about viewing real-time data on the instrument, downloading and viewing recorded sessions, creating DataView reports from the downloaded data, and configuring the instrument.

14. GENERAL SPECIFICATIONS

14.1. ENVIRONMENTAL CONDITIONS

The following chart shows conditions relating to ambient temperature and humidity:

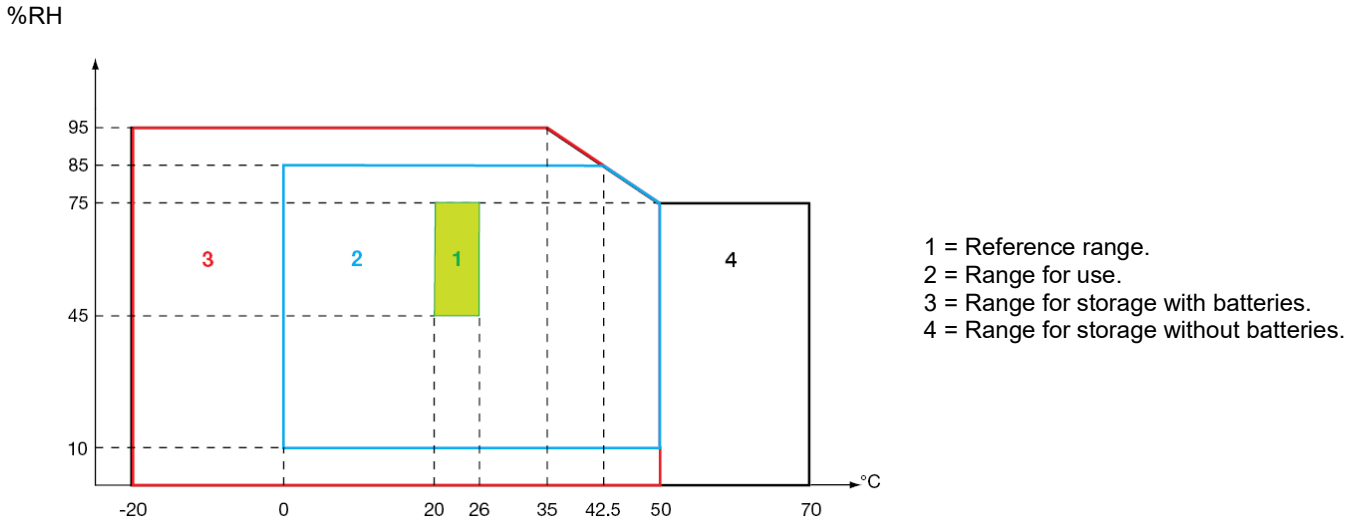

NOTE: At temperatures above 104°F (40°C), the instrument must be powered by the battery alone **OR** by the external power unit alone. The instrument must not be used with both the battery **AND** external power.

Altitude :
 Use < 6560' (2000 m)
 Storage < 32,800' (10,000 m)
 Degree of pollution: 2
 Use indoors

14.2. MECHANICAL CONDITIONS

Dimensions (L x W x H) 10.6" x 9.8" x 7.1" (270 mm x 250 mm x 180 mm)
 Weight approximately 8.16 lbs (3.7 kg)
 Screen 4.65" x 3.54" (118 mm x 90 mm), diagonal 5.82" (148 mm)

Ingress protection IP 67 per EN 60529 with the housing closed and the protecting plugs on the terminals.
 IP 54 with cover open, instrument not in operation (terminals not connected and nothing pressed on the keyboard).
 IP 50 with cover open and instrument in operation.

Fall 40" (1m) on each edge as per IEC 61010-1

14.3. OVERVOLTAGE CATEGORIES PER IEC 61010-1

The instrument is compliant with IEC 61010-1, 600 V category IV or 1000 V category III.

- AmpFlex®, MiniFlex®, or SR193 clamps keeps the "device + current sensor" system at 600 V category IV or 1000 V category III.
- MR193, J93, MN93, MN193, or SL261 clamps downgrades the "device + current sensor" system to 300 V category IV or 600 V category III.
- 5 A adapter downgrades the "device + current sensor" system to 150 V category IV or 300 V category III.

Double insulation between the inputs/outputs and earth.

Double insulation between the voltage inputs, the power supply, and the other inputs/outputs.

14.4. ELECTROMAGNETIC COMPATIBILITY

Emissions and immunity in an industrial setting compliant with IEC 61326-1.

For electromagnetic emissions, the instrument belongs to group 1, class A, under standard EN55011. Class A devices are intended for use in industrial environments. There may be difficulties ensuring electromagnetic compatibility in other environments, because of conducted and radiated disturbance.

For immunity to radio frequency fields, the instrument is intended for use at industrial sites under standard IEC61326-1.

For the AmpFlex® and MiniFlex® sensors:

- An (absolute) influence of 2% may be observed on the current THD measurement in the presence of a radiated electric field.
- Influence of 0.5 A may be observed on the RMS current measurement in the presence of conducted radio frequencies.
- Influence of 1 A may be observed on the RMS current measurement in the presence of a magnetic field.

14.5. POWER SUPPLY

14.5.1. EXTERNAL POWER SUPPLY

Range of use: 110 to 1000 V and DC to 440 Hz.

Input current: 0.8 A_{RMS} maximum

14.5.2. BATTERY POWER SUPPLY

The instrument is supplied by a 9.6 V, 4000 mAh battery pack, consisting of eight rechargeable NiMH elements.

Battery	8 NiMH storage cells
Capacity	4000 mAh nominal
Nominal voltage	1.2 V per cell, 9.6 V total
Life	at least 300 charge-discharge cycles
Charging current	1 A
Charging time	approximately 5 hours
Service T°	32 to 122 °F (0 to 50 °C)
Charging T°	50 to 104 °F (10 to 40 °C)
Storage T°	storage ≤ 30 days: -4 to 122 °F (-20 to 50 °C) storage for 30 to 90 days: -4 to 104 °F (-20 to 40 °C) storage for 90 days to 1 year: -4 to 86 °F (-20 to 30 °C)

If the instrument is to be left unused for an extended period, remove the battery (see § 16.3).

14.5.3. CONSUMPTION

Typical consumption of the instrument on external power (mA)	Battery charging	Battery charged
Active power (W)	17	6
Apparent power (VA)	30	14
RMS current (mA)	130	60

14.5.4. BATTERY LIFE

Battery life is 10 hours when the battery delivered with the instrument is fully charged, with the display screen ON. If the display screen is OFF (saving energy), battery life is more than 15 hours.

14.5.5. DISPLAY UNIT

The display unit is an active matrix (TFT) LCD type with the following specifications:

- 5.7" diagonal
- resolution 320 x 240 pixels (1/4 VGA)
- color
- minimum luminosity 210 cd/m², typical 300 cd/m²
- response time between 10 and 25 ms
- angle of view 80° in all directions
- excellent rendering from 32 to 122°F (0 to 50°C)

15. FUNCTIONAL SPECIFICATIONS

15.1. REFERENCE CONDITIONS

This table indicates the reference conditions of the quantities used by default in the specifications listed in § 15.3.4.

Parameter	Reference conditions
Ambient temperature	73 ± 5 °F (23 ± 3 °C)
Humidity (relative humidity)	[45 %; 75 %]
Atmospheric pressure	[860 hPa; 1060 hPa]
Phase-to-neutral voltage	[50 V _{RMS} ; 1000 V _{RMS}] without DC (< 0.5 %)
Standard current circuit input voltage (Except Flex [®] type current sensors)	[30 mV _{RMS} ; 1 V _{RMS}] without DC (< 0.5 %) <ul style="list-style-type: none"> ■ $A_{nom} \Leftrightarrow 1 V_{RMS}$ ■ $3 \times A_{nom}^{(1)} \div 100 \Leftrightarrow 30 mV_{RMS}$
Unamplified Rogowski current circuit input voltage (Flex [®] type current sensors)	[11.73 mV _{RMS} ; 391 mV _{RMS}] without DC (< 0.5 %) <ul style="list-style-type: none"> ■ $10 kA_{RMS} \Leftrightarrow 391 mV_{RMS}$ to 50 Hz ■ $300 A_{RMS} \Leftrightarrow 11.73 mV_{RMS}$ to 50 Hz
Amplified Rogowski current circuit input voltage (Flex [®] type current sensors)	[117.3 μV _{RMS} ; 3.91 mV _{RMS}] without DC (< 0.5 %) <ul style="list-style-type: none"> ■ $100 A_{RMS} \Leftrightarrow 3.91 mV_{RMS}$ to 50 Hz ■ $3 A_{RMS} \Leftrightarrow 117.3 \mu V_{RMS}$ to 50 Hz
Frequency of electrical network	50 Hz ± 0.1 Hz or 60 Hz ± 0.1 Hz
Phase shift	0° (active power and energy) 90° (reactive power and energy)
Harmonics	< 0.1 %
Voltage unbalance	< 10 %
Voltage ratio	1 (unity)
Current ratio	1 (unity)
Voltages	measured (not calculated)
Current sensors	actual (not simulated)
Power supply	Battery only
Electric field	< 1 V.m ⁻¹ for [80 MHz ; 1 GHz] ≤ 0.3 V.m ⁻¹ for [1 GHz ; 2 GHz] ≤ 0.1 V.m ⁻¹ for [2 GHz ; 2.7 GHz]
Magnetic field	< 40 A.m ⁻¹ DC (earth's magnetic field)

(1) The values of A_{nom} are given in the table below.

15.2. NOMINAL CURRENT ACCORDING TO TYPE OF SENSOR

Current sensor (except Flex [®])	Nominal RMS current (A_{nom}) [A]	Lower limit of the reference range ($3 \times A_{nom} \div 100$) [A]
J93 clamp	3500	105
SR193 clamp	1000	30
MR193 clamp	1000	30
MN93 clamp	200	6
MN193 clamp (100 A)	100	3
SL261 clamp (10 mV/A)	100	3
SL261 clamp (100 mV/A)	10	0.3
MN193 clamp (5 A)	5	0.15
5 A adapter	5	0.15

15.3. ELECTRICAL CHARACTERISTICS

15.3.1. VOLTAGE INPUT CHARACTERISTICS

Range for use: 0 V_{RMS} to 1000 V_{RMS} AC+DC phase-to-neutral and neutral-to-earth.
 0 V_{RMS} to 2000 V_{RMS} AC+DC phase-to-phase.
 (on condition of compliance with 1000 V_{RMS} with respect to earth in Cat III).
 Input impedance: 1195 $k\Omega$ (between phase and neutral and between neutral and earth).
 Admissible overload: 1200 V_{RMS} constant.
 2000 V_{RMS} for one second.

15.3.2. CURRENT INPUT CHARACTERISTICS

Operating range: [0 V; 1 V]
 Input impedance: 1 $M\Omega$.
 Admissible overload: 1.7 V_{RMS} constant.

Flex® type current sensors (AmpFlex® and MiniFlex®) switch the current input to an integrator assembly (amplified or unamplified Rogowski channel) capable of interpreting the signals from Rogowski sensors. The input impedance is reduced to 12.4 $k\Omega$ in this case.

15.3.3. BANDWIDTH

Measurement channels: 256 points per period, i.e.:

- 50 Hz: 6.4 kHz (256 × 50 ÷ 2).
- 60 Hz: 7.68 kHz (256 × 60 ÷ 2).

Analogue 3-dB bandwidth: 76 kHz.

15.3.4. INSTRUMENT SPECIFICATIONS (EXCLUDING CURRENT SENSOR)

Quantities concerning currents and voltages

Measurement		Measurement range without ratio (with unity ratio)		Display resolution (with unity ratio)	Maximum intrinsic error
		Minimum	Maximum		
Frequency ⁽⁷⁾		40 Hz	70 Hz	10 mHz	±10 mHz
RMS voltage ⁽⁵⁾	simple	2 V	1000 V ⁽¹⁾	100 mV V < 1000 V	±(0.5% + 200 mV)
				1 V V ≥ 1000 V	±(0.5% + 1 V)
	compound	2 V	2000 V ⁽²⁾	100 mV U < 1000 V	±(0.5% + 200 mV)
				1 V U ≥ 1000 V	±(0.5% + 1 V)
Direct voltage (DC) ⁽⁶⁾	simple	2 V	1200 V ⁽³⁾	100 mV V < 1000 V	±(1% + 500 mV)
				1 V V ≥ 1000 V	±(1% + 1 V)
	compound	2 V	2400 V ⁽³⁾	100 mV U < 1000 V	±(1% + 500 mV)
				1 V U ≥ 1000 V	±(1% + 1 V)
RMS ½ voltage	simple	2 V	1000 V ⁽¹⁾	100 mV V < 1000 V	±(0.8% + 1 V)
				1 V V ≥ 1000 V	
	compound	2 V	2000 V ⁽²⁾	100 mV U < 1000 V	±(0.8% + 1 V)
				1 V U ≥ 1000 V	
Peak voltage	simple	2 V	1414 V ⁽⁴⁾	100 mV V < 1000 V	±(3% + 2 V)
				1 V V ≥ 1000 V	
	compound	2 V	2828 V ⁽⁴⁾	100 mV U < 1000 V	±(3% + 2 V)
				1 V U ≥ 1000 V	
Severity of short-term flicker (PST)		0	12	0.01	See corresponding table
Severity of long-term flicker (PLT)		0	12	0.01	Uncertainty of PST
Peak factor (PF) (voltage and current)		1	9.99	0.01	±(1% + 5 ct) CF < 4
					±(5% + 2 ct) CF ≥ 4

- (1) Limitation of the MR193 and SL261 clamps
- (2) Two-phase (opposite phases) – same note as (1)
- (3) Limitation of the voltage inputs
- (4) $1000 \times \sqrt{2} \approx 1414$; $2000 \times \sqrt{2} \approx 2828$
- (5) Total RMS value and RMS value of the fundamental
- (6) DC harmonic component ($n=0$)
- (7) For voltages > 5 V

Measurement		Measurement range without ratio (with unity ratio)		Display resolution (with unity ratio)	Maximum intrinsic error
		Minimum	Maximum		
RMS current ⁽²⁾	J93 clamp	3 A	3500 A	1 A	$\pm(0.5\% + 1 \text{ A})$
	SR193 clamp MR193 clamp	1 A	1000 A	100 mA $A < 1000 \text{ A}$	$\pm(0.5\% + 200 \text{ mA})$
				1 A $A \geq 1000 \text{ A}$	$\pm(0.5\% + 1 \text{ A})$
	MN93 clamp	200 mA	200 A	100 mA	$\pm(0.5\% + 200 \text{ mA})$
	SL261 clamp (10 mV/A) MN193 clamp (100 A)	100 mA	100 A	10 mA $A < 100 \text{ A}$	$\pm(0.5\% + 20 \text{ mA})$
				100 mA $A \geq 100 \text{ A}$	$\pm(0.5\% + 100 \text{ mA})$
	SL261 clamp (100 mV/A)	10 mA	10 A	1 mA $A < 10 \text{ A}$	$\pm(0.5\% + 2 \text{ mA})$
				10 mA $A \geq 10 \text{ A}$	$\pm(0.5\% + 10 \text{ mA})$
	MN193 clamp (5 A)	5 mA	5 A	1 mA	$\pm(0.5\% + 2 \text{ mA})$
	AmpFlex ^{®(4)} MiniFlex ^{®(4)} (10 kA)	10 A	10 kA	1 A $A < 10 \text{ kA}$	$\pm(0.5\% + 3 \text{ A})$
10 A $A \geq 10 \text{ kA}$					
AmpFlex ^{®(4)} MiniFlex ^{®(4)} (6500 A)	10 A	6500 A	100 mA $A < 1000 \text{ A}$	$\pm(0.5\% + 3 \text{ A})$	
			1 A $A \geq 1000 \text{ A}$		
AmpFlex ^{®(4)} MiniFlex ^{®(4)} (100 A)	100 mA	100 A	10 mA $A < 100 \text{ A}$	$\pm(0.5\% + 30 \text{ mA})$	
			100 mA $A \geq 100 \text{ A}$		
Direct current (DC) ⁽³⁾	J93 clamp	3 A	5000 A	1A	$\pm(1\% + 1 \text{ A})$
	MR193 clamp	1 A	1300 A ⁽¹⁾	100 mA $A < 1000 \text{ A}$	$\pm(1\% + 1 \text{ A})$
				1 A $A \geq 1000 \text{ A}$	
	SL261 clamp (10 mV/A)	100 mA	100 A ⁽¹⁾	10 mA $A < 100 \text{ A}$	$\pm(1\% + 100 \text{ mA})$
100 mA $A \geq 100 \text{ A}$					
SL261 clamp (100 mV/A)	10 mA	10 A ⁽¹⁾	1 mA $A < 10 \text{ A}$	$\pm(1\% + 10 \text{ mA})$	
			10 mA $A \geq 10 \text{ A}$		

(1) In 1000 VRMS, category III, provided that the voltage between each of the terminals and earth does not exceed 1000 VRMS

(2) Total RMS value and RMS value of the fundamental

(3) DC harmonic component ($n=0$)

(4) Sensors compatible with the instrument (see §1.2)

Measurement		Measurement range without ratio (with unity ratio)		Display resolution (with unity ratio)	Maximum intrinsic error
		Minimum	Maximum		
RMS ½ current	J93 clamp	1 A	3500 A	1 A	±(1% + 1 A)
	SR193 clamp MR193 clamp	1 A	1200 A	100 mA A < 1000 A	±(1% + 1 A)
				1 A A ≥ 1000 A	
	MN93 clamp	200 mA	240 A	100 mA	±(1% + 1 A)
	SL261 clamp (10 mV/A) MN193 clamp (100 A)	0.1 A	120 A	10 mA A < 100 A	±(1% + 100 mA)
				100 mA A ≥ 100 A	
	SL261 clamp (100 mV/A)	10 mA	12 A	1 mA A < 10 A	±(1% + 10 mA)
				10 mA A ≥ 10 A	
	MN193 clamp (5 A)	5 mA	6 A	1 mA	±(1% + 10 mA)
AmpFlex ^{®(2)} MiniFlex ^{®(2)} (10 kA)	10 A	10 kA	1 A A < 10 kA	±(2.5% + 5 A)	
			10 A A ≥ 10 kA		
AmpFlex ^{®(2)} MiniFlex ^{®(2)} (6500 A)	10 A	6500 A	100 mA A < 1000 A	±(2.5% + 5 A)	
			1 A A ≥ 1000 A		
AmpFlex ^{®(2)} MiniFlex ^{®(2)} (100 A)	100 mA	100 A	10 mA A < 100 A	±(2.5% + 200 mA)	
			100 mA A ≥ 100 A		
Peak current (PK)	J93 clamp	1 A	4950 A ⁽¹⁾	1 A	±(1% + 2 A)
	SR193 clamp MR193 clamp	1 A	1414 A ⁽¹⁾	1 A A < 1000 A	±(1% + 2 A)
				1 A A ≥ 1000 A	
	MN93 clamp	200 mA	282.8 A ⁽¹⁾	100 mA	±(1% + 2 A)
	SL261 clamp (10 mV/A) MN193 clamp (100 A)	100 mA	141.4 A ⁽¹⁾	10 mA A < 100 A	±(1% + 200 mA)
				100 mA A ≥ 100 A	
	SL261 clamp (100 mV/A)	10 mA	14.14 A ⁽¹⁾	1 mA A < 10 A	±(1% + 20 mA)
				10 mA A ≥ 10 A	
	MN193 clamp (5 A)	5 mA	7.071 A ⁽¹⁾	1 mA	±(1% + 20 mA)
AmpFlex ^{®(2)} MiniFlex ^{®(2)} (10 kA)	10 A	14.14 kA ⁽¹⁾	1 A A < 10 kA	±(3% + 5 A)	
			10 A A ≥ 10 kA		
AmpFlex ^{®(2)} MiniFlex ^{®(2)} (6500 A)	10 A	9192 kA ⁽¹⁾	100 mA A < 1000 A	±(3% + 5 A)	
			1 A A ≥ 1000 A		
AmpFlex ^{®(2)} MiniFlex ^{®(2)} (100 A)	100 mA	141.4 A ⁽¹⁾	10 mA A < 100 A	±(3% + 600 mA)	
			100 mA A ≥ 100 A		

(1) $3500 \times \sqrt{2} \approx 4,950$; $1000 \times \sqrt{2} \approx 1,414$; $200 \times \sqrt{2} \approx 282.8$; $100 \times \sqrt{2} \approx 141.4$; $10 \times \sqrt{2} \approx 14.14$; $10,000 \times \sqrt{2} \approx 14,140$; $6,500 \times \sqrt{2} \approx 9192$

(2) Sensors compatible with the instrument (see §1.2).

Quantities concerning powers and energies

Measurement		Measurement range without ratio (with unity ratio)		Display resolution (with unity ratio)	Maximum intrinsic error
		Minimum	Maximum		
Active power (P) ⁽¹⁾	Excluding Flex [®]	10 mW ⁽³⁾	10 MW ⁽⁴⁾	4 digits at most ⁽⁵⁾	$\pm(1\%)$ $\cos \Phi \geq 0.8$
	AmpFlex [®] MiniFlex [®]				$\pm(1.5\% + 10 \text{ ct})$ $0.2 \leq \cos \Phi < 0.8$
Reactive power (Q ₁) ⁽²⁾ and non-active (N)	Excluding Flex [®]	10 mvar ⁽³⁾	10 Mvar ⁽⁴⁾	4 digits at most ⁽⁵⁾	$\pm(1\%)$ $\sin \Phi \geq 0.5$
	AmpFlex [®] MiniFlex [®]				$\pm(1.5\% + 10 \text{ ct})$ $0.2 \leq \sin \Phi < 0.5$
Distortion power (D) ⁽⁷⁾	Excluding Flex [®]	10 mvar ⁽³⁾	10 Mvar ⁽⁴⁾	4 digits at most ⁽⁵⁾	$\pm(1\%)$ $\sin \Phi \geq 0.5$
	AmpFlex [®] MiniFlex [®]				$\pm(1.5\%)$ $\sin \Phi \geq 0.5$
				if $\forall n \geq 1, \tau_n \leq (100 + n) [\%]$	
				or	
				$\pm(2\% + (n_{\max} \times 0.5\%) + 100 \text{ ct})$ $\text{THD}_A \leq 20\% f$	
				$\pm(2\% + (n_{\max} \times 0.7\%) + 10 \text{ ct})$ $\text{THD}_A > 20\% f$	
Apparent power (S)		10 mVA ⁽³⁾	10 MVA ⁽⁴⁾	4 digits at most ⁽⁵⁾	$\pm(1\%)$
DC power (Pdc)		20 mVA ⁽⁸⁾	6 MVA ⁽⁹⁾	4 digits at most ⁽⁵⁾	
Peak factor (PF)		-1	1	0.001	$\pm(1.5\%)$ $\cos \Phi \geq 0.5$
Active energy (Ph) ⁽¹⁾	Excluding Flex [®]	1 MWh	9,999,999 MWh ⁽⁶⁾	7 digits at most ⁽⁵⁾	$\pm(1.5\% + 10 \text{ ct})$ $0.2 \leq \cos \Phi < 0.8$
	AmpFlex [®] MiniFlex [®]				$\pm(1\%)$ $\cos \Phi \geq 0.8$
Reactive energy (Q h) ⁽²⁾ and non-active energy (N) ⁽²⁾	Excluding Flex [®]	1 mvarh	9,999,999 Mvarh ⁽⁶⁾	7 digits at most ⁽⁵⁾	$\pm(1.5\%)$ $0.5 \leq \cos \Phi < 0.8$
	AmpFlex [®] MiniFlex [®]				$\pm(1\%)$ $\sin \Phi \geq 0.5$
				$\pm(1.5\%)$ $0.2 \leq \sin \Phi < 0.5$	
Distortion energy (Dh)		1 mvarh	9,999,999 Mvarh ⁽⁶⁾	7 digits at most ⁽⁵⁾	$\pm(2.5\%)$ $0.2 \leq \sin \Phi < 0.5$
				$\pm(5.5\%)$ $\text{THD}_A \leq 20\% f$	
				$\pm(1.5\%)$ $\text{THD}_A > 20\% f$	
Apparent energy (Sh)		1 MVAh	9,999,999 MVAh ⁽⁶⁾	7 digits at most ⁽⁵⁾	$\pm(1\%)$
DC energy (Pdch)		1 MWh	9,999,999 MWh ⁽¹⁰⁾	7 digits at most ⁽⁵⁾	

- (1) Stated uncertainties on active power and energy measurements are maxima for $|\cos \Phi| = 1$ and typical for other phase differences.
- (2) Stated uncertainties on reactive power and energy measurements are maxima for $|\sin \Phi| = 1$ and typical for other phase shifts.
- (3) With MN193 clamp (5 A)
- (4) With AmpFlex® or MiniFlex® for a 2-wire single-phase connection (phase-to-ground voltage).
- (5) Resolution depends on the current sensor used and on the value to be displayed.
- (6) Energy is equivalent to more than 114 years of the associated maximum power (unity ratios).
- (7) n_{\max} is the highest order for which the harmonic ratio is non-zero.
- (8) With SL261 clamp (100 mV/A).
- (9) With J93 clamp, for a 2-wire single-phase connection (phase-to-ground voltage).
- (10) Energy corresponds to more than 190 years at maximum power P_{dc} (unit ratios).

Quantities associated with power

Measurement	Measurement range		Display resolution	Maximum intrinsic error
	Minimum	Maximum		
Phase differences of fundamentals	-179°	180°	1°	±2°
cos Φ (DPF)	-1	1	0.001	±1° for Φ ±5 ct for cos Φ
tan Φ	-32.77 ⁽¹⁾	32.77 ⁽¹⁾	0.001 tan $\Phi < 10$	±1° for Φ
			0.01 tan $\Phi \geq 10$	
Voltage unbalance (UNB)	0%	100%	0.1%	±3 ct UNB ≤ 10%
				±10 ct UNB > 10%
Current unbalance (UNB)	0%	100%	0.1%	±10 ct

- (1) $|\tan \Phi| = 32,767$ corresponds to $\Phi = \pm 88.25^\circ + k \times 180^\circ$ (k being a natural number)

Quantities concerning the spectral composition of the signals

Measurement	Measurement range		Display resolution	Maximum intrinsic error
	Minimum	Maximum		
Voltage harmonic ratio (τ_n)	0 %	1500 %f 100 %r	0.1 % $\tau_n < 1000$ %	$\pm(2.5 \% + 5 \text{ ct})$
			1 % $\tau_n \geq 1000$ %	
Current harmonic ratio (τ_n) (non-Flex®)	0 %	1500 %f 100 %r	0.1 % $\tau_n < 1000$ %	$\pm(2 \% + (n \times 0.2 \%) + 10 \text{ ct})$ $n \leq 25$
			1 % $\tau_n \geq 1000$ %	$\pm(2 \% + (n \times 0.6 \%) + 5 \text{ ct})$ $n > 25$
Current harmonic ratio (τ_n) (AmpFlex® & MiniFlex®)	0 %	1500 %f 100 %r	0.1 % $\tau_n < 1000$ %	$\pm(2 \% + (n \times 0.3 \%) + 5 \text{ ct})$ $n \leq 25$
			1 % $\tau_n \geq 1000$ %	$\pm(2 \% + (n \times 0.6 \%) + 5 \text{ ct})$ $n > 25$
Total voltage harmonic distortion (THD) (referred to the fundamental) of voltage	0 %	999.9 %	0.1 %	$\pm(2.5 \% + 5 \text{ ct})$
Total current harmonic distortion (THD) (referred to the fundamental) of current (non-Flex®)	0 %	999.9 %	0.1 %	$\pm(2.5 \% + 5 \text{ ct})$ if $\forall n \geq 1. \tau_n \leq (100 \div n)$ [%]
				or
				$\pm(2 \% + (n_{\max} \times 0.2 \%) + 5 \text{ ct})$ $n_{\max} \leq 25$
Total current harmonic distortion (THD) (referred to the fundamental) of current (AmpFlex® & MiniFlex®)	0 %	999.9 %	0.1 %	$\pm(2.5 \% + 5 \text{ ct})$ if $\forall n \geq 1. \tau_n \leq (100 \div n^2)$ [%]
				or
				$\pm(2 \% + (n_{\max} \times 0.3 \%) + 5 \text{ ct})$ $n_{\max} \leq 25$
Total voltage harmonic distortion (THD) (referred to the signal without DC) of voltage	0 %	100 %	0.1 %	$\pm(2.5 \% + 5 \text{ ct})$
				or
				$\pm(2 \% + (n_{\max} \times 0.2 \%) + 5 \text{ ct})$ $n_{\max} \leq 25$
Total current harmonic distortion (THD) (referred to the signal without DC) of current (non-Flex®)	0 %	100 %	0.1 %	$\pm(2.5 \% + 5 \text{ ct})$ if $\forall n \geq 1. \tau_n \leq (100 \div n)$ [%]
				or
				$\pm(2 \% + (n_{\max} \times 0.5 \%) + 5 \text{ ct})$ $n_{\max} > 25$
Total current harmonic distortion (THD) (referred to the signal without DC) of current (AmpFlex® & MiniFlex®)	0 %	100 %	0.1 %	$\pm(2.5 \% + 5 \text{ ct})$ if $\forall n \geq 1. \tau_n \leq (100 \div n^2)$ [%]
				or
				$\pm(2 \% + (n_{\max} \times 0.6 \%) + 5 \text{ ct})$ $n_{\max} > 25$
Harmonic loss factor (FHL)	1	99.99	0.01	$\pm(5 \% + (n_{\max} \times 0.4 \%) + 5 \text{ ct})$ $n_{\max} \leq 25$
				$\pm(10 \% + (n_{\max} \times 0.7 \%) + 5 \text{ ct})$ $n_{\max} > 25$
K factor (FK)	1	99.99	0.01	$\pm(5 \% + (n_{\max} \times 0.4 \%) + 5 \text{ ct})$ $n_{\max} \leq 25$
				$\pm(10 \% + (n_{\max} \times 0.7 \%) + 5 \text{ ct})$ $n_{\max} > 25$
Phase shifts of harmonics (order ≥ 2)	-179°	180°	1°	$\pm(1.5^\circ + 1^\circ \times (n + 12.5))$



NOTE: n_{\max} is the highest order for which the harmonic ratio is non-zero.

Measurement		Measurement range (with unity ratio)		Display resolution (with unity ratio)	Maximum intrinsic error
		Minimum	Maximum		
RMS harmonic voltage (order $n \geq 2$)	simple	2 V	1000 V ⁽¹⁾	100 mV $V < 1000 V$	$\pm(2.5 \% + 1 V)$
				1 V $V \geq 1000 V$	
	compound	2 V	2000 V ⁽²⁾	100 mV $U < 1000 V$	$\pm(2.5 \% + 1 V)$
				1 V $U \geq 1000 V$	
RMS distortion voltage	simple (Vd)	2 V	1000 V ⁽¹⁾	100 mV $V < 1000 V$	$\pm(2.5 \% + 1 V)$
				1 V $V \geq 1000 V$	
	compound (Ud)	2 V	2000 V ⁽²⁾	100 mV $U < 1000 V$	$\pm(2.5 \% + 1 V)$
				1 V $U \geq 1000 V$	
RMS harmonic current (order $n \geq 2$)	J93 clamp	1 A	3500 A	1 A	$\pm(2 \% + (n \times 0.2\%) + 1 A)$ $n \leq 25$
	SR193 clamp MR193 clamp	1 A	1000 A	100 mA $A < 1000 A$	$\pm(2 \% + (n \times 0.2\%) + 1 A)$ $n \leq 25$
				1 A $A \geq 1000 A$	$\pm(2 \% + (n \times 0.5\%) + 1 A)$ $n > 25$
	MN93 clamp	200 mA	200 A	100 mA	$\pm(2 \% + (n \times 0.2\%) + 1 A)$ $n \leq 25$
					$\pm(2 \% + (n \times 0.5\%) + 1 A)$ $n > 25$
	SL261 clamp (10 mV/A) MN193 clamp (100 A)	100 mA	100 A	10 mA $A < 100 A$	$\pm(2 \% + (n \times 0.2\%) + 100 mA)$ $n \leq 25$
				100 mA $A \geq 100 A$	$\pm(2 \% + (n \times 0.5\%) + 100 mA)$ $n > 25$
	SL261 clamp (100 mV/A)	10 mA	10 A	1 mA $A < 10 A$	$\pm(2 \% + (n \times 0.2\%) + 10 mA)$ $n \leq 25$
				10 mA $A \geq 10 A$	$\pm(2 \% + (n \times 0.5\%) + 10 mA)$ $n > 25$
	MN193 clamp (5A)	5 mA	5 A	1 mA	$\pm(2 \% + (n \times 0.2\%) + 10 mA)$ $n \leq 25$
					$\pm(2 \% + (n \times 0.5\%) + 10 mA)$ $n > 25$
	AmpFlex ^{®(4)} MiniFlex ^{®(4)} (10 kA)	10 A	10 kA	1 A $A < 10 kA$	$\pm(2 \% + (n \times 0.3\%) + 1 A + (A_{RMS}^{(3)} \times 0.1\%))$ $n \leq 25$
				10 A $A \geq 10 kA$	$\pm(2 \% + (n \times 0.6\%) + 1 A + (A_{RMS}^{(3)} \times 0.1\%))$ $n > 25$
	AmpFlex ^{®(4)} MiniFlex ^{®(4)} (6500 A)	10 A	6,500 A	100 mA $A < 1000 A$	$\pm(2 \% + (n \times 0.3\%) + 1 A + (A_{RMS}^{(3)} \times 0.1\%))$ $n \leq 25$
1 A $A \geq 1000 A$				$\pm(2 \% + (n \times 0.6\%) + 1 A + (A_{RMS}^{(3)} \times 0.1\%))$ $n > 25$	
AmpFlex ^{®(4)} MiniFlex ^{®(4)} (100 A)	100 mA	100 A	10 mA $A < 100 A$	$\pm(2 \% + (n \times 0.2\%) + 30 pt)$ $n \leq 25$	
			100 mA $A \geq 100 A$	$\pm(2 \% + (n \times 0.5\%) + 30 pt)$ $n > 25$	

(1) n_{max} is the highest order for which the harmonic ratio is non-zero.

(2) Two-phase (opposite phases) – same note as (1).

(3) RMS value of the fundamental.

(4) Sensors compatible with the instrument (see §1.2).

Measurement		Measurement range (with unity ratio)		Display resolution (with unity ratio)	Maximum intrinsic error
		Minimum	Maximum		
RMS distortion current (Ad) ⁽¹⁾	J93 clamp	1 A	3500 A	1 A	$\pm((n_{\max} \times 0.4\%) + 1 \text{ A})$
	SR193 clamp MR193 clamp	1 A	1000 A	100 mA A < 1000 A	$\pm((n_{\max} \times 0.4\%) + 1 \text{ A})$
				1 A A ≥ 1000 A	
	MN93 clamp	200 mA	200 A	100 mA	$\pm((n_{\max} \times 0.4\%) + 1 \text{ A})$
	SL261 clamp (10 mV/A) MN193 clamp (100 A)	0.1 A	100 A	10 mA A < 100 A	$\pm((n_{\max} \times 0.4\%) + 100 \text{ mA})$
				100 mA A ≥ 100 A	
	SL261 clamp (100 mV/A)	10 mA	10 A	1 mA A < 10 A	$\pm((n_{\max} \times 0.4\%) + 10 \text{ mA})$
				10 mA A ≥ 10 A	
	MN193 clamp (5 A)	5 mA	5 A	1 mA	$\pm((n_{\max} \times 0.4\%) + 10 \text{ mA})$
AmpFlex [®] (2) MiniFlex [®] (2) (10 kA)	10 A	10 kA	1 A A < 10 kA	$\pm((n_{\max} \times 0.4\%) + 1 \text{ A})$	
			10 A A ≥ 10 kA		
AmpFlex [®] (2) MiniFlex [®] (2) (6500 A)	10 A	6500 A	100 mA A < 1000 A	$\pm((n_{\max} \times 0.4\%) + 1 \text{ A})$	
			1 A A ≥ 1000 A		
AmpFlex [®] (2) MiniFlex [®] (2) (100 A)	100 mA	100 A	10 mA A < 100 A	$\pm(n_{\max} \times 0.5\%) + 30 \text{ pt})$	
			100 mA A ≥ 100 A		

(1) In 1000 V_{RMS}, category III, provided that the voltage between each of the terminals and earth does not exceed 1000 V_{RMS}.

(2) Sensors compatible with the instrument (see §1.2).

Severity of short-term flicker

Rectangular variations per minute (50% duty cycle)	Maximum intrinsic error of the short-term flicker severity measurement (PST)			
	120 V lamp 60 Hz network		230 V lamp 50 Hz network	
	PST ∈ [0.5 ; 4]	± 5%	PST ∈ [0.5 ; 4]	± 5%
1	PST ∈ [0.5 ; 5]	± 5%	PST ∈ [0.5 ; 5]	± 5%
2	PST ∈ [0.5 ; 7]	± 5%	PST ∈ [0.5 ; 8]	± 5%
7	PST ∈ [0.5 ; 12]	± 5%	PST ∈ [0.5 ; 10]	± 5%
39	PST ∈ [0.5 ; 12]	± 5%	PST ∈ [0.5 ; 10]	± 5%
110	PST ∈ [0.25 ; 12]	± 15%	PST ∈ [0.25 ; 10]	± 15%
1620				

Range of current and voltage ratios

Ratio	Minimum	Maximum
Voltage	$\frac{100}{1000 \times \sqrt{3}}$	$\frac{9,999,900 \times \sqrt{3}}{0.1}$
Current (1)	1	60,000 / 1

(1) Only for the MN193 clamp (5 A)

Measurement ranges after application of the ratios

Measurement		Measurement range	
		Minimum with minimum ratio(s)	Maximum with maximum ratio(s)
RMS & RMS ½ voltage	simple	120 mV	170 GV
	compound	120 mV	340 GV
Direct voltage (DC)	simple	120 mV	200 GV
	compound	120 mV	400 GV
Peak voltage (PK)	simple	160 mV	240 GV
	compound	320 mV	480 GV
RMS & RMS ½ current		5 mA	300 kA
Direct current (DC)		10 mA	5 kA
Peak current (PK)		7 mA	420 kA
Active power (P)		600 µW	51 PW (3)
DC power (Pdc)		1.2 mW	1 PW (3)
Reactive power (Q ₁) non-active (N) and distortion power (D)		600 µvar	51 Pvar (3)
Apparent power (S)		600 µVA	51 PVA (3)
Active energy (Ph)		1 mWh	9 999 999 EWh (1)
DC energy (Pdch)		1 mWh	9 999 999 EWh (2)
Reactive energy (Q ₁ h) non-active (Nh) and distortion energy (Dh)		1 mvarh	9 999 999 Evarh (1)
Apparent energy (Sh)		1 mVAh	9 999 999 EVAh (1)

(1) Energy corresponds to more than 22,000 years of the associated maximum power (maximum ratios).

(2) Energy Pdch corresponds to more than 1 million years at maximum power Pdc (maximum ratios).

(3) Maximum value calculated for a 2-wire single-phase connection (phase-to-ground voltage).

15.3.5. CURRENT SENSOR SPECIFICATIONS (AFTER LINEARIZATION)

Sensor errors are offset by a typical correction inside the instrument. This typical correction, applied to the phase and amplitude, depends on the type of sensor connected (detected automatically) and the gain in the current acquisition channel used.

The RMS current measurement error and phase error are additional errors (which must therefore be added to the instrument errors), indicated as influences on the calculations carried out by the analyzer (powers, energies, power factors, tangents, etc.).

Type of sensor	RMS current (Arms)	Maximum error for Arms	Maximum error for Φ
AmpFlex® ⁽¹⁾ 6500 A / 10 kA	[10 A ; 100 A[±3 %	±1°
	[100 A ; 10 kA]	±2 %	±0.5°
MiniFlex® ⁽¹⁾ 6500 A / 10 kA	[10 A ; 100 A[±3 %	±1°
	[100 A ; 10 kA]	±2 %	±0.5°
AmpFlex® ⁽¹⁾ 100 A	[100 mA ; 100 A]	±3 %	±1°
MiniFlex® ⁽¹⁾ 100 A	[100 mA ; 100 A]	±3 %	±1°
J93 clamp 3500 A	[3 A ; 50 A[-	-
	[50 A ; 100 A[±(2 % + 2.5 A)	±4°
	[100 A ; 500 A[±(1.5 % + 2.5 A)	±2°
	[500 A ; 2000 A[±1 %	±1°
	[2000 A ; 3500 A]	±1 %	±1.5°
]3500 A ; 5000 A] DC	±1 %	-
SR193 clamp 1000 A	[1 A ; 10 A[±0.8 %	±1°
	[10 A ; 100 A[±0.3 %	±0.5°
	[100 A ; 1000 A]	±0.2 %	±0.3°
MR193 clamp 1000 A	[1 A ; 10 A[±(1.5 % + 1 A)	-
	[10 A ; 100 A[±(1.5 % + 1 A)	±2°
	[100 A ; 200 A[±3 %	±1.5°
	[200 A ; 800 A[±3 %	±1.5°
	[800 A ; 1000 A[±5 %	±1.5°
]1000 A ; 1300 A] DC	±5 %	-
MN93 clamp 200 A	[200 mA ; 500 mA[-	-
	[500 mA ; 10 A[±(3 % + 1 A)	-
	[10 A ; 40 A[±(2.5 % + 1 A)	±3°
	[40 A ; 100 A[±(2.5 % + 1 A)	±3°
	[100 A ; 200 A]	±(1 % + 1 A)	±2°
MN193 clamp 100 A	[100 mA ; 1 A[±(0.7 % + 2 mA)	±1.5°
	[1 A ; 100 A]	±0.7 %	±0.7°
SL261 clamp (10 mV/A) 100A	[100 mA ; 40 A[±(2 % + 50 mA)	±0.5°
	[40 A ; 100 A]	±7.5 %	±0.5°
SL261 clamp (100 mV/A) 10A	[10 mA ; 10 A]	±(1.5 % + 50 mA)	±1°
Clamp MN193 5 A	[5 mA ; 50 mA[±(1 % + 100 μA)	±1.7°
	[50 mA ; 500 mA[±1 %	±1°
	[500 mA ; 5 A]	±0.7 %	±1°

(1) Sensors compatible with the instrument (see §1.2).



NOTE: This table does not take into account possible distortion of the measured signal (THD) because of the physical limitations of the current sensor (saturation of the magnetic circuit or of the Hall-effect cell). Class B under standard IEC61000-4-30.

Limitations of the AmpFlex® and MiniFlex®

Like all Rogowski sensors, the AmpFlex® and MiniFlex® have output voltage that is proportional to the frequency. A high current at high frequency can saturate the instrument's current input.

15.4. CLASS B UNDER STANDARD IEC 61000-4-30

15.4.1. INSTRUMENT CONFORMITY

The instrument and DataView PowerPad III Control Panel software are compliant with class B of standard IEC61000-4-30 for the following parameters:

- Industrial frequency
- Supply voltage amplitude
- Flicker
- Supply voltage brownouts
- Temporary overvoltages at industrial frequency
- Supply voltage blackouts
- Voltage transients
- Supply voltage unbalance
- Voltage harmonics

To ensure this compliance, trend recordings (Trend mode) must be made with:

- Recording period of one second
- Vrms and Urms selected
- V-h01 and U-h01 selected

15.4.2. UNCERTAINTIES AND MEASUREMENT RANGES

Parameter		Range	Uncertainty	U_{din}
Industrial frequency		[42.5 Hz ; 69 Hz]	± 10 mHz	[50 V ; 1000 V]
Supply voltage amplitude		[50 V ; 1000 V]	± 1 % of U_{din}	[50 V ; 1000 V]
Flicker		[0.25 ; 12]	See the corresponding tables	$V \in \{120 \text{ V} ; 230 \text{ V}\}$ $U \in \{207 \text{ V} ; 400 \text{ V}\}$
Supply voltage brownouts	Residual voltage	[5 % of U_{din} ; U_{din}]	± 2 % of U_{din}	[50 V ; 1000 V]
	Duration	[10 ms ; 65,535 days]	80 ppm ± 10 ms (maximum) 30 ppm ± 10 ms (typical)	
Temporary overvoltages at industrial frequency	Maximum amplitude	[U_{din} ; 150 % of U_{din}]	± 2 % of U_{din}	[50 V ; 1000 V]
	Duration	[10 ms ; 65,535 days]	80 ppm ± 10 ms (maximum) 30 ppm ± 10 ms (typical)	
Supply voltage blackouts	Duration	[10 ms ; 65,535 days]	80 ppm ± 10 ms (maximum) 30 ppm ± 10 ms (typical)	[50 V ; 1000 V]
Supply voltage unbalance		[0 % ; 10 %]	± 0.3 % or ± 3 ct	[50 V ; 1000 V]
Voltage harmonics	Rate	[0 % ; 1500 %]	$\pm(2.5$ % + 5 ct)	[50 V ; 1000 V]
	Voltage	[2 V ; 1000 V]	$\pm(2.5$ % + 1 V)	

15.4.3. REAL-TIME CLOCK UNCERTAINTY

The uncertainty of the real-time clock is 80 ppm at most (instrument 3 years old used at an ambient temperature of 122°F [50°C]). With a new instrument at 77°F (25°C), this uncertainty is only 30 ppm.

16. MAINTENANCE



Except for the battery and the memory card, the instrument contains no parts that can be replaced by personnel who have not been specially trained and accredited. Any unauthorized repair or replacement of a part by an “equivalent” may seriously impair safety.

16.1. CLEANING THE CASING

Disconnect the instrument from all connections and turn it OFF.

Use a soft cloth, dampened with soapy water. Rinse with a damp cloth and dry rapidly with a dry cloth or forced air. Do not use alcohol, solvents, or hydrocarbons.

16.2. SENSORS

Current sensors must be maintained as follows:

- Clean with a sponge and soapy water, rinse with a sponge and clean water, and dry rapidly.
- Keep the air gaps of the clamps (MN93, MN193, SR193, MR193 and SL261) perfectly clean using a cloth. Lightly oil visible metal parts to avoid rust.

16.3. BATTERY REPLACEMENT



To ensure safety, replace the battery only with the original model.

- Do not throw the battery into a fire.
- Do not expose the battery to a temperature in excess of 212°F (100°C).
- Do not short-circuit the terminals of the battery pack.

Remove the old battery.



To eliminate all risk of electric shock, disconnect the power supply cord and measurement leads of the instrument.

1. Using a Phillips screwdriver, remove the 6 screws of the battery compartment cover.

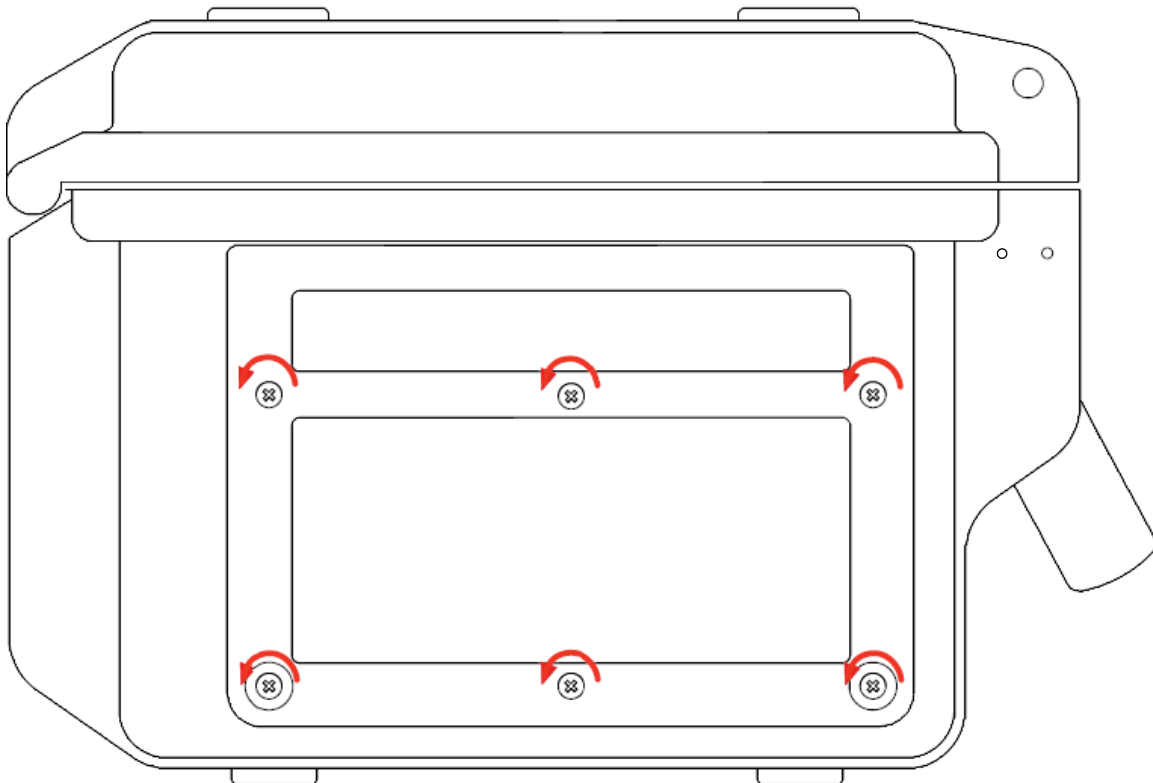

Figure 16-1

2. Remove the cover.

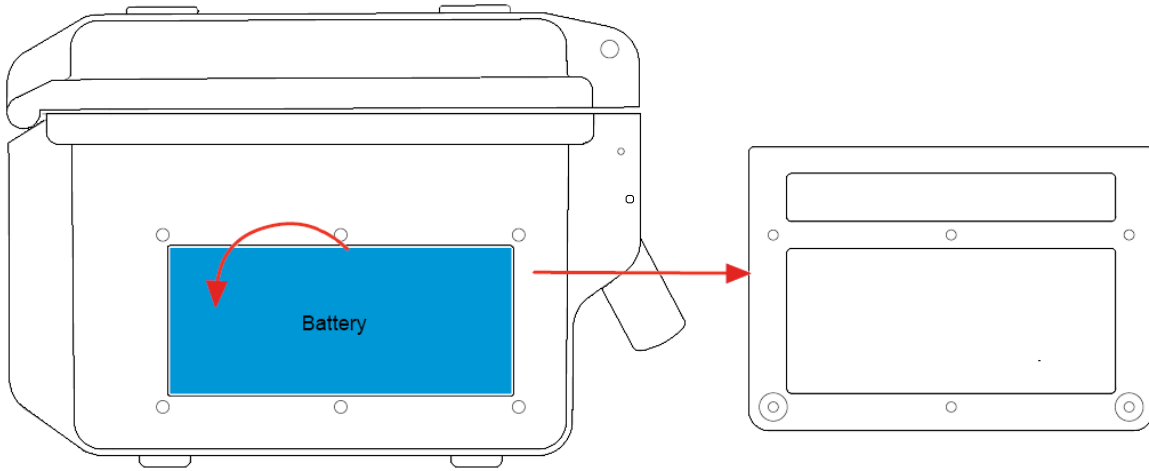

Figure 16-2

3. Tilt the top of the battery outward and remove it from its compartment.

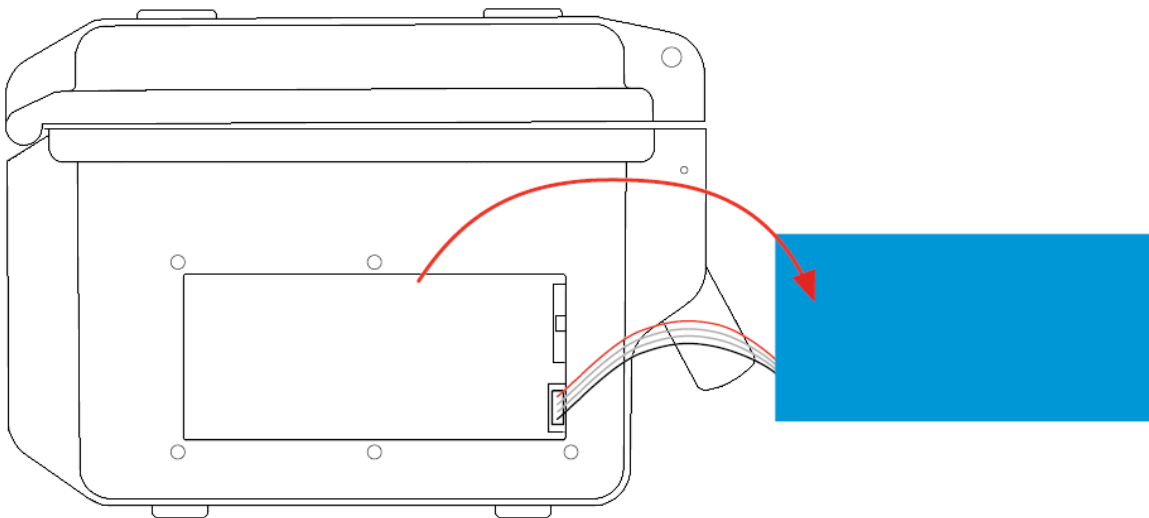

Figure 16-3

4. Disconnect the battery connector without pulling on the wires.

The instrument retains the date-time function for approximately 24 hours without the battery.



Spent batteries must not be treated as ordinary household waste. Take them to the appropriate recycling collection point.

Installing the new battery.

1. Connect the new battery. The connector is error-proofed to prevent reversals of polarity.
2. Place the bottom of the battery in its compartment, then the top. Arrange the wires so that they do not protrude.
3. Put the battery compartment cover back in place and screw the 6 screws back in.

! If the battery is disconnected, it must then be fully recharged, even if it is not replaced, so that the instrument can detect the battery charge condition (this information is lost when the battery is disconnected).

16.4. MEMORY CARD

The instrument accepts SD (SDSC), SDHC, and SDXC type memory cards. The card supplied with the instrument can store up to 8GB. (Note, however, that the maximum size of a trend recording is 2GB.)

Before removing or inserting the memory card, ensure the instrument is disconnected and powered OFF. Write-protect the memory card when you remove it from the instrument. Unlock write-protection before inserting the card back into the instrument.



To access the memory card, proceed as for the replacement of the battery.

1. Make sure that the instrument is disconnected and OFF.
2. Remove the cover and remove the battery from its compartment without disconnecting it.
3. Press on the memory card to release it, then press on the protecting tab to remove it from its slot. You can then grip the card.

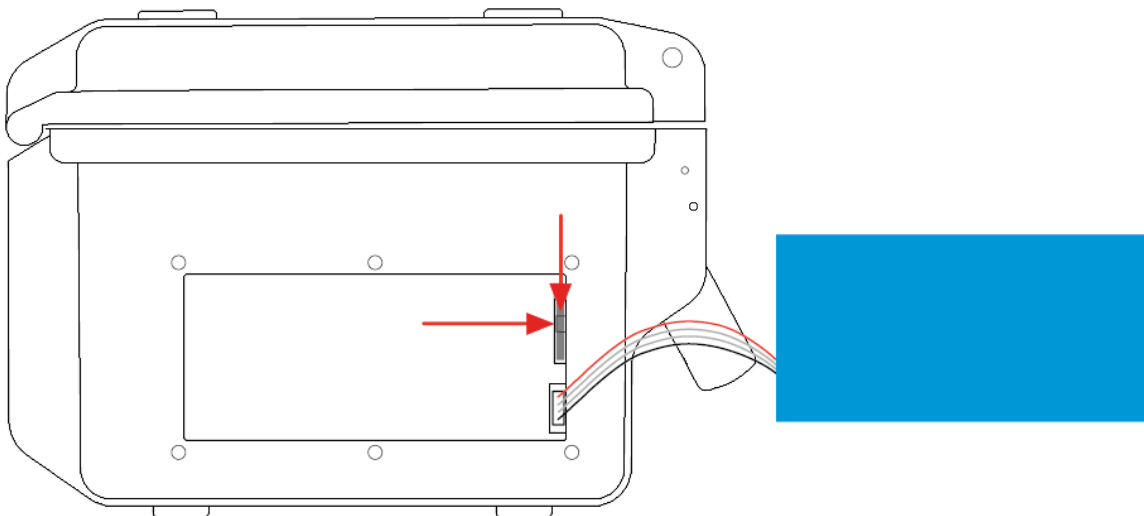

Figure 16-4

4. When you replace the memory card, the contacts must be on the left side and the locator down.

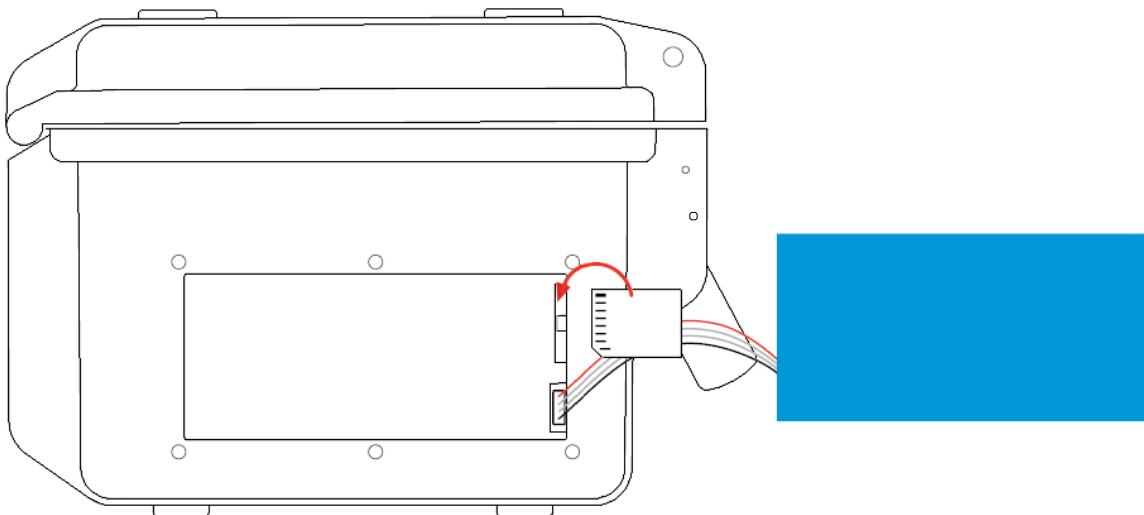





Figure 16-5

5. Insert the card into its slot until it snaps into place. The protecting tab is at the top of the card.
6. Put the battery back in its compartment and screw the cover back on.

16.5. FIRMWARE UPDATE

AEMC on occasion may update the firmware that controls instrument operation. These updates are available for free download. We recommend checking this site regularly and downloading updates as they become available. Upgrade instructions are included on the web site.

To check the current firmware revision running on your instrument, press  to display the Configuration menu, then select the  About option. This displays the About screen (see Figure 4-24), which includes the firmware version number currently running on the instrument. Compare this number against the firmware version posted on the AEMC Downloads site to determine whether or not your instrument should be updated.

 Firmware update erases all data (configuration, alarm campaigns, snapshots, inrush current capture, transient detection, trend recordings). Save any data you want to keep to a computer via the DataView PowerPad III Control Panel (see §13) before updating firmware.

17. POLE MOUNTING

Accessory brackets (Cat. #2137.82) enable you to mount the Model 8436 on a utility pole or similar structure.



To mount the instrument on a pole, turn it OFF and detach all leads and other connections. Then do the following:

1. Slide the brackets onto the bottom of the instrument.

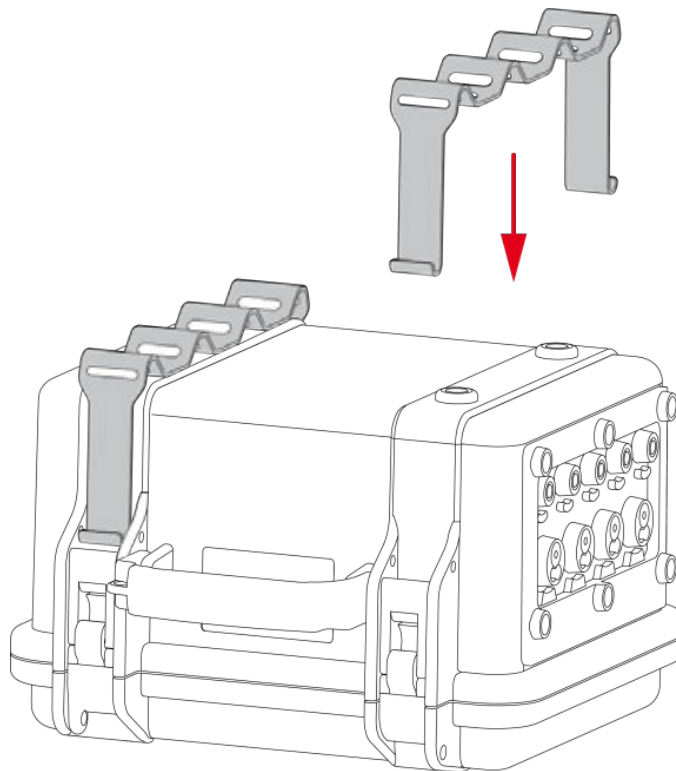

2. Attach the bracket by inserting the four connecting pins into the holes in the instrument case.

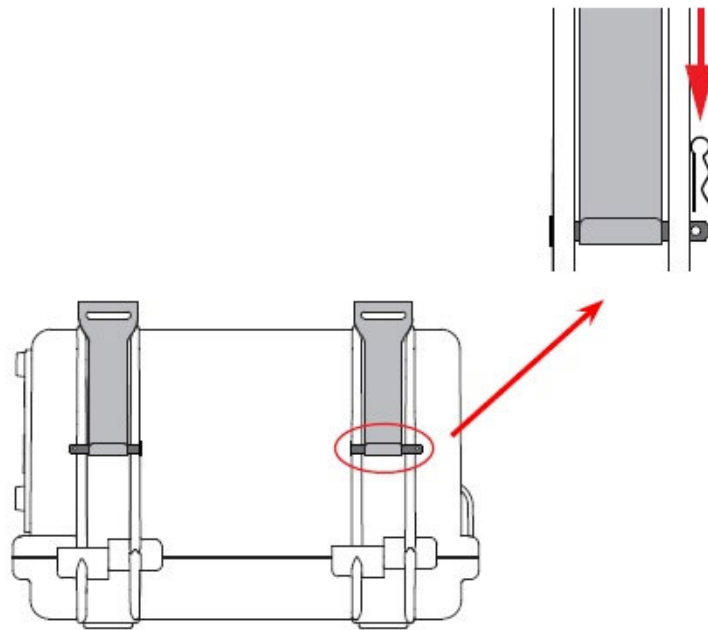

3. Insert the four clips into the holes in the pins.

4. Run two straps (not included) through the slots in the brackets. These slots are 1 x 0.157" (25.4 x 4mm).

5. Position the instrument on the pole, and attach it by fastening the straps.

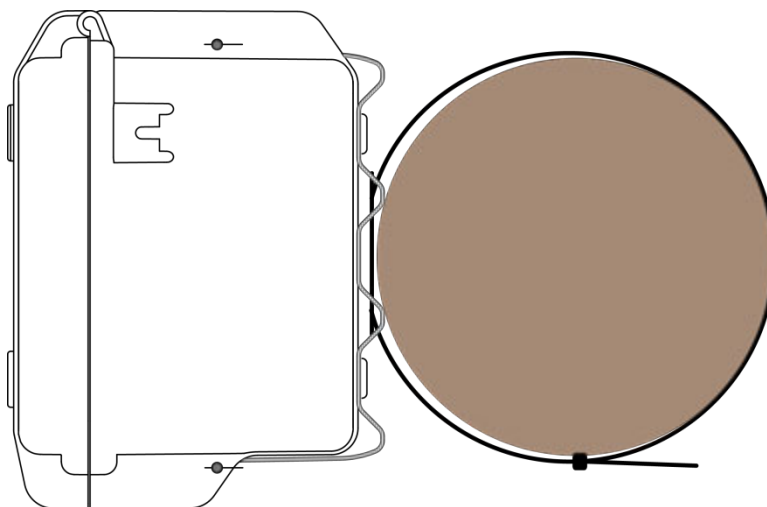

REPAIR AND CALIBRATION

To ensure that your instrument meets factory specifications, we recommend that it be scheduled back to our factory Service Center at one-year intervals for recalibration, or as required by other standards or internal procedures.

Costs for repair, standard calibration, and calibration traceable to N.I.S.T. are available.



NOTE: You must obtain a CSA# before returning any instrument.

TECHNICAL AND SALES ASSISTANCE

If you are experiencing any technical problems, or require any assistance with the proper operation or application of your instrument, please call, fax or e-mail our technical support team.

LIMITED WARRANTY

The instrument is warranted to the owner for a period of three years from the date of original purchase against defects in manufacture. This limited warranty is given by AEMC[®] Instruments, not by the distributor from whom it was purchased. This warranty is void if the instrument has been tampered with, abused, or if the defect is related to service not performed by AEMC[®] Instruments.

The warranty does not apply in the following cases:

- Inappropriate use of the equipment or use with incompatible equipment
- Modifications made to the equipment without the explicit permission of the manufacturer's technical staff
- Work done on the device by a person not approved by the manufacturer
- Adaptation to a particular application not anticipated in the definition of the equipment or not indicated in this user's manual
- Damage caused by shocks, falls, or floods

Please print the online Warranty Coverage Information for your records.

What AEMC[®] Instruments will do:

If a malfunction occurs within the warranty period, you may return the instrument to us for repair, provided we have your warranty registration information on file or a proof of purchase. AEMC[®] Instruments will, at its option, repair or replace the faulty material.



08/24

99-MAN 100480 v05

Chauvin Arnoux®, Inc. d.b.a. AEMC® Instruments