

C.A 6011













Continuity tester

Thank you for purchasing this **C.A 6011 continuity tester**

For best results from your instrument:

- **read** these operating instructions carefully,
- **comply** with the precautions for use.

	WARNING, risk of DANGER! The operator must refer to these instructions whenever this danger symbol appears.
	Information or useful tip.
	Earth.
	Equipment protected throughout by double insulation.
	Battery.
	The product has been declared recyclable after analysis of its life cycle in accordance with the ISO 14040 standard.
	Chauvin Arnoux has adopted an Eco-Design approach in order to design this appliance. Analysis of the complete lifecycle has enabled us to control and optimize the effects of the product on the environment. In particular this appliance exceeds regulation requirements with respect to recycling and reuse.
	
	The CE marking indicates conformity with European directives, in particular LVD and EMC.
	The rubbish bin with a line through it indicates that, in the European Union, the product must undergo selective disposal in compliance with Directive WEEE 2012/19/EU. This equipment must not be treated as household waste.

Definition of measurement categories

- Measurement category IV corresponds to measurements taken at the source of low-voltage installations.
Example: power feeders, counters and protection devices.
- Measurement category III corresponds to measurements on building installations.
Example: distribution panel, circuit-breakers, machines or fixed industrial devices.
- Measurement category II corresponds to measurements taken on circuits directly connected to low-voltage installations.
Example: power supply to domestic electrical appliances and portable tools.

PRECAUTIONS FOR USE

This instrument is compliant with safety standard IEC 61010-2-030, and the accessories are compliant with IEC 61010-031, for voltages up to 300V with respect to earth in measurement category IV. Failure to observe the safety instructions may result in electric shock, fire, explosion, and destruction of the instrument and of the installations.

- The operator and/or the responsible authority must carefully read and clearly understand the various precautions to be taken in use. The operator and/or the responsible authority must carefully read and clearly understand the various precautions to be taken in use. Sound knowledge and a keen awareness of electrical hazards are essential when using this instrument.
- Do not use the instrument on networks of which the voltage exceeds those mentioned.
- Never exceed the protection limits stated in the specifications.
- Observe the conditions of use, namely the temperature, the relative humidity, the altitude, the degree of pollution, and the place of use.
- Do not use the instrument if it seems to be damaged, incomplete, or poorly closed.
- Before each use, check the condition of the insulation on the leads, housing, and accessories. Any item of which the insulation is deteriorated (even partially) must be set aside for repair or scrapping.
- Use connection accessories of which the measurement category and operating voltage are greater than or equal to those of the measuring instrument (300V Cat. IV).
- When handling the leads, the probe tips, and crocodile clips, keep your fingers behind the physical guards.
- Use suitable means of protection.
- All troubleshooting and metrological checks must be done by competent, accredited personnel.

CONTENTS

1. FIRST USE	4
1.1. Delivery condition	4
1.2. Inserting the batteries	5
1.3. Fitting the wrist strap	5
2. PRESENTATION OF THE INSTRUMENT	6
2.1. Functions of the instrument	6
2.2. Display	7
2.3. Keypad	7
3. USE	8
3.1. Precautions for use.....	8
3.2. Checking the instrument	8
3.3. Preparing for measurements	8
3.4. Continuity measurement.....	8
3.5. Positioning the instrument	10
3.6. Resistance measurement.....	12
3.7. Errors.....	12
3.8. Disconnecting	12
4. TECHNICAL CHARACTERISTICS	13
4.1. Reference conditions.....	13
4.2. Electrical characteristics	13
4.3. Power supply	13
4.4. Environmental conditions	14
4.5. Mechanical characteristics	14
4.6. Compliance with international standards.....	14
4.7. Electromagnetic compatibility (CEM).....	14
5. MAINTENANCE	15
5.1. Cleaning	15
5.2. Replacement of the batteries.....	15
5.3. Adjusting the instrument	16
6. WARRANTY	17

1. FIRST USE

1.1. DELIVERY CONDITION

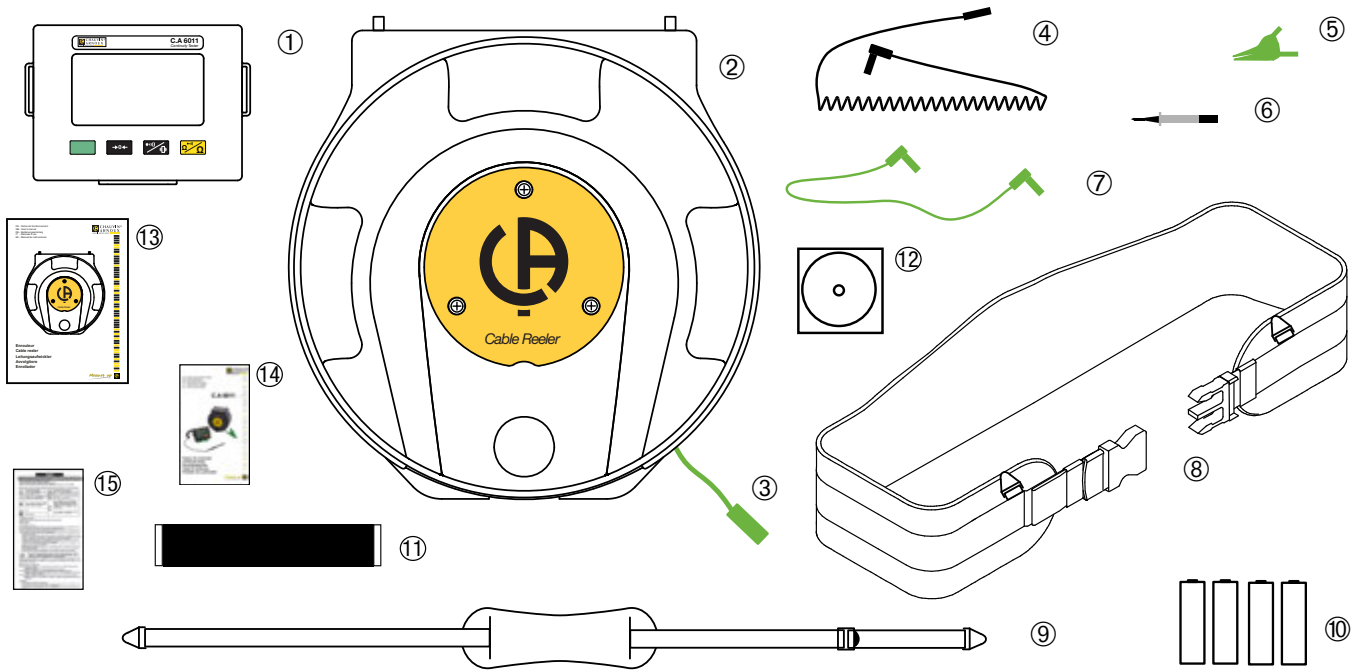

- ① One C.A 6011 continuity tester
- ② One take-up reel.
- ③ One green safety lead 30m long, elbow-straight.
- ④ One spiral-wound black safety lead, elbow-straight, 0.85 to 3.50m long.
- ⑤ One green crocodile clip.
- ⑥ One black probe tip.
- ⑦ One small green safety lead, elbow-elbow, 50cm long.
- ⑧ One belt to carry the take-up reel.
- ⑨ One shoulder strap to support the belt and take part of the weight of the take-up reel.
- ⑩ 4 LR6 or AA batteries.
- ⑪ One elastic wrist strap.
- ⑫ One user manual on mini CD-ROM (one file per language).
- ⑬ One user manual for the take-up reel.
- ⑭ One multilingual quick start guide.
- ⑮ One multilingual safety data sheet.

The two green safety leads have two layers of insulation of different colour, making it easy to see if the insulation is damaged.

The delivery condition depends on the model ordered. The instrument can be delivered with:

- One elastic wrist strap,
- 4 LR6 or AA batteries,
- One user manual on mini CD-ROM (one file per language),
- One multilingual quick start guide,
- One multilingual safety data sheet

1.2. INSERTING THE BATTERIES

- Use a screwdriver to unscrew the 2 screws of the battery compartment cover.
- Remove the battery compartment cover.

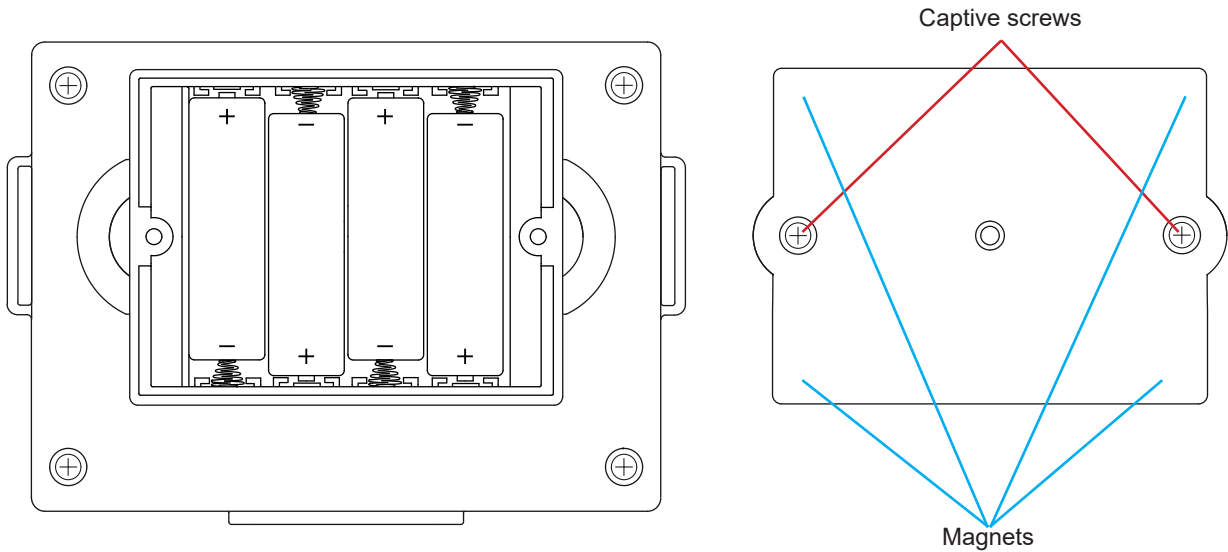

- Insert the new batteries, paying attention to the polarity.
- Close the battery compartment cover; make sure that it is completely and correctly closed.

1.3. FITTING THE WRIST STRAP

- Insert the metallic part of the strap in the belt loop of the instrument.
- Pass the strap under the instrument, then insert the other metallic part in the other belt loop.

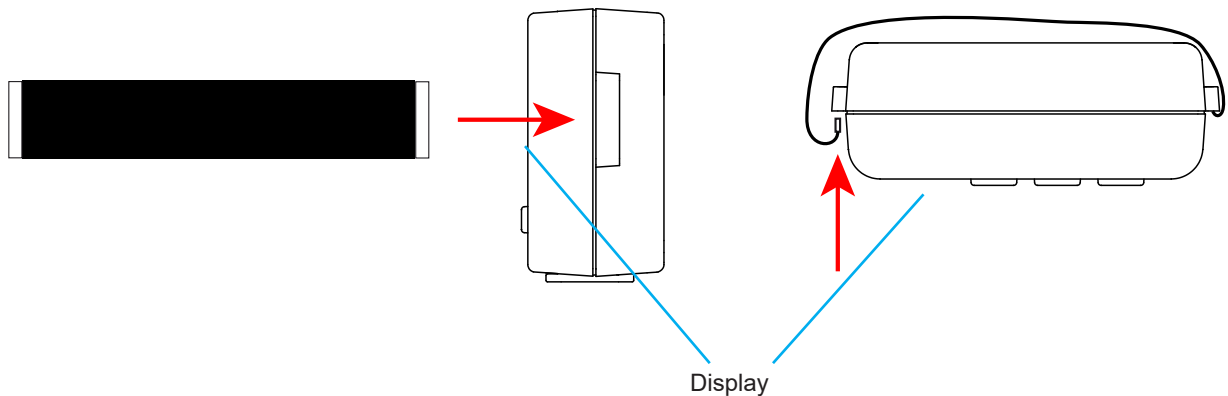

2. PRESENTATION OF THE INSTRUMENT

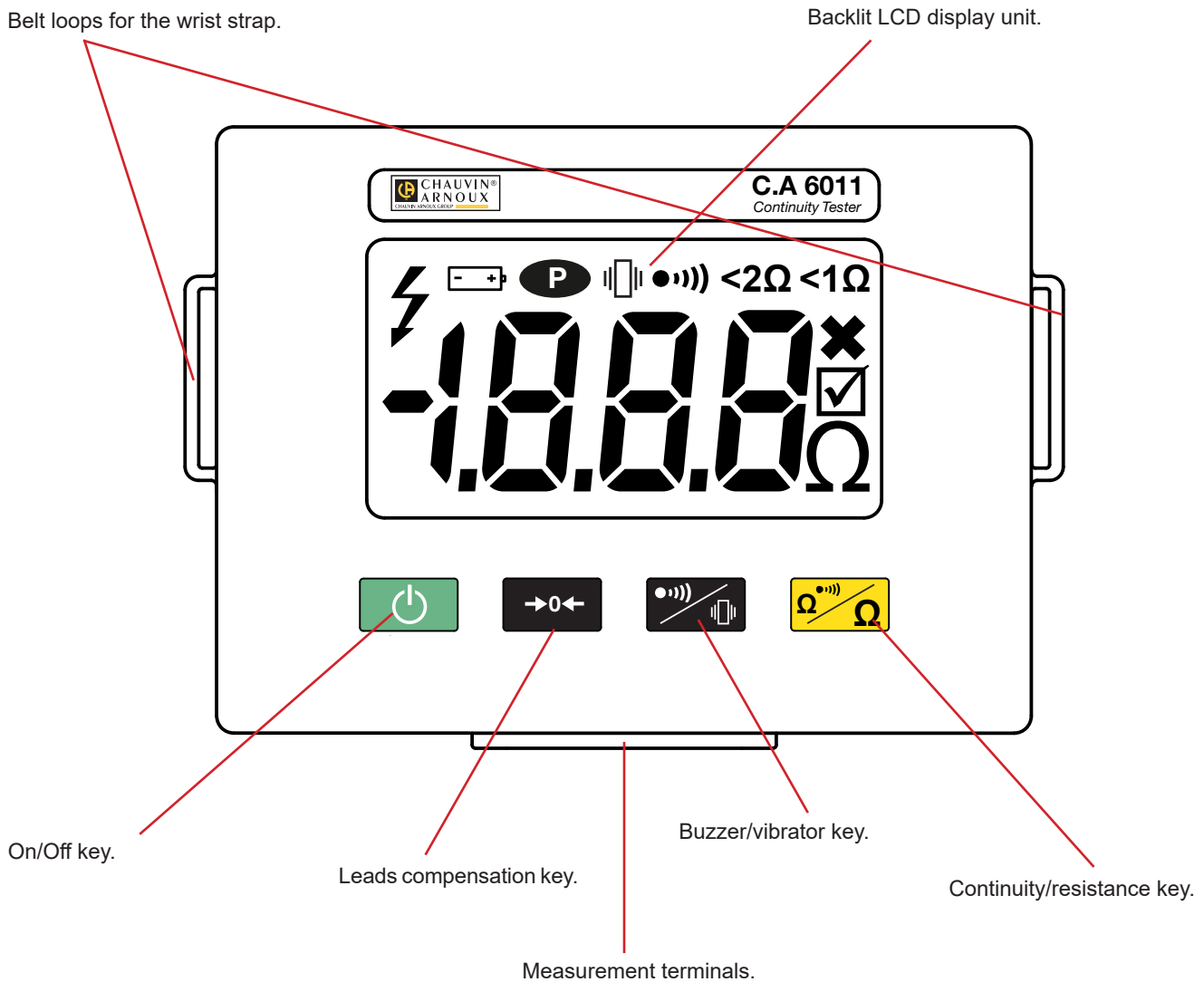

2.1. FUNCTIONS OF THE INSTRUMENT

The C.A 6011 continuity tester is a portable measuring instrument intended for continuity measurements per standard IEC 61557-4 and for resistance measurements. Powered by batteries.

- The C.A 6011 is used to make continuity measurements at 200mA. It reverses the current and calculates the mean automatically.
- It incorporates permanent compensation of the leads for more accurate measurements.
- To facilitate testing and make it possible to work in noisy environments, or to limit noise, as the case may be, the instrument reports that the continuity measurement is OK in several ways:
 - by the display unit,
 - by the colour of the backlighting,
 - by an audible signal,
 - by a vibration.
- It is protected against accidental overvoltages.
- The appropriate accessories facilitate the measurements.

2.2. DISPLAY



Indicates that a voltage is present on the terminals.



Indicates that the battery voltage is low, but you can still make 1000 measurements.



Indicates that auto off is deactivated: the instrument operates in permanent mode.



Indicates that the vibrator is active.



Indicates that the buzzer is active.



Indicates that the instrument is in continuity measurement mode and that the threshold is 2Ω.



Indicates that the instrument is in continuity measurement mode and that the threshold is 1Ω.



Indicates that the measurement is above the continuity threshold.



Indicates that the measurement is below the continuity threshold.

In continuity mode, the colour of the backlighting of the LCD display unit is:

- blue when the measurement is $<2\Omega$ (or $<1\Omega$).
- red when the measurement is $\geq 2\Omega$ (or $\geq 1\Omega$).

In resistance mode, the colour of the backlighting of the LCD display unit is blue when the measurement is $<200\Omega$. It is off when the measurement is $\geq 200\Omega$.

2.3. KEYPAD

- On/Off key
 - A short press on the On/Off key switches the instrument on or off.
 - A long press on the On/Off key activates or deactivates auto off (P symbol displayed).

When the instrument has not been used for 10 minutes, it automatically switches itself to standby, unless auto off has been deactivated (P symbol displayed).

The On/Off key does not protrude from the front panel of the instrument; this is in order to prevent its being pressed unintentionally.

- Continuity/resistance key
 - A short press on the continuity/resistance key toggles the measurement mode: continuity (the $<2\Omega$ or $<1\Omega$ symbol is displayed) or resistance.
 - A long press on the continuity/resistance key toggles the threshold: 1Ω ($<1\Omega$) or 2Ω ($<2\Omega$).

- Leads compensation key

In continuity mode, a long press on the leads compensation key subtracts the resistance of the leads from the measured value.

- Buzzer/vibrator key

In continuity mode, pressing the buzzer/vibrator key selects the type of signal when the measurement is below the threshold:

 - audible signal and display unit (display of the measurement and colour of the backlighting),
 - vibration and display unit (display of the measurement and colour of the backlighting),
 - audible signal accompanied by a vibration and display unit (display of the measurement and colour of the backlighting),
 - display unit only (display of the measurement and colour of the backlighting).



3. USE

3.1. PRECAUTIONS FOR USE







- Do not make a measurement on live objects.
- The measurements may be perturbed by impedances in parallel or by transient currents.
- Do not use the instrument in an explosive atmosphere or in the presence of flammable gases or vapours.

3.2. CHECKING THE INSTRUMENT

To ensure the validity of the measurements, the proper operation of the instrument must be checked regularly.

- Switch the instrument on by pressing the  key. Check that all segments of the LCD light for one second. The instrument then displays **OL**.
- If the  symbol is lit, you can still make 1000 measurements. But plan to replace the batteries (see § 5.2).
- Short-circuit the terminals; the instrument should display a measurement close to zero.

3.3. PREPARING FOR MEASUREMENTS

- Switch the instrument on by pressing the  key.
- Go to continuity mode by pressing the  key. The **<2Ω** symbol is displayed.
- Connect the leads you are going to use for the measurements and short-circuit them. The measurement is displayed. If it is less than 2Ω, the backlighting of the display unit turns blue and you can execute a compensation of the leads.
- This is done by a long press on the  key. The value displayed changes to 0. This compensation is recorded, and this operation will not have to be repeated until you change accessories.
- Choose your alarm mode by pressing the  key.
- Choose the continuity threshold (1Ω or 2Ω) by a long press on the  key. The  symbol **P** is displayed.

3.4. CONTINUITY MEASUREMENT

- Connect the spiral-wound lead to one of the terminals of the instrument. Connect the small lead to the other terminal of the instrument and to the terminal of the take-up reel.

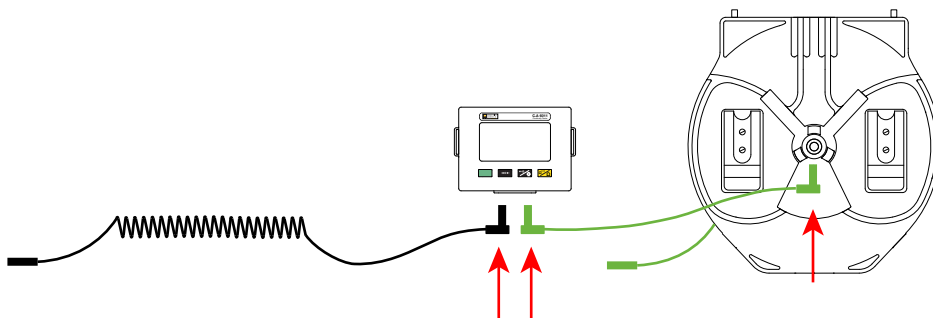

- Add the crocodile clip and the probe tip on the ends of the leads.

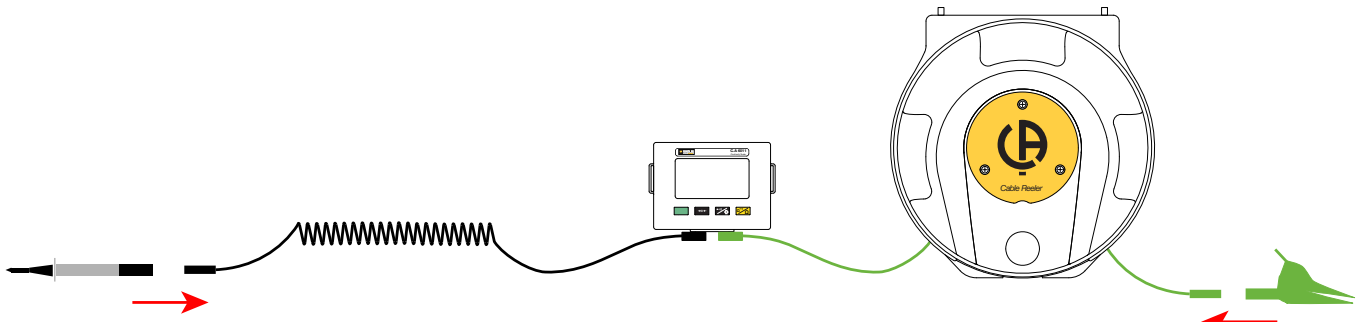

- Connect the crocodile clip to earth, preferably on the earth strip if it is accessible, or on the main bonding.



Concerning the correct way to make the measurements, always refer to the standard in force.

- Then place the probe tip on the object to be tested. The instrument makes one measurement with a current of +200mA and one measurement with a current of -200mA, then calculates and displays the mean of the two measurements.

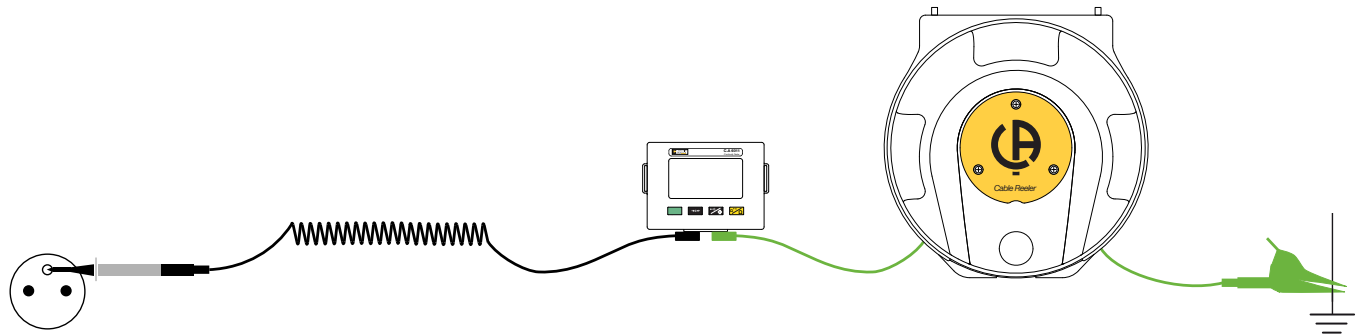

- Check the measurement by reading on the display unit, or observing the colour of the backlighting, or using the audible signal, or feeling the vibration.



Do not make a measurement on a live object. If the instrument detects a voltage $>6V$ on the object to be measured, measurement is disabled. The ⚡ symbol is displayed, the backlighting blinks red, and the instrument emits an audible signal and vibrates.

- Then go from measurement point to measurement point, letting the take-up reel pay out.

3.5. POSITIONING THE INSTRUMENT

The C.A 6011 is delivered with accessories intended to make the measurement process easier.

- Place the belt on your waist and adjust.
- Place the strap on your left shoulder (right shoulder if you are left-handed).

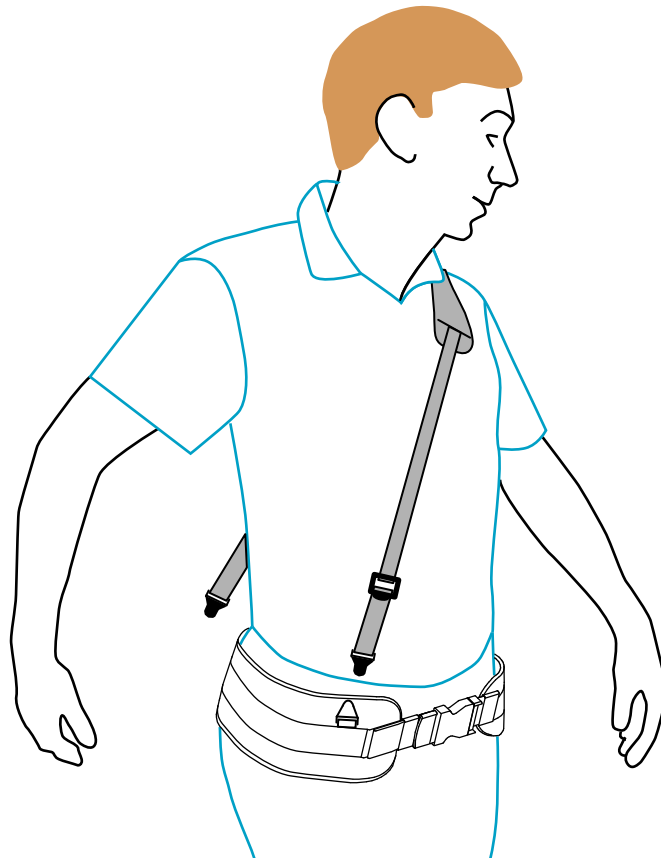

- Place the instrument on the take-up reel with the terminals towards the back of the reel. The locating studs fit into the four recesses in the instrument. The magnets hold the instrument in place. Then place the small green lead in the groove provided for this purpose.

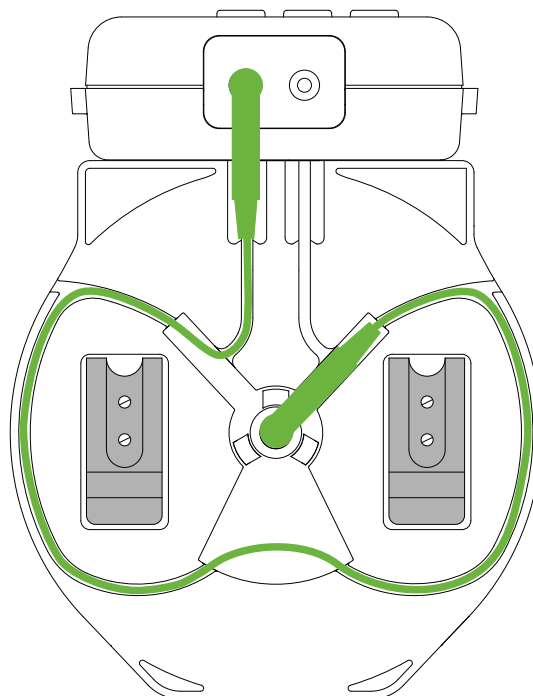



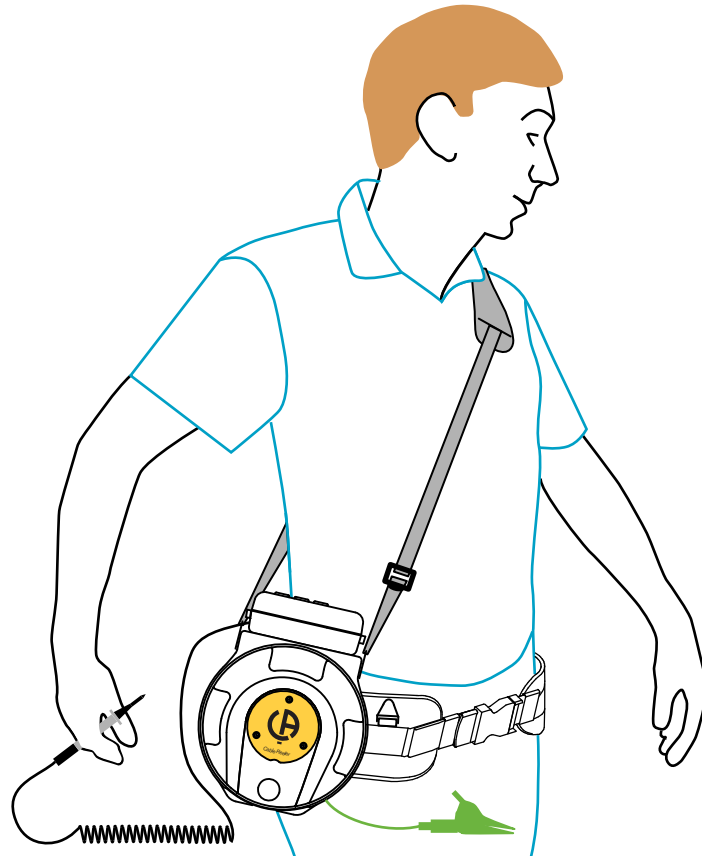

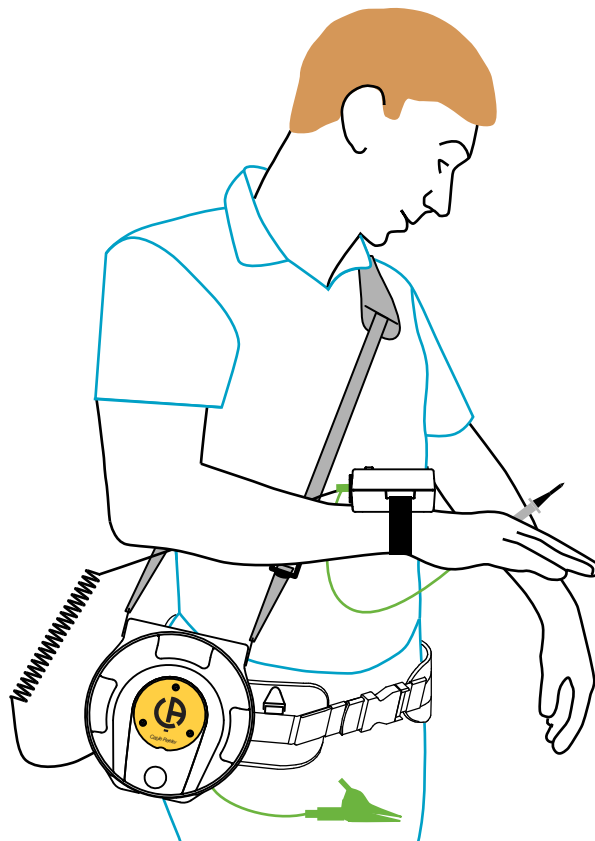

- Hook the take-up reel onto the belt, then hook the strap to the take-up reel and adjust. Your hands are free to hold the probe tip.



- If you use the display unit to check the continuity, place the instrument on your wrist using the elastic strap. Then interchange the spiral-wound lead and the small green lead.





3.6. RESISTANCE MEASUREMENT

- Switch the instrument on by pressing the  key.
- Switch to resistance measurement by pressing the  key. The <math><1\Omega</math>, <math><2\Omega</math>, , , , and  symbols disappear. There is no longer compensation of the leads.
- Connect the leads to the terminals of the instrument.
- Make measurements on objects that are not live.

3.7. ERRORS

- If the measurement is $\geq 20\Omega$ in continuity or $\geq 200\Omega$ in resistance, the instrument displays **OL**.
- In continuity mode, if the measurement displayed is negative, repeat the leads compensation procedure.
- In continuity mode, if the resistance of the leads to be compensated is greater than 5Ω , compensation is not possible.
- If there is a voltage $>6V$ on the object to be measured, measurement is disabled. The  symbol is displayed, the backlighting blinks red, and the instrument emits an audible signal and vibrates.

Here's an illustration of the display unit. In the first case, the measurement is OK (blue backlighting and display of the  symbol); in the second case, it is not OK (red backlighting and display of the  symbol).

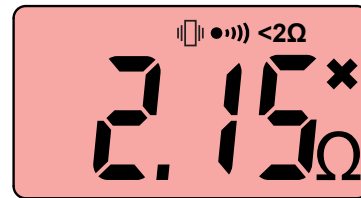
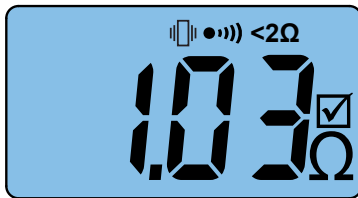

Here's an illustration of the display unit in the case of presence of a voltage $>6V$ in resistance measurement mode.

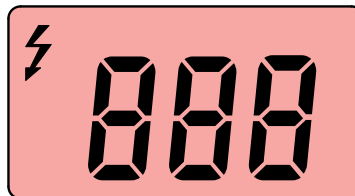

3.8. DISCONNECTING

At the end of the measurements, disconnect the leads, then switch off the instrument by pressing the  key.

4. TECHNICAL CHARACTERISTICS

4.1. REFERENCE CONDITIONS

Quantities of influence	Reference values
Temperature	23 ± 2 °C
Relative humidity	45 to 75 %RH
Supply voltage	5.8V ± 0.2V
Electric field	< 1V/m
Magnetic field	< 40A/m
Warmup time	≥ 5 minutes

The **intrinsic uncertainty** is the error defined under the conditions of reference.

This is expressed in % of the reading (R) and in number of display counts (ct):
 $\pm (a\% R + b.ct)$

4.2. ELECTRICAL CHARACTERISTICS

4.2.1. CONTINUITY AND RESISTANCE MEASUREMENTS

Particular conditions of reference

External Voltage on the terminals: zero.
 Resistance of the leads compensated.

	Continuity			Resistance
	0,02 - 0,49 Ω	0,50 - 1,99 Ω	2,00 - 19,99 Ω	1,0 - 199,9 Ω
Measurement range	0,02 - 0,49 Ω	0,50 - 1,99 Ω	2,00 - 19,99 Ω	1,0 - 199,9 Ω
Resolution	10 mΩ	10 mΩ	10 mΩ	100 mΩ
Measurement current	at least +200 mA / -200 mA	at least +200 mA / -200 mA	at least +20 mA / -20 mA	+10 mA
Intrinsic uncertainty	± 6 ct	± (10% R + 7 ct)		± (5% R + 7 ct)
Open-circuit voltage	± (4 VDC < U < 6 VDC)			

The instrument is protected against external voltages up to 300V. Above 6V, measurements are impossible.

Maximum compensation of the leads: 5Ω.

4.2.2. VARIATION IN THE DOMAIN OF USE

Quantities of influence	Limits of the range of use	Variation of the measurement	
		Typical	Maximum
Temperature	-10 to +50°C	± (1% R + 1 ct) / 10°C	± (2% R + 2 ct) / 10°C
Relative humidity	10 to 90 %RH without condensation	± (0,25% R + 2 ct)	± (0,5% R + 2 ct)
Supply voltage	4,1 to 6,4 V	± 1 ct	± 10 ct
AC voltage (50 Hz) in series	0 to 250 mV	0,4 %/mV	0,6 %/mV
DC voltage in series	0 to 250 mV	1 ct	5 ct
AC Voltage in common mode	230 V to 50 Hz	1 ct	2 ct

4.3. POWER SUPPLY

The instrument is powered by four 1.5V AA batteries (LR6 alkaline batteries). You can also use lithium batteries.
 The nominal operating voltage is lies between 4.1 and 6.4V.

Below 4.1V, the instrument cannot be switched on.

The average battery life is 30,000 0.8-second measurements every 10 seconds, and 1,000 measurements after the  symbol lights.

Or 4,500 5-second measurements every 25 seconds per standard IEC-61557-4.

The batteries can be replaced by NiMH rechargeable storage batteries of the same size. But because the voltage of the rechargeable batteries is lower than that of the primary batteries, the  symbol will be displayed at all times.

4.4. ENVIRONMENTAL CONDITIONS

Diagram of climatic conditions

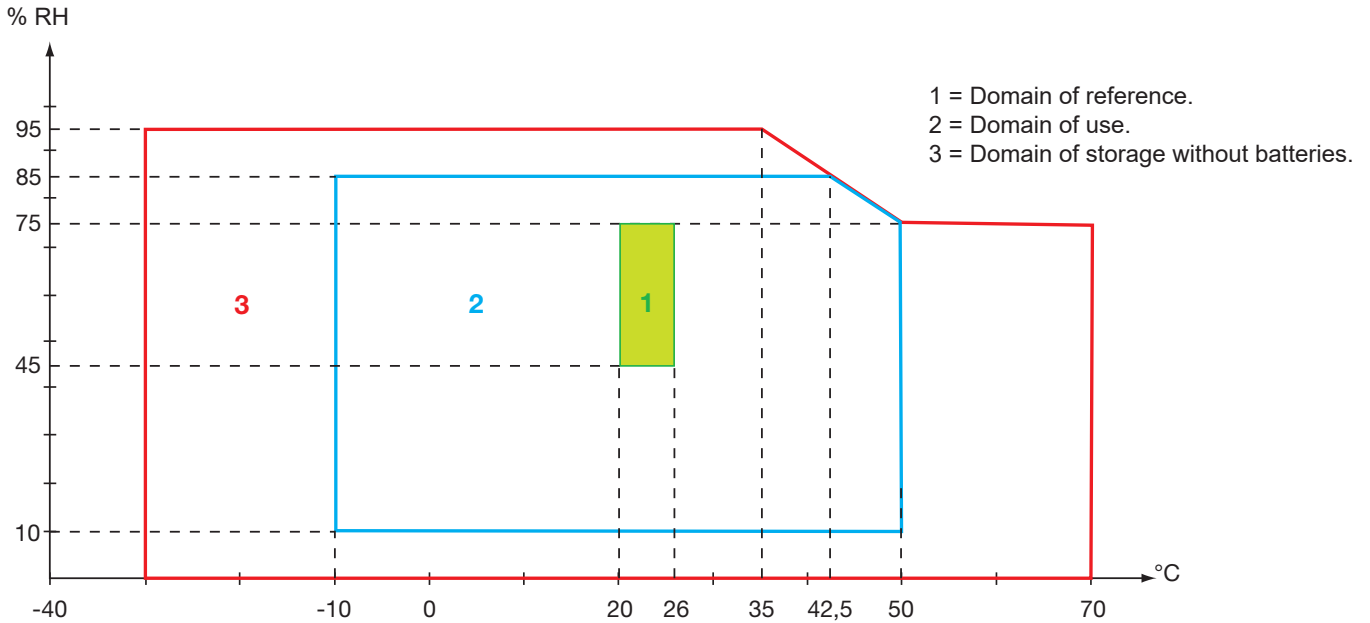

For indoor use, outdoor use without rain.

Altitude <2000m

Pollution degree 2

4.5. MECHANICAL CHARACTERISTICS

Dimensions (L x W x H) 225 x 185 x 135mm

Weight approximately 350g for the instrument and 1.2kg for the take-up reel with the 30m cable.

Ingress protection IP40 with the leads connected per IEC-60529.
IP20 without the leads per IEC-60529.

Drop test per IEC 61010-1

4.6. COMPLIANCE WITH INTERNATIONAL STANDARDS

The instrument is compliant with IEC 61557, parts 1 and 4.

The instrument is compliant with IEC 61010-1 and IEC 61010-2-030, 300V, category IV.

The accessories are compliant with IEC 61010-031, category IV 300V or higher.

4.7. ELECTROMAGNETIC COMPATIBILITY (CEM)

The device is compliant with standard IEC 61326-1.

5. MAINTENANCE



Except for the batteries, the instrument contains no parts likely to be replaced by personnel who are not specially trained and accredited. Any unauthorized repair or replacement of a part by an “equivalent” may gravely impair safety.

5.1. CLEANING

Disconnect everything connected to the instrument and switch it off.

Use a soft cloth, dampened with soapy water. Rinse with a damp cloth and dry rapidly with a dry cloth or forced air. Do not use alcohol, solvents, or hydrocarbons.

5.2. REPLACEMENT OF THE BATTERIES

When the instrument cannot be switched on, you must replace all of the batteries.

- Disconnect everything connected to the instrument and switch it off.
- Push the wrist strap clear of the battery compartment cover.
- Refer to §1.2 for the replacement procedure.



Spent batteries must not be treated as ordinary household waste. Take them to the appropriate recycling collection point.

- Put the wrist strap back in place.
- Then check that the instrument is working properly (see §3.2).

5.3. ADJUSTING THE INSTRUMENT



This must be done by qualified personnel. We recommend doing it once a year.

5.3.1. EQUIPMENT NECESSARY







- One 10A ammeter, accurate to 0.2% at 200mA.
- One 2Ω, 0.1Ω resistor accurate to 0.1%.
- One 191Ω, 0,1Ω, resistor accurate to 0.1%.
- A Ø4mm male-male banana lead not more than 0.50m long.

5.3.2. FUNCTIONS OF THE KEYS

During the adjustment, the keys have the following functions:

-  : ▲
-  : ▼
-  : ↵

5.3.3. ADJUSTMENT PROCEDURE

- Switch the instrument on by pressing the  key.
- To enter the adjustment mode, press the , ,  and  keys simultaneously until the instrument emits an audible signal and displays **CA1**.
- Connect the ammeter, on the 10A range, to the terminals. Use the ▲ and ▼ keys to obtain a reading as close as possible to -205mA on the ammeter. Confirm with the ↵ key.
- The instrument displays **CA2**. Use the ▲ and ▼ keys to obtain a reading of +205mA. Confirm with the ↵ key.
- The instrument displays **CA3**. Short-circuit the terminals using the lead, then confirm with the ↵ key.
- At the end of a few seconds, the instrument displays **CA4**. Connect the 2Ω resistor to the terminals, then confirm with the ↵ key.
- The instrument displays **CA5**. Connect the 191Ω resistor to the terminals, then confirm with the ↵ key.
- The adjustment is over; the instrument displays **CA1**. Switch the instrument off by pressing the  key.

At each step, if the value is outside of the acceptable range, the instrument displays **ERR** and waits for the correct value. If the value is correctly adjusted, the setting is saved when you go to the next step.

6. WARRANTY

Except as otherwise stated, our warranty is valid for **24 months** starting from the date on which the equipment was sold. Extract from our General Conditions of Sale, provided on request.

The warranty does not apply in the following cases:

- Inappropriate use of the equipment or use with incompatible equipment.
- Modifications made to the equipment without the explicit permission of the manufacturer's technical staff.
- Work done on the device by a person not approved by the manufacturer.
- Adaptation to a particular application not anticipated in the definition of the equipment or not indicated in the user's manual.
- Damage caused by shocks, falls, or floods.

