

■ AC CURRENT PROBE

# MA114



ENGLISH

User Manual



## Statement of Compliance

Chauvin Arnoux<sup>®</sup>, Inc. d.b.a. AEMC<sup>®</sup> Instruments certifies that this instrument has been calibrated using standards and instruments traceable to international standards.

We guarantee that at the time of shipping your instrument has met its published specifications.

An N.I.S.T. traceable certificate may be requested at the time of purchase, or obtained by returning the instrument to our repair and calibration facility, for a nominal charge.

The recommended calibration interval for this instrument is 12 months and begins on the date of receipt by the customer. For recalibration, please use our calibration services. Refer to our repair and calibration section.

**Serial #:** \_\_\_\_\_

**Catalog #:** 2153.41

**Model #:** MA114

Please fill in the appropriate date as indicated:

Date Received: \_\_\_\_\_

Date Calibration Due: \_\_\_\_\_



Chauvin Arnoux<sup>®</sup>, Inc.  
d.b.a AEMC<sup>®</sup> Instruments











# CONTENTS

<b>PRECAUTIONS FOR USE</b> .....	<b>5</b>
RECEIVING YOUR SHIPMENT .....	6
<b>1. DESCRIPTION</b> .....	<b>7</b>
1.1. GENERAL .....	7
1.2. MINIFLEX® MODEL MA114 .....	7
<b>2. OPERATION</b> .....	<b>8</b>
2.1. MEASUREMENT PRINCIPLE .....	8
2.2. OPERATION .....	8
2.2.1. CONNECTING THE MA114 .....	8
2.2.2. DISCONNECTING THE MA114 .....	10
2.2.3. AUTOMATIC POWER OFF .....	10
2.3. EXTERNAL POWER (OPTIONAL) .....	10
<b>3. SPECIFICATIONS</b> .....	<b>12</b>
3.1. REFERENCE CONDITIONS .....	12
3.2. ELECTRICAL CHARACTERISTICS .....	12
3.3. VARIATIONS IN THE RANGE OF USE .....	13
3.4. TYPICAL FREQUENCY RESPONSE GRAPHS .....	13
3.4.1. AMPLITUDE ERROR .....	13
3.4.2. PHASE ERROR .....	13
3.5. TYPICAL FREQUENCY RESPONSE GRAPHS .....	14
3.6. POWER SUPPLY .....	14
3.6.1. BATTERIES .....	14
3.6.2. EXTERNAL POWER (OPTIONAL) .....	14
3.7. ENVIRONMENTAL CONDITIONS .....	15
3.8. PHYSICAL SPECIFICATIONS .....	15
3.9. CONFORMITY TO INTERNATIONAL STANDARDS .....	16
3.10. ELECTROMAGNETIC COMPATIBILITY (CEM) .....	16
<b>4. MAINTENANCE</b> .....	<b>17</b>
4.1. CLEANING .....	17
4.2. BATTERY REPLACEMENT .....	17
<b>WARRANTY</b> .....	<b>18</b>

Thank you for purchasing the AEMC MiniFlex<sup>®</sup> MA114 flexible current sensor.

For best results from your instrument:

- read these operating instructions carefully
- comply with the precautions for use

	WARNING, risk of DANGER! The operator must refer to these instructions whenever this danger symbol appears.
	CAUTION! Risk of electric shock. The voltage at the parts marked with this symbol may be dangerous.
	Equipment protected by double insulation.
	Useful information or tip.
	Application or withdrawal not authorized on conductors carrying dangerous voltages. Type B current sensor as per IEC 61010-2-032.
	Battery.
	Direction of current.
	Recyclable in accordance with standard ISO14040.
	Conforms with European directives and with regulations covering EMC.
	In the European Union, the product must undergo selective disposal for the recycling of electric and electronic material, in compliance with Directive WEEE 2002/96/EC.

### Definition of Measurement Categories (CAT)

**CAT IV** Measurement category IV corresponds to measurements taken at the source of low-voltage installations.

*Examples:* power feeders, counters and protection devices.

**CAT III** Measurement category III corresponds to measurements on building installations.

*Examples:* distribution panel, circuit-breakers, machines or fixed industrial devices.

**CAT II** Measurement category II corresponds to measurements taken on circuits directly connected to low-voltage installations.

*Examples:* power supply to domestic electrical appliances and portable tools.

## PRECAUTIONS FOR USE

---

The MA114 is protected against voltages up to 600 V with respect to earth in measurement category IV, or 1000 V in category III. The protection assured by the current sensor can be compromised if it is used in a way that is not recommended by the manufacturer.

- Comply with the rated maximum voltage and current and the measurement category.
- Never exceed the protection limits stated in the specifications.
- Comply with the conditions of use (temperature, humidity, altitude, degree of pollution and location of use).
- Do not use the MA114 if it is open, damaged, or incorrectly reassembled.
- Before each use, check the integrity of the insulation on the coil, the leads, and the electronic unit.
- The application or withdrawal of the sensor on uninsulated conductors at dangerous voltages requires the use of suitable safety equipment.
- If it is not possible to power down the installation, follow safe operating procedures and use suitable means of protection.
- All troubleshooting and metrological checks must be done by competent, accredited personnel.

## Receiving Your Shipment

Upon receiving your shipment, make sure that the contents are consistent with the packing list. Notify your distributor of any missing items. If the equipment appears to be damaged, file a claim immediately with the carrier and notify your distributor at once, giving a detailed description of any damage. Save the damaged packing container to substantiate your claim.

## Ordering Information

**MiniFlex® 14" Model MA114 (3A/1V/A, 30A/100mV/A,  
300A/10mV/A, 3000A/1mV/A)..... Cat #2153.41**

*Includes two 1.5 V batteries (AA or LR6), multilingual safety data sheet, user manual, and verification certificate.*

# 1. INTRODUCTION

## 1.1. GENERAL

MiniFlex<sup>®</sup> sensors consist of a flexible coil connected by a shielded lead to a housing containing the signal processing electronics, powered by batteries. The flexibility of the sensors allows clamping of the conductor to be measured, whatever its shape (cable, bar, strand, etc.) and accessibility. The snap-locking coil opening/closing button allows handling while wearing protective gloves. The electronic unit can be connected to the  $mV_{AC}$  or  $V_{AC}$  input of a measuring instrument having an input impedance of  $\geq 1\text{ M}\Omega$ .

## 1.2. MINIFLEX<sup>®</sup> MODEL MA114

MiniFlex<sup>®</sup> MA114 single-phase 14" (35 cm) sensor converts alternating currents ranging from 3 to 3000 A into proportional AC voltages.

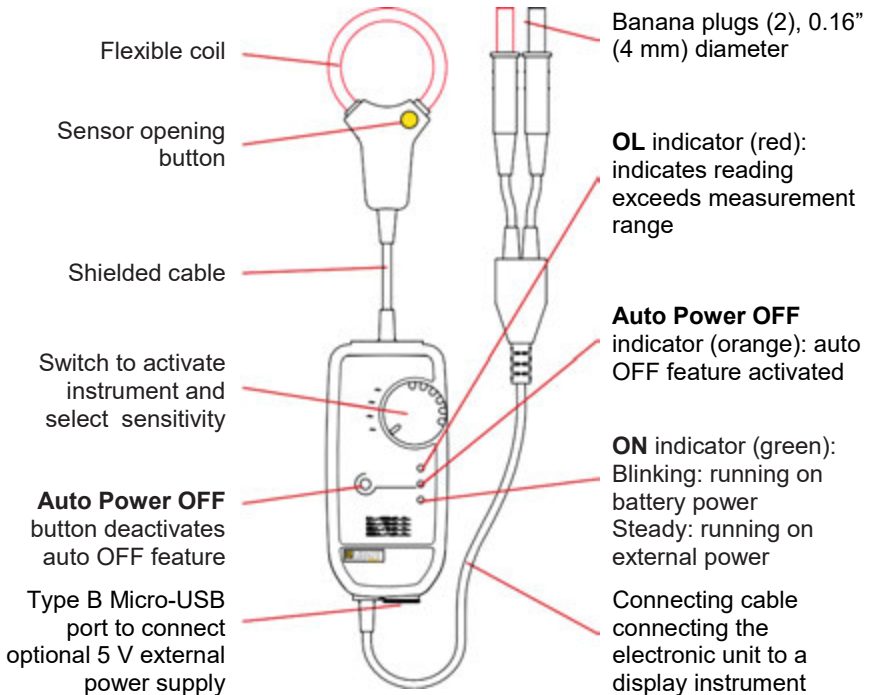

## 2. OPERATION

### 2.1. MEASUREMENT PRINCIPLE

The MA114 sensor is based on the Rogowski coil principle. This provides:

- very good linearity and no saturation effect (and therefore no overheating)
- wide measurement dynamic, up to several kA
- insensitivity to DC (measurement of the AC component of any AC + DC signal)
- light weight (no magnetic circuit)

### 2.2. OPERATION

#### 2.2.1. CONNECTING THE MA114

1. Connect the output leads to a measuring instrument (for example a multimeter) having an input impedance  $\geq 1 \text{ M}\Omega$ . Turn it ON and set to AC voltage measurement.

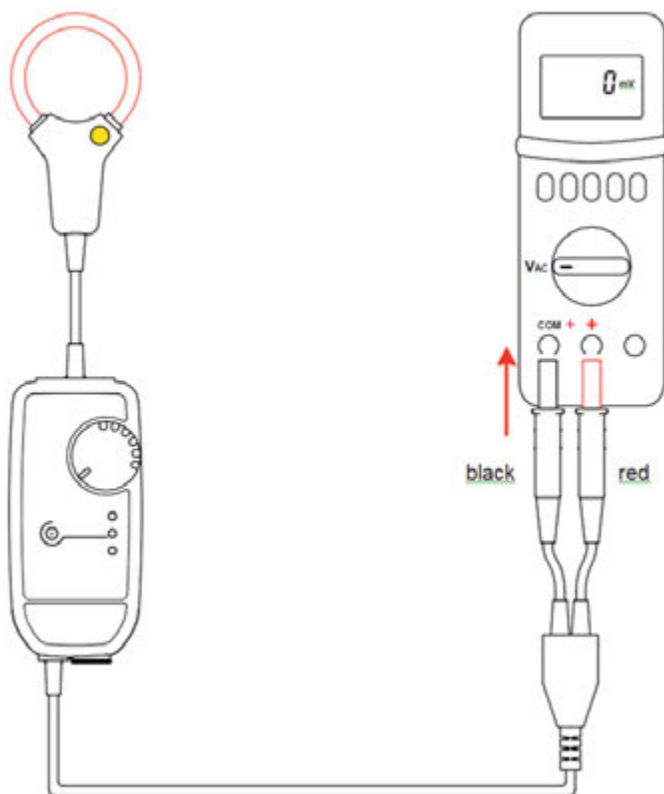



2. Turn the instrument ON by turning the rotary switch to any position. The green ON indicator starts blinking.
3. Press on the yellow sensor opening button to open the flexible coil.

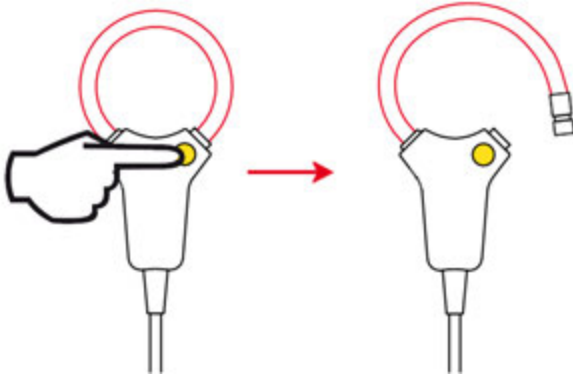

4. Place the open sensor around conductor to be measured (only one conductor in the sensor at a time). Close the coil; an audible click sounds as the coil is closed.



Use individual protection equipment when measuring an uninsulated conductor carrying a high voltage.

---

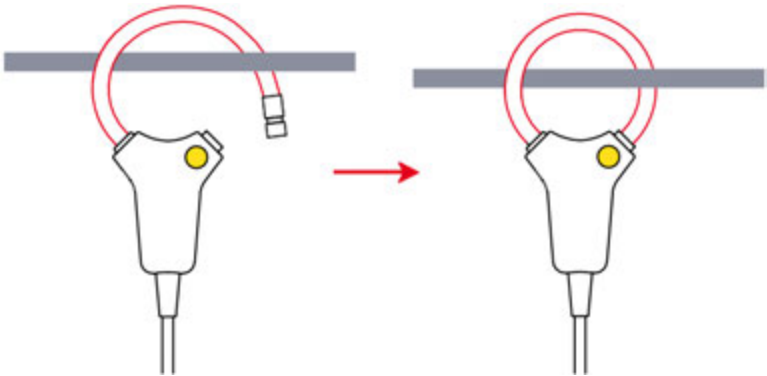

To optimize measurement, center the conductor in the coil.

5. Set the switch to the range providing the best sensitivity and ensure the red **OL** indicator is off. (**OL** indicates saturation of the electronics, resulting in a measurement error.)

6. Read the measurement on the multimeter, applying the reading coefficient indicated on the label on the electronic unit corresponding to the setting of the switch.

3 A~ range: 1000 mV~/A~

30 A~ range: 100 mV~/A~

300 A~ range: 10 mV~/A~

3000 A~ range: 1 mV~/A~

7. Multiply the reading by the coefficient.

For example, a reading of 1 V on the measuring instrument corresponds

to a current of  $\frac{1 \text{ V}}{10 \text{ mV/A}} = 100 \text{ A}$  in the 300 A~ range.

### 2.2.2. DISCONNECTING THE MA114

Remove the flexible coil from the conductor, set the switch to OFF, and disconnect the electronic unit from the multimeter.

### 2.2.3. AUTOMATIC POWER OFF

When the MA114 starts up, it operates for 10 minutes, then automatically switches itself to sleep mode to save battery life. While this feature is activated, the orange Auto Power Off indicator is lit.

To override automatic power off:

1. With the MA114 OFF, press and hold down the **Auto Power Off** button while turning the sensor ON by turning the switch to any measurement setting.
2. Continue to hold down **Auto Power Off** for longer than 2 seconds. The orange Auto Power Off indicator remains OFF, indicating this feature is disabled.

## 2.3. EXTERNAL POWER (OPTIONAL)

For long-duration measurements, you can connect the MA114's electronic unit to line power. Remove the protection from the type B micro-USB connector, then connect the lead. You can use any line/micro-USB adapter that delivers 100 mA or more.

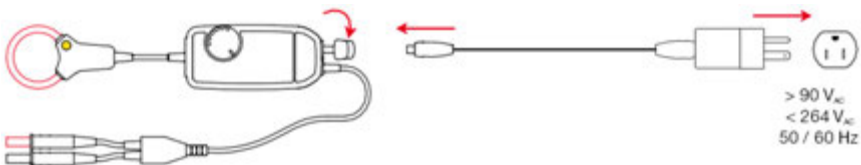

The green On indicator remains lit but its brightness varies to indicate the batteries are functional. While external power supply is present, automatic power off is disabled. If external power is disconnected, the MA114 switches to battery power and automatic power off takes effect after 10 minutes.

If you make long-duration recordings, you must deactivate automatic power OFF (see § 2.2.3).

The insulation between the type B micro-USB connector and the measurement output is 1000 V CAT III or 600 V CAT IV. That makes it possible to safely connect the instrument to wattmeters with uninsulated inputs. The type B micro-USB connector must not be in contact with conductors or uninsulated material at dangerous voltages.

## 3. SPECIFICATIONS

### 3.1. REFERENCE CONDITIONS

Quantity of influence	Reference values
Temperature	77 ± 9 °F (23 ± 5 °C)
Relative humidity	20 to 75 % RH
Measurement frequency range	30 to 440 Hz
Type of signal	sinusoidal
Instrument turn-on time	1 minute
External electric field	null
External DC magnetic field (earth's field)	< 40 A/m
External AC magnetic field	null
Position of the conductor in the coil	centered
Shape of the measurement coil	circular, no applied stress
Input impedance of the instrument connected to the electronic unit	≥ 1 MΩ

### 3.2. ELECTRICAL CHARACTERISTICS

Parameter	Value	
Range	3 A	<ul style="list-style-type: none"> <li>▪ 30 A</li> <li>▪ 300 A</li> <li>▪ 3000 A</li> </ul>
Specified measurement range	0.5 to 3 A	<ul style="list-style-type: none"> <li>▪ 2 to 30 A</li> <li>▪ 5 to 300 A</li> <li>▪ 50 to 3000 A</li> </ul>
Output/input ratio (mV~/A~)	1000	<ul style="list-style-type: none"> <li>▪ 100</li> <li>▪ 10</li> <li>▪ 1</li> </ul>
Maximum peak factor	1.5 at $I_N$ ( $I$ nominal)	
Intrinsic uncertainty (% of output signal)	$\leq 1\%$ + 40 mV	<ul style="list-style-type: none"> <li>▪ <math>\leq 1\% + 4</math> mV</li> <li>▪ <math>\leq 1.5\% + 0.4</math> mV (<math>I &lt; 10\% I_N</math>)</li> <li>▪ <math>\leq 1\% + 0.4</math> mV (<math>I \geq 10\% I_N</math>)</li> <li>▪ <math>\leq 1.5\% + 0.04</math> mV (<math>I &lt; 10\% I_N</math>)</li> <li>▪ <math>\leq 1\% + 0.04</math> mV (<math>I \geq 10\% I_N</math>)</li> </ul>
Maximum offset voltage	0 mV <sub>DC</sub>	
Phase shift at 50 Hz	$\leq 1^\circ$ (0.5° typical)	
Max. output voltage	- 4.5 V <sub>peak</sub> ≤ V ≤ + 4.5 V <sub>peak</sub>	
Frequency response*	10 Hz to 10 kHz	10 Hz to 20 kHz

\*Above 300 A<sub>RMS</sub>, see the graph in § 3.5.



The peak value is limited only by the electronics of the measurement unit (red **OL** indicator on). The coil alone can briefly withstand higher peak factors with no risk of overheating or damage.

### 3.3. VARIATIONS IN THE RANGE OF USE

Quantity of influence	Range of influence	Error in % of reading	
		Typical	Maximum
Battery voltage	1.8 to 3.2 V	0.02%	0.1%
Temperature	10 to 55 °C	0.15% / 10 °C	0.50% / 10 °C
Relative humidity	10 to 90% RH	0.2%	0.5%
USB supply voltage	5 V	0.5%	1.5%
Position of the conductor in the undeformed sensor	Any position	1%	2.5%
Adjacent conductor carrying an AC voltage	Conductor touching sensor	0.2%	1% (2% near snap lock)
Deformation of the sensor	Oblong shape	0.2%	1%
Common mode rejection	600 V between the jacket and the secondary	100 dB	80 dB
Input impedance of the measuring instrument	10 kΩ to 1 MΩ	0.1%	

### 3.4. TYPICAL FREQUENCY RESPONSE GRAPHS

#### 3.4.1. AMPLITUDE ERROR

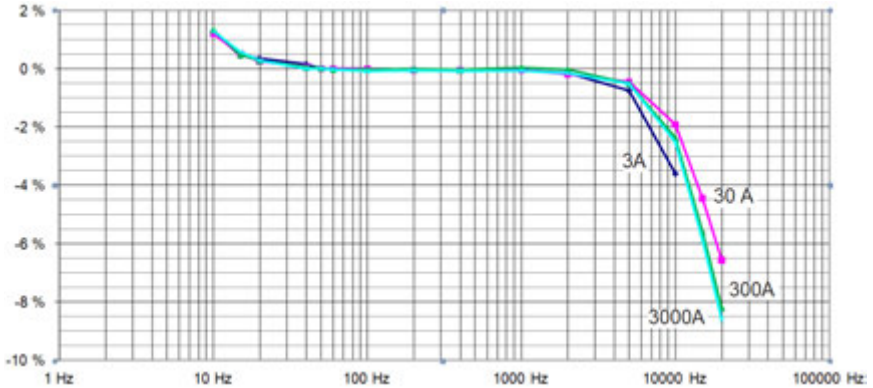

#### 3.4.2. PHASE ERROR

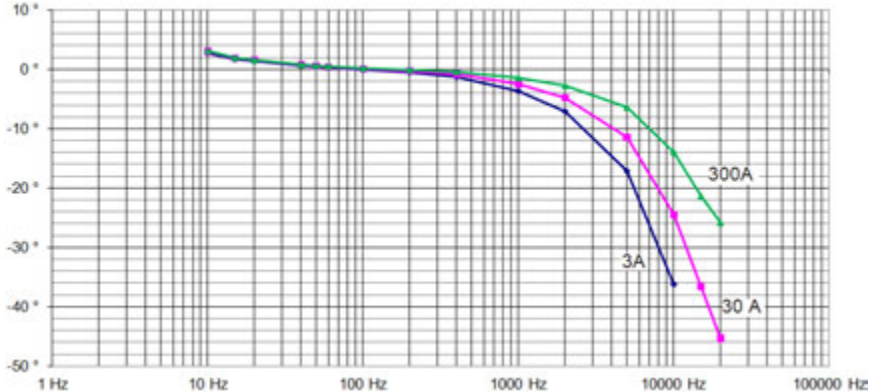

### 3.5. TYPICAL FREQUENCY RESPONSE GRAPHS

In the 3A, 30A, and 300A ranges, with a frequency  $\leq 20$  kHz, there is no frequency derating.

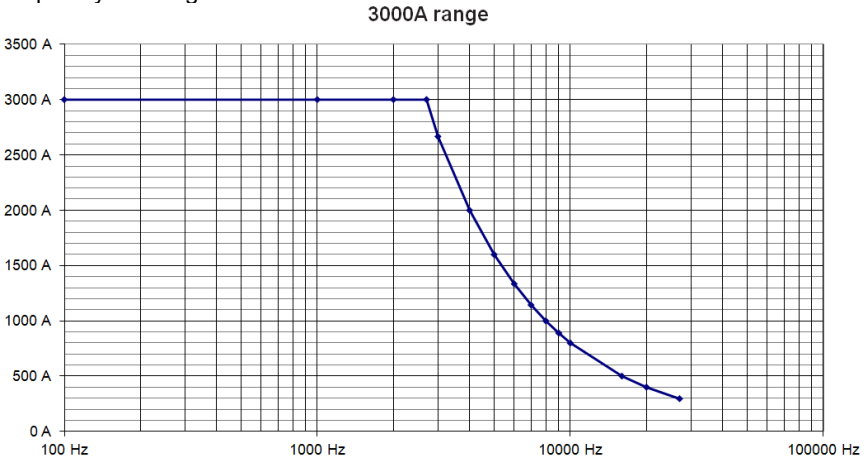

### 3.6. POWER SUPPLY

#### 3.6.1. BATTERIES

The MA114 is powered by two 1.5 V alkaline batteries (type AA or LR6). The nominal operating voltage is between 1.8 and 3.2 V.

The mean battery life is:

- 300 hours in continuous operation
- 1,800 10-minute measurements

When the MA114 is not connected to line power and the green On indicator goes off, the batteries must be replaced (see § 4.2).

#### 3.6.2. EXTERNAL POWER (OPTIONAL)

The MA114 can be powered by a standard line adapter (5 V<sub>DC</sub>, 100 mA) with a type B micro-USB connector.

When the adapter is connected and the switch is set to OFF, the On indicator is lit steadily.

When the MA114 is ON, the brightness of the On indicator varies to indicate that the batteries are functional. If the indicator remains on steadily, the batteries must be replaced.

### 3.7. ENVIRONMENTAL CONDITIONS

The MA114 must be used in the following conditions:

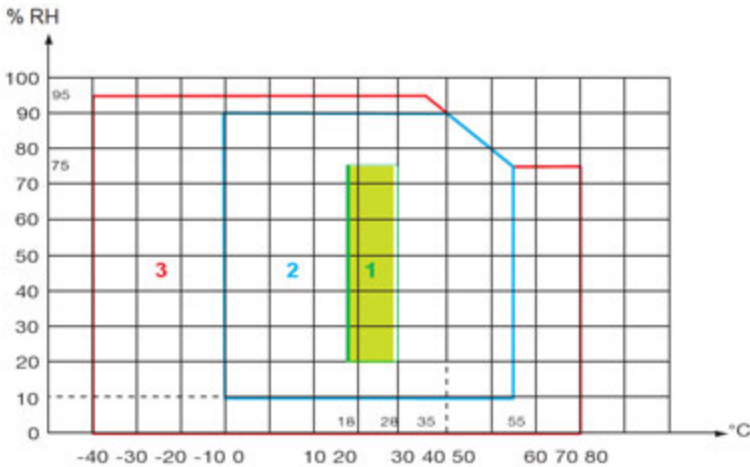

- 1: Range of reference
- 2: Operating range
- 3: Storage range (without battery)

If the MA114 will be unused or stored for an extended period, remove its batteries. The sensor by itself can withstand a maximum temperature of 194°F (90°C) for 10 minutes.

Degree of pollution: 2

Altitude: < 6500' (2000 m)

### 3.8. PHYSICAL SPECIFICATIONS

#### Coil:

- Length: 14" (35 cm)
- Clamping diameter: 4" (10 cm)

#### Shielded lead between the sensor and the electronic unit:

- Diameter: 0.16" (4 mm)
- Length: 78.7" (2 m)

#### Electronic unit:

Dimensions: 4.72 x 2.28 x 1.42" (120 x 58 x 36 mm)

#### Output cable:

- Length: 1.97" (50 cm)
- Diameter (2 plugs): 0.16" (4 mm)

**Weight:** approximately 10.5 oz (300 g).

**Protection index:** IP 54 for the electronic unit and IP 67 for the flexible sensor per IEC 60529. The flexible coil withstands oils and aliphatic hydrocarbons well.

### **3.9. CONFORMITY TO INTERNATIONAL STANDARDS**

- Electrical safety per IEC 61010-2-032 for type B sensors.
- Double insulation
- Measurement category: IV
- Rated voltage: 600 V (or 1000 V in CAT III)

### **3.10. ELECTROMAGNETIC COMPATIBILITY (CEM)**

Emissions and immunity in an industrial environment per IEC 61326-1.



## 4. MAINTENANCE

---

Except for the batteries, the MA114 contains no parts that can be replaced by personnel who have not been specially trained and accredited. Any unauthorized repair or replacement of a part by an “equivalent” may significantly impair safety.

### 4.1. CLEANING

- Disconnect the unit completely and turn the rotary switch to OFF.
- Wipe with a soft cloth, dampened with soapy water.
- Rinse with a damp cloth and dry rapidly with a dry cloth or forced air. Do not use alcohol, solvents, or hydrocarbons.
- Ensure no foreign body interferes with the operation of the snap lock button of the sensor.

### 4.2. BATTERY REPLACEMENT

The batteries must be replaced when the On indicator remains off upon power-up.

1. Disconnect the sensor completely and turn the rotary switch to OFF.
2. Use a screwdriver to remove the two screws closing the electronic unit.
3. Replace the spent batteries with new batteries (1.5V AA or LR6 alkaline batteries).
4. Insert the batteries in their compartment, taking care to ensure correct polarities.
5. Close the electronic unit and make sure that it is completely and correctly closed.
6. Screw the two screws back in.

# WARRANTY

---

Your AEMC instrument is warranted to the owner for a period of two years from the date of original purchase against defects in manufacture. This limited warranty is given by AEMC<sup>®</sup> Instruments, not by the distributor from whom it was purchased. This warranty is void if the unit has been tampered with, abused, or if the defect is related to service not performed by AEMC<sup>®</sup> Instruments.

Full warranty coverage and product registration is available on our website.

Please print the online Warranty Coverage Information for your records.

## **What AEMC<sup>®</sup> Instruments will do:**

If a malfunction occurs within the two-year period, you may return the instrument to us for repair, provided we have your warranty registration information on file or a proof of purchase. AEMC<sup>®</sup> Instruments will, at its option, repair or replace the faulty material.

## **WARRANTY REPAIRS**

What you must do to return an instrument for Warranty Repair:

First, request a Customer Service Authorization Number (CSA#) by phone or by fax from our Service Department (see address below), then return the instrument along with the signed CSA Form. Please write the CSA# on the outside of the shipping container. Return the instrument, postage or shipment pre-paid to:

**Ship To:** Chauvin Arnoux<sup>®</sup>, Inc. d.b.a. AEMC<sup>®</sup> Instruments

**Caution:** To protect yourself against in-transit loss, we recommend you insure your returned material.

**NOTE:** You must obtain a CSA# before returning any instrument.

**NOTES:**



05/19

99-MAN 100494 v1

Chauvin Arnoux<sup>®</sup>, Inc. d.b.a. AEMC<sup>®</sup>  
Instruments