

FS-*i* Series

INSTRUCTION MANUAL



Check Weighing Scales

FS-6*Ki*
FS-15*Ki*
FS-30*Ki*

AND
A&D Company, Limited

This Manual and Marks

All safety messages are identified by the following, "WARNING" or "CAUTION", of ANSI Z535.4 (American National Standard Institute: Product Safety Signs and Labels). The meanings are as follows:

 WARNING	A potentially hazardous situation which, if not avoided, could result in death or serious injury.
 CAUTION	A potentially hazardous situation which, if not avoided, may result in minor or moderate injury.



This is a hazard alert mark.

Note This manual is subject to change without notice at any time to improve the product. No part of this manual may be photocopied, reproduced, or translated into another language without the prior written consent of the A&D Company.

Product specifications are subject to change without any obligation on the part of the manufacture.

Copyright©2006 A&D Company, Limited

Contents

1. COMPLIANCE	2
2. INTRODUCTION	3
3. UNPACKING	3
4. CAUTION	4
4-1. Precautions for Installing the Scale	4
4-2. Precautions for Operating the Scale	4
4-3. Precautions for Storing the Scale	4
5. SETTING UP	5
5-1. Attaching a display pod to the display support column	5
5-2. Installing the scale	5
6. NAMES AND FUNCTIONS	6
7. BASIC OPERATION	10
7-1. Turning the power ON and OFF	10
7-2. Selecting a weighing unit	10
7-3. Basic operation	10
7-4. Weighing with Preset Tare	11
7-5. To Clear a Tare Weight	11
7-6. Weight display resolution	12
7-7. Simplified operation mode	12
7-8. LCD backlight	12
8. CHECK WEIGHING	13
8-1. Target weight setting mode	13
8-2. Upper & Lower limits weight setting mode	16
8-3. The comparator memory	17
9. ANALOG SWEEP DISPLAY	19
9-1. Selecting a display mode	19
9-2. Example of the analog sweep display	20
10. CALIBRATION	22
10-1. Calibration using a weight	22
10-2. Gravity acceleration correction	23
11. FUNCTIONS	24
11-1. The procedure for setting parameters	24
11-2. Function list	25
12. SPECIFICATIONS	27
12-1. Specifications	27
12-2. Dimensions	28
13. GRAVITY ACCELERATION MAP	29

1. COMPLIANCE

Compliance with FCC rules

- £ Please note that this equipment generates, uses and can radiate radio frequency energy. This equipment has been tested and has been found to comply with the limits of a Class A computing device pursuant to Subpart J of Part 15 of FCC rules. These rules are designed to provide reasonable protection against interference when equipment is operated in a commercial environment. If this unit is operated in a residential area it might cause some interference and under these circumstances the user would be required to take, at his own expense, whatever measures are necessary to eliminate the interference.
(FCC = Federal Communications Commission in the U.S.A.)

Classification of protection provided by enclosures

- £ The equipment is designed to comply with the IP Code of IEC 60529. The “IP65” is explained as follows:
 - “IP” International Protection.
 - “6” Against ingress of solid foreign objects.
Dust-tight. No ingress of dust.
 - “5” Against ingress of water with harmful effects.
Protected against water jets (no power full jets). Water projected in jets against the enclosure form any direction shall have no harmful effects.

NSF listed

- £ The equipment is certified and listed to NSF/ANSI Standard 169 by NSF International. NSF International evaluated the equipment and certified that it is compliant with food protection and sanitation requirements for the design, construction and materials.

2. INTRODUCTION

This manual describes how this scale works and how to get the most out of it in terms of performance.

FS-*i* series check weighing scales have the following features:

- £ The FS-*i* series has three kinds of weight display resolution, 1/3,000, 1/6,000 (~1/7,500) and 1/12,000 (~1/15,000) to cover various applications.
- £ There are 2 sizes of weighing pan. The FS-30*Ki* has a larger pan and the FS-6*Ki* / FS-15*Ki* has a smaller pan.
- £ Weighing units are **kg** kilogram, **g** gram, **lb** pound; **oz** ounce; and **lb-oz** pound and ounce.
- £ Waterproof to IP-65 specifications.
- £ Constructed from stainless steel for harsh working environment.
- £ Large liquid crystal display with back lighting and analog sweep display of 60 segments with back lighting.
- £ Scale may be operated by AC power source or an optional SLA (sealed lead acid) battery.
- £ Built in comparator with large and bright LED display of results.
- £ Three colors of comparator results for better visibility.
- £ Two modes of comparator operation, Target weight setting and Upper/Lower limits setting.
- £ Optional serial data and comparator relay interface.

3. UNPACKING

Unpack the scale carefully and keep the packing material if you are likely to transport the scale again in the future.



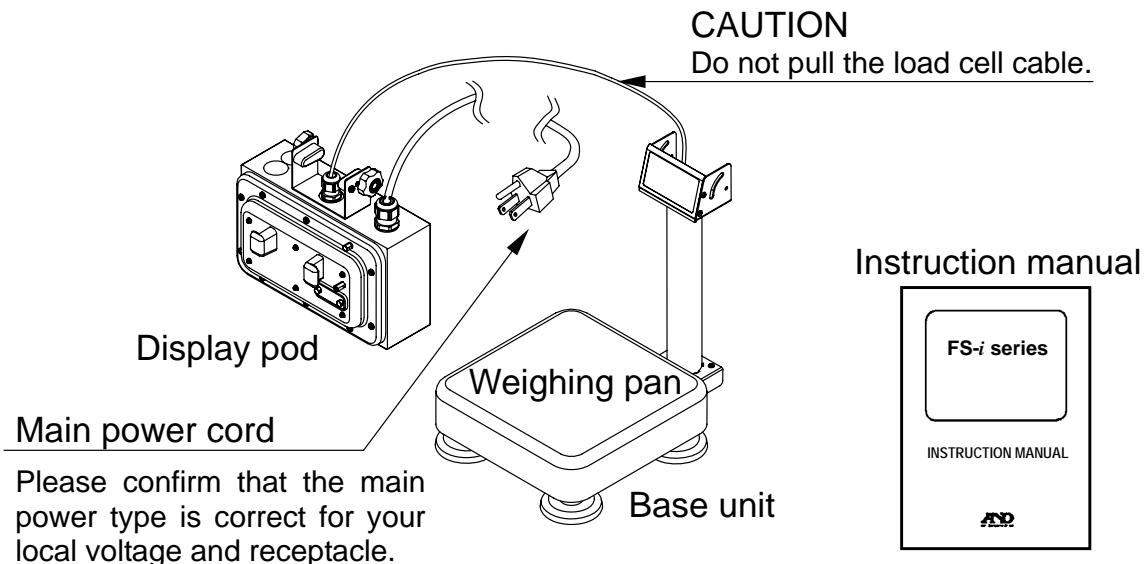

When unpacking, check whether all of the following items are included:



Please confirm that the main power type is correct for your local voltage and receptacle.

4. CAUTION

4-1. Precautions for Installing the Scale

-  ₤ Ground the scale so that the user will not be subjected an electric shock.
-  ₤ Do not handle the main power cord with wet hands.
-  ₤ The AC plug is not water-resistant. Install it in an area where it does not get wet.
-  ₤ Do not install the scale where there is flammable or corrosive gas present.
- ₤ Do not install the scale under water.
- ₤ Do not pull, fold or arrange cables forcibly.

Consider following conditions to get the most from your scale.

- ₤ Install the scale where the temperature and relative humidity is stable. There is no draft and a stable power source is available.
- ₤ Install the scale on a solid and level surface.
- ₤ Do not install the scale in direct sunlight.
- ₤ Do not install the scale near heaters or air conditioners.
- ₤ Do not install the scale where there is flammable or corrosive gas present.
- ₤ Do not install the scale near equipment which produces magnetic fields.
- ₤ Do not install the scale in a place where it is apt to be charged with static electricity, or where the relative humidity is lower than 45% RH. Plastic and isolators are apt to be charged with static electricity.
- ₤ Do not use an unstable power source.

4-2. Precautions for Operating the Scale

- ₤ Periodically ensure that the weighing value is correct.
- ₤ Calibrate the scale periodically to keep weighing accuracy (See “10. CALIBRATION”).
- ₤ Calibrate the scale when you move it to another location.
- ₤ Do not place anything on the pan that is heavier than the weighing capacity.
- ₤ Do not apply a shock load to the scale.
- ₤ Do not use a sharp instrument such as a pencil or ball-point pen to press the keys.
- ₤ Make sure that the STABLE annunciator is ON whenever reading or storing a value.
- ₤ We recommend you to press the **ZERO** or **TARE** key before each weighing to prevent possible error.

4-3. Precautions for Storing the Scale

- ₤ Do not disassemble the scale.
- ₤ Do not use solvents to clean the scale.
- ₤ For best cleaning of the display pod, wipe with a lint free cloth that is dry or moistened with warm water and mild detergent.
- ₤ The base unit is can be cleaned with gentle water jet and brushing. Dry the unit well before use.
- ₤ Do not use a powerful water jet.

5. SETTING UP

5-1. Attaching a display pod to the display support column

1. Take out whole of the scale from the box taking care not to pull the load cell cable.
2. Remove 2 clamps and 2 M4x12 screws.
3. Attach the display pod to the display support column and tighten the M4x12 screws removed at step 2.
4. Attach the clamps and tighten them after tilting the display pod where you like to use.
- £ Put the excess part of the load cell cable into the display support column

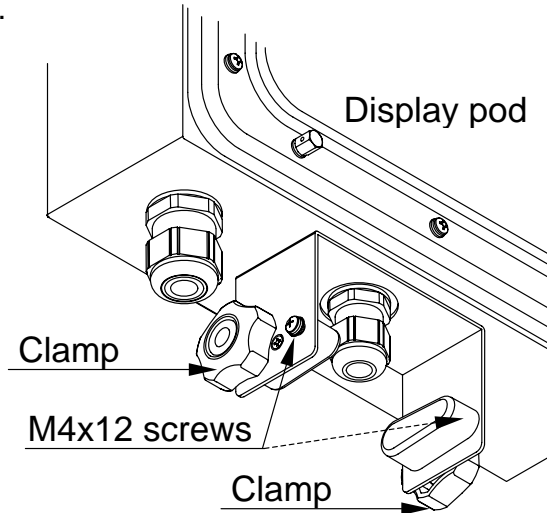

5-2. Installing the scale

1. Select the place for installing the scale. Refer to "Cautions for installing the scale" below.
2. Adjust the level of the base, using the spirit level and leveling feet. There is an extra foot under the display support column. Adjust this foot to reach floor after adjusting the level of the base.
- ⚠ 3. Connect the main power cord to the outlet that has the earth wiring. You may use the earth terminal on the rear side of the display pod to ground the scale.
4. If necessary, adjust the viewing angle of the display by loosening the 2 clamps, changing the angle and re-tightening the clamps.

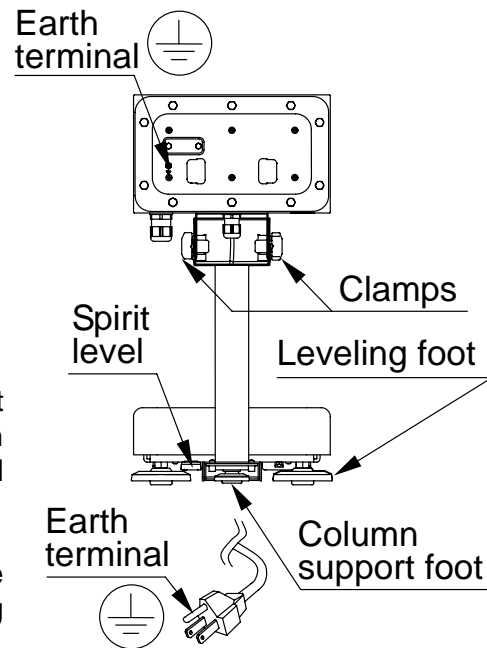

6. NAMES AND FUNCTIONS

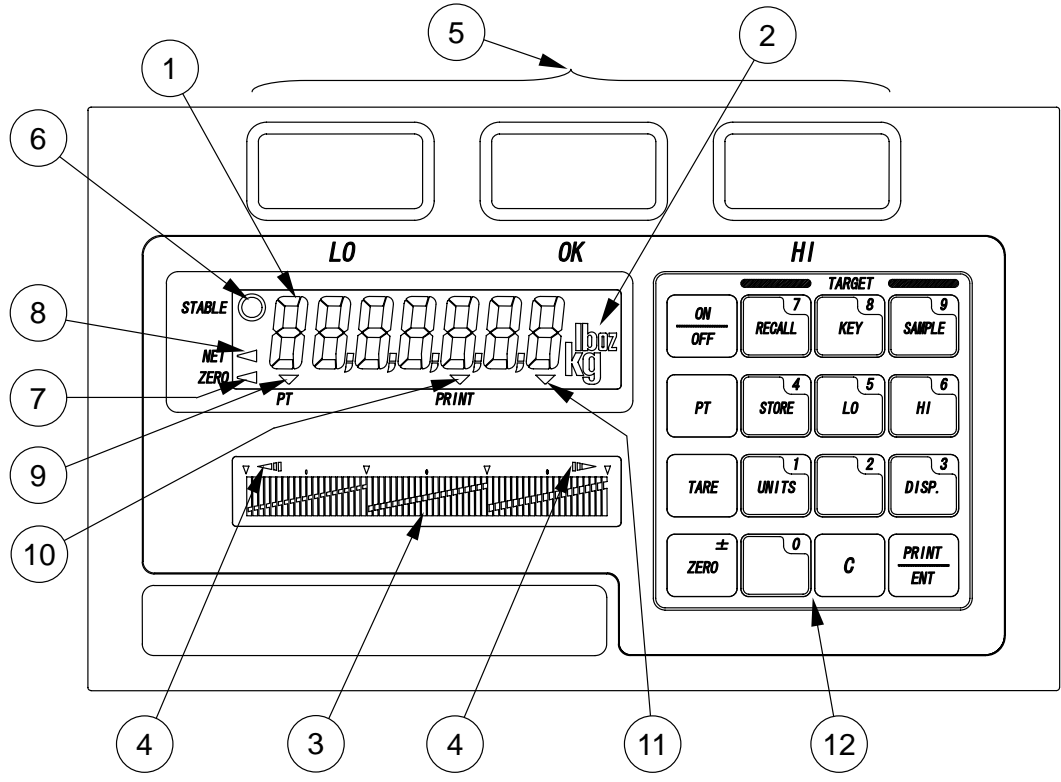
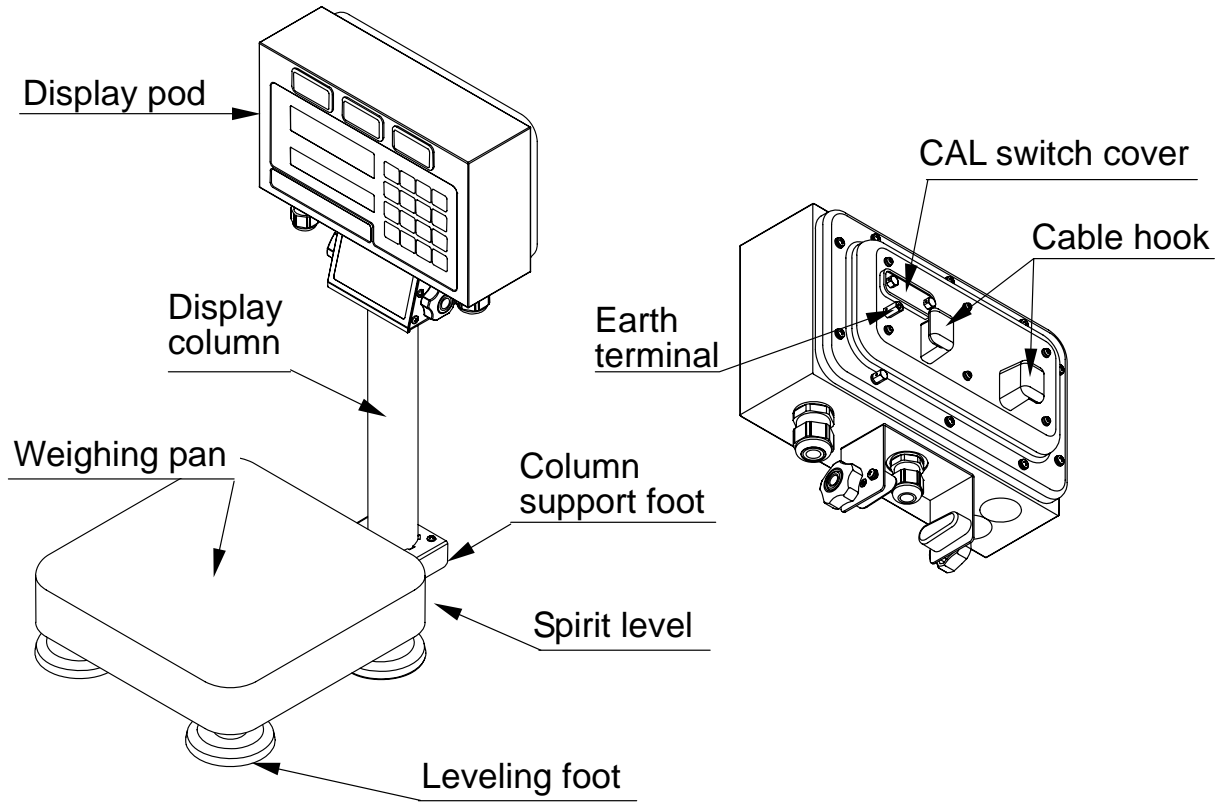

- ① **WEIGHT DATA DISPLAY.**
This display shows the weight on the weighing pan.
- ② **WEIGHING UNIT INDICATOR.**
This display area shows the weighing unit in use.
- ③ **ANALOG WEIGHT DISPLAY.**
This scale has a 60 segments analog sweep display representing zero to full scale when the simple weighing mode display is selected. In the limit check weighing display mode, this display shows comparison limits and results.
- ④ **OVER RANGE INDICATORS.**
This mark comes ON when the weight is outside the range of analog sweep display..
- ⑤ **COMPARISON INDICATORS.**
The indicators LO (RED), OK (GREEN) and HI (YELLOW) show the results of the weight comparison.
- ⑥ **STABLE ANNUNCIATOR.**
This annunciator will come ON when the weight reading is STABLE.
- ⑦ **ZERO ANNUNCIATOR.**
This annunciator will come ON when the scale is showing the center of ZERO.
- ⑧ **NET ANNUNCIATOR.**
This annunciator will come ON when the scale is displaying the NET weight on the weighing pan.
- ⑨ **PT ANNUNCIATOR.**
This annunciator will come ON when the scale is displaying the preset tare weight.
- ⑩ **PRINT ANNUNCIATOR.**
This annunciator will come ON for a moment when the scale sends out the weight data by pressing the PRINT key or auto-printing.
- ⑪ **PRECAUTION AGAINST LOW BATTERY.**
This annunciator will come ON when the optional battery is getting close to low battery.
- ⑫ **KEYPAD.**
A 13 key pad provides control and number keys.

Description of Key Operations

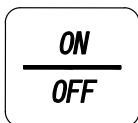

ON/OFF Key

The **ON/OFF** key turns the power on or off. When turned on, the scale will be automatically set to zero (power-on zero).

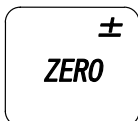

ZERO / ± Key

The **ZERO** key zeros the scale when the weight is stable (STABLE annunciator ON). In the data entry sequence this key switches the sign “+” and “-”.



TARE Key

The **TARE** key switches the scale to net weight mode and zeros the weight display when the weight is plus and stable. The ZERO and NET annunciators will come ON.



PT Key

The **PT** key is used to enter a tare weight via the 10-key pad.



SAMPLE / 9 Key

The **SAMPLE** key will register the sample weight as the target. In the data entry sequence this key displays the number 9.



KEY / 8 Key

The **KEY** key allows you to enter a target weight using the keypad. In the data entry sequence this key displays the number 8.



RECALL / 7 Key

The **RECALL** key is used to recall target weight and/or HI/LO limits. In the data entry sequence this key displays the number 7.



HI / 6 Key

The **HI** key allows you to enter the comparator HI limit using the numeric keypad. In the data entry sequence this key displays the number 6.

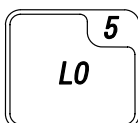

LO / 5 Key

The **LO** key allows you to enter the comparator LO limit using the numeric keypad. In the data entry sequence this key displays the number 5.



STORE / 4 Key

The **STORE** key is used to store target weight and/or HI/LO limits. In the data entry sequence this key displays the number 4.



DISP. / 3 Key

When the **DISP.** key is pressed the analog weight display steps through the 4 available modes of simple weighing, target weighing, limit check weighing and display off. In the data entry sequence this key displays the number 3.



UNITS / 1 Key

The **UNITS** key is used to select the desired weighing unit . In the data entry sequence this key displays the number 1.



PRINT / ENT Key

The **PRINT** key is used when the serial data option OP-03 or OP-04 is installed and sends one data string. In the data entry sequence this key is used to ENTER the numeric data into the scale memory.

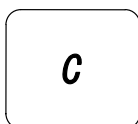

C Key

The **C** key is used to clear an incorrect data entry from the numeric keys.

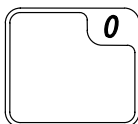

0 and 2 Keys

These keys are used to display the number 0 or 2 during a data entry sequence.

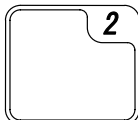

7. BASIC OPERATION

7-1. Turning the power ON and OFF

1. Press the **ON/OFF** key to turn the power ON.

All the display symbols are displayed and the scale waits for the weighing data to become stable.

After the weighing value internally becomes stable, the display turns off for a moment and zero is shown with the ZERO annunciator (power-on zero).

If the weighing value is unstable, the display will continue to "88888888". Check if anything touches the weighing pan, or check if there is strong wind or vibration.

The range for power-on zero is within $\pm 50\%$ of the weighing capacity (kg) around the calibrated zero point.

If the power is switched ON while there is a load beyond this range, the scale shows "- - - - -". Remove the load on the weighing pan.

2. Pressing the **ON/OFF** key again, and the power will be switched OFF.

- £ Auto power-off function

It is possible to have the power automatically switched OFF, if zero is displayed for approximately 5 minutes. See "11-2. Function list" and set the function "F1-1".

7-2. Selecting a weighing unit

Press the **UNITS** key to select the weighing unit if necessary.

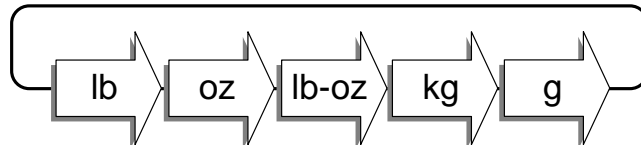

- £ It is possible to specify the display unit that will be shown first when the power is switched on. See the Function "F3".

- £ In some countries or areas "kg" or "g" only is available and the **UNITS** key does not work. The "kg" or "g" is specified by the Function "F3".

7-3. Basic operation

1. Press the **ON/OFF** key to switch on the scale.
2. Select a weighing unit using the **UNITS** key if necessary.
3. When the display doesn't show zero, press the **ZERO** key to set the display to zero.
4. When using a tare (container), place the container on the weighing pan, and press the **TARE** key to set the display to zero (net weight display).
5. Place the item to be weighed on the pan or in the container, and wait for the STABLE annunciator to come on and read the value.
6. Remove the item from the weighing pan.

Note for the Legal for Trade Models

- £ The range for power-on zero is within $\pm 10\%$ of the weighing capacity around the calibrated zero point.
- £ The **ZERO** key will zero the scale if the weight is within $\pm 2\%$ of the weighing capacity around the power-on zero point. The ZERO annunciator turns on. When the weight exceeds $\pm 2\%$ of the weighing capacity, the key does not work.

7-4. Weighing with Preset Tare

Using **PT** key, known tare weight can be entered via the 10-key pad.

1. Remove everything on weighing pan.
2. Press the **PT** key. The display will blink with the preset tare weight previously entered, or will show blank if there is no preset tare entered.
3. Use the 10-key pad to display the known tare weight.
 - £ If you hit the wrong key, press the **C** key to return to the display at step 2 and try again.
4. Press the **ENT** key. The weight display changes to net weight mode and the NET annunciator comes on.
5. Place the item together with the tare (container) to display the net weight.

7-5. To Clear a Tare Weight

Either:

1. Remove all items from the weighing pan.
2. Press the **ZERO** key. Then the display will go to zero and tare will be cleared.
 - £ The NET annunciator goes off.
 - £ In some countries or areas, the **ZERO** key does not clear the tare weight. Press the **TARE** key after zeroing at step 2. Then the tare weight will be cleared.

Or:

1. Press the **PT** key. The display will blink with the preset tare weight previously entered, or will show blank if there is no preset tare entered.
2. Press the **0** key and .press the **ENT** key.
3. The tare weight is cleared and the NET annunciator goes off.

7-6. Weight display resolution

The FS-*i* series has three kinds of weight display resolution, NORMAL, HIGH and HIGHER. The following is about “kg” and “lb” display for reference. See the “12. SPECIFICATIONS” in detail.

NORMAL:	1/3,000
HIGH:	1/6,000 ~ 1/7,500 (depending on capacity)
HIGHER:	1/12,000 ~ 1/15,000 (depending on capacity)

The factory setting is the NORMAL resolution, but it is possible to change by Function “F2”. Set this function according to the application.

£ **The resolution of the Legal for Trade Models is fixed to NORMAL, and the setting F2 cannot be changed.**

7-7. Simplified operation mode

If desired, the FS-*i* scale can be set in a Simplified Operation Mode. There are two kinds of mode according to the Function F14-1 and F14-2. In this mode, the following keys are active.

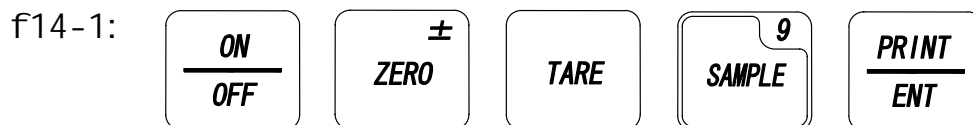

Set the upper/lower limits in the setting F14-0 first and change it to F14-1. Then, the target weight only can be set using the SAMPLE key. This setting will be used with Function F7-1 or F7-2.

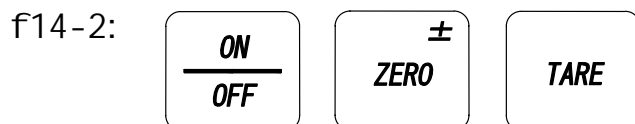

Set the target weight and upper/lower limits in the setting F14-0, and change it to F14-2. Then, The settings can not be changed accidentally.

£ **Be sure to set the Function F3 (weighing unit to be used) and F16 (analog sweep display mode) together with the setting above. Because the weighing unit and analog display cannot be changed in the simplified operation mode.**

7-8. LCD backlight

The Function F17 controls how the LCD backlight turns off. If F17-2 or F17-3 is selected, the backlight will automatically turn off after the weight display continues to be stable for 30 or 60 seconds. It will turn on when the weight changes more than 4d (d= minimum display division) or any key operation is pressed.

8. CHECK WEIGHING

The FS-*i* series provides for easy check weighing of products. There are two comparison modes according to number of parameters to set, "Target weight setting mode" and "Upper & lower limits weight setting mode". The comparator results are indicated by HI (yellow), OK (green) or LO (red) lights on the display. The results are also audible by the buzzer inside the scale.

The analog sweep display will help to see where the weight is in the OK range or how far from the OK range. See "19. ANALOG SWEEP DISPLAY" in detail.

If the optional OP-03 or OP-04 is installed, comparator relay output is also available.

£ It is necessary to set the "comparator function (F8-0 ~ F8-6)" parameters, upper limit (HI), lower limit (LO) and target weight (Target weight setting mode only) in advance to use comparator function.

£ Select the operating conditions to compare (see the Function F8).

F8-0: Comparator OFF.

F8-1: Compare when weight is stable or moving.

F8-2: Compare when weight is stable. (STABLE annunciator lit.)

F8-3: Compare when weight is stable or moving and more than +4d or less than -4d.

F8-4: Compare when weight is stable and more than +4d or less than -4d.

F8-5: Compare when weight is stable or moving and more than +4d above zero.

F8-6: Compare when weight is stable and more than +4d above zero.

d = minimum weight display in "kg". (see "12-1 Specifications")

£ If necessary, use the buzzer sound for comparator results. The Function set the buzzer to sound with which result (see the Function F9).

£ The brightness of comparator lights is adjustable. See the Function F15 to adjust.

8-1. Target weight setting mode

The TARGET WEIGHT SETTING MODE uses a target weight and +/- deviation from the target. The target weight is entered via the 10-key pad or a sample product to be weighed. The upper (HI) and lower (LO) limits are entered via the 10-key pad. Those will be deviation weight or % of the target weight.

£ Set the Function setting "F7-1 Target weight setting mode with HI/LO limit weight" or "F7-2 Target weight setting mode with HI/LO limit % of the target weight".

£ The formula to compare is as follows:

LO < Lower limit value mOK mUpper limit value < HI

Lower limit value = Target weight – LO limit

Upper limit value = Target weight + HI limit

Setting the target weight by sample

1. Press the **ZERO** key to zero the weight display if necessary.
2. Place the sample on the weighing pan. The display shows the sample item's weight.
3. Press the **SAMPLE** key. The sample weight flashes and the central part of analog display turns on.
- £ Press the **ON/OFF** key or **SAMPLE** key to exit without anything changed.
4. Wait for the **STABLE** annunciator to come on and press the **ENT** key to store the sample weight in memory.
5. The display shows **5stored** for a few seconds and returns to weighing mode.

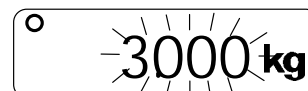
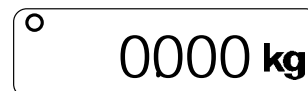

Setting the target weight by key

1. Press the **KEY** key and the last target weight entered will flash and the central part of analog display turns on.
2. Enter the target weight via the 10-key pad.
- £ If you hit the wrong key, press the **C** key and the old target weight is re-displayed. Continue data entry again.
- £ You can place minus value using the **±** key. This key toggles the sign.
3. Press the **ENT** key to store the target weight in memory.
4. The display shows **5stored** for a few seconds and returns to weighing mode.

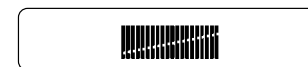
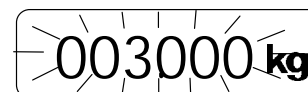
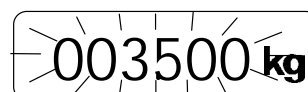

Setting the HI limit weight and LO limit weight

- £ Set the Function setting "F7-1 Target weight setting mode with HI/LO limit weight".
1. Press the **HI** key. Then, the last HI limit weight entered will flash and the right part of analog display turns on.
 2. Enter the HI limit weight via the 10-key pad.
 - £ If you hit the wrong key, press the **C** key and the old HI limit weight is re-displayed. Continue data entry again.
 - £ You cannot enter the "+" or "-" sign for the LO limit.

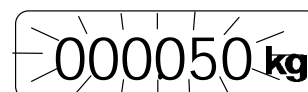
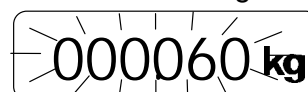

3. Press the **ENT** key to store the HI limit weight in memory.

4. The display shows **5tored** for a few seconds and returns to weighing mode.



5. Press the **LO** key. Then, the last LO limit weight entered will flash and the left part of analog display turns on.

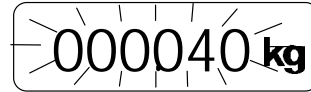

6. Enter the LO limit weight via the 10-key pad.

£ If you hit the wrong key, press the **C** key and the LO limit weight is re-displayed. Continue data entry again.

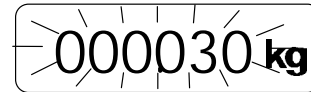

£ You cannot enter the “+” or “-” sign for the LO limit.

7. Press the **ENT** key to store the LO limit weight in memory.

8. The display shows **5tored** for a few seconds and returns to weighing mode.



£ Example:

Target weight: 3.000 kg, HI limit weight: 0.050 kg, LO limit weight: 0.030 kg

Then,

Upper limit = 3.000 kg + 0.050 kg = 3.050 kg

Lower limit = 3.000 kg - 0.030 kg = 2.970 kg

LO: weight < 2.970 kg

OK: 2.970 kg mweight m3.050 kg

HI: 3.050 kg < weight

Setting the HI limit % and LO limit %

£ Set the Function setting “F7-2 Target weight setting mode with HI/LO limit %”.

1. Press the **HI** key. Then, the last HI limit % entered will flash and the right part of analog display turns on.

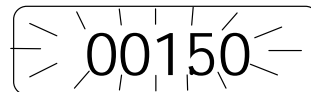

2. Enter the HI limit % via the 10-key pad.

£ If you hit the wrong key, press the **C** key and the old HI limit % is re-displayed. Continue data entry again.

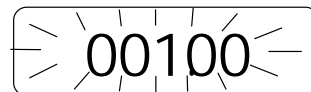

£ You cannot enter the “+” or “-” sign for the HI limit.

3. Press the **ENT** key to store the HI limit % in memory.

4. The display shows **5tored** for a few seconds and returns to weighing mode.



5. Press the **LO** key. Then, the last LO % weight entered will flash and the left part of analog display turns on.

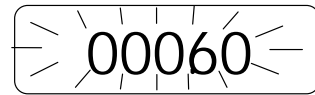

6. Enter the LO limit weight via the 10-key pad.
 £ If you hit the wrong key, press the **C** key and the LO limit % is re-displayed. Continue data entry again.

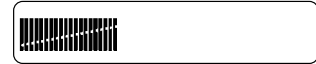
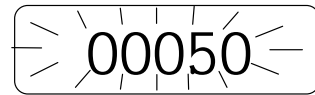

- £ You can not enter the “+” or “-” sign for the LO limit.
 7. Press the **ENT** key to store the LO limit % in memory.

8. The display shows **5tored** for a few seconds and returns to weighing mode.



- £ The HI/LO limit % has 2 decimal places fixed in the setting mode above.
 £ The HI/LO limit weight entered in the previous section will not be converted to %, and vice versa.
 £ Example:

Target weight: 3.000 kg, HI limit weight: 1.00 %, LO limit weight: 0.50 %

Then,

Upper limit = 3.000 kg + 3.000kg x 1.00 % = 3.030 kg

Lower limit = 3.000 kg - 3.000kg x 0.50 % = 2.985 kg

8-2. Upper & Lower limits weight setting mode

The UPPER & LOWER LIMITS WEIGHT SETTING MODE uses an upper limit weight and a lower limit weight. The target weight is not used. These upper (HI) and lower (LO) limits are entered via the 10-key pad directly.

- £ Set the Function “F7-0 Upper & Lower limit weight setting”.
 £ The formula to compare is as follows:
 $LO < \text{Lower limit value} \text{ mOK mUpper limit value} < HI$

Setting the upper (HI) limit weight and lower (LO) limit weight

- £ Set the Function “F7-0 Upper & Lower limit weight setting”.

1. Press the **HI** key and the last HI limit weight entered will flash and the right part of analog display turns on.

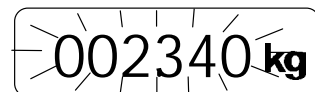

2. Enter the HI limit weight via the 10-key pad.
 £ If you hit the wrong key, press the **C** key and the old HI limit weight is re-displayed. Continue data entry again.

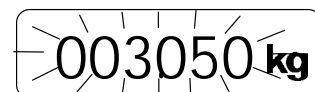

- £ You can enter minus value using the **±** key. This key toggles the sign.

3. Press the **ENT** key to store the HI limit weight in memory.

4. The display shows **5stored** for a few seconds and returns to weighing mode.



5. Press the **LO** key and the last LO limit weight entered will flash.

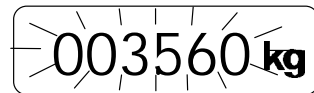

6. Enter the LO limit weight via the 10-key pad.

£ If you hit the wrong key, press the **C** key and the LO limit weight is re-displayed. Continue data entry again.

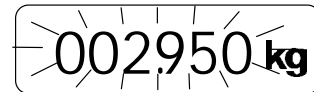

£ You can enter minus value using the **±** key. This key toggles the sign.



7. Press the **ENT** key to set the LO limit weight in memory.

8. The display shows **5stored** for a few seconds and returns to weighing mode.



£ Example:

Upper (HI) limit weight: 3.050 kg, Lower (LO) limit weight: 2.950 kg

Then,

LO: weight < 2.950 kg

OK: 2.950 kg mweight m3.050 kg

HI: 3.050 kg < weight

8-3. The comparator memory

The FS-*i* scale can store up to 100 comparator limits by 2 digit numbers, form 00 to 99.

£ To use this function, the scale must not be set to the simplified operation mode.

Storing a set of limits in memory

1. Set the comparator data according to the previous sections “8-1. Target weight setting mode” (target weight, HI limit and LO limit) or “8-2. Upper & Lower limits weight setting mode” (HI limit and LO limit).

2. Press the **STORE** key. Then the display will show **5d 00**.

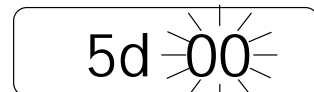

3. Press the memory number, for example 6.

£ If you stop to store, press the **C** key, the scale returns to the weighing mode.

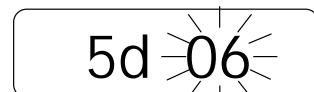

4. Press the **ENT** key to store the data to into the memory. The display shows **5stored** for a few seconds and returns to weighing mode.



Recalling a set of limits from memory

1. Press the **RECALL** key. Then the display will show **rd 00**.
2. Press the memory number, for example 3.
- £ If you stop to recall, press the **C** key, the scale returns to the weighing mode.
3. Press the **ENT** key to recall the data from the memory.
4. The display shows a set of data for a few seconds one by one and returns to weighing mode.

rd 00

rd 03

TARGET WEIGHT
(Target weight setting mode only)

3000 kg



HI LIMIT

0050 kg



LO LIMIT

0030 kg



WEIGHING MODE

9. ANALOG SWEEP DISPLAY

The FS-*i* series has a 60 segments analog sweep display. The **DISP.** key switches its display mode.

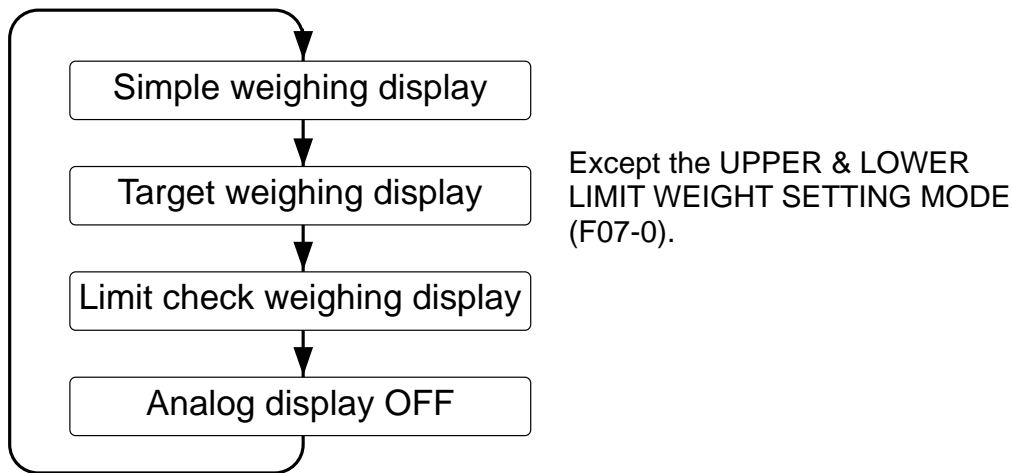

- £ It is possible to specify the display mode that will be shown first when the power is switched on. See the Function F16.
- £ Use the analog sweep display with positive target and limit weights.

9-1. Selecting a display mode

Simple weighing display mode

The 60 segments represent zero to full scale. When the scale is in the net mode, the analog sweep display shows net weight.

In the TARGET WEIGHT SETTING MODE (F07-1 or F07-2), the target weight will be shown on the display as a flashing segment.

- £ The UPPER & LOWER LIMIT WEIGHT SETTING MODE (F07-0) does not show the target weight segment.

Target weighing display mode

The 60 segments represent zero to full scale. When the scale is in the net mode, the analog sweep display shows net weight.

In the TARGET WEIGHT SETTING MODE, the 40th segment will flash as the target weight. Thus the 60 segments represent the relative weight that the target weight is scaled to the 40 segments.

As the weight increases, the analog segments approach the flashing segment. This will provide a simple way of filling the container to the target weight.

- £ The UPPER & LOWER LIMIT WEIGHT SETTING MODE (F07-0) does not have this display.

Limit check weighing display mode

The display shows comparison limits and results. The lower limit is shown at the 21st segment flashing and the upper limit is shown at the 40th segment flashing. The results will be known by the segments turned on.

9-2. Example of the analog sweep display

Simple weighing display mode

FS-30Ki / d=0.01 kg
 TARGET WEIGHT SETTING MODE
 (F07-1 or F07-2)
 Target weight = 15.00 kg.
 Net weight display (tare entered)

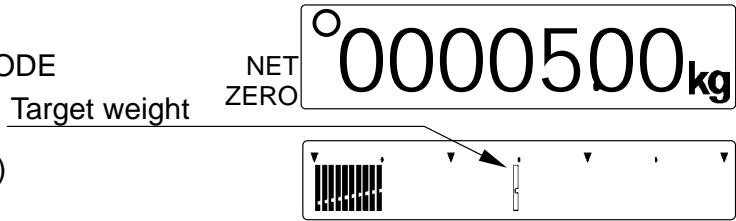

FS-30Ki / d=0.01 kg
 UPPER & LOWER LIMIT WEIGHT SETTING MODE
 (F07-0)

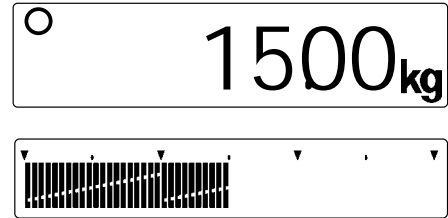

Target weighing display mode

FS-30Ki / d=0.01 kg
 TARGET WEIGHT SETTING MODE
 (F07-1 or F07-2)
 Target weight = 15.00 kg.

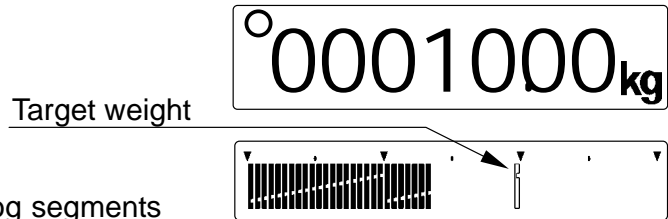

£ As the weight increases, the analog segments approach the flashing segment. This will provide a simple way of filling a container to a target weight.

£ The UPPER & LOWER LIMIT WEIGHT SETTING MODE (F07-0) does not have this display mode.

Limit check weighing display mode

FS-30Ki / d=0.01 kg
 TARGET WEIGHT SETTING MODE
 (F07-1 or F07-2)
 Target weight = 5.00 kg.
 HI = 0.10 kg, LO = 0.09 kg

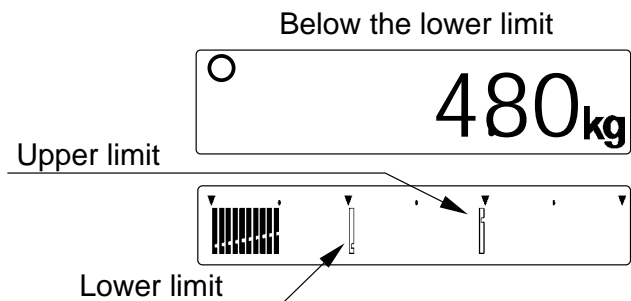

Within the limits



Above the upper limit

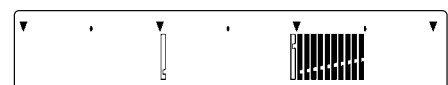
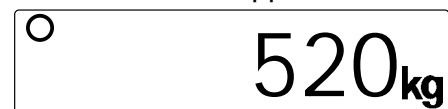

FS-30Ki / d=0.01 kg
 UPPER & LOWER LIMIT WEIGHT SETTING MODE
 (F07-0)
 Target weight = 5.00 kg.
 HI = 10.10 kg, LO = 9.91 kg

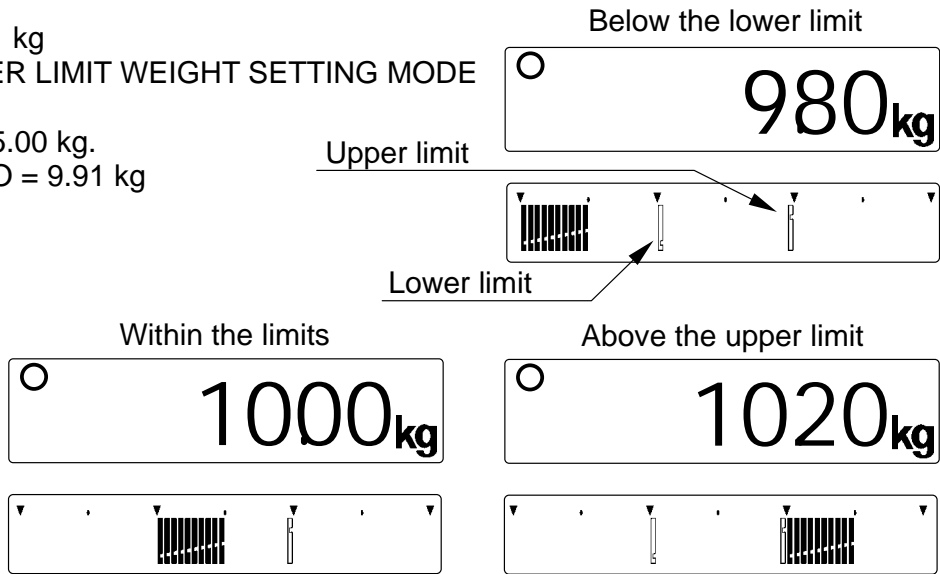

£ Outside the range of the analog sweep display
 FS-30Ki / d=0.01 kg
 TARGET WEIGHT SETTING MODE
 (F07-1 or F07-2)
 Target weight = 5.00 kg.
 HI = 0.10 kg, LO = 0.09 kg

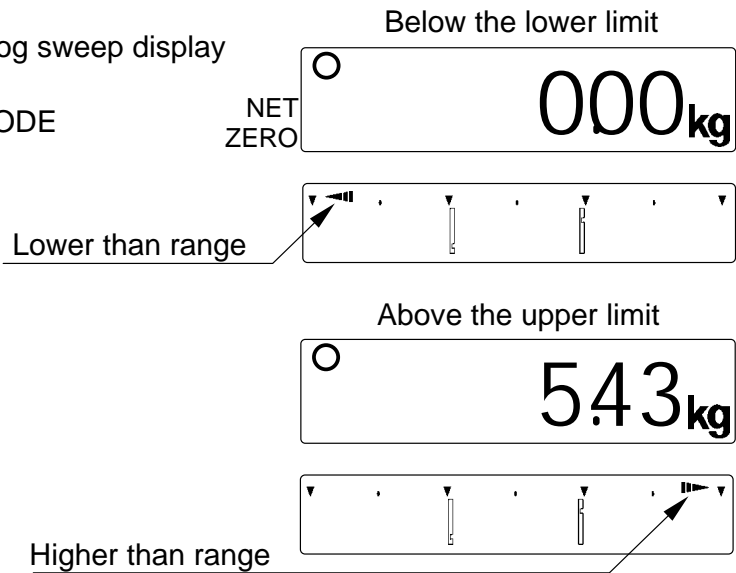

10. CALIBRATION

This function adjusts the scale for accurate weighing.
Calibrate the scale in the following cases.

- £ When the scale is first used.
- £ When the scale has been moved.
- £ When the ambient environment has changed.
- £ For regular calibration.

Loose the lock screws on the rear side of the display pod, and remove the CAL switch cover. Then, there is a calibration switch inside.

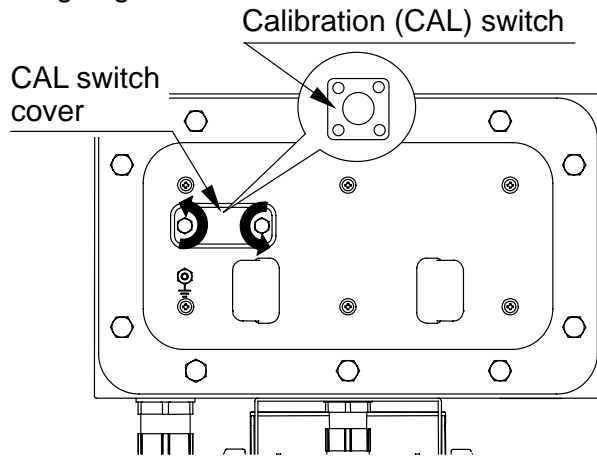

10-1. Calibration using a weight

1. Warm up the scale for at least half an hour with nothing on the weighing pan.
 - £ Change Function setting "F1" or place something on the pan to disable the auto power-off function.

2. Press and hold the calibration (CAL) switch until appears, and release the switch.

- £ **Press and hold the key for about 5 seconds, then you can also enter the calibration mode.**

- £ Press the key or CAL switch to exit without calibration.

3. Press the key, then the gravity acceleration value will be displayed.

- £ **It is not necessary to set the gravity acceleration value when calibrating the scale with a calibration weight at the place where it is to be used. (See the next section about the gravity acceleration correction.)**

4. Press the key, then the will be displayed.

5. Make sure that there is nothing on the weighing pan, and wait until the STABLE annunciator turns on.

6. Press the key. The scale calibrates the zero point, and the display shows "5pn 1" and the weight value to calibrate (SPAN calibration).

- £ **The weight value is equal to the capacity. When you enter with "kg" or "g" mode, then the value is "kg". Entering with "lb" or "oz", then "lb".**

↓

- £ If you do not need SPAN calibration, turn the power off to exit from the calibration procedure.

7. To calibrate with the different weight, change the displayed value using the 10-key pad.
- £ If you hit the wrong number, press the **C** key. The value returns to the capacity and enter again.
8. Place the calibration weight on the pan with the same value as displayed, and wait until the STABLE annunciator turns on.
9. Press the **ENT** key. The scale calibrate SPAN and **end** will appear. Remove the weight from the pan, and turns the power off.



£ **Note**

The value set in step 7 will be cleared after the power is switched off.

If the scale will suppose to move to another location, set the gravity acceleration value for the current location and calibrate the scale according to the procedure above. See the next section to set the value.

10-2. Gravity acceleration correction

When the scale is first used or has been moved to different place, it should be calibrated using a calibration weight.

But if a calibration weight is not available, the gravity acceleration correction will compensate the scale. Change the gravity acceleration value of the scale to the value of area where the scale will be used. Refer to the gravity acceleration map appended to the end of this manual.

£ **Note**

It is not necessary to set the gravity acceleration correction when calibrating the scale with a calibration weight at the place where it is to be used.

1. At step 3. of the previous section “10-1. Calibration using a weight”, enter a new value using 10-key pad.
- £ The integral part “9” is fixed and enter the value after the decimal point.
- £ If you hit the wrong number, press the **C** key. The value returns to the original number. Enter again.
2. Press the **ENT** key, then the **Cal 0** will be displayed.
3. If necessary to calibrate the scale using a calibration weight, go to step 5 of “10-1. Calibration using a weight”. To finish the setting, turn the power off.



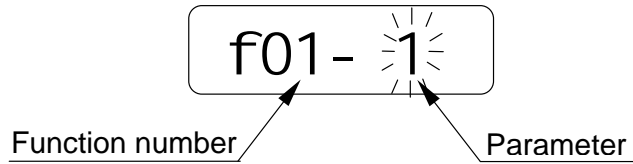

11. FUNCTIONS

The scale has Function settings to expand your applications. The parameters set in the Function settings are maintained even if the power switched off.

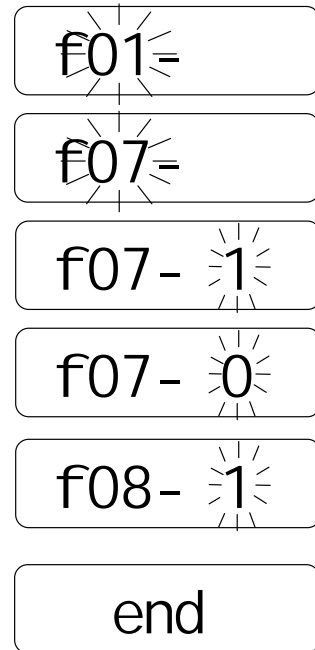

11-1. The procedure for setting parameters

1. Turn the power off.
 2. Press and hold the **ZERO** key and turn the power on via the **ON/OFF** key. Then the first function number is displayed.
 3. Enter the Function number using the 10-ley pad.
 4. Press the **ENT** key. Then the parameter stored is appears.
 3. Enter the parameter value using the 10-ley pad.
 - £ If you do not need to change the parameter, turn the power off without pressing **ENT** key.
 - £ If you like to go to the next function number, press the **ZERO** key and set the new parameter if necessary.
4. Press the **ENT** key. The display shows **end** for a few seconds and returns to weighing mode.
 - £ Be sure to press the **ENT** key because all of the new parameters are not stored until **end** is displayed.



11-2. Function list

Item	Function number	Description	
Auto power-off function	☒ f 1- 0	Auto power-off disabled	Automatically power off
	f 1- 1	Auto power-off enabled	
Display resolution	☒ f 2- 0	Normal (1/3,000 class)	Legal for trade is Normal only.
	f 2- 1	High (1/6,000~1/7,500 class)	
	f 2- 2	Higher (1/12,000~1/15,000 class)	
Weighing unit when powered on	f 3- 0	kg	Factory setting may be different depending on the area to be shipped.
	f 3- 1	g	
	☒ f 3- 2	lb	
	f 3- 3	oz	
	f 3- 4	lb-oz	
Serial interface Baud rate	☒ f 4- 0	2400 bps	Optional RS-232C/422/485
	f 4- 1	4800 bps	
	f 4- 2	9600 bps	
Serial interface Data bit / Parity	☒ f 5- 0	7 bit / Even parity	Optional RS-232C/422/485
	f 5- 1	7 bit / Odd parity	
	f 5- 2	8 bit / Non parity	
Serial interface Data output mode	f 6- 0	Stream mode	Optional RS-232C/422/485. The UFC format is applicable to f6-2 to 4.
	f 6- 1	Command mode	
	☒ f 6- 2	Print key mode	
	f 6- 3	Auto-print mode + data	
	f 6- 4	Auto-print mode +/- data	
Comparison mode	f 7- 0	Upper & Lower limits weight setting mode	Way to set parameters.
	☒ f 7- 1	Target weight setting mode with HI/LO limit weight	
	f 7- 2	Target weight setting mode with HI/LO limit % of the target weight	
Comparator operating condition	f 8- 0	Comparator disabled	Conditions to compare. d = minimum display division
	☒ f 8- 1	Compares all data	
	f 8- 2	Compares all stable data	
	f 8- 3	Compares data > +4d or < -4d	
	f 8- 4	Compares stable data > +4d or < -4d	
	f 8- 5	Compares data > +4d	
	f 8- 6	Compares stable data > +4d	
Comparator buzzer	☒ f 9- 0	Buzzer does not sound.	Buzzer sounds according to the comparator results
	f 9- 1	Buzzer sounds at LO	
	f 9- 2	Buzzer sounds at OK	
	f 9- 3	Buzzer sounds at LO and OK	
	f 9- 4	Buzzer sounds at HI	
	f 9- 5	Buzzer sounds at LO and HI	
	f 9- 6	Buzzer sounds at OK and HI	
	f 9- 7	Buzzer sounds at LO, OK and HI	
Response / Filtering	f10- 0		Software filtering
	☒ f10- 1		
	f10- 2		
	f10- 3		
	f10- 4		

☒ Factory setting

Item	Function number	Description	
Stability detection width	f11- 0	Narrow	Condition to detect stability
	☒ f11- 1		
	f11- 2	Wide	
Stability detection time	f12- 0	Short	
	☒ f12- 1		
	f12- 2	Long	
Zero tracking	f13- 0	Zero tracking OFF	
	☒ f13- 1	Zero tracking ON	
Key operation	☒ f14- 0	All keys enabled	Simplified operation available
	f14- 1	ON/OFF, ZERO, TARE, SAMPLE & PRINT/ENT only enabled.	
	f14- 2	ON/OFF, ZERO & TARE only enabled	
Comparator light brightness	f15- 0	Dark	Brightness control
	f15- 1		
	f15- 2		
	f15- 3		
	f15- 4		
	f15- 5		
	☒ f15- 6		
	f15- 7		
	f15- 8	Bright	
Analog sweep display when powered on	☒ f16- 0	Simple weighing display mode	
	f16- 1	Target weighing display mode	
	f16- 2	Limit check weighing display mode	
	f16- 3	Display off	
LCD backlight	f17- 0	Always OFF	Weight change or key operation turns on.
	☒ f17- 1	Always ON	
	f17- 2	Turns off after 30 sec. weight stability	
	f17- 3	Turns off after 60 sec. weight stability	
Serial interface Address	☒ f18- 00	00 RS-232C must be set to this.	Optional RS-232C/422/485
	f18- ##	## = 01~99 RS-422/485	
Serial interface	☒ f19- 0	RS-232C	
	f19- 1	RS-422	
	f19- 2	RS-485	
Serial interface operation mode	f20- 0	Reply to the command is sent.	F6-1
	☒ f20- 1	No reply to the command.	F6-2, 3 or 4
	f20- 2	UFC format	

☒ Factory setting

12. SPECIFICATIONS

12-1. Specifications

MODEL		FS-6Ki	FS-15Ki	FS-30Ki
kg	Capacity	6	15	30
	Min. display	0.002 *	0.005 *	0.01 *
		0.001 0.0005	0.002 0.001	0.005 0.002
g	Capacity	6000	15000	30000
	Min. display	2 *	5 *	10 *
		1 0.5	2 1	5 2
lb	Capacity	15	35	70
	Min. display	0.005 *	0.01 *	0.02 *
		0.002 0.001	0.005 0.002	0.01 0.005
oz	Capacity	240	560	1120
	Min. display	0.1 *	0.2 *	0.5 *
		0.05 0.02	0.1 0.05	0.2 0.1
lb-oz	Capacity	15	35	70
	Min. display	0.1	0.1	0.1
Repeatability (Std. deviation)		0.001 kg	0.002 kg	0.005 kg
Linearity error		±0.002 kg	±0.005 kg	±0.01 kg
Span drift		±20 ppm / °C (5°C~35°C / 41°F~95°F)		
Display		7 segment LCD display (Character height 18.6 mm) with backlight 60 segment analog sweep display with backlight		
Display update		Approximately 10 times per second		
Operating temp.		-10°C~40°C / 14°F~104°F, less than 85% R.H.		
Power supply		AC main (100V~240V) or SLA Battery (option)		
Weighing pan size		250 x 250 mm / 9.8 x 9.8 in.		380 x 300 mm 15.0 x 11.8 in.
Dimension		250(W) x 414(D) x 496(H) mm 9.8(W) x 16.3(D) x 19.5(H) in.		380(W) x 464(D) x 496(H) mm 15.0(W) x 18.3(D) x 19.5(H) in.
Weight (approximately)		8.1 kg / 17.9 lb		14.9 kg / 32.8 lb
Calibration weight		6 kg 15 lb	15 kg 30 lb	30 kg 60 lb

*) Factory setting

12-2. Dimensions

FS-6Ki
FS-15Ki

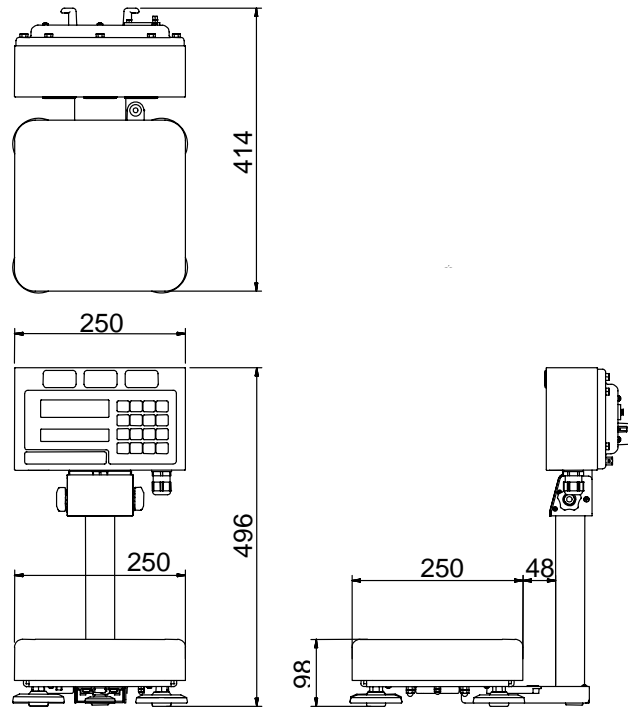

FS-30Ki

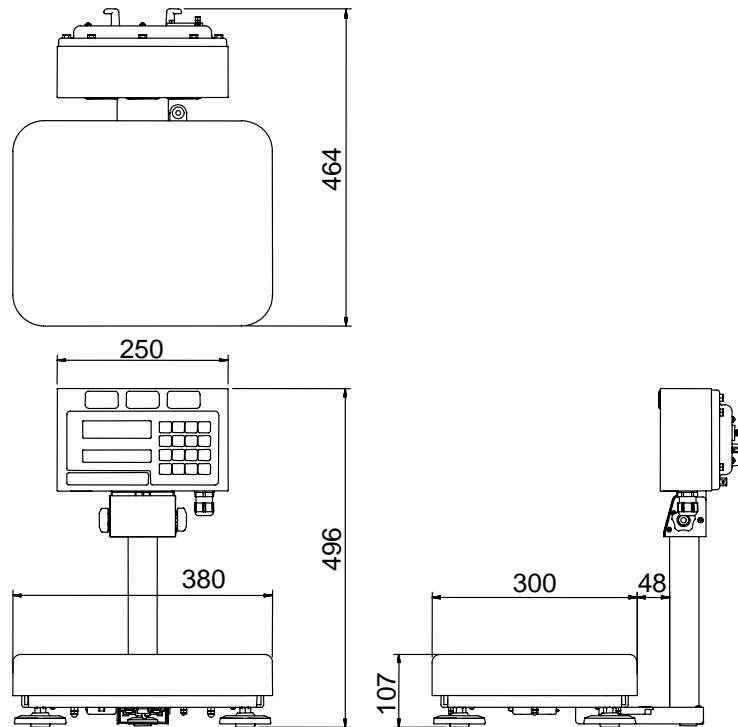

Unit: mm

13. GRAVITY ACCELERATION MAP

Values of gravity at various locations

Amsterdam	9.813 m/s ²	Manila	9.784 m/s ²
Athens	9.807 m/s ²	Melbourne	9.800 m/s ²
Auckland NZ	9.799 m/s ²	Mexico City	9.779 m/s ²
Bangkok	9.783 m/s ²	Milan	9.806 m/s ²
Birmingham	9.813 m/s ²	New York	9.802 m/s ²
Brussels	9.811 m/s ²	Oslo	9.819 m/s ²
Buenos Aires	9.797 m/s ²	Ottawa	9.806 m/s ²
Calcutta	9.788 m/s ²	Paris	9.809 m/s ²
Cape Town	9.796 m/s ²	Rio de Janeiro	9.788 m/s ²
Chicago	9.803 m/s ²	Rome	9.803 m/s ²
Copenhagen	9.815 m/s ²	San Francisco	9.800 m/s ²
Cyprus	9.797 m/s ²	Singapore	9.781 m/s ²
Djakarta	9.781 m/s ²	Stockholm	9.818 m/s ²
Frankfurt	9.810 m/s ²	Sydney	9.797 m/s ²
Glasgow	9.816 m/s ²	Taichung	9.789 m/s ²
Havana	9.788 m/s ²	Tainan	9.788 m/s ²
Helsinki	9.819 m/s ²	Taipei	9.790 m/s ²
Kuwait	9.793 m/s ²	Tokyo	9.798 m/s ²
Lisbon	9.801 m/s ²	Vancouver, BC	9.809 m/s ²
London (Greenwich)	9.812 m/s ²	Washington DC	9.801 m/s ²
Los Angeles	9.796 m/s ²	Wellington NZ	9.803 m/s ²
Madrid	9.800 m/s ²	Zurich	9.807 m/s ²

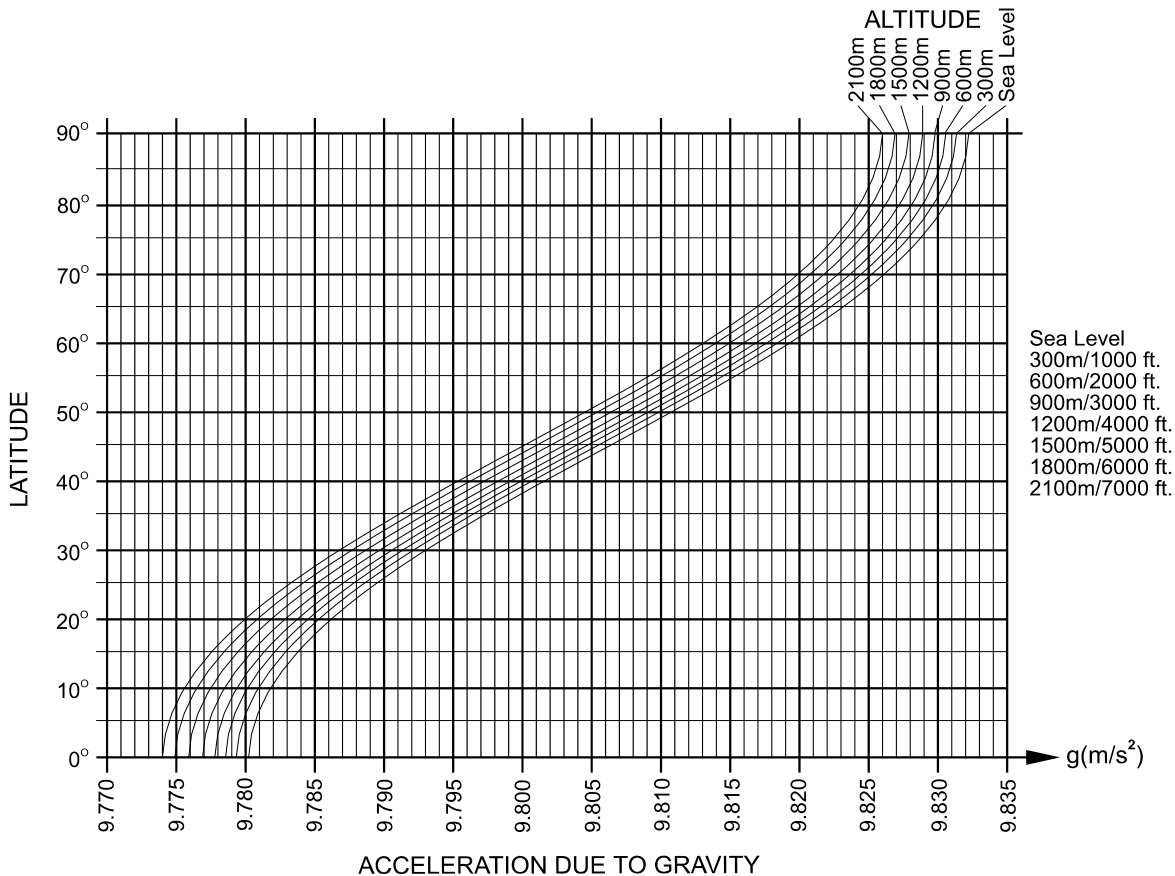

World map

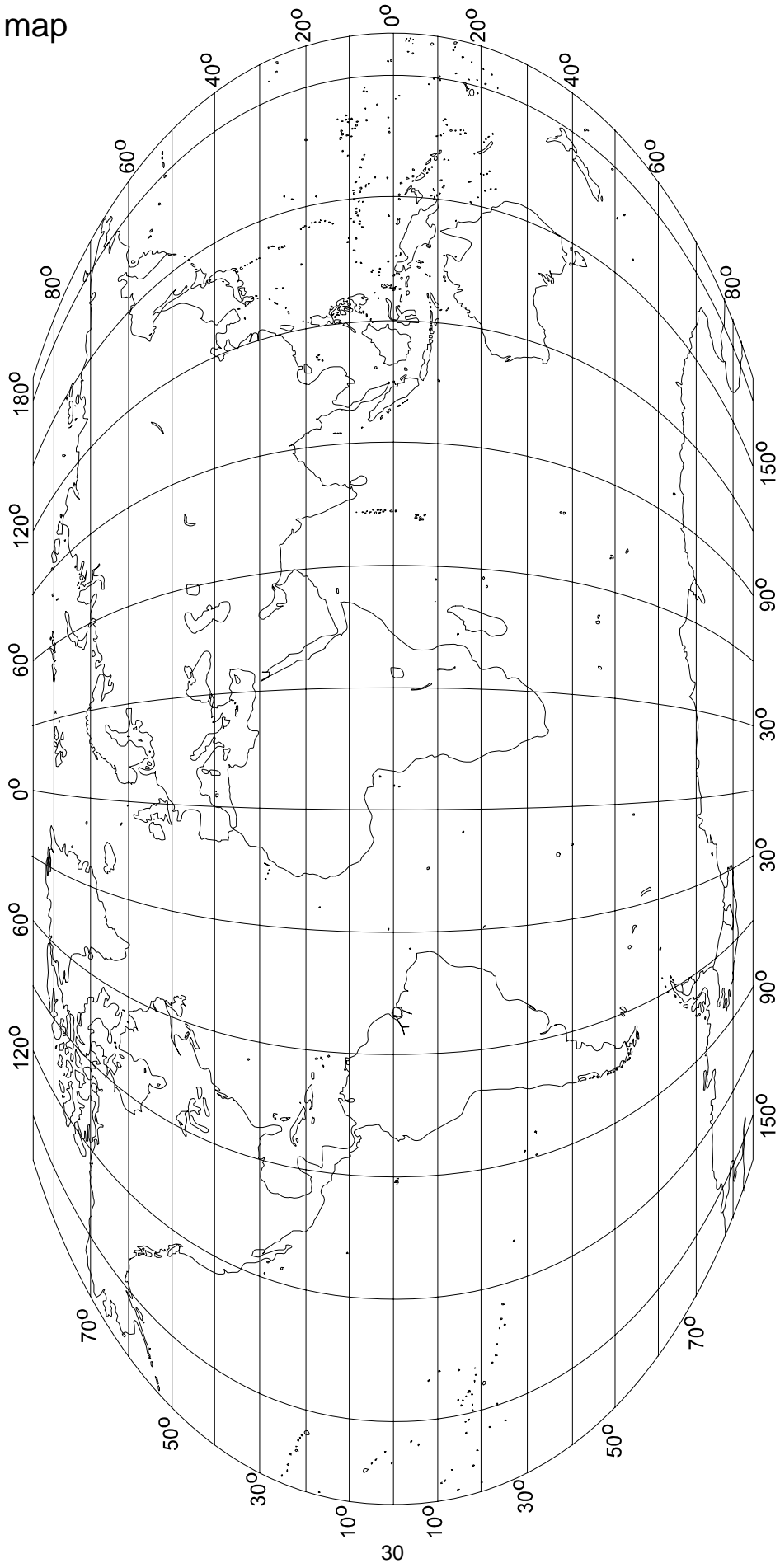

AND