

# HC-*i* Series

## INSTRUCTION MANUAL

---

### Counting Scale

HC-30*Ki*

HC-15*Ki*

HC-6*Ki*



HC-3*Ki*

**AND**

A&D Company, Limited

## This Manual and Marks

All safety messages are identified by the following, "WARNING" or "CAUTION", of ANSI Z535.4 (American National Standard Institute: Product Safety Signs and Labels). The meanings are as follows:

 WARNING	A potentially hazardous situation which, if not avoided, could result in death or serious injury.
 CAUTION	A potentially hazardous situation which, if not avoided, may result in minor or moderate injury.



This is a hazard alert mark.



This mark informs you about the operation of the product.

**Note** This manual is subject to change without notice at any time to improve the product. No part of this manual may be photocopied, reproduced, or translated into another language without the prior written consent of the A&D Company.

Product specifications are subject to change without any obligation on the part of the manufacture.

## Compliance with FCC rules

Please note that this equipment generates, uses and can radiate radio frequency energy. This equipment has been tested and has been found to comply with the limits of a Class A computing device pursuant to Subpart J of Part 15 of FCC rules. These rules are designed to provide reasonable protection against interference when this equipment is operated in a commercial environment. If this unit is operated in a residential area it might cause some interference and under these circumstances the user would be required to take, at his own expense, whatever measures are necessary to eliminate the interference. (FCC = Federal Communications Commission in the U.S.A.)

Copyright©2005 A&D Company, Limited

---

# Contents

---

1. INTRODUCTION.....	3
1-1. Introduction.....	3
1-2. Unpacking.....	4
1-3. Parts Overview .....	4
1-4. Setting Up Your Scale.....	5
1-5. Simple Operation Mode .....	6
1-6. kg or lb Weighing Units.....	6
1-7. Last Unit Weight Used Feature.....	6
2. Front Panel Overview.....	8
3. BASIC OPERATIONS .....	9
3-1. Basic Operations .....	9
3-2. To Start Counting .....	11
3-3. Unit Weight By a SAMPLE .....	12
3-5. Unit Weight By ID Number.....	17
4. ENTERING A TARE WEIGHT .....	18
4-1. Using the KEYBOARD TARE Key .....	18
4-2. To Clear TARE .....	19
5. STORE UNIT WEIGHT .....	20
5-1. Store Unit Weight by ID Numbers.....	20
5-2. Clearing A Stored Unit Weight.....	21
5-3. Unit Weight, Tare Weight & Comparator Limits Stored .....	22
6. USING THE M+ MEMORY .....	23
6-1. The M+ Memory Function.....	23
6-2. Viewing the M+ TOTAL.....	24
6-3. Clearing the M+ TOTAL .....	24
6-4. The M- Function.....	24
7. COMPARATOR FUNCTION.....	25
8. CALIBRATION.....	27
8-1. Calibration Procedure Using a Weight.....	27
8-2. Gravity Compensation .....	29
9. F-FUNCTION PARAMETERS .....	30
9-1. To Change or View F-Function Settings .....	30
9-2. F-Functions.....	31
10. ACAI FUNCTION.....	37
10-1. ACAI Automatic Counting Accuracy Improvement.....	37
10-2. ACAI Automatic Operation .....	37
10-3. ACAI Manual Operation .....	38

11. AWA FUNCTION.....	39
11-1. AWA Audible Weighing Assist.....	39
11-2. To Enable/Disable the AWA Function.....	39
12. OP-02 BATTERY.....	41
13. OP-03 RS-232C SERIAL INTERFACE.....	43
13-1. Installation.....	43
13-2. RS-232C Specifications.....	43
13-3. Data Output Mode.....	44
13-4. Connecting the AD-8121 Printer / MODE 1 or MODE 2.....	45
13-5. Connecting the AD-8121 Printer / MODE 3.....	46
13-6. Command Mode.....	46
13-7. Using UFC (Universal Flex Coms) Function.....	51
14. OP-04 RS-232C & RELAY OUTPUT.....	53
15. OP-08 EXTENSION CABLE.....	54
16. SPECIFICATIONS.....	55
17. GRAVITY ACCELERATION MAP.....	56

---

# 1. INTRODUCTION

---

## 1-1. Introduction

### *Thank you for your Purchase!*

This manual describes the functions of your counting scale and how to get the most out of it. Read this manual carefully before use.

### Features

The HC-*i* counting scales have the following features:

- The scales have a high internal resolution for a wider range of counting applications.
  - HC-3Ki / 6Ki / 30Ki: 1/600,000
  - HC-15Ki: 1/750,000
- There are the following ways to enter a unit weight (of the sample piece).
  - The way to weigh a fixed number of samples like 5 pieces, 10 pieces and so on.
  - The way to weigh the desired number of samples.
  - The way to store the desired unit weight directly using the 10-key pad.
  - The way to recall the stored unit weight from ID memory.
  - The way to send the desired unit weight from a personal computer.
- Three UNIT WEIGHT BY LED's will navigate you to enter a unit weight easily.
- ACAI (Automatic Counting Accuracy Improvement) supports counting by recalculating the unit weight when a sample is added. Therefore it is possible to reduce the counting error.
- The scale can show information for piece count, weight, unit weight and comparator result at the same time.
- UP to 99 ID memories can store ID numbers, unit weight, tare weight and comparator limits.
- Comparator function:
  - Compare a count or weight
  - Comparator limits can be changed using the 10-key pad.
  - Comparator relay output is also available using an optional interface.
- Accumulation function for counting.
- Optional RS-232C interface to communicate with a personal computer and printer expanding the counting application.
- The optional SLA (sealed lead acid) battery is useful for portable operation.
- The display unit is detachable from the scale base (approximately 60 cm). The distance between them can be extended to 2m by using the optional cable.

## 1-2. Unpacking

- ❑ Unpack the scale carefully and keep the packing material if you are likely to transport the scale again in the future.
- ❑ In the carton you should find this manual plus:
  - ❑ The counting scale.
  - ❑ An AC adapter (check that the AC input rating is correct).

Remove the protective packing materials from around the scale and between the pan and scale casing.

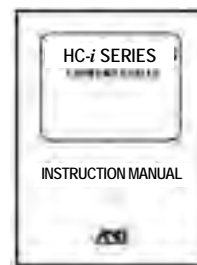

Instruction Manual

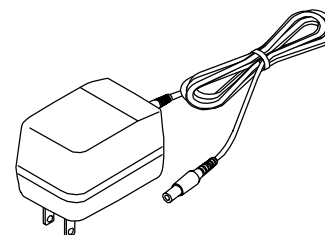
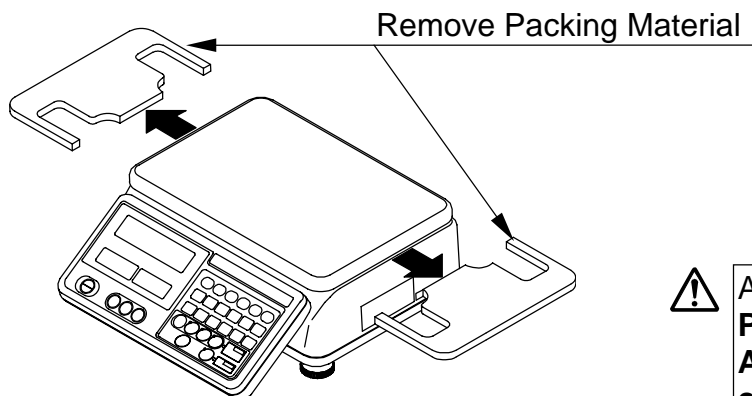

**AC Adapter**  
**Please confirm that the**  
**AC adapter type is**  
**correct for your local**  
**voltage and receptacle**

## 1-3. Parts Overview

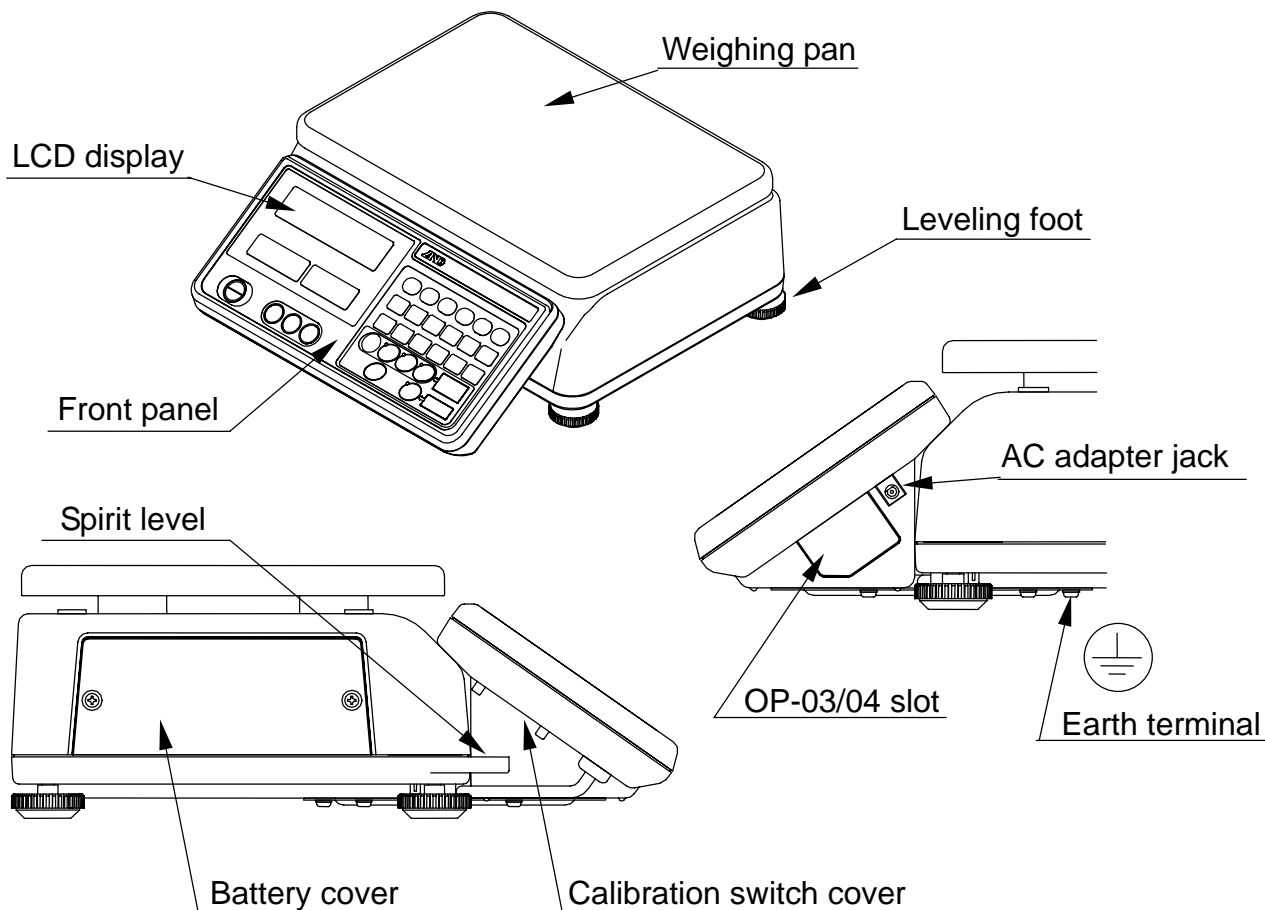

## 1-4. Setting Up Your Scale

1. Place the scale on a suitable weighing surface (see “Best Conditions For Weighing” below) and turn the adjustable feet until the spirit level shows that the scale is level.

2. Plug in the AC adapter. The AC input requirements could be 100, 120, 220, 230 or 240 Volts (50/60Hz) depending on the area in the world, so please check that the adapter is correct. Earth ground the chassis if you think static electricity may be a problem.

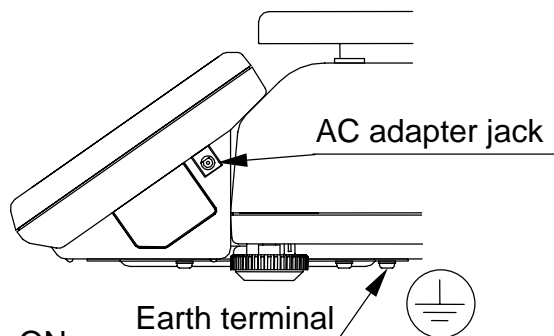

3. Press the **ON/OFF** key to turn the power ON.  
All the display symbols are displayed.

Then the display turns off once, and zero will be shown with the ZERO indicator.

4. Press the **ON/OFF** key again, and the power will switch OFF.

Auto-power off function

It is possible to have the power automatically switched OFF. If zero is displayed for approximately 5 minutes. See “9-2. F-Functions” and set the F-Function *F-04-05* at “/” to enable the function.

5. Switch the power ON at least half an hour before use so that the scale can warm up.

## Detach The Display Unit

Remove the display support plate first. Then, retrieve the cable and attach the display support plate again. Refer to the “15. OP-08 EXTENSION CABLE” to remove and attach the plate.

## Best Conditions For Weighing

- The Scale must be level (check the spirit level on the scale).
- Best operating temperature is between 20°C~25°C / 68°F~77°F at about 50%~60% Relative Humidity. There shouldn't be large temperature fluctuations.
- The weighing room should be kept clean and dry.
- The weighing table must be of a solid construction.
- Corners of rooms are best as they are less prone to vibrations.
- Don't install the scale near heaters or air conditioners.
- Don't install the scale in direct sunshine.
- Try to ensure a stable AC power supply when using the AC adapter.
- Keep equipment containing magnets away from the scale.
- Warm up the scale more than 30 minutes before use.
- Ground the scale chassis for electrostatic discharge if the weighing conditions warrant.

## Calibration

Calibration of the HC-*i* is required when the scale is initially installed. Please see “8. CALIBRATION” for more calibration information.

## 1-5. Simple Operation Mode

If desired, the HC-*i* scale can be set in a Simple Operation Mode. Set the F-Function *F-01-01* to "1". In this mode, only front panel keys that would be used in "3-3. Unit Weight By a Sample" counting operations are active. All others will not operate. The following keys are active in Simple Operations Mode:

**Keys that will operate in Simple Operation Mode:**

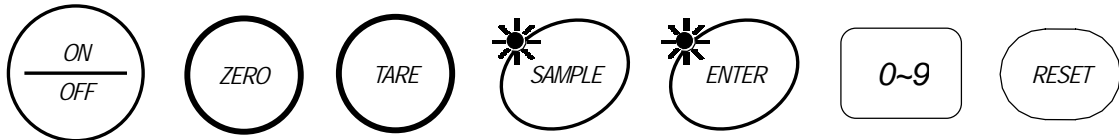

## 1-6. kg or lb Weighing Units

USA Version ONLY

The HC-*i* scale can weigh and register the unit weight in pounds or kilograms. When you switch between the weighing units, any weight amounts being used are also converted.

- To change the weighing units between pounds and kilograms, see F-Function *F-00-01*. Set to "0" for kg; or to "1" for lb.

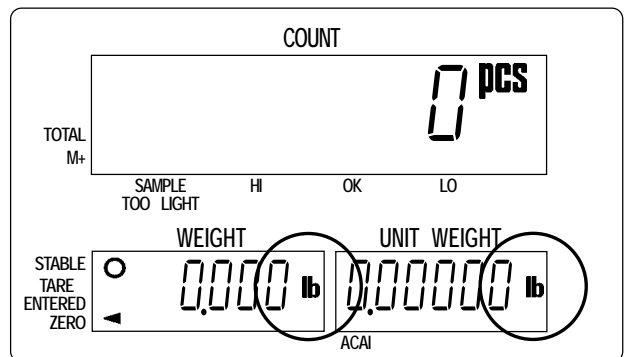

Or,

- Set F-Function *F-09-01* to "2" and you can change the weighing units between "kg" and "lb" by using the **[\*]** key.

## 1-7. Last Unit Weight Used Feature

There are a number of ways to register a unit weight to count. The HC-*i* scale has a feature to keep the last unit weight used in memory. This can be handy if you turn the scale off and then want to return to the same unit weight, or you accidentally clear the unit weight by pressing the **[RESET]** key.

When a unit weight is registered it is automatically placed in the ID "id-00" and remains there until a new unit weight is entered. It can be recalled by the following:

- When a unit weight is cleared and the three **UNIT WEIGHT BY** LED's are blinking;

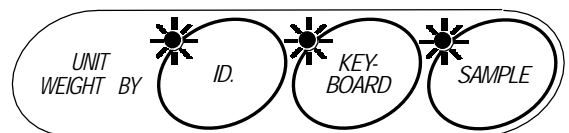

- Press the **[ID]** key. 'id 00' will be displayed with  $\Rightarrow 00 \Leftarrow$  blinking.

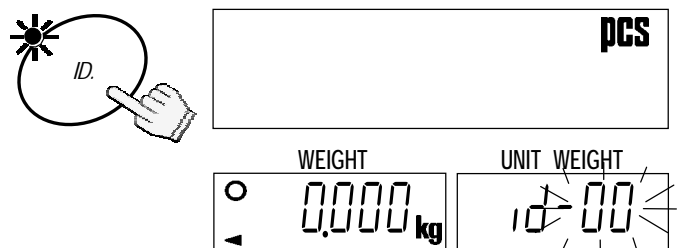



3. Press the **ENTER** key.  
The scale will recall the unit weight previously used.

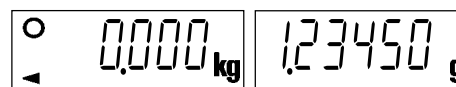
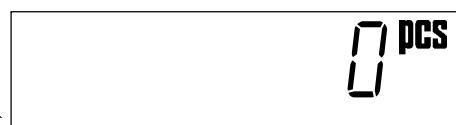
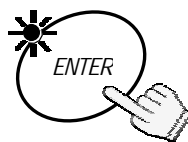

- This feature cannot be used in Simple Operation Mode.

### Automatic Last Unit Weight Used

When you turn the display ON, the scale can automatically recall the last unit weight used from memory, if desired.

- Set the F-Function *F-01-04* to "1". The scale will recall the last unit weight used, when the display is turned ON.

# 2. Front Panel Overview

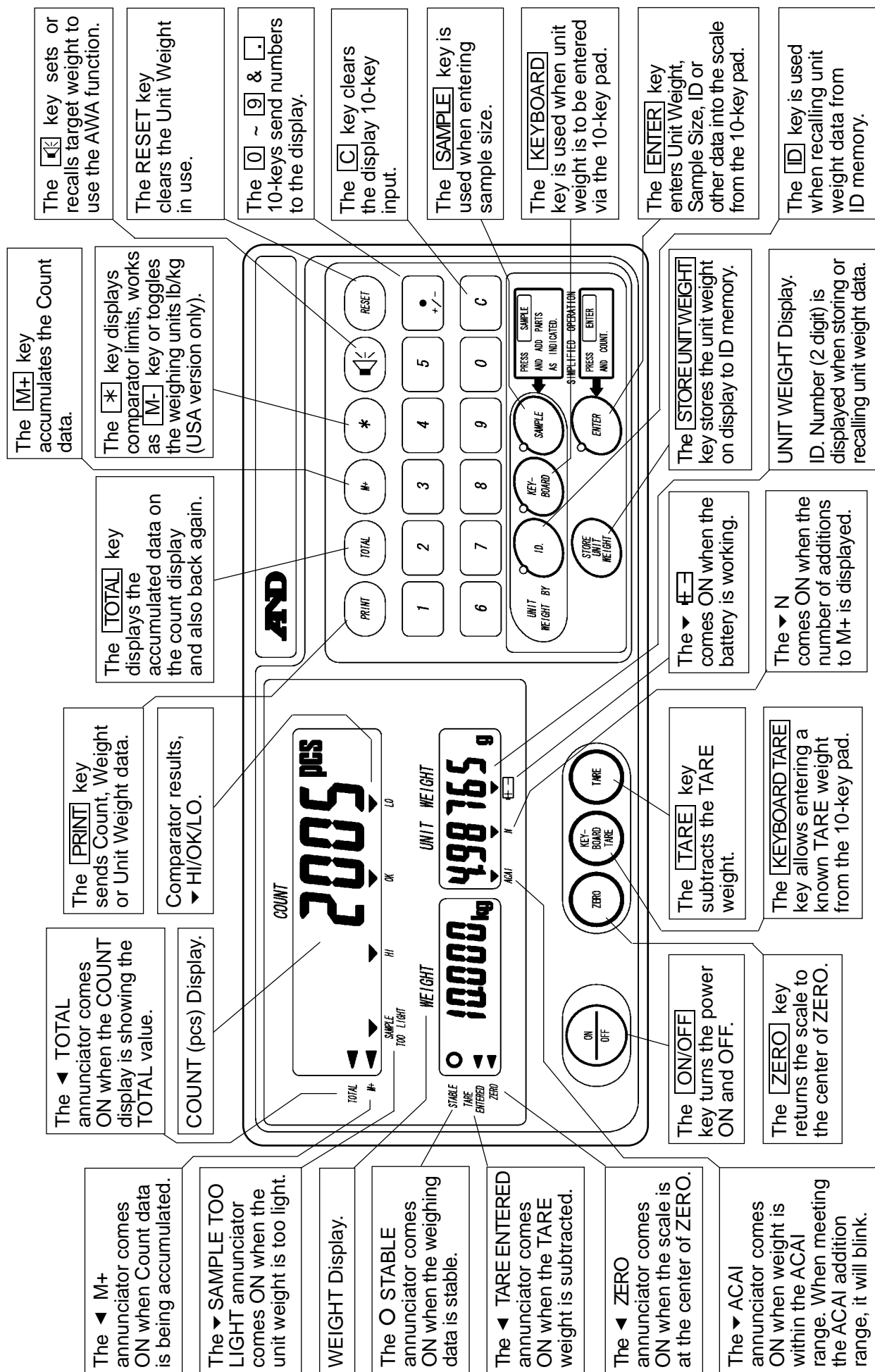

# 3. BASIC OPERATIONS

## 3-1. Basic Operations

### Turn The Power ON and OFF

1. Press the **ON/OFF** key to turn the power ON.

All the display symbols will turn on. After a few seconds, the display turns off once. Then, the scale will automatically read the zero point (power-on zero) and the display shows zero.

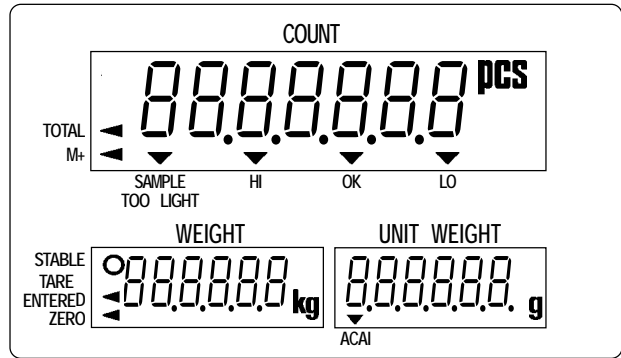
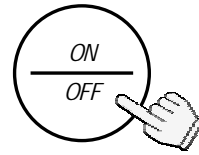

2. Press the **ON/OFF** key again, and the power will be switched OFF.

- Auto-power off function

It is possible to have the power automatically switched OFF, if zero is displayed for approximately 5 minutes. See "9-2. Functions" and set the F-Function *F-04-05* to "1" to enable the function.

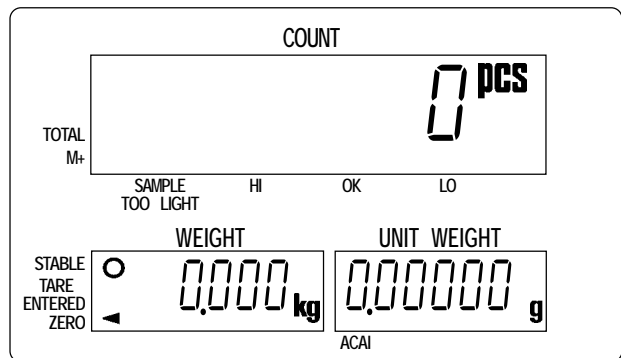

### ZERO

- The **ZERO** key will bring the weight display back to zero.

1. Remove everything from the weighing pan and press the **ZERO** key. Then the weight display shows "-----" and waits for the weighing data to become stable.
2. The scale will zero and the ZERO indicator will come ON to indicate that the scale is ready to start weighing or counting.

- There is an automatic re-zeroing function called "Zero Tracking". The scale initially comes with this function enabled to take care of normal drift from zero caused by changes in temperature, humidity, air pressure etc. (F-Function *F-04-01*).

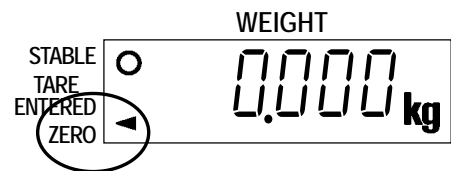

## TARE

□ The **TARE** key will subtract the displayed container weight.

1. Remove everything from the weighing pan and press the **ZERO** key to zero the scale.

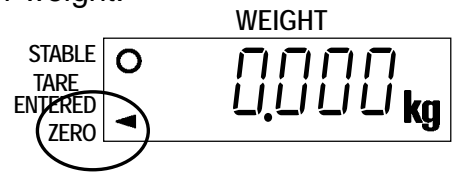

2. Place a tare container on the weighing pan. The weight display will show the weight of the container.

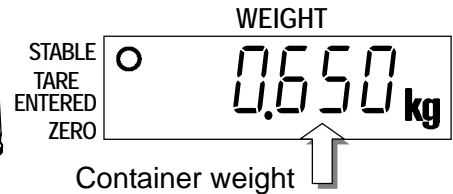
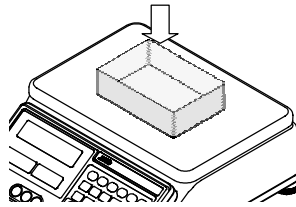

3. Press the **TARE** key. Then the weight display shows "-----" and waits for the weighing data to become stable.

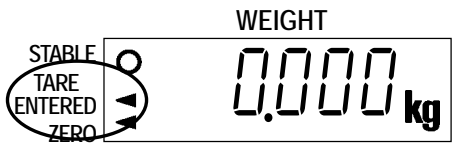
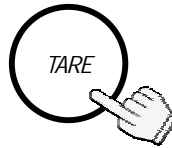

4. The scale will subtract the weight of the container and the weight display changes to net weight.

□ The TARE ENTERED indicator will light.

## 3-2. To Start Counting

1. Press the **ON/OFF** key to turn the scale ON. Or press the **RESET** key to initialize any previous operations.
2. The three LED's on the **UNIT WEIGHT BY** keys will blink. This is to prompt you to select a method for entering a unit weight for operation.

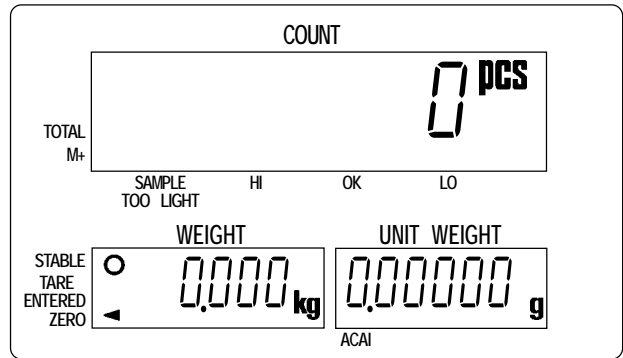

3. Select one of the ways to enter or recall the unit weight (the weight of one item of what you are counting), and see the section noted for more instructions.

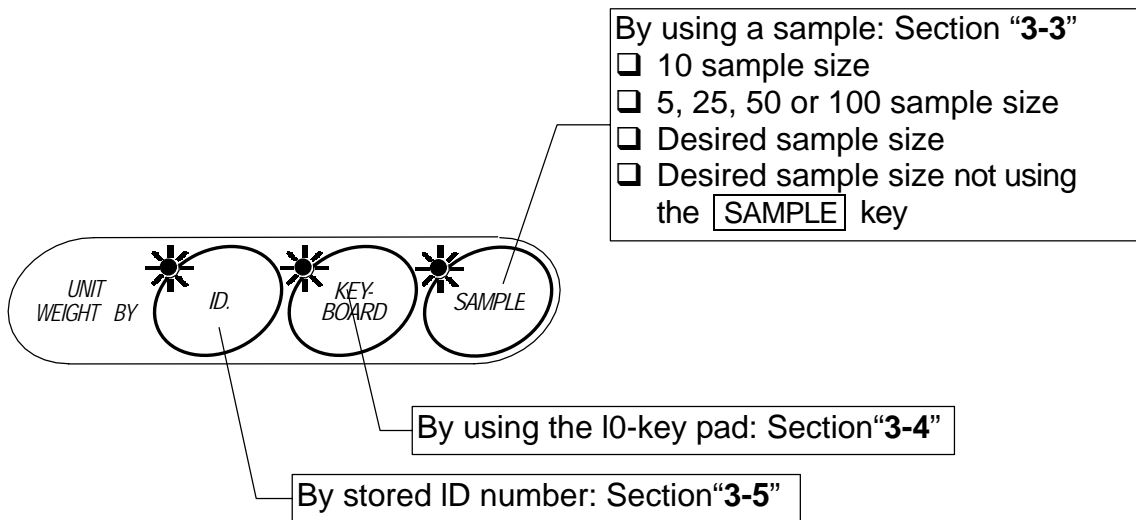



You can return to this point at any time during operation by pressing the **RESET** key. (This doesn't clear the entered tare weight, M+ memory, AWA settings and comparator limits.)

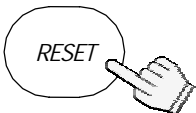

### 3-3. Unit Weight By a SAMPLE

#### 10 Sample Size

1. The three **UNIT WEIGHT BY** LED's should be blinking at this point, if not, press the **RESET** key to clear any unit weight. If you are going to use a tare container, place it on the weighing pan.

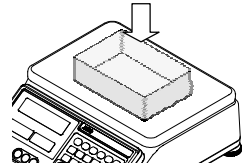

2. Press the **SAMPLE** key. Any tare container will be automatically tared. The display Will show "Add" "10 pcs".

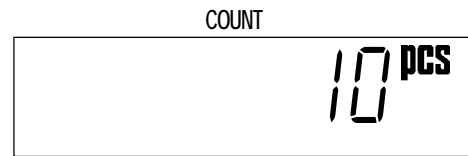
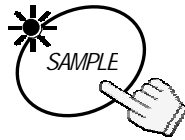

If weight isn't zero, press **TARE**.

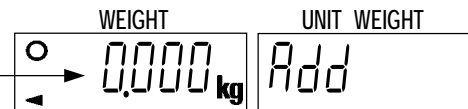

3. Place 10 sample pieces on the weighing pan (or in the tare container). The weight of all 10 pieces will be displayed.

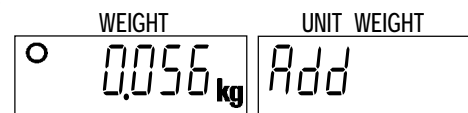
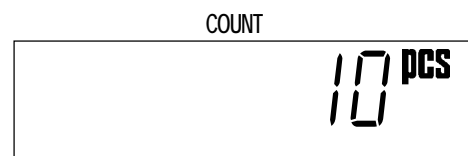
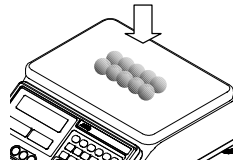

4. Press the **ENTER** key. The display will show "-----" for a moment while calculating the unit weight. After a moment the display will show the count, total weight and unit weight.

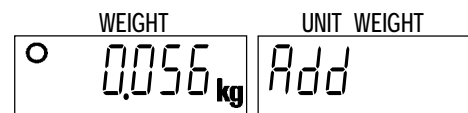
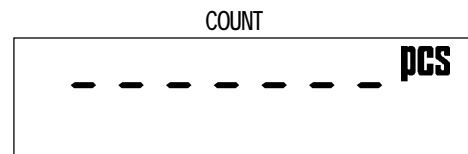
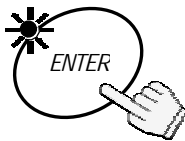

- At this point the scale may decide that 10 pieces is not a large enough sample size for accurate counting. If you see the "Add ##" on the unit weight display, then add the additional number of sample pieces displayed.

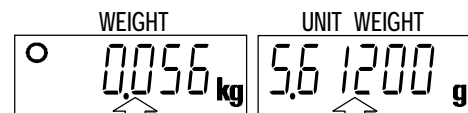
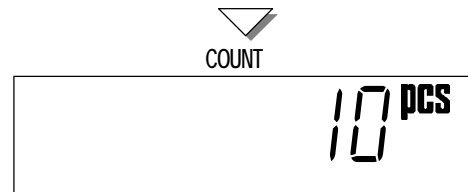

**Total Weight**  
The weight of all the sample pieces

**Unit Weight**  
The calculated weight of a unit.

- You can ignore the "Add ##" message and continue counting by pressing the **ENTER** key. However, the results may not be accurate. See F-Function F-0 1-02.

5. You may now begin counting operations for pieces of the same weight.

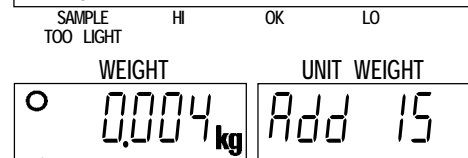
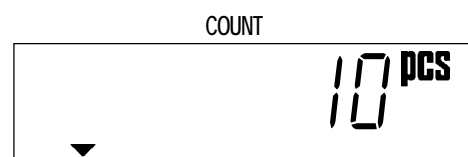

Another 30 pieces

- See "10. ACAI FUNCTION" for information concerning the ACAI counting accuracy function.

## 5, 25, 50 or 100 Sample Size

- The three **UNIT WEIGHT BY** LED's should be blinking at this point, if not, press the **RESET** key to clear any unit weight. If you are going to use a tare container, place it on the weighing pan.

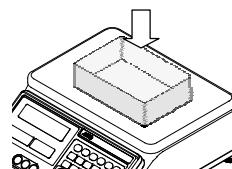

- Press the **SAMPLE** key. Any tare container will be automatically tared. The display will show "Add" "10 pcs".

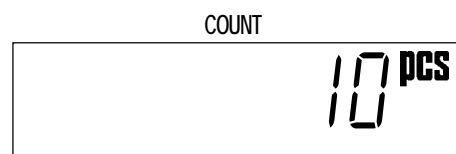
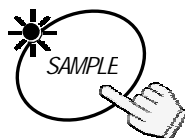

If weight isn't zero, press **TARE**.

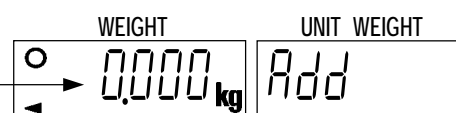

- Press the **SAMPLE** key to go through the count size: of 5, 25, 50 or 100 pieces.

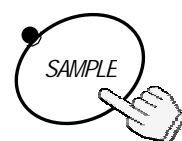

→ 10 → 5 → 25 → 50 → 100

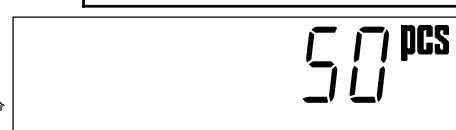

- The larger the sample size, the more accurate the unit weight registered. (Example of selecting a sample size of 50)

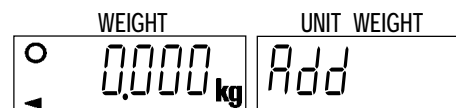

- Place the selected number of sample pieces on the weighing pan (or in the tare container). The weight of the pieces will be displayed.

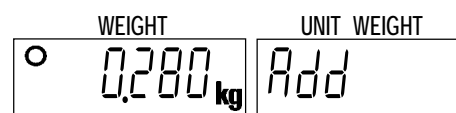
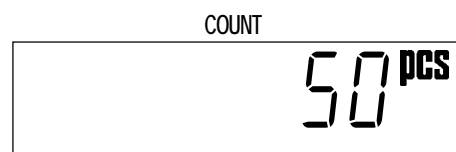
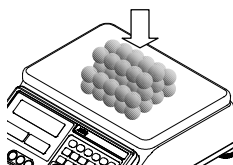

- Press the **ENTER** key. The display will show "-----" for a moment while calculating the unit weight. After a moment the display will show the count, total weight and unit weight.

≧Blinking≦

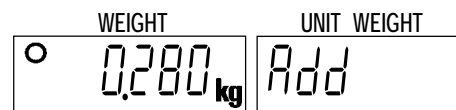
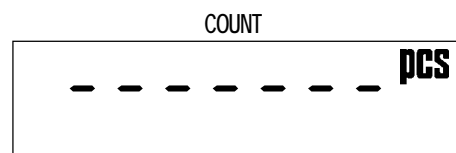
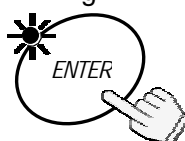

- If the "Add ###" appears on the unit weight display, then the sample size is not large enough for accurate counting – add the additional number of sample pieces.

▽  
COUNT

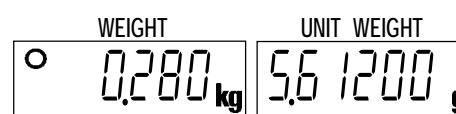
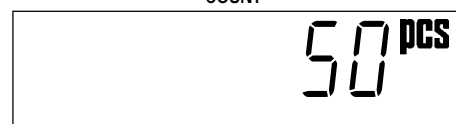

- You may now begin counting operations for pieces of the same weight.

## Desired Sample Size

- The three **UNIT WEIGHT BY** LED's should be blinking at this point, if not, press the **RESET** key to clear any unit weight. If you are going to use a tare container, place it on the weighing pan.

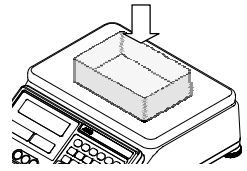

- Press the **SAMPLE** key. Any tare container will be automatically tared. The display will show "Add" "10 pcs".

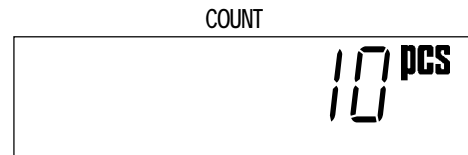
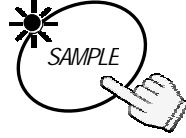

If weight isn't zero, press **TARE**.

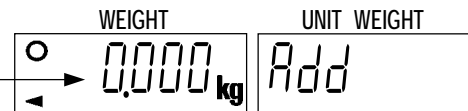

- Use the **0** → **9** 10-key pad to display the sample size desired.

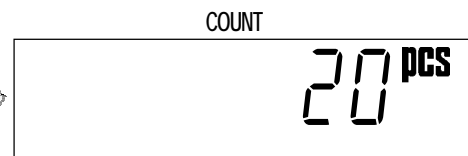

- If you hit the wrong key, press the **C** key to clear and start again. (Example of selecting a sample size of 20)

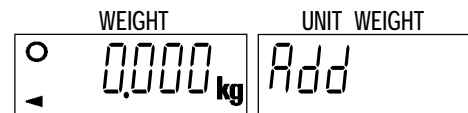

- Place the selected number of sample pieces on the weighing pan (or in the tare container). The weight of the pieces will be displayed.

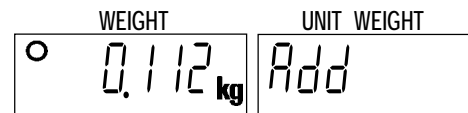
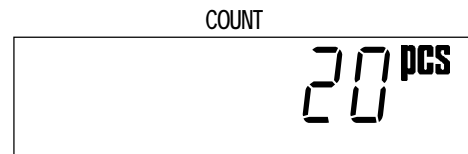
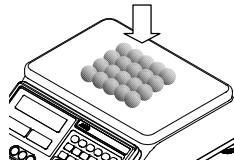

- Press the **ENTER** key. The display will show "-----" for a moment while calculating the unit weight. After a moment the display will show the count, total weight and unit weight.

≧Blinking≦

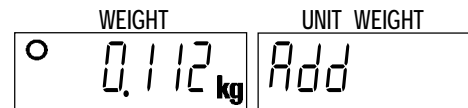
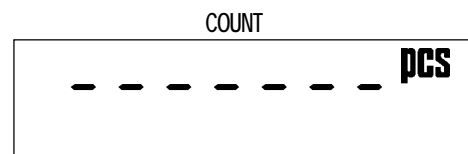
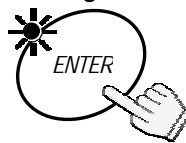

- If the "Add ##" appears on the unit weight display, then the sample size is not large enough for accurate counting – add the additional number of sample pieces.

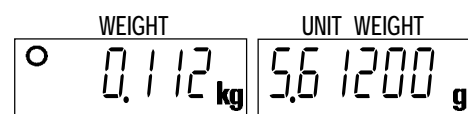
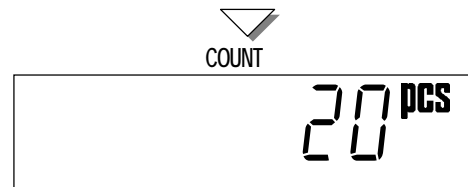

- You may now begin counting operations for pieces of the same weight.



## Desired Sample Size Not Using The **SAMPLE** Key

1. The three **UNIT WEIGHT BY** LED's should be blinking at this point, if not, press the **RESET** key to clear any unit weight. If you are going to use a tare container, place it on the weighing pan and press the **TARE** key. Be sure the weight display is "0".

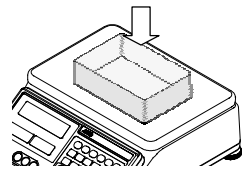

If weight isn't zero, press **TARE**.

2. Place sample pieces on the weighing pan (or in the tare container). The weight of the pieces will be displayed.

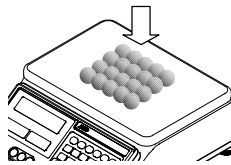

Diagram showing the display after placing sample pieces. The display shows COUNT: 0 pcs, WEIGHT: 0.112 kg, and UNIT WEIGHT: 0.000000 g.

3. Use the **0** → **9** 10-key pad to enter the sample size of the pieces you placed.



Diagram showing the display after entering the sample size. The display shows COUNT: 20 pcs, WEIGHT: 0.112 kg, and UNIT WEIGHT: Add.

- ❑ If you hit the wrong key, press the **C** key to clear and enter again. (Example of setting a sample size of 20)

4. Press the **ENTER** key. The display will show "-----" for a moment while calculating the unit weight. After a moment the display will show the count, total weight and unit weight.

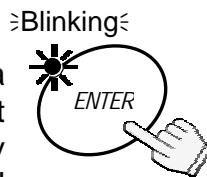

Diagram showing the display after pressing the ENTER key. The display shows COUNT: ----- pcs, WEIGHT: 0.112 kg, and UNIT WEIGHT: Add.

- ❑ If the "Add ##" display appears on the unit weight display, then the sample size is not large enough for accurate counting – add the additional number of sample pieces.

Diagram showing the display after adding more sample pieces. The display shows COUNT: 20 pcs, WEIGHT: 0.112 kg, and UNIT WEIGHT: 5.61200 g.

5. You may now begin counting operations for pieces of the same weight.

### 3-4. Unit Weight By KEYBOARD

1. The three **UNIT WEIGHT BY** LED's should be blinking at this point, if not, press the **RESET** key to clear any unit weight. If you are going to use a tare container, place it on the weighing pan and press the **TARE** key. Be sure to set the weight display is "0".

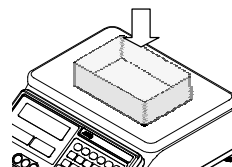

2. Press the **KEYBOARD** key. The unit weight display and the **ENTER** key LED will blink.

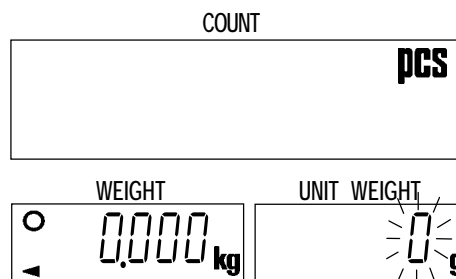
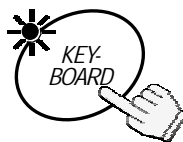

3. Use the **0** → **9** and **.** 10-key pad to display the unit weight.

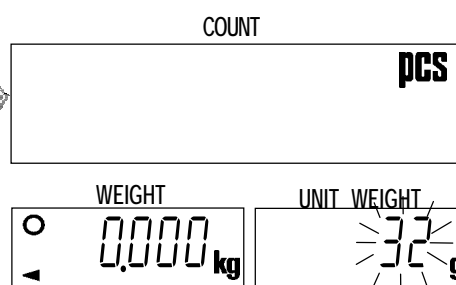
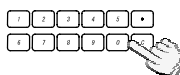

- ❑ If you hit the wrong key, press the **C** key to clear and start again. (Example of a unit weight 32g)

4. Press the **ENTER** key. The unit weight 32g will have been entered.

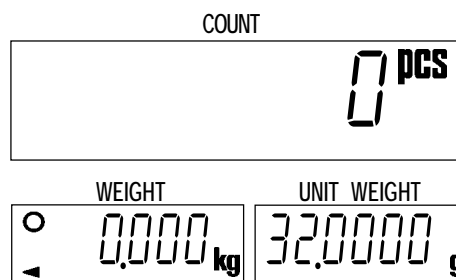
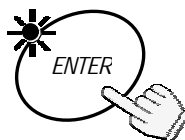

- ❑ If the unit weight entered is too light, "Lo ut" (low unit weight) will be displayed, and you will be returned to step 3.

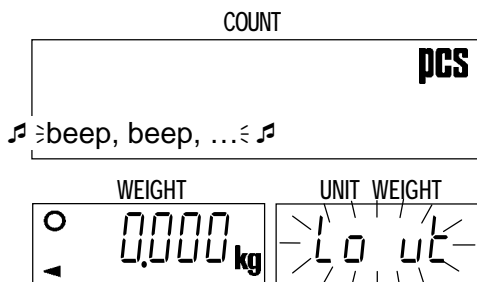

5. You may now begin counting operations for pieces of the same weight.

### 3-5. Unit Weight By ID Number

1. If there are no unit weights stored in memory, see “5-1. Store unit weight by ID Numbers”.

The three **UNIT WEIGHT BY** LED's should be blinking at this point, if not, press the **RESET** key to clear any unit weight.

2. Press the **ID** key.

'*id-00*' will be displayed with  $\approx 00 \approx$  blinking.

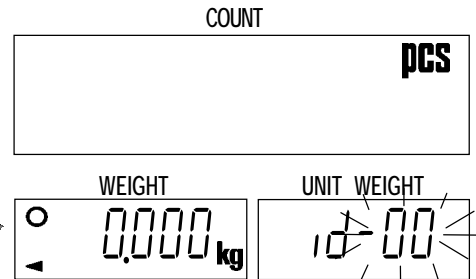
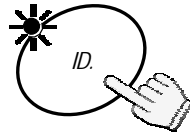

3. Use the **0** → **9** 10-key pad to display the ID number.



- ❑ If you hit the wrong key, press the **C** key to clear and start again. (Example of ID number '12')

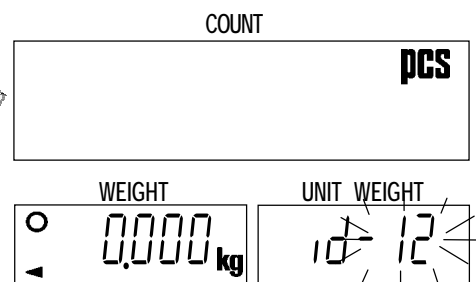

4. Press the **ENTER** key.

The count display will show '0' and the scale will recall '12g' previously entered as the unit weight of ID 12.

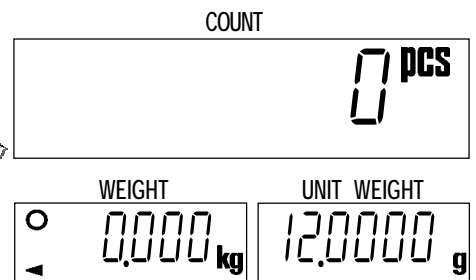
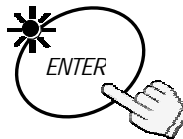

- ❑ If there is no unit weight entered for the ID number you tried to recall, "no id" will be displayed, and you will be returned to step 3.

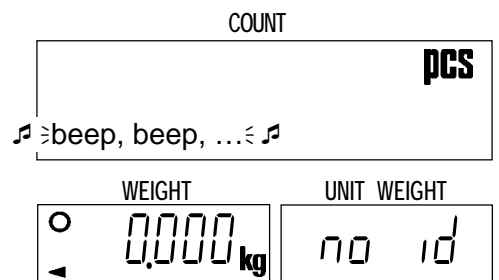

5. You may now begin counting operations for pieces of the same weight.



- ❑ "*id-00*" is a special memory area. It always holds the last unit weight entered.
- ❑ When you register a unit weight, it is automatically placed in the ID "*id-00*".
- ❑ If you clear the unit weight by pressing the **RESET** key, it can be recalled by recalling the ID "*id-00*".

# 4. ENTERING A TARE WEIGHT

There are two methods of tare operations.

- Using the **TARE** key to subtract the displayed container weight directly. Please see “3-1. Basic Operations”.
- Using the **KEYBOARD TARE** key to enter a tare weight via the 10-key pad.

## 4-1. Using the KEYBOARD TARE Key

1. Remove everything from the weighing pan and press the **ZERO** key to zero the scale.

2. Press the **KEYBOARD TARE** key. The weight display will blink (display is any tare weight previously entered).

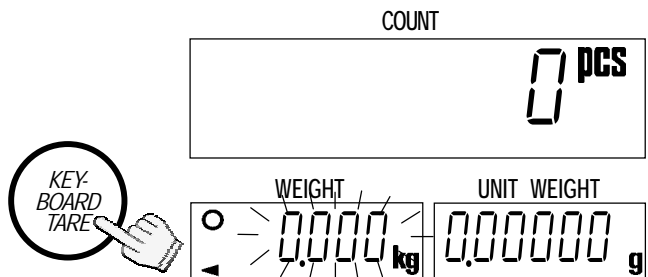

3. Use the **0** → **9** 10-key pad to display the desired tare weight.

If you hit the wrong key, press the **C** key to clear and start again. (Example of a tare weight 615g)



4. Press the **ENTER** key. The weight display changes to net weight.

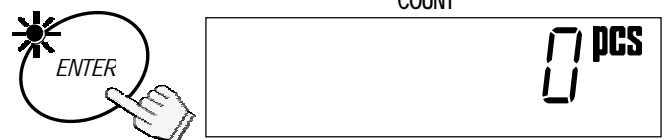

The TARE ENTERED indicator will light.

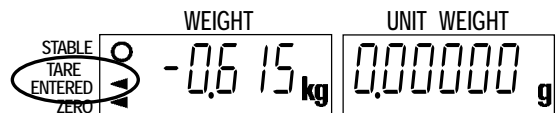

## 4-2. To Clear TARE

Either:

1. Have nothing on the weighing pan.

- If the ZERO indicator is not displayed, press the **ZERO** key to zero the scale.

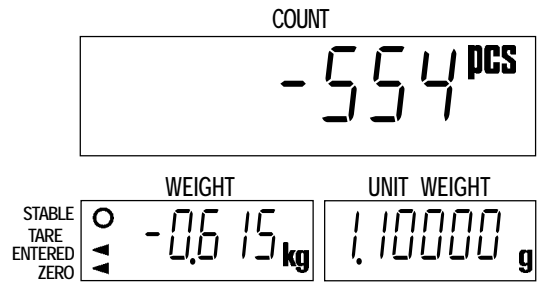

2. Press the **TARE** key.

The weight display will go to "0", and the TARE ENTERED indicator will be turned off (tare cleared).

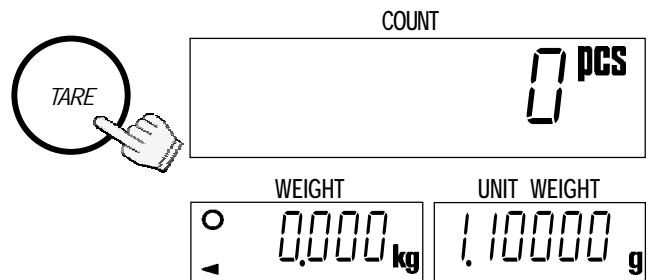

Or:

1. Press the **KEYBOARD TARE** key. The weight display will blink (display is any tare weight previously entered).

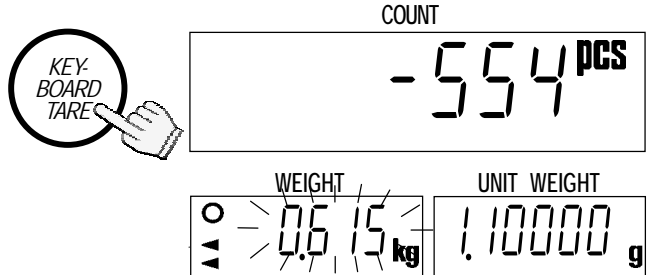

2. Press the **0** key and press the **ENTER** key.

Enter tare weight '0'.

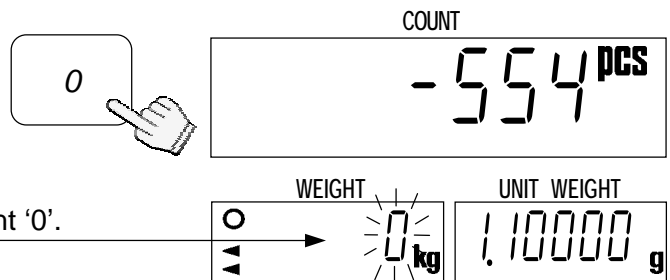

3. The tare weight is cleared and the TARE ENTERED indicator will be turned off.

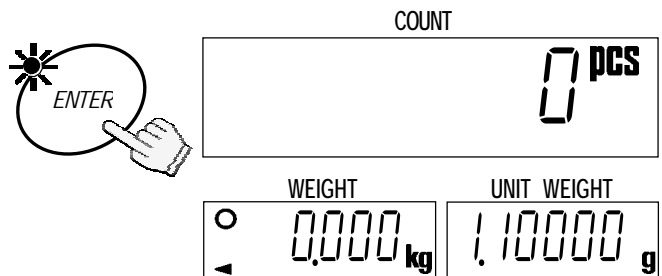

# 5. STORE UNIT WEIGHT

## 5-1. Store Unit Weight by ID Numbers

The scale can store up to 99 unit weights by 2 digit ID numbers, from 01 to 99. To recall, see “3-5. Unit Weight By ID. Number”.

- The scale is initially set to store ID numbers with a unit weight only. However, it can be set to store a TARE weight and comparator limits by setting F-Function  $F-01-05$ .

1. First register a unit weight by any method – using a sample or via the 10-key pad – and have it displayed.

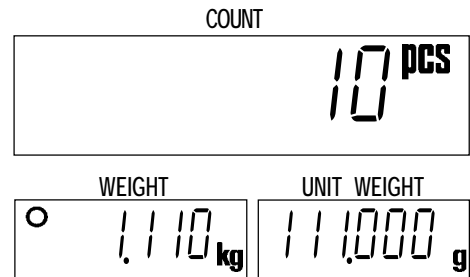

2. Press the **STORE UNIT WEIGHT** key. “id-00” will appear with  $\geq 00 \leq$  blinking.

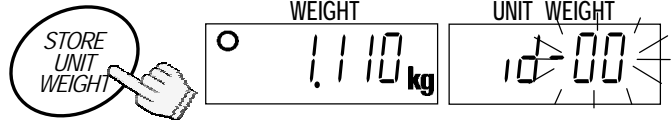

3. Use the **0** → **9** 10-key pad to display the new ID number. (Example of ID number “12”)

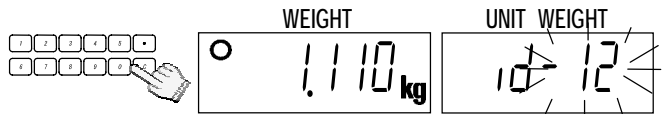

- If you hit the wrong key, press the **C** key to clear and start again.

4. Press the **ENTER** key. The ID number is stored and the display returns to normal.

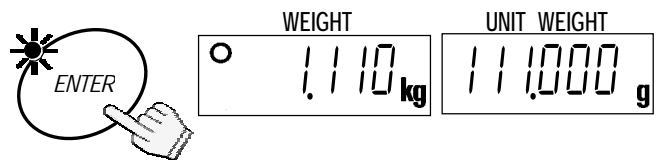

- If the same ID number was previously stored, the scale beeps twice and the ID number display stops blinking. You must then select one of two options: either (a) Overwrite the old ID unit weight, or (b) Select a different ID number:

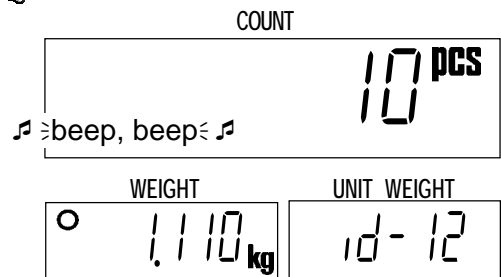

	<b>(a)</b> Press the <b>ENTER</b> key to overwrite the old ID number.	<b>OR</b>		<b>(b)</b> Press the <b>C</b> key to clear and go to step 3.
--	--	-----------	--	---

## 5-2. Clearing A Stored Unit Weight

1. Press and hold the **C** key, then press the **STORE UNIT WEIGHT** key – release both.

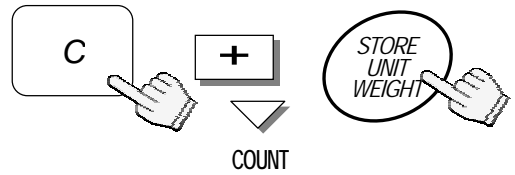

2. "CLEAR" will appear and "id-00" will appear with  $\Rightarrow 00 \Leftarrow$  blinking.

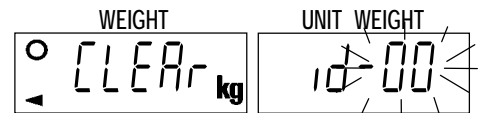

3. Use the **0** → **9** 10-key pad to display the ID number to clear. (Example of ID number "12")

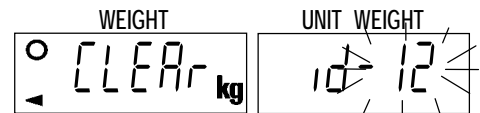
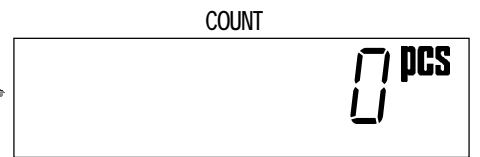
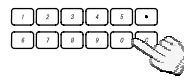

- ❑ If you hit the wrong key, press the **C** key to clear and start again.

4. Press the **ENTER** key. The ID memory specified at step 3 will be cleared and the display returns to normal.

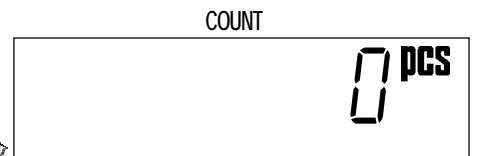
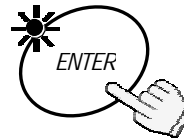

- ❑ If there is no such ID number to clear, the scale will beep. Return to step 2 to try again, or press the **RESET** key to exit.

## Clearing All ID Memories at Once

1. In the Step 2 above, press the **TOTAL** key. "idALL" will appear with  $\Rightarrow ALL \Leftarrow$  blinking.

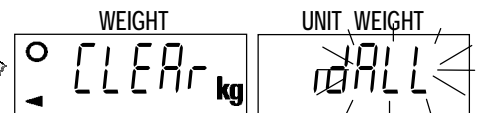
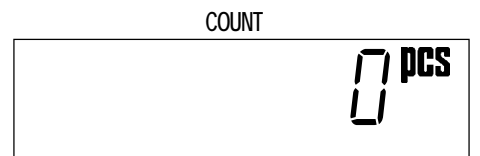
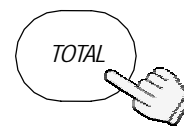

2. Press the **ENTER** key, then  $\Rightarrow ALL \Leftarrow$  blinking will stop.

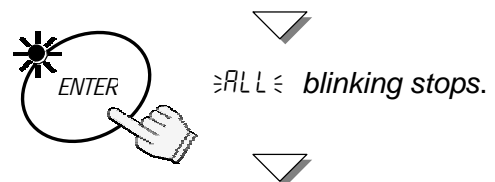

3. Press the **ENTER** key again to clear all ID memories. Press the **RESET** key to exit without clearing ID memories. The display will return to normal.

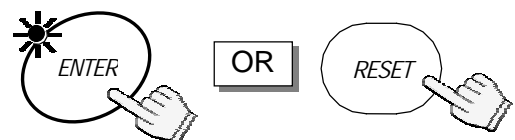

## 5-3. Unit Weight, Tare Weight & Comparator Limits Stored

The scale is initially set to store ID numbers with a unit weight only. However, it can be set to store a tare weight and/or comparator limits also by setting F-Function  $F-01-05$ .

1. First register a unit weight and a tare weight by any method. If necessary, set the comparator limits.

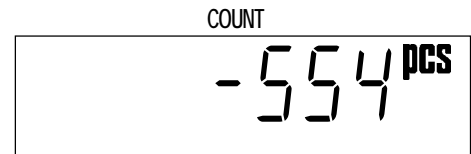

2. Go to step 2 of section "5-1. Store Unit Weight By ID Numbers".

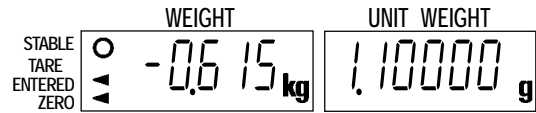

- When you recall a unit weight by the **ID** key, the tare and/or comparator limits are also recalled along with the unit weight.



" $id-00$ ", the special memory area, does not store a tare weight and comparator limits along with the unit weight.



# 6. USING THE M+ MEMORY

## 6-1. The M+ Memory Function

- ❑ The scale can accumulate count data by pressing the **M+** key, or automatically (see the next page). It also keeps track of the number of times you add to the total.
- ❑ When you view the total by pressing the **TOTAL** key, you view the number of pieces accumulated and the number of additions (how many times the total was added to). Please see “6-2.” and “6-3.” to view or clear the total count.

### Adding Using the M+ Key

- ❑ When stable count data is displayed:
  1. Press the **M+** key.  
The scale will beep and the **M+** indicator will blink for a few seconds.

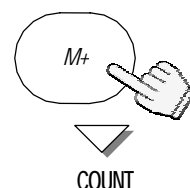

- ❑ **If the scale beeps 4 times, or the M+ indicator did not blink, then refer to the note below.**

- ❑ The **M+** indicator will stay ON while there is count in memory.

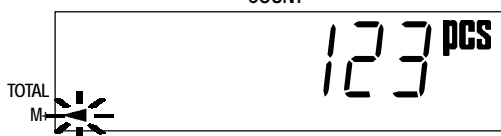

2. Press the **M+** key every time you want to add to the count. Remember that you may only add the count data once – the scale must return to near zero before it will let you add again.



- ❑ The **M+** key is accepted only once for each stable count data. Once accepted, the **M+** key is disabled until the display returns to less than +5d (1d = 1 weighing division).
- ❑ If *F-03-02* is set at “1”, then the **M+** key can accumulate both positive and negative data. Once the **M+** key is accepted, weight data must return within ±5d before the next accumulation.

### To Erase the Last M+ Addition

1. Press and hold the **C** key, then press the **M+** key – release.

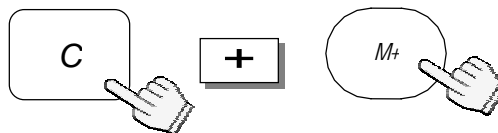

2. The scale will beep and clear the last **M+** addition.



- ❑ If the scale beeps 4 times, there is no **M+** addition to erase.

## Automatic M+ Accumulation Mode

- ❑ **M+** Accumulation can also be done automatically each time you count a different batch, As soon as you have a stable count, it will be added to the **M+** memory and the scale will beep. The weight display will have to return to near zero before another count can be added.
- ❑ Automatic **M+** accumulation is set by F-Function *F-03-01* to "1".
- ❑ **Only positive counts can be added.** If F-Function *F-03-02* is set to "1" (to accept negative count data), it will be ignored.
- ❑ **Once there is an automatic M+ accumulation, the display must return to less than +5d before another count can be accumulated.**

### 6-2. Viewing the M+ TOTAL

1. Press the **TOTAL** key.  
The count display will show the total count and the TOTAL annunciator will come ON.  
The number of additions to the **M+** memory is also shown.
2. Press the **TOTAL** key again.  
The display will return to normal.

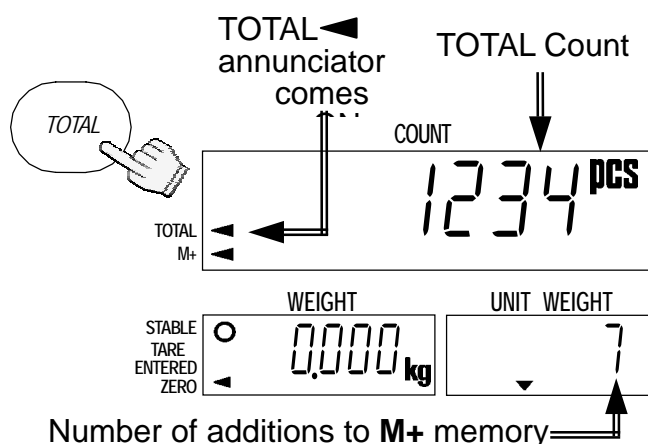

### 6-3. Clearing the M+ TOTAL

1. Press and hold the **C** key, then press the **TOTAL** key – release both.
2. The scale will clear the **M+** memory, and the TOTAL annunciator and the **M+** annunciator will go off.



**i**

- ❑ The **RESET** key does not clear the total data.
- ❑ The total data is held in memory, even if AC/Battery power to scale is interrupted.

### 6-4. The M- Function

- ❑ The scale can subtract count data from **M+** memory by using the **\*** key.
- ❑ Set the F-Function *F-09-01* to "1" to use the **\*** key as the **M-** key.
- ❑ This function is not to clear the last **M+** addition, but to subtract count data instead of addition. The number of additions is increased.
- ❑ **There is no automatic M- function.**

# 7. COMPARATOR FUNCTION

❑ The scale contains a comparator function that checks the amount on the weighing pan against set acceptable count or weight limits. When the comparator function is activated, “HI”, “OK” or “LO” indicator ▼ will be displayed.

❑ Before the comparator will work, Upper and Lower Limits must be set (see below). The limits are set by count or weight. So, if you are using weight for your comparator levels, calculate the weight before starting the procedure below.

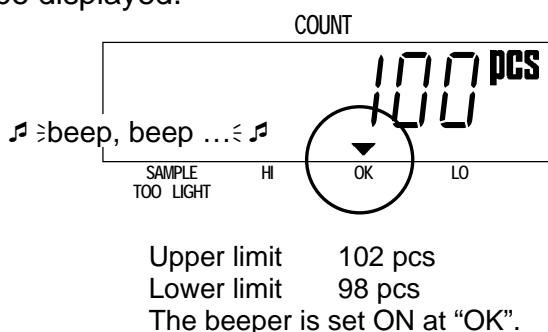

❑ If the OP-04 is installed, comparator relay output is also available.

❑ The comparator responds as follows,

“HI” Upper Limits < Count / Weight Data  
“OK” Lower Limits ≤ Count / Weight Data ≤ Upper Limits  
“LO” Count / Weight Data < Lower Limits

## To Set the Comparator

❑ Start with the scale switched off.

1. Press and hold the **ZERO** key, then press the **ON/OFF** key – release both.

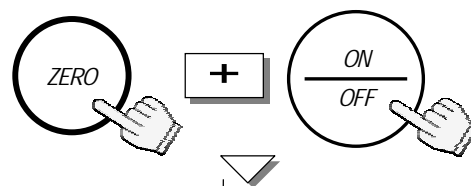

The count display will show “F-00” with “00” blinking.



2. Press the **5** key to enter into the F-Function *F-05-X Comparator* section.

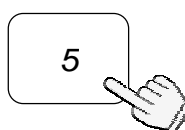

3. Press the **ENTER** key.  
The count display will show the F-Function and its present setting will blink.

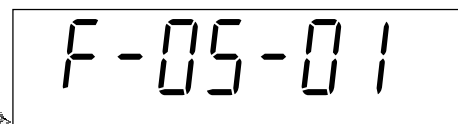
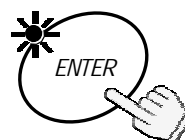

4. Use the **0** → **6** keys to display the number of the desired setting.

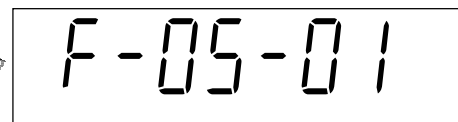
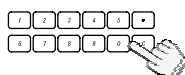

For example, let's select “1” compare all data.

5. Press the **ENTER** key to save the setting and move to next F-Function, *F-05-02*.

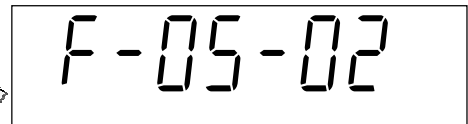
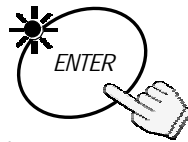

6. Continue to enter *F-05* comparator settings – refer to “9-2. F-Functions” for a listing. If there are no changes to a F-Function, press the **ENTER** key to move to the next.

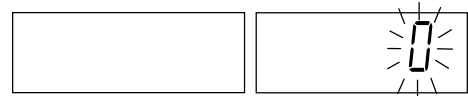

7. When finished: press the **ON/OFF** key to exit. Then, press it to turn the display back ON. Comparator functions and limits will now operate as set.

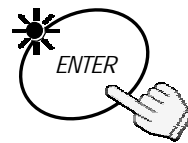

To ENTER or MOVE to next

### Viewing Comparator Limits

- ❑ The comparator limits you are using will be shown by pressing the **\*** key.
- ❑ Set *F-09-01="0"* to use this mode.

1. Press the **\*** key, then the upper limit will be shown.
2. Press the **\*** key again, then the lower limit will be shown.
3. Press the **\*** key. The display will return to normal.

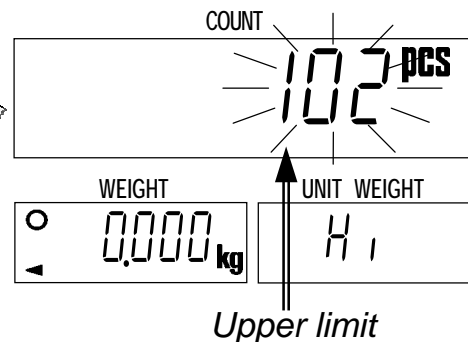
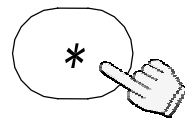

### Changing Comparator Limits Instead of Setting the F-Function

- ❑ Set *F-09-01="0"* to use this mode.

1. To change the upper limit, use the **0** → **9** 10-key pad to display a new limit in step 1 above, and press the **ENTER** key. Then the new limit is stored and the lower limit will be shown.

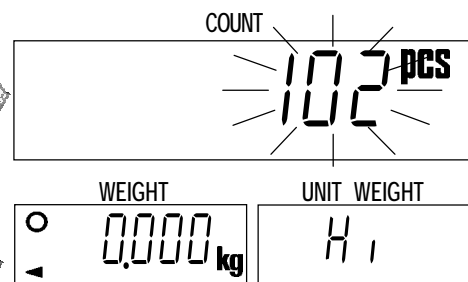
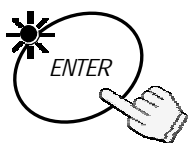
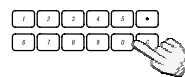

2. To change the lower limit, use the **0** → **9** 10-key pad to display a new limit, and press the **ENTER** key. Then the display will return to normal with the new limit.

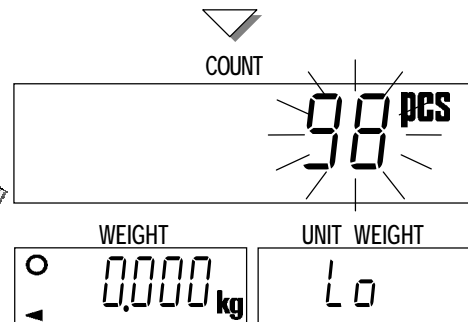
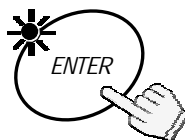

❑ Pressing the **\*** key to go to next step, the input data is not stored.

❑ These limits are held in memory even if power to the scale is switched off.

# 8. CALIBRATION

- ❑ Calibration of the scale is required when it is initially installed, if it is moved often, or it is moved a substantial distance. Calibration is also necessary in regular scale maintenance due to normal mechanical wear-and-tear, changes in seasonal temperature, humidity, air pressure, etc.
- ❑ The scale is equipped with gravity compensation, which allows it to be calibrated in one location and then adjusted to match the gravity acceleration at another location where it will be used. But don't worry about this, as far as you calibrate the scale using a calibration weight and use it at same place.
- ❑ The scale must perform "warm up" for at least 30 minutes before starting calibration.

## 8-1. Calibration Procedure Using a Weight

- ❑ The scale should be powered on at least one-half hour to warm it up before starting the calibration procedure.
1. Remove the calibration switch cover, and press the calibration (CAL) switch. The scale shows "CAL" in the count display.

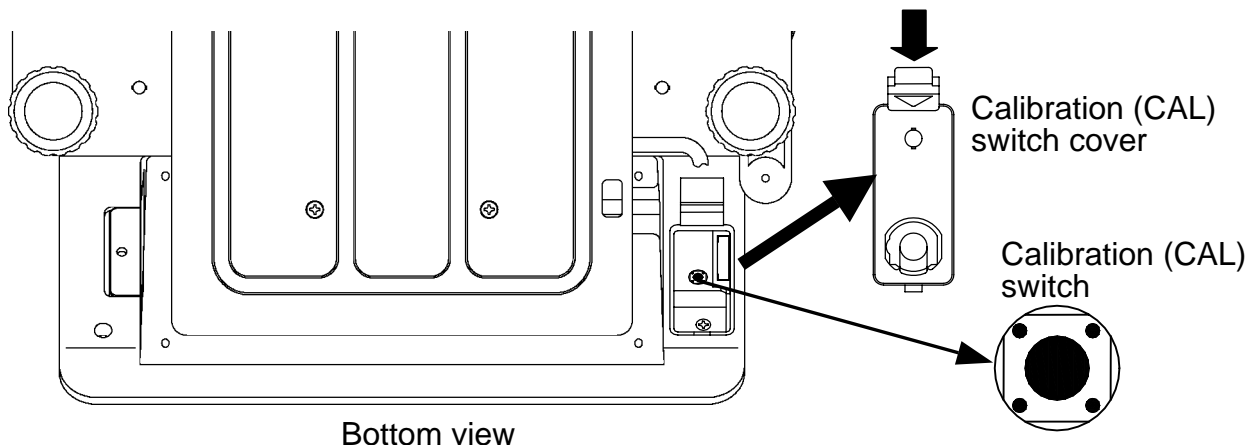

- ❑ Press the **ON/OFF** key to exit without calibrating the scale.
- ❑ Press and hold the **PRINT** key and press the **ON/OFF** key, then you can also enter calibration mode.

2. Press the **ZERO** key to enter into the zero & span calibration mode.

- ❑ The display flashes the required calibration weight value.

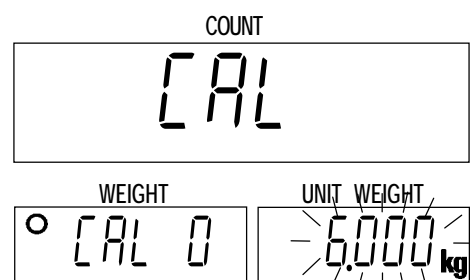
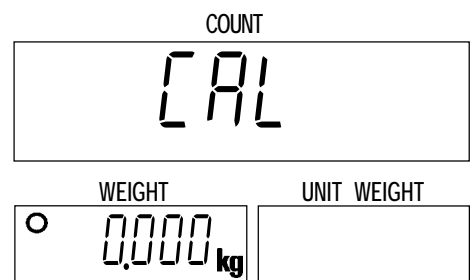

- If you know the exact weight value, or if you wish to use a different weight, use the **0** → **9** and **.** 10-key pad to display the desired calibration weight.



(For example: Using 5 kg calibration weight that actually weighs 5.001 kg. Do not forget to enter a decimal point in this case.)

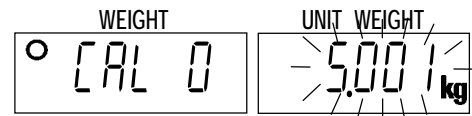

3. Press the **ENTER** key.  
The calibration weight stops blinking.

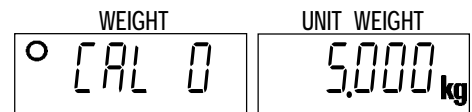
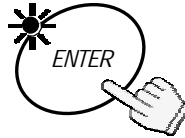

4. Making sure that there is nothing on, or touching the weighing pan, press the **ENTER** key.  
When zero calibration is completed, the display will show "CAL F".

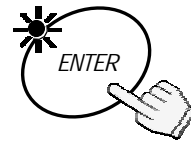

*Nothing on the weighing pan!*

- If you don't need span calibration, press the **ON/OFF** key to exit from the calibration procedure.

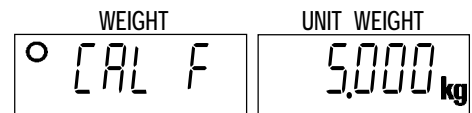
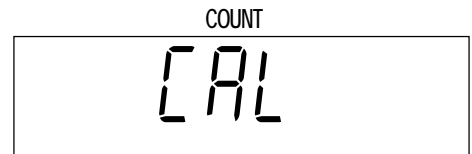

5. Place the calibration weight on the weighing pan and press the **ENTER** key.  
When span calibration is completed, the display returns to step 1 showing the weight value for the calibration weight.  
Remove the calibration weight.

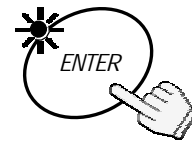

*Place Calibration weight.*

- If the calibration weight is not what it should be, an error will be displayed. Check if the weight is correct and try again.

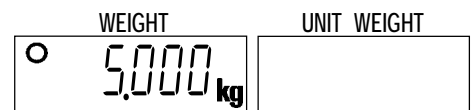

6. Press the **ON/OFF** key to turn the scale off and re-attach the calibration switch cover.  
(End of the calibration procedure.)



If the scale will be moved to another place, set the gravity acceleration value before calibration. The value must be of the area where the calibration is to be done.

## 8-2. Gravity Compensation

When the scale is first used or has been moved to different place, it should be calibrated using a calibration weight.

But if the calibration weight cannot be prepared, the gravity acceleration correction will compensate the scale. Change the gravity acceleration value of the scale to the value of the area where it will be used. Refer to the gravity acceleration map appended to the end of this manual.

1. In the Step 1 above, press the **TARE** key  
The display flashes the gravity acceleration value stored in the scale.

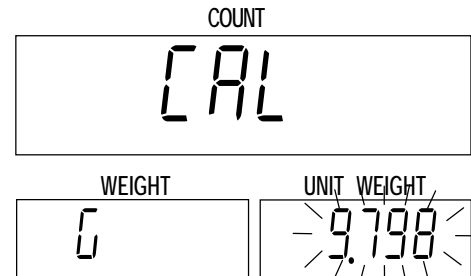

2. Use the **0** → **9** 10-key pad to display the desired gravity acceleration value.  
(Example of the value 9.800 m/s<sup>2</sup>.)

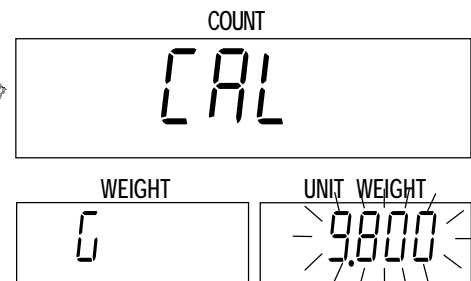
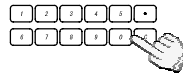

3. Press the **ENTER** key.  
The scale will store the new value.  
If necessary to calibrate the scale using a weight, go to Step 2 of the previous section.

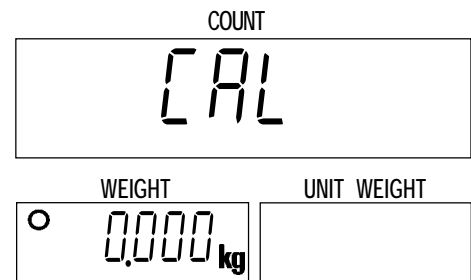
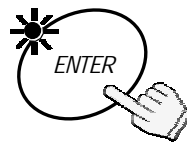

4. Press the **ON/OFF** key to turn the scale off and re-attach the calibration switch cover. (End of the calibration procedure.)

# 9. F-FUNCTION PARAMETERS

## 9-1. To Change or View F-Function Settings

☐ Start with the scale switched off.

1. Press and hold the **ZERO** key, then press the **ON/OFF** key.

The count display will show "F-00" with "00" blinking. Then release both keys.

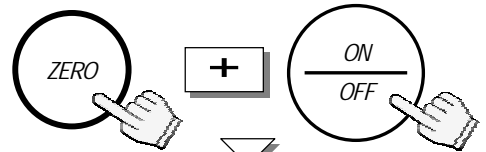

2. Press the **0** → **9** keys to display the number of the F-Function section.

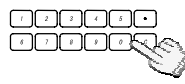

☐ For example: the **5** key to enter into the F-Function **F-05-X Comparator** section.

3. Press the **ENTER** key.  
The count display will show the F-Function and its present setting will blink.

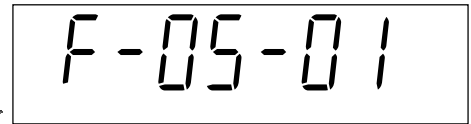
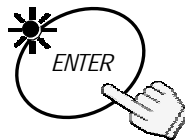

4. You may now either change the setting (Step 5) or move to the next F-Function (Step 6).

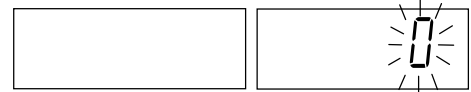

5. Use the **0** → **9** keys to change the setting.

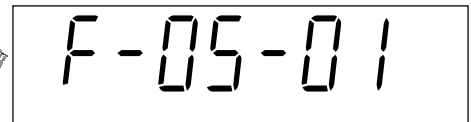
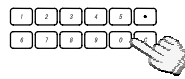

☐ The **C** key clears the input setting if you press the wrong key and want to re-enter.



☐ If you make a mistake and want to escape without saving any changes made after the last time the **ENTER** key was pressed – press the **ON/OFF** key to exit.

6. Press the **ENTER** key to save any changes and/or move to the next function.

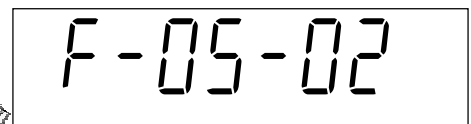
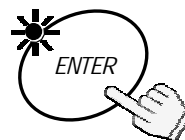

7. When finished: press the **ON/OFF** key to exit. Then, press it to turn the display back ON. New settings will operate as set.





## 9-2. F-Functions

□ “◀” designates Factory Settings.

### F-00-X Weight Unit USA Version ONLY

<b>F-00-01</b>	<input type="checkbox"/> <b>Weight Display when the scale is switched on.</b> See also setting “F-09-01=2”.	
	0	kg (kilograms).
	1◀	lb (pounds).

<b>F-00-02</b>	<input type="checkbox"/> <b>Unit Weight (when “lb” is selected).</b>	
	0◀	lb as piece weight.
	1	lb as 1,000 piece weight.

### F-01-X Operations

<b>F-01-01</b>	<input type="checkbox"/> <b>Operation Mode.</b>	
	0◀	Normal Operation. All features and keys available.
	1	Simplified Operation. The unit weight registration is by sample only. All other keys are disabled.

<b>F-01-02</b>	<input type="checkbox"/> <b>“Add” Sample Request Override.</b> If the sample weight is too light and the scale asks to “Add” more sample pieces, using this F-Function, the unit weight can be entered without adding the requested sample pieces. Or disable the “Add” Sample Request function.	
	0	“Add” sample request function is disabled. Light unit weight can be accepted without “Add” more sample request.
	1◀	The unit weight <u>can be entered</u> without requested “Add” sample pieces (via the <span style="border: 1px solid black; padding: 2px;">ENTER</span> key).
	2	The unit weight <u>cannot be entered</u> without requested “Add” sample pieces (via the <span style="border: 1px solid black; padding: 2px;">ENTER</span> key).

□ “F-01-03” is for factory use and should be “0”.

<b>F-01-04</b>	<input type="checkbox"/> <b>Display ON Unit Weight – Reset or Last.</b> When the scale is switched on, the scale can be set to recall the last unit weight used.	
	0◀	The unit weight is RESET (cleared) when display comes on.
	1	The unit weight last used will be entered automatically.

F-01-05

<input type="checkbox"/> <b>ID Memory contents.</b> The scale ID memory can contain unit weights with tare weights and comparator limits, or just unit weights alone.	
00 ◀	ID memory contains the unit weight only.
<p>Tare Weight ↓ 00 ↑ Comparator limits</p>	<p>You select which data to be stored by keying in a <input type="checkbox"/> 0 or <input type="checkbox"/> 1 for the data: tare weight or comparator limits. <i>Example:</i> Key in <input type="checkbox"/> 1 <input type="checkbox"/> 0 to display 10, ID memory contains the unit weight and comparator limits.</p>

### F-02-X ACAI Operation & Min. Unit Weight

F-02-01

<input type="checkbox"/> <b>ACAI Mode When Unit Weight entered by <i>Sample Pieces</i>.</b>	
0	ACAI is disabled.
1 ◀	ACAI automatic Operation.
2	ACAI Manual Mode (using the <input type="checkbox"/> ENTER key).

F-02-02

<input type="checkbox"/> <b>ACAI Mode When Unit Weight entered by <i>Keyboard or ID</i>.</b>	
0	ACAI is disabled.
1 ◀	ACAI Manual Mode (using the <input type="checkbox"/> ENTER key). This setting works when F-02-01 setting is not "0".
2	ACAI Automatic obeys F-02-01 setting.

F-02-03

<input type="checkbox"/> <b>Minimum Unit Weight.</b> (1d=1 weighing display division) The factory setting may be different for some countries.	
0	1/5 d
1 ◀	1/100 d

## F-03-X M+ Accumulation Function

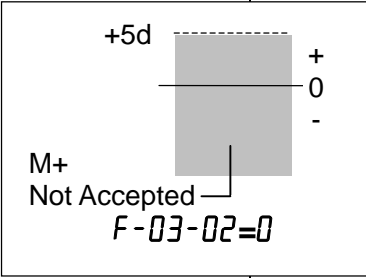
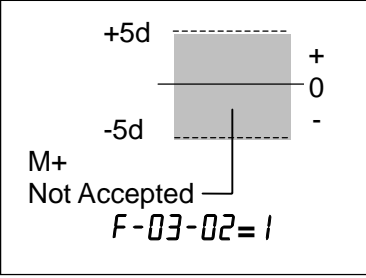
<b>F-03-01</b>	<input type="checkbox"/> <b>M+ Accumulation – Automatic or manual</b>	
	0	Manual accumulation (by pressing the <b>M+</b> key).
	1	Automatic accumulation (Positive data only).
<b>F-03-02</b>	<input type="checkbox"/> <b>+ or – Count Data Acceptable. (Manual Accumulation)</b>	
	0	Positive data only (5d and above).
	1	Positive and negative data (5d and above or –5d or below).
		

## F-04-X Environment and Beeper

<b>F-04-01</b>	<input type="checkbox"/> <b>Zero Tracking.</b>	
	Zero tracking traces a drift from zero caused by temperature change etc., and stabilizes the zero point.	
	0	Zero tracking ON.
	1	Zero tracking OFF.
<b>F-04-02</b>	<input type="checkbox"/> <b>Response</b>	
	0	Fast / sensitive
	1	Normal
	2	Slow / stable
	3	Slower / stabler
<b>F-04-03</b>	<input type="checkbox"/> <b>Stable Detection Speed / Environment</b>	
	0	Fast stable detection (good environment).
	1	Normal.
	2	Slow stable detection (poor environment).
<b>F-04-04</b>	<input type="checkbox"/> <b>Beeper for key operation</b>	
	0	Beeper ON.
	1	Beeper OFF.

F-04-05

<input type="checkbox"/> <b>Auto power-off</b>	
0	Auto power-off disabled.
1	Auto power-off enabled.

"F-04-06" is for factory use and should be "0".

### F-05-X Comparator

F-05-01

<input type="checkbox"/> <b>Comparator Mode.</b>	
0	Comparator OFF.
1	Compare all data.
2	Compare stable data.
3	Compare all data except when near ZERO*.
4	Compare stable data except when near ZERO*.
5	Compare all positive data except when near ZERO*
6	Compare stable positive data except when near ZERO*.
* "near ZERO" means between -4d and +4d of weight data.	

F-05-02

<input type="checkbox"/> <b>Data to Compare – Count or Weight</b>	
0	Compare count data.
1	Compare weight data.



F-05-03

<input type="checkbox"/> <b>Upper Limit.</b>	
0	Enter via the 10-key pad. Use the <input type="checkbox"/> key to "set minus value."

F-05-04

<input type="checkbox"/> <b>Lower Limit.</b>	
0	Enter via the 10-key pad. Use the <input type="checkbox"/> key to set minus value.

F-05-05

<input type="checkbox"/> <b>A Beeper With Comparator Results.</b>	
These are beeps for the comparator, not for the key operation.	
000	All Comparator Beepers are OFF.
	<b>Example:</b>  The OK beep sounds – HI & LO doesn't sound. The scale will beep continuously when the display meets the OK condition.
0 = Beeper OFF 1 = Beeper ON	

## F-06-X RS-232C Data Output

F-06-X requires OP-03 or OP-04 RS-232C interface.

F-06-01

□ Data Out Mode	
0	Key Mode: Data is sent by pressing the <b>PRINT</b> key. + Command Mode.
1	Stream Mode: Data is sent continuously. Command Mode cannot be used.
2	Auto-Print Mode A: Data is sent if the weight display is stable at +5d (weighing display division) and above. + Command Mode.
3	Auto-Print Mode B: Data is sent if the weight display is stable, at $\pm 5d$ (weighing display division) and above/below. + Command Mode
4	Command Mode Only.
5	This setting cannot be used.
6	UFC format with Key Mode (see setting "0").
7	UFC format with Auto-Print Mode A (see setting "2").
8	UFC format with Auto-Print Mode B (see setting "3").

F-06-02

□ Data to be Sent.	
0 100	Count data sent.
	<p>You select which data to be sent by keying in a <b>0</b> or <b>1</b> for the data: ID no., PCS (count), weight or unit weight.</p> <p><i>Example:</i> Key in <b>1 1 0 0</b> to display <b>1 100</b>, this setting would send only the ID number and the count.</p>

F-06-03

□ Data Format	
When F-06-01="6", "7" or "8" is set, the data is UFC format.	
0	Format for AD-8121 MODE 1. Same as F-06-03="2" but the interval between continuous data is approximately 2 seconds.
1	Format for AD-8121 MODE 3. The interval between continuous data is approximately 2 seconds.
2	Format for general apparatuses, computers, etc. The data-update rate is approximately 10 times per second when used with the Stream Mode.

F-06-04

□ Baud Rate	
0	2400 bps.
1	4800 bps.
2	9600 bps.

F-06-05

□ Data Length and Parity	
0	7 bits, even parity.
1	7 bits, odd parity.
2	8 bits, non parity.

□ “F-07” and “F-08” are for factory use and should be “0”.

F-09-X \* key

F-09-01

F-09-01=2 is for USA version only.

□ Operation mode for the * key	
0	Operating as a key to display and/or change comparator upper and lower limits.
1	Operating as M- key to subtract Count data from M+ memory.
2	Operating as a key to toggle the weighing unit between “lb” and “g”.

F-09-02

□ Decimal Point and RS-232C Output	
0000	Decimal point: “.” Header for stable weight data: “ST” Acknowledgment of command: <ACK><C <sub>R</sub> ><L <sub>F</sub> >
	Select the decimal point “.” or “,” and output format for RS-232C. Set 0 or 1 for each bit. Decimal point: “0” = “.” “1” = “,” Header: “0” = “ST,+001.2346 kg” “1” = “WT,+001.2346 kg” Acknowledgment: “0” = “<ACK><C <sub>R</sub> ><L <sub>F</sub> >” “1” = “<ACK>”

□ “F-10”, “F-11” and “F-12” are for factory use and should be “0”.

# 10. ACAI FUNCTION

## 10-1. ACAI Automatic Counting Accuracy Improvement

The ACAI™ (Automatic Counting Accuracy Improvement) function recalculates the unit weight as more pieces are added to improve the count accuracy.

When the scale calculates the unit weight from sample pieces, the more sample pieces that are used, the higher the accuracy.

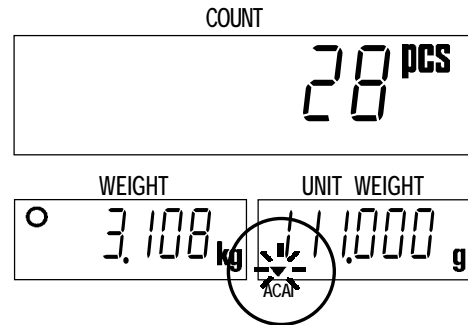

### ACAI Notes

- You must do the ACAI procedure just after you set the unit weight. The samples must still be on the weighing pan.
- Do not take the samples off until the end of the ACAI procedure.
- You don't have to count out the pieces when you add, just stay within the ACAI range.
- Continue the ACAI procedure to reach the largest amount that you will be counting.
- If you want the most precise counting results for every different batch of the same items, use ACAI every time you start counting the next batch.
- The ACAI function is initially set to manual operation when the unit weight is set digitally by the keyboard, by ID memory or using computer via the serial interface. This can be set to the automatic mode. The ACAI mode when the unit weight is entered by ID or digital input is controlled by F-Function *F-02-02*. It is initially set at "0", ACAI manual operation mode. Set to "1" for automatic operation mode.

## 10-2. ACAI Automatic Operation

1. To start ACAI automatic operation, unit weight must be registered and the sample still on the weighing pan.

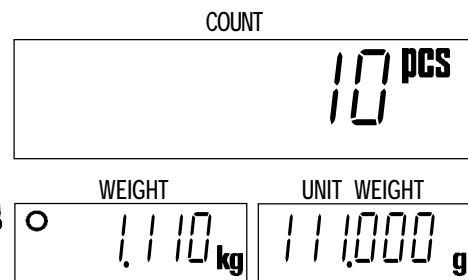
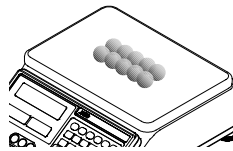

2. Add pieces within the nearest ACAI range (refer to table on the next page). A good rule of thumb is to roughly double the amount on the weighing pan.

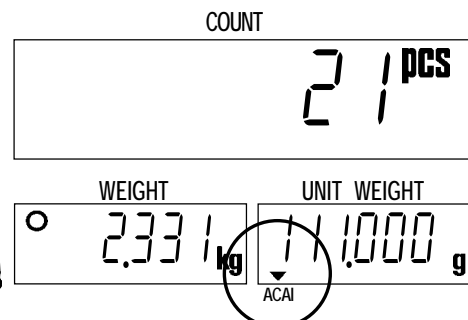
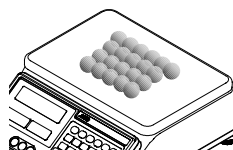

Pcs On the Weighing Pan	ACAI Addition Range		
10	13~26	60	63~122
20	23~49	70	73~138
30	33~70	80	83~152
40	43~89	90	93~166
50	53~106	100	103~299
		over 200	203~492

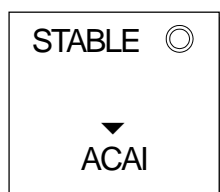

As you add, the ACAI annunciator will be ON as long as you are in range.

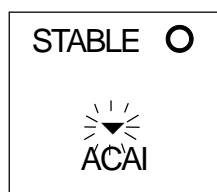

When you stop adding and the display becomes STABLE, the ACAI annunciator will blink.

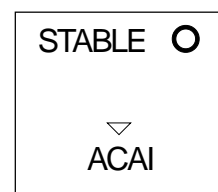

After the new unit weight is calculated, the annunciator will disappear.

3. Continue adding pieces within the ACAI range until you have reached a sample size as large as the largest number of pieces that you will be counting.

- ❑ When you have added the maximum number of pieces required, remove the sample pieces and start your counting job.

### 10-3. ACAI Manual Operation

- ❑ The ACAI procedure can also be controlled manually. The ACAI will not recalculate the unit weight until the **ENTER** key is pressed (as long as it is at the proper time and the guidelines in the ACAI Notes section have been followed).
- ❑ The ACAI manual mode is controlled by F-Function  $F-02-1$ , set at "2".
- ❑ To start ACAI manual operation, the unit weight must be registered and the samples still on the weighing pan.

1. Add pieces within the nearest ACAI range (refer to table in the previous section). The ACAI annunciator will stay ON as long as you are within ACAI range.

2. Wait until the display becomes stable and press the **ENTER** key. When the new unit weight is calculated, the indicator will blink for a moment and then turn off.

3. Continue adding pieces within the ACAI range until you have reached a sample size as large as the largest number of pieces that you will be counting.

- ❑ When you have added the maximum number of pieces required, remove the sample pieces and start your counting job.

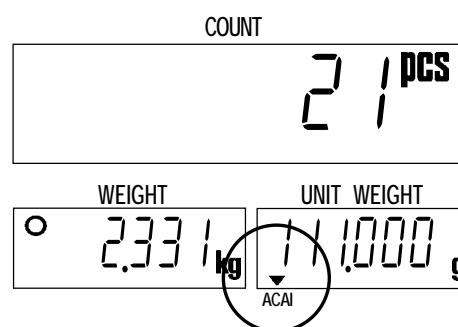



---

# 11. AWA FUNCTION

---

## 11-1. AWA Audible Weighing Assist

The AWA (Audible Weighing Assist) function will assist you to count a certain amount of pieces by listening to the buzzer sound. The buzzer sound changes its interval as the pieces getting close to, and stops at, the target count.

There are three modes of operation. These can be selected by the  key.



♪ Off mode: AWA function disabled.

♪ Target mode: To set the number of pieces that you will count.

♪ Interval mode: To set the number of pieces as an interval count. For example, when 20 pieces is set as an interval count, the target count will be 20, 40, 60, ... pieces.

- The buzzer starts to beep at the “target count – 9” pieces. As you add pieces and the count is getting close to the target, the buzzer changes its interval of beeps, shorter and shorter. Finally it stops at the target count.
- The buzzer will beep again for “target count + 1, 2, 3 or 4” pieces.
- The minimum number of pieces to set is 10.
- The number of pieces is set to less than 50 in the interval mode, the buzzer will start to beep at the “target count – 5” pieces.
- You cannot set a minus target or interval count. But the AWA function works for negative pieces, too.
- The AWA function should be disabled when the comparator buzzer is used.**

## 11-2. To Enable/Disable the AWA Function

Press the  key, then the display will show one of the three modes of operation to set. The display moves among these setting modes cyclically by pressing the  key to select one of them.

- Press the **RESET** key in the setting modes, the scale returns to normal without changing the AWA function setting and the unit weight you are using.

### Off Mode Setting

1. The count display shows “off” blinking.
2. When you do not use the AWA function, press the **ENTER** key. The display returns to normal with the AWA function deactivated. Or, move to the other mode setting by pressing the  key.

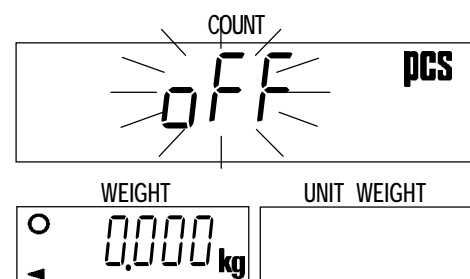

## Target Mode Setting

1. The count display shows the target count blinking.

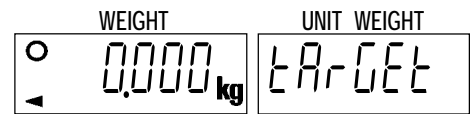
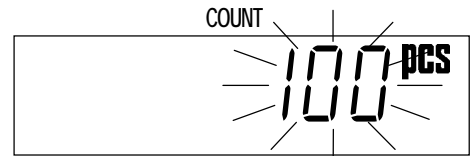

2. Use the **[0]** → **[9]** keys to set or change the count.

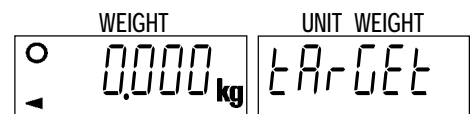
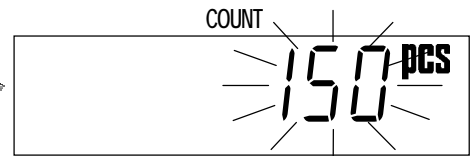
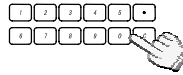

- The **[C]** key clears the input setting if you press the wrong key and want to re-enter.
3. Press the **[ENTER]** key. The display returns to normal and the target mode will be activated.

## Interval Mode Setting

1. The count display shows the interval count blinking.

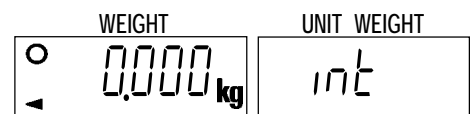
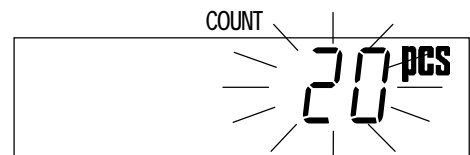

2. Use the **[0]** → **[9]** keys to set or change the count.

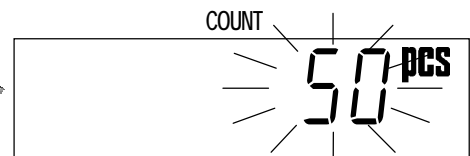
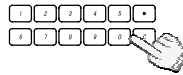

- The **[C]** key clears the input setting if you press the wrong key and want to re-enter.
3. Press the **[ENTER]** key. The display returns to normal and the interval mode will be activated.

---

# 12. OP-02 BATTERY

---

## Using the OP-02 SLA Battery

- ❑ The scale can be operated with an SLA (Sealed Lead Acid) battery that will be commercially available.
- ❑ The scale (with no other options) can be operated for around 80 hours with a fully charged battery.
- ❑ The battery will take about 15 hours to be fully charged.
- ❑ The battery life will vary depending on how the scale is used, the ambient temperature and so on.



- ❑ Use a Yuasa Battery NP4-6 (6V, 4Ah).
- ❑ Use only the AC adapter that is provided with the HC-*i* scale.
- ❑ There will be risk of explosion if the battery is connected improperly or replaced with the incorrect type.
- ❑ Dispose of a used battery according to the local laws and regulations.

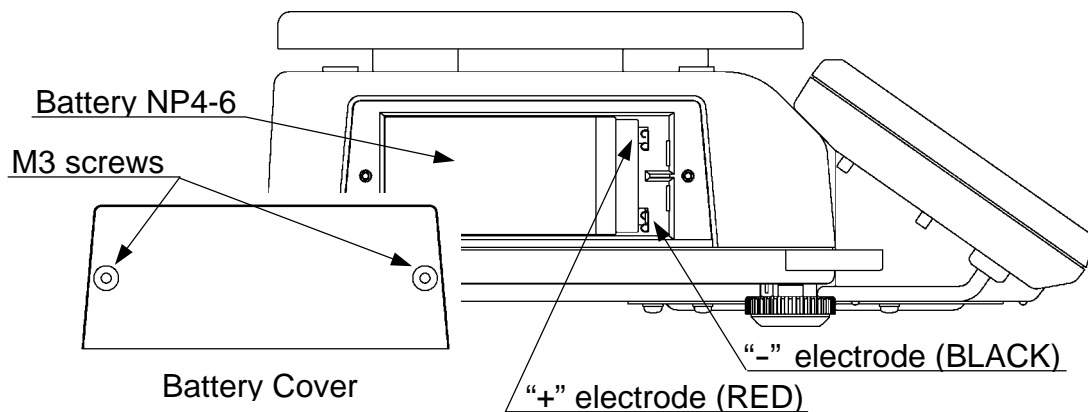

1. Disconnect the AC adapter from the scale.
  2. Loosen the two M3 screws and remove the battery cover.
  3. Connect the wires in the battery box to the battery.
- ⚠ Be sure to connect RED wire to positive (+ / RED) terminal and BLACK wire to negative (- / BLACK) terminal. Or there is a risk of explosion.**
4. Place the battery into the box and attach the battery cover using the screws removed in the step 2 above.
  5. Press the ON/OFF key and check that the scale works normally.

## Charging the Battery

- ❑ When the count display shows “Lo bAt”, the battery power is almost exhausted and should be recharged.

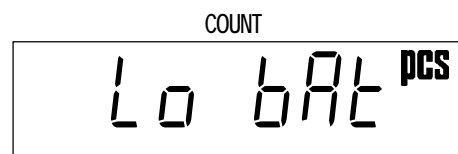

- ❑ While the scale is operating with the battery, the annunciator ▼ will light.

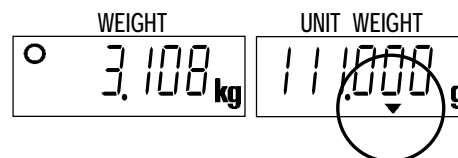

- ❑ The scale can be used while the battery is charging. After fully charged, the scale will change the charging process to trickle charge automatically.

❑ **Charge the battery at a temperature between 0°C (32°F) and 40°C (104°F). Preferably 5°C (41°F) ~ 35°C (95°F) is recommended.**

❑ **Charge the battery when using for the first time.**

❑ **The battery must be recharged regularly if the scale is not used for a long period of time. Every 3 months in a warmer area and every 6 months in a cooler area will be needed.**

⚠ **Be sure to use the AC adapter that provided with the HC-i.**

# 13. OP-03 RS-232C SERIAL INTERFACE

This interface allows the HC-*i* series to be connected with a multifunction printer or a personal computer.

- The OP-03 unit includes an interface board, a connector plug (DIN type) and two screws. (M3x6 tapping type).

## 13-1. Installation

1. Disconnect the AC adapter from the scale. If the battery is used, switch off the scale.
2. Loosen the screw and remove the panel covering the option slot.
3. Attach the OP-03 connector cable to the connector inside the option slot.
4. Fix the OP-03 unit using the two screws included with the option.

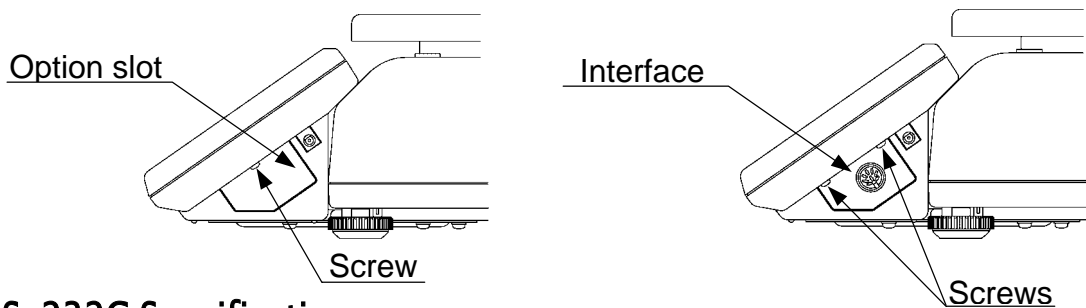

## 13-2. RS-232C Specifications

Transmission form	Asynchronous, bi-directional, half-duplex	
Data format	Baud rate: 2400, 4800, 9600 bps	
	Data: 7 bits + parity 1bit (even / odd) or 8 bits (non-parity)	
	Start bit: 1 bit	
	Stop bit: 1 bit	
	Code: ASCII	
	Terminator: Data Send / C <sub>R</sub> L <sub>F</sub>	Data Receive / C <sub>R</sub> or C <sub>R</sub> L <sub>F</sub>

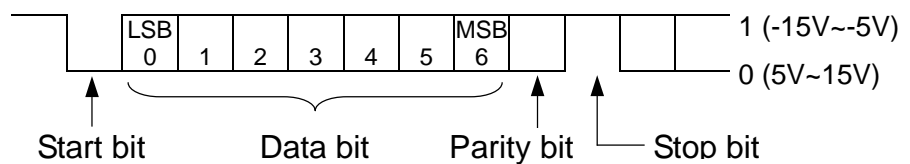

Pin connections

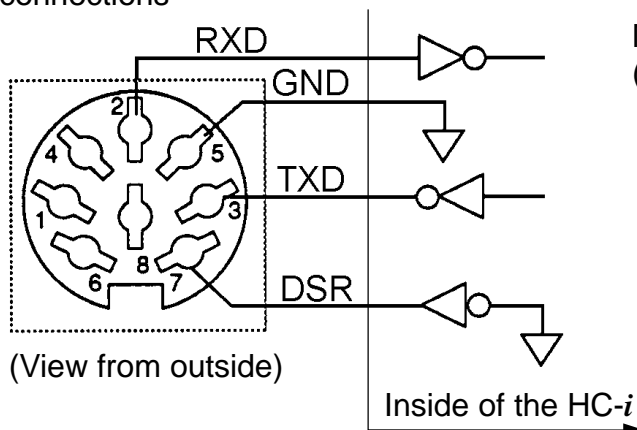

Mating connector: JA+TCP0586  
(Included in the OP-03)

- 2 Receive data
- 3 Transmit data
- 5 Signal ground
- 7 Data set ready
- 1, 4, 6 and 8 N.C.

- The HC-*i* is designated as DCE (Data Communication Equipment).

## 13-3. Data Output Mode

- ❑ The Data Output Modes and Parameters are set by F-Functions in F-06-X as described in the “9-2. F-Functions”
- ❑ To control the scale using commands from an external device, see “13-6. Command Mode”.
- ❑ Refer to “13-6. Command Mode” about the output data format.

### Data Output Mode (F-06-01)

- ❑ Key Mode (F-06-01="0")  
When the weight display is stable, data is sent by pressing the PRINT key. The count display will blink when the data has been sent.
- ❑ Stream Mode (F-06-01="1")  
Data is sent continuously. The data-update rate is approximately 10 times per second for F-06-03="2". For F-06-03="0" or "1", the interval between continuous data is approximately 2 seconds.
- ❑ Auto-print Mode A (F-06-01="2")  
Data is sent if the weight display is stable at +5d (weighing display division) and above. The next transmission can not occur until after the weight display falls below +5d.
- ❑ Auto-print Mode B (F-06-01="3")  
Data is sent if the weight display is stable at ±5d (weighing display division) and above/below. The next transmission can not occur until after the weight display falls between -5d and +5d.
- ❑ To use with the UFC format, refer to "13-7. Using UFC (Universal Flex Coms) Function"

### Data to be Sent (F-06-02)

Select which data is to be sent by keying in a 0 or 1 for the data: ID No., PCS (count), weight or unit weight.

*Example:* Key in 1 1 0 0 to display 1100, this setting would send only the ID number and the count.

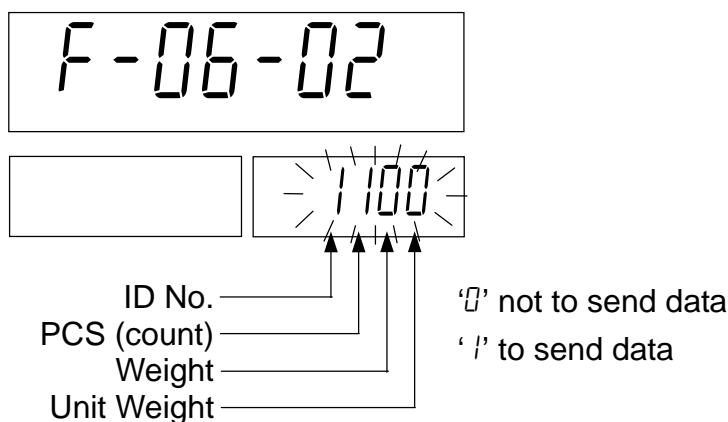

### Data Format (F-06-03)

- ❑ Format for AD-8121 MODE 1 or 2. (F-06-03="0")
- ❑ Format for AD-8121 MODE 3. (F-06-03="1")
- ❑ Format for general apparatuses, computers, etc. (F-06-03="2")

## Baud Rate (F-06-04)

Select the baud rate according to the device to be connected.

- 2400 bps (F-06-04="0") Select 2400 bps to connect with an AD-8121.
- 4800 bps (F-06-04="1")
- 9600 bps (F-06-04="2")

## 13-4. Connecting the AD-8121 Printer / MODE 1 or MODE 2

- When using the AD-8121 printer (MODE 1 or MODE 2), you will be able to print: Number of data items, total, maximum, minimum, mean value, range of data (max. - min. data) and standard deviation.
- When using the AD-8121 with MODE 2, set F-06-02 to print pcs (count) data only or weight data only.
- To print the date and time, use the AD-8121's calendar / clock function and set F-06-02 to print pcs (count) data only or weight data only.

## Print Operations Settings

Print By:	F-Function F-06-01	Printer MODE
HC <input type="button" value="PRINT"/> key	0	MODE 1
Auto Print	2 or 3	MODE 1
Printer <input type="button" value="DATA"/> key	1	MODE 2

## Example of F-06-02 settings

- To print pcs (count) data only: set F-06-02 to "0 100"
- To print weight data only: set F-06-02 to "00 10"
- To print pcs (count) and weight data: set F-06-02 to "0 1 10"
- To print pcs, weight and unit weight data: set F-06-02 to "0 1 1 1"
- To print total data (accumulated by the  key), press the  key so that the count display shows the total, then press the  key.
- If you are using the AD-8121's statistic functions, then set F-06-02 to "0 1#0" (# = 0 or 1) for pcs (count) data or "00 10" for weight data.
- MODE 1 and 2 of the AD-8121 can not print ID numbers.

### 13-5. Connecting the AD-8121 Printer / MODE 3

- ❑ When using MODE 3 of the AD-8121 printer, printouts are obtained using the **PRINT** key ( $F-06-01=0$ ), or auto-print mode A/B ( $F-06-01=2$  or  $3$ ).
- ❑ The total data (accumulated by the **M+** key) will be printed along with the number of additions to **M+** memory.
- ❑ The AD-8121 / MODE 3 does not have statistical functions.

#### AD-8121 Printout Sample

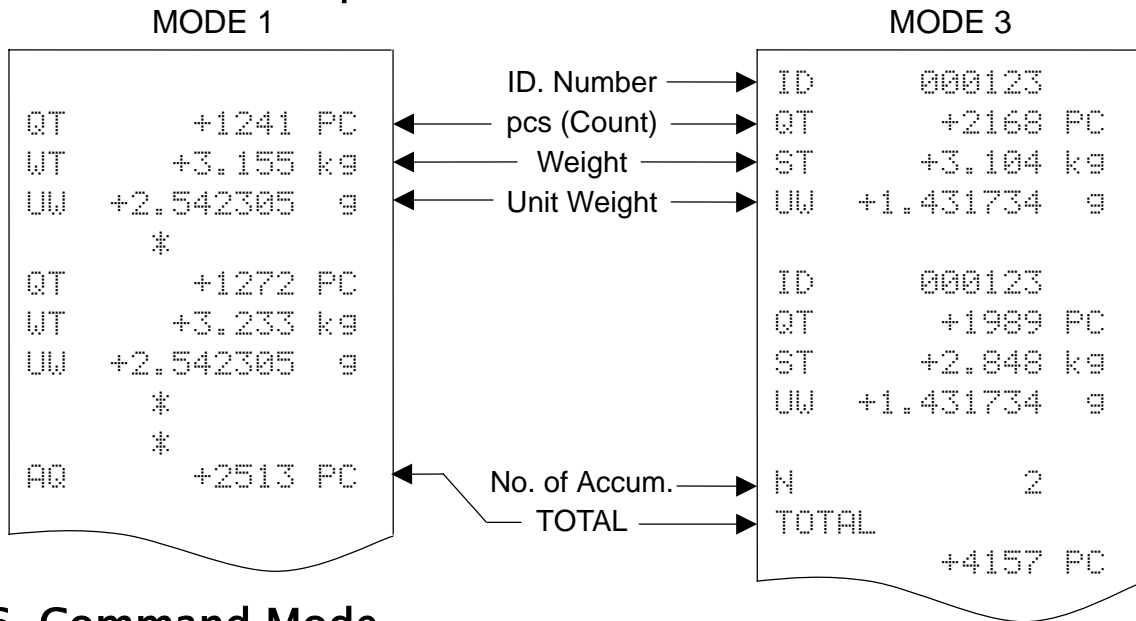

### 13-6. Command Mode

- ❑ In the command mode, the scale is controlled by commands that come from an external device, computer etc.
- ❑ Do not set  $F-06-01="1"$  (stream mode) to use with the command mode. if you don't want to use command mode together with key mode or auto-print mode, set  $F-06-01="4"$  (command mode only).
- ❑ Use an optional cable listed below to connect with a computer.

AX-KO577A-200 RS-232C cable, for D-sub 25 pin, length 2m  
 AX-KO1786-200 RS-232C cable, for D-sub 9 pin, length 2m  
 (These cables have a DIN 7pin connector, but it can connect with OP-03.)

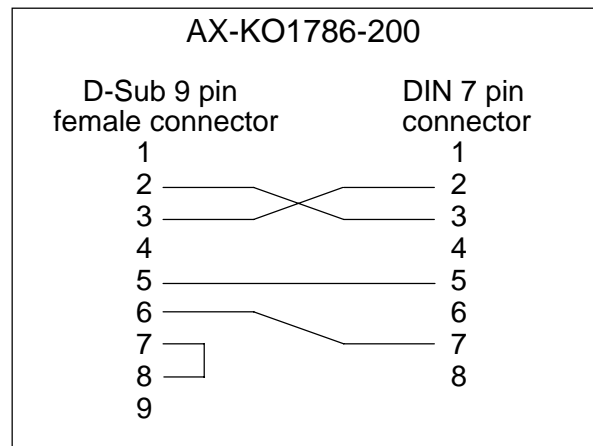
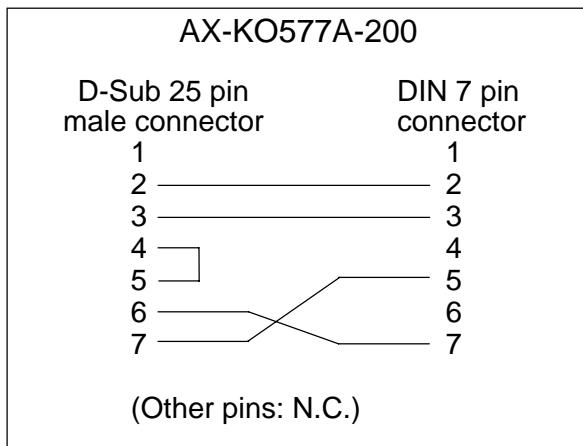



## Command List

Command	Definition	Notes
@	Start / stop continuous data transmission.	
A	Same as <b>RESET</b> key.	Key command
D	Set a known tare weight.	"D,1.23C <sub>R</sub> L <sub>F</sub> " sets the tare weight as "1.23kg".
E	Store the unit weight and other values in use to ID memory.	Refer to the data format. Refer <i>F-01-05</i>
F	Recall a unit weight from ID memory.	"F12C <sub>R</sub> L <sub>F</sub> " recalls from ID12.
G	Set a known unit weight.	"G,0.123C <sub>R</sub> L <sub>F</sub> " sets the unit weight as "0.123g" (or "0.123 lb").
J	Same as the <b>TOTAL</b> key.	Key command
K	Same as the <b>M+</b> key.	Key command
Q	Send data immediately.	Data depends on <i>F-06-02</i>
S	Send stable data after accepting command.	
T	Same as the <b>TARE</b> key.	Key command
X	Request a list of the F-Function parameters.	The last data terminates with <EOT> (04H)
Y	Request a list of the ID memory contents.	
Z	Same as the <b>ZERO</b> key.	Key command
ON	Start the scale from power on sequence	Refer to the data format for the reply.
?ID	Send the ID number in use.	
?QT	Send the pcs (count) data.	
?WT	Send the weight data.	
?UW	Send the unit weight in use.	
?AQ	Send the total (accumulated) <b>M+</b> memory count	
?AN	Send the number of additions to <b>M+</b> memory.	
?TR	Send the tare weight in use.	
?MR	Send the specified ID memory contents.	
MR	Store the unit weight and tare weight into the specified ID memory.	
ML	Store the comparator limits into the specified ID memory.	
CM	Clear the specified ID memory contents	"CM,1.2C <sub>R</sub> L <sub>F</sub> " clears content of <i>id 12</i> .
?FC	Send the specified F-Function setting.	Refer to the data format for the reply.
FC	Store the specified F-Function setting value.	

## Acknowledgment and Error Codes

When the scale receives an external command, it reacts as follows:

- If the command requests a data reply, the scale will send the data.

For other commands, the scale will send an acknowledgment <ACK><C<sub>R</sub>><L<sub>F</sub>> or <ACK> (see F-Function "*F-09-02*") upon acceptance of the command.

- ❑ If the command is **[S]**, **[T]** or **[Z]**, the scale will send a second acknowledgment <ACK><C<sub>R</sub>><L<sub>F</sub>> or <ACK> (see F-Function “F-09-02”) when the command operation is completed.

If an error occurs, the scale will send an error code.

- ❑ The error format is **[E][C], [E][n][C<sub>R</sub>][L<sub>F</sub>]**, “n” being error number.

En	Definition	Notes
E0	Communication Error	Parity error, framing error, etc.
E1	Undefined command Error	Command does not exist for the scale.
E2	Scale not ready Error.	The scale is not in a state where a command could be expected.
E4	Too many characters Error	Command contains too many characters.
E6	Format Error	Command contains invalid characters.
E7	Out of range Error	Value is out of range. Tare weight is more than the capacity, etc.

### Data Format “ \_ ” in examples below shows “Space” (20H).

- ❑ Examples below are for F-09-02=“0000”. <ACK>=06H.
- ❑ Store unit weight and other value in use (according to F-01-05).

Command **[E], [1][2][C<sub>R</sub>][L<sub>F</sub>]** Stores to *id-12*. (E,000012C<sub>R</sub>L<sub>F</sub> is acceptable.)

Reply **ACK[C<sub>R</sub>][L<sub>F</sub>]**

- ❑ ID Number

Command **[?][I][D][C<sub>R</sub>][L<sub>F</sub>]**

Reply **[I][D], [0][0][0][0][1][2][C<sub>R</sub>][L<sub>F</sub>]**

- ❑ PCS (Count ) Data

Command **[?][Q][T][C<sub>R</sub>][L<sub>F</sub>]**

Reply **[Q][T], [+][0][0][0][0][1][2][3][4][\_][P][C][C<sub>R</sub>][L<sub>F</sub>]** Stable Positive Data  
**[U][S], [-][0][0][0][0][5][6][7][8][\_][P][C][C<sub>R</sub>][L<sub>F</sub>]** Unstable Negative Data  
**[O][L], [+][9][9][9][9][9][9][9][9][\_][P][C][C<sub>R</sub>][L<sub>F</sub>]** ‘E’ display

- ❑ Weight Data

Command **[?][W][T][C<sub>R</sub>][L<sub>F</sub>]**

Reply **[S][T], [+][0][0][1].[2][3][4][6][\_][k][g][C<sub>R</sub>][L<sub>F</sub>]** Stable Positive Data  
**[S][T], [-][0][0][2].[7][2][5][5][\_][l][b][C<sub>R</sub>][L<sub>F</sub>]** Stable Negative Data  
**[U][S], [-][0][0][1][2].[3][4][6][\_][l][b][C<sub>R</sub>][L<sub>F</sub>]** Unstable Negative Data  
**[U][S], [+][0][0][0][5].[5][9][3][\_][k][g][C<sub>R</sub>][L<sub>F</sub>]** Unstable Positive Data  
**[O][L], [+][9][9][9][9].[9][9][9][\_][k][g][C<sub>R</sub>][L<sub>F</sub>]** ‘E’ display  
**[O][L], [-][9][9][9][9].[9][9][9][\_][l][b][C<sub>R</sub>][L<sub>F</sub>]** ‘-E’ display

☐ Unit Weight

Command 

?	U	W	C <sub>R</sub>	L <sub>F</sub>
---	---	---	----------------	----------------

Reply 

U	W	,	+	1	.	2	3	4	5	6	7	_	_	g	C <sub>R</sub>	L <sub>F</sub>
U	W	,	+	0	.	2	7	2	5	3	1	_	l	b	C <sub>R</sub>	L <sub>F</sub>

☐ Total Count

Command 

?	A	Q	C <sub>R</sub>	L <sub>F</sub>
---	---	---	----------------	----------------

Reply 

A	Q	,	+	0	0	9	9	9	9	9	9	_	P	C	C <sub>R</sub>	L <sub>F</sub>
---	---	---	---	---	---	---	---	---	---	---	---	---	---	---	----------------	----------------

☐ Accumulation Numbers

Command 

?	A	N	C <sub>R</sub>	L <sub>F</sub>
---	---	---	----------------	----------------

Reply 

A	N	,	0	0	0	0	1	2	3	4	C <sub>R</sub>	L <sub>F</sub>
---	---	---	---	---	---	---	---	---	---	---	----------------	----------------

☐ Tare Weight

Command 

?	T	R	C <sub>R</sub>	L <sub>F</sub>
---	---	---	----------------	----------------

Reply 

T	R	,	+	0	0	1	.	2	3	4	6	_	k	g	C <sub>R</sub>	L <sub>F</sub>
---	---	---	---	---	---	---	---	---	---	---	---	---	---	---	----------------	----------------

☐ Request the scale to reply with the contents of ID memory.

Command 

?	M	R	,	1	2	C <sub>R</sub>	L <sub>F</sub>
---	---	---	---	---	---	----------------	----------------

 Request the contents of *id-12*.

Reply 

M	R	,	0	0	0	0	1	2	,	1	2	.	3	4	5	6	7	,	+	0	0	0
.	2	3	4	5	,	+	0	0	0	0	1	3	5	7	,	+	0	0	0	0	1	2
4	6	,	+	0	1	2	3	4	5	6	7	,	0	0	0	0	1	2	3	4	C <sub>R</sub>	L <sub>F</sub>

MR, ID number (6 digit), unit weight (8 digit including decimal point), tare weight (9 digit including sign and decimal point), upper limit (9 digit including sign), lower limit (9 digit including sign), total count (9 digit including sign), number of addition (8 digit) C<sub>R</sub> L<sub>F</sub>.

☐ Store (enter) a unit weight and tare weight into a specified ID memory.

Command 

M	R	,	1	2	,	1	.	2	3	,	0	.	3	4	5	C <sub>R</sub>	L <sub>F</sub>
---	---	---	---	---	---	---	---	---	---	---	---	---	---	---	---	----------------	----------------

ID #
Unit Weight
Tare Weight

Reply 

ACK	C <sub>R</sub>	L <sub>F</sub>
-----	----------------	----------------

ID Number: Maximum 6 digit  
 Unit Weight: Maximum 8 digit including decimal point  
 Tare Weight: Maximum 8 digit including decimal point ('kg' or 'lb' depends on F-00 setting).

☐ Store the comparator limits into a specified ID memory.

Command 

M	L	,	1	2	,	+	1	0	1	0	,	+	9	9	0	C <sub>R</sub>	L <sub>F</sub>
---	---	---	---	---	---	---	---	---	---	---	---	---	---	---	---	----------------	----------------

ID #
Upper Limit
Lower Limit

Reply 

ACK	C <sub>R</sub>	L <sub>F</sub>
-----	----------------	----------------

ID Number: Maximum 6 digit  
Upper Limit: Maximum 9 digit including sign  
Lower Limit: Maximum 9 digit including sign

- Request the scale to reply with the setting of an F-Function.

Command 

?	F	C	,	0	5	0	1	C <sub>R</sub>	L <sub>F</sub>
---	---	---	---	---	---	---	---	----------------	----------------

 Request to reply with the setting of *F-05-01*.

Reply 

F	C	,	0	5	0	1	,	0	C <sub>R</sub>	L <sub>F</sub>
---	---	---	---	---	---	---	---	---	----------------	----------------

*F-05-01 = 0*

F-#                      Setting value

- Store the specified F-Function setting value

Command 

F	C	,	0	5	0	3	,	+	1	2	3	4	C <sub>R</sub>	L <sub>F</sub>
---	---	---	---	---	---	---	---	---	---	---	---	---	----------------	----------------

 Set "1234" as the Upper limit.

F-#                      Setting value

F-Function Number: 4 digits  
Setting Value: Maximum 8 digits including sign.

Reply 

ACK	C <sub>R</sub>	L <sub>F</sub>
-----	----------------	----------------

Command 

O	N	C <sub>R</sub>	L <sub>F</sub>
---	---	----------------	----------------

 Start with new settings.

Reply 

ACK	C <sub>R</sub>	L <sub>F</sub>
-----	----------------	----------------

- Having finished the "FC" command, send the "ON" command to start the scale with new settings. The scale replies <ACK> (06H) and starts.

## 13-7. Using UFC (Universal Flex Coms) Function

- The UFC function allows you to format the print out (UFC format).
- The scale can store the UFC format as text data. It will include parameters to replace with the count data, weight data and so on.
- The maximum number of text data is 384 characters.
- The terminator for the "PF" command is "C<sub>R</sub>" or "C<sub>R</sub>L<sub>F</sub>".
- Using the "PF" command, the text data has to be sent to the scale from the computer in advance. Then, connect the scale with the printer.**
- When the PRINT key is pressed or by auto-print mode A/B, the scale will send the stored text data with the parameters replaced by the original data.

### Store Text Data into the Scale Memory

Command	P	F	,	\$	P	C	,	'	T	E	X	T	'	,	#	2	0	,	\$	S	P	*	2	,	&
	\$	C	R	,	\$	L	F	,	\$	W	T	,	\$	C	R	,	\$	L	F	C <sub>R</sub>	L <sub>F</sub>				
Reply	ACK			C <sub>R</sub>	L <sub>F</sub>	Terminator																			

The "PF" command sends text data that will include:

- Parameters for the scale data and control codes

Parameter	Data & Code
\$PC	Count
\$WT	Weight
\$UW	Unit weight in use
\$TR	Tare weight in use
\$TL	Total count
\$AN	Accumulation numbers

Parameter	Data & Code
\$CD	ID number in use
\$CP	Comparator result
\$CM	Comma
\$SP	Space
\$CR	Carriage Return
\$LF	Line Feed

- These parameters must be used in capital letters.
- ASCII text string  
A text string is described in single quote marks as 'Data'.  
The single quote itself is written as ''(2 single quotes).  
Example: Text 'ABC' is described as "'ABC'".
- The ASCII hexadecimal code  
The ASCII hexadecimal codes are written in the form "#" + 2 hexadecimal digits.  
This will mainly be used to send control codes that can't be described as a text string.  
Example: #04 "EOT" of ASCII code
- Repeat data  
The control codes \$SP, \$CR and \$LF can be used with "\*" plus a 1 or 2 digit number". That code will be repeated the number of times designated.  
Example: \$LF\*9 Repeat "\$LF" 9 times.  
\$SP\*12 Use 12 "Spaces".
- Link mark "&"  
If you will send more than 2 lines of data, attach "&" to the end of the first line. Then, the scale considers the data to be continued.
- A "Space" or "," will be used to separate these data. You can skip them, but you cannot skip "," after "PF". You must start with "PF,".**

## Data Format for the Scale Data

"\_" in examples below shows "Space" (20H).

Parameters for the scale data will be replaced by the format below when the scale sends them out.

- Data has a fixed number of digits including a sign and a decimal point. The insignificant zeros are replaced by "Space (20H)" (except the ID number).

\$PC	<table border="1"><tr><td>_</td><td>_</td><td>_</td><td>_</td><td>+</td><td>1</td><td>2</td><td>3</td><td>4</td><td>_</td><td>P</td><td>C</td></tr></table>	_	_	_	_	+	1	2	3	4	_	P	C	1234 pcs / 9 digit data + 3 digit unit
_	_	_	_	+	1	2	3	4	_	P	C			
\$WT	<table border="1"><tr><td>_</td><td>_</td><td>+</td><td>4</td><td>.</td><td>3</td><td>2</td><td>1</td><td>0</td><td>_</td><td>k</td><td>g</td></tr></table>	_	_	+	4	.	3	2	1	0	_	k	g	4.3210 kg / 9 digit data + 3 digit unit
_	_	+	4	.	3	2	1	0	_	k	g			
\$UW	<table border="1"><tr><td>+</td><td>1</td><td>.</td><td>2</td><td>3</td><td>4</td><td>5</td><td>6</td><td>7</td><td>_</td><td>_</td><td>g</td></tr></table>	+	1	.	2	3	4	5	6	7	_	_	g	1.234567 g / 9 digit data + 3 digit unit
+	1	.	2	3	4	5	6	7	_	_	g			
\$TR	<table border="1"><tr><td>_</td><td>_</td><td>+</td><td>1</td><td>.</td><td>2</td><td>3</td><td>4</td><td>5</td><td>_</td><td>k</td><td>g</td></tr></table>	_	_	+	1	.	2	3	4	5	_	k	g	1.2345 kg / 9 digit data + 3 digit unit
_	_	+	1	.	2	3	4	5	_	k	g			
\$TL	<table border="1"><tr><td>_</td><td>_</td><td>+</td><td>9</td><td>9</td><td>9</td><td>9</td><td>9</td><td>9</td><td>_</td><td>P</td><td>C</td></tr></table>	_	_	+	9	9	9	9	9	9	_	P	C	999999 pcs / 9 digit data + 3 digit unit
_	_	+	9	9	9	9	9	9	_	P	C			
\$AN	<table border="1"><tr><td>_</td><td>_</td><td>_</td><td>_</td><td>1</td><td>2</td><td>3</td><td>4</td></tr></table>	_	_	_	_	1	2	3	4	1234 times / 8 digit data				
_	_	_	_	1	2	3	4							
\$CD	<table border="1"><tr><td>0</td><td>0</td><td>0</td><td>0</td><td>1</td><td>2</td></tr></table>	0	0	0	0	1	2	ID Number 000012 / 6 digit data						
0	0	0	0	1	2									
\$CP	<table border="1"><tr><td>O</td><td>K</td></tr><tr><td>_</td><td>_</td></tr></table>	O	K	_	_	Result is "OK" / 2 characters Result is not available.								
O	K													
_	_													

## Examples of PF command and AD-8121 Printout Sample

AD-8121 (F-06-03="0" or "1")  
(HC-i → AD-8121)

"PF" Command  
(Computer → HC-i)

```

ID 000012

Count
      +1234 PC
Unit Weight
      +1.234567 g
Weight
      +1.5235 kg

DATE 09/18/2005
TIME 12:34:56

A&D HC-15Ki
    
```

```

PF, 'ID_', $CD, $CR, $LF, &
$CR, $LF, &
' Count', $CR, $LF, &
$SP*4, $PC, $CR, $LF, &
' Unit_Weight', $CR, $LF, &
$SP*4, $UW, $CR, $LF, &
' Weight', $CR, $LF, &
$SP*4, $WT, $CR, $LF, &
$CR, $LF, &
#1B, #44, $CR, $LF, &
#1B, #54, $CR, $LF, &
$CR, $LF, &
'_A&D_HC-15Ki', $CR, $LF
    
```

Terminator codes

"\_" shows "Space".

- Normally the printer needs to receive the terminator, and do not forget to add the terminator code(s) to the end of text data.

# 14. OP-04 RS-232C & RELAY OUTPUT

RS-232C interface and relay output for comparator results are obtained by installing OP-04.

- ❑ The OP-04 unit includes an interface board, a connector plug (DIN type) and two screws. (M3x6 tapping type).

## OP-04 Installation

- ❑ See “13-1. Installation”.
- ❑ OP-04 is installed into the same slot as OP-03, therefore OP-03 and OP-04 cannot coexist.
- ❑ The RS-232C specifications are the same as OP-03 RS-232C interface. Refer to “13. OP-03 RS-232C SERIAL INTERFACE”.

## Comparator Relay Output Circuit

Pin connections

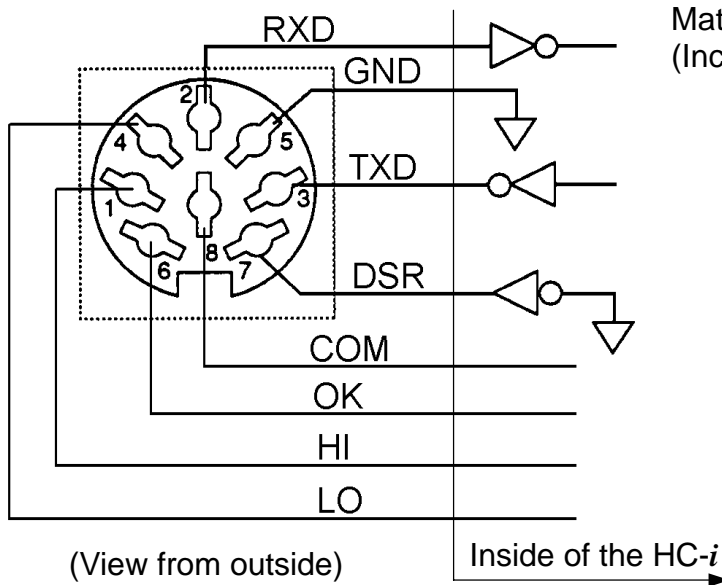

Mating connector: JA+TCP0586  
(Included in the OP-04)

- 1 HI (relay output)
- 2 Receive data (RS-232C)
- 3 Transmit data (RS-232C)
- 4 LO (relay output)
- 5 Signal ground (RS-232C)
- 6 OK (relay output)
- 7 Data set ready (RS-232C)
- 8 COM (relay common)

- ❑ The HC-*i* is designated as DCE (Data Communication Equipment).

## Maximum rating of the Relay Output

The maximum rating of the replay output is as follows.

- ❑ Maximum voltage: 50V DC
- ❑ Maximum current: 100mA DC
- ❑ Maximum ON resistance 30Ω

# 15. OP-08 EXTENSION CABLE

The display pod can be separated from the scale base by using the optional extension cable. The cable between the display pod and the base is approximately 2m long.

1. Disconnect the AC adapter from the scale. If the battery is used, switch off the scale.
2. Remove 6 screws and the display support plate.

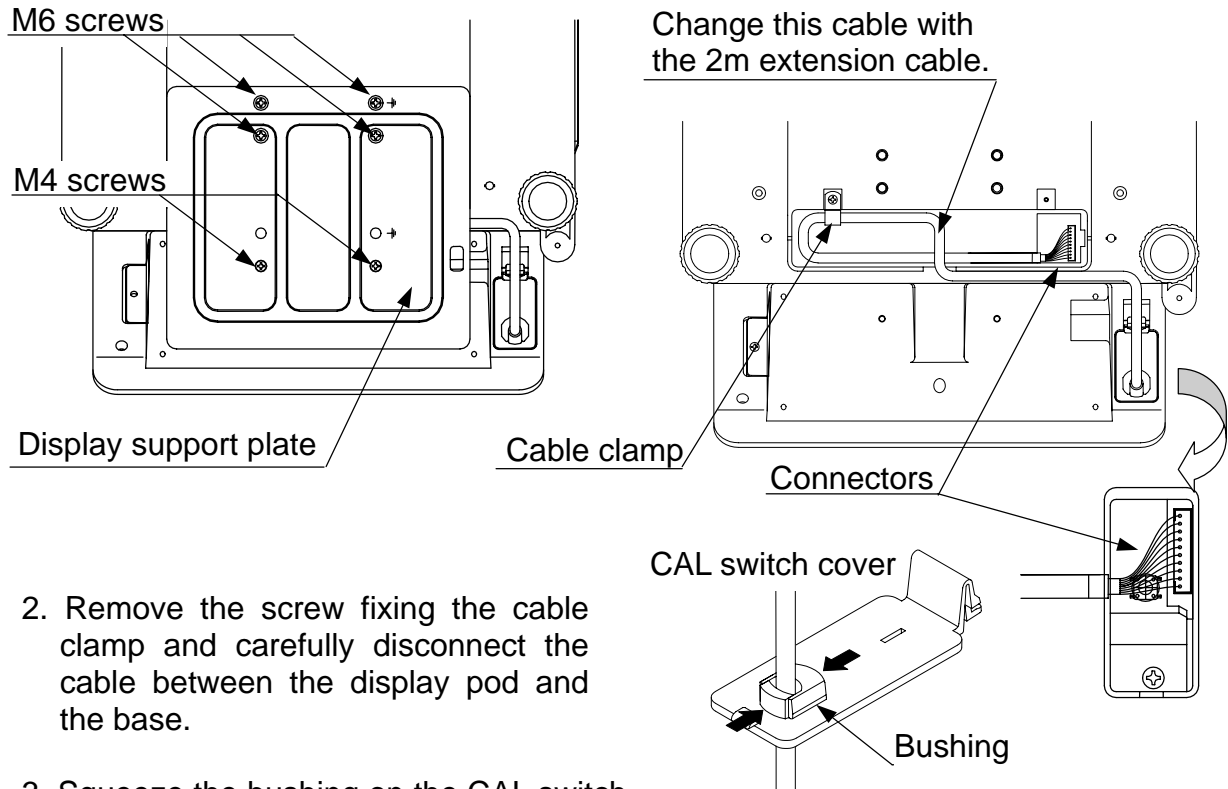

2. Remove the screw fixing the cable clamp and carefully disconnect the cable between the display pod and the base.
3. Squeeze the bushing on the CAL switch cover and pull the cable out.

4. Attach the optional cable to the CAL switch cover with the bushing.

❑ Carefully connect the cable connectors to the scale as the original cable was.

5. Attach the display support plate as shown, using 4 M6 screws removed at step 2.

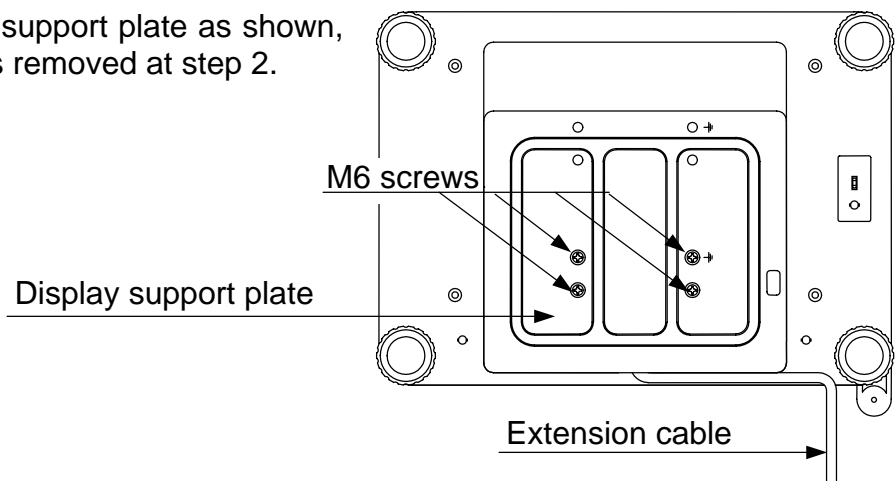



# 16. SPECIFICATIONS

MODEL	HC-3Ki	HC-6Ki	HC-15Ki	HC-30Ki
Capacity kg	3 kg	6 kg	15 kg	30 kg
Resolution (k)g	0.0005 kg	0.001 kg	0.002 kg	0.005 kg
Capacity lb	6 lb	15 lb	30 lb	60 lb
Resolution lb	0.001 lb	0.002 lb	0.005 lb	0.01 lb
Sample Size	10 pieces normal – 5, 25, 50, 100 or random number, user selectable			
Min. Unit Weight *)	0.1 g / 0.005 g	0.2 g / 0.01 g	0.4 g / 0.02 g	1 g / 0.05 g
Non-linearity	±0.5 g	±1 g	±2 g	±5 g
Repeatability	0.5 g	1 g	2 g	5 g
Span Drift	0.002%/°C (5°C~35°C) typ.			
Operating Temp.	-10°C~40°C/14°F~104°F, less than 85% RH (No Condensation)			
Display	7 segment LCD, Character height: pcs 18.6mm, weight/unit weight 11.4mm			
Display Update	Approximately 10 times per second			
Interface	RS-232C (option)			
Power	AC adapter or SLA Battery (option) Battery Operating Time: Approx. 80 hours (without interface)			
Platform Size	300 x 210 mm / 11.8 x 8.3 inches			
Dimensions	315(W) x 331(D) x 126(H) mm / 12.4(W) x 13.0(D) x 5.0(H) inches			
Weight (approx.)	4.8 kg / 10.6 lb			
Calibration Weight	3kg±0.1g	6kg±0.2g	15kg±0.5g	30kg±1g
Accessories	This manual, AC adapter			

\*) Min. unit weight varies according to the function setting (F-02-03).

## Options

- OP-02 SLA Battery (Yuasa Battery NP4-6 recommended.)
  - OP-03 RS-232C (See note.)
  - OP-04 RS-232C + Comparator Relay output (See note.)
- Note) OP-03 and OP-04 cannot coexist.

## Dimensions

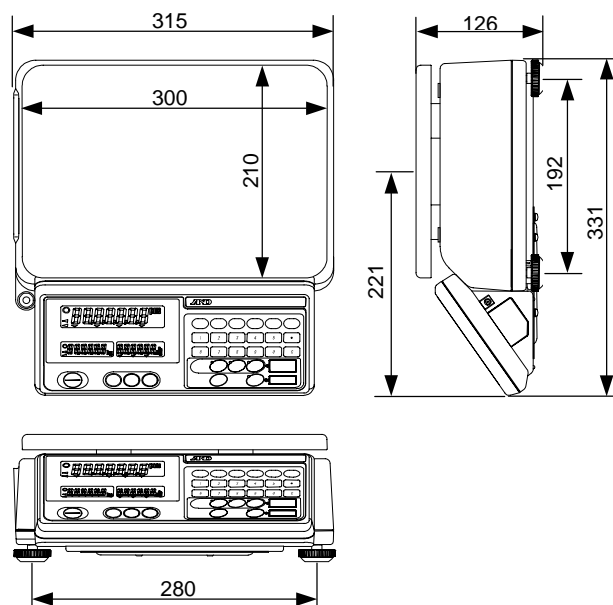

# 17. GRAVITY ACCELERATION MAP

## Values of gravity at various locations

Amsterdam	9.813 m/s <sup>2</sup>	Manila	9.784 m/s <sup>2</sup>
Athens	9.807 m/s <sup>2</sup>	Melbourne	9.800 m/s <sup>2</sup>
Auckland NZ	9.799 m/s <sup>2</sup>	Mexico City	9.779 m/s <sup>2</sup>
Bangkok	9.783 m/s <sup>2</sup>	Milan	9.806 m/s <sup>2</sup>
Birmingham	9.813 m/s <sup>2</sup>	New York	9.802 m/s <sup>2</sup>
Brussels	9.811 m/s <sup>2</sup>	Oslo	9.819 m/s <sup>2</sup>
Buenos Aires	9.797 m/s <sup>2</sup>	Ottawa	9.806 m/s <sup>2</sup>
Calcutta	9.788 m/s <sup>2</sup>	Paris	9.809 m/s <sup>2</sup>
Cape Town	9.796 m/s <sup>2</sup>	Rio de Janeiro	9.788 m/s <sup>2</sup>
Chicago	9.803 m/s <sup>2</sup>	Rome	9.803 m/s <sup>2</sup>
Copenhagen	9.815 m/s <sup>2</sup>	San Francisco	9.800 m/s <sup>2</sup>
Cyprus	9.797 m/s <sup>2</sup>	Singapore	9.781 m/s <sup>2</sup>
Djakarta	9.781 m/s <sup>2</sup>	Stockholm	9.818 m/s <sup>2</sup>
Frankfurt	9.810 m/s <sup>2</sup>	Sydney	9.797 m/s <sup>2</sup>
Glasgow	9.816 m/s <sup>2</sup>	Taichung	9.789 m/s <sup>2</sup>
Havana	9.788 m/s <sup>2</sup>	Taiwan	9.788 m/s <sup>2</sup>
Helsinki	9.819 m/s <sup>2</sup>	Taipei	9.790 m/s <sup>2</sup>
Kuwait	9.793 m/s <sup>2</sup>	Tokyo	9.798 m/s <sup>2</sup>
Lisbon	9.801 m/s <sup>2</sup>	Vancouver, BC	9.809 m/s <sup>2</sup>
London (Greenwich)	9.812 m/s <sup>2</sup>	Washington DC	9.801 m/s <sup>2</sup>
Los Angeles	9.796 m/s <sup>2</sup>	Wellington NZ	9.803 m/s <sup>2</sup>
Madrid	9.800 m/s <sup>2</sup>	Zurich	9.807 m/s <sup>2</sup>

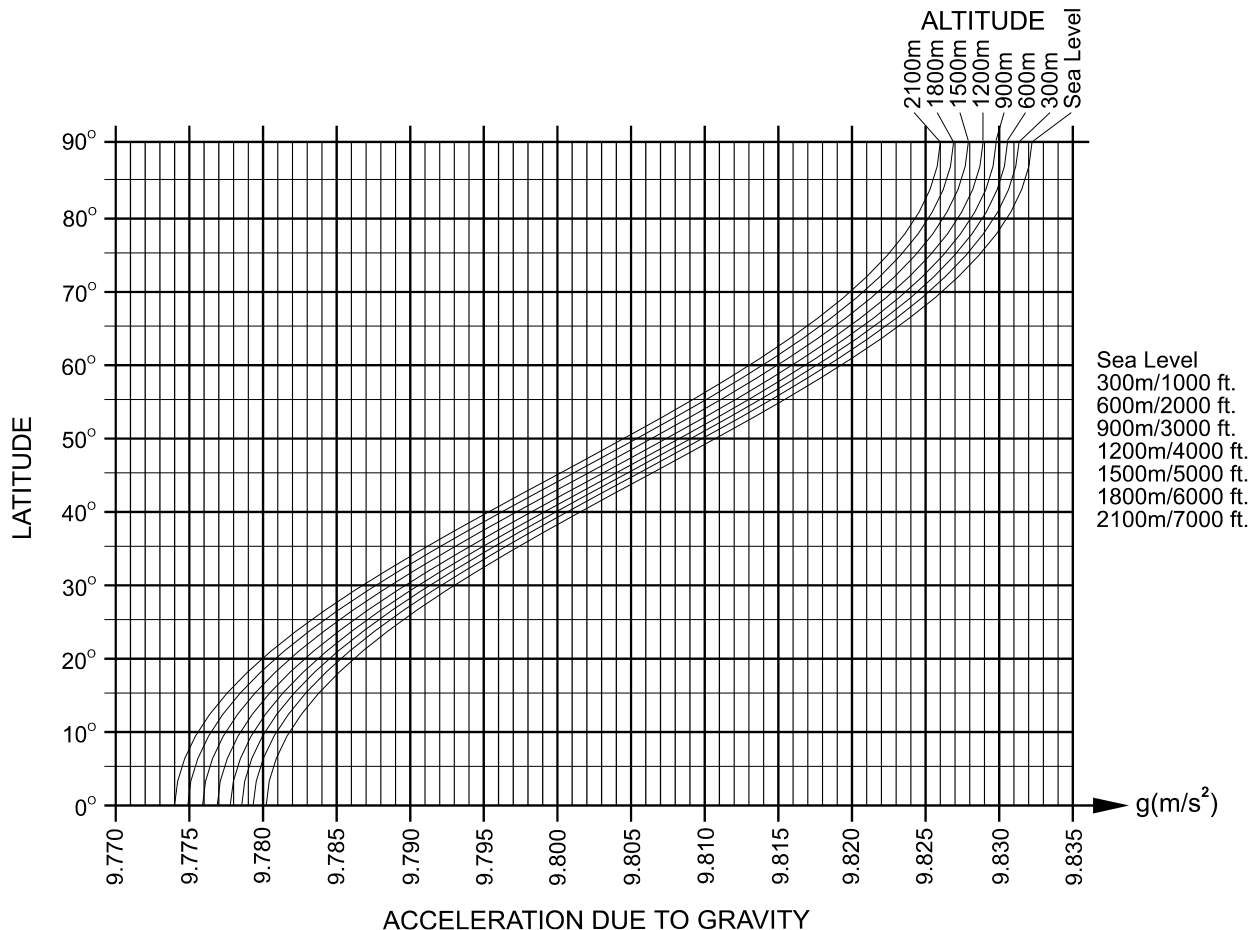

# World map

