



Tools for
Advancing
Innovation™

CYCLOPS 4K

Digital Microscope



26700-424

Contents

1.	Product Introduction.....	2
1.1	Packing Contents.....	2
1.2	Assemble microscope with stand	2
1.3	IR Remote controller	4
1.4	Microscope menu functions.....	11
1.5	Microscope introduction:.....	19
1.6	Microscope Focus.....	23
1.7	Microscope accessory	27
2.	Printed Notice	27
2.1	Maintenance	27
2.2	Product Specification	28
2.3	Safety Instructions.....	30

1. Product Introduction

1.1 Packing Contents

The box contains microscope and accessories. The Object Lens 4X is already assembled onto microscope.

Item	Q'ty	Item	Q'ty
Cyclops 4K	1	White Balance Card	1
HDMI Cable	1	IR Remote Control	1
USB mini Cable	1	User's Guide	1
Power adaptor	1	Calibrator	1
S107 Stand	1	Object Lens 4x	1
Stand assemble guide	1	Object Lens 10x	Option
MicroSD Card	Option		

Software download: aventools.com/software-downloads



1.2 Assemble microscope with stand

1.2.1 Fix microscope

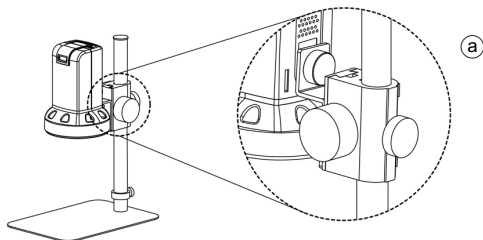
Tighten the microscope onto stand [ⓐ]. Refer to stand assembling instruction for detailed explanation.



1.2.2 Start to use microscope

Connect the HDMI cable  and adaptor  to HDMI monitor and power. See below:

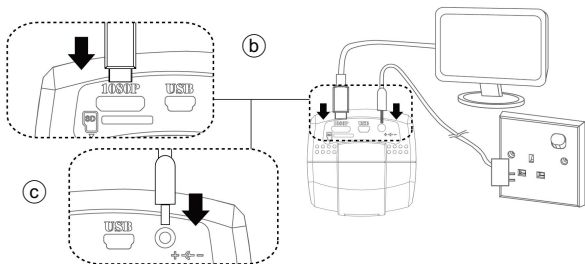

1.2.3 Power On/Off



Press Power  to turn on microscope. Choose HDMI mode

or Auto on HDMI monitor to output image. *Long press means press and hold the button for 2 seconds.

1.3 IR Remote controller

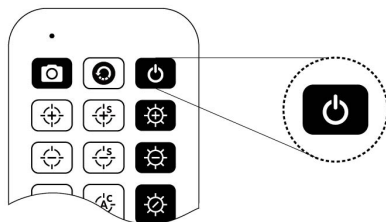
The microscope operation and functions is controlled by the IR remote controller.



- (1) Power : Turn on/off.
- (2) HDMI : When in HDMI mode, the HDMI cable must connect with the screen and microscope.
- (3) PC CAM : The USB cable must connect to a PC and microscope in PC CAM mode. Please disconnect software before switching to HDMI mode or powering off. If SD card is loaded, a USB Disk will also show up.

(4) Snapshot : In HDMI mode, press button to save an 8MP .jpg file into SD card. Per snapshot takes 9 Seconds to complete. In PCCAM mode, press snapshot to take an 8MP image, select photo type when saving the image on the software.

(5) LED Adjustment: 12 levels of brightness.

(5-1) Increase : Increase LED brightness.

(5-2) Decrease : Decrease LED brightness.

(5-3) On/Off : Turn the LED on/off. When turn on the LED, the brightness will return to the situation before turn off.

(6) Motor Reset  (Recalibrates entire operation): Returns to

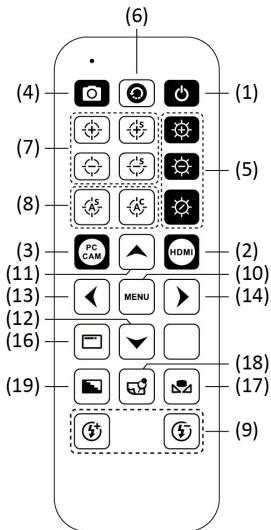



the lens position. If a loss of electricity occurred during operation, please reset the operation.

(7) Manual focus

(7-1) Zoom in : Zooms in; speed increases when held.

(7-2) Zoom out : Zooms out; speed increases when held.

(7-3) Step zoom in : Zoom in by steps.

(7-4) Step zoom out : Zoom out by steps.

(8) Autofocus: Press one time to search focus in current area, long press for 2 seconds to search focus in whole area.







(8-1) Single Autofocus : Focuses one time.

(8-2) Continuous Autofocus : Re-focuses when image blurred.

(9) Exposure Value: 14 levels of exposure value are selectable, from -7 ~ Auto ~ +6.

(9-1) Increase : Use to increase exposure when the image is too dark.



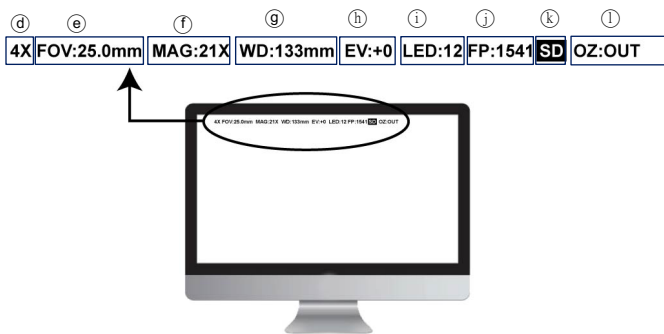

(9-2) Decrease : Use to decrease exposure when the image is too bright.

- (10) Menu on Screen : Open/close menu for setting. Refer to Section 1.4.
- (11) Up : Choose the previous item, if Crosshair is ON, select other color.
- (12) Down : Choose the next item, if Crosshair is ON, select other color.
- (13) Left : Choose the next value, if Crosshair is ON, select Line Size.
- (14) Right : Choose the last value. When MENU function is off, press to turn on/off Crosshair.
- (15) Video Ratio : No Function.
- (16) Status Bar : There are 8 fixed information on Status bar and one is operating information which only display 3 sec. If see different lens mode, such as [FL, FLC, TL], it's for free lens such as 4x long focus lens or -CSZ064 series. It will disable the LED light, WD, FOV and show only OZ (sensor position), and EV (Exposure). Longer press 6 secs on the Status Button to switch to standard 4X/10X lens mode.



(16-1) Fixed information:

- (16-1-1) 4X ϕ : Object Lens (4X/10X) or other Lens type. (FL/FLC/TL)
- (16-1-2) FOV ϵ : Field of View (FOV) display image on the effective horizontal size of screen.
- (16-1-3) MAG ϕ : (Magnification) The magnification size will change depending on the lens position, screen size, and image ratio.
- (16-1-4) WD \textcircled{g} : Working Distance.

- (16-1-5) EV : Exposure Value levels.
- (16-1-6) LED : LED levels
- (16-1-7) POS : Focus Position
- (16-1-8) SD : SD card status. If SD card is loaded, it will show SD on the status bar.
- (16-2) Operating Information :
 - (16-2-1) OZ: Optical Zoom. Ex: OZ: IN. Optical zoom in.
 - (16-2-2) SZ: Step Zoom. Ex: SZ: OUT. Zoom by steps.
 - (16-2-3) AFS: Single Autofocus. Ex: AFS▶ AREA, “A” means search focus in “current area”. AFS▶ WIDE, “W” means search focus in “whole area”.
 - (16-2-4) AFC: Continuous autofocus, “A” and “W” are same function as AFS.
 - (16-2-5) MR: Motor Reset. MOTOR▶ RST.
 - (16-2-6) SHA : Sharpness. Ex: SHA▶ MAX: 31, means maximum. The current level set at 4. SHA▶ SET:4
 - (16-2-7) FRZ: Image Freeze. Ex: FRZ▶ ON, means freeze image, FRZ▶ OFF means unfreeze image.

- (16-2-8) AWC: White Balance Calibration. Ex: AWC▶SET means calibrate white balance.
- (16-2-9) DISP: Turn on the Status Bar. EX: AWC▶ON。
- (16-2-10) SNAPSHOT: Photo Taking.
- (16-2-11) WAITING: Picture Saving. (about 9 sec)
- (16-2-12) SAVED: Save the Menu Setting.
- (16-2-13) NO SD: No SD Card loaded. Unable to take picture.
- (16-2-14) SD FULL: SD Card Storage is full. Unable to take picture.
- (16-2-15) LOAD DEF: Loading the Default Setting.
- (16-2-16) FINISHED: Photo saved or Default setting completed.
- (16-2-17) FAILED: Failed to save image. Please format the SD card in FAT32, or SD card is damaged.
- (16-2-18) None: Function not supported.

(17) Auto White Balance Calibration : To calibrate the white

balance, place the white balance card (included in box) under the lens, focus until clear, and choose on. Because the white balance is sometimes influenced by external light sources, it is recommended to calibrate the white balance if the color seems off or incorrect.

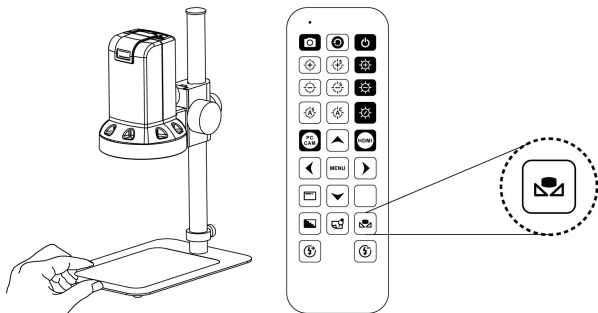

(18) Image Freeze : ON/Off to freeze or unfreeze the image.

(19) Sharpness : On/Off to set sharpness at Minimum and Maximum level.

1.4 Microscope menu functions

There are 2 pages in Menu, total 16 items. Press  button to

enter MENU, press Up (▲) and Down (▼) to choose item, Left (◀) and Right (▶) to turn on/off or adjust parameter. Enter (↵) means more functions, press Menu (MENU) to enter next function or confirm. Return to return last page, or press Left (◀) or Right (▶) to choose "SAVED" to return preview window.

[MAIN MENU]	1/2
IMG ADJUST	↵
IMG EFFECT	↵
EXPOSURE	AUTO
GAIN CTRL	LVLO
BACKLIGHT	QTR
AWB MODE	AWB

[MAIN MENU]

2/2

2D NR	ON ↵
POWER FREQ	60HZ
MENU COLOR	WHT
FACTORY	NO
ABOUT	↵
EXIT	END ↵

1.4.1 IMG ADJUST

To adjust Image parameters. See below:

[IMAGE ADJUST]

CONTRAST	20
BRIGHTNESS	128
SATURATION	30
SHARPNESS	4
DEFAULT	NO
RETURN	↵

- (1) CONTRAST: Adjust Image's Contrast. Range from 0~63.
- (2) BRIGHTNESS: Adjust Image's Brightness, range from 0~255
- (3) SATURATION: Adjust Image's Saturation. Range from 0~63.
- (4) SHARPNESS: Adjust Sharpness, higher value increases the higher contrast along/near edges of the image. Higher edges might show image noise.
- (5) DEFAULT: Return to Default Setting.
- (6) RETURN: Return to last page.

1.4.2 IMG EFFECT

To adjust Image effect, please see below.

[IMAGE EFFECT]	
COLOR MODE	COLOR
VIDEO FLIP	NONE
FREEZE	OFF
DEFAULT	NO
RETURN	⏮

- (2-1) COLOR MODE: Output image can be Color mode or Black/White (MONO).
- (2-2) VIDEO FLIP: Image flip function. HORI: Horizontal Flip, Mirror: VERT: Vertical and Diagonal (BOTH: Flip Horizontal and vertical)
- (2-3) FREEZE: (ON/OFF), Image Freeze function.
- (2-4) DEFAULT: Return to Default Setting.
- (2-5) RETURN: Return to last page.

1.4.3 EXPOSURE

Digitally control amount of light, the amount is smaller the image is darker and the frame rate is also slower. The range: 1/10K, 1/5K, 1/2K, 1/1K, 1/480, 1/240, 1/120, AUTO, 1/60, 1/30, X2, X4, X6, X8.

1.4.4 GAIN CTRL

Set gain Control level to raise up brightness of image. When the observing, LED turn maximum, but the image is still dark, increase the Gain control level. Gain level does not affect frame rate speed. Range: LVL0~ LVL7.

1.4.5 BACKLIGHT

To choose the backlight mode. Press Left/Right to select mode.

- (1) WHOLE: Compensate the darker area of the image.
- (2) QTR: To calculate the backlight compensation from 1/4 area of the central
- (3) QTR+: Again, weighting 1/4 area backlight compensation

1.4.6 AWB MODE

Calibrate the white color when change different light. Press Left/Right to choose correct mode.

- (1) AWB: Auto white balance.
- (2) AWC: Semi-auto white balance. Use to trace the white color from current image. See item (17) in Section 1.3.
- (3) MWB : Manually adjust blue and red values to find correct white color. Refer to below fig.

[MANUAL WB]

RED	47
GREEN	24
BLUE	56
DEFAULT	NO
RETURN	↵

- (3-1) RED: RED, adjust Red percentage, range 0~255.
- (3-2) GREEN: Green, adjust Green percentage, range 0~255.
- (3-3) BLUE: Blue, adjust Blue percentage, range 0~255.
- (3-4) DEFAULT: Return to default setting.
- (3-5) RETURN: Return to last page.

1.4.7 2D NR

Two Dimensional Noise Reduction: 2DNR. To obtain high quality output image.

- (1) ON : Turn on 2D. Press  to enter Menu function.

[2D NR]

NR LEVEL	8
DEFAULT	ON
RETURN	↵

(1-1) NR LEVEL: Noise Reduction level. Higher level will decrease the image noise, cause the edge sharpness downgrade.

(1-2) DEFAULT: Return to Default Setting.

(1-3) RETURN: Return to last page.

(2) OFF: OFF.

1.4.8 POWER FREQ

Power line frequency. Based on the power line to choose 60Hz or 50Hz. Or when see horizontal lines show up (flicker situation), can try to set another frequency.

1.4.9 MENU COLOR

Menu color, choose menu color.

(1) WHT: White text, black background.

(2) RED: Red text, black background.

(3) YEL: Yellow text, black background.

(4) FUS: Fuchsia text, black background.

1.4.10 FACTORY

Factory Default. Press Left ◀ or Right ▶ to select “NO” or “Yes ↵” to return to factory setting.

1.4.11 ABOUT

Press MENU , read output and firmware version in ABOUT.

[ABOUT]

HDMI: 1080P/60FPS

USB: YUV/1080P

MJPG/4K2K

PSN: UM30TW0100

IFW: 02.01

MFW: 01.00.00

1.4.12 EXIT

Exit menu, press Left ◀ or Right ▶ to choose “END ↵” or “SAVE ↵” current setting.

1.5 Microscope introduction:

1.5.1 IR Remote Area/Indicator

When both ④ and ⑤ LED indicator blinks, the microscope is in standby mode.

Caution: Please remove the transparent protection sheet on the IR receiver area.

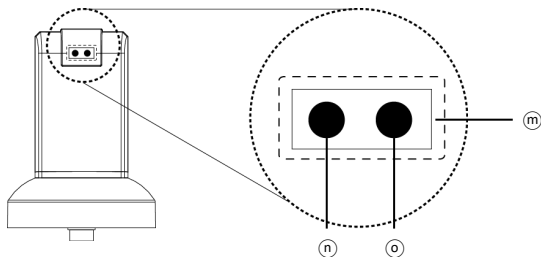

- (1) IR remote control aiming area ④ : The indicator will blink whenever buttons are pressed. If the indicator did not blink means the signal was not delivered and please repress again.
- (2) HDMI indicator ⑤ : When lit up, the microscope is in HDMI mode. If light blinks, means microscope does not connect with monitor.
- (3) PCCAM Indicator ⑥ : When lit up, the device is in USB mode. If light blinks, means microscope is not connected to a PC.

1.5.2 Power/USB/HDMI port

Caution: Please hold the cable when remove from microscope and do not disassemble cables forcefully.

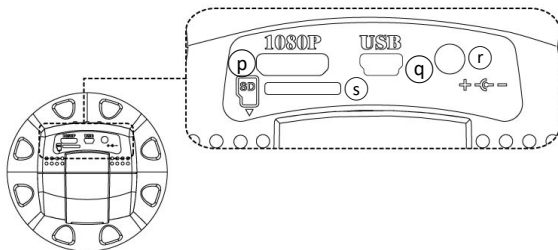

- (1) Power **p**: Power adaptor is only compatible with the cord in the box. Please do not use other adaptor.
- (2) USB **q**: USB port for PC connection, SD card reading and Firmware update.
- (3) HDMI **r**: The HDMI port is used to connect the microscope to a screen. When the device is in HDMI mode, connect the microscope to the screen using the HDMI cable from the box.
* For TV screen connections, make sure to choose the homologous image ratio and format.
- (4) Miro SD **s**: SD card slot. Snapshot in HDMI mode.

1.5.3 Stand gear box

Assemble the stand and then screw the microscope onto the universal joint ① on the gear box.

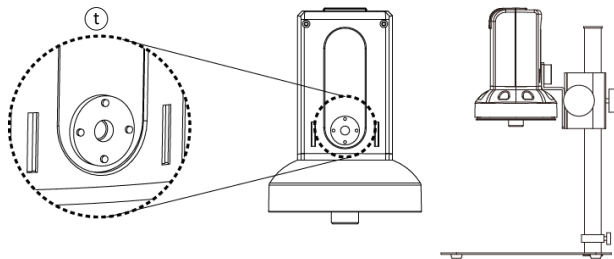

1.5.4 LED/ Light socket

- (1) LED ①: 30 pcs LEDs for object lens 4x.
- (2) Light socket ②: For Optional accessory Lens 10x.

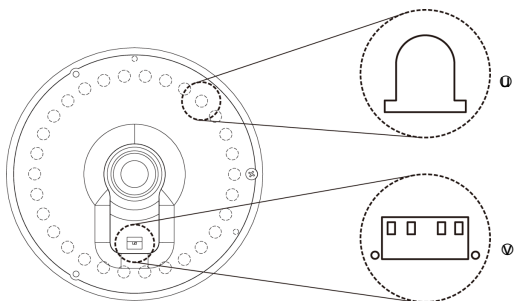

1.6 Microscope Focus

There are two ways to focus. First, choose focus distance to adjust the microscope height, then tuning focus by remote controller until clear. On the contrary, first to choose the image sensor position then adjusts the microscope height.

- Focus distance: distance from object lens to object.
- Image sensor position: The image sensor position.

1.6.1 Focus Techniques

(1) Fixed focus distance

Use knob Ⓧ or Ⓧ to adjust the distance from the object lens to the object. When the distance is closer, the magnification

size is higher. When the focus distance is fixed, use the remote controller or far distance control mode on the application program to focus the image.

(2) Fixed image sensor position

The status bar will show on the screen (please refer to Section 1.3-(16)). Use the remote controller to adjust the image sensor position based on magnification size, FOV, or working distance. When the image sensor position is fixed, focus the image by using knob ω to adjust the height and knob \otimes to fine tune.

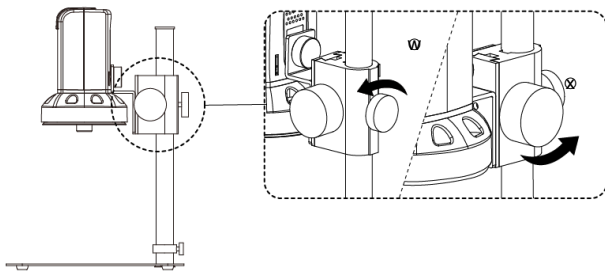

1.6.2 Magnification chart

26 focus section setting is based on the whole focus area per 4x object lens. 10x object lens only have 14 focus sections. The sensor position tells the magnification size (Mag.), field of view (FOV), or working distance(WD). The below chart is measured on 4:3 ratio on 24" screen, it's only a reference data, might not be accurate enough. Based on the image ratio (preview window size), field of view and magnification size will change.

- (1) 4X object lens, focus distance from 21.8mm~213.5mm (0.858~8.4405inch).

4X object lens on 24" (Reference data)									
Focus section	1	2	3	4	5	6	7	8	9
Sensor position	1638	1614	1584	1540	1474	1440	1392	1362	1330
WD(mm)	213.5	186.6	160.1	133.7	107.4	96.6	86.2	80.8	75.5
FOV(mm)	40	35	30	25	20	18	16	15	14
Mag. (X)	13.2	15.1	17.7	21.2	26.5	29.5	33.2	35.4	37.9
Focus section	10	11	12	13	14	15	16	17	18
Sensor position	1294	1250	1200	1142	1110	1070	1028	980	922

WD(mm)	70.3	65.0	59.8	54.5	51.8	49.3	46.6	44.0	41.3
FOV(mm)	13	12	11	10	9.5	9	8.5	8	7.5
Mag. (X)	40.8	44.2	48.3	53.1	55.9	59.0	62.5	66.4	70.8
Focus section	19	20	21	22	23	24	25	26	
Sensor position	864	794	706	606	486	340	160	74	
WD(mm)	38.7	36.0	33.4	30.7	28.0	25.5	22.8	21.8	
FOV(mm)	7	6.5	6	5.5	5	4.5	4	3.8	
Mag. (X)	75.9	81.7	88.5	96.6	106	118	133	140	

(2) 10X object lens, focus distance from 6.7mm~10.4mm
(0.263~0.409inch)

10X object lens on 24" (Reference data)									
Focus section	1	2	3	4	5	6	7	8	9
Sensor position	1822	1752	1680	1594	1502	1404	1294	1170	1020
WD(mm)	10.4	10.1	9.8	9.5	9.2	8.9	8.6	8.3	8.0
FOV(mm)	2.3	2.2	2.1	2.0	1.9	1.8	1.7	1.6	1.5
Mag. (X)	231	242	253	266	280	295	313	332	354
Focus section	10	11	12	13	14				
Sensor position	860	670	450	186	40				
WD(mm)	7.7	7.4	7.1	6.8	6.7				
FOV(mm)	1.4	1.3	1.2	1.1	1.05				

Mag. (X)	380	409	443	483	506				
----------	-----	-----	-----	-----	-----	--	--	--	--

1.7 Microscope accessory

1.7.1 White balance card

The white side is used to calibrate the white balance. If the object is tiny, place it onto the white balance card and move the card instead of the object.

2. Printed Notice

Please read the following information before operating.

2.1 Maintenance

Please abide by the following rules while storing or using this product:

2.1.1 Keep dry: do not place the product in a humid environment. Dry surroundings help extend the life of the product.

2.1.2 Avoid temperature shock: temperature shock (for example, taking the product into a warm room from a cold environment) will cause internal condensation inside the machine. Please put the device inside the protection bag or handbag to prevent temperature shock, and avoid using the device in an environment with extreme temperatures.

2.1.3 Avoid dropping: the device may malfunction if it encounters strong collision, vibration, or distortion.

2.1.4 Turn the microscope off before cutting off the power supply: do not forced cut off the power supply.

2.1.5 Do not face the lens against strong light or sunshine for extended periods of

time: Strong light rays may degrade sensitive elements and generate white stains on images.

- 2.1.6 Handle the device carefully: do not disassemble cables forcefully and avoid contact with the lens since they are subjected to damage.
- 2.1.7 Make sure to switch the power supply off and unplug the power cable if the device is not in operation for an extended period of time. Store the device in a dry environment with excellent ventilation. Do not expose the machine in an environment lower than -5°C or higher than 50°C.
- 2.1.8 While carrying, put the device inside the box to prevent from being damaged.

2.2 Product Specification

CMOS Sensor	8 million pixels CMOS sensor
Lens	Object lens 4X Object lens 10X (Option)
Magnification	Object lens 4X: 13x~140x;10 Object lens : 231x~506x on 24" monitor
Auxiliary source	White LED × 30pcs
DC Port	Adaptor DC Input
HDMI Port	Mini HDMI Output 1080P(1920*1080 Pixel) image
USB 2.0 Port	Mini USB, UVC and USB disk
SD Port	Micro SD; Support 2G~128G, FAT32 format
Focus control	IR remote control
Power Supplier	Adaptor (Output: DC 5.0V/2.0A Input: AC 100-240V 50/60Hz)

Power Consumption (A/C)	1.8A(Max) /9W
Size	106(L)×106(W)×152(T) mm
Weight	Host weight around 328 grams
Operation Environment	Temperature -5°C ~ 35°C; Humidity-lower than 85% (No Condensation)
For any changes, please visit https://www.aventools.com	

2.3 Safety Instructions

- As an electronic product, please do not use the device in any place in which electronic products are prohibited.
- Keep the device away from water sources to avoid electric shock as it is not waterproof.
- Keep the device away from chemicals or substances with explosive or fire hazards. Switch the device off near gas stations.
- In the case that there are foreign substances or water inside the device, or the device is dropped or damaged, please switch off and remove the power supply to avoid fire and electric shock.
- Do not look steadily into Light sources after switching on the host as it is harmful to your eyes.
- Please use only the product accessories provided in the box for connections. Do not use any outside products without approval of original factory.
- Please remove the power supply from the microscope when not in use.
- Do not disassemble the machine for inspection. For any problems occurring in the machine itself, please power off the device and contact us through e-mail: info@aventools.com

Aven Warranty

Product	
Model no	26700-424
S/L nos.	
Purchase date	DD/MM/YYYY
Purchaser	
Tel no:	
Address	
Email	
Distributor Seal for Confirmation	
(Stamp is necessary for validation of the Warranty)	
※Distributor's seal shall include name of the shop, telephone and address※	

Please ask the distributor to fill in the name of the shop, address, purchase date, and other contents to protect your rights and validate your one-year warranty since upon the purchase date.

Contents of Warranty: The warranty is provided free of charge for faults caused by manufacturing within one year from the purchase date.

Non-warranty:

1. Product appearance parts, such as the outer casing, knobs and LED cover, etc. (charged spare parts are limited to one year after completing the product manufacturing).
2. Consumption goods of the host itself, such as LED lights and lens.
3. Product accessories and fittings, such as the power supplier, HDMI cable, white balance card, remote controller...etc.

Services caused by any of the following situations in the period of the warranty shall not be provided free of charge:

1. Improper use or disassembly, repair or refitting.
2. Any damages to the device caused by external or environmental factors.
3. Discrepancy of product serial number, unfilled or unidentified warranty. Any inspection or repair service after the period of warranty will be charged as follows:
 - (1) Service fees (including transportation fees) of product inspection.
 - (2) Repair fees.
 - (3) Fees of replaced parts



© Aven Inc. All rights reserved.