

Keysight Technologies B1506A Power Device Analyzer for Circuit Design



User's Guide

Notices

Copyright Notice

© Keysight Technologies 2014, 2016

No part of this manual may be reproduced in any form or by any means (including electronic storage and retrieval or translation into a foreign language) without prior agreement and written consent from Keysight Technologies as governed by United States and international copyright laws.

Manual Part Number

B1506-90000

Edition

Edition 1, October 2014

Edition 2, December 2014

Edition 3, January 2016

Printed in:

Printed in Malaysia

Published by:

Keysight Technologies International Japan
G.K.

9-1, Takakura-cho, Hachioji-shi, Tokyo
192-0033 Japan

Technology Licenses

The hardware and/or software described in this document are furnished under a license and may be used or copied only in accordance with the terms of such license.

Declaration of Conformity

Declarations of Conformity for this product and for other Keysight products may be downloaded from the Web.

U.S. Government Rights

The Software is "commercial computer software," as defined by Federal Acquisition Regulation ("FAR") 2.101. Pursuant to FAR 12.212 and 27.405-3 and Department of Defense FAR Supplement ("DFARS") 227.7202, the U.S. government acquires commercial computer software under the same terms by which the software is customarily provided to the public. Accordingly, Keysight provides the Software to U.S. government customers under its standard commercial license, which is embodied in its End User License Agreement (EULA). The license set forth in the EULA represents the exclusive authority by which the U.S. government may use, modify, distribute, or disclose the Software. The EULA and the license set forth therein, does not require or permit, among other things, that Keysight: (1) Furnish technical information related to commercial computer software or commercial computer software documentation that is not customarily provided to the public; or (2) Relinquish to, or otherwise provide, the government rights in excess of these rights customarily provided to the public to use, modify, reproduce, release, perform, display, or disclose commercial computer software or commercial computer software documentation. No additional government requirements beyond those set forth in the EULA shall apply, except to the extent that those terms, rights, or licenses are explicitly required from all providers of commercial computer software pursuant to the FAR and the DFARS and are set forth specifically in writing elsewhere in the EULA. Keysight shall be under no obligation to update, revise or otherwise modify the Software. With respect to any technical data as defined by FAR 2.101, pursuant to FAR 12.211 and 27.404.2 and DFARS 227.7102, the U.S. government acquires no greater than Limited Rights as defined in FAR 27.401 or DFAR 227.7103-5 (c), as applicable in any technical data.

Warranty

THE MATERIAL CONTAINED IN THIS DOCUMENT IS PROVIDED "AS IS," AND IS SUBJECT TO BEING CHANGED, WITHOUT NOTICE, IN FUTURE EDITIONS. FURTHER, TO THE MAXIMUM EXTENT PERMITTED BY APPLICABLE LAW, KEYSIGHT DISCLAIMS ALL WARRANTIES, EITHER EXPRESS OR IMPLIED, WITH REGARD TO THIS MANUAL AND ANY INFORMATION CONTAINED HEREIN, INCLUDING BUT NOT LIMITED TO THE IMPLIED WARRANTIES OF MERCHANTABILITY AND FITNESS FOR A PARTICULAR PURPOSE. KEYSIGHT SHALL NOT BE LIABLE FOR ERRORS OR FOR INCIDENTAL OR CONSEQUENTIAL DAMAGES IN CONNECTION WITH THE FURNISHING, USE, OR PERFORMANCE OF THIS DOCUMENT OR OF ANY INFORMATION CONTAINED HEREIN. SHOULD KEYSIGHT AND THE USER HAVE A SEPARATE WRITTEN AGREEMENT WITH WARRANTY TERMS COVERING THE MATERIAL IN THIS DOCUMENT THAT CONFLICT WITH THESE TERMS, THE WARRANTY TERMS IN THE SEPARATE AGREEMENT SHALL CONTROL.

COMPLIANCE WITH GERMAN NOISE REQUIREMENTS

This is to declare that this product is in conformance with the German Regulation on Noise Declaration for Machines (Lärmangabe nach der Maschinenlärminformation-Verordnung -3.GSGV Deutschland).

- Herstellerbescheinigung
GERÄUSCHEMISSION
Lpa < 70 dB
am Arbeitsplatz
normaler Betrieb
nach DIN 45635 T. 19
- Manufacturer's Declaration
ACOUSTIC NOISE EMISSION
Lpa < 70dB
operator position
normal operation
per ISO 7779

South Korean Class A EMC declaration

This equipment is Class A suitable for professional use and is for use in electromagnetic environments outside of the home.

A급 기기

(업무용 방송통신기자재)

이 기기는 업무용(A급) 전자파적합기기로서 판매자 또는 사용자는 이 점을 주의하시기 바라며, 가정외의 지역에서 사용하는 것을 목적으로 합니다.

WARNING



High Voltage

is used in the operation of this equipment.

LETHAL VOLTAGE on CONTACT

may be present at measurement terminals,
if you fail to take in all safety precautions!

- When the RED indicator lights, lethal voltage (± 3000 V dc/pulse) may appear at measurement terminals.
- Usually use the interlock function.
- Do not operate the instrument unless another person is around the work space who is familiar with instrument operation and hazards or administering first aid.
- Potentials less than ± 500 V may cause death under certain conditions. Therefore, adequate preventive measures must be taken at all times!

FIRST AID FOR ELECTRIC SHOCK

SPECIAL ATTENTION TO RESCUE IN SAFETY

- Never rush into an accidental situation.
- Take special attention to the following notices to prevent second accident.
 - Do NOT touch the CASUALTY or conductive surface with your hands unprotected.
 - Shut off high voltage at once.
 - Disconnect AC mains.
- If it is unsure to make safe, the following procedure will help to protect your lives during the CASUALTY is rescued.
 - Stand on a dry insulating material; use a dry wooden or plastic implement to free the CASUALTY from contact with hazardous electrical source.
 - Ground the circuit to de-energize.

- Free the CASUALTY from the LIVE conductor

CALL EMERGENCY

- Call your local Emergency number immediately, if any of signs or symptoms shown in the following table will be found.

http://en.wikipedia.org/wiki/Emergency_telephone_number#Emergency_numbers

DELAYED SYMPTOMS

- In some cases, electric shock can cause injuries that are not evident and symptoms may be delayed.
- Burns to the CASUALTY may be greater than they appear on the surface.
- For these reasons, all electric shock CASUALTY should be taken to hospital for advanced observation.

<i>English</i>	<i>Deutsch</i>	<i>French</i>	<i>Japanese</i>	<i>Korean</i>	<i>Simplified Chinese</i>	<i>Traditional Chinese</i>
Symptoms	Symptome	Symptômes	兆候	징후	征候	徵候
Cardiac arrest	Herz-Kreislauf-Stillstand	Arestation cardiopulmonaire	心肺停止	심폐 정지	心肺停止	心肺停止
Abnormal cardiac rhythm	Arrhythmia	Arythmie	不整脈	부정맥	脉律不齐	脈律不齊
Respiratory failure (difficult or absent breathing)	Respiratorischer Mißerfolg	Échec respiratoire	呼吸不全	호흡 부전	呼吸不全	呼吸不全
Muscle pain and contractions	Muskelschmerz und Zusammenziehungen	Douleur du muscle et contractions	筋肉痛 / 痙攣	근육통 / 수축	肌肉痛 / 痙攣	肌肉痛 / 痙攣
Seizures (heart beat stopped)	Herzlähmung	Paralysie cardiaque	心臟麻痺	심장 마비	心脏麻痹	心臟麻痺
Numbness and tingling	Eine Taubheit / Stachel	Un engourdissement / Une épine	痺れ / 刺痛	저리다 / 가시痛	发麻 / 刺痛	發麻 / 刺痛
Unconsciousness	Bewusstlosigkeit	Évanouissement	意識不明	의식 불명	意识不明	意識不明
Entrance and exit wound burns	Eine elektrische Schockspur	Une trace du choc électrique	感電跡	감전 자국	触电痕迹	觸電痕跡

First Aid for Electric Shock Procedure

Do not give compression-only CPR to infants and children — all infants and children who have a sudden cardiac arrest need conventional CPR. Also should not be used for adults whose cardiac arrest is from respiratory causes, or for an unwitnessed cardiac arrest.

D	Danger	Check for DANGER, make SAFE first to YOU, Others, and the CASUALTY.	
R	Response	Check for a RESPONSE.	
		Leave on back. If not conscious, <ol style="list-style-type: none"> 1. Ask others to emergency CALL for an ambulance immediately. 2. HELP to bring AED, ASAP. 3. Start CPR by YOU. 	
C	CPR for ADULT only	Start the center of chest compressions (>100 compressions per minute) without stopping until emergency medical services arrive.	
		One of the most famous chest compression-only CPR is AHA Hands-Only CPR which is without mouth-to-mouth rescue breaths.	
		Rhythm of chest compression:	
		Continue CPR until <ul style="list-style-type: none"> ● Signs of life return. ● AED is ready to use. ● Medical services arrive and take over. 	
If YOU have a trained rescue skill, should apply the following step. If not, only keep chest compression until others help.			
A	Airway	No foreign material Leave on back, open airway.	Foreign material Place in the recovery position, clear of objects.
B	Breathing	30 compress & 2 breaths	
D	Defibrillator 	Apply AED with following voice prompts. If no AED available, continue CPR until qualified personnel arrives.	

- ※AED: Automated External Defibrillator
- ※CPR: Cardio Pulmonary Resuscitation
- ※AHA: American Heart Association, Inc.

Safety Summary

The following general safety precautions must be observed during all phases of operation, service, and repair of this instrument. Failure to comply with these precautions or with specific warnings elsewhere in this manual may impair the protections provided by the instrument. In addition, it violates safety standards of design, manufacture, and intended use of the instrument. Keysight Technologies assumes no liability for customer's failure to comply with these requirements.

Product manuals may be provided on CD-ROM or in printed form. Printed manuals are an option for many products. Manuals may also be available on the Web.

NOTE

Do not use this instrument in any manner not specified by the manufacturer. The protective features of this instrument may be impaired if it is used in a manner not specified in the operation instructions.

This instrument is an INDOOR USE product.

This instrument complies with INSTALLATION CATEGORY II for mains input and INSTALLATION CATEGORY I for measurement input terminals, and POLLUTION DEGREE 2 defined in IEC 61010-1.

If an instrument is marked CAT I (IEC Measurement Category I), or it is not marked with a measurement category, its measurement terminals must not be connected to line-voltage mains.

Safety of any system incorporating the equipment is the responsibility of the assembler of the system.

WARNING

Hazardous voltage, instrument maximum output voltage may appear at the measurement terminals (High, Force, Guard, and Sense) if Interlock terminal is closed. Open the Interlock terminal when the measurement terminals are accessible. Voltage applied to the terminals will be limited up to ± 42 V.

Do not work the interlock function intentionally in order to bring the output voltage to the safe level. While the high voltage indicator is lit, the dangerous voltage by the output voltage or the residual charge appears on the measurement terminal.

- *DANGEROUS PROCEDURE WARNINGS*

Warnings, such as WARNING on the previous page, shall be complied. Procedures throughout in this manual prevent you from potentially hazard. Their instructions contained in the warnings must be followed.

- *BEFORE APPLYING POWER*

Verify that all safety precautions are taken. Make all connections to the instrument before applying power. Note the instrument's external markings described under "Safety Symbols".

- *GROUND THE INSTRUMENT*

This is Safety Class I instrument. To minimize shock hazard, the instrument chassis and cabinet must be connected to an electrical ground. The power terminal and the power cable must meet International Electrotechnical Commission (IEC) safety standards.

- *DO NOT OPERATE IN AN EXPLOSIVE ATMOSPHERE*

Do not operate the instrument in the presence of flammable gases or fumes. Operation of any electrical instrument in such an environment constitutes a definite safety hazard.

- *DO NOT REMOVE COVERS*

No operator serviceable parts inside. Refer servicing to qualified personnel. To prevent electrical shock do not remove covers.

- *IN CASE OF DAMAGE*

Instruments that appear damaged or defective should be made inoperative and secured against unintended operation until they can be repaired by qualified service personnel. Return the instrument to a Keysight Technologies sales or service office for services and repair to ensure that safety features are maintained.

- *USE ONLY THE SPECIFIC ACCESSORIES*

Specific accessories satisfy the requirements for specific characteristics for using the instrument. Use the specific accessories, cables, adapters, and so on for safety reasons.

Safety Symbols

The general definitions of safety symbols used on equipment or in manuals are listed below.

 Direct current.

 Alternating current.

 Earth (ground) terminal.

 Protective conductor terminal. For protection against electrical shock in case of a fault. Used with field wiring terminals to indicate the terminal which must be connected to ground before operating equipment.

 Frame or chassis terminal. A connection to the frame (chassis) of the equipment which normally includes all exposed metal structures.

 Grounded terminal which indicates the earth potential.

 On supply.

 Off supply.

 Standby supply. The equipment will be marked with this symbol is not completely disconnected from AC mains when power switch is in the standby position.

 In position of a bi-stable push switch.

 Out position of a bi-stable push switch.

 Hazardous voltage and potential for electrical shock. Do not touch terminals that have this symbol when the equipment is on.

 Hot surface. Avoid contact. Surfaces are hot and may cause personal injury if touched.

 Low temperature or freezing conditions. Avoid contact. Surfaces are cold and may cause personal injury if touched.

 Caution, refer to accompanying documentation. The equipment will be marked with this symbol when it is necessary for the user to refer to the instruction manual.

 Read operator's manual. To indicate that the operator's manual or card should be read before continuing the operation.

CAT I IEC Measurement Category I

CE The CE mark shows that the product complies with all applicable European Directives.



The CSA mark is a registered trademark of the Canadian Standards Association.



The RCM mark is a registered trademark of the Australian Communications Authority. This signifies compliance with the Australian EMC Framework Regulations under the terms of the Radio communications Act.

ICES/NMB-001

This ISM device complies with Canadian ICES-001.
Cet appareil ISM est conforme à la norme NMB-001 du Canada.

ISM GROUP 1 CLASS A

This is the symbol for an Industrial, Scientific and Medical, Group 1 Class A product. (CISPR 11)



Korea's safety and EMC mark



China RoHS - Environmentally Green Product Label



China RoHS - Product with Toxic Substance 40 yr EPUP



The Chinese mark for paper-based packaging materials; Paperboard and Corrugated Fiberboard



Plastic Material Coding Identification

WARNING

A WARNING notice denotes a hazard. It calls attention to an operating procedure, practice, or the like that, if not correctly performed or adhered to, could result in personal injury or death. Do not proceed beyond a WARNING notice until the indicated conditions are fully understood and met.

CAUTION

A CAUTION notice denotes a hazard. It calls attention to an operating procedure, practice, or the like that, if not correctly performed or adhered to, could result in damage to the product or loss of important data. Do not proceed beyond a CAUTION notice until the indicated conditions are fully understood and met.

Power Supply and Measurement Safety

- Power Supply Safety

This instrument can output high currents and voltages. Make sure that the load or device under test can safely handle the output current and voltage. Also, make sure that the connection leads can safely withstand the expected currents and are insulated for the expected voltages.

The instrument outputs may be connected so as to float relative to earth ground. Isolation or floating voltage ratings are indicated on the instrument, near the output terminal or the Circuit Common terminal. There is the danger of electric shock by touching the floated measurement terminals. Keep in mind it to protect yourself. And it is a reason of using the recommended accessories.

- Voltage/Current Measurement Safety

Multimeters and other instruments capable of measuring high voltages and currents are subject to specific safety concerns because of the circuits to which they may be connected. To safely use these instruments, you need to understand the markings on the instrument near the input terminals, which include the Protection Limits and the IEC Measurement Category.

- Protection Limits

Keysight multimeters and other voltage measurement instruments provide protection circuitry to prevent damage to the instrument and to protect against the danger of electric shock, provided the Protection Limits are not exceeded. To ensure safe operation of the instrument, do not exceed the Protection Limits shown on the input terminals.

- Source/Monitor Terminals

Source/monitor unit, SMU, can simultaneously perform DC voltage or current output and measurement. Typical SMU has the Force, Guard, Sense, and Circuit Common terminals as shown below. Normally the Force, Guard, and Sense terminals are the same potential. Voltage marked around the terminals indicates the Protection Limits.

Force and Sense must be connected to a terminal of a device under test for the Kelvin connection which is effective for high current measurement and low resistance measurement. For the non-Kelvin connection to ease the connections, connect Force only. Do not connect Sense. It must be opened.

Guard should be extended to around the device terminal for reducing leakage current caused by a coaxial cable used. Guard must be never connected to anything at the device side.

Circuit Common should be connected to shielding of the coaxial cable used.

The following image is the Kelvin triaxial connector of Medium Power SMU.

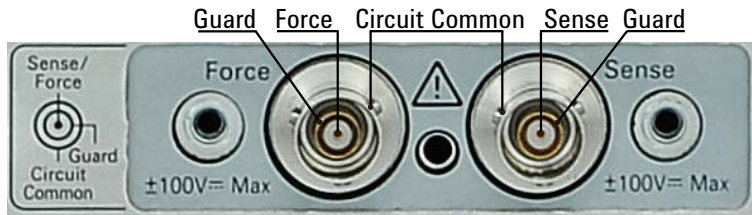

To Avoid Risk of Residual Charge

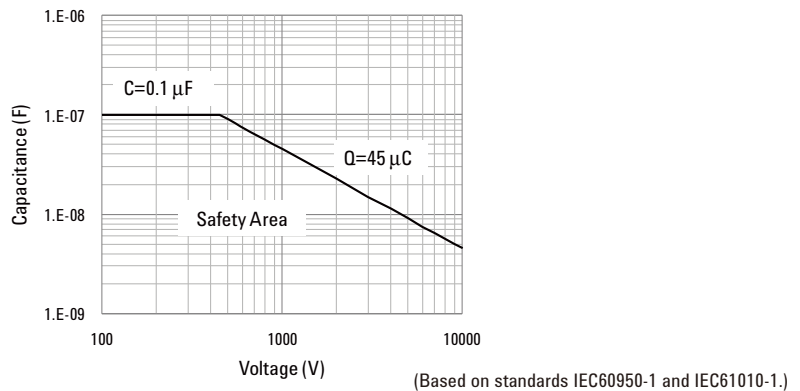

This graph shows the load capacitance vs voltage characteristics generally considered as safety. Use the instrument within the safety area up to 0.1 μF or 45 μC according to the voltage. Also do not connect the capacitive load over the maximum load capacitance specified for the instrument, for example 10 nF for HVSMU.

Before touching the measurement terminal, confirm that it has been discharged enough. For that, ground and discharge the terminals over 10 seconds after stopping the high voltage output, and confirm that they have been safety voltage by using another volt meter.

If abnormal end of measurement, breaking of cable, or device damage occurs, do not touch the terminals until they are discharged enough.

Also if a series resistor is connected, do not touch the terminal until it is discharged enough.



High Voltage Shock Hazard

Keysight B1506A can force dangerous voltages (± 3000 Vdc for HVSMU and ± 100 Vdc for MPSMU) at the High, Force, Guard, and Sense terminals. To prevent electric shock hazard, the following safety precautions must be observed during the use of Keysight B1506A.

- Connect the instrument to an electrical ground (safety ground) by using three-conductor AC power cable.
- Before performing measurement, connect the interlock circuit to the Interlock terminal of this instrument.
- Confirm periodically that the interlock function works normally.
- Before touching the connections of the High, Force, Guard, and Sense terminals, turn the instrument off and discharge any capacitors of the measurement path. If you do not turn the instrument off, complete “all” of the following items, regardless of any instrument settings.
 - Terminate measurement by pressing the Stop key, confirm that the Measurement status indicator is not lit.
 - Confirm that the High Voltage indicator is not lit.
 - Open the Interlock terminal.
 - Discharge any capacitors if the capacitance is connected to an SMU.
- Warn workers in the vicinity of the instrument about hazardous conditions.



Gefahr durch Hochspannung

Von den Geräten Keysight B1506A können Spannungen an den Anschlüssen "High", "Force", "Guard" und "Sense" von bis zu 3000 V ausgehen. Um elektrischem Schlag vorzubeugen, ist bei der Benützung der Geräte Keysight B1506A folgendes zu beachten.

- Verwenden Sie ein dreiphasiges AC-Stromkabel für die Gerätsteckvorrichtung (Eingang) und schließen Sie das Instrument an eine Erdung an (Sicherheitserdung).
- Vor der Messung verbinden Sie den Verriegelungsstromkreis mit dem Interlock-Anschluss dieses Instruments.
- Prüfen Sie in regelmäßigen Abständen, dass die Verriegelungsfunktion ordnungsgemäß funktioniert.
- Bevor Sie die Verbindungen zu den Anschlüssen "High", "Force", "Guard" und "Sense" berühren, schalten Sie das Instrument aus und entladen alle Kondensatoren des Messwegs. Wenn Sie das Instrument nicht ausschalten, führen Sie, unabhängig von den Instrumenteinstellungen, alle folgenden Schritte durch.
 - Beenden Sie die Messung, indem Sie auf die Taste "Stop" drücken. Stellen Sie sicher, dass die Statusanzeige "Measurement" nicht leuchtet.
 - Stellen Sie sicher, dass die Anzeige "High Voltage" nicht leuchtet.
 - Öffnen des Interlock-Anschlusses.
 - Entladen Sie alle Kondensatoren, wenn die Kapazität mit einer SMU verbunden ist.
- Warnen Sie Mitarbeiter in der Umgebung des Instruments vor den Gefahren.



Danger de choc dû à une haute tension

Une tension dangereuse (max. \pm pour HVSMU; 3000 Vdc, max. \pm pour MPSPMU; 100 Vdc) émanant du dispositif Keysight B1506A peut être sortie aux bornes High, Force, Guard et Sense. Les précautions suivantes doivent être observées contre commotion électrique accidentelle.

- Utilisez un câble d'alimentation CA à trois conducteurs vers le coupleur secteur (entrée) et branchez l'instrument sur une mise électrique à la terre (prise de terre de sécurité).
- Avant de procéder aux mesures, connectez le circuit de sécurité à la borne Interlock de l'instrument.
- Vérifiez régulièrement le bon fonctionnement de la fonction de sécurité.
- Avant de toucher les connexions des bornes High, Force, Guard et Sense, mettez l'instrument hors tension et déchargez tout condensateur du chemin de mesure. Si vous ne mettez pas l'instrument hors tension, effectuez « toutes » les opérations ci-dessous, quels que soient les paramètres de l'instrument.
 - Terminez les mesures en appuyant sur la touche Stop ; vérifiez que l'indicateur d'état Measurement est éteint.
 - Vérifiez que le témoin High Voltage est éteint.
 - Ouvrez la borne Interlock.
 - Déchargez les éventuels condensateurs si la capacité est connectée à une unité SMU.
- Informez les personnes travaillant à proximité de l'instrument des conditions.



高電圧感電注意

Keysight B1506A の High、Force、Guard、Sense 端子には、危険電圧が出力されることがあります (HVSMU の場合は最大 ± 3000 Vdc、MPSMU の場合は最大 ± 100 Vdc)。感電事故防止のため、Keysight B1506A の使用時には必ず以下の事柄を守ってください。

- ・ 3 極電源ケーブルを使用して本器を接地してください。
- ・ 測定を開始する前にはインターロック回路を本器の Interlock 端子に接続してください。
- ・ インターロック機能が正常であることを定期的を確認してください。
- ・ High、Force、Guard、Sense 端子に繋がる接続部に触れる前には、本器の電源をオフしてください。また、測定系のキャパシタを放電してください。電源をオフしない場合は、以下の事項を全て実施してください。
 - ・ Stop キーを押して Measurement インジケータが消灯したことを確認してください。
 - ・ 高電圧警告 (High Voltage) インジケータが消灯していることを確認してください。
 - ・ Interlock 端子を開放してください。
 - ・ キャパシタが SMU に接続されているならば、キャパシタを放電してください。
- ・ 周囲のほかの作業者に対しても、高電圧危険に対する注意を徹底してください。

Product Stewardship



- Waste Electrical and Electronic Equipment (WEEE) Directive 2002/96/EC

This product complies with the WEEE Directive (2002/96/EC) marking requirements. The affixed label indicates that you must not discard this electrical/ electronic product in domestic household waste.

Product Category: With reference to the equipment types in the WEEE directive Annex 1, this product is classified as a "Monitoring and Control instrumentation" product.

Do not dispose in domestic household waste.

To return unwanted products, contact your local Keysight office or visit the following website for more information.

<http://about.keysight.com/en/companyinfo/environment/>

- LCD Fluorescent Lamp

Certain products sold by Keysight contain a liquid crystal display (LCD); backlighting for the LCD is provided by a fluorescent lamp which contains mercury, and must be managed, recycled, and/or disposed in accordance with all applicable laws, ordinances and regulations.

Precautionary Statement

Keysight B1506A Power Device Analyzer for Circuit Design operates in the Microsoft Windows environment. Keysight B1506A requires Keysight Easy Test Navigator software, a specially-designed Windows application program.

- About guarantee and support for Keysight B1506A

Keysight Technologies guarantees and supports the performance of Keysight B1506A for the same condition as the preload condition when shipped from the factory.

- About updating Keysight Easy Test Navigator and the Windows Update

Keysight Technologies confirms the operation of Easy Test Navigator patch programs and important Windows security patches, and provides recommended update information. Visit Keysight B1506A support site, download the patches, and perform the software update.

- About Windows application programs and peripherals (including driver)

Using commercial products on Keysight B1506A is your responsibility. Keysight Technologies cannot provide compatibility information for commercial products.

- About servicing

Bench repair service is available at your nearest Keysight Technologies service center. Be aware that the B1506A configuration might be updated to the latest one without notice because of support issues.

The internal hard disk drive (HDD) might be initialized during servicing. If peripherals are connected, they will be removed.

When Keysight B1506A is returned, the internal HDD might be initialized. Peripherals will be returned separately.

- Other notes

- Back up the internal HDD to prevent loss of data by accident or failure.
- Protect Keysight B1506A from computer viruses.
- If you connect Keysight B1506A to the network, take care to protect it from computer virus.

Working in Comfort

To optimize your comfort and productivity, it is important that you set up your work area correctly and use your instrument properly. With that in mind, we have developed some set-up and use recommendations for you to follow based on established ergonomic principles. Improper and prolonged use of keyboards and input devices are among those tasks that have been associated with repetitive strain injury (RSI) to soft tissues in the hands and arms. If you experience discomfort or pain while using the instrument, discontinue use immediately and consult your physician as soon as possible. For more information on RSI you may wish to consult the *About Repetitive Strain Injury* section. Please study the recommendations described below. Included there are references to relevant parts of international standards, regulations and guidelines, such as ISO 9241 and the European Community Display Screen Equipment directive. You may also wish to consult your employer's human resources department or other relevant departments for guidance specific to your company.

About Repetitive Strain Injury

Because your comfort and safety are our primary concern, we strongly recommend that you use the instrument in accordance with established ergonomic principles and recommendations. Scientific literature suggests that there may be a relationship between injury to soft tissues -especially in the hands and arms- and prolonged improper use of keyboards or other equipment requiring repeated motions of the hands and forearms. This literature also suggests that there are many other risk factors that may increase the chance of such injury, commonly called Repetitive Strain Injury.

What is RSI?

Repetitive Strain Injury (RSI -also known as cumulative trauma disorder or repetitive motion injury) is a type of injury where soft tissues in the body, such as muscles, nerves, or tendons, become irritated or inflamed. RSI has been a reported problem for those who perform repetitive tasks such as assembly line work, meatpacking, sewing, playing musical instruments, and computer work. RSI also has been observed in those who frequently engage in activities such as carpentry, knitting, housework, gardening, tennis, windsurfing and lifting children.

What causes RSI?

The specific causes of RSI have not been established. Nevertheless, the incidence of RSI has been associated with a variety of risk factors, including:

- Too many uninterrupted repetitions of an activity or motion.
- Performing an activity in an awkward or unnatural posture.

- Maintaining static posture for prolonged periods.
- Failing to take frequent short breaks.
- Other environmental and psychosocial factors.

In addition, there have been reports associating the occurrence of RSI with the use of keyboards, mice, and other input devices. Also, certain medical conditions, such as rheumatoid arthritis, obesity and diabetes, may predispose some people to this type of injury.

What if I experience discomfort?

If you are experiencing any discomfort, seek professional medical advice immediately. Typically, the earlier a problem is diagnosed and treated, the easier it is to resolve.

Mice and Other Input Devices

Various aspects of using mice and other input devices may increase your risk of discomfort or injury. Observing the following recommendations may reduce that risk.

- Try to keep your hand, wrist, and forearm in a neutral position while using your mouse or other input device.
- If you use your thumb to rotate the ball on a trackball or spaceball, keep it in a relaxed, natural shape, and maintain a neutral posture in your hand, wrist, and forearm.
- Hold the mouse gently by draping your fingers over it. Keep your hand relaxed and fingers loose. Do not grip the mouse tightly.
- It takes very little pressure or force from your fingers to activate the buttons or scroll wheel on your mouse, scrolling mouse, trackball, or other input device. Using too much force can place unnecessary stress on the tendons and muscles in your hands, wrists, and forearms.
- If you are using a scrolling mouse, be sure to keep your fingers and hand in a relaxed, neutral position when activating the scroll wheel. Also, this type of mouse features software that can minimize the number of mouse movements or button clicks.
- When using a mouse, trackball, or other input device, position it as close to the keyboard as possible, and keep it at the same level as you do not have to stretch while using it.
- Be sure to keep your mouse and trackball clean. Regular removal of accumulated dust and dirt helps ensure proper tracking and reduces unnecessary hand and wrist motions.

For more information, see “Working in Comfort” located at http://about.keysight.com/en/quality/Keysight_Ergonomic_Information.pdf.

In This Manual

This manual describes the product overview, installation information, measurement operation, and software reference information of Keysight Technologies B1506A.

This manual consists of the following chapters:

1. “Introduction”

This chapter describes basic features of Keysight B1506A.

2. “Installation”

This chapter describes installation and maintenance.

3. “How To Perform Measurement”

This chapter explains how to perform measurement by using Keysight B1506A.

4. “GUI Reference”

This chapter provides the reference information of Keysight Easy Test Navigator software.

NOTE

For the specifications of the B1506A, see Data Sheet.

NOTE

The information is subject to change without notice due to the future enhancement.

The actual screen image on the B1506A may be different from the image shown in this manual.

Contents

1. Introduction

Overview	1-3
Mainframe	1-4
Test Fixture	1-5
Mainframe Front View	1-6
⚠ Mainframe Rear View	1-9
⚠ Test Fixture Front View	1-14
⚠ Measurement Terminals	1-16
⚠ Test Fixture Rear View	1-18
Software	1-20
Easy Test Navigator Software	1-20
EasyEXPERT Software	1-21
Utility Software	1-21
Accessories	1-23
Options	1-25
Measurement Resources	1-26
GNDU - Ground Unit	1-26
About SMU	1-27
MPSMU - Medium Power SMU	1-28
HVSMU - High Voltage SMU	1-31
MCSMU - Medium Current SMU	1-33
HCSMU - High Current SMU	1-35
UHCU - Ultra High Current Unit	1-37
MFCMU - Multi Frequency CMU	1-39

2. Installation

⚠	2-2
Requirements	2-4

Contents

Power Requirements	2-4
Operating Environment	2-4
Storing/Shipping Environment	2-4
⚠ Installation Requirements	2-5
⚠ Power Cable	2-6
Inspection and Installation	2-8
To Inspect Shipment	2-8
To Perform Initial Setup	2-9
⚠ To Connect Test Fixture	2-11
To Check Operation of Test Fixture	2-16
To Change Windows Logon Setting	2-16
To Change GPIB Address	2-17
To Enable System Controller	2-18
⚠ Connecting Accessories	2-19
⚠ 3-pin Inline Package Socket Module	2-20
⚠ Curve Tracer Test Adapter Socket Module	2-21
⚠ Universal Socket Module Kit	2-22
⚠ Gate Charge Socket Adapter	2-25
⚠ Accessories for Connecting a DUT	2-29
⚠ Prober System Cable	2-31
Thermocouple	2-33
Thermal Plate	2-34
⚠ Thermostream	2-34
Maintenance	2-37
Cleaning	2-37
⚠ Self-test and Diagnosis	2-37
Calibration	2-37
Before Shipping to Service Center	2-38
To Make Backup	2-38
To Check Module Slots	2-38

Contents

⚠ To Collect Equipment and Accessories	2-38
--	------

3. How To Perform Measurement

How To Perform Datasheet Characterization	3-3
Preparing Measurement	3-4
Executing Measurement	3-5
How To Perform I/V Measurement	3-13
Preparing Measurement	3-14
Executing Measurement	3-15
Monitoring Voltage/Current Waveforms	3-21
Setting Parameter	3-23
How To Perform Capacitance Measurement	3-25
Preparing Measurement	3-26
Executing Measurement	3-27
Setting Parameters	3-30
How To Perform Gate Charge Measurement	3-32
Preparing Measurement	3-33
Executing Measurement	3-34
How To Calculate Power Loss	3-40
Calculating Power Loss	3-42
Extracted Parameters By Power Loss Calculation	3-49
How To Monitor/Control Temperature Under Measurement	3-51
Preparing the Measurement	3-51
Thermal Monitor/Control During Measurement	3-52
Displaying and Operating Graph	3-57
How To Select and Display Characteristics Curve	3-57
How To Use the Marker	3-59

4. GUI Reference

Contents

Software Palette	4-3
Datasheet Characterization Software	4-5
GUI Overview	4-6
Work Area	4-7
Automatic Data Save	4-16
Toolbar	4-18
Main Menu	4-23
Dialog Boxes	4-29
Summary of Files	4-36
Parameters Defined in Furnished Templates	4-39
Creating Custom File	4-54
I/V Measurement Software	4-56
GUI Overview	4-57
Work Area	4-58
Automatic Data Save	4-82
Toolbar	4-83
Main Menu	4-85
Dialog Boxes	4-87
Summary of Files	4-88
Capacitance Measurement Software	4-90
GUI Overview	4-91
Work Area	4-92
Automatic Data Save	4-108
Toolbar	4-109
Main Menu	4-111
Dialog Boxes	4-113
Summary of Files	4-116
Gate Charge Measurement Software	4-118
GUI Overview	4-119
Work Area	4-120

Contents

Automatic Data Save	4-132
Toolbar	4-133
Main Menu	4-135
Dialog Boxes	4-137
Summary of Files	4-140
Power Loss Calculation Software	4-142
GUI Overview	4-143
Work Area	4-144
Automatic Data Save	4-155
Toolbar	4-156
Main Menu	4-158
Dialog Boxes	4-160
Summary of Files	4-161
Thermal Monitor/Control Software	4-163
Monitor Mode GUI	4-164
Control Mode GUI	4-166
Executing Measurement in Synchronization with Thermo-trigger List	4-179
Dialog Boxes	4-181
Summary of Files	4-182
Common GUI Components	4-183
Module Configuration Dialog Box	4-183

Contents

1

Introduction

Introduction

This chapter describes the basic functions and features of Keysight B1506A Power Device Analyzer for Circuit Design, and consists of the following sections.

- “Overview”
- “Mainframe Front View”
- “Mainframe Rear View”
- “Test Fixture Front View”
- “Test Fixture Rear View”
- “Software”
- “Accessories”
- “Options”
- “Measurement Resources”

Overview

Keysight B1506A Power Device Analyzer for Circuit Design is a complete solution that can help power electronic circuit designers maximize the value of their power electronics products by enabling them to select the correct power devices for their applications. It can evaluate all relevant device parameters under a wide range of operating conditions, including IV parameters such as breakdown voltage and on-resistance, as well as three terminal FET capacitances, gate charge and power loss. The B1506A has a wide range of capabilities that help it identify substandard devices under actual circuit operating conditions, including a wide voltage and current range (3 kV and 1500 A), a wide temperature measurement range ($-50\text{ }^{\circ}\text{C}$ to $+250\text{ }^{\circ}\text{C}$), fast pulsing capability, and sub-nA level current measurement capability. Its unique software interface presents the user with a familiar device data sheet format that makes it easy to characterize devices without going through any formal training. Integrated switching circuitry within the test fixture supports fully automated testing, with the ability to automatically change between both high voltage and high current testing as well as between IV and CV measurements. In addition, a unique plug-in style device test fixture socket adapter eliminates cable connection and other human-related errors. The B1506A also supports the complete automation of thermal characterization. This can be accomplished either through the integrated Thermostream control or via the Thermal Plate. Since the DUT is in close proximity to the B1506A's measurement resources, the large parasitics caused by cable extensions leading to a temperature chamber do not exist. For this reason, oscillation free ultra-high currents of up to 1500 A can be accurately evaluated at both low and high temperature.



Keysight B1506A provides the following packages.

- B1506A-H20: 20 A/3 kV IV Package
- B1506A-H50: 500 A/3 kV IV Package
- B1506A-H70: 1500 A/3 kV IV Package
- B1506A-H21: 20 A/3 kV IV/CV/Gate Charge Package
- B1506A-H51: 500 A/3 kV IV/CV/Gate Charge Package
- B1506A-H71: 1500 A/3 kV IV/CV/Gate Charge Package

Each package contains the mainframe, the test fixture, the connection cables, and the control software. For the furnished accessories, see Table 1-1.

Mainframe

Mainframe is equipped with the measurement resources listed below, the 15-inch touch screen LCD panel, hard disk drive, DVD drive, USB, LAN, GPIB, GPIO interfaces, and so on. For more information on the measurement resources, see “Measurement Resources” on page 1-26.

- HVSMU, high voltage source/monitor unit, 1 ea.
- HCSMU, high current source/monitor unit, 1 ea. for the B1506A-H20/H21
- MCSMU, medium current source/monitor unit, 1 ea. for the B1506A-H20, 2 ea. for H21, 3 ea. for H50/H70, 4 ea. for H51/H71
- MFCMU, multi frequency capacitance measurement unit, 1 ea. for the B1506A-H21/H51/H71
- MPSMU, medium power source/monitor unit, 1 ea.
- GNDU, ground unit, 1 ea.

The B1506A provides an intuitive graphical user interface, touch screen LCD, stylus pen, USB keyboard, and USB mouse for easy and effective measurement and analysis on the Windows environment, and supports the B1506A measurement control software listed below. For more information, see “Software” on page 1-20.

- Easy Test Navigator software
- EasyEXPERT software

Test Fixture

The test fixture is required to connect your device under test (DUT). The following furnished accessories are available.

- Socket module for connecting a 3-pin inline package device
- Socket module for connecting a curve tracer test adapter
- Universal socket module kit for connecting variety of packaged devices.
- Accessories for connecting other type of device
 - Blank silicon plate
 - Connection wire
 - Clip
 - Banana pin adapter
- Socket adapter for performing gate charge measurement, for the B1506A-H21/H51/H71
- Thermocouple for performing temperature measurement

The test fixture initially installs the selector for switching the measurement resource connected to the collector/drain terminal of the DUT. The measurement resource will be the MFCMU, the HVSMU, the MPSMU, the HCSCMU, or the ultra high current unit (UHCU). Available resources depend on the package (option).

The B1506A-H50/H51/H70/H71 configures the UHCU by using the test fixture and two MCSMU installed in the mainframe. The B1506A-H50/H51 supports up to 500 A and the B1506A-H70/H71 supports up to 1500 A.

Additionally, for controlling temperature of DUT, the test fixture can be equipped with Thermal Plate inside the fixture cover or Thermostream by using the B1506A-T01 Thermal Test Enclosure.

For the Thermal Plate and the Thermostream, contact inTEST Corporation.

NOTE

Selector may emit a noise sound during operation. However it is not abnormal status.

Mainframe Front View

This section describes the front view of the mainframe.

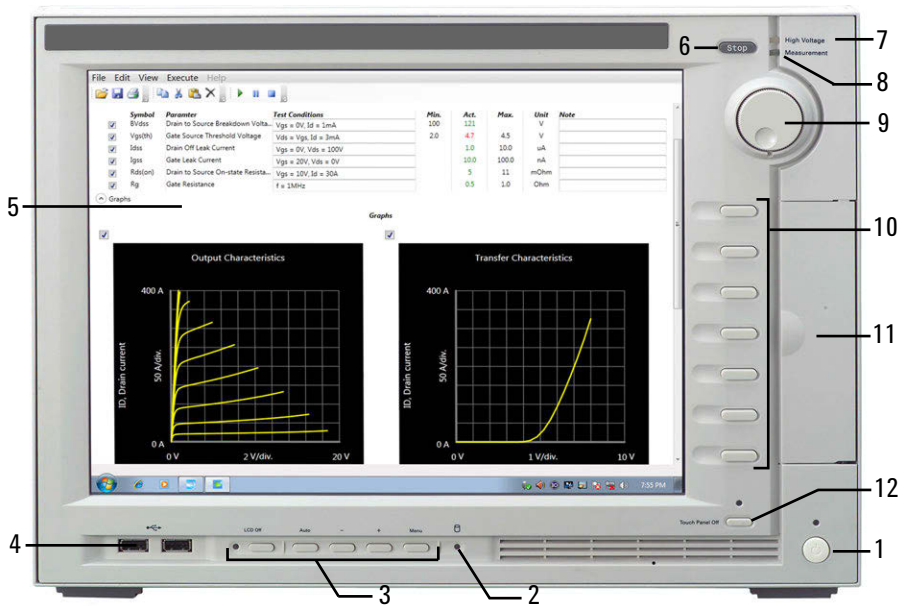

1. Standby switch

Turns on/off the mainframe. Pressing the button in the ON state makes it in the standby state. The green LED lights when it is in the ON state.

NOTE

Opening measurement terminals

Open the measurement terminals at the device side when turning the B1506A on. Also disconnect the device from the measurement terminals and open the measurement terminals after the measurement. If you leave the connection with the device, the device may be damaged by unexpected operations or charge-up of measurement cables.

2. HDD access indicator

This green LED lights in the access status of HDD or DVD drive. Do not turn the instrument off during this LED lights.

3. LCD adjustment keys

LCD Off enables or disables the LCD panel. The green LED lights when the LCD is disabled.

Four keys are available for adjusting brightness. Use + and - to adjust it and then press *Set* to fix it. Pressing *Cancel* instead of *Set* cancels the adjustment.

4. USB interfaces

USB, 2 ports. For keyboard, mouse, and so on.

To remove USB devices from the instrument, use “Safely Remove Hardware” on Windows taskbar. If it is not used, the instrument may cause the internal USB communication error. If the error occurs, turn the instrument off and disconnect the power cable from it. Leave it about 30 seconds before rebooting it, and connect the power cable again, and then turn the instrument on.

5. LCD panel

15 inch TFT XGA display, 1024 × 768 resolution. Displays the Windows screen, the B1506A measurement control software, and so on. Touch screen operation is available when the Touch Panel Off indicator does not light.

To adjust the touch panel, use Microchip TSHARC Control Panel which is opened by selecting *Microchip TSHARC Control Panel* from the Start menu.

6. Stop key

Stops the present measurement or source output immediately.

7. High voltage status indicator

This red LED lights when a source channel applies dangerous voltage.

8. Measurement status indicator

This green LED lights when a measurement channel performs measurement.

9. Rotary knob

Works on the execution environment of the B1506A measurement control software. Rotating the knob moves the marker on the graph, or increases/decreases/changes the value in the active entry field. Pressing the knob sets or enters the value.

10. Softkeys

Seven softkeys are available for the B1506A measurement control software. Used to select an alternative for the entry field specified or the dialog box.

11. DVD-R drive

For data backup, software update, and so on.

12. Touch Panel Off key

Works on the execution environment of the B1506A measurement control software. Enables or disables the touch screen operation. The green LED lights when the touch screen is disabled.

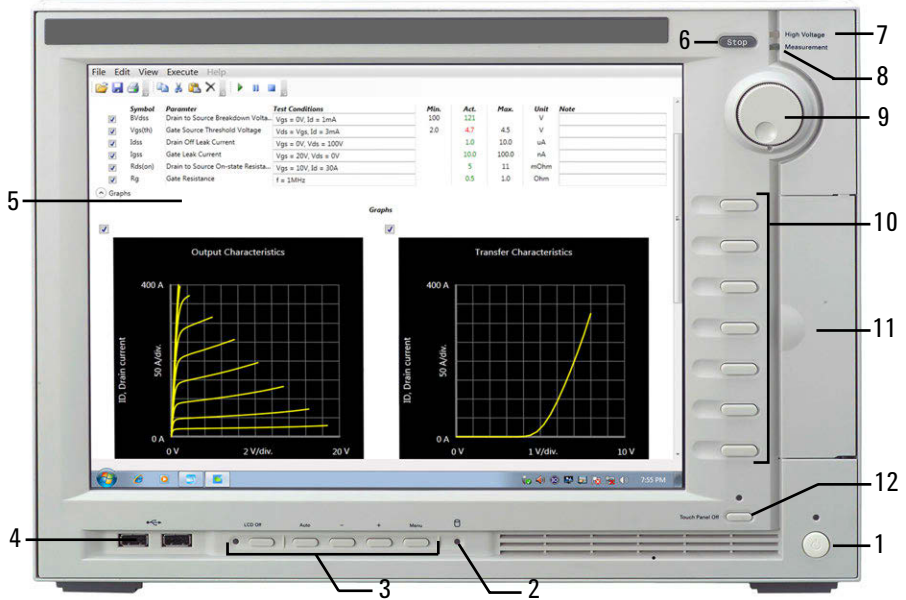

Mainframe Rear View

This section describes the rear view of the mainframe.

WARNING



To avoid electrical shock and instrument damage, turn the all instruments off before connecting or disconnecting measurement cable.

Mettez la machine hors tension pour fixer le connecteur ou pour retirer le connecteur de l'unité centrale.

WARNING



There are potentially hazardous voltages (± 3000 Vdc for HVSMU and ± 100 Vdc for MPSMU) present at the High, Force, Sense, and Guard terminals of the instruments. To prevent electrical shock, the following safety precautions must be observed during the use of instruments.

- **Connect the instrument to an electrical ground (safety ground) by using three-conductor AC power cable.**
- **Connect the mainframe Interlock terminal to the test fixture Interlock terminal by using an interlock cable.**
- **Confirm periodically that the interlock function works normally.**
- **Before touching the connections on the High, High Force, High Sense, and Guard terminals in the test fixture, turn the instruments off and discharge any capacitors. If you do *not* turn the instruments off, complete *all* of the following items, regardless of the instrument settings.**
 - **Press the front panel Stop key to set the source output off.**
 - **Confirm that the front panel High Voltage indicator is not lit.**
 - **Open the Interlock terminal (open the fixture cover).**
 - **Discharge any capacitors connected to a measurement resource.**
- **Warn persons working around the instruments about dangerous conditions.**

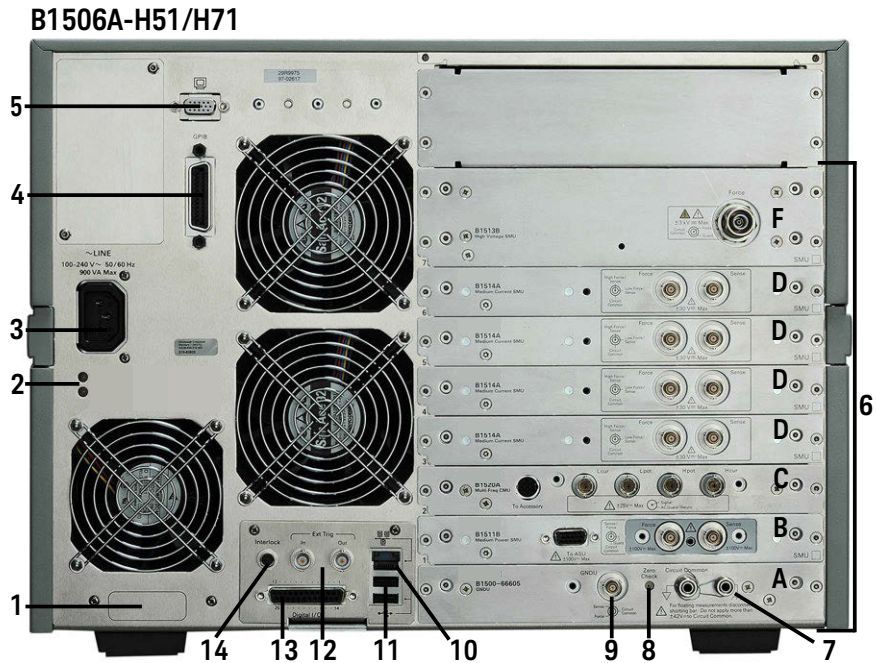

1. Serial number

You need this *serial number* when using Keysight Technologies telephone assistance program.

2. LED status indicator

For troubleshooting. Followings are some examples.

- Both LEDs turn off:
The instrument is in the standby state and Standby switch is OFF position.
- One LED turns green:
Power supply works normally.
- Both LEDs turn orange:
The instrument is in the standby state and Standby switch is ON position.

3. LINE input receptacle

AC power cable is connected to this receptacle.

4. GPIB interface

For the GPIB connection of this instrument, use an GPIB interface, Keysight 82350B (for PCI bus), Keysight 82357A/B (USB/GPIB), or National Instrument GPIB-USB-HS.



For using an USB/GPIB interface, it is recommended to set the GPIB address of this instrument to an even number. The USB/GPIB interface might cause serial poll error intermittently due to the intrinsic communication scheme differences. It is reported that using an even GPIB address sometimes significantly decreases the chance of the error.

5. Video output terminal

VGA connector. For an external display. Signal to the built-in LCD is also applied to this terminal.

6. Measurement Resources

See A to F described later.

 7. Circuit Common () and frame ground () terminals

Normally, connect the terminals together by using the shorting bar. For floating measurement, remove the shorting bar.

WARNING



If the Circuit Common terminal is *not* connected to the frame ground terminal (for floating measurement), a potential shock hazard may present. Do not touch any of measurement circuit at any time while a floating measurement is in progress.

Si la borne Circuit Common *n'est pas* connectée à la borne de terre du cadre (pour des mesures de flotte), il peut y avoir un risque de choc électrique. Ne touchez aucun circuit de mesure à n'importe quel moment quand la mesure de flotte est en cours.

CAUTION

For floating measurement, do not apply dangerous voltage to the Circuit Common terminal. Failure to heed this caution may result in damage to the instrument.

8. Zero Check terminal

Ground reference point of the instrument.

CAUTION

The Zero Check terminal can be used for the service purpose only. For the normal operation, leave this terminal open and do not connect anything to this terminal. Connecting anything can damage the instrument.

9. GNDU terminal

0 V constant voltage source. Used for the reference of measurement ground.
Triaxial connector.

10. LAN interface

RJ45 connector.

11. USB interfaces

USB, 2 ports. For keyboard, mouse, or peripherals.

To remove USB devices from the instrument, use “Safely Remove Hardware” on Windows taskbar. If it is not used, the instrument may cause the internal USB communication error.

If the error occurs, turn the instrument off and disconnect the power cable from it. Leave it about 30 seconds before rebooting it, and connect the power cable again, and then turn the instrument on.

12. Ext Trig terminals

Two BNC connectors, one for trigger input, and one for trigger output. For details about the trigger function, see *Programming Guide*.

13. Digital I/O terminal

Used to connect the test fixture.

 14. Interlock terminal

Used to connect the test fixture. If the fixture cover is open, maximum output is limited to ± 42 V.

To verify the interlock function, perform the Interlock Open/Close test on the Main Frame tab screen of the EasyEXPERT Configuration window.

WARNING



Dangerous voltage, instrument maximum output voltage may appear at High, Force, Sense, and Guard terminals if the fixture cover is closed.

Une tension dangereuse, une tension de sortie maximale de l'appareil peut apparaître aux bornes High, Force, Guard et Sense si la borne Interlock est fermée.



A. GNDU/ADC

Ground unit (GNDU) and A/D converter.



B. MPSMU

Medium power source/monitor unit (MPSMU) has two triaxial connectors, force and sense, for the Kelvin connections.

- ⚠ C. MFCMU for B1506A-H21/H51/H71
Multi frequency capacitance measurement unit (MFCMU) has four coaxial connectors, Lcur, Lpot, Hpot, and Hcur, for the four-terminal pair connection.

CAUTION

Do not apply voltage more than ± 25 V to the MFCMU input terminals. Failure to heed this caution may result in damage to the MFCMU.

- ⚠ D. MCSMU
Medium current source/monitor unit (MCSMU) has two triaxial connectors, force and sense, for the Kelvin connections.
- ⚠ E. HCSMU for B1506A-H20/H21
High current source/monitor unit (HCSMU) has the force coaxial connector and the sense triaxial connector, for the Kelvin connections.
- ⚠ F. HVSMU
High voltage source/monitor unit (HVSMU) has the force connector.

B1506A-H21



Test Fixture Front View

This section describes the front view of the test fixture.

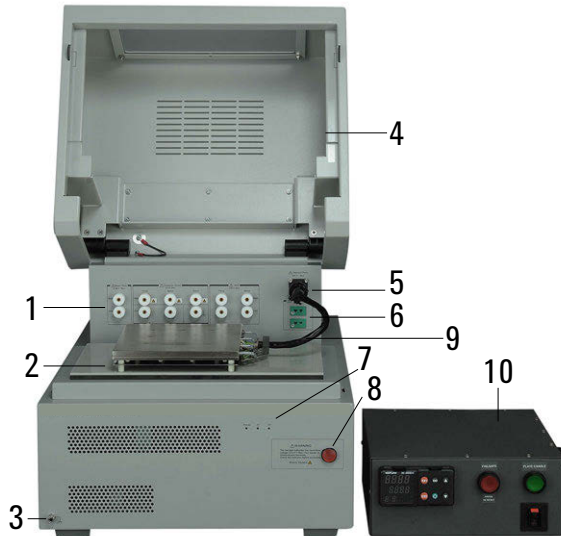

1. Measurement terminals

Connects the connection wire or attaches the socket module/adapter for connecting your device under test (DUT). For more information, see “Measurement Terminals” on page 1-16.

2. DUT stage

In the above picture, the Blank Silicon Plate is set on the stage, and the Thermal Plate is placed on the Blank Silicon Plate. For the Thermal Plate, contact inTEST Corporation.

3. Terminal for connecting wrist strap

4. Fixture cover

The fixture cover should be closed to avoid electrical shock by touching measurement terminals and to prevent a device under test from external noise.

When the fixture cover is open, maximum output voltage is limited to ± 42 V.

WARNING

Hazardous voltage, instrument maximum output voltage may appear at the High, High Force, High Sense, and Guard terminals if the fixture cover is closed.

WARNING



Make sure that the cover is closed properly before starting measurement. Do not perform the measurement when a wire is protruding from the fixture cover.

Assurez-vous que le couvercle est fermé correctement avant de commencer la mesure. Ne pas effectuer la mesure lorsqu'un câble dépasse du couvercle de l'appareil.



5. Thermal Plate connector

This connector is used to connect the cable from the Thermal Plate. For the Thermal Plate, contact inTEST Corporation.



6. Thermocouple terminals

For connecting thermocouple to measure temperature around a DUT. Temperature range is $-50\text{ }^{\circ}\text{C}$ to $250\text{ }^{\circ}\text{C}$.

7. Status indicator

Power LED turns yellow when the AC power is applied to the test fixture.

Power LED turns green when the test fixture is ready to use.

IV LED lights when the B1506A is in the IV measurement condition.

CV LED lights when the B1506A is in the capacitance measurement condition.



8. Hazardous voltage status indicator

This red LED lights when a measurement resource applies dangerous voltage. This indicator is connected to the mainframe via the Interlock terminal and works with the High Voltage indicator on the mainframe front panel.

Warning labels written in French, German, and Japanese are furnished. Attach the label to the front panel of the fixture if you need.

WARNING



The red light indicates that hazardous voltage (maximum $\pm 3000\text{ Vdc}$) may appear at measurement terminals. Check this indicator before accessing.

Le témoin rouge indique qu'une tension dangereuse ($\pm 3000\text{ V Max}$) risque d'apparaître au niveau des bornes de mesure. Vérifiez cet indicateur avant d'accéder.

9. Thermal Plate

Contact inTEST Corporation.

10. Temperature controller of Thermal Plate

Contact inTEST Corporation.

Measurement Terminals

WARNING

Set the instrument output off before connecting or disconnecting connection wire.

Press the mainframe front panel Stop key to set the source output off. And confirm that the mainframe front panel High Voltage indicator is not lit.

WARNING



To prevent electrical shock and DUT damage, do not connect or disconnect the DUT while the instrument is applying voltage or current.

When you touch the DUT after measurement, devise a countermeasure of residual charge and heat to prevent electrical shock and burn. Use glove and any tool. Also have enough time for discharge and radiation.

Pour éviter toute électrocution et tout risque d'endommagement de l'appareil, ne retirez pas les câbles pendant le fonctionnement.

Lorsque vous touchez le MST après la mesure, élaborer une contre-mesure de la charge résiduelle et du chauffage afin d'éviter tout choc électrique et toute brûlure. Utilisez des gants et des outils. Prévoyez également du temps pour la décharge et la radiation.

CAUTION

Never connect the High, High Force, High Sense, or Guard terminal to any output, including circuit common and chassis ground. Connecting other output may damage the connected one.

NOTE

To use the 3-pin Inline Package Socket Module or the Curve Tracer Test Adapter Socket Module, attach it to the Base/Gate, Collector/Drain, and Emitter/Source terminals. Then do not use the Guard terminal.

NOTE

To use the Gate Charge Socket Adapter, attach it to the Base/Gate, Collector/Drain, Emitter/Source, and AUX Force terminals. Then do not use the AUX Sense.

If you do not use the socket module or the Gate Charge Socket Adapter, connect your device under test (DUT) to the terminals by using connection wire, clip, adapter, and so on. Then set the Blank Silicon Plate on the DUT stage.

1. Base/Gate High and Low terminals
Connect High to the gate or base terminal of DUT.
Connect Low to the source or emitter terminal of DUT.
2. Collector/Drain High Force and Sense terminals
Connect Force and Sense to the drain or collector terminal of DUT.
Force and Sense must be connected together at the terminal of DUT for making the Kelvin connection.
3. Collector/Drain Guard terminal
Guard of Collector/Drain High. The guard has the same potential as the Collector/Drain High. You may extend the guard as close as possible to the drain or collector terminal of DUT to reduce the leakage current caused by the cable. Open the guard at the end of the cable. Never connect it to anything.
4. Emitter/Source Low Force and Sense terminals
Connect Force and Sense to the source or emitter terminal of DUT.
Force and Sense must be connected together at the terminal of DUT for making the Kelvin connection.
5. Chassis common terminal
Use for grounding or shielding.
6. AUX High Force and Sense terminals and Low Force and Sense terminals
Output terminals internally connected to the AUX input connectors. The measurement resource is the SMU3 (MCSMU) installed in the mainframe.
Connect High Force and Sense to the high terminal of DUT.
Connect Low Force and Sense to the low terminal of DUT.
Force and Sense must be connected together at the terminal of DUT for making the Kelvin connection.

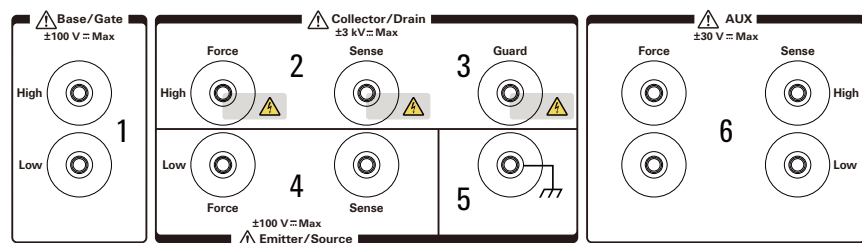

Test Fixture Rear View

WARNING



To avoid electrical shock and instrument damage, turn the all instruments off before connecting or disconnecting measurement cable.

Mettez la machine hors tension pour fixer le connecteur ou pour retirer le connecteur de l'unité centrale.

This section describes the rear view of the test fixture. For connecting the cables, see “To Connect Test Fixture” on page 2-11.



1. Power switch
Turns on/off the test fixture.
2. LINE input receptacle
AC power cable is connected to this receptacle.
3. Option number label
4. Serial number label
You need this *serial number* when using Keysight Technologies telephone assistance program.



5. Connectors for connecting the system cable

The following measurement resources in the mainframe are connected by using the system cable.

- HVSMU
- HCSMU for B1506A-H20/H21
- MCSMU
- MPSMU
- GNDU

-  6. Connectors for connecting the CMU cable, for B1506A-H21/H51/H71

The connectors are used to connect the CMU cable from the MFCMU in the mainframe.

7. Digital I/O terminal

This terminal is used to connect the Digital I/O cable from the mainframe Digital I/O terminal.

-  8. Earth terminal

Screw terminal for earthing.

WARNING



Connect a wire from an electrical ground (safety ground) to this terminal.

Connecter un fil depuis une mise à la terre électrique (mise à la terre de sécurité) à la borne de terre.

-  9. Interlock terminal

This terminal is used to connect the interlock cable from the mainframe Interlock terminal. The interlock cable is included in the system cable.

WARNING

Potentially hazardous voltage may be present at the High, Force, Sense, and Guard terminals when the interlock terminals are shorted on test fixture, probe station, and such.

-  10. Thermal Plate connector

This connector is used to connect the cable from the temperature controller of the Thermal Plate. For the Thermal Plate, contact inTEST Corporation.

Software

Keysight B1506A realizes easy and effective measurement and analysis on the Windows environment using an intuitive graphical user interface, touch screen LCD, stylus pen, keyboard, and mouse. The following software is previously installed or stored in the mainframe.

- “Easy Test Navigator Software”
- “EasyEXPERT Software”
- “Utility Software”

Easy Test Navigator Software

The Easy Test Navigator software provides measurement control software for power device characterization. It supports various types of measurement task with ease-of-use and simple operation. Some of the functions are listed below. For more information on the Easy Test Navigator software, see Chapters 3 and 4.

- Software included:
 - Datasheet characterization software
 - I/V measurement software
 - Capacitance measurement software, for B1506A-H21/H51/H71
 - Gate charge measurement software, for B1506A-H21/H51/H71
 - Power loss calculation software, for B1506A-H21/H51/H71
 - Thermal monitor/control software
- Ready-to-use measurement templates for typical power device characteristics measurements
- Ability to automatically accumulate measurement data on the HDD in exportable formats
- Oscilloscope view for a pulsed sweep measurement point

EasyEXPERT Software

The EasyEXPERT software is an application program for controlling Keysight B1500 series. Some of the functions are listed below. For more information, see Keysight EasyEXPERT *User's Guide*.

- Single measurement, repeat measurement, and append measurement
- Module selector control
- Measurement/setup data management by workspace
- Graph display and analysis with markers, cursors, and lines; and auto analysis
- Data import/export capability, data output by CSV/XML format, and graph output by EMF/BMP/GIF/PNG format
- Maintenance; self-test and self-calibration
- Remote control function from an external computer

The EasyEXPERT has the following measurement execution environments.

- Application test
- Classic test
- Tracer test
- Quick test

NOTE

Application Library

The EasyEXPERT contains an application library that is a set of test definitions. The application test can be performed by selecting a test definition and setting the test condition for the actual DUT (device under test).

All test definitions are just sample. If the samples damage your devices, Keysight Technologies is NOT LIABLE for the damage.

Utility Software

Followings are the utility software available for the B1506A. For more information on the utility software, see Keysight EasyEXPERT *User's Guide*.

- EasyEXPERT for PC software
EasyEXPERT software runs on an external Windows PC.

- 4155/4156 setup file converter

Program for converting the 4155/4156 measurement setup files (file extension MES or DAT) into EasyEXPERT classic test setup files. This program is stored in the following folder.

<program folder>\Agilent\B1500\EasyEXPERT\415xC\Conversion\

- MDM file converter

Program for converting EasyEXPERT data files (file extension XTR or ZTR) into Keysight IC-CAP MDM files. This program is stored in the following folder.

<program folder>\Agilent\B1500\EasyEXPERT\IC-CAP Support\MDM\

- Prober control programs

Execution files for controlling the probers listed below. The files are stored in the following folder.

<program folder>\Agilent\B1500\EasyEXPERT\Utilities\

Probers supported:

- Cascade Microtech Summit 12K or S300
- SUSS MicroTec PA200 or PA300
- Vector Semiconductor VX-2000 or VX-3000

- sleep.exe program

Execution file for inserting a wait time in the test execution flow of an EasyEXPERT application test. This file is stored in the following folder.

<program folder>\Agilent\B1500\EasyEXPERT\Utilities\

NOTE**Notations**

<program folder> is as follows. Then, <system drive> is the drive the B1506A measurement control software has been installed.

For Windows 7 64 bit version, <system drive>:\Program Files (x86)

For Windows 7 32 bit version, Vista, or XP, <system drive>:\Program Files

Accessories

Furnished accessories and the available accessories for Keysight B1506A are listed in Tables 1-1 and 1-2.

Table 1-1

Furnished Accessories

Description	Quantity
System cable	1
CMU cable	1
Digital I/O cable	1
Blank silicon plate	1
3-pin inline package socket module	1
Curve tracer test adapter socket module	1
Gate charge socket adapter, for the B1506A-H21/H51/H71	1
Universal socket module kit, for the B1506A-H21/H51/H71	1
Thermocouple (high temperature resistant, 75 cm)	2
Connection wire with mini alligator clip, 200 mm	8
Connection wire with mini alligator clip, 300 mm	6
High current connection wire, 200 mm	2
High current connection wire, 300 mm	2
Clip for high current connection wire, large alligator	4
Banana pin adapter for connection wire	18
Spare clip, mini alligator	14
USB keyboard	1
USB mouse	1

Description	Quantity
Stylus pen	1
Power cable	2
Product Reference CD-ROM	1

Table 1-2

Available Accessories

Model Number	Option Item	Description
16444A		Accessories for B1500 series
	16444A-001	USB keyboard
	16444A-002	USB mouse
	16444A-003	Stylus pen
16493G		Digital I/O connection cable
	16493G-001	1.5 m length
	16493G-002	3 m length
N1300A		CMU connection cable
	N1300A-001	1.5 m length
	N1300A-002	3 m length
N1254A	N1254A-524	500 A Ultra High Current Prober System Cable

Options

Options available for Keysight B1506A are listed in Table 1-3.

Table 1-3

Options

Option Item	Description
Power Device Analyzer for Circuit Design	
B1506A-H20	20 A/3 kV/Thermal Fixture Package
B1506A-H50	500 A/3 kV/Thermal Fixture Package
B1506A-H70	1500 A/3 kV/Thermal Fixture Package
B1506A-H21	20 A/3 kV/C-V/Gate Charge/Thermal Fixture Package
B1506A-H51	500 A/3 kV/C-V/Gate Charge/Thermal Fixture Package
B1506A-H71	1500 A/3 kV/C-V/Gate Charge/Thermal Fixture Package
Thermal enclosure	
B1506A-T01	Thermal Test Enclosure (Thermostream Compatible)
Calibration	
B1506A-A6J	ANSI Z540-1-1994 Calibration
B1506A-UK6	Commercial calibration certificate with test data
Documentation	
B1506A-ABA	User's Guide, English
B1506A-ABJ	User's Guide, Japanese
Drive option	
B1506A-DR1	Replace a built-in DVD-R drive with a read-only DVD drive

Measurement Resources

Keysight B1506A can be equipped with the following measurement resources. Available resources depend on the package (option).

- “GNDU - Ground Unit”
- “MPSMU - Medium Power SMU”
- “HVSMU - High Voltage SMU”
- “MCSMU - Medium Current SMU”
- “HCSMU - High Current SMU”
- “UHCU - Ultra High Current Unit”
- “MFCMU - Multi Frequency CMU”

See Keysight EasyEXPERT *User’s Guide* for the functions available for the EasyEXPERT software. See *Programming Guide* for the functions available for the GPIB remote mode.

GNDU - Ground Unit

The ground unit (GNDU) is a 0 V constant voltage source, and used for the reference of measurement ground. Also the GNDU can sink up to ± 4.2 A, so it is effective for using MPSMU or HVSMU. When the HCSMU, MCSMU, or UHCU is used, the GNDU must be connected to the Low terminal side to apply the reference zero voltage. Figure 1-1 is a simplified circuit diagram of GNDU.

Figure 1-1

Simplified GNDU Circuit Diagram

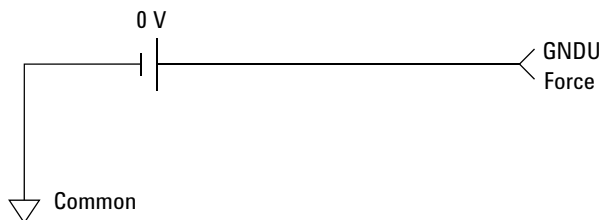

About SMU

Source/monitor unit (SMU) can apply DC voltage or current, and can measure DC current or voltage. Figure 1-2 is a simplified SMU circuit diagram.

The MPSMU can perform the following operations:

- Apply voltage and measures current or voltage
- Apply current and measures current or voltage

The HCSMU, MCSMU, and HVSMU can perform the following operations:

- Apply voltage and measures current and/or voltage
- Apply current and measures current and/or voltage

NOTE

To select the SMU operation mode in the GPIB remote condition, enter the CMM command.

Figure 1-2 Simplified SMU Circuit Diagram

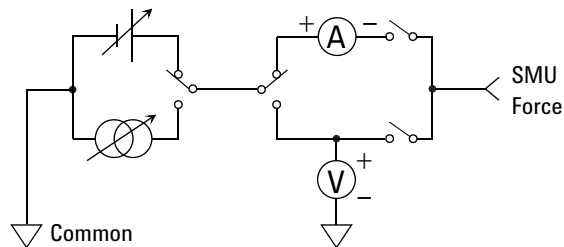

Compliance

The SMU has a compliance feature that limits output voltage or current to prevent damage to the device under test. When the SMU applies voltage, you can specify current compliance. When the SMU applies current, you can specify voltage compliance. For details on the compliance, see Keysight EasyEXPERT *User's Guide*.

MPSMU - Medium Power SMU

This section describes typical specification of the medium power source/monitor unit (MPSMU).

- Maximum voltage, current, output power: ± 100 V, ± 100 mA, 2 W
- Minimum range: 0.5 V, 1 nA
- Output/measurement value and resolution: see Table 1-4 to Table 1-7.

Figure 1-3

MPSMU Output and Measurement Ranges

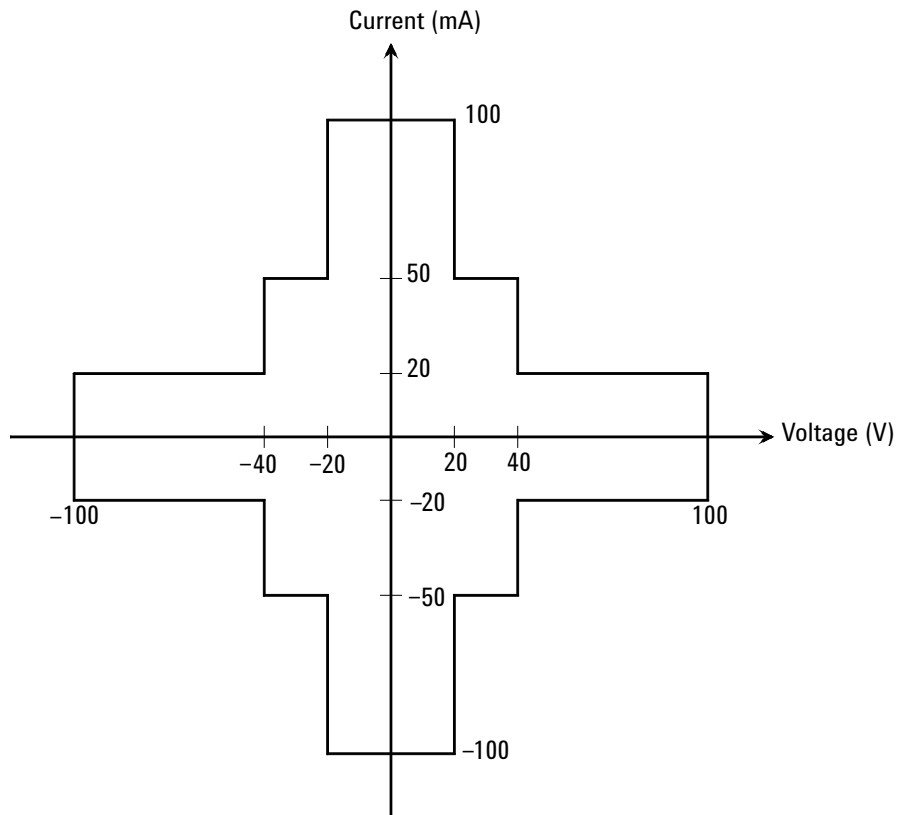

Table 1-4 **MPSMU Output Voltage Ranges and Resolutions**

Range	Output Value	Setting Resolution	Maximum Current
0.5 V	$0 \leq V \leq 0.5 \text{ V}$	25 μV	$\pm 100 \text{ mA}$
2 V	$0 \leq V \leq 2 \text{ V}$	100 μV	$\pm 100 \text{ mA}$
5 V	$0 \leq V \leq 5 \text{ V}$	250 μV	$\pm 100 \text{ mA}$
20 V	$0 \leq V \leq 20 \text{ V}$	1 mV	$\pm 100 \text{ mA}$
40 V	$0 \leq V \leq 20 \text{ V}$	2 mV	$\pm 100 \text{ mA}$
	$20 \text{ V} < V \leq 40 \text{ V}$	2 mV	$\pm 50 \text{ mA}$
100 V	$0 \leq V \leq 20 \text{ V}$	5 mV	$\pm 100 \text{ mA}$
	$20 \text{ V} < V \leq 40 \text{ V}$	5 mV	$\pm 50 \text{ mA}$
	$40 \text{ V} < V \leq 100 \text{ V}$	5 mV	$\pm 20 \text{ mA}$

Table 1-5 **MPSMU Output Current Ranges and Resolutions**

Range	Output Value	Setting Resolution	Maximum Voltage
1 nA	$0 \leq I \leq 1.15 \text{ nA}$	50 fA	$\pm 100 \text{ V}$
10 nA	$0 \leq I \leq 11.5 \text{ nA}$	500 fA	$\pm 100 \text{ V}$
100 nA	$0 \leq I \leq 115 \text{ nA}$	5 pA	$\pm 100 \text{ V}$
1 μA	$0 \leq I \leq 1.15 \mu\text{A}$	50 pA	$\pm 100 \text{ V}$
10 μA	$0 \leq I \leq 11.5 \mu\text{A}$	500 pA	$\pm 100 \text{ V}$
100 μA	$0 \leq I \leq 115 \mu\text{A}$	5 nA	$\pm 100 \text{ V}$
1 mA	$0 \leq I \leq 1.15 \text{ mA}$	50 nA	$\pm 100 \text{ V}$
10 mA	$0 \leq I \leq 11.5 \text{ mA}$	500 nA	$\pm 100 \text{ V}$
100 mA	$0 \leq I \leq 20 \text{ mA}$	5 μA	$\pm 100 \text{ V}$
	$20 \text{ mA} < I \leq 50 \text{ mA}$	5 μA	$\pm 40 \text{ V}$
	$50 \text{ mA} < I \leq 100 \text{ mA}$	5 μA	$\pm 20 \text{ V}$

Table 1-6 MPSMU Measurement Voltage Values and Resolutions

Range	Measurement Value ^a	Measurement Resolutions	
		High Speed ADC	High Resolution ADC
0.5 V	$0 \leq V \leq 0.55 \text{ V}$	25 μV	0.5 μV
2 V	$0 \leq V \leq 2.2 \text{ V}$	100 μV	2 μV
5 V	$0 \leq V \leq 5.5 \text{ V}$	250 μV	5 μV
20 V	$0 \leq V \leq 22 \text{ V}$	1 mV	20 μV
40 V	$0 \leq V \leq 44 \text{ V}$	2 mV	40 μV
100 V	$0 \leq V \leq 100 \text{ V}$	5 mV	100 μV

Table 1-7 MPSMU Measurement Current Values and Resolutions

Range	Measurement Value ^a	Measurement Resolutions	
		High Speed ADC	High Resolution ADC
1 nA	$0 \leq I \leq 1.15 \text{ nA}$	50 fA	10 fA
10 nA	$0 \leq I \leq 11.5 \text{ nA}$	500 fA	10 fA
100 nA	$0 \leq I \leq 115 \text{ nA}$	5 pA	100 fA
1 μA	$0 \leq I \leq 1.15 \text{ }\mu\text{A}$	50 pA	1 pA
10 μA	$0 \leq I \leq 11.5 \text{ }\mu\text{A}$	500 pA	10 pA
100 μA	$0 \leq I \leq 115 \text{ }\mu\text{A}$	5 nA	100 pA
1 mA	$0 \leq I \leq 1.15 \text{ mA}$	50 nA	1 nA
10 mA	$0 \leq I \leq 11.5 \text{ mA}$	500 nA	10 nA
100 mA	$0 \leq I \leq 100 \text{ mA}$	5 μA	100 nA

a. This column is applied to the auto ranging or the limited auto ranging.
For fixed ranging, maximum measurement value is **Range** column value.

HVSMU - High Voltage SMU

This section describes typical specification of the high voltage source/monitor unit (HVSMU).

- Maximum voltage/current: 3000 V/4 mA, -3000 V/-4 mA, 1500 V/8 mA, or -1500 V/-8 mA
- Maximum output power: 12 W
- Minimum range: 200 V, 1 nA
- Output/measurement value and resolution: see Table 1-8 and Table 1-9.

CAUTION

Never connect the HVSMU Force and Guard terminals to any output, including circuit common, chassis ground, or any other measurement resource such as SMU. Connecting other measurement resource may damage the connected one.

Figure 1-4

HVSMU Output and Measurement Ranges

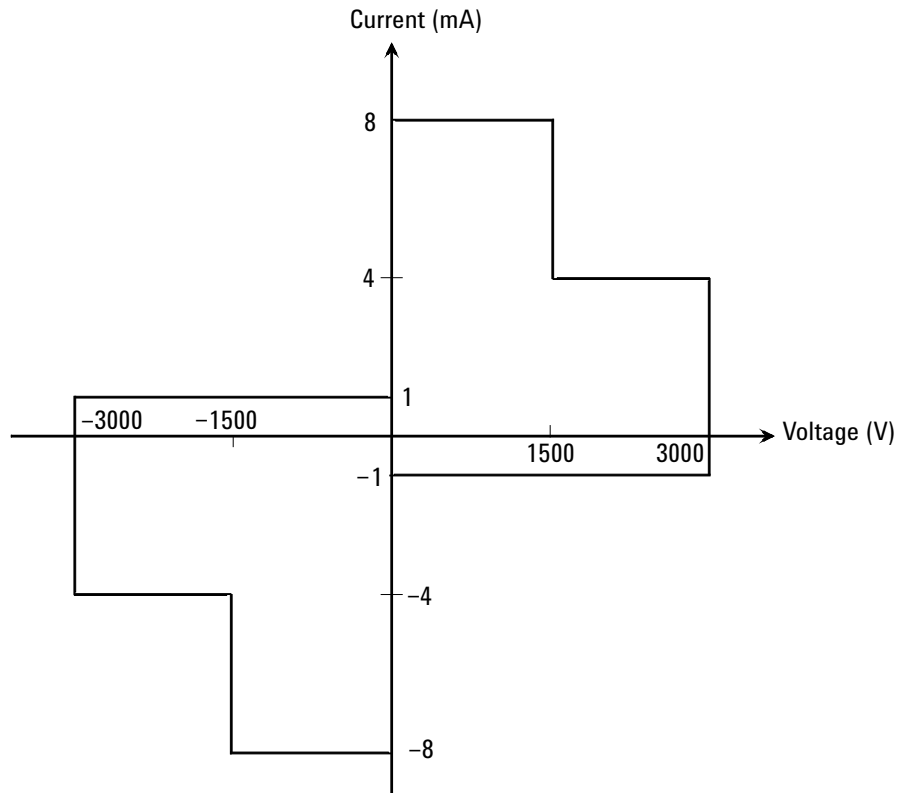

Table 1-8 HVSMU Voltage Ranges and Resolutions

Range	Output Value and Measurement Value	Setting/ Measurement Resolution	Maximum Current Imax
200 V	$0 \leq V \leq 200 \text{ V}$	200 μV	8 mA
500 V	$0 \leq V \leq 500 \text{ V}$	500 μV	8 mA
1500 V	$0 \leq V \leq 1500 \text{ V}$	1.5 mV	8 mA
3000 V	$0 \leq V \leq 3000 \text{ V}$	3 mV	4 mA

Table 1-9 HVSMU Current Ranges and Resolutions

Range	Output Value and Measurement Value	Setting/ Measurement Resolution	Maximum Voltage Vmax
1 nA ^a	$0 \leq I \leq 1.15 \text{ nA}$	10 fA	3000 V
10 nA	$0 \leq I \leq 11.5 \text{ nA}$	100 fA	3000 V
100 nA	$0 \leq I \leq 115 \text{ nA}$	100 fA	3000 V
1 μA	$0 \leq I \leq 1.15 \mu\text{A}$	1 pA	3000 V
10 μA	$0 \leq I \leq 11.5 \mu\text{A}$	10 pA	3000 V
100 μA	$0 \leq I \leq 115 \mu\text{A}$	100 pA	3000 V
1 mA	$0 \leq I \leq 1.15 \text{ mA}$	1 nA	3000 V
10 mA	$0 \leq I \leq 8 \text{ mA}$	10 nA	1500 V
	$0 \leq I \leq 4 \text{ mA}$		3000 V

a. DC only

MCSMU - Medium Current SMU

This section describes typical specification of the medium current source/monitor unit (MCSMU).

- Maximum current: ± 1 A (pulse), ± 0.1 A (DC)
- Maximum voltage: ± 30 V
- Maximum output power: 30 W (pulse), 3 W (DC)
- Minimum range: 0.2 V, 10 μ A
- Minimum pulse width: 10 μ s
- Output/measurement value and resolution: see Table 1-10 and Table 1-11.

Figure 1-5

MCSMU Output and Measurement Ranges

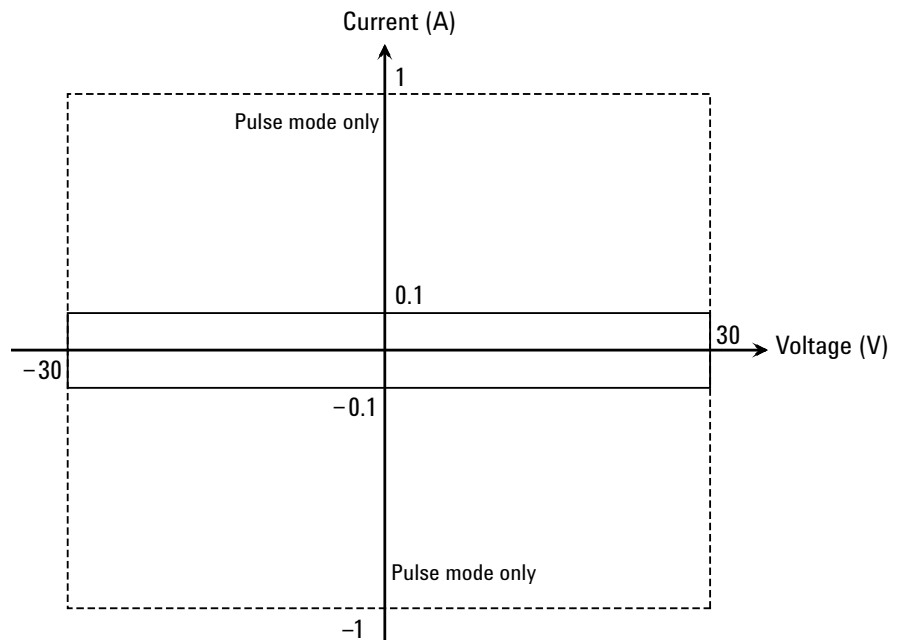

Table 1-10 MCSMU Voltage Ranges and Resolutions

Range	Output Value and Measurement Value	Setting/ Measurement Resolution	Maximum Current	Maximum Pulse Base Value
0.2 V	$0 \leq V \leq 0.2 \text{ V}$	200 nV	100 mA, 1 A ^a	$\pm 0.2 \text{ V}$
2 V	$0 \leq V \leq 2 \text{ V}$	2 μV		$\pm 2 \text{ V}$
20 V	$0 \leq V \leq 20 \text{ V}$	20 μV		$\pm 20 \text{ V}$
40 V	$0 \leq V \leq 30 \text{ V}$	40 μV		$\pm 30 \text{ V}$

a. For pulse.

Table 1-11 MCSMU Current Ranges and Resolutions

Range	Output Value and Measurement Value	Setting/ Measurement Resolution	Maximum Voltage	Maximum Pulse Base Value
10 μA	$0 \leq I \leq 11.5 \mu\text{A}$	10 pA	$\pm 30 \text{ V}$	$\pm 10 \mu\text{A}$
100 μA	$0 \leq I \leq 115 \mu\text{A}$	100 pA		$\pm 100 \mu\text{A}$
1 mA	$0 \leq I \leq 1.15 \text{ mA}$	1 nA		$\pm 1 \text{ mA}$
10 mA	$0 \leq I \leq 11.5 \text{ mA}$	10 nA		$\pm 10 \text{ mA}$
100 mA	$0 \leq I \leq 100 \text{ mA}$, $0 \leq I \leq 115 \text{ mA}$ ^a	100 nA		$\pm 100 \text{ mA}$
1 A ^b	$0 \leq I \leq 1 \text{ A}$	1 μA		$\pm 50 \text{ mA}$

a. For pulse.

b. For pulse. Maximum pulse width and duty cycle are 100 ms and 5 % respectively.

HCSMU - High Current SMU

This section describes typical specification of the high current source/monitor unit (HCSMU). The HCSMU is available for the B1506A-H21.

- Maximum current: ± 20 A (pulse), ± 1 A (DC)
- Maximum voltage: ± 40 V, ± 20 V only for the pulse over ± 1 A
- Maximum output power: 40 W
- Minimum range: 0.2 V, 10 μ A
- Minimum pulse width: 50 μ s
- Output/measurement value and resolution: see Table 1-12 and Table 1-13.

NOTE

Do not put any conductor on the HCSMU Low Force and Low Sense terminals, outer conductor of the coaxial connectors. Putting conductor of circuit common, chassis ground, or any potential on causes the measurement error.

Figure 1-6

HCSMU Output and Measurement Ranges

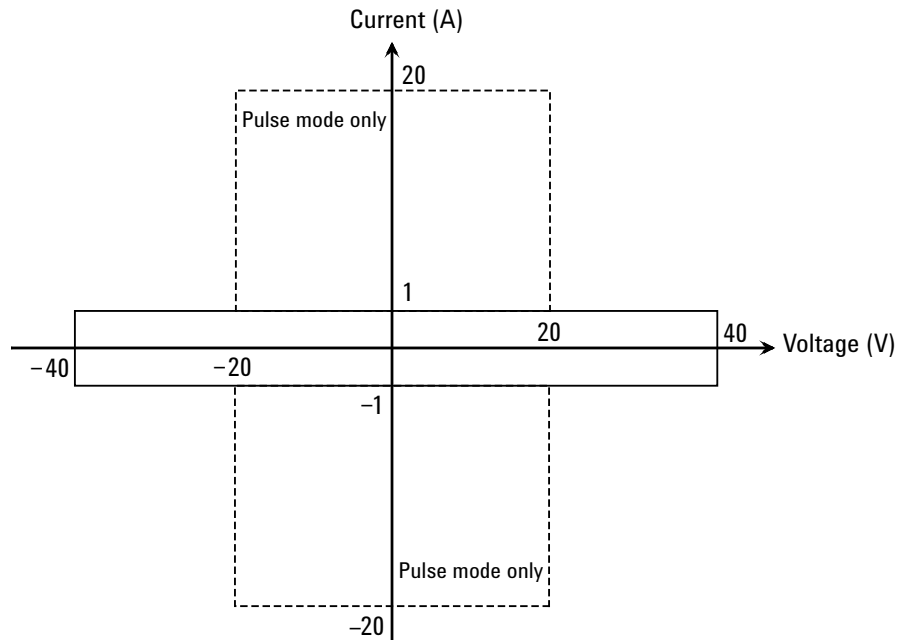

Table 1-12 HCSMU Voltage Ranges and Resolutions

Range	Output Value and Measurement Value	Setting/Measurement Resolution	Maximum Current	Maximum Pulse Base Value
0.2 V	$0 \leq V \leq 0.2 \text{ V}$	200 nV	$\pm 20 \text{ A} / \pm 40 \text{ A}$	$\pm 0.2 \text{ V}$
2 V	$0 \leq V \leq 2 \text{ V}$	2 μV	$\pm 20 \text{ A} / \pm 40 \text{ A}$	$\pm 2 \text{ V}$
20 V	$0 \leq V \leq 20 \text{ V}$	20 μV	$\pm 20 \text{ A} / \pm 40 \text{ A}$	$\pm 20 \text{ V}$
40 V	$0 \leq V \leq 40 \text{ V}$	40 μV	$\pm 1 \text{ A} / \pm 2 \text{ A}$	$\pm 40 \text{ V}$

Table 1-13 HCSMU Current Ranges and Resolutions

Range	Output Value and Measurement Value	Setting/Measurement Resolution	Maximum Voltage	Maximum Pulse Base Value
10 μA	$0 \leq I \leq 11.5 \mu\text{A}$	10 pA	$\pm 40 \text{ V}$	$\pm 10 \mu\text{A}$
100 μA	$0 \leq I \leq 115 \mu\text{A}$	100 pA	$\pm 40 \text{ V}$	$\pm 100 \mu\text{A}$
1 mA	$0 \leq I \leq 1.15 \text{ mA}$	1 nA	$\pm 40 \text{ V}$	$\pm 1 \text{ mA}$
10 mA	$0 \leq I \leq 11.5 \text{ mA}$	10 nA	$\pm 40 \text{ V}$	$\pm 10 \text{ mA}$
100 mA	$0 \leq I \leq 115 \text{ mA}$	100 nA	$\pm 40 \text{ V}$	$\pm 100 \text{ mA}$
1 A	$0 \leq I \leq 1.15 \text{ A}^{\text{a}}$	1 μA	$\pm 40 \text{ V}$	$\pm 1 \text{ A}$
20 A	$0 \leq I \leq 20 \text{ A}$	20 μA	$\pm 20 \text{ V}$	$\pm 100 \text{ mA}$

a. Maximum value is 1 A for DC output or measurement.

UHCU - Ultra High Current Unit

This section describes typical specification of the ultra high current unit (UHCU). The UHCU is available for the B1506A-H51/H71.

- Output: voltage pulse or current pulse
- Measurement: current or voltage
- Maximum current: ± 500 A (B1506A-H51) or ± 1500 A (B1506A-H71)
- Maximum voltage: ± 60 V
- Maximum power: 7.5 kW for 500 A range, or 22.5 kW for 2000 A range
- Minimum pulse width: 10 μ s
- Maximum pulse duty: 0.4 % for 500 A range, or 0.1 % for 2000 A range
- Output/measurement value and resolution: see Table 1-14 and Table 1-15.

Figure 1-7

UHCU Output and Measurement Ranges

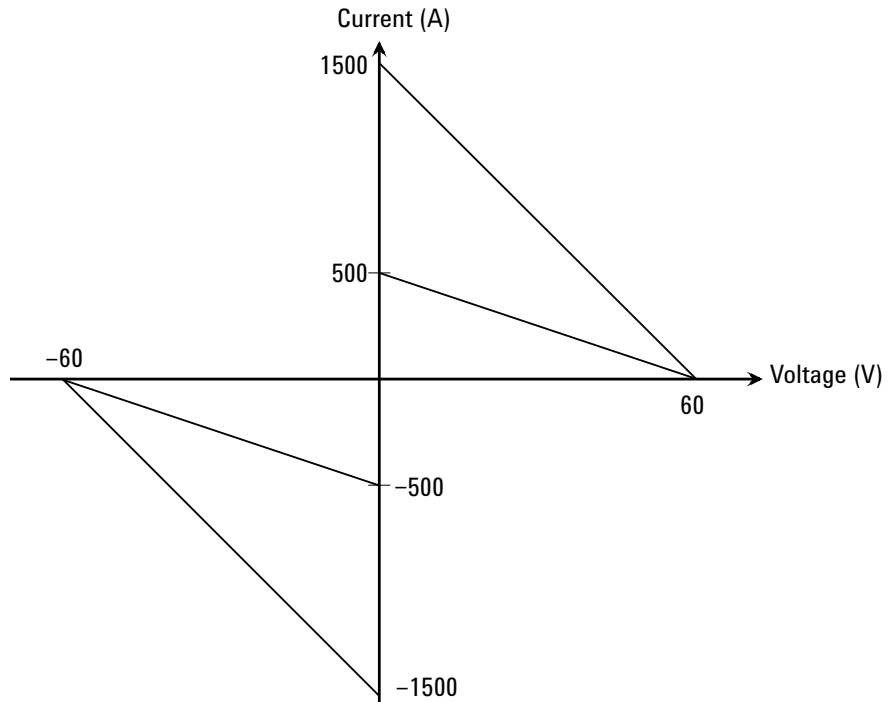

Table 1-14 UHCU Voltage Ranges and Resolutions

Range	Output Value	Measurement Value	Setting Resolution	Measurement Resolution	Maximum Current
100 V	$0 \leq V \leq 60 \text{ V}^a$	$0 \leq V \leq 60 \text{ V}$	200 μV	100 μV	$\pm 500 \text{ A}$, $\pm 1500 \text{ A}^b$

a. Pulse base value is always 0 V.

b. Only for the B1506A-H71.

Table 1-15 UHCU Current Ranges and Resolutions

Range	Output Value	Measurement Value	Setting Resolution	Measurement Resolution	Maximum Voltage
500 A	$0 \leq I \leq 500 \text{ A}^a$	$0 \leq I \leq 500 \text{ A}$	1 mA	500 μA	$\pm 63 \text{ V}^b$
2000 A ^c	$0 \leq I \leq 1500 \text{ A}$	$0 \leq I \leq 1500 \text{ A}$	4 mA	2 mA	

a. Pulse base value is always 0 A.

b. This is the maximum voltage compliance value.

c. Only for the B1506A-H71. Pulse base value is always 0 A.

MFCMU - Multi Frequency CMU

This section describes typical specification of the multi frequency capacitance measurement unit (CMU). The CMU performs the impedance measurement and returns the specified measurement data such as Cp-G.

- Measurement parameters: See Table 1-16.
- AC signal, output frequency:
1 kHz to 5 MHz
Setting resolution: 1 mHz (1 kHz to), 10 mHz (10 kHz to), 0.1 Hz (100 kHz to), or 1 Hz (1 MHz to 5 MHz)
- AC signal, output level:
10 mVrms to 250 mVrms, 1 mV resolution
- DC bias:
0 to ± 25 V, using MFCMU internal DC bias
0 to ± 3000 V, using HVSMU and high voltage bias-tee
- Measurement range:
For the fixed ranging mode, measurement range (impedance range) must be specified to perform measurement. Table 1-17 shows the available measurement ranges and the corresponding impedance value. And Figure 1-8 shows the calculation example of the impedance vs frequency characteristics of a capacitive load. Use these information to decide the measurement range.

Impedance Z is calculated by the following formula.

$$Z = 1 / (2\pi f C)$$

where f is frequency (Hz) and C is capacitance (F).

Table 1-16 Measurement Parameters

Primary Parameter	Secondary Parameter
R (resistance, Ω)	X (reactance, Ω)
G (conductance, S)	B (susceptance, S)
Z (impedance, Ω)	θ (phase, radian)
Z (impedance, Ω)	θ (phase, degree)
Y (admittance, S)	θ (phase, radian)
Y (admittance, S)	θ (phase, degree)
Cp (parallel capacitance, F)	G (conductance, S)
Cp (parallel capacitance, F)	D (dissipation factor)
Cp (parallel capacitance, F)	Q (quality factor)
Cp (parallel capacitance, F)	Rp (parallel resistance, Ω)
Cs (series capacitance, F)	Rs (series resistance, Ω)
Cs (series capacitance, F)	D (dissipation factor)
Cs (series capacitance, F)	Q (quality factor)
Lp (parallel inductance, H)	G (conductance, S)
Lp (parallel inductance, H)	D (dissipation factor)
Lp (parallel inductance, H)	Q (quality factor)
Lp (parallel inductance, H)	Rp (parallel resistance, Ω)
Ls (series inductance, H)	Rs (series resistance, Ω)
Ls (series inductance, H)	D (dissipation factor)
Ls (series inductance, H)	Q (quality factor)

Table 1-17 Measurement Range for Fixed Ranging Mode

Impedance Z	Measurement range (impedance range)		
	$1 \text{ kHz} \leq f \leq 200 \text{ kHz}$	$200 \text{ kHz} < f \leq 2 \text{ MHz}$	$2 \text{ MHz} < f \leq 5 \text{ MHz}$
$0 \leq Z < 100 \Omega$	50 Ω	50 Ω	50 Ω
$100 \Omega \leq Z < 300 \Omega$	100 Ω	100 Ω	100 Ω
$300 \Omega \leq Z < 1 \text{ k}\Omega$	300 Ω	300 Ω	300 Ω
$1 \text{ k}\Omega \leq Z < 3 \text{ k}\Omega$	1 $\text{k}\Omega$	1 $\text{k}\Omega$	1 $\text{k}\Omega$
$3 \text{ k}\Omega \leq Z < 10 \text{ k}\Omega$	3 $\text{k}\Omega$	3 $\text{k}\Omega$	3 $\text{k}\Omega$
$10 \text{ k}\Omega \leq Z < 30 \text{ k}\Omega$	10 $\text{k}\Omega$	10 $\text{k}\Omega$	
$30 \text{ k}\Omega \leq Z < 100 \text{ k}\Omega$	30 $\text{k}\Omega$	30 $\text{k}\Omega$	
$100 \text{ k}\Omega \leq Z < 300 \text{ k}\Omega$	100 $\text{k}\Omega$		
$300 \text{ k}\Omega \leq Z$	300 $\text{k}\Omega$		

Figure 1-8 Impedance vs Frequency Characteristics of Capacitive Load, Calculation Example

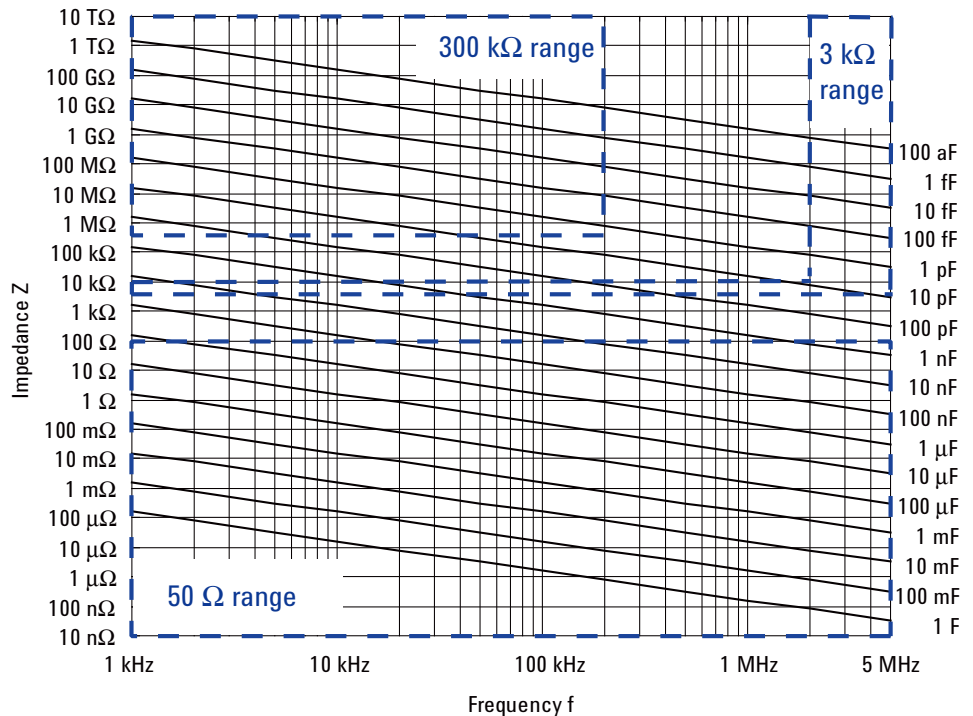

Introduction
Measurement Resources

2

Installation

This chapter describes how to install Keysight B1506A.

- “Requirements”
- “Inspection and Installation”
- “Connecting Accessories”
- “Maintenance”
- “Before Shipping to Service Center”

WARNING

To avoid electrical shock and instrument damage, turn the all instruments off before connecting or disconnecting measurement cable.

Mettez la machine hors tension pour fixer le connecteur ou pour retirer le connecteur de l'unité centrale.

WARNING

The mainframe and the test fixture are heavy and require a two person lift.

Le châssis principale et l'équipement de test sont lourds et nécessitent un levage par deux personnes.

CAUTION

Do not grab the fixture cover when lifting the test fixture.

WARNING

There are potentially hazardous voltages (± 3000 Vdc for HVSMU and ± 100 Vdc for MPSMU) present at the High, Force, Guard, and Sense terminals of the instruments. To prevent electrical shock, the following safety precautions must be observed during the use of instruments.

- Connect the instrument to an electrical ground (safety ground) by using three-conductor AC power cable.
 - Connect the mainframe Interlock terminal to the test fixture Interlock terminal by using an interlock cable.
 - Confirm periodically that the interlock function works normally.
 - Before touching the connections on the High, Force, Guard, and Sense terminals in the test fixture or the shielding box, turn the instruments off and discharge any capacitors. If you do *not* turn the instruments off, complete *all* of the following items, regardless of the instrument settings.
 - Press the front panel Stop key to set the source output off.
 - Confirm that the front panel High Voltage indicator is not lit.
 - Open the Interlock terminal (open the fixture cover or the shielding box access door).
 - Discharge any capacitors connected to a measurement resource.
 - Warn persons working around the instruments about dangerous conditions.
-

Requirements

This section describes the requirements for the environment this instrument is used.

- “Power Requirements”
- “Operating Environment”
- “Storing/Shipping Environment”
- “Installation Requirements”
- “Power Cable”

Power Requirements

This instrument can operate from any single-phase AC power source supplying 100/240 V ($\pm 10\%$) at 50/60 Hz. The maximum power consumption is shown below.

- Mainframe: 900 VA
- Test fixture of B1506A-H20/H21: 130 VA
- Test fixture of B1506A-H50/H51/H70/H71: 470 VA

Operating Environment

This instrument must be operated within the following environmental conditions:

Temperature: +5 °C to +40 °C, +5 °C to +30 °C if Thermal plate is used, or +20 °C to +30 °C if Thermostream is used

Humidity: 20 % to 70 % RH or 20 % to 50 % RH if the Thermostream setting temperature is +20 °C or below. No condensation.

Altitude: 0 to 2,000 m (6,561 ft.)

Storing/Shipping Environment

This instrument must be stored/shipped within the following environmental conditions:

Temperature: -20 °C to +60 °C

Humidity: 10 % to 90 % RH, no condensation

Altitude: 0 to 4,600 m (15,092 ft.)

Installation Requirements

WARNING

Do not operate the instrument in dusty environment, or in the presence of flammable gases, corrosive gases, or fumes.

Ne pas utiliser l'appareil dans un endroit poussiéreux, ou en présence de gaz inflammables, corrosifs ou de fumée.

- Environmental conditions for this instrument are documented in the previous page. In principle, this instrument should only be operated indoors in a controlled environment.
- Install the instrument horizontal place then face the roof up.
- The dimensions of this instrument are shown below. Fan cools the instrument by drawing air through the sides and exhausting it out the back. The instrument must be installed in a location that allows sufficient space at the sides and back of the instrument for adequate air circulation.
 - Mainframe: 420 mm (W) × 575 mm (D) × 330 mm (H)
 - Test fixture: 420 mm (W) × 575 mm (D) × 360 mm (H)

If the airflow is restricted, the internal operating temperature will be higher. This may reduce the instrument's reliability, or cause the thermal-protection circuits to turn the instrument off.

- Make sure that there is enough space for connecting/disconnecting the power cable easily.

Power Cable

WARNING

FIRE HAZARD: Use only the power cable supplied with your instrument. Using other types of power cable may cause overheating of the power cable, resulting in fire.

SHOCK HAZARD: The power cable provides the chassis ground through a third conductor. Be sure to connect to a three-conductor type power outlet with the correct pin grounded.

RISQUE D'INCENDIE : utilisez uniquement le câble d'alimentation fourni avec votre appareil. L'utilisation d'autres types de câble d'alimentation peut provoquer une surchauffe du câble d'alimentation et provoquer un incendie.













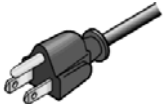

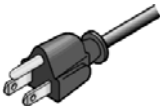

RISQUE DE CHOC ÉLECTRIQUE: le câble d'alimentation fournit la masse du châssis par le biais d'un troisième conducteur. Assurez-vous de connecter la prise d'alimentation de type trois conducteurs avec la broche correcte mise à la terre.

NOTE

The detachable power cable may be used as an emergency disconnecting device. Removing the power cable will disconnect AC input power to the instrument.

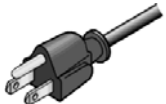
Connect the power cable to the IEC 320 connector on the rear of the instrument. If the wrong power cable was shipped with your instrument, contact your nearest Keysight Sales and Support Office.

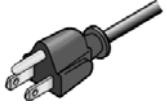
The AC input on the back of your instrument is a universal AC input. It accepts nominal line voltages in the range of 100 to 240 VAC.

<p>Option 900</p>  <ul style="list-style-type: none"> • Plug: BS 1363/A, 250 V, 10 A • PN: 8120-4420 	<p>Option 901</p>  <ul style="list-style-type: none"> • Plug: AS/NZS 3112, 250 V, 10 A • PN: 8120-4419 	<p>Option 902</p>  <ul style="list-style-type: none"> • Plug: IEC 60277-1, 250 V, 10 A • PN: 8121-1226 	<p>Option 903</p>  <ul style="list-style-type: none"> • Plug: NEMA 5-15P, 125 V, 10 A • PN: 8120-6825
<p>Option 904</p>  <ul style="list-style-type: none"> • Plug: NEMA 6-15P, 250 V, 10 A • PN: 8120-3996 	<p>Option 906</p>  <ul style="list-style-type: none"> • Plug: SEV 1011, 250 V, 10 A • PN: 8120-4416 	<p>Option 912</p>  <ul style="list-style-type: none"> • Plug: SB 107-2-D1, 250 V, 10 A • PN: 8121-1655 	<p>Option 917</p>  <ul style="list-style-type: none"> • Plug: IS 1293 and IS 6538, 250 V, 10 A • PN: 8121-1690
<p>Option 918</p>  <ul style="list-style-type: none"> • Plug: JIS C 8303, 125 V, 12 A • PN: 8121-0743 	<p>Option 919</p>  <ul style="list-style-type: none"> • Plug: Israel SI 32, 250 V, 10 A • PN: 8121-0724 	<p>Option 920</p>  <ul style="list-style-type: none"> • Plug: IRAM 2073, 250 V, 10 A • PN: 8121-0725 	<p>Option 921</p>  <ul style="list-style-type: none"> • Plug: CEI 23-16, 250 V, 10 A • PN: 8121-0722
<p>Option 922</p>  <ul style="list-style-type: none"> • Plug: GB 1002 figure 3, 250 V, 10 A • PN: 8120-8376 	<p>Option 923</p>  <ul style="list-style-type: none"> • Plug: SANS 164-1, 250 V, 10 A • PN: 8121-0564 	<p>Option 927</p>  <ul style="list-style-type: none"> • Plug: NEMA WD-6, 250 V, 10 A • PN: 8120-0674 	<p>Option 930</p>  <ul style="list-style-type: none"> • Plug: NBR 14136, 250 V, 10 A • PN: 8121-1809
<p>Option 931</p>  <ul style="list-style-type: none"> • Plug: CNS 10917-2, 125 V, 10 A • PN: 8121-1635 	<p>Option 932</p>  <ul style="list-style-type: none"> • Plug: CS 0017, 250 V, 10 A • PN: 8121-1638 		

Inspection and Installation

Do the following when this instrument arrived.

- “To Inspect Shipment”
- “To Perform Initial Setup”
- “To Connect Test Fixture”
- “To Check Operation of Test Fixture”

Do the following setup if you need.

- “To Change Windows Logon Setting”
- “To Change GPIB Address”
- “To Enable System Controller”

To Inspect Shipment

1. Before unpacking any components, inspect all boxes for any signs of damage that might have occurred during shipment, such as:
 - dents
 - scratches
 - cuts
 - water marks

If you suspect any damage, contact Keysight Technologies.

2. When you open the boxes that contain the instrument and accessories, check the components against the contents lists attached to the boxes.

If anything is missing, contact Keysight Technologies.

After the inspection, move the instrument and accessories to the installation site. For the requirements for the installation site, see “Requirements” on page 2-4.

To Perform Initial Setup

1. Place the mainframe at the installation site.
2. Make sure that the Standby switch is set to off.
3. On the rear panel, connect the Circuit Common terminal to the frame ground terminal by using a shorting-bar.
4. If you use the furnished USB keyboard and/or USB mouse, connect it to an USB port of the mainframe.
5. Connect the power cable from the mainframe to an AC power outlet.
6. Open the measurement terminals and press the Standby switch to turn on the mainframe.

If the mainframe is operating correctly, the power-on self-test is automatically performed. If problems arise, contact Keysight Technologies.

7. Follow the Windows setup wizard and complete the initial setup.
 - a. Set the system display language to English. The language must be English.
 - b. Set Country or region, Time and currency, and Keyboard layout.

If you use the furnished USB keyboard, the Keyboard layout must be US.
 - c. Accept the End User License Agreement.
 - d. Set Time zone, date and time.

If the mainframe has been already connected to your site LAN, you can proceed the network connection setup. If you connect the mainframe to the network, take care to protect it from computer virus.

NOTE

Other Windows setup

You can set other setup of Windows after the initial setup. It is your responsibility.

Users listed in Table 2-1 are available just after the initial setup.

You can add users after the initial setup. Add users as you need.

Table 2-1

Users Available Just After the Initial Setup

User Account	Description
Keysight B1500 User	Account for automatic logon. Password is not set to this account.
KeysightOnly	Account for Keysight service personnel. Do not delete this account. This account is password protected.
Administrator	Administrator. Password is not set to this account.

To Connect Test Fixture

WARNING

To avoid electrical shock and instrument damage, turn the all instruments off before connecting or disconnecting measurement cable.

Mettez la machine hors tension pour fixer le connecteur ou pour retirer le connecteur de l'unité centrale.

Connect the system cables between the mainframe and the test fixture as shown in Figure 2-1. Also see one of Tables 2-2 to 2-5 associated with your B1506A.

1. Connect the Digital I/O cable.
2. Only for the B1506A-H21/H51/H71, connect the CMU cable.
3. Connect the System cable in order of the label number.

Figure 2-1

B1506A Rear View

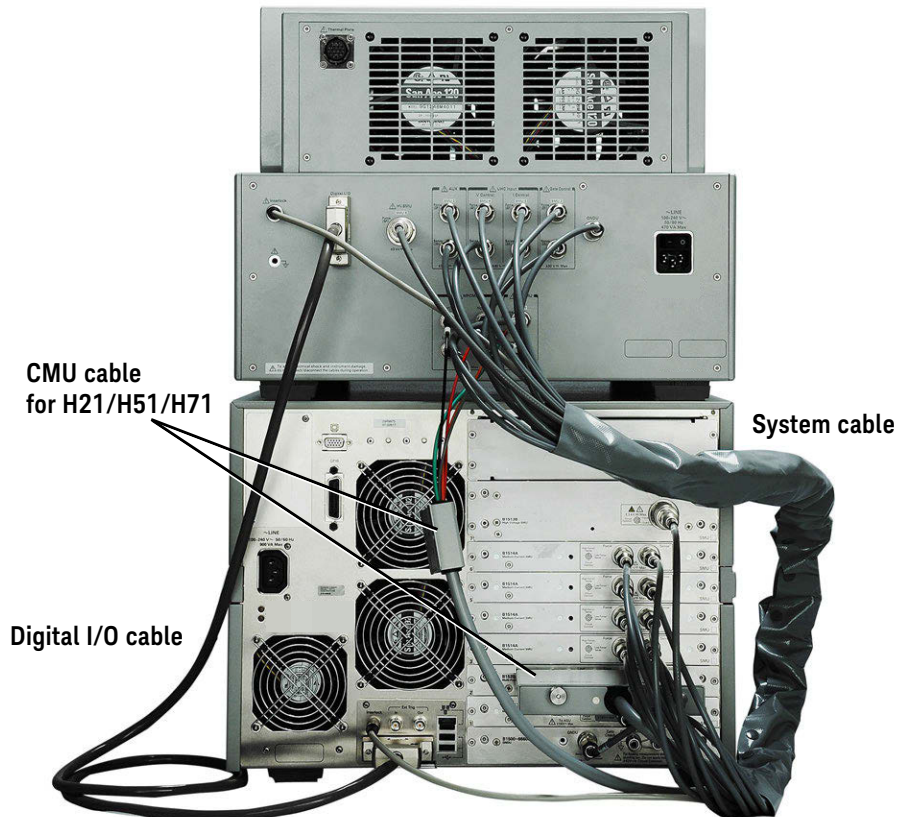

Table 2-2 B1506A-H20 System Cable Connections

Test Fixture		Label of Cable		Mainframe	
Digital I/O Cable					
Digital I/O		none	none	Digital I/O	
System Cable					
MPSMU SMU1	Force (1F)	1F	1F	Force	SMU1
	Sense (1S)	1S	1S	Sense	
Gate Control SMU2	Force (2F)	2F	2F	Force	SMU2
	Sense (2S)	2S	2S	Sense	
HCSMU SMU3	Force (3F)	3F	3F	Force	SMU3
	Sense (3S)	3S	3S	Sense	
HVSMU SMU4	Force (4F)	4F	4F	Force	SMU4
GNDU		GNDU	GNDU	GNDU	
Interlock		none	none	Interlock	

Table 2-3 B1506A-H21 System Cable Connections

Test Fixture		Label of Cable		Mainframe	
Digital I/O Cable					
Digital I/O		none	none	Digital I/O	
CMU Cable					
MFCMU	Lcur (LC)	LC	Lcur	MFCMU	
	Lpot (LP)	LP	Lpot		
	Hcur (HC)	HC	Hcur		
	Hpot (HP)	HP	Hpot		
System Cable					
MPSMU SMU1	Force (1F)	1F	1F	Force	SMU1
	Sense (1S)	1S	1S	Sense	
Gate Control SMU2	Force (2F)	2F	2F	Force	SMU2
	Sense (2S)	2S	2S	Sense	
AUX SMU3	Force (3F)	3F	3F	Force	SMU3
	Sense (3S)	3S	3S	Sense	
HCSMU SMU4	Force (4F)	4F	4F	Force	SMU4
	Sense (4S)	4S	4S	Sense	
HVSMU SMU5	Force (5F)	5F	5F	Force	SMU5
GNDU		GNDU	GNDU	GNDU	
Interlock		none	none	Interlock	

Table 2-4

B1506A-H50/H70 System Cable Connections

Test Fixture		Label of Cable		Mainframe	
Digital I/O Cable					
Digital I/O		none	none	Digital I/O	
System Cable					
MPSMU SMU1	Force (1F)	1F	1F	Force	SMU1
	Sense (1S)	1S	1S	Sense	
Gate Control SMU2	Force (2F)	2F	2F	Force	SMU2
	Sense (2S)	2S	2S	Sense	
V Control SMU3	Force (3F)	3F	3F	Force	SMU3
	Sense (3S)	3S	3S	Sense	
I Control SMU4	Force (4F)	4F	4F	Force	SMU4
	Sense (4S)	4S	4S	Sense	
HVSMU SMU5	Force (5F)	5F	5F	Force	SMU5
GNDU		GNDU	GNDU	GNDU	
Interlock		none	none	Interlock	

Table 2-5 B1506A-H51/H71 System Cable Connections

Test Fixture		Label of Cable		Mainframe	
Digital I/O Cable					
Digital I/O		none	none	Digital I/O	
CMU Cable					
MFCMU	Lcur (LC)	LC	Lcur	MFCMU	
	Lpot (LP)	LP	Lpot		
	Hcur (HC)	HC	Hcur		
	Hpot (HP)	HP	Hpot		
System Cable					
MPSMU SMU1	Force (1F)	1F	1F	Force	SMU1
	Sense (1S)	1S	1S	Sense	
Gate Control SMU2	Force (2F)	2F	2F	Force	SMU2
	Sense (2S)	2S	2S	Sense	
AUX SMU3	Force (3F)	3F	3F	Force	SMU3
	Sense (3S)	3S	3S	Sense	
V Control SMU4	Force (4F)	4F	4F	Force	SMU4
	Sense (4S)	4S	4S	Sense	
I Control SMU5	Force (5F)	5F	5F	Force	SMU5
	Sense (5S)	5S	5S	Sense	
HVSMU SMU6	Force (6F)	6F	6F	Force	SMU6
GNDU		GNDU	GNDU	GNDU	
Interlock		none	none	Interlock	

To Check Operation of Test Fixture

After completing the cable connections described in “To Connect Test Fixture” on page 2-11, perform the following procedure.

1. Open the measurement terminals of the test fixture and close the fixture cover.
2. Connect the power cable from the test fixture to an AC power outlet.
3. Connect the power cable from the mainframe to an AC power outlet.
4. Set the test fixture power switch to the ON position.
5. Press the mainframe Standby switch and wait for the Easy Test Navigator software palette to arise.
6. Launch the I/V Measurement software.
7. Click the Configuration > Module menu to display the Module Configuration dialog box.
8. Use the Module Configuration dialog box and perform diagnosis of the test fixture. If problems arise, contact Keysight Technologies.

To Change Windows Logon Setting

Windows automatic logon has been enabled initially. If you want to change this setting, select *All Programs > Control Auto Logon* from the Start menu. Control Auto Logon is displayed on the browser. Then click one of the following buttons on the browser and follow the setup script.

- Enable Auto Logon
- Disable Auto Logon

NOTE

If you set a password for the user account *Keysight B1500 User*, disable the automatic logon.

To Change GPIB Address

When this instrument is shipped from the factory, the GPIB address is set to 17. To change the GPIB address, perform the following procedure.

1. If the Easy Test Navigator software is running, terminate it by clicking on the Exit button which appears by pointing the upper right corner of the software palette.
2. If the EasyEXPERT software is running, terminate it as shown below:
 - a. Select the menu function *File > Exit* on the EasyEXPERT main screen.
 - b. Click [x] at the upper right corner of the Start EasyEXPERT button.
3. Select *All Programs > Keysight IO Libraries Suite > Keysight Connection Expert* from the Start menu. Keysight Connection Expert window appears.
4. At the *Instrument I/O on this PC* area, select GPIB0, and click the Change Properties... button. Keysight 82350 PCI GPIB Interface - GPIB0 window appears.
5. Change the GPIB Address value.
6. Remove the check from the *Auto-discover instruments connected to this interface* box.
7. Click the OK button on Keysight 82350 PCI GPIB Interface - GPIB0 window.
8. On the Reboot Required dialog box, click the Reboot Now button, and reboot the mainframe.

NOTE

For the GPIB connection of this instrument, use an GPIB interface, Keysight 82350B (for PCI bus), Keysight 82357A/B (USB/GPIB), or National Instrument GPIB-USB-HS.

For using an USB/GPIB interface, it is recommended to set the GPIB address of this instrument to an even number. The USB/GPIB interface might cause serial poll error intermittently due to the intrinsic communication scheme differences. It is reported that using an even GPIB address sometimes significantly decreases the chance of the error.

To Enable System Controller

To allow this instrument to control external GPIB devices, perform the following procedure. After the procedure, you cannot control the instrument from an external computer.

1. If the Easy Test Navigator software is running, terminate it by clicking on the Exit button which appears by pointing the upper right corner of the software palette.
2. If the EasyEXPERT software is running, terminate it as shown below:
 - a. Select the menu function *File > Exit* on the EasyEXPERT main screen.
 - b. Click [x] at the upper right corner of the Start EasyEXPERT button.
3. Select *All Programs > Keysight IO Libraries Suite > Keysight Connection Expert* from the Start menu. Keysight Connection Expert window appears.
4. At the *Instrument I/O on this PC* area, select GPIB0, and click the Change Properties... button. Keysight 82350 PCI GPIB Interface - GPIB0 window appears.
5. Set the GPIB Address value to 21 that is the typical address number for the system controller.
6. Check the *System Controller* box.
7. Remove the check from the *Auto-discover instruments connected to this interface* box.

This disables the automatic device detection. So the Connection Expert cannot detect the instruments connected to the GPIB interface by itself.
8. Click the OK button on Keysight 82350 PCI GPIB Interface - GPIB0 window.
9. On the Reboot Required dialog box, click the Reboot Now button, and reboot the mainframe.

NOTE

To Disable System Controller

To disable the system controller, change the steps 5 and 6 for setting the GPIB Address value to *not* 21 and removing the check from the *System Controller* box, and perform the procedure to the step 9.

Connecting Accessories

The test fixture is used to connect your device under test (DUT). The B1506A is furnished with the following accessories.

- “3-pin Inline Package Socket Module”
- “Curve Tracer Test Adapter Socket Module”
- “Universal Socket Module Kit”
- “Gate Charge Socket Adapter”
- “Accessories for Connecting a DUT”
- “Prober System Cable”
- “Thermocouple”

Also, the following equipment can be used with the B1506A for controlling temperature of DUT. Contact inTEST Corporation for the equipment.

- “Thermal Plate”
- “Thermostream”

WARNING

Set the instrument output off before connecting or disconnecting connection wire.

Press the mainframe front panel Stop key to set the source output off. And confirm that the mainframe front panel High Voltage indicator is not lit.

WARNING



To prevent electrical shock and DUT damage, do not connect or disconnect the DUT while the instrument is applying voltage or current.

When you touch the DUT after measurement, devise a countermeasure of residual charge and heat to prevent electrical shock and burn. Use glove and any tool. Also have enough time for discharge and radiation.

Pour éviter toute électrocution et tout risque d'endommagement de l'appareil, ne retirez pas les câbles pendant le fonctionnement.

Lorsque vous touchez le MST après la mesure, élaborer une contre-mesure de la charge résiduelle et du chauffage afin d'éviter tout choc électrique et toute brûlure. Utilisez des gants et des outils. Prévoyez également du temps pour la décharge et la radiation.

3-pin Inline Package Socket Module

Use the socket module to connect a three-terminal inline packaged device. See the following simple instruction.

Requirements

- 3-pin inline package socket module
- DUT

Procedure

1. Attach the socket module directly to the Base/Gate, Collector/Drain, and Emitter/Source terminals of the test fixture.
2. Set your DUT on the socket.
3. Close the fixture cover and perform measurement.



WARNING

Hazardous voltage, instrument maximum output voltage may appear at the measurement terminals if the fixture cover is closed.

CAUTION

Do not apply voltage/current over the maximum limit of the socket module.

Maximum voltage: 3000 V

Maximum current: 500 A pulse, 39 A dc

CAUTION

Use the socket module within the temperature range of 0 °C to +100 °C.

NOTE

Short plate is furnished with the socket module. It is used for performing the short correction before the capacitance measurement. Set it on the socket before the short correction and remove it after the correction.

Curve Tracer Test Adapter Socket Module

This module provides a socket available for connecting a test adapter designed for connecting to Tektronix 370B/371B curve tracers. To use this module, see the following simple instruction.

Requirements

- Curve tracer test adapter socket module
- DUT and a test adapter for curve tracer

Procedure

1. Attach the socket module directly to the test fixture.
2. Set your test adapter on the socket module.
3. Set your DUT on the test adapter.
4. Close the fixture cover and perform measurement.



WARNING

Hazardous voltage, instrument maximum output voltage may appear at the measurement terminals if the fixture cover is closed.

CAUTION

Do not apply voltage/current over the maximum limit of the socket module.

Maximum voltage: 3000 V

Maximum current for Collector/Drain/Emitter/Source Force: 500 A pulse, 39 A dc

Maximum current for other terminals: 40 A pulse, 2 A dc

CAUTION

Use the socket module within the temperature range of +5 °C to +40 °C.

Universal Socket Module Kit

This is a blank module, kind of a do-it-yourself kit for supporting variety of packaged devices. This kit is furnished with the B1506A-H21/H51/H71. The contents of this kit are shown in Figure 2-2 and Table 2-6.

You can use this handmade socket module with the same manner as the 3-pin Inline Package Socket Module. See “3-pin Inline Package Socket Module”.

Figure 2-2

Universal Socket Module Kit

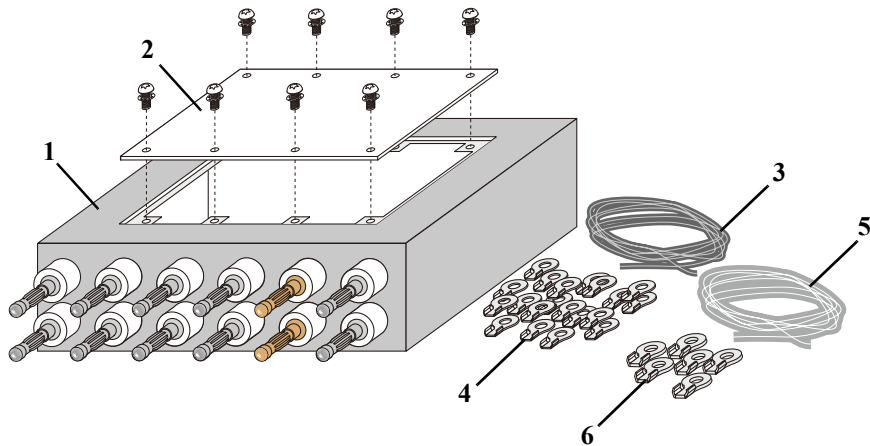

Table 2-6

Parts of Universal Socket Module Kit

Reference	Parts	Description	Qty.
1	Blank module	Base of the socket module	1 ea
2	Dummy board	This is pre-assembled to the blank module. You can also make a socket board using this board, instead of a new blank board.	1 ea
3	Wire	For internal connections	2 m
4	Lug terminal	For internal connections	20 ea.
5	Wire for high current	For internal connections	2 m
6	Lug terminal for high current	For internal connections	6 ea

Making the Universal Socket Module

Requirements

- T10 Torx screwdriver
- T15 Torx screwdriver
- 9 mm wrench
- Caulking tool for lug terminals, 2.0sq
- Caulking tool for high current lug terminals, 5.5sq

Prepare a socket for your test devices, a blank board, tools for mounting the socket, screws and nut for socket terminals, and so on separately.

For the dimensions and screw holes of a blank board, see Figure 2-3.

CAUTION

Confirm the allowable temperature range of the blank board and the socket and use the socket module within the range.

The allowable temperature range of the dummy board is approximately 0 °C to +100 °C.

Procedure

1. Remove the dummy board from the blank module using a T15 Torx screwdriver.
2. Make a socket board by process a blank board or the dummy board and mount your device socket onto the board.

WARNING

Make enough space between the socket terminal and the shield/chassis, for example, about 1 mm for maximum 200 V output and 6 mm for 3000 V, to prevent discharge and any accident.

3. Fix the socket board to the blank module using the screws and tooth washers you kept when removing the dummy board.
4. Remove the bottom cover of the blank module using a T10 Torx screwdriver.
5. Assemble cables using the wire and lug terminals.

Cut the appropriate length of the wire, tear off the coating of wire ends, and then secure the lug terminals to the wire ends using a caulking tool.

WARNING

When the measurement uses higher range than 500A range, use the wire for high current and lug terminals for high current for connecting the Force terminals of the Collector/Drain and Emitter/Source.

6. Connect one ends of all cables to the inside terminals on the blank module.

Remove screws and tooth washers from the terminals, and fix the lug terminal of the cable end in order of a washer, a lug terminal, a tooth washer, and a screw. When fixing the lug terminal, secure a screw by a T15 Torx screwdriver with fixing the bottom nut by a 9 mm wrench.

Positions of the wiring side terminals are shown below.

Blank module wiring side view:

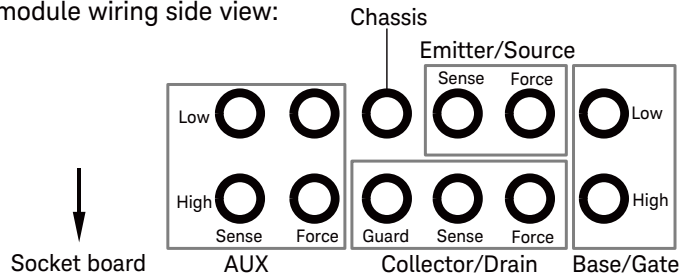

7. Connect the other ends of the cables to the terminals on the back side of the socket board.

If a socket terminal does not have a screw or nut for securing a lug terminal of the cable, prepare it. Ensure the terminal position of the blank module and the socket board, and connect the cables correctly.

8. Fix the bottom cover to the blank module using a T10 Torx screwdriver.

Figure 2-3

Dimensions and Screw Holes of Blank Board

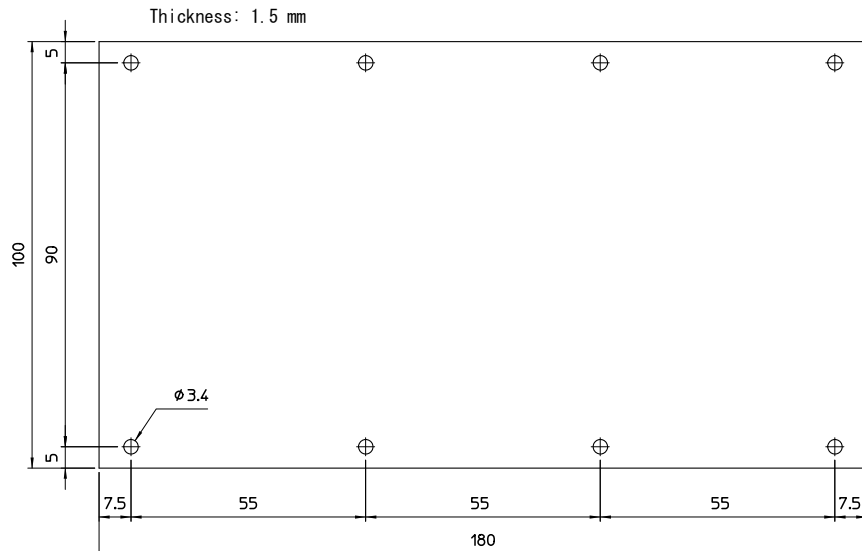

Gate Charge Socket Adapter

This socket adapter is designed for performing the gate charge measurement. The adapter supports 3-pin inline package device and other type of device. This socket adapter is furnished with the B1506A-H21/H51/H71.

- “Connecting 3-pin Inline Package Device”
- “Connecting Other Type of Device”

CAUTION

Use the gate charge socket adapter at ambient temperatures.

Connecting 3-pin Inline Package Device

Requirements

- Gate charge socket adapter and Shorting bar (furnished with the adapter)
- DUT (3-pin inline package device)
- Current control device or Load resistor

The current control device must be an extra 3-pin inline package device which is expected to have the same characteristics as DUT. If the device is not available, use a load resistor. The resistor must satisfy the following specifications.

Resistance = V_r/I_r (V_r : rated voltage, I_r : rated current)

Peak power $\geq V_r \times I_r \times 1$ ms

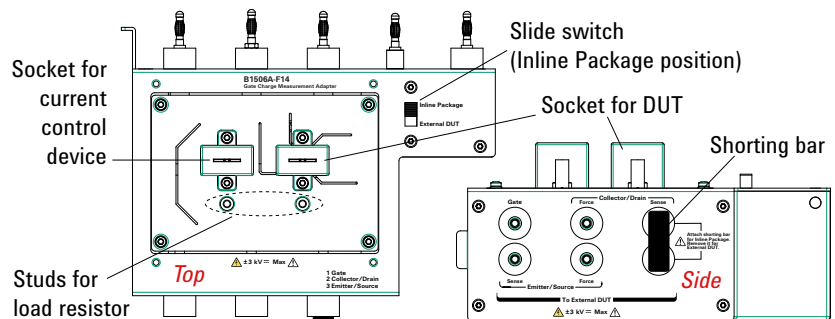

Procedure

1. Attach the socket adapter directly to the Base/Gate, Collector/Drain, Emitter/Source, and AUX Force terminals of the test fixture.
2. Attach the shorting bar to the Sense terminals on the side panel.
3. Set the slide switch to the Inline Package position.

4. Set the current control device on the left socket or connect the load resistor between the studs for the resistor.
5. Set your DUT on the right socket.
6. Close the fixture cover and perform measurement.

WARNING

Hazardous voltage, instrument maximum output voltage may appear at the measurement terminals if the fixture cover is closed.

NOTE

Open the AUX Sense terminals of the test fixture. Do not connect anything to them.

NOTE

Short plate is furnished with the adapter. It is used for performing the short correction before the gate charge measurement. Set it on “Socket for DUT” before the short correction and remove it after the correction.

Connecting Other Type of Device

Requirements

- Gate charge socket adapter
- Blank silicon plate
- Connection wire, clip, adapter, and so on. Use the furnished accessories.

Banana pin to Large alligator clip wire can be assembled by fixing a banana pin adapter and a clip to a connection wire using a screw and a nut.

- DUT (other than 3-pin inline package device)
- Current control device or Load resistor

The current control device must be an extra 3-pin inline package device which is expected to have the same characteristics as DUT. If the device is not available, use a load resistor. The resistor must satisfy the following specifications.

Resistance = V_r/I_r (V_r : rated voltage, I_r : rated current)

Peak power $\geq V_r \times I_r \times 1 \text{ ms}$

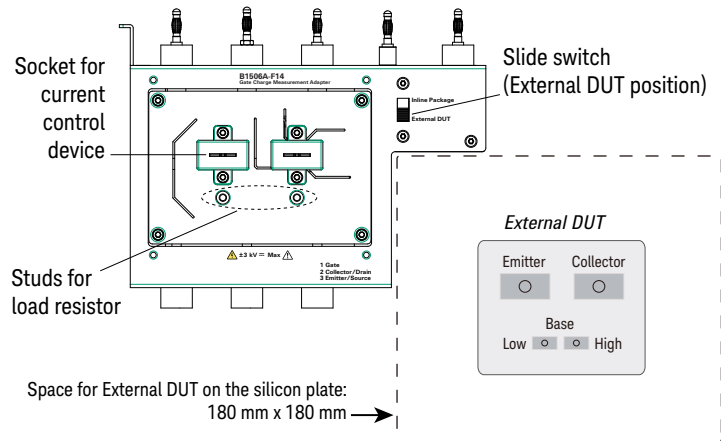

Procedure

1. Set the blank silicon plate on the DUT stage of the test fixture.
2. Attach the socket adapter directly to the Base/Gate, Collector/Drain, Emitter/Source, and AUX Force terminals of the test fixture.
3. Remove the shorting bar from the Sense terminals if it is attached.
4. Set the slide switch to the External DUT position.
5. Set the current control device on the left socket or connect the load resistor between the studs for the resistor.
6. Put your DUT on the space for the external DUT. The device size should be smaller than approximately 170 mm (W) × 170 mm (D) × 130 mm (H).
7. Connect your DUT to the side panel terminals by using connection wire, clip, adapter, and so on.

Force and Sense must be connected together at the terminal of DUT for making the Kelvin connection.

8. Close the fixture cover and perform measurement.

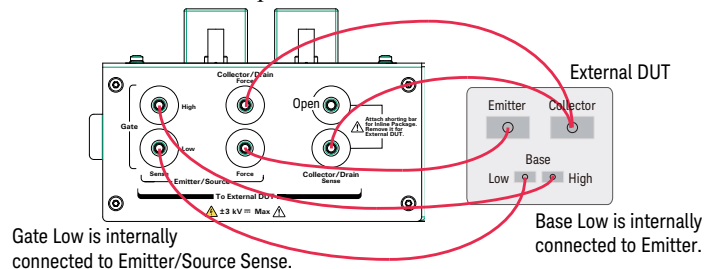

WARNING

Hazardous voltage, instrument maximum output voltage may appear at the measurement terminals if the fixture cover is closed.

WARNING



Make sure that the cover is closed properly before starting measurement. Do not perform the measurement when a wire is protruding from the fixture cover.

Assurez-vous que le couvercle est fermé correctement avant de commencer la mesure. Ne pas effectuer la mesure lorsqu'un câble dépasse du couvercle de l'appareil.

NOTE

Open the AUX Sense terminals of the test fixture. Do not connect anything to them.

NOTE

Open/short correction should be performed before the gate charge measurement. Open between the Gate/Base terminal and the Emitter/Source terminal for the open correction and short them for the short correction at the end of the extension cables.

Accessories for Connecting a DUT

Use the connection wire, clip, adapter, and so on to connect a device that cannot be connected to any socket module or adapter.



In the above picture, the blank silicon plate is set on the DUT stage of the test fixture, and the Thermal Plate is placed on the plate and connected to the Thermal Plate connector. Also, the thermocouples are connected to the K Thermocouple terminals and put on the places to monitor temperature. For the Thermal Plate, contact inTEST Corporation.

Requirements

- Blank silicon plate
- Connection wire, clip, adapter, and so on. Use the furnished accessories.
Banana pin to Large alligator clip wire can be assembled by fixing a banana pin adapter and a clip to a connection wire using a screw and a nut.
- DUT (other than 3-pin inline package device)

Procedure

1. Set the blank silicon plate on the DUT stage of the test fixture.
2. Put your DUT on the blank silicon plate. The device size should be smaller than approximately 330 mm (W) × 170 mm (D) × 130 mm (H).
3. Connect your DUT to the measurement terminals of the test fixture by using connection wire, clip, adapter, and so on.

Force and Sense must be connected together at the terminal of DUT for making the Kelvin connection.

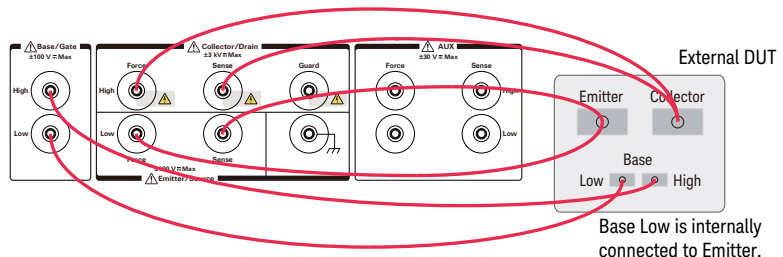

4. Close the fixture cover and perform measurement.

WARNING

Hazardous voltage, instrument maximum output voltage may appear at the measurement terminals if the fixture cover is closed.

WARNING

To reduce the leakage current of the extension cable, the Guard terminal may be extended as close as possible to the drain or collector terminal of DUT.

Then, open the Guard terminal at the end of the extension cable to avoid electrical shock, instrument damage, or DUT damage. Do not connect anything to this terminal which has the same potential as the High Force and High Sense.

WARNING



Make sure that the cover is closed properly before starting measurement. Do not perform the measurement when a wire is protruding from the fixture cover.

Assurez-vous que le couvercle est fermé correctement avant de commencer la mesure. Ne pas effectuer la mesure lorsqu'un câble dépasse du couvercle de l'appareil.

CAUTION

Never connect the High, High Force, High Sense, or Guard terminal to any output, including circuit common and chassis ground. Connecting other output may damage the connected one.

⚠ Prober System Cable

The N1254A-524 prober system cable is used to extend the measurement terminals to a probe station. For connecting this cable to the B1506A, see “Connecting Prober System Cable to Test Fixture” on page 2-32. Connection image is shown in Figure 2-4. Cable length is approximately 1.8 m.

The prober side of this cable is a connector box which provides five connectors. The connector box should be installed near DUT interface such as manipulators and must be connected to it. For the connection cables to DUT interface, see Table 2-8.

The prober side connector type, maximum voltage, and maximum current of the prober system cable are shown in Table 2-7. This cable internally connects Low and Low Sense.

CAUTION

Do not apply voltage/current over the maximum limit of the cable.

Figure 2-4 Connection Image using N1254A-524 Prober System Cable

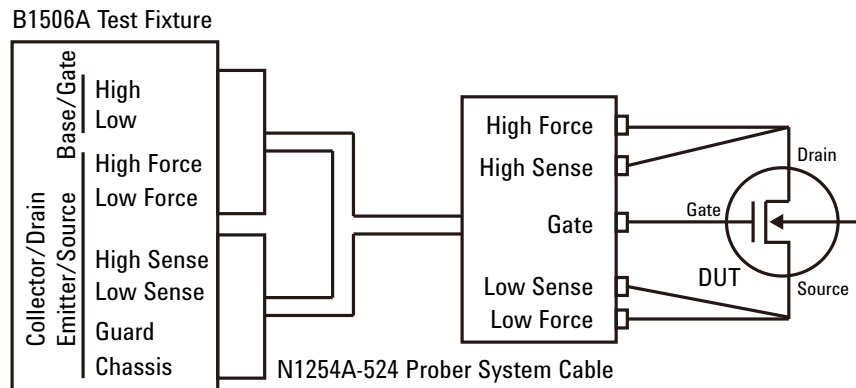

Table 2-7 Prober Side Connector Type and Maximum Voltage/Current of N1254A-524

Connector label	Connector type	Test fixture measurement terminals to extend	Maximum voltage	Maximum current
High Force	Banana(jack)	Collector/Drain High Force	3000 V	39 A dc, 500 A pulse ^a
Low Force	Banana(jack)	Emitter/Source Low Force	200 V	

Connector label	Connector type	Test fixture measurement terminals to extend	Maximum voltage	Maximum current
High Sense	HV(jack)	Collector/Drain High Sense	3000 V	1 A dc, 20 A pulse
Low Sense	BNC(f)	Emitter/Source Low Sense	200 V	
		Base/Gate Low		
Gate	BNC(f)	Base/Gate High	200 V	

a. Pulse of 1 ms pulse width and 0.4 % duty cycle

Table 2-8 Connection Cables to DUT Interface

N1254A-524 connectors	Required cables/Description	Connect to
Low Force	Ultra high current cable with banana(plug). N1254A-523 can be used.	DUT low terminal (ex: source)
Low Sense	Coaxial cable with BNC(m) connector. N1254A-503 can be used.	
High Force	Ultra high current cable with banana(plug). N1254A-523 can be used.	DUT high terminal (ex: drain)
High Sense	Triaxial cable with HV(plug) connector. N1254A-505 can be used.	
Gate	Coaxial cable with BNC(m) connector. N1254A-503 can be used.	DUT drive terminal (ex: gate)

CAUTION

Never connect the High Force and High Sense terminals to any output, including circuit common, chassis ground, or any other measurement resource such as SMU. Connecting other measurement resource may damage the connected one.

Connecting Prober System Cable to Test Fixture

Requirements

- Box wrench, M5 hex
- Clear plastic plate, 2 ea. (furnished with the N1254A-524 prober system cable)

Procedure

1. Turn the all instruments off.
2. Remove power cable from the all instruments.

3. Open the test fixture cover.
4. Remove connection wire from the test fixture measurement terminals if the wire is connected.
5. Remove the clear plastic plate from the test fixture cover. This makes opening for passing the cable through. Use the box wrench and unscrew six hex nuts to remove the plate.

Treasure the removed plate. It must be replaced in the normal use conditions without the N1254A-524 prober system cable.
6. Connect two connector boxes of the prober system cable to the Collector/Drain, Emitter/Source, and Base/Gate terminals properly. See Figure 2-4.
7. Pull out the prober side connector box and some long of extension cable (approximately 1.5 m) from the opening.
8. Set and fix two clear plastic plates to the fixture cover by using the hex nuts removed in the step 5. The plates close the excess opening and make the opening enough to pass the cable through.
9. Close the fixture cover.
10. Connect the 16493J interlock cable from the B1506A mainframe to the interlock circuit installed in the probe station.

WARNING

For using the prober system cable safely

Never connect the interlock cable to the test fixture.

Never leave and use the test fixture in the condition that the clear plastic plates are removed from its fixture cover.

Pour utiliser le système de sonde en toute sécurité

Ne jamais connecter le câble de verrouillage au montage d'essai.

Ne jamais ôter les plaques en plastique transparent du couvercle d'appareil.

Thermocouple

Use thermocouple to monitor temperature. The B1506A is furnished with two thermocouples. For the setup image, see “Accessories for Connecting a DUT” on page 2-29.

1. Connect the thermocouple to the K Thermocouple terminal.
2. Secure the end of the thermocouple to the place for monitoring temperature.

Thermal Plate

3. The test fixture can be equipped with the Thermal Plate for controlling temperature of DUT. For the setup image, see “Accessories for Connecting a DUT” on page 2-29.
1. Set the blank silicon plate on the DUT stage of the test fixture.
2. Place the Thermal Plate on the silicon plate.
3. Connect the cable from the Thermal Plate to the Thermal Plate connector on the test fixture.
4. Put your DUT on the Thermal Plate. The device size should be smaller than approximately 160 mm (W) × 160 mm (D) × 100 mm (H).
5. Connect your DUT as described in “Accessories for Connecting a DUT” on page 2-29. Or see “Connecting Other Type of Device” on page 2-26 for performing the gate charge measurement.
6. Set the thermocouple if it is used. See “Thermocouple” on page 2-33.
7. Connect the cable from the temperature controller to the Thermal Plate connector on the test fixture rear panel.
8. Close the fixture cover and perform measurement.

For the Thermal Plate, contact inTEST Corporation.

Thermostream

The test fixture can be equipped with the Thermostream for controlling temperature of DUT. For the setup image, see the following figure. The B1506A-T01 thermal test enclosure is needed to set the Thermostream on the test fixture.

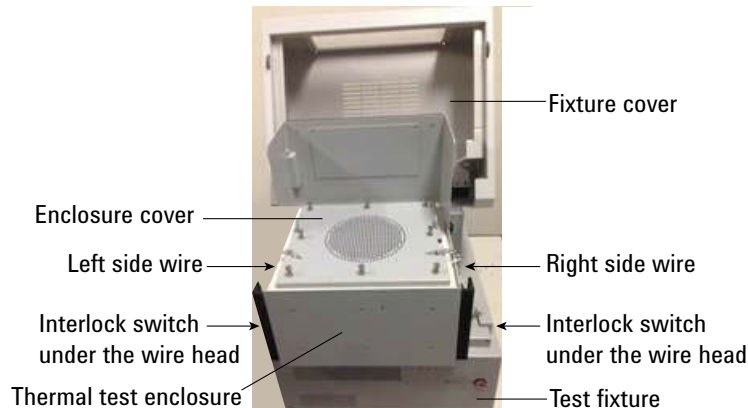

1. If you use the thermocouple, connect it to the K Thermocouple terminal.
2. Face the terminals on the enclosure rear panel to the fixture output terminals, and firmly connect them until no gap is shown between them.
3. Unscrew and remove the enclosure cover.
4. Put your DUT in the enclosure. The device size should be smaller than approximately 260 mm (W) × 180 mm (D) × 120 mm (H).
If you use the socket module, attach it directly to the terminals in the enclosure.
5. Refer to “Accessories for Connecting a DUT” on page 2-29 and connect your DUT properly. Do not leave the unused test leads inside the enclosure.
If you use the socket module, set your DUT on the socket.
If you use the thermocouple, secure the end of the thermocouple to the place for monitoring temperature.
6. Set and fix the enclosure cover by screws so that the openings are not made between the enclosure body and the cover especially around the slit labeled “Thermocouple”.
If you use the thermocouple, pass it through the slit. If two thermocouples are used, adjust them so that they do not overlap together.
7. Set the Thermostream on the enclosure cover.
Adjust the nozzle of the Thermostream so that it fits the cover horizontally and so that the openings are not made between them.
Connect the purge air tube from the Thermostream to the Purge air inlet at the enclosure side back.
8. Set the left side wire head in the slit of the test fixture interlock switch and ram it down.
9. Set the right side wire head in the slit of the test fixture interlock switch and ram it down.
10. Leave the fixture cover open and perform measurement.

For the Thermostream, contact inTEST Corporation.

WARNING



Activating the Thermostream may cause low or high temperature of -50 °C to +250 °C on the enclosure front panel, the cover, and the left and right protection panels. To prevent yourself from getting injury, confirm that they are in the safe temperature range before touching the enclosure.

L'activation du flux thermique peut entraîner une basse ou haute température de -50 °C à +250 °C sur le panneau de protection avant, le couvercle et les panneaux de protection à gauche et à droite. Pour éviter de vous blesser, confirmez qu'ils sont dans la plage de température de sécurité avant de toucher le boîtier.

WARNING



While the enclosure wire heads (To Slit) are rammed down into the slits of the test fixture interlock switches, hazardous voltage, instrument maximum output voltage may appear at the measurement terminals.

Pendant que les têtes de fil d'enceinte (à fente) sont enfoncés dans les fentes des commutateurs d'interverrouillage de mélange d'essai, une tension dangereuse, une tension de sortie maximale d'instrument peut apparaître aux bornes de mesure.

CAUTION

Do not expose the back of the enclosure to the condensation. Wetting the connection cables or connectors may cause the instrument damage.

CAUTION

If you use the socket module, confirm its allowable temperature range and use it within the range.

CAUTION



Purge air inlet

To prevent condensation, connect the Thermostream purge air tube here.

Entrée de purge d'air

Pour empêcher toute formation de condensation, connectez le tube de purge d'air Thermostream ici.

Maintenance

Maintenance should be performed periodically to keep the instrument in good condition.

Cleaning

Before performing cleaning, turn off the instrument, and disconnect power cable from the rear panel. Use a dry cloth to clean the external case parts.

To prevent electrical shock, do not perform cleaning when the instrument is turned on, and do not use a wet cloth.

Self-test and Diagnosis

This instrument provides the following functions to check the operation. Perform the following functions as necessary. Open the measurement terminals to perform self-test, self-calibration, or diagnosis.

- Self-test
- Self-calibration
- Diagnosis

If problems arise, contact Keysight Technologies.

NOTE



Interlock Open/Close test and High Voltage LED test

Interlock function limits the maximum output voltage to ± 42 V when the measurement terminal is touchable. For safety, this function must be checked before using the instrument after power on at least once a day by performing the diagnosis.

Calibration

Calibration and adjustments must be performed periodically so that the instruments satisfy the specifications, and keep a good condition. It is recommended to perform the calibration once a year at least. For the calibration and adjustments, contact Keysight Technologies. Trained service personnel will perform the calibration and adjustments.

Before Shipping to Service Center

Before shipping this instrument to service center, you have to do following:

- “To Make Backup”
- “To Check Module Slots”
- “To Collect Equipment and Accessories”

To Make Backup

If the internal hard disk drive (HDD) is failed, you will lose all data stored in the HDD. So it is important to make backup constantly.

Before shipping the instrument to the service center, make backup of data in the HDD. And keep the backup media in trust. You may need to perform data recovery of the instrument returned from the service center.

If the HDD is replaced, the instrument will be returned with the latest revision of the software.

To Check Module Slots

Do not remove the plug-in module from the mainframe. The instrument must be shipped with all modules. The module cannot be repaired or calibrated without the mainframe.

If a module is removed and installed, the specifications are not guaranteed. The specifications are guaranteed after the calibration is performed at Keysight Technologies service center.

To Collect Equipment and Accessories

The mainframe, test fixture, and all connection cables are required for servicing and must be shipped to the service center. For details, contact the service center.

WARNING

To prevent electrical shock, turn off the instrument and remove the power cable before removing the connection cables.

Mettez la machine hors tension pour fixer le connecteur ou pour retirer le connecteur de l'unité centrale.

3

How To Perform Measurement

This chapter describes how to measure the power devices by using Keysight B1506A and Keysight Easy Test Navigator Software, and consists of the following sections:

- How To Perform Datasheet Characterization
- How To Perform I/V Measurement
- How To Perform Capacitance Measurement ¹
- How To Perform Gate Charge Measurement ¹
- How To Calculate Power Loss ¹
- How To Monitor/Control Temperature Under Measurement

NOTE**If Easy Test Navigator does not run**

Launch “Keysight Connection Expert” by using the icon on Windows taskbar. And check the USB0 connection status displayed in “Instrument I/O on this PC” area.

USB0 connection status display example:

```
USB0
+ B1500A(USB0::2391::1::0001::0::INSTR)
  + agb1500a
    + UsbDevice1
```

If “agb1500A” and “UsbDevice1” are not listed, add them by using a dialog box which is opened by right-clicking on B1500A(USB0:: . . ::INSTR) and selecting “Add VISA Alias” from the menu. For more information, see *Connectivity Guide* opened from the Help menu on the Connection Expert window.

NOTE

This chapter may contain the information different from the instrument’s actual screen image and operation. For the reference information of GUI, see Chapter 4.

1. Available for the B1506A-H21/H51/H71.

How To Perform Datasheet Characterization

This section describes how to perform measurement on device parameters and characteristics using the datasheet characterization software. This section consists of the following sub-sections:

- Preparing Measurement
- Executing Measurement

The datasheet characterization software provides a simple operation environment in a familiar datasheet-like format that can specify measurement items and measurement conditions, perform measurement, and displays measurement results.

NOTE

For using the B1506A-H20/H50/H70, ignore the description about the capacitance measurement, the gate charge measurement, and the power loss calculation.

Figure 3-1

Datasheet Characterization Software

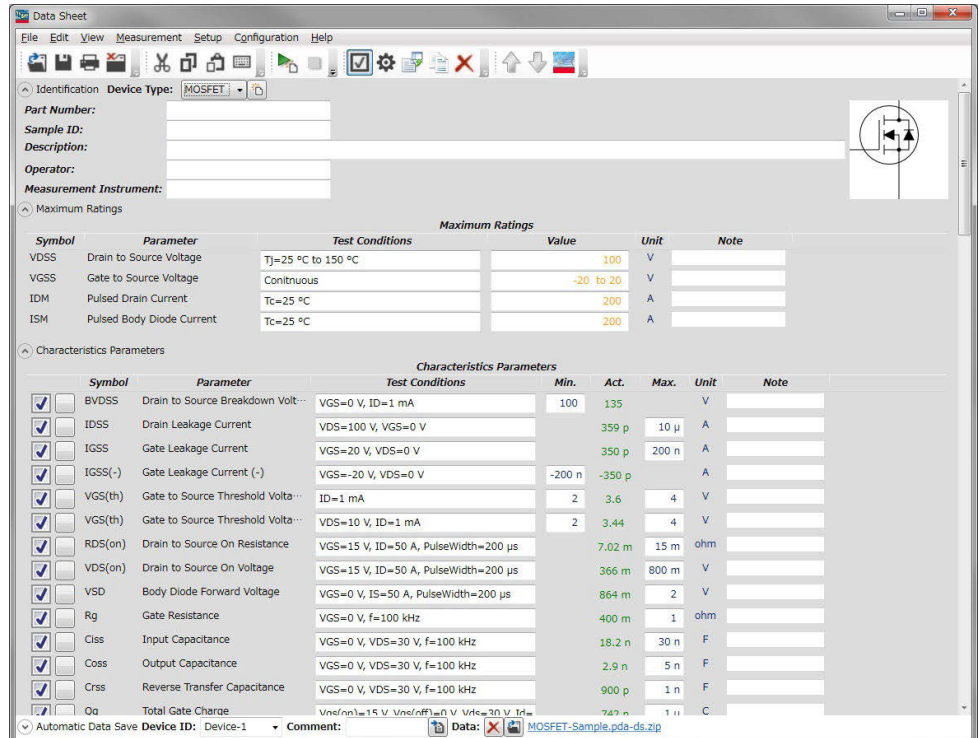

Preparing Measurement

WARNING

Set the instrument output off before connecting or disconnecting connection wire.

Press the mainframe front panel Stop key to set the source output off. And confirm that the mainframe front panel High Voltage indicator is not lit.

WARNING

To prevent electrical shock and DUT damage, do not connect or disconnect the DUT while the instrument is applying voltage or current.

When you touch the DUT after measurement, devise a countermeasure of residual charge and heat to prevent electrical shock and burn. Use glove and any tool. Also have enough time for discharge and radiation.

Step 1. Before starting the procedure, prepare accessories used for connecting your device under test (DUT). See the following section depending on the accessory.

- “3-pin Inline Package Socket Module” on page 2-20
- “Curve Tracer Test Adapter Socket Module” on page 2-21
- “Universal Socket Module Kit” on page 2-22
- “Gate Charge Socket Adapter” on page 2-25
- “Accessories for Connecting a DUT” on page 2-29

NOTE

If you would like to monitor/control temperature during measurement, perform the required connection and operation. “How To Monitor/Control Temperature Under Measurement” on page 3-51.

Step 2. Turn the instrument on.

Step 3. Measure the calibration data for capacitance measurement.

NOTE

The capacitance measurement software keeps the last measured calibration data. If the connection for the capacitance measurement is same as when the last calibration data was measured, this step can be skipped.

1. Connect the accessory used for DUT connection to the test fixture. Do not connect DUT at this time.
2. On the software palette, click Capacitance Measurement icon . The Capacitance Measurement software (Figure 3-3) opens.

3. Click Start Calibration... button on the toolbar to measure the calibration data.

Follow the instruction on the dialog box and measure the open and short calibration data.

Step 4. Measure the calibration data for gate charge measurement.

NOTE

The gate charge measurement software keeps the last measured calibration data. If the connection for the gate charge measurement is same as when the last calibration data was measured, this step can be skipped.

1. Remove the accessory and attach the gate charge socket adapter to the test fixture. Do not connect DUT at this time.
2. On the software palette, click Gate Charge Measurement icon . The Gate Charge Measurement software (Figure 3-4) opens.
3. Click Start Calibration... button on the toolbar to measure the calibration data.

Follow the instruction on the dialog box and measure the open and short calibration data.

Executing Measurement

Perform the measurement as the following steps:

NOTE

The following steps show the measurement example that uses the MOSFET as DUT.

- Step 1.** On the software palette, click Datasheet Characterization icon . The Datasheet Characterization software (Figure 3-1) opens.

- Step 2.** Select the device type of DUT, and load the corresponding template.

A template is a setup and measurement data file only for this software. It is called as ETN DS file.

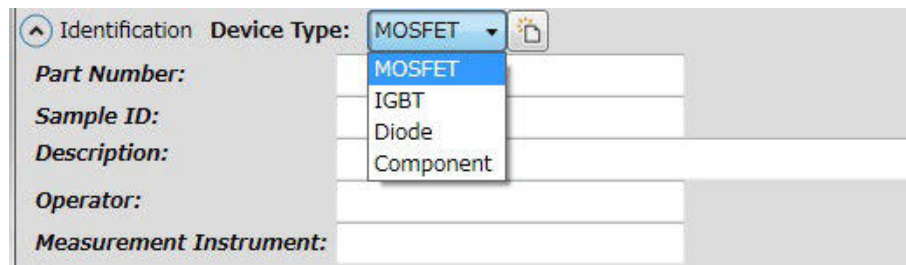



1. From the Device Type drop-down list on the upper work area, select the device type of DUT.

This example selects MOSFET.

2. Click New Datasheet button .

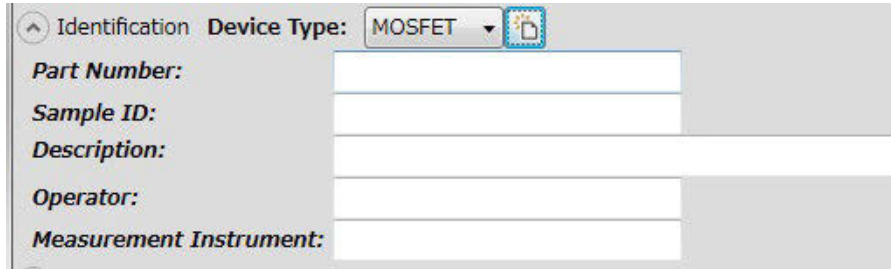
Step 3. Enter the information for device identification.



Identification **Device Type:** MOSFET 

Part Number:

Sample ID:

Description:

Operator:

Measurement Instrument:

You can enter the following information for device identification of DUT at Identification area on upper work area:

- Part Number** Part number of DUT
- Sample ID** Device ID of DUT
- Description** Device description or any additional information.
- Operator** Operator information
- Measurement Instrument** Measurement instrument information

Step 4. Specify the maximum ratings of DUT

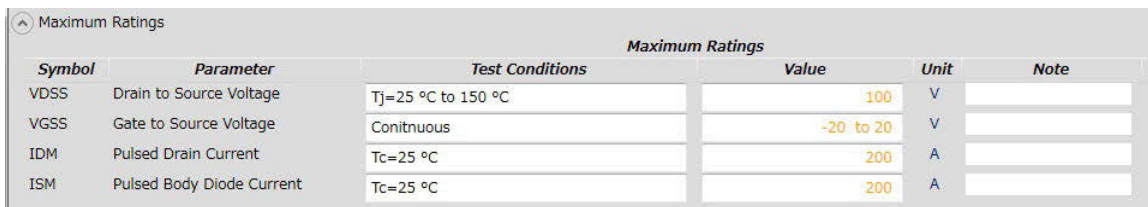

Maximum Ratings						
Symbol	Parameter	Test Conditions	Value	Unit	Note	
VDSS	Drain to Source Voltage	T _J =25 °C to 150 °C	100	V		
VGSS	Gate to Source Voltage	Conitnuous	-20 to 20	V		
IDM	Pulsed Drain Current	T _c =25 °C	200	A		
ISM	Pulsed Body Diode Current	T _c =25 °C	200	A		

Confirm the maximum rating parameters and parameter values set in the Maximum Ratings area, and edit them if needed.

The specified maximum rating values are used to limit the values of measurement conditions in the Characteristics Parameters area and Characteristics Graphs area.

- Symbol** Symbol of rating parameter

You can edit this by clicking on the text.
- Parameter** Rating parameter name

You can edit the name by clicking on the text.
- Test Condition** Conditions for rating parameter

You can edit the condition by clicking on the text. To close the expanded editing fields, click the Close button .
- Value** Maximum rating value

You can edit the maximum rating value by clicking on the value. To close the expanded editing fields, click the Close button .
- Note** Note

You can add any text for remarks by clicking the field.

Step 5. Select characteristics measurement items to be measured and enter measurement conditions



Characteristics Parameters							
Symbol	Parameter	Test Conditions	Min.	Act.	Max.	Unit	Note
<input checked="" type="checkbox"/>	BVDS	Drain to Source Breakdown Volt...	VGS=0 V, ID=1 mA	100	135	V	
<input checked="" type="checkbox"/>	IDSS	Drain Leakage Current	VDS=100 V, VGS=0 V	359 p	10 μ	A	
<input checked="" type="checkbox"/>	IGSS	Gate Leakage Current	VGS=20 V, VDS=0 V	350 p	200 n	A	
<input checked="" type="checkbox"/>	IGSS(-)	Gate Leakage Current (-)	VGS=-20 V, VDS=0 V	-200 n	-350 p	A	
<input checked="" type="checkbox"/>	VGS(th)	Gate to Source Threshold Volta...	ID=1 mA	2	3.6	4	V
<input checked="" type="checkbox"/>	VGS(th)	Gate to Source Threshold Volta...	VDS=10 V, ID=1 mA	2	3.44	4	V
<input checked="" type="checkbox"/>	RDS(on)	Drain to Source On Resistance	VGS=15 V, ID=50 A, PulseWidth=200 μs	7.02 m	15 m	ohm	
<input checked="" type="checkbox"/>	VDS(on)	Drain to Source On Voltage	VGS=15 V, ID=50 A, PulseWidth=200 μs	366 m	800 m	V	
<input checked="" type="checkbox"/>	VSD	Body Diode Forward Voltage	VGS=0 V, IS=50 A, PulseWidth=200 μs	864 m	2	V	
<input checked="" type="checkbox"/>	Rg	Gate Resistance	VGS=0 V, f=100 kHz	400 m	1	ohm	
<input checked="" type="checkbox"/>	Ciss	Input Capacitance	VGS=0 V, VDS=30 V, f=100 kHz	18.2 n	30 n	F	
<input checked="" type="checkbox"/>	Coss	Output Capacitance	VGS=0 V, VDS=30 V, f=100 kHz	2.9 n	5 n	F	
<input checked="" type="checkbox"/>	Crss	Reverse Transfer Capacitance	VGS=0 V, VDS=30 V, f=100 kHz	900 p	1 n	F	
<input checked="" type="checkbox"/>	Qg	Total Gate Charge	Vgs(on)=15 V, Vgs(off)=0 V, Vds=30 V, Id=	742 n	1 μ	C	
<input checked="" type="checkbox"/>	Qgs	Gate to Source Charge	Vgs(on)=15 V, Vgs(off)=0 V, Vds=30 V, Id=	87 n	100 n	C	

Characteristics Parameters area shows the pre-defined characteristics parameters. Each parameter corresponds to a measurement item.

1. Mark the check box at left side of row to select the characteristics parameter to be measured.
2. The following column of each characteristics parameter line shows the following conditions. Confirm the conditions and enter the conditions.

Measurement

Priority

Click the button on the right-hand side of the check box, if necessary. You can change the priority of the execution for the measurement.

: 1st priority

: 2nd priority

: 3rd priority

Symbol

Symbol of characteristics parameter.

You can edit this by clicking on the text.

Parameter

Name of characteristics parameter.

You can edit the name by clicking on the text.

Test Conditions

Conditions for characteristics parameter.

You can edit the condition by clicking on the text. To close the expanded editing fields, click the Close button .

Min.

Lower limit of expected range of characteristics parameter.

You can enter the value by clicking on the value.

If lower limit is unavailable, the field is not effective.

Act.

Measured value of characteristics parameter.

If a measured value is out of expected range, which is from Min. to Max., a measured value is displayed in red italics.

Max.

Upper limit of expected range of characteristics parameter.

You can enter the value by clicking on the value.

If upper limit is unavailable, the field is not effective.

Note Remarks.

You can enter the value by clicking on the field.

NOTE

To measure same measurement item under the different conditions

If you would like to measure same measurement item under the different conditions, do as following instruction:

1. To select a characteristics parameter to be measured, click on the corresponding line.
2. Click Duplicate button  on the toolbar.

The a duplicate line of selected characteristics parameter is added under the selected line.

3. Change the conditions on a duplicate line.

Step 6. Select characteristics graph to be measured

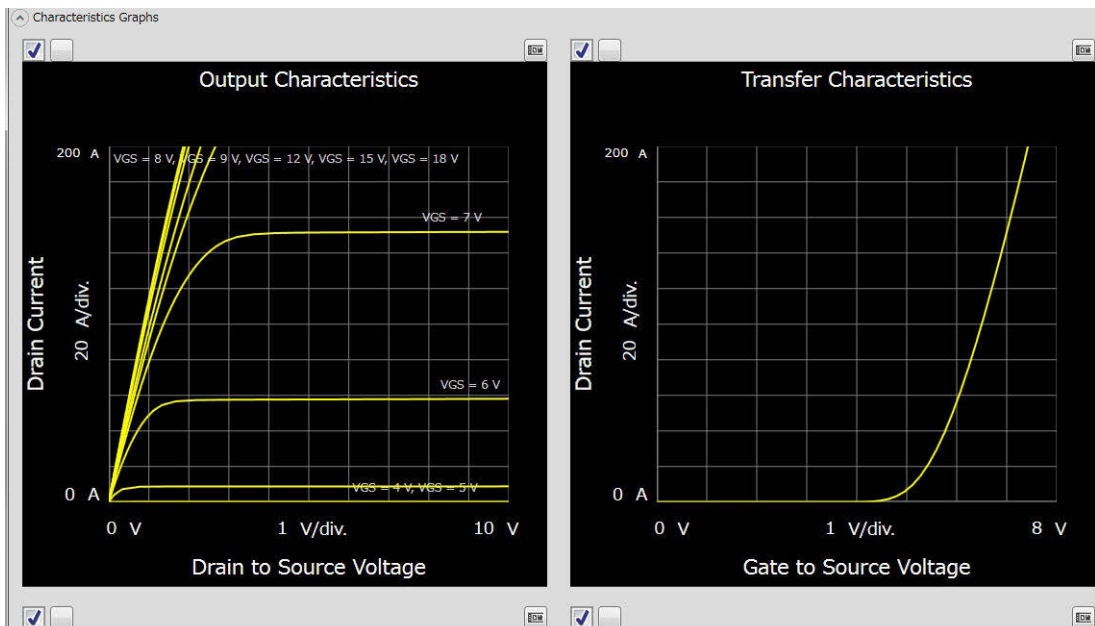

Characteristics Graphs area shows the pre-defined characteristics graphs. Each characteristics graph corresponds to a measurement item.

1. Mark the check box at upper left of graph to select the characteristics graph to be measured.
2. Click the button on the right-hand side of the check box, if necessary. You can change the priority of the execution for the measurement with similar uses as the setting of the measurement priority in the Characteristics Parameters area.
3. To change the maximum or minimum value of the X and Y-axis, click on the value.

If an X or Y-axis corresponds to voltage or current output value, the minimum and maximum values also specify the output range on measurement.

4. You can change the title of characteristics graph, the labels of X and Y-axis by clicking on them.

Step 7. Click the Start Measurement tool button  to start measurement.

The Connection dialog opens. Then, sets up and connect the DUT for the I/V measurement and the capacitance measurement.



1. Connect the accessory used for DUT connection to the test fixture.
2. Connect your DUT by using the accessory.
3. Close the test fixture cover.
4. Click the OK button. The marked measurement items related to the I/V and capacitance measurement are executed.

For the execution order of the measurement items, see “Execution Order of Measurement Items” on page 4-15.

During measurement, you can stop the measurement by clicking the Stop Measurement tool button .

During the measurement execution, the measured values of each measurement item are updated on Act. column of corresponding line at Characteristics Parameters or on the corresponding characteristics graph at Characteristics Graphs.

- Step 8.** After all measurements by the I/V measurement software and the capacitance measurement software are completed, the Connection dialog opens. Then, change the DUT connection setup to that for the gate charge measurement.

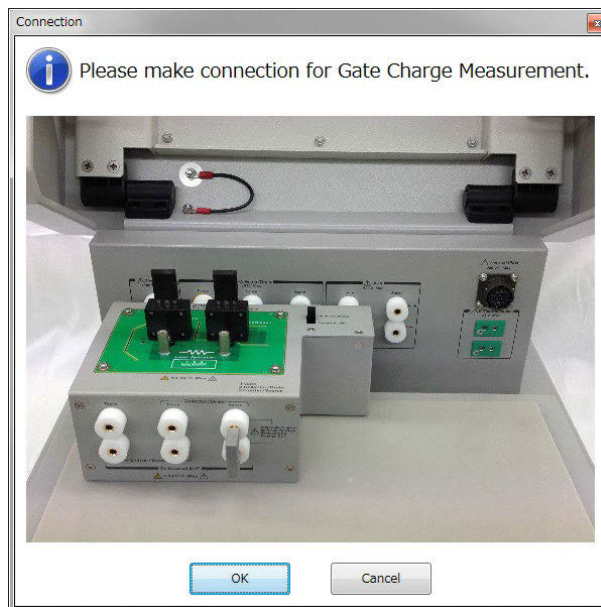

1. Open the test fixture cover and remove the accessory from the test fixture.
2. Attach the gate charge socket adapter to the test fixture.

How To Perform Measurement

How To Perform Datasheet Characterization

3. Set your DUT on the gate charge socket adapter.
4. Close the test fixture cover.
5. Click the OK button. The measurement for the selected gate charge measurement items is started.

For the execution order of the measurement items, see “Execution Order of Measurement Items” on page 4-15.

Step 9. After all measurements are completed, the setup data and the measurement data are automatically stored in the ETN DS file. The ETD DS file is the setup and measurement data file only for the datasheet characterization software.

How To Perform I/V Measurement

This section describes how to perform a measurement using the I/V measurement software and consists of the following sub-sections:

- Preparing Measurement
- Executing Measurement
- Monitoring Voltage/Current Waveforms
- Setting Parameter

Figure 3-2 I/V Measurement Software

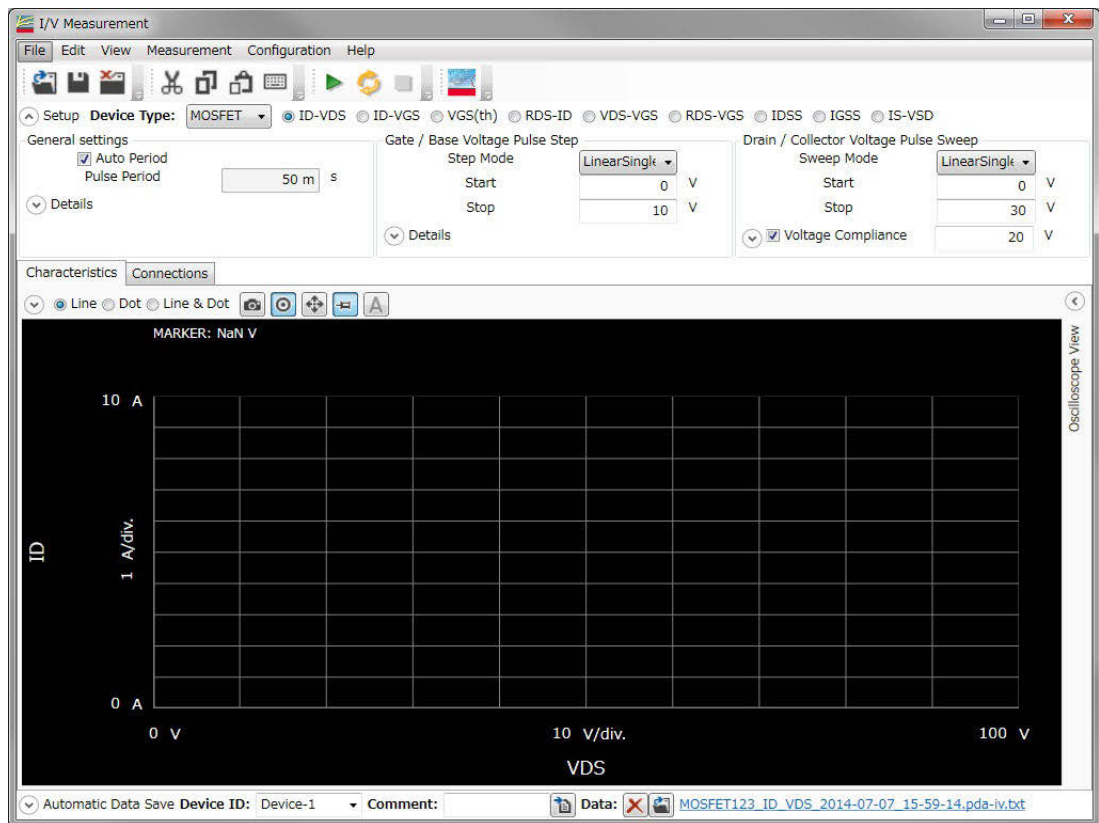

Preparing Measurement

WARNING

Set the instrument output off before connecting or disconnecting connection wire.

Press the mainframe front panel Stop key to set the source output off. And confirm that the mainframe front panel High Voltage indicator is not lit.

WARNING

To prevent electrical shock and DUT damage, do not connect or disconnect the DUT while the instrument is applying voltage or current.

When you touch the DUT after measurement, devise a countermeasure of residual charge and heat to prevent electrical shock and burn. Use glove and any tool. Also have enough time for discharge and radiation.

Step 1. Before starting the procedure, prepare an accessory used for connecting your device under test (DUT). See the following section depending on the accessory.

- “3-pin Inline Package Socket Module” on page 2-20
- “Curve Tracer Test Adapter Socket Module” on page 2-21
- “Universal Socket Module Kit” on page 2-22
- “Accessories for Connecting a DUT” on page 2-29

Step 2. Turn the instrument on. After that, connect your DUT to the test fixture by using the accessory.

If your DUT is diode, connect a cathode terminal of your DUT to the Collector/Drain terminal of test fixture and an anode terminal of your DUT to the Emitter/Source terminal of test fixture.

NOTE

If you would like to monitor/control temperature during measurement, perform the required connection and operation. See “How To Monitor/Control Temperature Under Measurement” on page 3-51.

Executing Measurement

NOTE

This section explains the procedure using an example that selects MOSFET as a device type of DUT and ID-VDS as a measurement item.

Execute a measurement as follows:

- Step 1.** On the software palette, click the I/V Measurement icon . The I/V Measurement Software (Figure 3-2) opens.
- Step 2.** At the Setup area in work area, select a device type and measurement item to be measured.

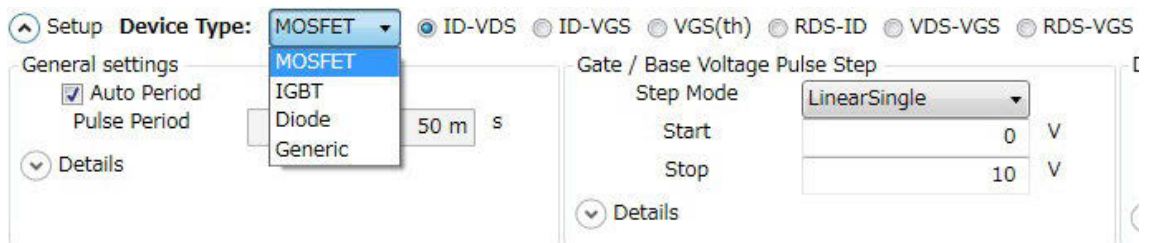

- Device Type

From the Device Type drop-down list, select a device type.

This example selects MOSFET.

- Measurement Item

From the radio buttons located on the right of a Device Type selection, which is MOSFET in this example, select a measurement item to be measured.

This example selects ID-VDS.

For information on the available device types and measurement items, see Table 3-1 on page 3-23

By selecting a device type and measurement item, the setup items displayed in the Setup area are automatically switched.

Step 3. Enter or select the setup conditions for the gate of MOSFET in Gate/Base Voltage Pulse Step at the center of Setup area.

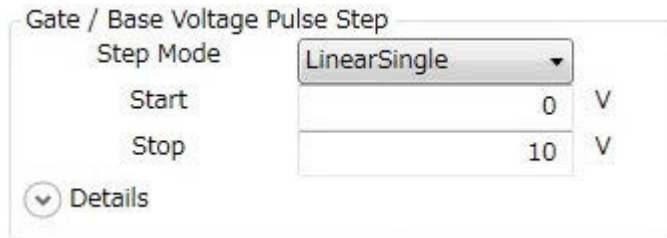

- Selecting Step Mode

From the Step Mode drop-down list, select a step mode of pulse voltage output.

LinearSingle Outputs voltage level changes from the Start value to the Stop value at equal intervals.

ListSingle Specify the output voltages of each step in the List. Each step voltage in the List will be output in order from top to bottom.

This example selects the ListSingle.

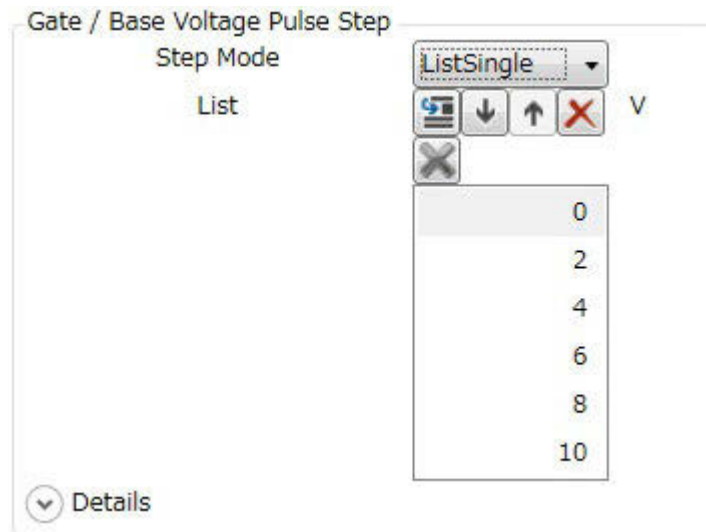



- To change step values

Click the value in the List and you can change it to new value.

- To insert new step value

Select the step value immediately after where you want to insert new step value and click the Insert button .

- To change an output order of step values

Click the Move Down and the Move Up buttons   to move down or up an order of the selected step value.

- To delete a step value

Click the Delete button  to delete the selected step value.

By clicking the **Details** button, the area expands to set more detail conditions.

For more information on setting items, see “Setup” on page 4-58.

- Step 4.** Enter or select the setup conditions for the drain of MOSFET in Drain/Collector Voltage Pulse Sweep at the right side of Setup area.

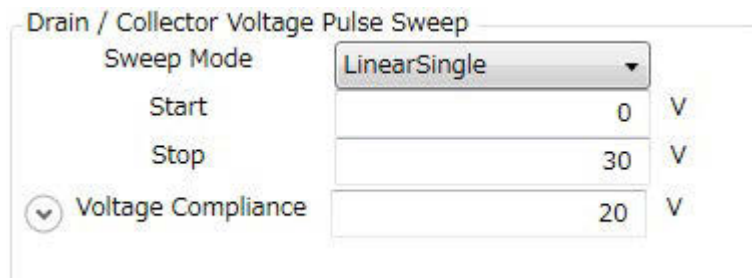

Drain / Collector Voltage Pulse Sweep

Sweep Mode	LinearSingle	
Start	0	V
Stop	30	V
Voltage Compliance	20	V

Select or specify a sweep mode, a sweep start value, a sweep stop value, and a voltage compliance.

- Sweep Mode

Select a sweep mode from the Sweep Mode drop-down list.

LinearSingle One-way linear sweep from the Start (sweep start value) to the Stop (sweep stop value).

LogSingle One-way logarithmic sweep from the Start (sweep start value) to the Stop (sweep stop value).

LinearDouble Linear-sweep from the Start (sweep start value) to the Stop (sweep stop value) and then return linear-sweep from the Stop to the Start.

LogDouble Logarithmic-sweep from the Start (sweep start value) to the Stop (sweep stop value) and then return logarithmic-sweep from the Stop to the Start.

- Start, Stop

Enter the sweep start value in the Start and the sweep stop value in the Stop.

- Voltage Compliance

Enter the voltage compliance value in the Voltage Compliance.

If the output voltage of measurement unit connected to a drain terminal is more than this value, a measurement unit stops the output.

By clicking the **Details** button, the area expands to set more detail conditions.

For more information on setting items, see “Setup” on page 4-58.

- Step 5.** Enter the setup conditions for the pulse output in General settings at the left side of Setup area.



Auto Period Automatic adjustment for the pulse period.
To enable this function, mark the check box.

Pulse Period Pulse period.
However, if the Auto Period function is enabled, the pulse period is automatically adjusted to a minimum period corresponding to the pulse width.

Step 6. Click the Connections tab to display Connections area.

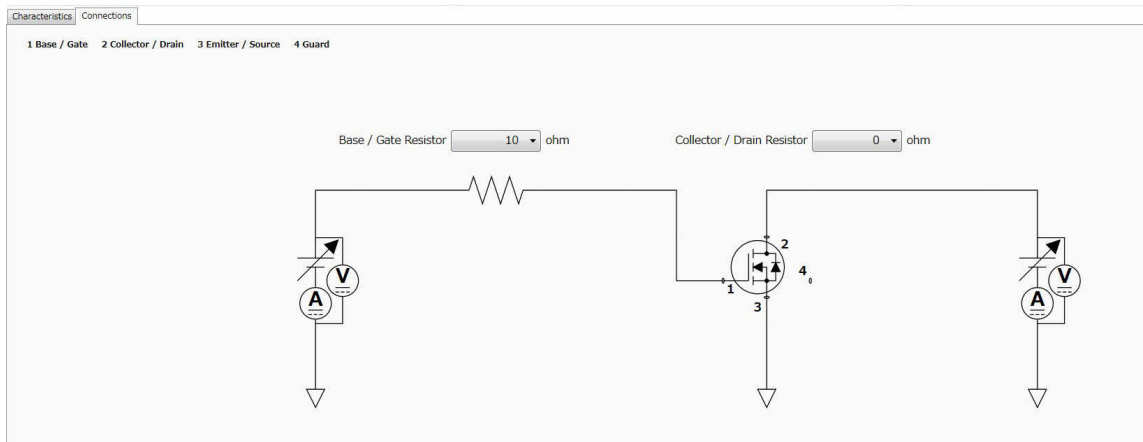

At Connections area, you can confirm a measurement circuit.

Also, you can select a gate resistor/drain resistor that may be effective to suppress a device oscillation during measurement.

- Base/Gate Resistor

You can select a gate resistor from this drop-down list.

A gate resistor may be effective to suppress a device oscillation during large current measurement.

NOTE

You can select a gate resistor only if a measurement resource is MCSMU.

In this example, which selects MOSFET as a device type and ID-VDS as a measurement item, the default measurement resource is MCSMU and you can select a gate resistor.

- Collector/Drain Resistor

You can select a drain resistor from this drop-down list.

A drain resistor may be effective to suppress a over current during a break-down measurement.

NOTE

You can select a drain resistor only if a measurement resource is HVSMU.

In this example, which selects MOSFET as a device type and ID-VDS as a measurement item, the default measurement resource is UHCU and a drain resistor is fixed to $0\ \Omega$.

Step 7. Click the Start Measurement tool button  to start a measurement.

Or, click the Repeat Measurement tool button  to repeat a measurement.

After starting a measurement, you can stop a measurement by clicking the Stop Measurement tool button .

Step 8. Click the Characteristics tab to display the Characteristics area.

After a measurement is completed, a measured I/V characteristics curve is displayed on the Characteristics area. This example shows an ID-VDS characteristics curve.

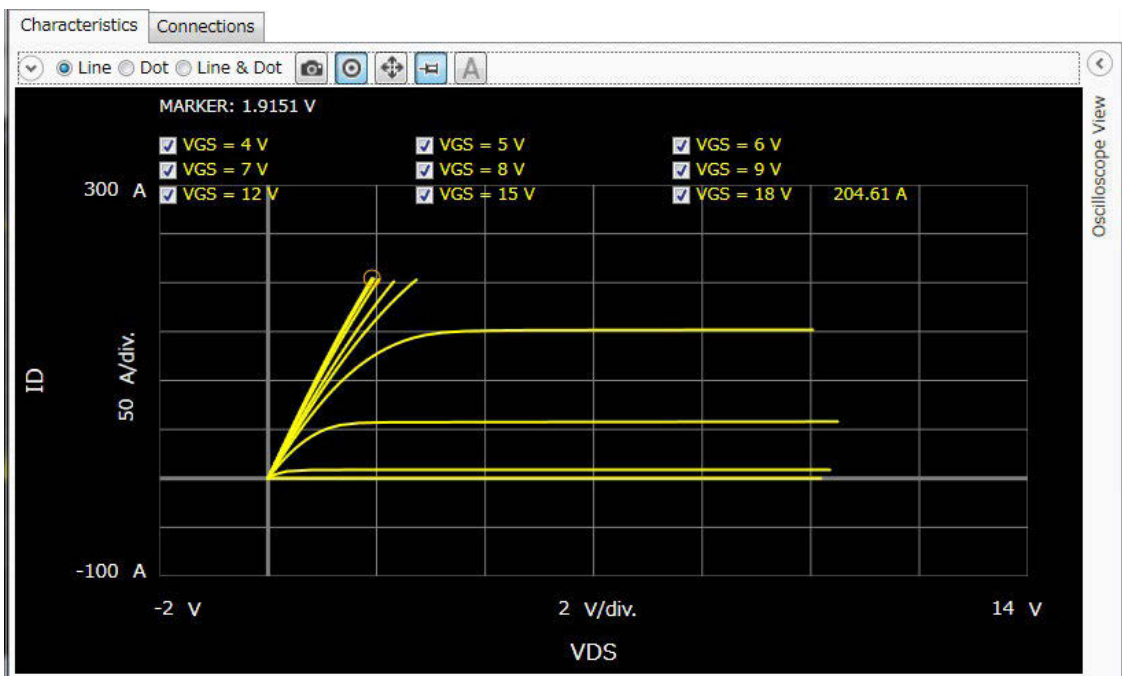



For the operation on the graph display, see “Displaying and Operating Graph” on page 3-57.

Monitoring Voltage/Current Waveforms

The I/V measurement software can monitor both voltage and current waveforms for the measurement channels at the specified measurement point on the characteristic trace when the measurement is in the pulse mode operation.

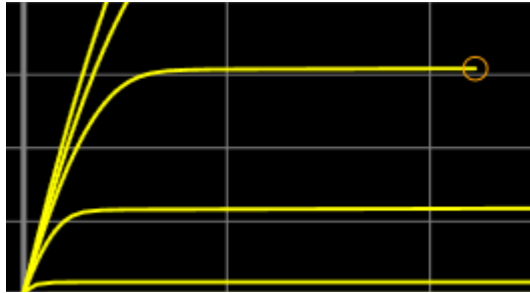
- Step 1.** Click the Characteristics tab to display the Characteristics area.
- Step 2.** Click the Oscilloscope View  button to display the Oscilloscope View area.
- Step 3.** Execute the I/V measurement according to the steps described in “Executing Measurement” on page 3-15.
- Step 4.** Move the trace marker on the Characteristics graph to specify the observation point.



- Step 5.** Click the Start Measurement tool button  to start a measurement.

Or, click the Repeat Measurement tool button  to repeat a measurement.

After starting a measurement, you can stop a measurement by clicking the Stop Measurement tool button .

How To Perform Measurement
How To Perform I/V Measurement

After measuring the specified point, the observation point on the characteristics graph is identified by a monitor marker (green frame), and the time domain waveform(s) is displayed on this area.

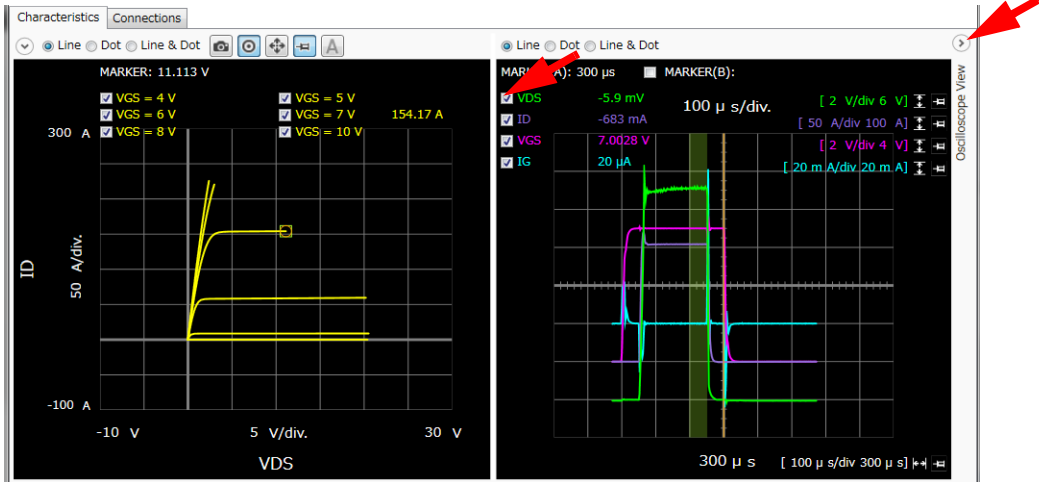

In the case of the repeat measurement, you can move the trace marker to change the observation point during the measurement. After measuring the changed point, the monitor maker moves to the point and the waveforms are updated.

Step 6. Mark the check boxes for the voltage or current data names the measurement channels that you want to monitor.

Setting Parameter

Table 3-1 Available Device Types and Measurement Items

Device Type	Measurement Item	Description
MOSFET	ID-VDS	ID-VDS output characteristics
	ID-VGS	ID-VGS transmission characteristics
	RDS-ID	RDS (Drain to Source resistance) - ID characteristics
	VGS(th)	Gate to Source Threshold voltage
	VDS-VGS	VDS-VGS characteristics
	RDS-VGS	RDS (Drain to Source resistance) - VGS characteristics
	IDSS	Drain leak current - VDS characteristics
	IGSS	Gate leak current - VGS characteristics
	IS-VSD	Forward current of body diode - VSD characteristics
IGBT	IC-VCE	IC-VCE output characteristics
	IC-VGE	IC-VGE transmission characteristics
	VGE(th)	Gate to Emitter Threshold voltage
	VCE-VGE	VCE-VGE characteristics
	VCE(sat)	VCE(sat) (Collector to Emitter saturation voltage) - IC characteristics
	ICES	Collector leak current - VCE characteristics
	IGES	Gate leak current - VGE characteristics
	IF-VF	Forward characteristics of free wheel diode
Diode	IF-VF	Forward bias current - voltage characteristics
	IR-VR	Reverse bias current - voltage characteristics

How To Perform Measurement
How To Perform I/V Measurement

Device Type	Measurement Item	Description
Generic2T	Conduction	Conduction resistance characteristics
	Isolation	Isolation characteristics
Generic		Free setup on the measurement units connection and measurement conditions.

How To Perform Capacitance Measurement

This section describes how to perform a measurement using the capacitance measurement software which is available for the B1506A-H21/H51/H71.

This section consists of the following sub-sections:

- Preparing Measurement
- Executing Measurement
- Setting Parameter

Figure 3-3 Capacitance Measurement Software

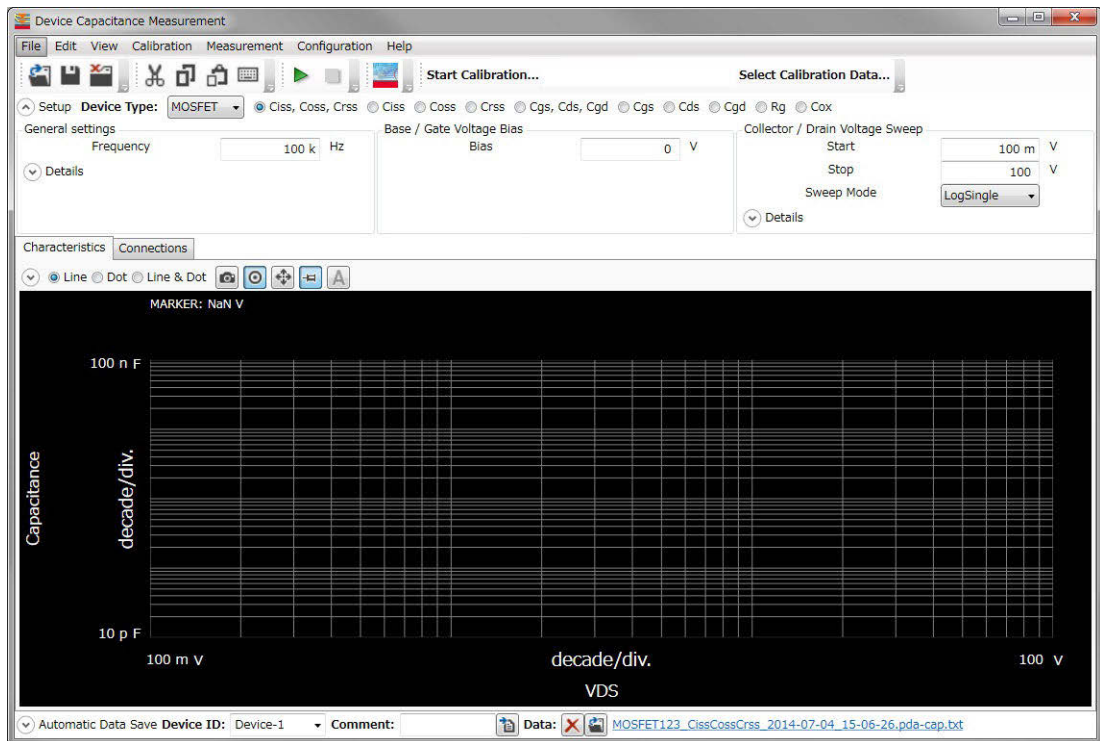

Preparing Measurement

WARNING

Set the instrument output off before connecting or disconnecting connection wire.

Press the mainframe front panel Stop key to set the source output off. And confirm that the mainframe front panel High Voltage indicator is not lit.

WARNING

To prevent electrical shock and DUT damage, do not connect or disconnect the DUT while the instrument is applying voltage or current.

When you touch the DUT after measurement, devise a countermeasure of residual charge and heat to prevent electrical shock and burn. Use glove and any tool. Also have enough time for discharge and radiation.

Step 1. Before starting the procedure, prepare an accessory used for connecting your device under test (DUT). See the following section depending on the accessory.

- “3-pin Inline Package Socket Module” on page 2-20
- “Curve Tracer Test Adapter Socket Module” on page 2-21
- “Universal Socket Module Kit” on page 2-22
- “Accessories for Connecting a DUT” on page 2-29

Step 2. Turn the instrument on.

NOTE

If you would like to monitor/control temperature during measurement, perform the required connection and operation. For more information, see “How To Monitor/Control Temperature Under Measurement” on page 3-51.

Executing Measurement

NOTE

This section explains the procedure using an example that selects MOSFET as a device type of DUT and Ciss, Coss, Crss as a measurement item.

Execute a measurement as follows:

Step 1. On the software palette, click the Capacitance Measurement icon . The Capacitance Measurement software (Figure 3-3) opens.

Step 2. At the Setup area in work area, select a device type of your DUT and a measurement item to be measured.

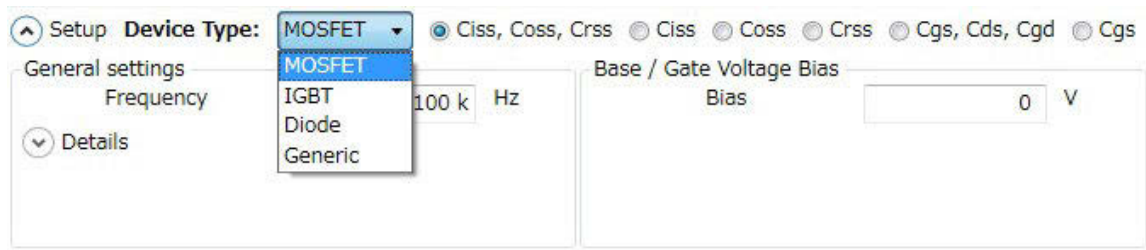

- Device Type

Select a device type from the Device Type drop-down list.

This example selects MOSFET.

- Measurement Item

From the radio buttons located on the right of a Device Type selection, which is MOSFET in this example, select a measurement item to be measured.

This example selects Ciss, Coss, Crss.

For information on the available device types and measurement items, see Table 3-2 on page 3-30

By selecting a device type and measurement item, the setup items displayed in the Setup area are automatically switched.

Step 3. Enter the measurement frequency in the Frequency of General settings located at the left part of Setup area.



By clicking the **Details** button, the area expands to set more detail conditions.

For more information on setting items, see “Setup” on page 4-92.

- Step 4.** Enter the bias voltage value in the Bias of Base/Gate Voltage Bias at the center of Setup area.



- Step 5.** Enter or select the voltage sweep conditions in the Collector/Drain Voltage Sweep at the right of Setup area.



Start Enter a start voltage value of sweep.

Stop Enter a stop voltage value of sweep.

Sweep Mode Select a sweep mode.

LinearSingle One-way linear sweep from the Start to the Stop.

LogSingle One-way logarithmic sweep from the Start to the Stop.

LinearDouble Linear-sweep from the Start to the Stop and then return linear-sweep from the Stop to the Start.

LogDouble Logarithmic-sweep from the Start to the Stop and then return logarithmic-sweep from the Stop to the Start.

By clicking the **Details** button, the area expands to set more detail conditions.

For more information on setting items, see “Setup” on page 4-92.

- Step 6.** Click the Start Calibration... button in the toolbar to measure the calibration data of measurement path.

Follow the instruction displayed on the dialog box to measure the open and short calibration data.

If you have measured and saved the calibration data of measurement path, click the Select Calibration Data... button in the toolbar to select and load the stored calibration data.

Step 7. Connect your DUT. And click the Start Measurement button  to start a measurement.

You can stop the measurement by clicking the Stop Measurement button  during a measurement execution.

NOTE

If your DUT is diode, connect the cathode of your DUT to the Collector/Drain terminal of the test fixture and the anode of your DUT to the Emitter/Source terminal of the test fixture.

Step 8. Click the Characteristics tab to display the Characteristics area.

After a measurement is completed, a measured capacitance characteristics curve is displayed on the Characteristics area. This example shows the Ciss, Coss, and Crss, characteristics curves.

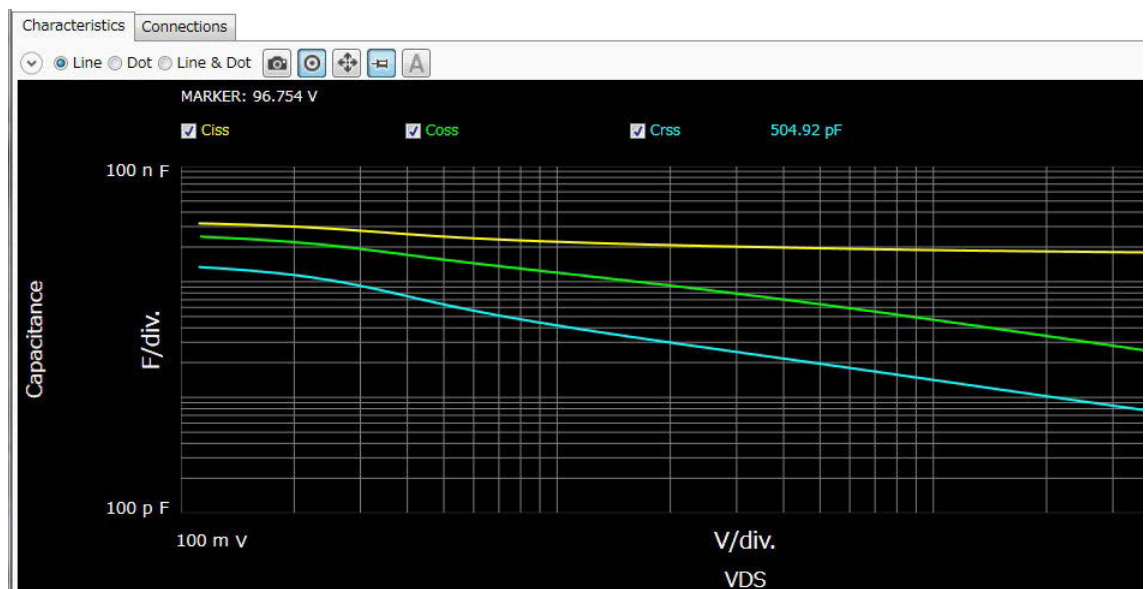

For the operation on the graph display, see “Displaying and Operating Graph” on page 3-57.

Setting Parameters

Table 3-2 Available Device Types and Measurement Items

Device Type	Measurement Item	Description
MOSFET	Ciss	Ciss (Input capacitance) - Vds characteristics
	Coss	Coss (Output capacitance) - Vds characteristics
	Crss	Crss (Feedback capacitance) - Vds characteristics
	Ciss, Coss, Crss	Ciss, Coss, and Crss characteristics
	Cgs	Cgs (Gate to Source capacitance) - Vds characteristics
	Cds	Cds (Drain to Source capacitance) - Vds characteristics
	Cgd	Cgd (Gate to Drain capacitance) - Vds characteristics
	Cgs, Cds, Cgd	Cgs, Cds, and Cgd characteristics
	Rg	Rg (Gate resistance) - Vgs characteristics
	Cox	Cox (Gate oxide film capacitance) - Vgs characteristics
IGBT	Cies	Cies (Input capacitance) - Vce characteristics
	Coes	Coes (Output capacitance) - Vce characteristics
	Cres	Cres (Feedback capacitance) - Vce characteristics
	Cies, Coes, Cres	Cies, Coes, and Cres characteristics
	Cge	Cge (Gate to Emitter capacitance) - Vce characteristics
	Cce	Cce (Collector to Emitter capacitance) - Vce characteristics
	Cgc	Cgc (Gate to Collector capacitance) - Vce characteristics
	Cge, Cce, Cgc	Cge, Cce, and Cgc characteristics
	Rg	Rg (Gate resistance) - Vge characteristics

Device Type	Measurement Item	Description
Diode	CT	Total capacitance at reverse bias to bias voltage characteristics
Generic	Sweep Voltage Between Terminal 2-3	Cp-G model capacitance between Collector/Drain terminal and Emitter/Source terminal to Vce/Vds characteristics
	Sweep Voltage Between Terminal 1-3	Cs-Rs model capacitance between Base/Gate terminal and Emitter/Source terminal to Vbe/Vgs characteristics

How To Perform Gate Charge Measurement

This section describes how to perform a measurement using the gate charge measurement software which is available for the B1506A-H21/H51/H71.

This section consists of the following sub-sections:

- Preparing Measurement
- Executing Measurement

Figure 3-4 Gate Charge Measurement Software

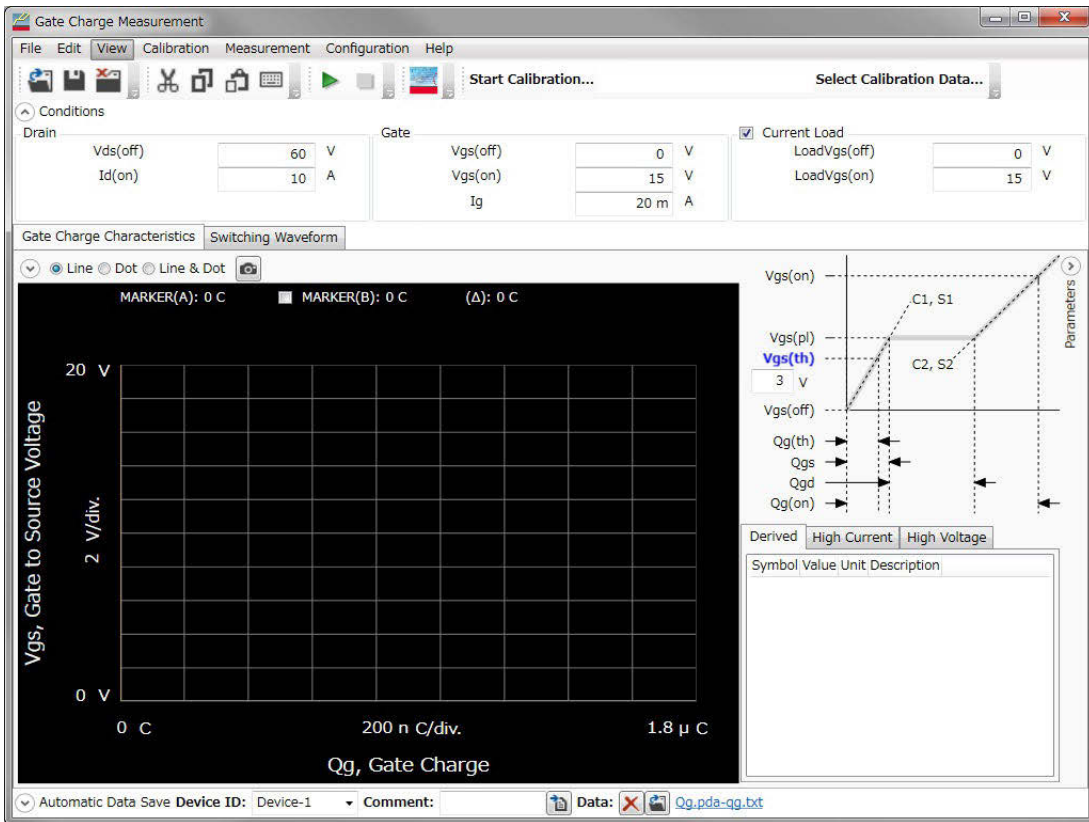

Preparing Measurement

WARNING

Set the instrument output off before connecting or disconnecting connection wire.

Press the mainframe front panel Stop key to set the source output off. And confirm that the mainframe front panel High Voltage indicator is not lit.

WARNING

To prevent electrical shock and DUT damage, do not connect or disconnect the DUT while the instrument is applying voltage or current.

When you touch the DUT after measurement, devise a countermeasure of residual charge and heat to prevent electrical shock and burn. Use glove and any tool. Also have enough time for discharge and radiation.

Step 1. Before starting the procedure, prepare the gate charge socket adapter. See “Gate Charge Socket Adapter” on page 2-25.

Step 2. Turn the instrument on.

NOTE

If you would like to monitor/control temperature during measurement, perform the required connection and operation. For more information, see “How To Monitor/Control Temperature Under Measurement” on page 3-51.

Executing Measurement

Execute a measurement as follows:

Step 1. On the software palette, click the Gate Charge Measurement icon . The Gate Charge Measurement software (Figure 3-4) opens.

Step 2. Enter the measurement conditions at the Condition area.



Conditions	
Drain	
Vds(off)	60 V
Id(on)	10 A
Gate	
Vgs(off)	0 V
Vgs(on)	15 V
Ig	20 m A
<input checked="" type="checkbox"/> Current Load	

Drain

Specify the drive conditions for the drain of your device under test (DUT).

- Vds(off)

Enter the voltage to force between drain and source of DUT at the off-state.

- Id(on)

Enter the drain current to force to DUT at the on-state if the constant current load (Current Load) is used.

If the constant current load is not used, the drain current at the on-state is determined by the Vds(off), the resistance of resistive load, and the on-state resistance/saturation voltage. For the current output range of measurement resource, the minimum range that includes Id(on) is automatically selected.

Gate

Specify the gate drive conditions of DUT.

- Vgs(off)

Enter the gate-source voltage that turns the DUT to the off-state.

- Vgs(on)

Enter the gate-source voltage that turns the DUT to the complete on-state.

- I_g

Enter the limit value of gate current.

This setting effects the switching time. The larger limit causes the shorter switching time and the smaller limit causes the longer switching time.

Current Load Mark the check box if the constant current load is used.

0	V
15	V
20 m	A

Current Load

LoadVgs(off) 0 V

LoadVgs(on) 15 V

Specify the gate drive conditions of the constant current load transistor so that the constant current load transistor forces the current as same as $I_d(\text{on})$ specified in the Drain.

If you do not use the constant current load but use the resistive load, unmark the Current Load check box.

- LoadVgs(off)

Enter the gate-source voltage that turns the constant current load transistor to the off-state.

- LoadVgs(on)

Enter the gate-source voltage that turns the constant current load transistor to the complete on-state.

Step 3. Click the Start Calibration... button in the toolbar to measure the calibration data of measurement path.

Follow the instruction displayed on the dialog box to measure the open and short calibration data.

If you have measured and saved the calibration data of measurement path, click the Select Calibration Data... button in the toolbar to select and load the stored calibration data.

Step 4. Connect your DUT. And click the Start Measurement button  to start a measurement.

You can stop the measurement by clicking the Stop Measurement button  during a measurement execution.

Step 5. Click the Gate Charge Characteristics tab to display the Gate Charge Characteristics area.

After a measurement is completed, a measured gate charge characteristics curve and extracted parameters are displayed on the Gate Charge Characteristics area.

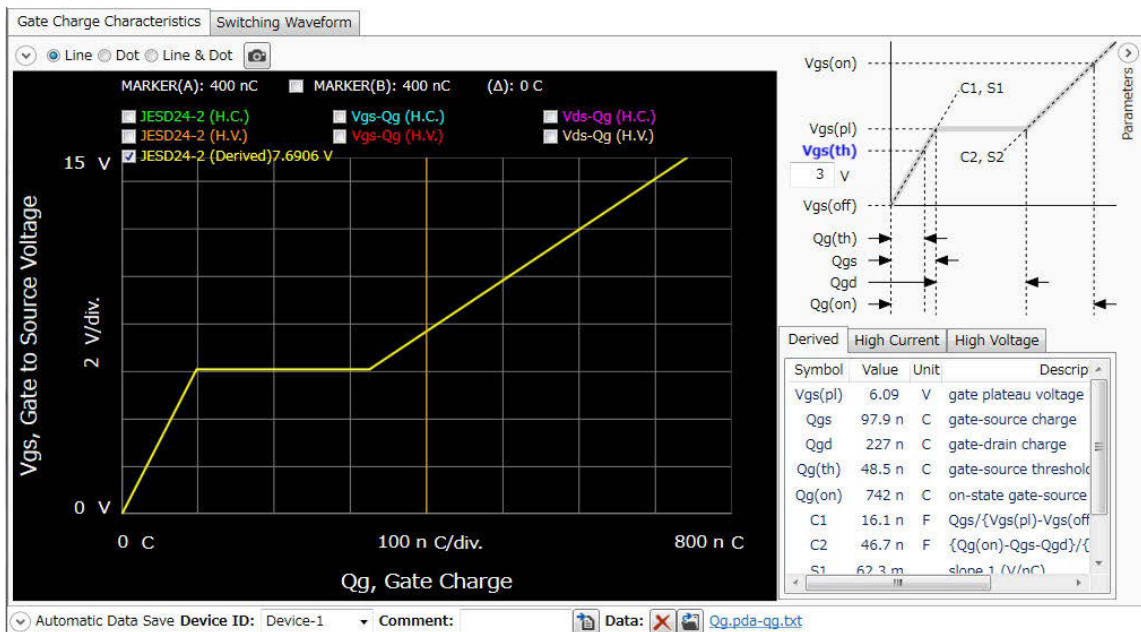

The left side shows the measured gate charge characteristics curve and the right side shows the extracted parameters.

Step 6. Displaying the gate charge characteristics curve

- To select the gate charge characteristics curve to be displayed

Mark the check box corresponding to the gate charge characteristics to display the characteristics curve.

You can select the multiple gate charge characteristics.

JESD24-2 (Derived)	Shows the approximation straight line of gate charge characteristics that measured under conditions of $V_{ds}(off)$ and $I_g(on)$ specified in “Drain”.
Vgs-Qg (H.C.)	Shows the gate charge characteristics that measured under the condition of $I_d(on)$ specified in “Drain”.
Vgs-Qg (H.V.)	Shows the gate charge characteristics that measured under the condition of $V_{ds}(off)$ specified in “Drain”.
JESD24-2 (H.C.)	Shows the approximation straight line of Vgs-Qg(H.C.) gate charge characteristics. The approximation is calculated on sloops (S_1 , S_2 , and S_3) defined in JEDEC Standard JESD24-2.
JESD24-2 (H.V.)	Shows the approximation straight line of Vgs-Qg(H.V.) gate charge characteristics. The approximation is calculated on sloops (S_1 , S_2 , and S_3) defined in JEDEC Standard JESD24-2.
Vds-Qg (H.C.)	Shows the relationship between the drain-source voltage and gate charge when the Vgs-Qg(H.C.) is measured.
Vds-Qg (H.V.)	Shows the relationship between the drain-source voltage and gate charge when the Vgs-Qg(H.V.) is measured.

By the radio buttons at the top of graph, you can select the line type of characteristics curve from Line, Dot, or (Line & Dot).

- Extracted Parameter Display

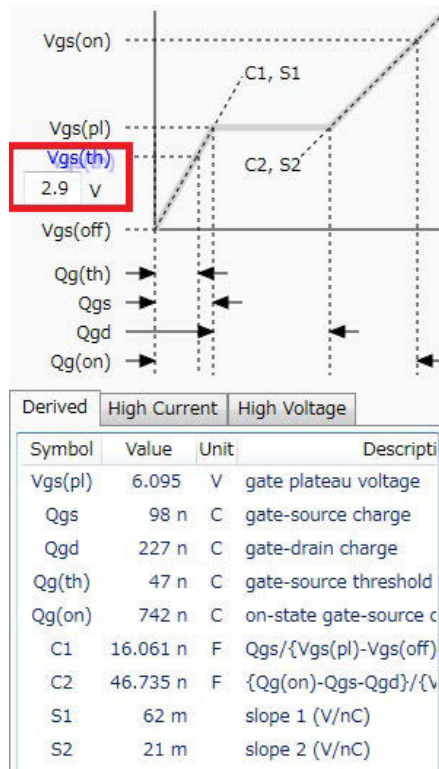

Enter the threshold voltage of DUT in the Vgs(th) at the upper of parameter display area.

The gate charge parameter values that extracted from the specified threshold voltage Vgs(th), and JESD24-2(Derived), JESD24-2(H.C.), and JESD24-2(H.V) are displayed in this area.

To show the gate charge parameters from JESD24-2(Derived), click the Derived tab.

To show the gate charge parameters from JESD24-2(H.C.), click the High Current tab.

To show the gate charge parameters from JESD24-2(H.V.), click the High Voltage tab.

The following gate charge parameters are displayed:

Vgs(pl) Gate plateau voltage

Qgs	Gate - source charge Gate charge for slope S_1 defined in JEDEC Standard JESD24-2.
Qgd	Gate - drain charge Gate charge for slope S_3 defined in JEDEC Standard JESD24-2.
Qg(th)	Gate-source charge at threshold Gate charge from $V_{gs(off)}$ to $V_{gs(th)}$.
Qg(on)	Gate-source charge in on-state Gate charge from $V_{gs(off)}$ to $V_{gs(on)}$.
C1	$Q_{gs} / \{V_{gs(pl)} - V_{gs(off)}\}$ Equivalent capacitance for slope S_1 defined in JEDEC Standard JESD24-2
C2	$\{Q_{gs(on)} - Q_{gs} - Q_{gd}\} / \{V_{gs(on)} - V_{gs(pl)}\}$ Equivalent capacitance for slope S_2 defined in JEDEC Standard JESD24-2.
S1	Slope S_1 defined in JEDEC Standard JESD24-2
S2	Slope S_2 defined in JEDEC Standard JESD24-2

For more information on the operation for graph display, see “Displaying and Operating Graph” on page 3-57.

How To Calculate Power Loss

This section describes how to calculate the power loss at a switching device using the power loss calculation software which is available for the B1506A-H21/H51/H71.

This section consists of the following sub-sections:

- Calculating Power Loss
- Extracted Parameters By Power Loss Calculation

The power loss calculation software calculates the power loss from the drive conditions and the device characteristics parameters of DUT.

There are the following two ways to specify the parameters for calculation:

- Specify the parameter values from the datasheet of DUT.

If you want to calculate the power loss of DUT at the different drive conditions or there are the parameters that are not specified in the datasheet, you may specify the predicted values.

- Measure the switching device by the I/V measurement software, capacitance measurement software, and gate charge measurement software at your desired drive conditions and store the measurement data. Then, the power loss calculation software read the stored measurement data and extract the required drive conditions and characteristics parameters for power loss calculation.

This section explains the procedure that specify the measurement data file of DUT.

Figure 3-5 Power Loss Calculation Software

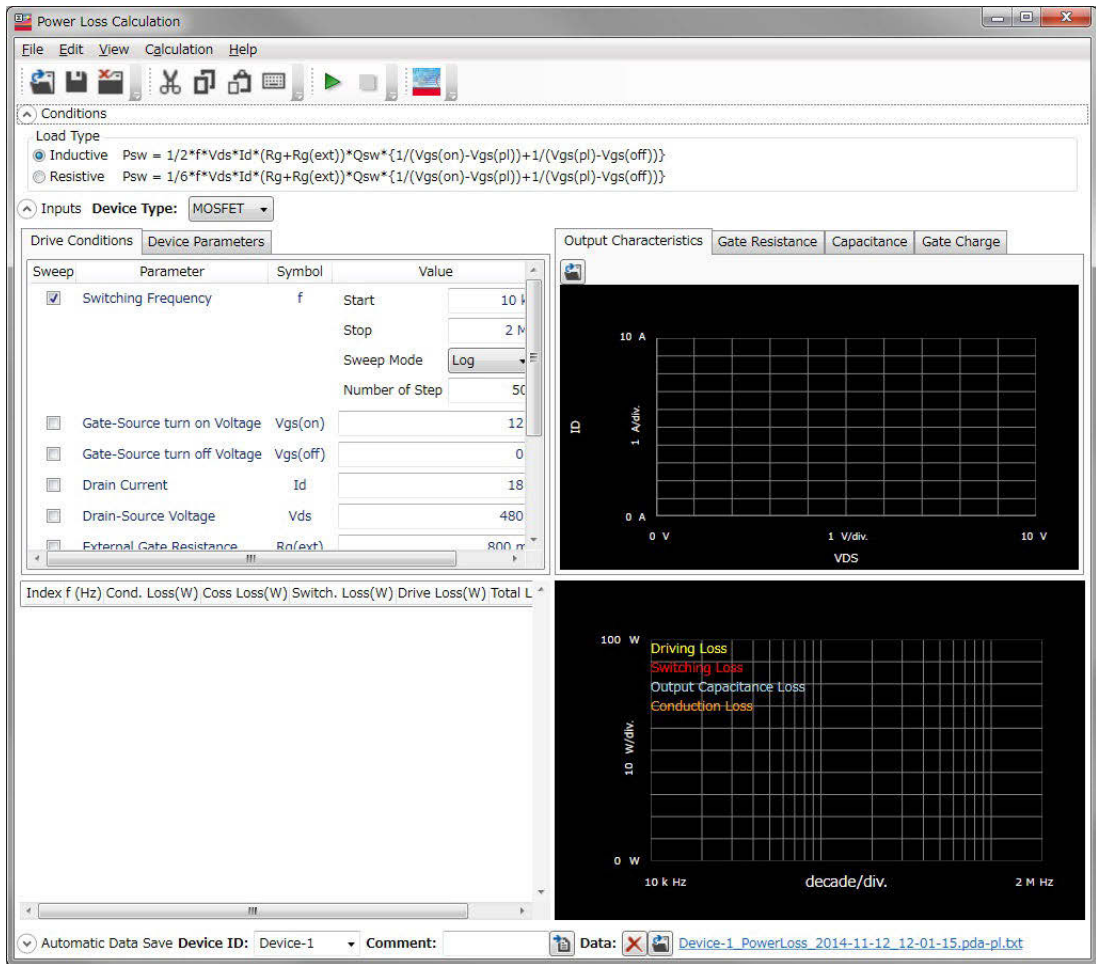

Calculating Power Loss

Step 1. Prepare the measurement data

The power loss calculation software uses the following measurement data files to calculate the power loss. So, measure the DUT at your desired drive conditions and save the measured data.

- Measurement data file of I/V measurement software

Prepare a measurement data file that measured either one of the following measurement item.

For MOSFET device type,

- ID-VDS
- RDS-ID
- VDS-VGS
- RDS-VGS

For IGBT device type,

- IC-VCE
- VCE(sat)
- VCE-VGE

- Measurement data file of capacitance measurement software

Prepare the measurement data files that measured the following measurement items.

For MOSFET device type,

- Rg
- Ciss, Coss, Crss (Coss or Crss)

For IGBT device type,

- Rg
- Cies, Coes, Cres (Coes or Cres)

- Measurement data file of gate charge measurement software

Prepare a measurement data file that measured any measurement item.

Step 2. On the software palette, click the Power Loss Calculation icon . The Power Loss Calculation software (Figure 3-5) opens.

Step 3. Select the assumed load type to calculate the power loss in the Conditions area on the work area.

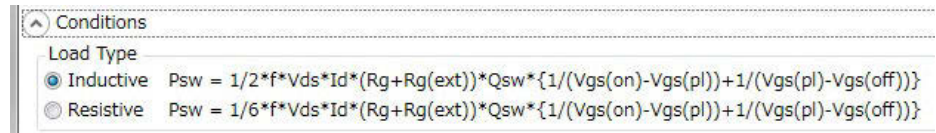

Inductive Inductive load

Resistive Resistive load

Step 4. At the Inputs area in work area, select a device type.

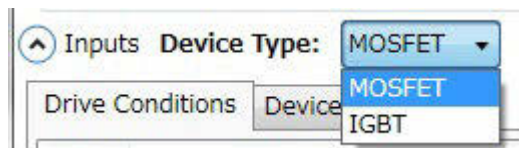

From the Device Type drop-down list, select a device type.

This example selects MOSFET.

Step 5. Specify the measurement data files to be used for power loss calculation and load them.

How To Perform Measurement
How To Calculate Power Loss



1. Specify the measurement data file of the I/V measurement software to load.
 - a. Click the Output Characteristics tab at the right of work area to display the Output Characteristics area.
 - b. Click the Load Measurement Data button  at the upper-left corner of the Output Characteristics area.

After the dialog box opens, specify the measurement data of I/V measurement software.

The characteristics graph of the loaded measurement item is displayed.

2. Specify the Rg measurement data file of the capacitance measurement software to load.
 - a. Click the Gate Resistance tab to display the Gate Resistance area.
 - b. Click the Load Measurement Data button  at the upper-left corner of the Gate Resistance area.

After the dialog box opens, specify the Rg measurement data of capacitance measurement software.

The loaded Rg characteristics graph is displayed.

3. Specify the “Ciss, Coss, Crss” measurement data file of the capacitance measurement software to load.

- a. Click the Capacitance tab to display the Capacitance area.
- b. Click the Load Measurement Data button  at the upper-left corner of the Capacitance area.

After the dialog box opens, specify the “Ciss, Coss, Crss” measurement data of capacitance measurement software.

The loaded “Ciss, Coss, Crss” characteristics graph is displayed.

4. Specify the measurement data file of the gate charge measurement software to load.
 - a. Click the Gate Charge tab to display the Gate Charge area.
 - b. Click the Load Measurement Data button  at the upper-left corner of the Gate Charge area.

After the dialog box opens, specify the measurement data of gate charge measurement software.

The gate charge characteristics graph of the loaded measurement item is displayed.

For the drive conditions and the device parameters for power loss calculation that extracted from the loaded measurement data, see “Extracted Parameters By Power Loss Calculation” on page 3-49”.

You can confirm or change the drive conditions for power loss calculation by clicking the Drive Conditions tab at the left of work area.
Also, you can confirm or change the device parameters for power loss calculation by clicking the Device Parameters tab.

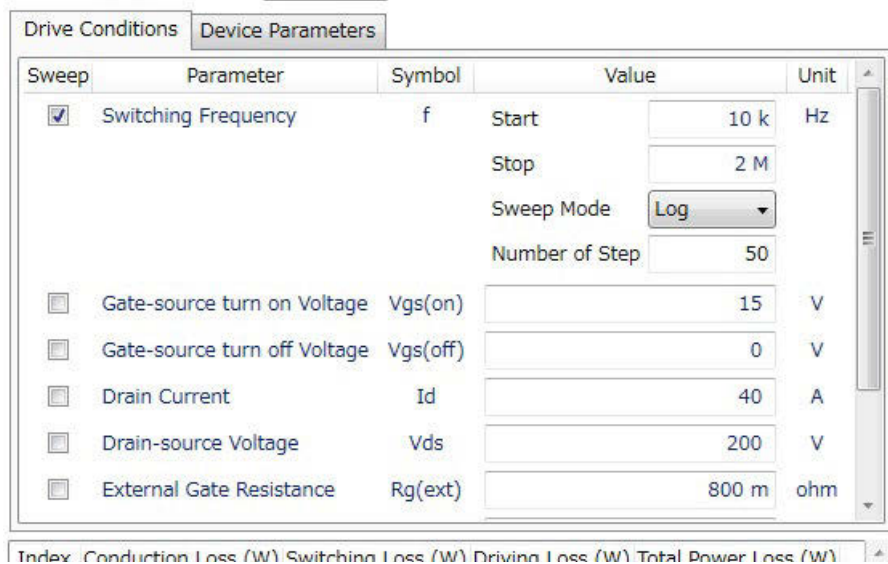

Step 6. Select a drive condition or device parameter to be swept and specify the sweep condition.

If you select a drive condition parameter to be swept, click the Drive Condition tab and mark the check box of the desired drive parameter.

If you select a device parameter to be swept, click the Device Parameters tab and mark the check box of the desired device parameter.

This example select a switching frequency to be swept.

1. Click the Drive Conditions tab and mark the check box of the Switching Frequency parameter to select.
2. Specify the sweep condition in the Value column.

Start Sweep start value

Stop Sweep stop value

Sweep Mode Sweep mode
Log (logarithmic sweep) or Linear (linear sweep)

Number of Step

Number of sweep steps

Step 7. Specify the drive conditions that are not extracted from the loaded measurement data.

1. Click the Drive Conditions tab at the left of work area to display the Drive Conditions area.
2. Specify the following drive conditions that are not extracted from the measurement data.

Switching Frequency

Switching frequency

In this example, this parameter already specified by Step.4.

Rg(ext)

Gate input resistance in the external drive circuit

Irms, D

Irms: Effective drain current (the root mean square of the load current)
D: Duty cycle.

Specify Irms or D.

The relation between Irms and D is $I_{rms} = I_d \times D^{1/2}$.

Step 8. Click the Start button  of toolbar to start the power loss calculation.

Step 9. After the calculation is completed, the list of calculated values and the trend chart are displayed as shown below.

Index	f (Hz)	Cond. Loss(W)	Coss Loss(W)	Switch. Loss(W)	Drive Loss(W)	Total Loss(W)
0	10000.000000	22.221208	0.047417	2.060067	0.111158	24.439851
1	11141.913842	22.221208	0.052832	2.295309	0.123851	24.693201
2	12414.224406	22.221208	0.058865	2.557414	0.137994	24.975481
3	13831.821875	22.221208	0.065587	2.849449	0.153752	25.289995
4	15411.296761	22.221208	0.073076	3.174831	0.171309	25.640424
5	17171.134070	22.221208	0.081421	3.537369	0.190871	26.030869
6	19131.929638	22.221208	0.090718	3.941306	0.212667	26.465900
7	21316.631165	22.221208	0.101078	4.391370	0.236952	26.950607
8	23750.806785	22.221208	0.112620	4.892826	0.264010	27.490664
9	26462.944287	22.221208	0.125480	5.451545	0.294157	28.092390
10	29484.784525	22.221208	0.139809	6.074064	0.327747	28.762829
11	32851.692883	22.221208	0.155774	6.767670	0.365173	29.509825
12	36603.073166	22.221208	0.173562	7.540480	0.406873	30.342122
13	40782.828757	22.221208	0.193381	8.401538	0.453334	31.269461
14	45439.876424	22.221208	0.215463	9.360921	0.505101	32.302693

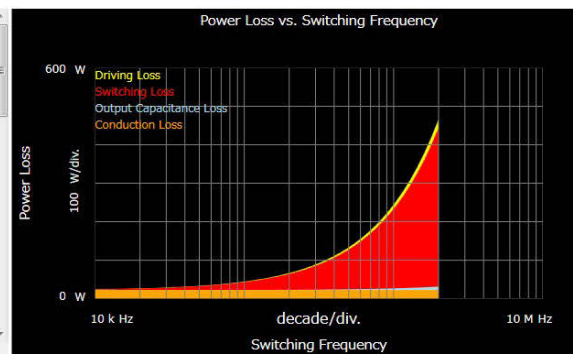

- List of Calculated Results

The following calculated data are displayed in list format.

Index	Index number of sweep step.
Sweep Parameter	Sweep parameter and its step values. In this example, F values are listed as the sweep parameter.
Conduction Loss	Calculated conduction loss
Coss (or Coes) Loss	Calculated output capacitance loss
Switching Loss	Calculated switching loss
Driving Loss	Calculated driving loss
Total Power Loss	Sum total of the conduction loss, switching loss, and driving loss.

For the calculation formula for each power loss, see “Results” on page 4-152.

- Trend Chart

The sweep parameter is assigned to X-axis, and the conduction loss, output capacitance loss, switching loss, and driving loss are assigned to Y-axis and accumulated in this order.

You can change the minimum and maximum values on the X and Y-axes by clicking the value.

Extracted Parameters By Power Loss Calculation

Table 3-3

Measurement Data and Extracted Drive Conditions and Device Parameters for Power Loss Calculation (MOSFET)

Measurement Data		Extracted Drive Conditions	Extracted Device Parameters
Measurement Software	Measurement Item		
I/V Measurement	ID-VDS, RDS-ID, RDS-VGS, or VDS-VGS		Rds(on) ^a
Capacitance Measurement	Rg		Rg ^b
	Crss		Qsw ^c
Gate Charge Measurement	Any measurement items	Vgs(on), Vgs(off), Id, Vds	Qg(on), Qg(off), Qsw, Vgs(pl)

- a. Extracted from Vgs(on)
- b. Extracted from Vgs(off)
- c. Extracted from Vgs(off) and Vds(off)

Table 3-4 Measurement Data and Extracted Drive Conditions and Device Parameters for Power Loss Calculation (IGBT)

Measurement Data		Extracted Drive Conditions	Extracted Device Parameters
Measurement Software	Measurement Item		
I/V Measurement	IC-VCE, VCE(sat), or VCE-VGE		Vce(sat) ^a
Capacitance Measurement	Rg		Rg ^b
	Cres		Qsw ^c
Gate Charge Measurement	Any measurement items	Vge(on), Vge(off), Ic, Vce	Qg(on), Qg(off), Qsw, Vgs(pl)

- a. Extracted from Vge(on)
- b. Extracted from Vge(off)
- c. Extracted from Vge(off) and Vce(off)

How To Monitor/Control Temperature Under Measurement

The thermal monitor/control software provides the following functions:

- Thermal monitor using the thermocouple
- Thermal control using the thermostream
- Synchronized measurement execution with the thermal conditions

These functions enable the automated measurement execution under the multiple temperature conditions.

This section describes how to monitor the temperature and execute the measurement synchronized with the specified thermal conditions using the thermal monitor/control software and consists of the following sub-sections:

- Preparing the Measurement
- Thermal Monitor/Control During Measurement

NOTE

This section uses the example that monitors the temperature of DUT controlled by thermostream and executes the measurement synchronized with the thermal conditions.

Preparing the Measurement

Step 1. Before starting the procedure, prepare an accessory used for connecting your device under test (DUT). See the following section depending on the accessory. Also prepare the thermocouple and the thermostream.

- “3-pin Inline Package Socket Module” on page 2-20
- “Curve Tracer Test Adapter Socket Module” on page 2-21
- “Universal Socket Module Kit” on page 2-22
- “Accessories for Connecting a DUT” on page 2-29
- “Thermocouple” on page 2-33
- “Thermostream” on page 2-34

- Step 2.** Turn the instrument on. After that, connect your DUT to the test fixture by using the accessory.

Figure 3-6 Thermal Monitor/Control Software

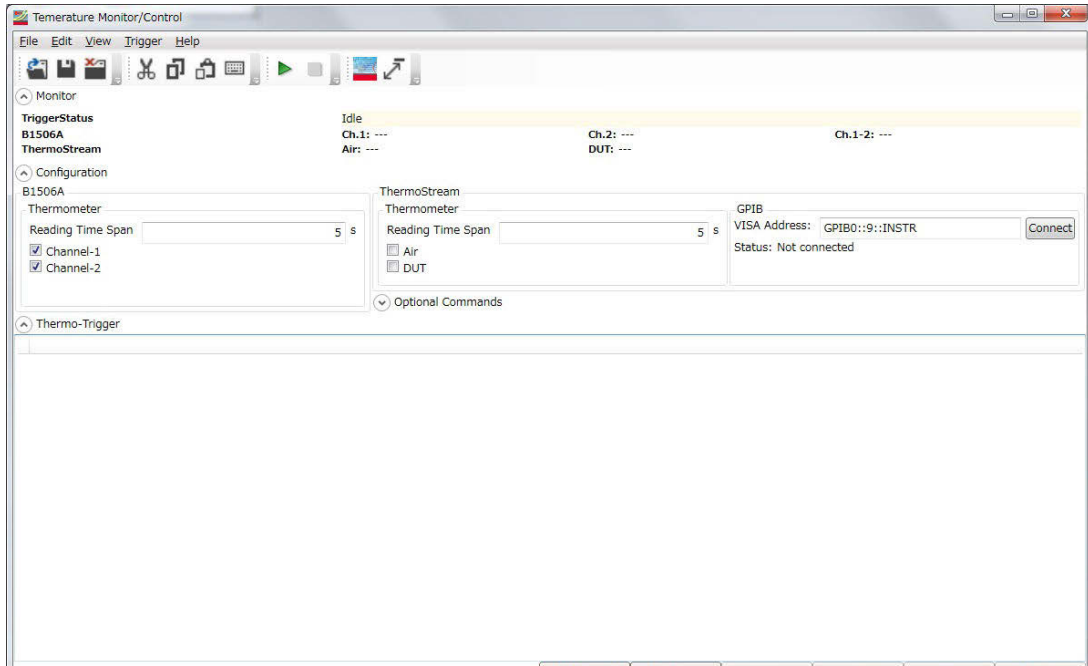

Thermal Monitor/Control During Measurement

- Step 1.** On the software palette, click the Thermal Monitor/Control icon . The Thermal Monitor/Control software (Figure 3-6) opens.
- Step 2.** Specify the conditions of thermal monitor at the Thermometer of Configuration area in the work area.

This example uses the thermocouple connected to the B1506A to monitor the temperature, so specify at the Thermometer of B1506A.

Reading Time Span Thermal reading interval

Channel 1 Mark the check box if you would like to enable the thermal monitor for the thermocouple connected to the channel 1 of K Thermocouple terminal on the test fixture.

Channel 2 Mark the check box if you would like to enable the thermal monitor for the thermocouple connected to the channel 2 of K Thermocouple terminal on the test fixture is enabled.

Step 3. Specify the conditions of thermo-trigger function

The thermo-trigger function executes the thermo-trigger list, which consists of the steps for watching on establishment of thermal condition and the steps for thermal control, sequentially.

If the thermo-trigger function is under execution, the measurement application waits the establishment of thermal condition and then executes the measurement.

This example set the following thermo-trigger steps:

- a. Wait until the temperature of the B1506A thermometer channel 1 is $25\text{ }^{\circ}\text{C} \pm 1\text{ }^{\circ}\text{C}$.

If the thermal condition is established, wait for 5 seconds and then output the measurement trigger to the measurement software.

Wait for the measurement completion by the measurement software.

If the measurement is completed, proceed to the next thermo-trigger step.

- b. Wait until the temperature of the B1506A thermometer channel 1 is $30\text{ }^{\circ}\text{C} \pm 1\text{ }^{\circ}\text{C}$.

If the thermal condition is established, wait for 5 seconds and then output the measurement trigger to the measurement software.

Wait for the measurement completion by the measurement software.

If the measurement is completed, proceed to the next thermo-trigger step.

- c. End of the thermo-trigger step.

Example of Thermo-trigger Steps



- 1. Click the Insert Control button at the bottom of the window.

2. The line for a thermo-trigger step is inserted in the Thermo-Trigger. Specify the condition.



- a. Select the target temperature by the drop-down list of second column.

This example selects the Channel1.

You can select the followings by this drop-down list:

Channel1	The temperature monitored by B1506A thermometer channel 1
Channel2	The temperature monitored by B1506A thermometer channel 2
Channel1_2	Differences between the temperature monitored by B1506A thermometer channel 1 and channel 2 (Channel 1 - Channel 2)
ThermoStream Air	The temperature of air blowing from the thermostream (when using the thermostream)
ThermoStream DUT	The temperature monitored by the DUT thermometer of thermostream (when using the thermostream)

- b. Specify the thermal condition.

Center	Center value of thermal condition. This example specified as 25.
Radius	Allowable range from the center value for the thermal condition. This example specifies as 1.
Delay	Delay time after establishment of thermal condition to execute the specified action. This example specifies as 5 (s).

- c. Selects the action after establishment of thermal condition from the Action drop-down list.

This example selects the TRIGGER, which outputs the measurement trigger.

You can select the following actions by this drop-down list:

TRIGGER	Outputs the measurement trigger.
NOP	Does nothing and proceed to the next step.
END	Terminates the thermo-trigger list execution.

3. Click the Duplicate button at the bottom of the window to copy the line of thermo-trigger step and add the copied line to the Thermo-Trigger.
4. Specify the thermal condition of the copied thermo-trigger line.
This example changes the condition of Center to 30 °C.

- Step 4.** Opens the measurement software that will synchronized with the thermo-trigger function and setup the measurement condition on it.

After the measurement setup is completed, leave the software to be opened.

- Step 5.** Click the Start button  of the menu bar on the thermal monitor/control software to start the thermo-trigger function.

The thermal monitor/control software executes the first thermo-trigger step and waits for the establishment of thermal condition.

- Step 6.** Click the Start button  of the menu bar on the measurement software to start the measurement.

The measurement software waits for the measurement trigger from the thermal monitor/control software.

- Step 7.** Control the thermostream so that the temperature is $25\text{ }^{\circ}\text{C} \pm 1\text{ }^{\circ}\text{C}$, which is the first thermal condition.

If the thermal condition is established, the thermal monitor/control software outputs the measurement trigger to the measurement software.

After receiving the measurement trigger, the measurement software starts the measurement.

- Step 8.** When the measurement is completed, the measurement software outputs the signal of the measurement completion to the thermal monitor/control software.
And then, the measurement software waits for the next measurement trigger from the thermal monitor/control software.

When the thermal monitor/control software receives the signals of measurement completion, the thermal monitor/control software executes the next thermo-trigger step and waits for the establishment of thermal condition.

- Step 9.** Control the thermostream so that the temperature is $30\text{ }^{\circ}\text{C} \pm 1\text{ }^{\circ}\text{C}$, which is the next thermal condition.

If the thermal condition is established, the thermal monitor/control software outputs the measurement trigger to the measurement software.

After receiving the measurement trigger, the measurement software starts the measurement under the different thermal condition.

Displaying and Operating Graph

This section describes the common graph operation within the measurement softwares and consists of the followings:

- How To Select and Display Characteristics Curve
- How To Use the Marker

How To Select and Display Characteristics Curve

Step 1. Select the characteristics curves to display.

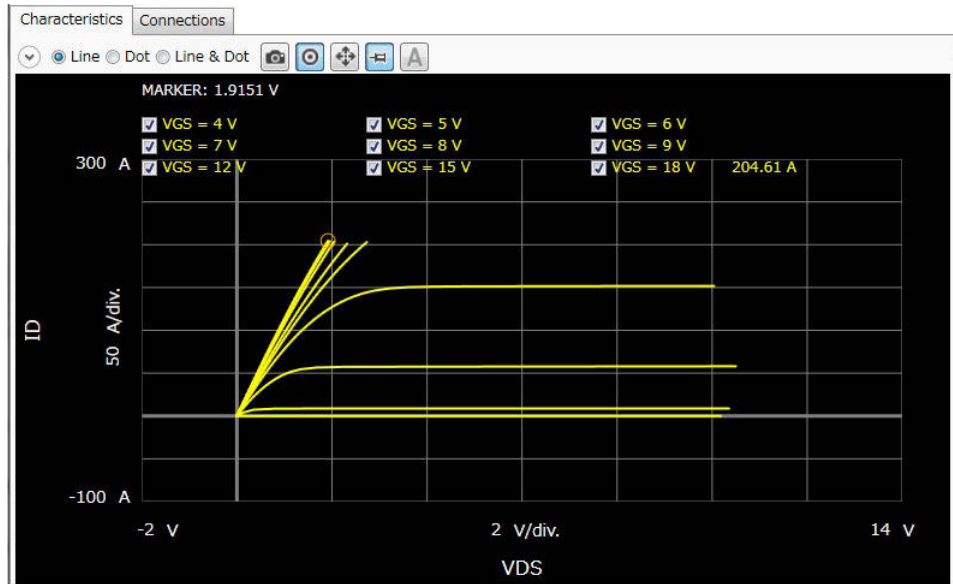

The check boxes for the available characteristics are displayed at the upper left on the graph area.

Mark the check boxes for the desired characteristics to display.

You can select the multiple characteristics to display.

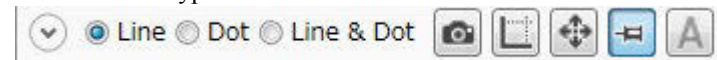

Step 2. Select the line type of curve.



By the radio buttons at the top of graph area, you can select the line type of curve from the Line, Dot, or Line&Dot.

Step 3. Change the minimum and maximum values of X and Y-axes

If the auto scale mode button  is selected, the X and Y-axes of the graph are automatically changing to fit the measured data during measurement execution.

If the fixed scale mode button  is selected and the auto-scale button  is clicked, the X and Y-axes of the graph are changed to fit the measured data.

Or, you can change the minimum and maximum values of X and Y-axes by clicking the value.



How To Use the Marker

You can use the domain marker and/or trace marker to read the value on the curve.

The following table shows the measurement softwares and their furnished marker function.

Marker	Description	Applied Software
Domain Marker	Vertical line marker. The marker moves in the direction of X and you can read the X-axis value of the marker and Y-axis values of the intersections of marker and characteristics curves.	I/V measurement, Capacitance measurement, Gate charge measurement
Trace Marker	Circle marker. The marker moves on a characteristics curve and you can read the X and Y-axis values of the marker.	I/V measurement, Capacitance measurement,

Using the domain marker

Step 1. If the trace marker is displayed, click the trace marker mode button  to change to the domain marker mode .

Step 2. Marker A (Vertical line) is displayed.

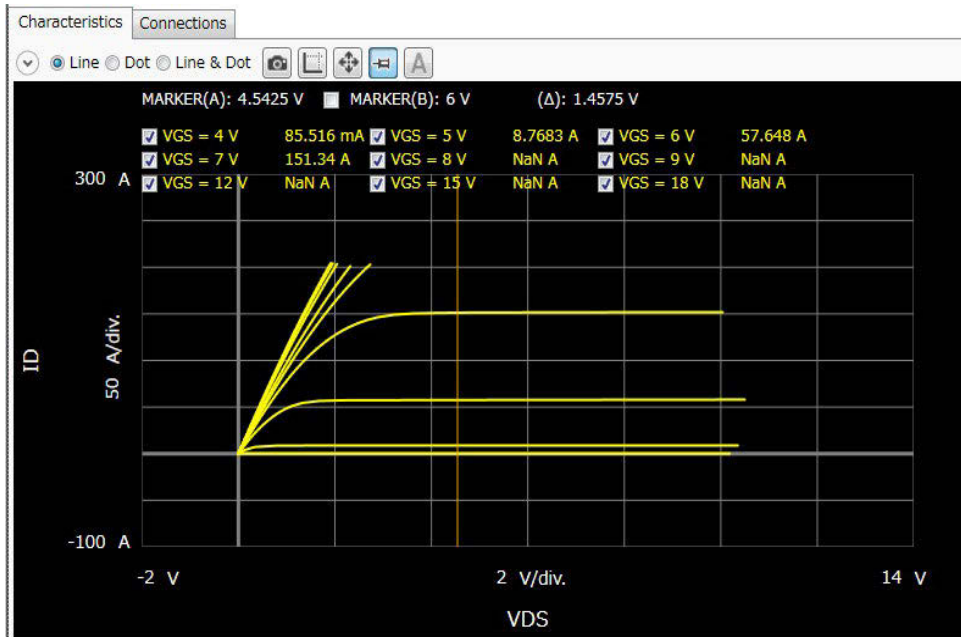

To move the marker, use the rotary nob or mouse.

The **MARKER(A)**: at the upper left of graph area shows the X-axis value of marker A and the Y-axis value of the intersection of the marker and each characteristics curve is displayed at the right of characteristics curve name.

Step 3. If the check box at the left of the **MARKER(B)**: is marked, the marker B (vertical dot line) is displayed.

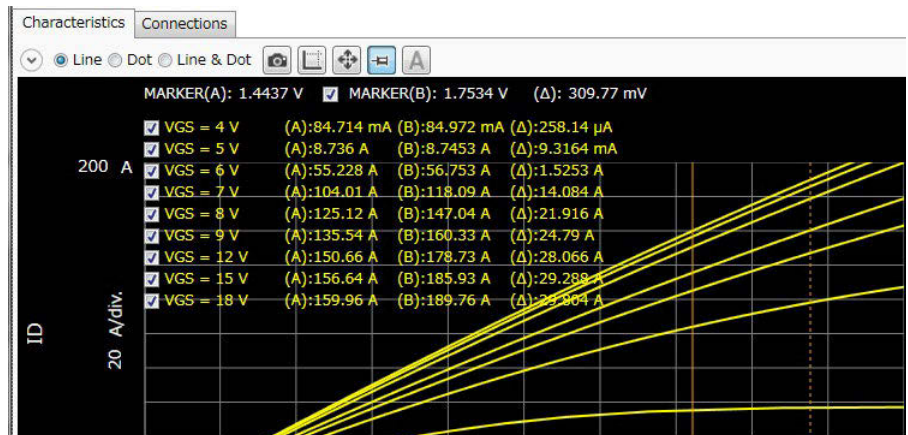



The following information is displayed at the top of graph area:

MARKER(B): X-axis value of marker B

(Δ) X-axis value of marker B - X-axis value of marker A

The Y-axis values of the intersection of the markers and each characteristics curve, and the differences of Y-axis values between the mark A interaction and the mark B interaction (B-A) are displayed at the right of characteristics curve name.

Using the trace marker

Step 1. If the domain marker is displayed, click the domain marker mode button  to change to the trace marker mode .

Step 2. The trace marker (circle) is displayed.

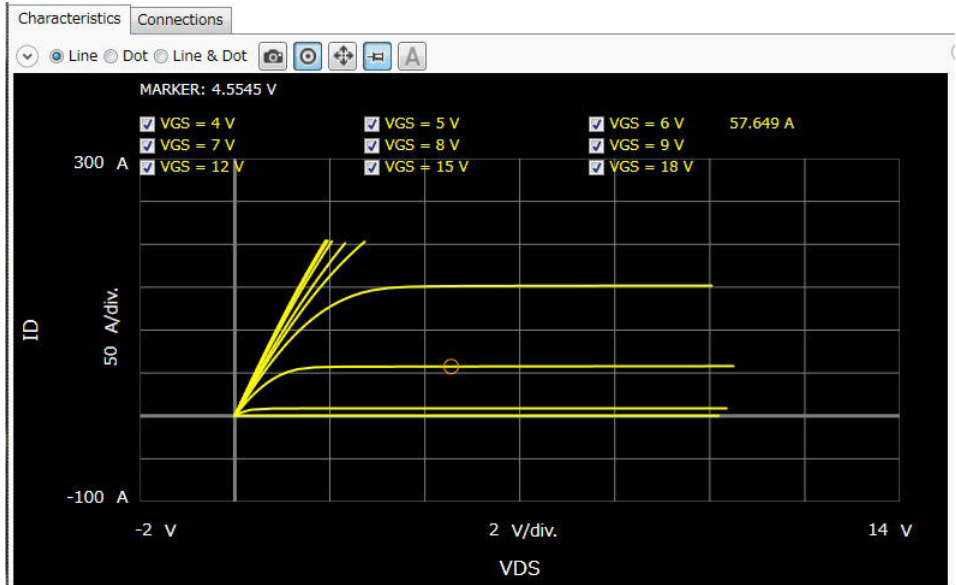

You can move the trace marker on the characteristics curve using the rotary knob or mouse.

The **MARKER**: at the upper left of graph shows the X-axis value of the marker and the Y-axis value is displayed at the right of the characteristics curve name.

4

GUI Reference

Keysight Easy Test Navigator software provides dedicated measurement software for power device characterization. It supports various types of measurement tasks with ease-of-use and simple operation.

This chapter describes reference information of the Keysight Easy Test Navigator software, and covers the following topics.

- “Software Palette”
- “Datasheet Characterization Software”
- “I/V Measurement Software”
- “Capacitance Measurement Software”¹
- “Gate Charge Measurement Software”¹
- “Power Loss Calculation Software”¹
- “Thermal Monitor/Control Software”

For how to perform the measurements, see Chapter 3, “How To Perform Measurement.”

NOTE

The actual screen image on the B1506A may be different from the image shown in this chapter.

1. Available for the B1506A-H21/H51/H71.

Software Palette

The software palette provides a complete list of the B1506A's measurement software and also allows this software to be launched. The software palette lists icons with the measurement software names. You can start a measurement software by clicking an icon or a software name, or by pressing a softkey corresponding to the software. Seven softkeys are available for this purpose at the right next to the LCD of this instrument.

The software palette is displayed in fullscreen mode after powering up the B1506A. The software palette can be minimized to access the Windows desktop.

The following shows the icons and texts displayed on the software palette, and actions by clicking them.



**Datasheet
Characterization**

Starts the datasheet characterization software. See “Datasheet Characterization Software” on page 4-5.



I/V Measurement

Starts the I/V measurement software. See “I/V Measurement Software” on page 4-56.



**Capacitance
Measurement**

Available for the B1506A-H21/H51/H71.
Starts the capacitance measurement software. See “Capacitance Measurement Software” on page 4-90.



**Gate Charge
Measurement**

Available for the B1506A-H21/H51/H71.
Starts the gate charge measurement Software. See “Gate Charge Measurement Software” on page 4-118.



**Power Loss
Calculation**

Available for the B1506A-H21/H51/H71.
Starts the power loss calculation software. See “Power Loss Calculation Software” on page 4-142.



**Thermal
Monitor/Control**

Starts the thermal monitor/control software. See “Thermal Monitor/Control Software” on page 4-163.



Minimize

Minimizes the software palette. This is useful when you access the Windows desktop. When you click the icon on the taskbar, the software palette appears again.



Exit

Exits the software palette and opened measurement software. This button is displayed if you move the mouse pointer over the upper right corner.

When you use the EasyEXPERT software or you update the Easy Test Navigator software, use this button to exit the Easy Test Navigator software in advance.

Datasheet Characterization Software

The datasheet characterization software measures various characteristics parameters and graphs of the I/V characteristics, capacitance characteristics, and gate charge characteristics described on a device datasheet. This software has the following features.

- A simple operating environment that can measure a range of device parameters and characteristics using a familiar datasheet-like format
 - To enter measurement conditions in a datasheet-like format
 - To set sweep output start/stop by using graph minimum/maximum
 - To display measured parameters and characteristics in a datasheet-like format
 - To automatically compare measurement results with expected values
- Minimal software learning curve for device characterization using the following templates installed with the software
 - MOSFET
 - IGBT
 - BJT
 - Diode
 - Component

A template is a setup and measurement data file only for this software. It is called as ETN DS file.

- To effectively get the data not covered by the manufacturer's datasheet

For details of the templates furnished with this software, see “Parameters Defined in Furnished Templates” on page 4-39. And, for how to create an ETN DS file to be fitted to real devices, see “Creating Custom File” on page 4-54.

NOTE

For using the B1506A-H20/H50/H70, ignore the description about the capacitance measurement, the gate charge measurement, and the power loss calculation.

GUI Overview

The GUI (Graphical User Interface) of the datasheet characterization software is comprised of the following areas.

Figure 4-1

Datasheet Characterization Software GUI

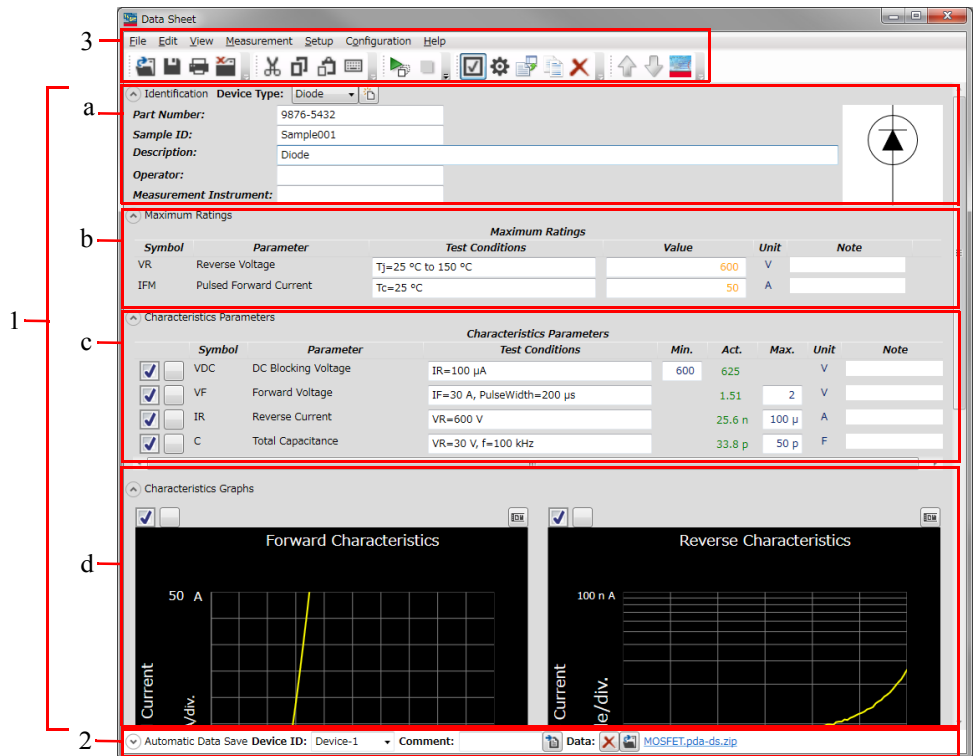

1. Work Area (See p. 4-7.)

This area provides the functions to set the measurement conditions and observe the measurement results. This is separated to the following areas.

- a. Identification (See p. 4-7.)
- b. Maximum Ratings (See p. 4-10.)
- c. Characteristics Parameters (See p. 4-11.)
- d. Characteristics Graphs (See p. 4-12.)

2. Automatic Data Save (See p. 4-16.)

This area provides the functions regarding the automatic saving of the ETN DS files. The ETN DS file can have the setup data and measurement data, and it is only for this software.

3. Operating Tools

- Toolbar (See p. 4-18.)

This provides the functions that are very frequently used in the button format.

- Main Menu (See p. 4-23.)

This provides the functions needed for various operations in the menu format.

For the dialog boxes displayed during this software operation, see “Dialog Boxes” on page 4-29.

For the files handled by this software, see “Summary of Files” on page 4-36.

Work Area

In this area, set the measurement conditions and observe the measurement results. This is separated to the following areas.

- Identification (See p. 4-7.)
- Maximum Ratings (See p. 4-10.)
- Characteristics Parameters (See p. 4-11.)
- Characteristics Graphs (See p. 4-12.)

Identification

This is an area to select the device type of the device under test (DUT) and enter the identification information for the DUT.

This area can be hidden or shown by clicking the line of  Identification.

Figure 4-2



a. Device Type

Lists the following device types. Select the device type of the DUT from them.

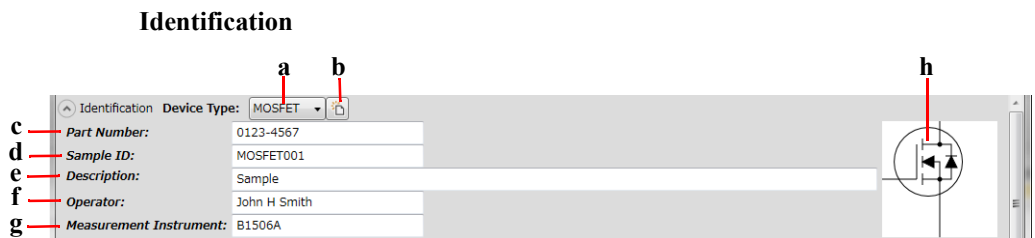
- MOSFET

MOSFET is selected. For details of the measurement items, see “MOSFET Template” on page 4-39.

- IGBT

IGBT is selected. For details of the measurement items, see “IGBT Template” on page 4-44.

- BJT

BJT is selected. For details of the measurement items, see “BJT Template” on page 4-49.

- Diode

Diode is selected. For details of the measurement items, see “Diode Template” on page 4-52.

- Component

Displays a pop-up menu for selecting a component type appears as shown below. Click this menu and select on from the displayed component types.

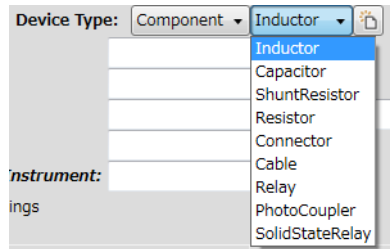

NOTE

To create an ETN DS file for a device type other than the above types, enter an arbitrary device type name into the Device Type field and save it as a new file.

b. New Datasheet button 

Creates a new ETN DS file using the selected template.

Reads a furnished template specified by the device type selection, opens new ETN DS file (measurement conditions and measurement data), and shows the measurement conditions and measurement data defined in the template in the in the Maximum Ratings, Characteristics Parameters, and Characteristics Graphs areas.

- c. Part Number
Enter a par number of your DUT. It is stored to the present ETN DS file.
- d. Sample ID
Enter a Device ID to identify your DUT. It is stored to the present ETN DS file.
- e. Description
Enter a device description and so on. It is stored to the present ETN DS file.
- f. Operator
Enter operator information. It is stored to the present ETN DS file.
- g. Measurement Instrument
Enter measurement instrument information. It is stored to the present ETN DS file.
- h. Device Circuit Symbol
Displays the device circuit symbol corresponding to the selected device type. If you click over this field, the following pop-up menu is displayed.

System Picture

Displays the default circuit symbol.

Import Picture

Opens the Open Picture dialog box used to display a specified image file.

Clear Picture

Clears the present picture.

Maximum Ratings

This is an area to set up the maximum ratings of your DUT. The entered maximum rating values are used as the limits for the measurement conditions of the characteristics measurement items.

You can change the column order in this table by dragging a column header.

This area can be hidden or shown by clicking the line of  Maximum Ratings.

Figure 4-3

Maximum Ratings

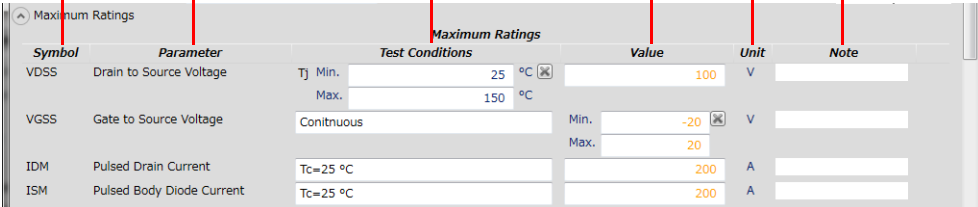

Symbol	Parameter	Test Conditions	Value	Unit	Note
VDS	Drain to Source Voltage	TJ Min. 25 °C [X] Max. 150 °C	100	V	
VGSS	Gate to Source Voltage	Conitnuous	Min. -20 [X] Max. 20	V	
IDM	Pulsed Drain Current	Tc=25 °C	200	A	
ISM	Pulsed Body Diode Current	Tc=25 °C	200	A	

a. Symbol

Symbol of a rating parameter. You can edit this by clicking on the text.

b. Parameter

Name of a rating parameter. You can edit this by clicking on the text.

c. Test Condition

Applicable condition for a rating parameter. You can edit this by clicking on the text. To close the expanded edition fields, click the Close button .

d. Value

Rating value. You can edit this by clicking on the text. To close the expanded edition fields, click the Close button .

e. Unit

Shows a unit for the rating value.

f. Note

Enter a remark for the rating value. It is stored to the present ETN DS file.

Characteristics Parameters

This is an area to set up the characteristics parameter measurements. A line has the measurement conditions for a characteristics parameter.

To select a characteristics parameter, click on the blank space (excepting edition fields) of its row. The selected row is highlighted.

You can change the column order in this table by dragging a column header.

This area can be hidden or shown by clicking the line of  Characteristics Parameters.

Figure 4-4

Characteristics Parameters



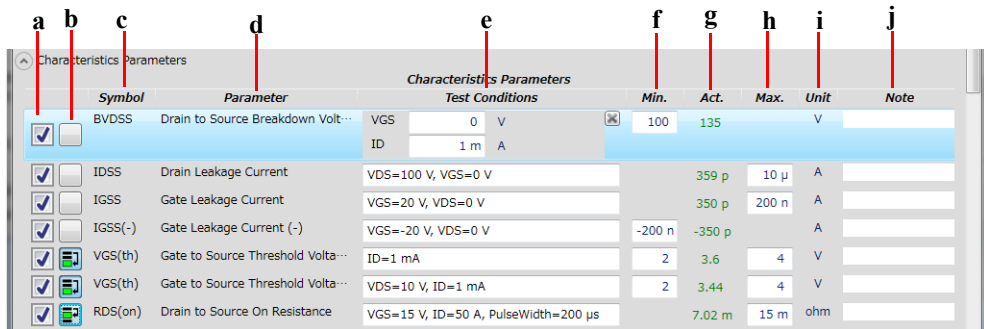

Symbol	Parameter	Test Conditions	Min.	Act.	Max.	Unit	Note
<input checked="" type="checkbox"/>	BVDSS	Drain to Source Breakdown Volt...	VGS=0 V	100	135	V	
<input checked="" type="checkbox"/>	IDSS	Drain Leakage Current	VDS=100 V, VGS=0 V	359 p	10 μ	A	
<input checked="" type="checkbox"/>	IGSS	Gate Leakage Current	VGS=20 V, VDS=0 V	350 p	200 n	A	
<input checked="" type="checkbox"/>	IGSS(-)	Gate Leakage Current (-)	VGS=-20 V, VDS=0 V	-200 n	-350 p	A	
<input checked="" type="checkbox"/>	VGS(th)	Gate to Source Threshold Volta...	ID=1 mA	2	3.6	4	V
<input checked="" type="checkbox"/>	VGS(th)	Gate to Source Threshold Volta...	VDS=10 V, ID=1 mA	2	3.44	4	V
<input checked="" type="checkbox"/>	RDS(on)	Drain to Source On Resistance	VGS=15 V, ID=50 A, PulseWidth=200 μs	7.02 m	15 m	ohm	

a. Check box

Mark this for a characteristics parameter to be measured.

b. Measurement Priority

You can set the priority of the measurement execution for each measurement item. As default, all items are set to 1st priority. Click the button on the right-hand side of the check box to select the priority level.

- : 1st priority
- : 2nd priority
- : 3rd priority

For the execution order of the measurement items, see “Execution Order of Measurement Items” on page 4-15.

c. Symbol

Symbol of a characteristics parameter. You can edit this by clicking on the text.

d. Parameter

Name of a characteristics parameter. You can edit this by clicking on the text.

e. Test Conditions

Measurement condition values to measure a characteristics parameter. You can edit this by clicking on the text. To close the expanded edition fields, click the Close button .

f. Min.

Lower limit value of the expected range for the measured characteristics parameter value. Leave a blank if there is no lower limit.

g. Act.

Shows an actual measured value of a characteristics parameter.

The measured value is displayed in red italic type if it is out of the expected range from “Min.” to “Max.”.

h. Max.

Upper limit value of the expected range for the measured characteristics parameter value. Leave a blank if there is no upper limit.

i. Unit

Unit for a characteristics parameter.

j. Note

Enter a remark for the characteristics parameter value. It is stored to the present ETN DS file.

Characteristics Graphs

This is an area to set up the measurements for obtaining the characteristics graphs. Set the measurement conditions on each graph.

To select a characteristics graph, click on the graph. The outer frame of the selected graph is highlighted.

This area can be hidden or shown by clicking the line of  Characteristics Graphs.

Figure 4-5 Characteristics Graphs



- a. Check box

Mark this for a characteristics graph to be measured.

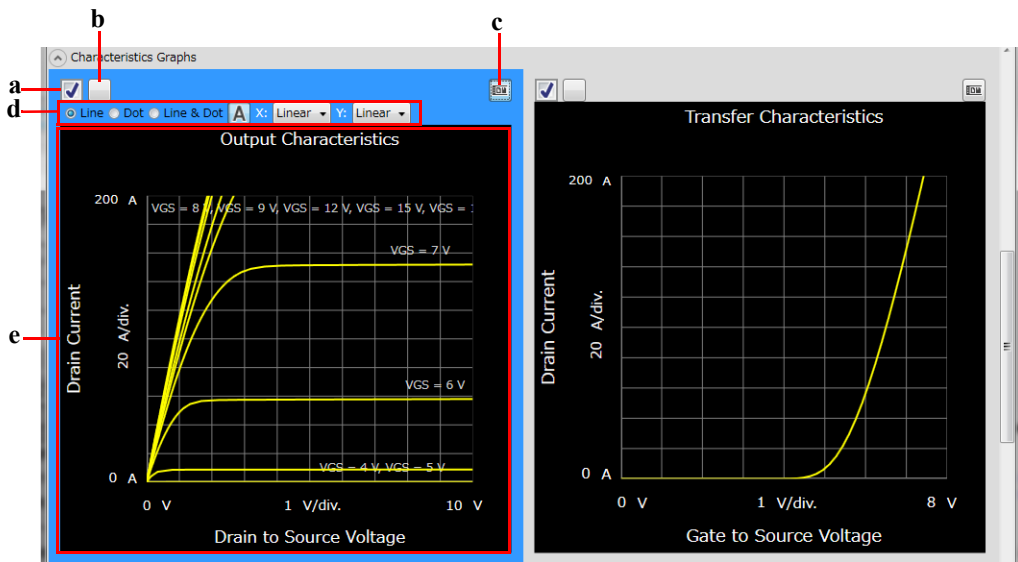
- b. Measurement Priority

You can set the priority of the measurement execution for each measurement item. As default, all items are set to 1st priority. Click the button on the right-hand side of the check box to select the priority level.

- : 1st priority
- : 2nd priority
- : 3rd priority

For the execution order of the measurement items, see “Execution Order of Measurement Items” on page 4-15.

- c. Graph tool button

Shows or hides the graph tools at the top of the graph.

- d. Graph tools

You can do below using the graph tools.

- Trace Representation

You can select one from the following trace representations.

The curves can be represented as Line, Dot, or combination (Line & Dot). Select any trace representation using the radio buttons shown in the bottom part of the graph.

- Line
Plots a line between two measurement points.
- Dot
Represents the measurement points by dots.
- Line & Dot
Represents the measurement points by dots and plots a line between two measurement points.

- Trace label button 

Shows or hides labels to distinguish multiple traces on the graph.

- X/Y-axes scales

You can select scales for the X and Y-axes from the following.

- Linear
Linear scale
- PositiveLog
Logarithm scale for positive data
- NegativeLog
Logarithm scale for negative data

e. Graph

Shows the measured characteristics graph.

You can change the minimum and maximum values on the X and Y-axes by clicking on the values.

For X and Y-axes of the voltage or current output values, enter the minimum and maximum values on X and Y-axes to specify the measurement range.

Execution Order of Measurement Items

After starting the measurement, the marked measurement items are executed in the following order, depending on the measurement priority setting, the kind of measurement, the location of the measurement item, and need of the adapter changing.

1. Measurement Items related to I/V or Capacitance Measurement
 - a. 1st Priority Measurement items
 1. Measurement Items in the Characteristics Parameters area are executed in the order from top to bottom.
 2. Measurement items in the Characteristics Graphs area are executed in the order of top left, top right, left on second row, right on second row, ..., bottom left, and bottom right.
 - b. 2nd Priority Measurement Items
 1. Measurement Items in the Characteristics Parameters area are executed in the order from top to bottom.
 2. Measurement items in the Characteristics Graphs area are executed in the order of top left, top right, left on second row, right on second row, ..., bottom left, and bottom right.
 - c. 3rd Priority Measurement Items
 1. Measurement Items in the Characteristics Parameters area are executed in the order from top to bottom.
 2. Measurement items in the Characteristics Graphs area are executed in the order of top left, top right, left on second row, right on second row, ..., bottom left, and bottom right.
2. (Changing operation of the adapter)
3. Measurement Items related to Gate Charge Measurement
 - a. 1st Priority Measurement items
 1. Measurement Items in the Characteristics Parameters area are executed in the order from top to bottom.
 2. Measurement items in the Characteristics Graphs area are executed in the order of top left, top right, left on second row, right on second row, ..., bottom left, and bottom right.

- b. 2nd Priority Measurement Items
 1. Measurement Items in the Characteristics Parameters area are executed in the order from top to bottom.
 2. Measurement items in the Characteristics Graphs area are executed in the order of top left, top right, left on second row, right on second row, ..., bottom left, and bottom right.
- c. 3rd Priority Measurement Items
 1. Measurement Items in the Characteristics Parameters area are executed in the order from top to bottom.
 2. Measurement items in the Characteristics Graphs area are executed in the order of top left, top right, left on second row, right on second row, ..., bottom left, and bottom right.

Automatic Data Save

This area sets the automatic saving for all setup data including the measurement conditions and all measurement data. These data are automatically saved to a new ETN DS file in the specified folder at the end of the measurement.

The Data folder and Recent data fields can be shown or hidden by clicking the line of  Automatic Data Save.

Figure 4-6

Automatic Data Save

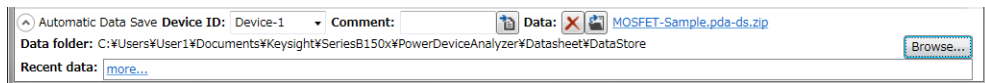

Device ID Enter device ID string to the Device ID field. The maximum 10 recently-entered device IDs can be kept as history, and you can also select one from the history list.

The entered device ID is automatically saved to the ETN DS file at the end of the measurement.

You can also change the device ID in the latest ETN DS file after the measurement here. To change it, change the device ID in the Device ID field, and then click the Apply button .



Comment Enter a comment string to the Comment field.

The entered comment is automatically saved to the ETN DS file at the end of the measurement.

You can also change the comment in the latest ETN DS file after the measurement here. To change it, change the comment in the Comment field, and then click the Apply button .

Data

The Data field shows the latest auto-saved or last-opened ETN DS file name. You can do the following operations.

- Open the ETN DS file by clicking the Open button .
- Rename the ETN DS file by clicking the ETN DS file name.
- Delete the ETN DS file by clicking the Delete button .

Data folder

Shows the absolute path of the auto-saved ETN DS file To change this, click the Browse button to open the folder selection dialog box. Select your desired folder in the dialog box.

For the initial setting of the data folder, see “Summary of Files” on page 4-88.

Recent data

Shows up to 10 auto-saved ETN DS files that were automatically saved recently, in the hyper-link format. Clicking the hyper-link opens the selected ETN DS file This destroys the presently-editing data.

If the number of the auto-saved ETN DS files is over ten, this field shows “more...”. Clicking this opens the file selection dialog box. Select a ETN DS file to open.





Toolbar

Figure 4-7







The toolbar has five tool button groups. The following shows the tool buttons in the tool button groups.

File tool button group

- | | | |
|---|--------------|--|
|  | Open | Opens the Open File dialog box used to open a specified ETN DS file. All present setup data and measurement data are cleared by opening the file. |
|  | Save | Saves the present setup data and measurement data as the same file name. |
|  | Print | Prints the present setup data and measurement data to the specified printer in the datasheet format, or to a document file in the XPS or PDF format. |
|  | Exit | Exits the datasheet characterization software. Unsaved data is destroyed. |

Edit tool button group

- | | | |
|---|---------------------------|--|
|  | Cut | Moves the selected text to the clipboard. |
|  | Copy | Copies the selected text to the clipboard. |
|  | Paste | Pastes the text from the clipboard to the insertion point. |
|  | On-screen keyboard | Displays the on-screen keyboard. |

Measurement tool button group



Start without data cleared

Starts to measure the marked measurement items in sequence. At the starting point, the existing measurement data for the all measurement items is cleared. During the measurement, the measurement status indicator on the front panel lights up.



Start with data cleared

Starts to measure the marked measurement items in sequence. At the starting point, the existing measurement data for the marked measurement items is cleared, but the measurement data for the unmarked items is retained. If the measurement is aborted, the measurement data acquired before aborting is retained. During the measurement, the measurement status indicator on the front panel lights up.

NOTE

The above two Start buttons are switched depending on the setting of the Start Options described below.



Stop Measurement

Stops the measurement.

You can also use the Measurement > Stop menu or the Stop key on the front panel to stop the measurement.



Start Options

Displays the following menu items to set the option for the Start tool button.

- Without data cleared
- With data cleared

Setup tool button group



All Check/ Uncheck

This button indicates three statuses whether all of the measurement items (characteristics parameters and graphs) are objects to be measured.

This status shows that all measurement items are not objects to be measured. If clicking this button under this status, the check boxes of all measurement items are marked to set to objects to be measured.



This status shows that some measurement items are objects to be measured. If clicking this button under this status, the check boxes of all measurement items are marked to set to objects to be measured.

-  This status shows that all measurement items are objects to be measured. If clicking this button under this status, the check boxes of all measurement items are unmarked to set to no objects to be measured.



Setup

Launches one of the following software corresponding to the highlighted (selected) measurement item of Characteristics Parameters or Characteristics Graphs and displays its setup and measurement data.

- “I/V Measurement Software”
- “Capacitance Measurement Software”
- “Gate Charge Measurement Software”

On this software, you can change typical measurement conditions and perform measurement for this item.

Saving data on this software will send the data to the datasheet characterization software GUI, too. It does not save the ETN DS file.



Add Maximum Rating

Opens the Maximum Rating Properties dialog box (page 4-30). Setting up the new item’s properties adds it to the Maximum Ratings.



Add Characteristics Parameter

Opens the Open Data dialog box. And selecting the original data file for the new item opens the Characteristics Parameter Properties dialog box (page 4-30). Setting up the new item’s properties adds it to the Characteristics Parameters.



Add Characteristics Graph

Opens the Open Data dialog box. And selecting the original data file for the new item opens the Characteristics Graph Properties dialog box (page 4-33). Setting up the new item’s properties adds it to the Characteristics Graphs.



Import

Imports data in a measurement data file created by other measurement software to the setup and measurement data of the measurement item highlighted (selected) in the Characteristics Parameter area or Characteristic Graphs area.

It is useful when you need to import the existing data to a new additional measurement item or replace the setup and measurement data with the existing data.



Duplicate

Makes a duplicate of the measurement item highlighted (selected) in the Characteristics Parameters area or Characteristics Graphs area.

The duplicated item is placed after the highlighted item.

It is useful when you need to measure the same characteristics parameter with multiple conditions.



Move Up

Moves the highlighted (selected) item upward.



Move Down

Moves the highlighted (selected) item downward.



Properties

If an item of the Maximum Ratings is highlighted (selected), opens the Maximum Rating Properties dialog box (page 4-30) with its properties.

If an item of the Characteristics Parameters is highlighted (selected), opens the Characteristics Parameter Properties dialog box (page 4-30) with its properties.

If an item of the Characteristics Graphs is highlighted (selected), opens the Characteristics Graph Properties dialog box (page 4-33) with its properties.



Edit Setup

Launches one of the following software corresponding to the highlighted (selected) measurement item of Characteristics Parameters or Characteristics Graphs and displays its setup and measurement data.

- “I/V Measurement Software”
- “Capacitance Measurement Software”
- “Gate Charge Measurement Software”

On this software, you can change all measurement conditions and perform measurement for this item.

Saving data on this software will send the data to the datasheet characterization software GUI, too. It does not save the ETN DS file.



Recycle

Restores the deleted item from the recycle bin.



Delete

Deletes the measurement item highlighted (selected) in the Characteristics Parameters area or Characteristics Graphs area.

View tool button group



Page Up

Scrolls up.



Page Down

Scrolls down.



Go to Palette

Displays the software palette in fullscreen mode.

Main Menu

Figure 4-8

Main Menu

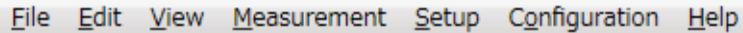

The image shows a horizontal menu bar with the following items: File, Edit, View, Measurement, Setup, Configuration, and Help. Each item is underlined and the entire bar has a light gray background.

The following describes the functions of the main menu.

File Menu

Displays the following menu items to operate the ETN DS file. For the file types and extensions, see “Summary of Files” on page 4-36.

New	Clears all present setup data and measurement data to start from initial setting.
Open...	Opens the Open File dialog box used to open a specified ETN DS file. All present setup data and measurement data are cleared by opening the file.
Save	Saves the present setup data and measurement data as the same file name.
Save As...	Opens the Save Data File dialog box used to save the present setup data and measurement data as the specified file. You can also save the data in a XPS (XML Paper Specification) format (.xps file) or a tab-separated values format (.txt file).
Print...	Prints the present setup data and measurement data to the specified printer in the datasheet format, or to a document file in the XPS format. To print to an XPS file, select the Microsoft XPS Document Writer as a printer in the Print dialog box. If the PDF Writer/Printer is available, you can also print the present setup data and measurement data to a document file in the PDF format.
Change Device ID...	Changes the device ID recorded in the ETN DS file This opens the Change Device ID dialog box, and changes the device ID recorded in the selected ETN DS file(s). See “Change Device ID dialog box” on page 4-29.
Report...	Opens the Datasheet Reporter (page 4-35).

Collects the measurement data for all of the Characteristics Parameters measurement items included in one or more ETN DS files and saves it in a tab-separated values format (.txt file).

Data of one ETN DS file is arranged in a row. Each row contains the Device ID, the ETN DS file name, and the measurement data for all of the Characteristics Parameters measurement items included in the file.

Recent Setup Files

Lists a maximum of 10 names of the ETN DS files that were recently edited, as menu items. You can easily open a ETN DS file by using them.

Exit Exits the datasheet characterization software. Unsaved data is destroyed.

Edit Menu

Displays the following menu items to edit the setup.

Cut Moves the selected text to the clipboard.

Copy Copies the selected text to the clipboard.

Paste Pastes the text from the clipboard to the insertion point.

On-screen keyboard... Displays the on-screen keyboard.

View Menu

Displays the following menu items for the display setting.

Go to Palette Displays the software palette in fullscreen mode.

Page Displays the following menu items used the page scrolling.

Up Scrolls up.

Down Scrolls down.

Main Window Displays the following menu item.

Fullscreen Changes the display style of the main window.

If this is marked, the main window does not have the titlebar and is displayed in fullscreen mode.

If this is unmarked, the main window has the titlebar and is displayed in the regular window style.

This is initially marked.

Color Settings... Opens the Color Setting dialog box to set the color for parts in this software. See “Color Setting dialog box” on page 4-29.

Measurement Menu

Displays the following menu items for controlling the measurement.

Start with data cleared

Starts to measure the marked measurement items in sequence. At the starting point, the existing measurement data for the all measurement items is cleared. During the measurement, the measurement status indicator on the front panel lights up.

Start without data cleared

Starts to measure the marked measurement items in sequence. At the starting point, the existing measurement data for the marked measurement items is cleared, but the measurement data for the unmarked items is retained. If the measurement is aborted, the measurement data acquired before aborting is retained. During the measurement, the measurement status indicator on the front panel lights up.

Stop

Stops the measurement.

You can also use the Stop Measurement button  on the toolbar or the Stop key on the front panel to stop the measurement.

Options

Sets the measurement execution option.

- Stop if an actual value is out of range

While this option has been checked, the measurement stops automatically if the measurement result (Act.) is out of the range from Min. to Max. for a Characteristics Parameters item. Measurements for the next items are not performed.

Setup Menu

Displays the following menu items for setting up the measurement items.

Check All

Marks the check boxes of all characteristics parameters and graphs to measure all of them.

Uncheck All

Unmarks the check boxes of all characteristics parameters and graphs to not measure all of them.

Setup

Launches one of the following software corresponding to the highlighted (selected) measurement item of Characteristics Parameters or Characteristics Graphs and displays its setup and measurement data.

- “I/V Measurement Software”
- “Capacitance Measurement Software”
- “Gate Charge Measurement Software”

On this software, you can change typical measurement conditions and perform measurement for this item.

Saving data on this software will send the data to the datasheet characterization software GUI, too. It does not save the ETN DS file.

Add

Adds new items by using the following sub-menu.

- **Maximum Rating**
Opens the Maximum Rating Properties dialog box (page 4-30). Setting up the new item’s properties adds it to the Maximum Ratings.
- **Characteristics Parameter**
Opens the Open Data dialog box. And selecting the original data file for the new item opens the Characteristics Parameter Properties dialog box (page 4-30). Setting up the new item’s properties adds it to the Characteristics Parameters.
- **Characteristics Graph**
Opens the Open Data dialog box. And selecting the original data file for the new item opens the Characteristics Graph Properties dialog box (page 4-33). Setting up the new item’s properties adds it to the Characteristics Graphs.

Import

Imports data in a measurement data file created by the following measurement software to the setup and measurement data of the measurement item highlighted (selected) in the Characteristics Parameter area or Characteristic Graphs area.

- “I/V Measurement Software”
- “Capacitance Measurement Software”
- “Gate Charge Measurement Software”

Data import can be done as follows.

1. Highlight (select) the target measurement item.

2. Select Setup > Import menu.

The Open Data dialog box opens.

As the initial importing folder, the initial saving folder of the measurement software related to the highlighted item is opened.

3. Select a measurement data file to import the setup and measurement data corresponding to the highlighted item.

As above, the existing the setup and measurement data for the highlighted item are cleared, and the setup and measurement data are imported from the specified measurement data file.

It is useful when you need to import the existing data to a new additional measurement item or replace the setup and measurement data with the existing data.

Duplicate

Makes a duplicate of the measurement item highlighted (selected) in the Characteristics Parameters area or Characteristics Graphs area.

Duplicate can be done as follows.

1. Highlight (select) the target measurement item.
2. Select Setup > Duplicate menu.
The duplicated item is placed after the highlighted item.

It is useful when you need to measure the same characteristics parameter with multiple conditions.

Move Up

Moves the highlighted (selected) item upward.

Move Down

Moves the highlighted (selected) item downward.

Properties

If an item of the Maximum Ratings is highlighted (selected), opens the Maximum Rating Properties dialog box (page 4-30) with its properties.

If an item of the Characteristics Parameters is highlighted (selected), opens the Characteristics Parameter Properties dialog box (page 4-30) with its properties.

If an item of the Characteristics Graphs is highlighted (selected), opens the Characteristics Graph Properties dialog box (page 4-33) with its properties.

Edit Setup Launches one of the following software corresponding to the highlighted (selected) measurement item of Characteristics Parameters or Characteristics Graphs and displays its setup and measurement data.

- “I/V Measurement Software”
- “Capacitance Measurement Software”
- “Gate Charge Measurement Software”

On this software, you can change all measurement conditions and perform measurement for this item.

Saving data on this software will send the data to the datasheet characterization software GUI, too. It does not save the ETN DS file.

Recycle Restores the deleted item from the recycle bin.

Delete Deletes the measurement item highlighted (selected) in the Characteristics Parameters area or Characteristics Graphs area.

Configuration Menu Displays the following menu item to administrate the configuration of the built-in modules in the mainframe and test fixture.

Module... Opens the Module Configuration dialog box. See “Module Configuration Dialog Box” on page 4-183.

Help Menu Displays the following menu item.

About... Opens the about box. See “About box” on page 4-35.

Dialog Boxes

Change Device ID dialog box

This dialog box is used to change the device ID in all selected ETN DS files at once.

This dialog box is opened by selecting the main menu File > Change Device ID....

- | | |
|------------------------|--|
| Device ID field | Enter a new device ID. You can also select it from the history. |
| Add... button | Opens the file selection dialog box to select the ETN DS file(s) that you want to change the device ID. The selected ETN DS files are displayed into the list. |
| Remove button | Excludes the selected ETN DS file from the list. |
| Execute button | Changes the device ID. |
| Close button | Closes this dialog box. |

Color Setting dialog box

This dialog box is used to set colors of the following parts in this software. The setting in the Color Setting dialog box is saved as a user setting.

- Window Background
- Graph Background
- Graph Axis
- Graph Grid
- Graph Text
- Trace

This dialog box is opened by selecting the main menu View > Color Settings....

Clicking the color pattern opens the dialog box for selecting a color.

- | | |
|----------------------|---|
| Apply button | Applies the present setting to the graph. |
| Reset button | Resets to the default setting. |
| OK button | Applies the present setting to the graph, and closes this dialog box. |
| Cancel button | Closes this dialog box without applying the present setting. |

Maximum Rating Properties dialog box

This dialog box is used to display and edit the properties of the item (rating parameter) highlighted (selected) in the Maximum Ratings.

Parameter	Sets the following properties corresponding to the display/entry fields in the Maximum Ratings.
Symbol	Symbol to identify the rating parameter
Parameter	Name or description
Value	Sets the maximum rating value (<i>Point</i>) or the allowable range (<i>Range</i>).
Unit	Unit
Note	Note or comment
Test Conditions	Sets the condition corresponding to the Test Conditions field in the Maximum Ratings. Sets the applicable condition for the rating parameter by the <i>Text</i> , <i>Parameter</i> , or <i>Range</i> format.
Text	Specify the applicable condition by text.
Parameter	Specify the applicable condition name, the applicable value, and the unit.
Range	Specify the applicable condition name, the applicable range, and the unit.
OK button	Applies the present setting, and closes this dialog box.
Cancel button	Closes this dialog box without applying the present setting.

Characteristics Parameter Properties dialog box

This dialog box is used to display and edit the properties of the item (measurement parameter) highlighted (selected) in the Characteristics Parameters.

Parameter	Specifies the measurement data file of the software used for this parameter measurement, and sets the properties corresponding to the display/entry fields in the Characteristics Parameters.
Data File	Name of the measurement data file
Symbol	Symbol to identify the measurement parameter
Parameter	Name or description

	Domain, Value	Associates the measurement parameter (<i>Act.</i> , measurement result value) with the variable used in the measurement software. See “Value and Domain” on page 4-31.
	Minimum, Maximum	Minimum value (<i>Min.</i>) and maximum value (<i>Max.</i>) See “Minimum and Maximum” on page 4-32.
	Unit	Unit
	Note	Note or comment
Test Conditions		Defines the setup parameters corresponding to the Test Conditions field in the Characteristics Parameters. Multiple parameters can be set.
	Symbol	Symbol to identify the setup parameter
	Parameter	Name or description
	Value	Setup value
	Unit	Unit
	Rating Symbol	Maximum rating Selects the maximum rating applied to this setup parameter from the drop down menu (optional).
	Setup, Gain, Offset	Associates this setup parameter with the setup item used in the measurement software. See “Setup, Gain, and Offset” on page 4-32. To add/delete/up/down the setup parameter, use the buttons located in the upper right portion of the dialog box.
OK button		Applies the present setting, and closes this dialog box.
Cancel button		Closes this dialog box without applying the present setting.

Value and Domain.

These fields are used to associate the measurement parameter (*Act.*, measurement result value) with the variable used in the measurement software.

Value	Variable corresponding to the measurement parameter
Domain	Variable other than the one set to <i>Value</i> . For example, set the variable used for the sweep output.

Measurement result of the parameter is the *Act.* value given by the following formula. And it is displayed in the *Act.* field in the Characteristics Parameters.

$$Act. = Data \times Gain + Offset$$

Where, *Data*, *Gain*, and *Offset* are the following values.

- *Data*: Actual measurement value given by the variable set to the *Value* field
- *Gain*: Value of the *Gain* field right next to the *Value* field
- *Offset*: Value of the *Offset* field right next to the *Gain* field

The variable set to the Domain field is used if an exception occurs during the measurement. For example, it is used for extracting the last effective data if the sweep stops automatically when measuring the parameter given by the sweep measurement results.

Minimum and Maximum.

These fields are used to set the minimum and maximum values of the measurement parameter. They are corresponding to the *Min.* and *Max.* fields in the Characteristics Parameters. If the field is blank, the minimum/maximum value is not set.

There is the *Setup* field (optional) right next to these fields. This field is used to associate the *Minimum/Maximum* field with the setup item used in the measurement software. If the *Setup* field is set, the *A* value given by the following formula is set to the setup item. Where, *Gain/Offset* is the value of the *Gain/Offset* field located below the *Setup* field.

$$A = Minimum \times Gain + Offset \text{ or } Maximum \times Gain + Offset$$

Setup, Gain, and Offset.

The *Setup* field (optional) is used to associate the setup parameter (*Value* field of Test Conditions) with the setup item used in the measurement software. If the *Setup* field is set, the *A* value given by the following formula is set to the setup item. Where, *Gain/Offset* is the value of the *Gain/Offset* field located below the *Setup* field.

$$A = Value \times Gain + Offset$$

Characteristics Graph Properties dialog box

This dialog box is used to display and edit the properties of the item (sweep measurement graph) highlighted (selected) in the Characteristics Graphs.

Data Specifies the measurement data file of the software used for this sweep measurement, and specifies the data plotted on the graph.

Data File Name of the measurement data file

X, Y Associates the X-Y data with the variables used in the measurement software. See “X and Y” on page 4-33.

Data Aliases This function is effective for the graph which contains multiple traces. It can replace the variable name part (*Key*) of the trace label with the other string (*Value*).

For example on the ID-VDS graph, each trace has the label like $VGS = x$ V. In this condition, if *VGS* is set to the *Key* field and *Vg* is set to the *Value* field, the label is changed to $Vg = x$ V.

To add/delete/up/down the Data Aliases, use the buttons located in the upper right portion of the Key/Value setup table.

Graph Sets the graph properties.

Title Title of the graph

Axes Sets the label and the unit of the X-axis and the Y-axis. See “Axes” on page 4-34.

Scope Sets the graph scale. See “Scope” on page 4-34.

OK button Applies the present setting, and closes this dialog box.

Cancel button Closes this dialog box without applying the present setting.

X and Y.

These fields are used to associate the X-Y data with the variables used in the measurement software.

X Variable corresponding to the X-axis data

Y Variable corresponding to the Y-axis data

X-Y data is given by the following formula, and is plotted on the graph.

$$X \text{ or } Y = \text{Data} \times \text{Gain} + \text{Offset}$$

Where, *Data*, *Gain*, and *Offset* are the following values.

- *Data*: Measurement data given by the variable set to the *X* or *Y* field
- *Gain*: Value of the *Gain* field right next to the *X* or *Y* field
- *Offset*: Value of the *Offset* field right next to the *Gain* field

Axes.

These fields are used to set the label and the unit of the X-axis and the Y-axis.

X	Symbol for the X-axis
Y	Symbol for the Y-axis
Description	Name or description of the axis
Unit	Unit of the X-axis or Y-axis data

The *Description* value is used for the label. If this field is blank, the symbol is used for the label.

Scope.

These fields are used to set the graph scale of the X-axis and the Y-axis.

- **Scale**
Specifies the linear scale (Linear), the positive log scale (PositiveLog), or the negative log scale (NegativeLog).
There is the *Setup* field (optional) right next to this field. This field is used to associate the *Scale* field with the setup item used in the measurement software.
- **Range: Minimum and Maximum**
These fields are used to set the minimum and maximum values of the graph axes.
There is the *Setup* field (optional) right next to these fields. This field is used to associate the *Minimum/Maximum* field with the setup item used in the measurement software. If the *Setup* field is set, the *A* value given by the following formula is set to the setup item. Where, *Gain/Offset* is the value of the *Gain/Offset* field located below the *Setup* field.

$$A = \text{Minimum} \times \text{Gain} + \text{Offset} \text{ or } \text{Maximum} \times \text{Gain} + \text{Offset}$$

- **Range: Rating Symbol (optional)**
Selects the maximum rating applied to the value set to the *Minimum/Maximum* field from the drop down menu.

Datasheet Reporter

Datasheet Reporter provides the function to collect the measurement data for all of the Characteristics Parameters measurement items included in one or more ETN DS files and save it in a tab-separated values format (.txt file).

Add...	Opens the Please select the file to open dialog box. The ETN DS files under this function must be added to the list of the Datasheet Reporter.
Remove	Removes the highlighted (selected) ETN DS files from the list of the Datasheet Reporter.
Execute	Opens the Please select the file to save dialog box. The Datasheet Reporter applies this function to all ETN DS files in the list.
Close	Closes the Datasheet Reporter.

The created text file consists of one header line and multiple data lines. One data line is corresponding to one ETN DS file and contains the Device ID, the ETN DS file name, and the measurement data for all of the Characteristics Parameters measurement items included in the ETN DS file.

About box

The about box displays the model number, the software revision number, download URL for software updating, and so on.

This dialog box is opened by selecting the main menu Help > About....

Summary of Files

The following shows the summary of the files handled by the datasheet characterization software.

Table 4-1 Summary of Files

File Type	Description	Extension	Folder as Initial Setting
ETN DS file	<p>File only for this software. This has the measurement conditions and measurement data for all measurement items including the device ID and comment.</p> <p>The measurement conditions and measurement data are automatically saved to this file in the specified folder at the end of the measurement. And, you can also save this using the File menu anytime.</p>	*.pda-ds.zip	<p>C:\Users\<<user name>\Documents\Keysight\SeriesB150x\PowerDeviceAnalyzer\Datasheet\DataStore (You can change this)</p>
Text output file	<p>This has the measurement conditions and measurement data for all measurement items including the device ID and comment in the text format.</p> <p>You can save this using the File menu anytime.</p>	*.txt	<p>(You can specify the folder when saving the data)</p>
I/V Measurement Data File	<p>For importing. This is a measurement data file created by the I/V measurement software, and has the setup data and measurement data for the I/V measurement.</p>	*.pda-iv.txt	<p>C:\Users\<<user name>\Documents\Keysight\SeriesB150x\PowerDeviceAnalyzer\IV\DataStore (You can change this)</p>

File Type	Description	Extension	Folder as Initial Setting
Capacitance Measurement Data File	For importing. This is a measurement data file created by the capacitance measurement software, and has the setup data and measurement data for the capacitance measurement.	*.pda-cap.txt	C:\Users\<<user name>\Documents\Keysight\SeriesB150x\PowerDeviceAnalyzer\DeviceCapacitance\DataStore (You can change this)
Gate Charge Measurement Data File	For importing. This is a measurement data file created by the gate charge measurement software, and has the setup data and measurement data for the gate charge measurement.	*.pda-qg.txt	C:\Users\<<user name>\Documents\Keysight\SeriesB150x\PowerDeviceAnalyzer\GateCharge\DataStore (You can change this)
XPS output file	Output file in XPS ^a format	*.xps	(You can specify the folder when printing this file)

a. XPS (XML Paper Specification) is the standard document format on Windows.

File name of ETN DS File on Auto-saving

An auto-saved ETN DS file is named as follows:

<DeviceID>_<TEMP>_<TIME>.pda-ds.zip

<DeviceID>: Device ID

<TEMP>: Temperature

<TIME>: Time stamp on auto-saving

Example)

Device-1_@Ch1=30degC_Ch2=30degC_2014-10-30_18-56-55.pda-ds.zip

And, the file name is decided according to the following rule.

1. <TEMP> is the characters of the available thermometer identifiers and the thermometer readings. To enable thermometers, use the Thermal Monitor/Control Software. See “Thermal Monitor/Control Software” on page 4-163.

@<thermometer>=<reading>degC

- <thermometer>: An identifier of the available thermometer
 - Ch1** Channel 1 thermometer of B1506A
 - Ch2** Channel 2 thermometer of B1506A
 - Air** Thermometer on the air outlet port of the thermostream
 - DUT** Thermometer on the DUT port of the thermostream

- <reading>: A reading value of the thermometer in degrees centigrade
If multiple thermometers are available, the temperature information is concatenated by an underscore (_). The @ is attached only at the beginning of the temperature information.

Example) @Ch1=25degC_Ch2=75degC_Air=100degC

2. <TIME> is the characters of year, month, day, hour, minute, and second. The time stamp representation depends on the time setting on Windows. And, an invalid character is replaced with an underscore (_).

Example 1) 2014-10-30_18-56-55

Example 2) 30-10-2014_6-56-55_PM

3. If the file name duplicates the existing file name, the serial number from 2 enclosed by brackets is concatenated before the file extension.

Example)

Device-1_@Ch1=30degC_Ch2=30degC_2014-10-30_18-56-55(3).pda-ds.zip

Parameters Defined in Furnished Templates

This section provides the maximum ratings and characteristics measurement items defined in the representative templates furnished with this software.

MOSFET Template

The section shows the maximum ratings and characteristics measurement items defined in the template for the MOSFET devices using some tables.

The following table shows the maximum rating parameters defined in this template.

Table 4-2

Maximum Ratings

Parameter	Symbol
Drain to Source Voltage	VDSS
Gate to Source Voltage	VGSS
Pulsed Drain Current	IDM
Pulsed Body Diode Current	ISM

The following table shows the characteristics parameters that are defined in this template.

You can specify values to the parameters described in the Conditions column of the following table, as the measurement conditions. And, the rating parameter described in the Ratings column is used as the limit for the measurement conditions.

Table 4-3

Characteristics Parameters

Parameter	Symbol	Conditions	Ratings
Drain to Source Breakdown Voltage	BVDSS	ID	IDM
		VGS	VGSS
Drain Leakage Current	IDSS	VDS	VDSS
		VGS	VGSS
Gate Leakage Current	IGSS	VGS	VGSS
		VDS	VDSS

Parameter	Symbol	Conditions	Ratings
Gate Leakage Current (-) ^a	IGSS(-)	VGS	VGSS
		VDS	VDSS
Gate to Source Threshold Voltage ^b	VGS(th)	ID	IDM
Gate to Source Threshold Voltage (Constant Drain to Source Voltage)	VGS(th)	VDS	VDSS
		ID	IDM
Transconductance ^c	gfs	VDS	VDSS
		ID	IDM
Drain to Source On Resistance	RDS(on)	VGS	VGSS
		ID	IDM
		PulseWidth	
Drain to Source On Voltage	VDS(on)	VGS	VGSS
		ID	IDM
		PulseWidth	
Body Diode Forward Voltage	VSD	IS	ISM
		VGS	VGSS
Gate Resistance	Rg	VGS	VGSS
		f	
Input Capacitance	Ciss	VDS	VDSS
		VGS	VGSS
		f	
Output Capacitance	Coss	VDS	VDSS
		VGS	VGSS
		f	

Parameter	Symbol	Conditions	Ratings
Reverse Transfer Capacitance	Crss	VDS	VDSS
		VGS	VGSS
		f	
Total Gate Charge	Qg	Vds	VDSS
		Vgs(on)	VGSS
		Vgs(off)	VGSS
		Id	IDM
Gate to Source Charge	Qgs	Vds	VDSS
		Vgs(on)	VGSS
		Vgs(off)	VGSS
		Id	IDM
Gate to Drain Charge	Qgd	Vds	VDSS
		Vgs(on)	VGSS
		Vgs(off)	VGSS
		Id	IDM
Gate to Source Plateau Voltage	Vgs(pl)	Vds	VDSS
		Vgs(on)	VGSS
		Vgs(off)	VGSS
		Id	IDM

- a. This is a measurement with a negative voltage.
- b. The same voltage is forced to between the drain-source terminals and the gate-source terminals at the measurement.
- c. Available for the B1506A-H20/H21.

The following table shows the characteristics graphs that are defined in this template.

The X and Y in the Symbol column show the measurement data specified as the X and Y-axes data on the graph. And, the rating parameters in the X and Y of the Ratings column are used as the limit for the measurement conditions.

Table 4-4 **Characteristics Graphs**

Characteristics	Symbols		Ratings	
	X	Y	X	Y
Output Characteristics	VDS	ID	VDSS	IDM
Transfer Characteristics	VGS	ID	VGSS	IDM
Drain to Source Resistance vs. Drain Current	ID	RDS	IDM	
Drain to Source Resistance vs. Gate to Source Voltage	VGS	RDS	VGSS	
Drain to Source Voltage vs. Gate to Source Voltage	VGS	VDS	VGSS	VDSS
Body Diode Forward Characteristics	VSD	IS	VDSS	ISM
Capacitances vs. Drain to Source Voltage	VDS	Ciss, Coss, Crss	VDSS	
Gate Charge Characteristics	Qg	Vgs		VGSS

The following describes about the symbols in the Conditions column of Table 4-3 on page 4-39 and in the Symbols column of Table 4-4 on page 4-42.

Table 4-5 **Glossary of MOSFET Template**

Symbol	Description
VGS	Gate-source voltage
VDS	Drain-source voltage
ID	Drain current
PulseWidth	Pulse width of drain current/voltage
f	AC signal frequency

Symbol	Description
IS	Body diode forward current (source current)
VSD	Body diode forward voltage (source-drain voltage)
RDS	Drain-source resistance
Ciss	Input capacitance
Coss	Output capacitance
Crss	Reverse transfer capacitance
Qg	Gate charge
Vgs	Gate-source voltage (gate charge measurement)
Vgs(on)	Gate-source “On-state” voltage (gate charge measurement)
Vgs(off)	Gate-source “Off-state” voltage (gate charge measurement)
Vds	Drain-source “Off-state” voltage (gate charge measurement)
Id	Drain “On-state” current (gate charge measurement)

IGBT Template

The section shows the maximum ratings and characteristics measurement items defined in the template for the IGBT devices using some tables.

The following table shows the maximum rating parameters defined in this template.

Table 4-6

Maximum Ratings

Parameter	Symbol
Collector to Emitter Voltage	VCES
Gate to Emitter Voltage	VGES
Pulsed Collector Current	ICM
Pulsed Freewheeling Diode Current	IFM

The following table shows the characteristics parameters that are defined in this template.

You can specify values to the parameters described in the Conditions column of the following table, as the measurement conditions. And, the rating parameter described in the Ratings column is used as the limit for the measurement conditions.

Table 4-7

Characteristics Parameters

Parameter	Symbol	Conditions	Ratings
Collector to Emitter Breakdown Voltage	BVCES	IC	ICM
		VGE	VGES
Collector Leakage Current	ICES	VCE	VCES
		VGE	VGES
Gate Leakage Current	IGES	VGE	VGES
		VCE	VCES
Gate Leakage Current (-) ^a	IGES(-)	VGE	VGES
		VCE	VCES
Gate to Emitter Threshold Voltage ^b	VGE(th)	IC	ICM

Parameter	Symbol	Conditions	Ratings
Gate to Emitter Threshold Voltage (Constant Collector to Emitter Voltage)	VGE(th)	VCE	VCES
		IC	ICM
Collector to Emitter Saturation Voltage	VCE(sat)	VGE	VGES
		IC	ICM
		PulseWidth	
Transconductance ^c	gfs	VCE	VCES
		IC	ICM
Freewheeling Diode Forward Voltage	VF	IF	IFM
		VF	VCES
Gate Resistance	Rg	VGE	VGES
		f	
Input Capacitance	Cies	VCE	VCES
		VGE	VGES
		f	
Output Capacitance	Coes	VCE	VCES
		VGE	VGES
		f	
Reverse Transfer Capacitance	Cres	VCE	VCES
		VGE	VGES
		f	
Total Gate Charge	Qg	Vce	VCES
		Vge(on)	VGES
		Vge(off)	VGES
		IC	ICM

Parameter	Symbol	Conditions	Ratings
Gate to Emitter Charge	Qge	Vce	VCES
		Vge(on)	VGES
		Vge(off)	VGES
		Ic	ICM
Gate to Collector Charge	Qgc	Vce	VCES
		Vge(on)	VGES
		Vge(off)	VGES
		Ic	ICM
Gate to Emitter Plateau Voltage	Vge(pl)	Vce	VCES
		Vge(on)	VGES
		Vge(off)	VGES
		Ic	ICM

- a. This is a measurement with a negative voltage.
- b. The same voltage is forced to between the collector-emitter terminals and the gate-emitter terminals at the measurement.
- c. Available for the B1506A-H20/H21.

The following table shows the characteristics graphs that are defined in this template.

The X and Y in the Symbol column show the measurement data specified as the X and Y-axes data on the graph. And, the rating parameters in the X and Y of the Ratings column are used as the limit for the measurement conditions.

Table 4-8 Characteristics Graphs

Characteristics	Symbols		Ratings	
	X	Y	X	Y
Output Characteristics	VCE	IC	VCES	ICM
Transfer Characteristics	VGE	IC	VGES	ICM
Collector to Emitter Voltage vs. Gate to Emitter Voltage	VCE	VGE	VCES	VGES
Freewheeling Diode Forward Characteristics	VF	IF	VCES	IFM
Capacitances vs. Collector to Emitter Voltage	VCE	Cies, Coes, Cres	VCES	
Gate Charge Characteristics	Qg	Vge		VGES

The following describes about the symbols in the Conditions column of Table 4-7 on page 4-44 and in the Symbols column of Table 4-8 on page 4-47.

Table 4-9 Glossary of IGBT Template

Symbol	Description
VGE	Gate-emitter voltage
VCE	Collector-emitter voltage
IC	Collector current
PulseWidth	Pulse width of collector current/voltage
f	AC signal frequency
IF	Free-wheel diode forward current
VF	Free-wheel diode forward voltage
Cies	Input capacitance
Coes	Output capacitance

Symbol	Description
Cres	Reverse transfer capacitance
Qg	Gate charge
Vge	Gate-emitter voltage (gate charge measurement)
Vge(on)	Gate-emitter “On-state” voltage (gate charge measurement)
Vge(off)	Gate-emitter “Off-state” voltage (gate charge measurement)
Vce	Collector-emitter “Off-state” voltage (gate charge measurement)
Ic	Collector “On-state” current (gate charge measurement)

BJT Template

The section shows the maximum ratings and characteristics measurement items defined in the template for the BJT devices using some tables.

The following table shows the maximum rating parameters defined in this template.

Table 4-10

Maximum Ratings

Parameter	Symbol
Collector-Emitter Voltage	VCEO
Collector-Base Voltage	VCBO
Emitter-Base Voltage	VEBO
Collector Current	IC
Pulsed Collector Current	ICM
Base Current	IB
Total Power Dissipation	PD
Operating Junction Temperature	Tj

The following table shows the characteristics parameters that are defined in this template.

You can specify values to the parameters described in the Conditions column of the following table, as the measurement conditions. And, the rating parameter described in the Ratings column is used as the limit for the measurement conditions.

Table 4-11

Characteristics Parameters

Parameter	Symbol	Conditions	Ratings
Collector Cutoff Current	ICEO	VCE	VCEO
		IB	IB
Emitter Cutoff Current	IEBO	VEB	VEBO
		IC	IC

Parameter	Symbol	Conditions	Ratings
DC Current Gain ^a	hFE	VCE	VCEO
		IC	ICM
Collector-Emitter Saturation Voltage	VCE(sat)	IC	ICM
		IB	IB
Base-Emitter Saturation Voltage	VBE(sat)	IC	ICM
		IB	IB
Base-Emitter ON Voltage ^a	VBE(on)	VCE	VCEO
		IC	ICM
Collector-Emitter Breakdown Voltage	V(BR)CEO	IC	IC
		IB	IB
Emitter-Base Breakdown Voltage	V(BR)EBO	IE	IB
		IC	IC

a. Available for the B1506A-H20/H21.

The following table shows the characteristics graphs that are defined in this template.

The X and Y in the Symbol column show the measurement data specified as the X and Y-axes data on the graph. And, the rating parameters in the X and Y of the Ratings column are used as the limit for the measurement conditions.

Table 4-12

Characteristics Graphs

Characteristics	Symbols		Ratings	
	X	Y	X	Y
Output Characteristics	VCE	IC	VCE O	ICM
DC Current Gain ^a	IC	hFE	ICM	
Base-Emitter Voltage ^a	IC	VBE	ICM	

- a. Available for the B1506A-H20/H21.

The following describes about the symbols in the Conditions column of Table 4-11 on page 4-49 and in the Symbols column of Table 4-12 on page 4-50.

Table 4-13

Glossary of BJT Template

Symbol	Description
VBE	Base-emitter voltage
VEB	Emitter-base voltage
IB	Base current
IE	Emitter current
VCE	Collector-emitter voltage
IC	Collector current
hFE	DC current amplification factor

Diode Template

The section shows the maximum ratings and characteristics measurement items defined in the template for the diodes using some tables.

The following table shows the maximum rating parameters defined in this template.

Table 4-14

Maximum Ratings

Parameter	Symbol
Reverse Voltage	VR
Pulsed Forward Current	IFM

The following table shows the characteristics parameters that are defined in this template.

You can specify values to the parameters described in the Conditions column of the following table, as the measurement conditions. And, the rating parameter described in the Ratings column is used as the limit for the measurement conditions.

Table 4-15

Characteristics Parameters

Parameter	Symbol	Conditions	Ratings
DC Blocking Voltage	VDC	IR	
Forward Voltage	VF	IF	IFM
Reverse Current	IR	VR	VR
Total Capacitance	CT	VR	VR
		f	

The following table shows the characteristics graphs that are defined in this template.

The X and Y in the Symbol column show the measurement data specified as the X and Y-axes data on the graph. And, the rating parameters in the X and Y of the Ratings column are used as the limit for the measurement conditions.

Table 4-16 **Characteristics Graphs**

Characteristics	Symbols		Ratings	
	X	Y	X	Y
Forward Characteristics	VF	IF		IFM
Reverse Characteristics	VR	IR	VR	
Capacitance	VR	CT	VR	

The following describes about the symbols in the Conditions column of Table 4-15 on page 4-52 and in the Symbols column of Table 4-16 on page 4-53.

Table 4-17 **Glossary of Diode Template**

Symbol	Description
IR	Reverse current
IF	Forward current
VR	Reverse voltage
f	AC signal frequency
VF	Forward voltage
CT	Total capacitance

Creating Custom File

This section introduces a procedure and essentials to create a new ETN DS file to be fitted to specific devices.

1. After starting this software, select the type of your device and then click the New Datasheet button  in the Identification area.

This reads the data from the selected template, and provides the foundation for a new ETN DS file.

2. Create a new ETN DS file with an appropriate name using the main menu File > Save as.

For example, if you specify CustomMOSFET as a new name, CustomMOSFET.pda-ds.zip file is created.

3. Open the ETN DS file (for example, CustomMOSFET) using the main menu File > Open. Skip this step if you operate continuously.
4. Customize the measurement conditions and so on with referring to the “Customization Essentials” below.

5. After finishing all customization, save all setup data and measurement data to the ETN DS file using the main menu File > Save.



To use the ETN DS file as a template for evaluating same device model, it is recommended to manage it with keeping from changing. When evaluating each individual device, use a copy of the ETN DS file

NOTE

During opening the ETN DS file, don't use the Device Type and New Datasheet button . If they are used, it rewrites all data by the furnished template.

Customization Essentials

- Customizing in the Identification area
 - Enter appropriate information to the fields.
- Customizing in the Maximum Ratings area
 - Review the maximum rating values, and change them to values appropriate for your device.
- Customizing in the Characteristics Parameters and Characteristics Graphs areas

- Review the measurement items, and delete unnecessary items.
To do so, highlight (select) a measurement item, and then click the Delete button  on the toolbar (or select Delete from the Setup menu).
- Review the measurement items, and make duplicates of the measurement item if you need to measure the same characteristics parameter/graph with multiple conditions.
To do so, highlight (select) a measurement item, and then click the Duplicate button  on the toolbar (or select Duplicate from the Setup menu).
- For the characteristics parameters, change the parameter values of the Test Conditions to new preset values appropriate for your device.

For the characteristics graphs, change the minimum and maximum values on the voltage/current axes to new preset output values appropriate for your device.
- Review the detailed settings for each measurement item, and change them if necessary.
To do so, highlight (select) a measurement item, and then click the Setup button  on the toolbar (or select Setup from the Setup menu).

A measurement software related to the highlighted item is launched with the detailed settings for the item.

Review the detailed settings on the launched measurement software, adjust them with executing the measurement. The measurement result is automatically reflected onto the datasheet characterization software GUI.

If you change the settings without executing the measurement on the launched measurement software, save new settings to the present measurement data file. The new settings saved into the measurement data file are reflected to the ETN DS file when saving the ETN DS file.
- Conveniently save the ETN DS file
By saving the ETN DS file, the changes on the launched measurement software are reflected to the ETN DS file
- After finishing to adjust the settings of all measurement items, mark the check boxes of all measurement items, start the datasheet characterization measurement for all items, and then check all results.

I/V Measurement Software

I/V Measurement Software provides:

- Voltage/current sweep/spot measurements
- DC/pulse outputs
- Linear/log sweep with both single (one-way) and double (round-trip) capability for the primary sweep source (similar to the collector supply of a conventional curve tracer)
- Linear/list sweep capability for the secondary sweep source (corresponding to the step generator of a conventional curve tracer)
- The ability to assign the primary sweep source or the secondary sweep source to either the collector/drain terminal or to the base/gate terminal.
- Intuitive and interactive sweep/spot measurement operation using rotary knob.
- Predefined templates for typical MOSFET, IGBT and Diode I/V measurements.

I/V Measurement Software supports Oscilloscope View function in the pulse mode operation. At the specified measurement point on the characteristic trace, this function can monitor both voltage and current waveforms for the measurement channels of all supported modules. Oscilloscope View supports the following modules:

- MCSMU
- HVSMU
- HCSMU
- UHCU

GUI Overview

The GUI (Graphical User Interface) of the I/V measurement software is comprised of the following areas.

Figure 4-9

I/V Measurement Software GUI

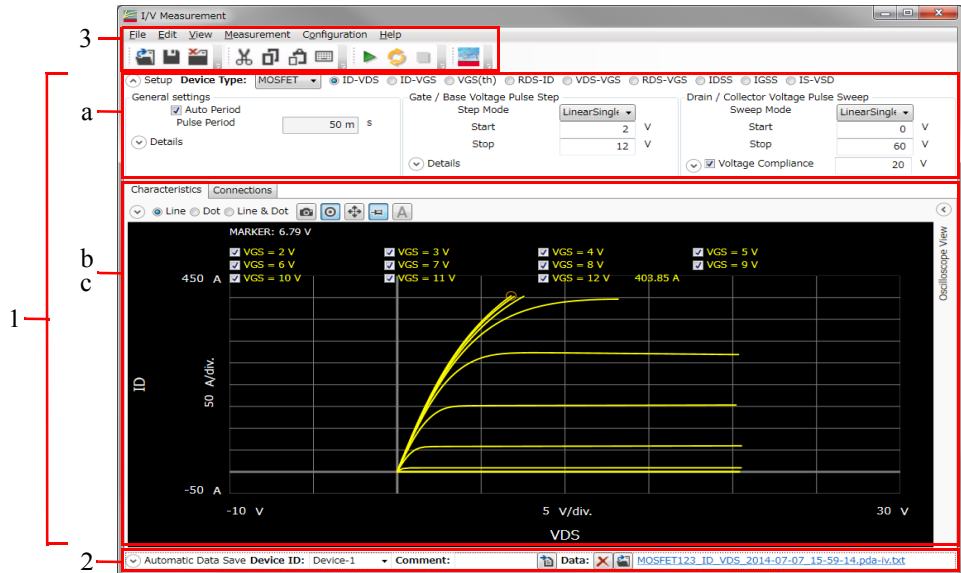

1. Work Area (See p. 4-58.)

This area provides the functions to set the measurement conditions and observe the measurement results. This is separated to the following areas.

- a. Setup (See p. 4-58.)
- b. Characteristics (See p. 4-74.)
- c. Connections (See p. 4-80.)

2. Automatic Data Save (See p. 4-82.)

This area provides the functions regarding the automatic saving of the measurement data files.

3. Operating Tools

- Toolbar (See p. 4-83.)

This provides the functions that are very frequently used in the button format.

- Main Menu (See p. 4-85.)

This provides the functions needed for various operations in the menu format.

For the dialog boxes displayed during this software operation, see “Dialog Boxes” on page 4-87.

For the files handled by this software, see “Summary of Files” on page 4-88.

Work Area

In this area, set the measurement conditions and observe the measurement results. This is separated to the following areas.

- Setup (See p. 4-58.)
- Characteristics (See p. 4-74.)
- Connections (See p. 4-80.)

Setup

This is an area to select the device type and its measured I/V characteristics, and enter your measurement conditions.

Figure 4-10

Setup

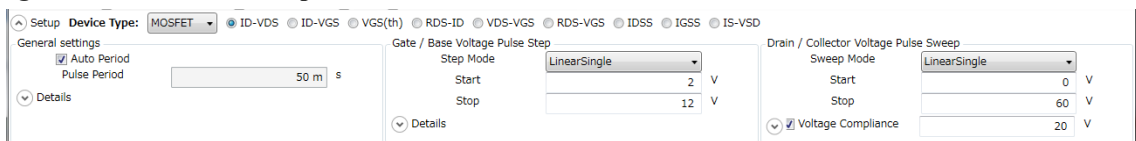

Device Type

Select the device type of your DUT from below.

- MOSFET
- IGBT
- BJT
- Diode
- Generic2T

This is for two-terminal general devices.

- **Generic**

Select the Generic to execute more general measurements for device other than above types.

MOSFET

You can select one of the following I/V characteristics measurements for “MOSFET” device type.

- **ID-VDS**

Creates new settings to measure the output characteristics.

- **ID-VGS**

Creates new settings to measure the transfer characteristics.

- **VGS(th)**

Creates new settings to measure the threshold voltage.

- **RDS-ID**

Creates new settings to measure the drain-source resistance characteristics for the drain current.

- **VDS-VGS**

Creates new settings to measure the drain-source voltage characteristics for the gate-source voltage.

- **RDS-VGS**

Creates new settings to measure the drain-source resistance characteristics for the gate-source voltage.

- **IDSS**

Creates new settings to measure the drain leak current characteristics for the drain-source voltage.

- **IGSS**

Creates new settings to measure the gate leak current characteristics for the gate-source voltage.

- **IS-VSD**

Creates new settings to measure the forward characteristics of the body diode for the source-drain voltage.

IGBT

You can select one of the following I/V characteristics measurements for “IGBT” device type.

- IC-VCE
Creates new settings to measure the output characteristics.
- IC-VGE
Creates new settings to measure the transfer characteristics.
- VGE(th)
Creates new settings to measure the threshold voltage.
- VCE-VGE
Creates new settings to measure the collector-emitter voltage characteristics for the gate-emitter voltage.
- VCE(sat)
Creates new settings to measure the collector-emitter saturation voltage characteristics for the collector current.
- ICES
Creates new settings to measure the collector leak current characteristics for the collector-emitter voltage.
- IGES
Creates new settings to measure the gate leak current characteristics for the gate-emitter voltage.
- IF-VF
Creates new settings to measure the free-wheel diode forward characteristics.

BJT

You can select one of the following I/V characteristics measurements for “BJT” device type.

- IC-VCE
Creates new settings to measure the output characteristics.
- hFE
Creates new settings to measure the DC current amplification factor characteristics (hFE-IC).
- VBE(on)

Creates new settings to measure the base-emitter ON voltage characteristics (VBE-IC).

- ICEO

Creates new settings to measure the collector leakage current characteristics for the collector-emitter voltage with the base open condition.

- ICES

Creates new settings to measure the collector leakage current characteristics for the collector-emitter voltage with the base-emitter short condition.

- IEBO

Creates new settings to measure the emitter leakage current characteristics for the emitter-base voltage with the collector open condition.

Diode

You can select one of the following I/V characteristics measurements for “Diode” device type.

- IF-VF

Creates new settings to measure the forward bias characteristics.

- IR-VR

Creates new settings to measure the reverse bias characteristics.

Generic2T

You can select on of the following I/V characteristics measurements for “Generic2T” device type.

- Conduction

Creates new settings to measure the conduction resistance characteristics.

- Isolation

Creates new settings to measure the isolation characteristics.

Generic

Set your measurement conditions in “General settings” on page 4-61, “Gate/Base drive settings” on page 4-63, and “Drain/Collector drive settings” on page 4-64 for “Generic” device type.

General settings

In this area, you can set the following measurement conditions for DC output measurement or pulse output measurement.

For DC output measurement:

- Trace Mode

Quick	Performs fast staircase sweep measurement using the fixed range mode.
Fine	Performs accurate staircase sweep measurement using the auto ranging mode.

- For Quick trace mode:
 - Step Time
Specify the period between steps for the staircase sweep.
Setting range: 500 μ s to 5 s
 - Aperture
Specify the measurement time at each step for the staircase sweep.
Setting range: 2 μ s to 20 ms
 - Hold Time
Specify the hold time of the sweep start voltage. At the sweep start point, the start voltage is forced for more than the specified time.
Setting range: 0 to 655.35 s
- For Fine trace mode:
 - NPLC
Set the measurement time by specifying the number of power line cycles.
Setting range: 1 to 100
 - Delay Time
Specify the wait time until starting measurement since starting output at each step of the staircase sweep.
Setting range: 0 to 65.535 s
 - Hold Time
Specify the hold time of the sweep start voltage. At the sweep start point, the start voltage is forced for more than the specified time.
Setting range: 0 to 655.35 s

For pulse output measurement:

- Auto Period
Enable or disable the automatic adjustment for the pulse period. To enable this, mark the check box.
- Pulse Period

Specify the pulse period.

Setting range: 5 ms to 5 s

If the Auto Period is enabled, this is automatically adjusted to minimum period corresponding to the pulse width.

- Aperture

Specify the measurement time at each pulse.

Setting range: 2 μ s to 20 ms

- Hold Time

Specify the hold time of the sweep start voltage. At the sweep start point, the start voltage is forced for more than the specified time.

Setting range: 0 to 655.35 s

The following parameter can be shown or hidden by clicking the line of  Details.

- Aperture
- Hold Time

Gate/Base drive settings

Set the output voltage/current to the gate/base terminal. One of the following types is automatically selected depending on the selected characteristics measurement. The selected type is displayed on the title of this terminal setting area as shown in the following figure.

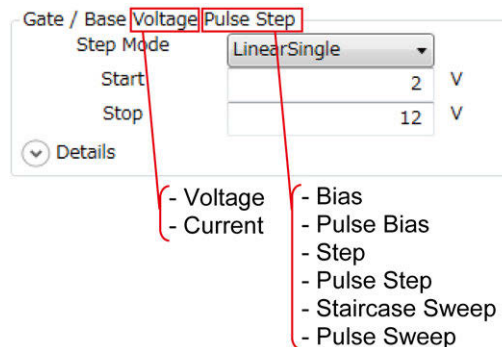

For the setting items of the types, see below.

- Bias (See p. 4-64.)
Outputs the constant bias voltage/current.
- Pulse Bias (See p. 4-65.)
Outputs the voltage or current pulse that the peak output is constant.

- Step (See p. 4-66.)
Outputs the constant voltage/current that the level is changed every time a sweep measurement is finished.
- Pulse Step (See p. 4-67.)
Outputs the voltage/current pulse that the peak level is changed every time a sweep measurement is finished.
- Staircase Sweep (See p. 4-68.)
Outputs the staircase-swept voltage/current.
- Pulse Sweep (See p. 4-70.)
Outputs the staircase-swept pulse voltage/current.

Drain/Collector drive settings

Set the output voltage/current to the drain/collector terminal. One of the following types is automatically selected depending on the selected characteristics measurement. The selected type is displayed on the title of this terminal setting area.

For the setting items of the types, see below.

- Bias (See p. 4-64.)
Outputs the constant bias voltage/current.
- Pulse Bias (See p. 4-65.)
Outputs the voltage or current pulse that the peak output is constant.
- Step (See p. 4-66.)
Outputs the constant voltage/current that the level is changed every time a sweep measurement is finished.
- Pulse Step (See p. 4-67.)
Outputs the voltage/current pulse that the peak level is changed every time a sweep measurement is finished.
- Staircase Sweep (See p. 4-68.)
Outputs the staircase-swept voltage/current.
- Pulse Sweep (See p. 4-70.)
Outputs the staircase-swept pulse voltage/current.

Bias

The terminal outputs the constant voltage or current.

Set the following parameters.

- Source
Specify an output voltage/current value.

The following parameters can be shown or hidden by clicking the line of  Details.

- Resource/Output Mode/Output Sequence
You can change the settings of this terminal using the pull-down menu. For details, see “Resource/Output Mode/Output Sequence” on page 4-71.
- Compliance
Specify a current/voltage compliance value.
If the output exceeds this, the sweep measurement is terminated.
- Voltage Compliance
Specify a voltage compliance value for UHCU.
To enable this, mark the check box.
If the output exceeds this, the sweep measurement is terminated.
Available for UHCU.

Pulse Bias

The terminal outputs the voltage or current pulse that the peak output is constant.
Set the following parameters.

- Source
Specify a pulse peak voltage/current value.

The following parameters can be shown or hidden by clicking the line of  Details.

- Resource/Output Mode/Output Sequence
You can change the settings of this terminal using the pull-down menu. For details, see “Resource/Output Mode/Output Sequence” on page 4-71.
- Base
Specify a pulse base voltage/current value.
- Compliance
Specify a current/voltage compliance value.
If the output exceeds this, the sweep measurement is terminated.
- Voltage Compliance
Specify a voltage compliance value for UHCU.
To enable this, mark the check box.
If the output exceeds this, the sweep measurement is terminated.
Available for UHCU.
- Pulse Delay

Specify a delay time from the beginning point of the pulse period to the raising point.

- Pulse Width

Specify a period of the pulse peak.

Step

The terminal outputs the constant voltage or current that the level is changed every time a sweep measurement is finished.

Set the following parameters.

- Step Mode

Select one from the following level change operation.

- LinearSingle: Constant level is changed by a constant step value.
- ListSingle: Constant level is changed according to the listed levels.

- Start

Specify the first step value.

Available for the “LinearSingle” Step Mode.

- Stop

Specify the last step value.

Available for the “LinearSingle” Step Mode.

The following parameters can be shown or hidden by clicking the line of  Details.

- Resource/Output Mode/Output Sequence

You can change the settings of this terminal using the pull-down menu. For details, see “Resource/Output Mode/Output Sequence” on page 4-71.

- Number of Step

Specify the number of steps.

Available for the “LinearSingle” Step Mode.

- List

Create the list of the output levels.

Available for the “ListSingle” Step Mode.

To insert a new step entry before the selected step value, click the Insert button .

To move the selected step value up/down, click the Move button .

To delete the selected step value, click the Delete button .

- Compliance
Specify a current/voltage compliance value.
If the output exceeds this, the sweep measurement is terminated.
- Power Compliance
Specify the power compliance value.
To enable this, mark the check box.
If the output exceeds this, the sweep measurement is terminated.
Not available for HVSMU.
- Voltage Compliance
Specify a voltage compliance value for UHCU.
To enable this, mark the check box.
If the output exceeds this, the sweep measurement is terminated.
Available for UHCU.

Pulse Step

The terminal outputs the voltage or current pulse that the peak level is changed every time a sweep measurement is finished.

Set the following parameters.

- Step Mode
Select one from the following level change operations.
 - LinearSingle: Peak level is changed by a constant step value.
 - ListSingle: Peak level is changed according to the listed levels.
- Start
Specify the first pulse peak value.
Available for the “LinearSingle” Step Mode.
- Stop
Specify the last pulse peak value.
Available for the “LinearSingle” Step Mode.
- List
Create the list of the output levels.
Available for the “ListSingle” Step Mode.

To insert a new step entry before the selected step value, click the Insert button .

To move the selected step value up/down, click the Move button .

To delete the selected step value, click the Delete button .

The following parameters can be shown or hidden by clicking the line of  Details.

- Resource/Output Mode/Output Sequence
You can change the settings of this terminal using the pull-down menu. For details, see “Resource/Output Mode/Output Sequence” on page 4-71.
- Base
Specify a pulse base voltage/current value.
- Number of Step
Specify the number of steps.
Available for the “LinearSingle” Step Mode.
- Compliance
Specify a current/voltage compliance value.
If the output exceeds this, the sweep measurement is terminated.
- Power Compliance
Specify the power compliance value.
To enable this, mark the check box.
If the output exceeds this, the sweep measurement is terminated.
Not available for HVSMU.
- Voltage Compliance
Specify a voltage compliance value for UHCU.
To enable this, mark the check box.
If the output exceeds this, the sweep measurement is terminated.
Available for UHCU.
- Pulse Delay
Specify a delay time from the beginning point of the pulse period to the raising point.
- Pulse Width
Specify a period of the pulse peak.

Staircase Sweep

The terminal outputs the staircase-swept voltage/current.

Set the following parameters.

- Sweep Mode

Select one from the following sweep modes.

- LinearSingle (Sweep from start to stop in a linear incremental step)
- LogSingle (Sweep from start to stop in a logarithmic incremental step)
- LinearDouble (Sweep from start to stop to start in a linear incremental step)
- LogDouble (Sweep from start to stop to start in a logarithmic incremental step)

- Sweep Polarity

Select one from the following polarity modes.

- Bipolar (Sweep for both positive and negative layers)
- Positive (Sweep for positive layer only)
- Negative (Sweep for negative layer only)

- Start

Specify the sweep start value.

- Stop

Specify the sweep stop value.

The following parameters can be shown or hidden by clicking the line of  Details.

- Resource/Output Mode/Output Sequence

You can change the settings of this terminal using the pull-down menu. For details, see “Resource/Output Mode/Output Sequence” on page 4-71.

- Number of Step

Specify the number of sweep steps from start to stop.

- Compliance

Specify a current/voltage compliance value.

If the output exceeds this, the sweep measurement is terminated.

- Power Compliance

Specify the power compliance value.

To enable this, mark the check box.

If the output exceeds this, the sweep measurement is terminated.

Not available for HVSMU.

- Voltage Compliance

Specify a voltage compliance value for UHCU.

To enable this, mark the check box.

If the output exceeds this, the sweep measurement is terminated.

Available for UHCU.

Pulse Sweep

The terminal outputs the staircase-swept pulse voltage/current.

Set the following parameters.

- Sweep Mode

Select one from the following sweep modes.

- LinearSingle (Sweep from start to stop in a linear incremental step)
- LogSingle (Sweep from start to stop in a logarithmic incremental step)
- LinearDouble (Sweep from start to stop to start in a linear incremental step)
- LogDouble (Sweep from start to stop to start in a logarithmic incremental step)

- Sweep Polarity

Select one from the following polarity modes.

- Bipolar (Sweep for both positive and negative layers)
- Positive (Sweep for positive layer only)
- Negative (Sweep for negative layer only)

- Start

Specify the sweep start value.

- Stop

Specify the sweep stop value.

The following parameters can be shown or hidden by clicking the line of  Details.

- Resource/Output Mode/Output Sequence

You can change the settings of this terminal using the pull-down menu. For details, see “Resource/Output Mode/Output Sequence” on page 4-71.

- Base

Specify a pulse base voltage/current value.

- **Number of Step**
Specify the number of sweep steps from start to stop.
- **Compliance**
Specify a current/voltage compliance value.
If the output exceeds this, the sweep measurement is terminated.
- **Power Compliance**
Specify the power compliance value.
To enable this, mark the check box.
If the output exceeds this, the sweep measurement is terminated.
Not available for HVSMU.
- **Voltage Compliance**
Specify a voltage compliance value for UHCU.
To enable this, mark the check box.
If the output exceeds this, the sweep measurement is terminated.
Available for UHCU.
- **Pulse Delay**
Specify a delay time from the beginning point of the pulse period to the raising point.
- **Pulse Width**
Specify a period of the pulse peak.

**Resource/Output
Mode/Output
Sequence**

Depending on the selected characteristics measurement, the pre-defined output mode and sequence are automatically selected. If necessary, you can change the measurement resource, the output mode, and the output sequence. Table 4-18 shows the available alternatives for the gate/base terminal, and Table 4-19 shows the available alternatives for the drain/collector terminal.

Table 4-18 Available Resource/Output Mode/Output Sequence for Gate/Base Terminal

Measurement Resource	Output Mode	Output Sequence
<ul style="list-style-type: none"> • MCSMU MCSMU is connected to this terminal. • MPSMU MPSMU is connected to this terminal. 	<ul style="list-style-type: none"> • V Specifies the DC voltage output. • VPulse Specifies the pulse voltage output. • I Specifies the DC current output. • IPulse Specifies the pulse current output. 	<ul style="list-style-type: none"> • Constant Specifies the constant bias output sequence. • Step Specifies the step bias output sequence. • Sweep Specifies the sweep output sequence.

Table 4-19

Available Resource/Output Mode/Output Sequence for Drain/Collector Terminal

Measurement Resource	Output Mode	Output Sequence
<ul style="list-style-type: none"> • Open No connection. This terminal is opened. • UHCU ^a UHCU is connected to this terminal. • HCSMU ^b HCSMU is connected to this terminal. • HVSMU HVSMU is connected to this terminal. • MPSMU MPSMU is connected to this terminal. 	<ul style="list-style-type: none"> • V^c Specifies the DC voltage output. • VPulse Specifies the pulse voltage output. • I^c Specifies the DC current output. • IPulse Specifies the pulse current output. 	<ul style="list-style-type: none"> • Constant Specifies the constant bias output sequence. • Step Specifies the step bias output sequence. • Sweep Specifies the sweep output sequence.

a. Available for B1506A-H50/H70/H51/H71.

b. Available for B1506A-H20/H21.

c. Not available for UHCU.

The combinations of the Output Mode and Output Sequence decide the types as shown in the following table.

Type	Output Mode	Output Sequence
Bias	V or I	Constant
Pulse Bias	VPulse or IPulse	Constant
Step	V or I	Step
Pulse Step	VPulse or IPulse	Step
Staircase Sweep	V or I	Sweep
Pulse Sweep	VPulse or IPulse	Sweep

Characteristics

This page shows the graph of the specified I/V characteristics as the measurement result. To display this page, click the Characteristics tab.

Figure 4-11

Characteristics

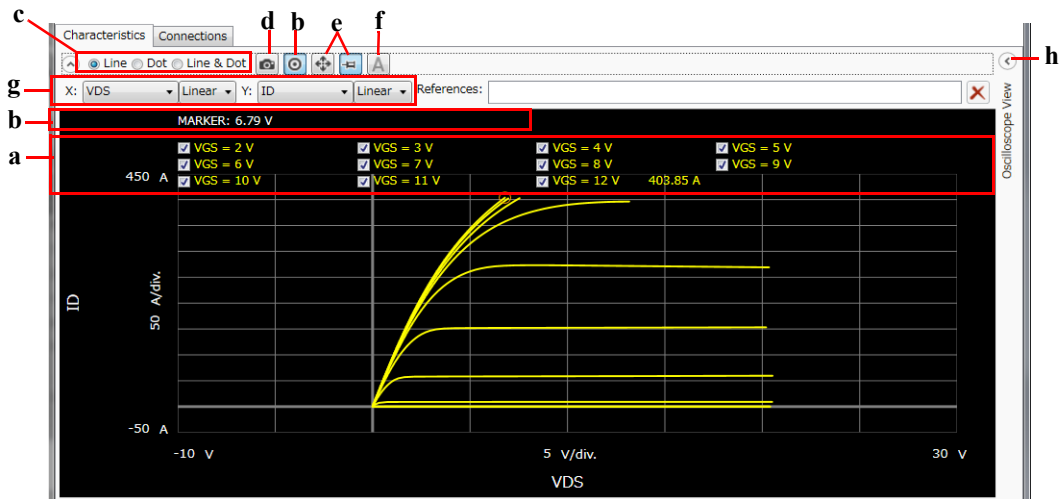

a. Displaying Characteristic Curves

The data for the X and Y-axes are assigned according to the I/V characteristics specified in the Setup.

If the graph has multiple characteristic curves for different measurement conditions, the measurement conditions are displayed on the graph with the check boxes. Marking the check box displays the characteristic curve for the measurement condition. You can mark multiple check boxes for the measurement conditions.

You can change the minimum and maximum values on the X and Y-axes by clicking the value.

If a status other than normal is detected during the measurement, the status information icon appears. Clicking this icon shows the measurement status details.

b. Markers

This graph supports two kinds of markers: Domain marker and Trace marker. You can switch these markers by clicking the Marker button shown in the bottom part of the graph.



: Marker button when the Domain marker is used.



: Marker button when the Trace marker is used.

The Domain marker can read multiple characteristic values for the X-axis position.

The Domain marker supports two markers (A and B). Marker A is always available. To use the Marker B, mark the check box for the Marker B. The Marker B is a break line. To move the marker position, use the rotary knob or mouse.

The marker annotation on the graph has X-axis values for markers, and a difference value (Δ) between the Marker B and A (B-A). And, each curve annotation has Y-axis values and difference values (Δ) between the Marker B and A (B-A).

The Trace marker can read the characteristic value with tracing each characteristic curve. It is useful when you want to read the characteristic value on double sweep result.



The marker annotation on the graph has X-axis value for the marker. And, the traced curve annotation has Y-axis value.

c. Trace Representation

The curves can be represented as Line, Dot, or combination (Line & Dot). Select any trace representation using the radio buttons shown in the bottom part of the graph.

d. Reference Traces

You can register the presently-displayed curves as reference traces to compare with other measurement results on the graph. If you register them as reference traces, the reference traces are displayed as dimmed thin lines on the graph when you open other measurement data files or execute the next measurement. To register as the reference traces, click the Capture button  shown in the bottom part of the graph.

You can register a maximum of 10 reference traces. The measurement data files registered as the reference traces are listed in the References field under the Capture button . You can show or hide the reference traces using the check boxes at the head of the measurement data file names. The References field can be shown or hidden by clicking the line of the  button on top of the graph.

To remove unnecessary reference traces, select the measurement data file in the References field, and then click the Remove button .

The registration of the reference traces is cleared when you exit the I/V measurement software.

e. Auto Scale

Clicking the Auto Scale button  fits the measurement data at that time in the graph scale.

If the auto scale mode is selected by using the Scale mode button, the measurement data is automatically fit according to the progress of the measurement.

If the fixed scale mode is selected by using the Scale mode button, the scale is fixed until changing the scale manually or clicking the Auto Scale button.

 : Scale mode button during selecting the auto scale mode.

 : Scale mode button during selecting the fixed scale mode.

f. Trace Labels

The step values for the characteristic curves can be shown or hidden by clicking the Trace Label button .

In the case that multiple curves are displayed on the IV-VDS characteristic graph of MOSFET, IC-VCE characteristic graph of IGBT, and so on, the step value display is useful to identify which curve is for which step value.

g. X/Y Data

You can select the data and scale for the X and Y-axes. As default, the data for the X and Y-axes are assigned according to the I/V characteristics specified in the Setup.

The X/Y data field can be shown or hidden by clicking the line of the  button on top of the graph.

Select one from the following scales.

- Linear
Linear scale
- PositiveLog
Logarithm scale for positive data

- NegativeLog

Logarithm scale for negative data

Select data for X and Y-axes corresponding to the specified device type. The following shows data corresponding to the device type.

For MOSFET:

- VDS: Drain-source voltage
- ID: Drain current
- RDS: Drain-source resistance
- VGS: Gate-source voltage
- IG: Gate current
- IS: Forward direction current of body diode (source current)
- VSD: Forward direction voltage of body diode (source-drain voltage)
- gfs: Transconductance

For IGBT:

- VCE: Collector-emitter voltage
- IC: Collector current
- VGE: Gate-emitter voltage
- IG: Gate current
- VF: Forward direction voltage of free-wheel diode
- IF: Forward direction current of free-wheel diode
- gfs: Transconductance

For BJT:

- VCE: Collector-emitter voltage
- IC: Collector current
- VBE: Base-emitter voltage
- IB: Base current
- hFE: DC current amplification factor

For Diode:

- VF: Forward direction voltage
- IF: Forward direction current
- VR: Reverse direction voltage
- IR: Reverse direction current

For Generic2T:

- V: Voltage between terminals 2 and 3
- I: Terminal 2 current
- R: Resistance between terminals 2 and 3
- VGS: Voltage between terminals 1 and 3
- IG: Terminal 1 current
- RGS: Resistance between terminals 1 and 3

For Generic:

- VDS: Voltage between terminals 2 and 3
- ID: Terminal 2 current
- RDS: Resistance between terminals 2 and 3
- VGS: Voltage between terminals 1 and 3
- IG: Terminal 1 current
- RGS: Resistance between terminals 1 and 3
- VSD: Voltage between terminals 3 and 2
- IS: Terminal 3 current

h. Oscilloscope View

The Oscilloscope View area can be hidden or shown by clicking the column of  Oscilloscope View. For details, see “Oscilloscope View” on page 4-78.

Oscilloscope View

When the measurement is in the pulse mode operation, the Oscilloscope View can monitor both voltage and current waveforms for the measurement channels of all supported modules, at the specified measurement point on the characteristic trace. Oscilloscope View supports the following modules:

- MCSMU
- HVSMU

- HCSMU
- UHCU

To monitor the waveforms in the Oscilloscope View, you need to display this area before executing the measurement.

To display this area, clicking the column of  Oscilloscope View at the right top corner of the Characteristics area.

Figure 4-12 Oscilloscope View



a. Specifying Observation Point

To specify the observation point, use the trace marker on the left-hand characteristics graph. After measuring the specified point, the observation point on the characteristics graph is identified by a monitor marker (green frame), and the time domain waveform(s) is displayed on this area.

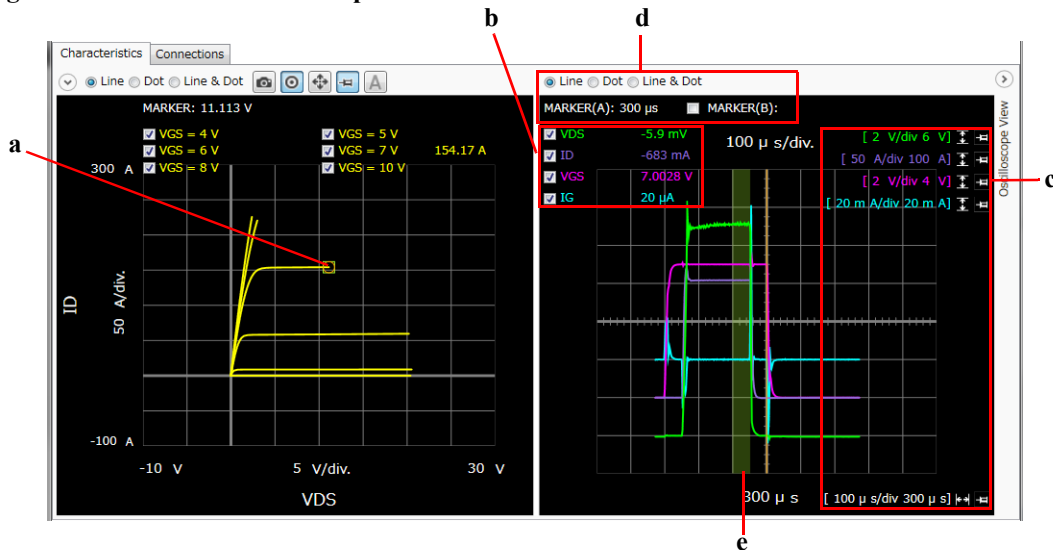
In the case of the repeat measurement, you can move the trace marker to change the observation point during the measurement. After measuring the changed point, the monitor maker moves to the point and the waveforms are updated.

b. Specifying Channel

This area can display voltage or current waveforms characteristics for multiple measurement channels. To display waveforms, mark the check boxes for the voltage or current data names of the measurement channels that you want to monitor.

c. Graph Scale and Offset

The following buttons are available for adjusting the graph scale.

 : Auto scale button for Y-axis

 : Auto scale button for X-axis

 : Scale mode button when the auto scale mode is selected

 : Scale mode button when the fixed scale mode is selected

Clicking the auto scale button fits the measurement data at that time in the graph scale.

In the auto scale mode, the measurement data is automatically fit according to the progress of the measurement.

In the fixed scale mode, the scale is fixed until changing the scale manually or clicking the auto scale button.

The string left next to the auto scale button indicates the scale resolution and the minimum value of the graph. For example, [2 V/div 0 V] means the scale resolution 2 V and the minimum value 0 V. Clicking the value allows to change the value.

d. Domain Markers and Trace Representation

On the graph, you can read values using the domain marker and change the trace representation. For details, see “b. Markers” on page 4-75, and “c. Trace Representation” on page 4-75.

e. Aperture Period

The diaphanous green zone on the graph shows the period of the Aperture value set in the General settings.

Connections

This page shows the measurement circuit that is automatically connected according to your specified measurement conditions. To display this page, click the Connections tab.

Figure 4-13

Connections

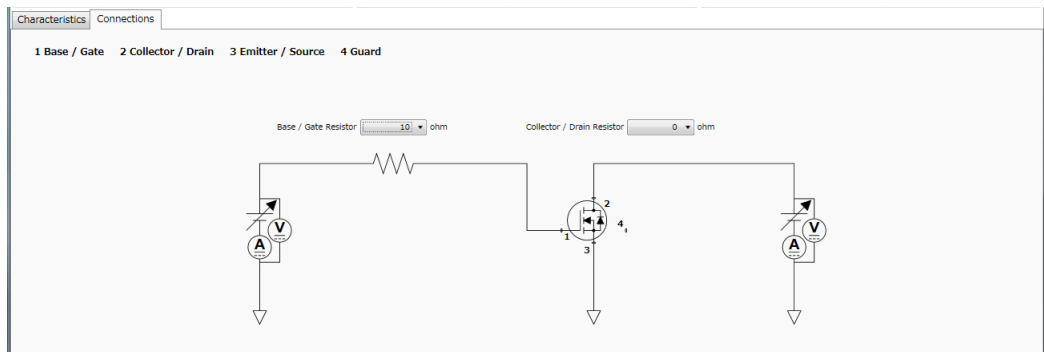

On the measurement circuit, the measurement terminals, the measurement resources, and the built-in capacitance and resistance are displayed. The following shows the relationship between the terminal numbers and the measurement terminals.

- 1: Base/Gate terminal
- 2: Collector/Drain terminal
- 3: Emitter/Source terminal
- 4: Guard terminal

NOTE

If DUT is a diode, connect the cathode terminal to 2. Collector/Drain terminal, and the anode terminal to 3. Emitter/Source terminal.

If DUT is a 2-terminal general device, connect a terminal to 2. Collector/Drain terminal, and the another terminal to 3. Emitter/Source terminal.

Base/Gate Resistor

If the MCSMU is specified to the Base/Gate terminal as the measurement resource, you can select one from the following base/gate resistances.

- 0 Ω
- 10 Ω
- 100 Ω
- 1 k Ω

The base/gate resistance is effective to restrain the oscillation of DUT that occurs during the ultra high current measurement and so on.

Collector/Drain Resistor

If the MVSMU is specified to the Collector/Drain terminal as the measurement resource, you can select one from the following collector/drain resistances.

- 0 Ω
- 100 k Ω

The collector/drain resistance is effective to restrain the over current that occurs during the breakdown measurement and so on.

Automatic Data Save

This area sets the automatic saving for the setup data and measurement data. These data are automatically saved to a new measurement data file in the specified folder at the end of the measurement.

The Data folder and Recent data fields can be shown or hidden by clicking the line of  Automatic Data Save.

Figure 4-14

Automatic Data Save

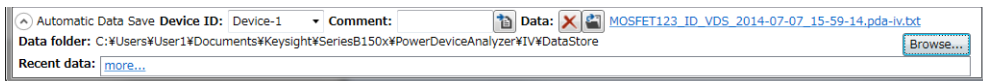

Device ID

Enter device ID string to the Device ID field. The maximum 10 recently-entered device IDs can be kept as history, and you can also select one from the history list.

The entered device ID is automatically saved to the measurement data file at the end of the measurement.

You can also change the device ID in the latest measurement data file after the measurement here. To change it, change the device ID in the Device ID field, and then click the Apply button .

Comment

Enter a comment string to the Comment field.

The entered comment is automatically saved to the measurement data file at the end of the measurement.

You can also change the comment in the latest measurement data file after the measurement here. To change it, change the comment in the Comment field, and then click the Apply button .

Data

The Data field shows the latest auto-saved or last-opened measurement data file name. You can do the following operations.

- Open the measurement data file by clicking the Open button .
- Rename the measurement data file by clicking the measurement data file name.

- Delete the measurement data file by clicking the Delete button .

Data folder Shows the absolute path of the auto-saved measurement data file. To change this, click the Browse button to open the folder selection dialog box. Select your desired folder in the dialog box.

For the initial setting of the data folder, see “Summary of Files” on page 4-88.

Recent data Shows up to 10 auto-saved measurement data files that were automatically saved recently, in the hyper-link format. Clicking the hyper-link opens the selected measurement data file. This destroys the presently-editing data.

If the number of the auto-saved measurement data files is over ten, this field shows “more...”. Clicking this opens the file selection dialog box. Select a measurement data file to open.

Toolbar

Figure 4-15

Toolbar



The toolbar has four tool button groups. The following shows the tool buttons in the tool button groups.

File tool button group



Open

Opens the Open File dialog box used to open a specified setup file or measurement data file. The present data is cleared by opening the file.



Save





Saves the present data as the same file name.





Exit



Exits the I/V measurement software. Unsaved data is destroyed.

Edit tool button group

- | | | |
|---|---------------------------|--|
|  | Cut | Moves the selected text to the clipboard. |
|  | Copy | Copies the selected text to the clipboard. |
|  | Paste | Pastes the text from the clipboard to the insertion point. |
|  | On-screen keyboard | Displays the on-screen keyboard. |

Measurement tool button group

- | | | |
|---|---------------------------|---|
|  | Start Measurement | Starts a measurement. During the measurement, the measurement status indicator on the front panel lights up. |
|  | Repeat Measurement | Starts a repeat measurement. During the measurement, the measurement status indicator on the front panel lights up.
This allows you to observe the measurement result with changing the setup.

To stop the measurement, select the Measurement > Stop menu, click the Stop Measurement button  on the toolbar, or press the Stop key on the front panel. |
|  | Stop Measurement | Stops the measurement. |

View tool button group

- | | | |
|---|----------------------|---|
|  | Go to Palette | Displays the software palette in fullscreen mode. |
|---|----------------------|---|

Main Menu

Figure 4-16

Main Menu

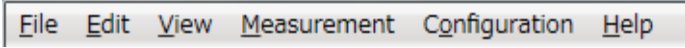

The image shows a horizontal menu bar with six items: File, Edit, View, Measurement, Configuration, and Help. Each item is underlined. The 'Measurement' and 'Configuration' items are highlighted with a grey background.

The following describes the functions of the main menu.

File Menu

Displays the following menu items to operate the setup file and measurement data file. For the file types and extensions, see “Summary of Files” on page 4-88.

- New** Clears the present data to start from initial setting.
- Open...** Opens the Open File dialog box used to open a specified setup file or measurement data file. The present data is cleared by opening the file.
- Save** Saves the present data as the same file name.
- Save Setup As...** Opens the Save Data File dialog box used to save the present setup data as the specified setup file.
- Save Data As...** Opens the Save Data File dialog box used to save the present setup data and measurement data as the specified measurement data file.

Change Device ID...

- Changes the device ID recorded in the measurement data file.
This opens the Change Device ID dialog box, and changes the device ID recorded in the selected measurement data file(s). See “Change Device ID Dialog Box” on page 4-87.

Recent Setup Files

- Lists a maximum of 10 names of the setup files that were recently edited, as menu items. You can easily open a setup file by using them.

- Exit** Exits the I/V measurement software. Unsaved data is destroyed.

Edit Menu

Displays the following menu items to edit the setup.

- Cut** Moves the selected text to the clipboard.
- Copy** Copies the selected text to the clipboard.
- Paste** Pastes the text from the clipboard to the insertion point.

On-screen keyboard... Displays the on-screen keyboard.

View Menu

Displays the following menu items for the display setting.

Go to Palette Displays the software palette in fullscreen mode.

Main Window Displays the following menu item.

Fullscreen Changes the display style of the main window.

If this is marked, the main window does not have the titlebar and is displayed in fullscreen mode.

If this is unmarked, the main window has the titlebar and is displayed in the regular window style.

This is initially marked.

Color Settings... Opens the Color Setting dialog box to set the color for parts in this software. See “Color Setting Dialog Box” on page 4-87.

Measurement Menu

Displays the following menu items for controlling the measurement.

Start Starts a measurement. During the measurement, the measurement status indicator on the front panel lights up.

Repeat Starts a repeat measurement. During the measurement, the measurement status indicator on the front panel lights up. This allows you to observe the measurement result with changing the setup.

To stop the measurement, select the Measurement > Stop menu, click the Stop Measurement button  on the toolbar, or press the Stop key on the front panel.

Stop Stops the measurement.

Configuration Menu

Displays the following menu item to administrate the configuration of the built-in modules in the mainframe and test fixture.

Module... Opens the Module Configuration dialog box. See “Module Configuration Dialog Box” on page 4-183.

Help Menu

Displays the following menu item.

About... Opens the about box. See “About Box” on page 4-88.

Dialog Boxes

Change Device ID Dialog Box

The Change Device ID dialog box is used to change the device ID in all selected measurement data files at once.

This dialog box is opened by selecting the main menu File > Change Device ID....

- | | |
|------------------------|---|
| Device ID field | Enter a new device ID. You can also select it from the history. |
| Add... button | Opens the file selection dialog box to select the measurement data file(s) that you want to change the device ID. The selected files are displayed into the list. |
| Remove button | Excludes the selected measurement data file from the list. |
| Execute button | Changes the device ID. |
| Close button | Closes this dialog box. |

Color Setting Dialog Box

The Color Setting dialog box is used to set colors of the following parts in this software. The setting in the Color Setting dialog box is saved as a user setting.

- Graph Background
- Graph Axis
- Graph Grid
- Graph Text
- Marker
- Trance

This dialog box is opened by selecting the main menu View > Color Settings....

Clicking the color pattern opens the dialog box for selecting a color.

- | | |
|---------------------|---|
| Apply button | Applies the present setting to the graph. |
| Reset button | Resets to the default setting. |
| OK button | Applies the present setting to the graph, and closes this dialog box. |

Cancel button Closes this dialog box without applying the present setting.

About Box

The about box displays the model number, the software revision number, download URL for software updating, and so on.

This dialog box is opened by selecting the main menu Help > About....

Summary of Files

The following shows the summary of the files handled by the I/V measurement software.

Table 4-20 Summary of Files

File Type	Description	Extension	Folder as Initial Setting
Setup File	This has the setup data only. You can save this using the File menu anytime.	*.pda-iv	(You can specify the folder when saving the data)
Measurement Data File	This has the setup data and measurement data including the device ID and comment. The setup data and measurement data are automatically saved to this file in the specified folder at the end of the measurement. And, you can also save this using the File menu anytime.	*.pda-iv.txt	C:\Users\ <user name="">\Documents\Keysight\SeriesB150x\PowerDeviceAnalyzer\IV\DataStore (You can change this)</user>

File name of Measurement Data File on Auto-saving

An auto-saved measurement data file is named as follows:

<DeviceID>_<TEMP>_<TIME>.pda-iv.txt

<DeviceID>: Device ID

<TEMP>: Temperature

<TIME>: Time stamp on auto-saving

Example)

Device-1_@Ch1=30degC_Ch2=30degC_2014-10-30_18-56-55.pda-iv.txt

And, the file name is decided according to the following rule.

1. <TEMP> is the characters of the available thermometer identifiers and the thermometer readings. To enable thermometers, use the Thermal Monitor/Control Software. See “Thermal Monitor/Control Software” on page 4-163.

@<thermometer>=<reading>degC

- <thermometer>: An identifier of the available thermometer
 - Ch1** Channel 1 thermometer of B1506A
 - Ch2** Channel 2 thermometer of B1506A
 - Air** Thermometer on the air outlet port of the thermostream
 - DUT** Thermometer on the DUT port of the thermostream
- <reading>: A reading value of the thermometer in degrees centigrade
If multiple thermometers are available, the temperature information is concatenated by an underscore (_). The @ is attached only at the beginning of the temperature information.

Example) @Ch1=25degC_Ch2=75degC_Air=100degC

2. <TIME> is the characters of year, month, day, hour, minute, and second. The time stamp representation depends on the time setting on Windows. And, an invalid character is replaced with an underscore (_).

Example 1) 2014-10-30_18-56-55

Example 2) 30-10-2014_6-56-55_PM

3. If the file name duplicates the existing file name, the serial number from 2 enclosed by brackets is concatenated before the file extension.

Example)

Device-1_@Ch1=30degC_Ch2=30degC_2014-10-30_18-56-55(3).pda-iv.txt

Capacitance Measurement Software

NOTE

This software is available for the B1506A-H21/H51/H71.

Capacitance measurement software provides:

- Automated measurement circuit configuration for three-terminal device capacitance measurement (e.g. C_{iss} , C_{oss} and C_{rss}), with no need to manually modify any device connections
 - With DC bias (sweep) control up to 3 kV for Collector/Drain terminal
 - With DC bias (sweep) control up to 100 V for Base/Collector terminal
- Automated correction for every measurement path
- Stable measurements even if the low-side load capacitance changes due to a bias change (load adaptive gain-phase compensation)
- Predefined templates for typical capacitance measurements of both enhancement and depletion type MOSFETs, IGBTs and Diodes

GUI Overview

The GUI (Graphical User Interface) of the capacitance measurement software is comprised of the following areas.

Figure 4-17

Capacitance Measurement Software GUI

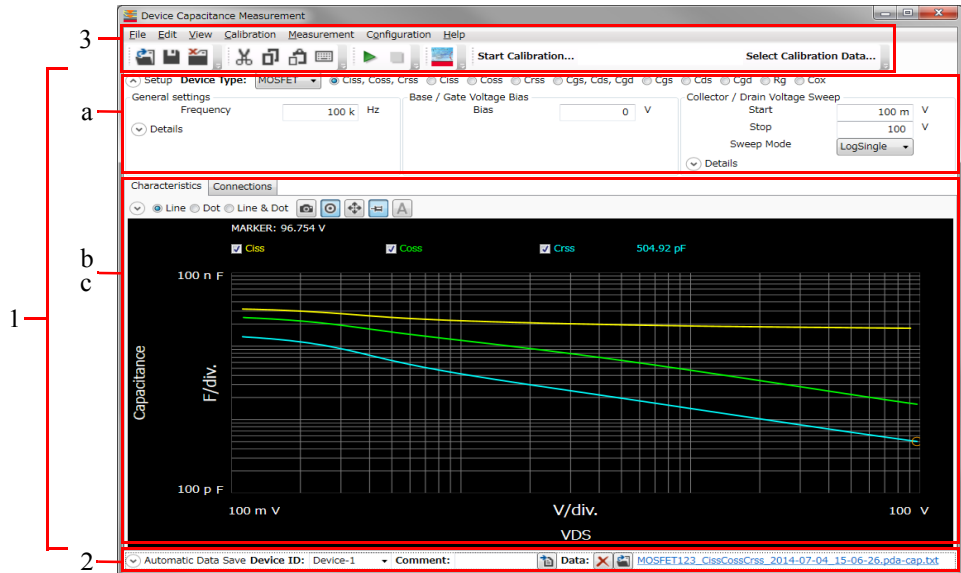

1. Work Area (See p. 4-92.)

This area provides the functions to set the measurement conditions and observe the measurement results. This is separated to the following areas.

- a. Setup (See p. 4-92.)
- b. Characteristics (See p. 4-101.)
- c. Connections (See p. 4-105.)

2. Automatic Data Save (See p. 4-108.)

This area provides the functions regarding the automatic saving of the measurement data files.

3. Operating Tools

- Toolbar (See p. 4-109.)

This provides the functions that are very frequently used in the button format.

- Main Menu (See p. 4-111.)

This provides the functions needed for various operations in the menu format.

For the dialog boxes displayed during this software operation, see “Dialog Boxes” on page 4-113.

For the files handled by this software, see “Summary of Files” on page 4-116.

Work Area

In this area, set the measurement conditions and observe the measurement results. This is separated to the following areas.

- Setup (See p. 4-92.)
- Characteristics (See p. 4-101.)
- Connections (See p. 4-105.)

Setup

This is an area to select the device type and its measured parameters, and enter your measurement conditions.

Figure 4-18

Setup

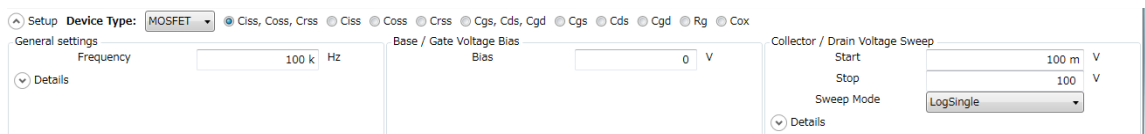

Device Type

Select the device type of your DUT from below.

- “MOSFET”
- “IGBT”
- “Diode”
- “Generic”

Select Generic to execute more general measurements for device other than above types.

MOSFET

You can select one of the following capacitance and resistance parameter measurements for “MOSFET” device type.

- Ciss, Coss, Crss
Creates new settings to measure the characteristics of the input capacitance, output capacitance, and reverse transfer capacitance for the drain-source voltage in order.
- Ciss
Creates new settings to measure the characteristics of the input capacitance for the drain-source voltage.
- Coss
Creates new settings to measure the characteristics of the output capacitance for the drain-source voltage.
- Crss
Creates new settings to measure the characteristics of the reverse transfer capacitance for the drain-source voltage.
- Cgs, Cds, Cgd
Creates new settings to measure the characteristics of the gate-source capacitance, drain-source capacitance, and gate-drain capacitance for the drain-source voltage in order.
- Cgs
Creates new settings to measure the characteristics of the gate-source capacitance for the drain-source voltage.
- Cds
Creates new settings to measure the characteristics of the drain-source capacitance for the drain-source voltage.
- Cgd
Creates new settings to measure the characteristics of the gate-drain capacitance for the drain-source voltage.
- Rg
Creates new settings to measure the characteristics of the gate resistance for the gate-source voltage.

- Cox
Creates new settings to measure the characteristics of the gate oxide capacitance for the gate-source voltage.

IGBT

You can select one of the following capacitance and resistance parameter measurements for “IGBT” device type.

- Cies, Coes, Cres
Creates new settings to measure the characteristics of the input capacitance, output capacitance, and reverse transfer capacitance for the collector-emitter voltage in order.
- Cies
Creates new settings to measure the characteristics of the input capacitance for the collector-emitter voltage.
- Coes
Creates new settings to measure the characteristics of the output capacitance for the collector-emitter voltage.
- Cres
Creates new settings to measure the characteristics of the reverse transfer capacitance for the collector-emitter voltage.
- Cge, Cce, Cgc
Creates new settings to measure the characteristics of the gate-emitter capacitance, collector-emitter capacitance, and gate-collector capacitance for the collector-emitter voltage in order.
- Cge
Creates new settings to measure the characteristics of the gate-emitter capacitance for the collector-emitter voltage.
- Cce
Creates new settings to measure the characteristics of the collector-emitter capacitance for the collector-emitter voltage.
- Cgc
Creates new settings to measure the characteristics of the gate-collector capacitance for the collector-emitter voltage.

- **Rg**
Creates new settings to measure the characteristics of the gate resistance for the gate-emitter voltage.

Diode

You can select the following capacitance parameter measurements for “Diode” device type.

- **CT**
Creates new settings to measure the characteristics of the total anode-cathode capacitance for the reverse bias voltage.

Generic

You can select one of the following measurements for “Generic” device type.

- **Sweep Voltage Between Terminal 2-3 (Collector-Emitter/Drain-Source Voltage Sweep Measurement)**
Creates new settings to measure the Cp-G model capacitance between the collector/drain and the emitter/source terminals for the swept collector-emitter or drain-source voltage.
- **Sweep Voltage Between Terminal 1-3 (Base-Emitter/Gate-Source Voltage Sweep Measurement)**
Creates new settings to measure the Cs-Rs model capacitance between the base/gate and the emitter/source terminals for the swept base-emitter or gate-source voltage.

General settings

In this area, you can set the following measurement conditions.

- **Frequency**
Specify the output frequency of the AC signal from MFCMU.
Setting range: 1 kHz to 1 MHz
- **AC Level**
Specify the output level of the AC signal from MFCMU.
Setting range: 0 to 250 mV
- **N PLC**
Specify the measurement time (integral time) in the number of power line cycle.
Setting range: 1 to 100
- **Phase Compensation**
Specify one from the following phase compensation modes.

- Auto
Uses the predefined phase compensation data.
- Adaptive
Compensates the phase at each measurement point before the measurement.
It is useful when you cannot measure in the Auto compensation mode by MFCMU oscillation.

The following parameter can be shown or hidden by clicking the line of  Details.

- AC Level
- N PLC
- Phase Compensation

Base/Gate drive settings

Specify the output settings for the base-collector or gate-source voltage. You can set them up depending on the types of the selected measurement: forcing the constant bias voltage or sweeping the bias voltage.

Base/Gate Voltage Bias:

You can specify the following parameters to force the constant bias voltage.

- Bias
Specify the bias voltage.
Setting range: -100 V to +100 V

Base/Gate Voltage Sweep:

You can specify the following parameters to sweep the bias voltage.

- Start
Specify the sweep start value.
Setting range: -100 V to +100 V
- Stop
Specify the sweep stop value.
Setting range: -100 V to +100 V
- Sweep Mode
Select one from the following sweep modes.
 - LinearSingle (Sweep from start to stop in a linear incremental step)
 - LogSingle (Sweep from start to stop in a logarithmic incremental step)

- LinearDouble (Sweep from start to stop to start in a linear incremental step)
- LogDouble (Sweep from start to stop to start in a logarithmic incremental step)

- Number of Step

Specify the number of sweep steps from start to stop.
Setting range: 1 to 1001

- Hold Time

Specify the hold time of the sweep start voltage. At the sweep start point, the start voltage is forced for more than the specified time.
Setting range: 0 to 655.35 s

- Delay Time

Specify the delay time of the measurement at each sweep step. The measurement is executed after waiting for more than the specified time at each sweep step.
Setting range: 0 to 65.535 s

- Zero Bias Time

Keeps 0 V at every terminal for more than the specified time after one sweep measurement.
Setting range: 0 to 99.9 s

In the measurement of the same capacitance parameter as shown in the following table, the characteristics results by the single measurement and the continuous measurement may have the difference depending on the bias voltage condition between the measurements. This parameter is used to cancel the dependence on the bias voltage condition in the continuous measurement.

Device Type	Continuous Measurement	Single Measurement
MOSFET	<ul style="list-style-type: none"> • Ciss, Coss, Crss 	<ul style="list-style-type: none"> • Ciss • Coss • Crss
	<ul style="list-style-type: none"> • Cgs, Cds, Cgd 	<ul style="list-style-type: none"> • Cgs • Cds • Cgd
IGBT	<ul style="list-style-type: none"> • Cies, Coes, Cres 	<ul style="list-style-type: none"> • Cies • Coes • Cres
	<ul style="list-style-type: none"> • Cge, Cce, Cgc 	<ul style="list-style-type: none"> • Cge • Cce • Cgc

The following parameter can be shown or hidden by clicking the line of  Details.

- Number of Step
- Hold Time
- Delay Time
- Zero Bias Time

Collector/Drain drive settings

Specify the output settings for the collector-emitter or drain-source voltage. You can set them up depending on the types of the selected measurement: forcing the constant bias voltage or sweeping the bias voltage.

Collector/Drain Voltage Bias:

You can specify the following parameters to force the constant bias voltage.

- Bias

Specify the bias voltage.

Setting range: -3000 V to +3000 V

Collector/Drain Voltage Sweep:

You can specify the following parameters to sweep the bias voltage.

- **Start**
Specify the sweep start value.
Setting range: -3000 V to +3000 V
- **Stop**
Specify the sweep stop value.
Setting range: -3000 V to +3000 V
- **Sweep Mode**
Select one from the following sweep modes.
 - LinearSingle (Sweep from start to stop in a linear incremental step)
 - LogSingle (Sweep from start to stop in a logarithmic incremental step)
 - LinearDouble (Sweep from start to stop to start in a linear incremental step)
 - LogDouble (Sweep from start to stop to start in a logarithmic incremental step)
- **Number of Step**
Specify the number of sweep steps from start to stop.
Setting range: 1 to 1001
- **Hold Time**
Specify the hold time of the sweep start voltage. At the sweep start point, the start voltage is forced for more than the specified time.
Setting range: 0 to 655.35 s
- **Delay Time**
Specify the delay time of the measurement at each sweep step. The measurement is executed after waiting for more than the specified time at each sweep step.
Setting range: 0 to 65.535 s
- **Zero Bias Time**
Keeps 0 V at every terminal for more than the specified time after one sweep measurement.
Setting range: 0 to 99.9 s

In the measurement of the same capacitance parameter as shown in the following table, the characteristics results by the single measurement and the continuous measurement may have the difference depending on the bias voltage condition between the measurements. This parameter is used to cancel the dependence on the bias voltage condition in the continuous measurement.

Device Type	Continuous Measurement	Single Measurement
MOSFET	<ul style="list-style-type: none"> • Ciss, Coss, Crss 	<ul style="list-style-type: none"> • Ciss • Coss • Crss
	<ul style="list-style-type: none"> • Cgs, Cds, Cgd 	<ul style="list-style-type: none"> • Cgs • Cds • Cgd
IGBT	<ul style="list-style-type: none"> • Cies, Coes, Cres 	<ul style="list-style-type: none"> • Cies • Coes • Cres
	<ul style="list-style-type: none"> • Cge, Cce, Cgc 	<ul style="list-style-type: none"> • Cge • Cce • Cgc

The following parameter can be shown or hidden by clicking the line of  Details.

- Number of Step
- Hold Time
- Delay Time
- Zero Bias Time

Characteristics

This page shows the graph of the specified parameter characteristics as the measurement result. To display this page, click the Characteristics tab.

Figure 4-19

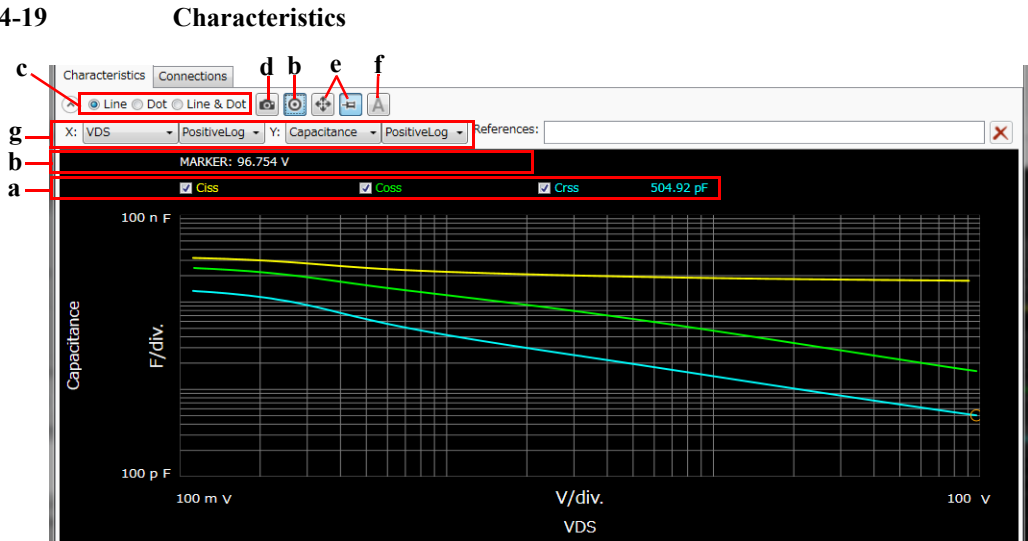

a. Displaying Characteristic Curves



The data for the X and Y-axes are assigned according to the parameter characteristics specified in the Setup.

If the graph has multiple characteristic curves for different measurement conditions, the measurement conditions are displayed on the graph with the check boxes. Marking the check box displays the characteristic curve for the measurement condition. You can mark multiple check boxes for the measurement conditions.

You can change the minimum and maximum values on the X and Y-axes by clicking the value.

b. Markers

This graph supports two kinds of markers: Domain marker and Trace marker. You can switch these markers by clicking the Marker button shown in the bottom part of the graph.

-  : Marker button when the Domain marker is used.
-  : Marker button when the Trace marker is used.

The Domain marker can read multiple characteristic values for the X-axis position.

The Domain marker supports two markers (A and B). Marker A is always available. To use the Marker B, mark the check box for the Marker B. The Marker B is a break line. To move the marker position, use the rotary knob or mouse.

The marker annotation on the graph has X-axis values for markers, and a difference value (Δ) between the Marker B and A (B–A). And, each curve annotation has Y-axis values and difference values (Δ) between the Marker B and A (B–A).

The Trace marker can read the characteristic value with tracing each characteristic curve. It is useful when you want to read the characteristic value on double sweep result.



The marker annotation on the graph has X-axis value for the marker. And, the traced curve annotation has Y-axis value.

c. Trace Representation

The curves can be represented as Line, Dot, or combination (Line & Dot). Select any trace representation using the radio buttons shown in the bottom part of the graph.

d. Reference Traces

You can register the presently-displayed curves as reference traces to compare with other measurement results on the graph. If you register them as reference traces, the reference traces are displayed as dimmed thin lines on the graph when you open other measurement data files or execute the next measurement. To register as the reference traces, click the Capture button  shown in the bottom part of the graph.

You can register a maximum of 10 reference traces. The measurement data files registered as the reference traces are listed in the References field under the Capture button . You can show or hide the reference traces using the check boxes at the head of the measurement data file names. The References field can be shown or hidden by clicking the line of the  button on top of the graph.

To remove unnecessary reference traces, select the measurement data file in the References field, and then click the Remove button .

The registration of the reference traces is cleared when you exit the capacitance measurement software.

e. Auto Scale

Clicking the Auto Scale button  fits the measurement data at that time in the graph scale.

If the auto scale mode is selected by using the Scale mode button, the measurement data is automatically fit according to the progress of the measurement.

If the fixed scale mode is selected by using the Scale mode button, the scale is fixed until changing the scale manually or clicking the Auto Scale button.

 : Scale mode button during selecting the auto scale mode.

 : Scale mode button during selecting the fixed scale mode.

f. Trace Labels

The step values for the characteristic curves can be shown or hidden by clicking the Trace Label button .

In the case that multiple curves (Ciss, Coss, and Crss of MOSFET, and so on) are displayed on the graph, the parameter name display is useful to identify which curve is for which parameter.

g. X/Y Data

You can select the data and scale for the X and Y-axes. As default, the data for the X and Y-axes are assigned according to the parameter characteristics specified in the Setup.

The X/Y data field can be shown or hidden by clicking the line of the  button on top of the graph.

Select one from the following scales.

- Linear
Linear scale
- PositiveLog
Logarithm scale for positive data
- NegativeLog
Logarithm scale for negative data

Select data for X and Y-axes. The data corresponding to the parameter specified in the Setup is represented as Capacitance, Conductance, or Resistance.

For example, in the case of the Ciss measurement, Cp is represented as Capacitance and G is represented as Conductance. In like manner, in the case of the Rs measurement, Rs is represented as Resistance and Cs is represented as Capacitance.

- Cp
Parallel capacitance on the Cp-G model
- G
Conductance on the Cp-G model
- Cs
Serial capacitance on the Cs-Rs model

GUI Reference
Capacitance Measurement Software

- R_s
Serial resistance on the Cs-Rs model
- L_s
Serial inductance on the Ls-Rs model
- L_p
Parallel inductance on the Lp-G model
- R
Resistance on the R-X (impedance) model
- X
Reactance on the R-X (impedance) model
- G
Conductance on the G-B (admittance) model
- B
Susceptance on the G-B (admittance) model
- V_{GS} (for MOSFET)/ V_{GE} (for IGBT)
Gate-source voltage or base-emitter voltage
- I_G
Gate or base current
- V_{DS} (for MOSFET)/ V_{CE} (for IGBT)
Drain-source voltage or collect-emitter voltage
- I_D (for MOSFET)/ I_C (for IGBT)
Drain or collector current

Connections

This page shows the measurement circuit that is automatically connected according to your specified measurement conditions. To display this page, click the Connections tab.

Figure 4-20 Connections

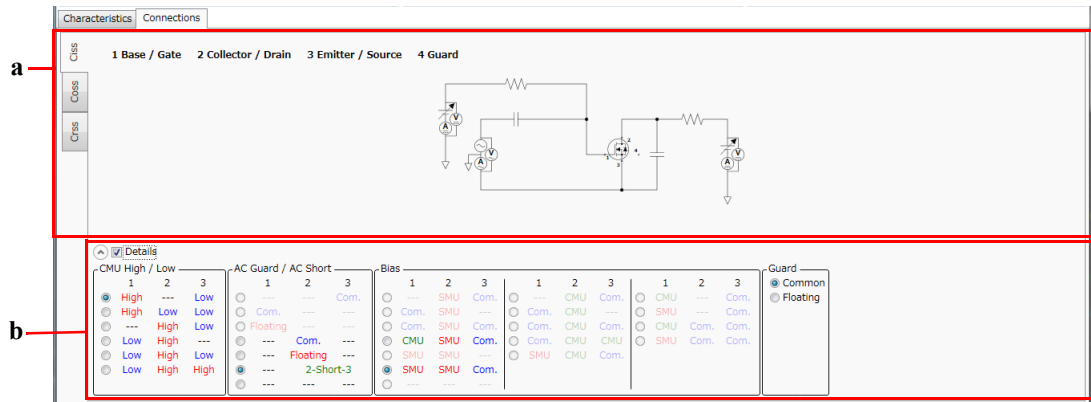

a. Measurement Circuit

On the measurement circuit, the measurement terminals, the measurement resources, and the built-in capacitance and resistance are displayed. The following shows the relationship between the terminal numbers and the measurement terminals.

- 1: Base/Gate terminal
- 2: Collector/Drain terminal
- 3: Emitter/Source terminal
- 4: Guard terminal

NOTE

If DUT is a diode, connect the cathode terminal to 2. Collector/Drain terminal, and the anode terminal to 3. Emitter/Source terminal.

In the case that the specified parameter characteristics has multiple measurements such as Ciss, Coss, and Crss measurements, the measurement circuits are respectively separated for the measurements by left-side tabs.

b. Details

This area is hidden as default. You can show this area under the measurement circuit by clicking the line of Details.

This area shows the connection status for the terminals in the table format. To edit the settings, mark the check box in this area. You can set up the connections by the combination of the following items.

- CMU High/Low

Select a combination of connections between the DUT terminals (1 to 3) and the CMU terminals (High and Low).

High Connects the DUT terminal to the High terminal of CMU.

Low Connects the DUT terminal to the Low terminal of CMU.

--- No connection

- AC Guard/AC Short

Select a combination of connections between the DUT terminals (1 to 3) and AC Guard terminal, or AC short connection between the DUT terminals 2 and 3.

Com. Connects the DUT terminal to the circuit common directly.

Floating Connects the DUT terminal to the selected bias source or the circuit common via the built-in capacitor.

2-Short-3 Shorts between DUT terminals 2 and 3 via the built-in capacitor.

--- No connection

- Bias

Select a combination of connections between the DUT terminals (1 to 3) and the DC bias source (SMU, CMU, or Common).

CMU Uses the bias source in the CMU that is connected.

SMU Connects the DUT terminal to an SMU as the bias source.

Com. Connects the DUT terminal to the circuit common.

--- No connection

- Guard

Select a connection between the DUT terminal 4 and AC Guard terminal.

Com. Connects the DUT terminal 4 to circuit common directly.

Floating Connects the DUT terminal 4 to the selected bias source or the circuit common via the built-in capacitor.

The following table shows applicable connections between the DUT terminals and the measurement resources. The rightmost column shows the potential at the DUT terminal 4 when it is connected to the AC Guard terminal in the built-in capacitor (Floating connection). In the table, the blank cell means “same as above”.

Table 4-21 Applicable Connections

CMU High/Low			AC Guard/AC Short			Bias			Guard
1	2	3	1	2	3	1	2	3	Floating
High	---	Low	---	Com.	---	CMU	Com.	Com.	AC Guard
						SMU	Com.	Com.	AC Guard
			---	Floating	---	CMU	SMU	Com.	Terminal 2
						SMU	SMU	Com.	Terminal 2
			---	2-Short-3		CMU	SMU	Com.	Terminal 2
						SMU	SMU	Com.	Terminal 2
High	Low	Low	---	---	---	CMU	Com.	Com.	AC Guard
						SMU	Com.	Com.	AC Guard
---	High	Low	Com.	---	---	Com.	SMU	Com.	AC Guard
			Floating	---	---	SMU	SMU	Com.	AC Guard
						SMU	CMU	Com.	AC Guard
Low	High	---	---	---	Com.	Com.	SMU	Com.	AC Guard
						SMU	SMU	Com.	AC Guard
						Com.	CMU	Com.	AC Guard
						SMU	CMU	Com.	AC Guard
Low	High	Low	---	---	---	Com.	SMU	Com.	AC Guard
						SMU	SMU	Com.	AC Guard
Low	High	High	---	---	---	Com.	CMU	CMU	AC Guard

Automatic Data Save

This area sets the automatic saving for the setup data and measurement data. These data are automatically saved to a new measurement data file in the specified folder at the end of the measurement.

The Data folder and Recent data fields can be shown or hidden by clicking the line of  Automatic Data Save.

Figure 4-21

Automatic Data Save

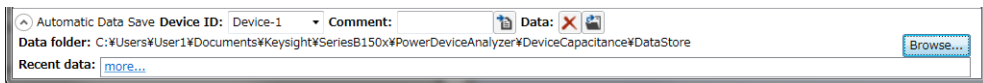

Device ID

Enter device ID string to the Device ID field. The maximum 10 recently-entered device IDs can be kept as history, and you can also select one from the history list.

The entered device ID is automatically saved to the measurement data file at the end of the measurement.

You can also change the device ID in the latest measurement data file after the measurement here. To change it, change the device ID in the Device ID field, and then click the Apply button .

Comment



Enter a comment string to the Comment field.

The entered comment is automatically saved to the measurement data file at the end of the measurement.

You can also change the comment in the latest measurement data file after the measurement here. To change it, change the comment in the Comment field, and then click the Apply button .

Data

The Data field shows the latest auto-saved or last-opened measurement data file name. You can do the following operations.

- Open the measurement data file by clicking the Open button .
- Rename the measurement data file by clicking the measurement data file name.
- Delete the measurement data file by clicking the Delete button .

- Data folder** Shows the absolute path of the auto-saved measurement data file. To change this, click the Browse button to open the folder selection dialog box. Select your desired folder in the dialog box.
- For the initial setting of the data folder, see “Summary of Files” on page 4-116.
- Recent data** Shows up to 10 auto-saved measurement data files that were automatically saved recently, in the hyper-link format. Clicking the hyper-link opens the selected measurement data file. This destroys the presently-editing data.
- If the number of the auto-saved measurement data files is over ten, this field shows “more...”. Clicking this opens the file selection dialog box. Select a measurement data file to open.

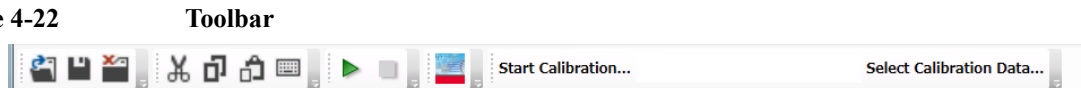

Toolbar

Figure 4-22







The toolbar has five tool button groups. The following shows the tool buttons in the tool button groups.

File tool button group

-  **Open** Opens the Open File dialog box used to open a specified setup file or measurement data file. The present data is cleared by opening the file.
-  **Save** Saves the present data as the same file name.
-  **Exit** Exits the capacitance measurement software. Unsaved data is destroyed.



Edit tool button group

-  **Cut** Moves the selected text to the clipboard.

- | | | |
|---|---------------------------|--|
|  | Copy | Copies the selected text to the clipboard. |
|  | Paste | Pastes the text from the clipboard to the insertion point. |
|  | On-screen keyboard | Displays the on-screen keyboard. |

Measurement tool button group

- | | | |
|---|--------------------------|--|
|  | Start Measurement | Starts a measurement. During the measurement, the measurement status indicator on the front panel lights up.

To stop the measurement, select the Measurement > Stop menu, click the Stop Measurement button  on the toolbar, or press the Stop key on the front panel. |
|  | Stop Measurement | Stops the measurement. |

View tool button group

- | | | |
|---|----------------------|---|
|  | Go to Palette | Displays the software palette in fullscreen mode. |
|---|----------------------|---|

Calibration tool button group

- | | |
|-----------------------------------|--|
| Start Calibration... | Opens the Calibration dialog box to get the calibration data. See “Calibration Dialog Box” on page 4-114. |
| Select Calibration Data... | Opens a dialog box for the file selection, and then applies the selected calibration data file to the measurement. |

Main Menu

Figure 4-23

Main Menu

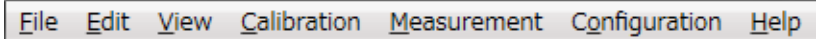

The following describes the functions of the main menu.

File Menu

Displays the following menu items to operate the setup file and measurement data file. For the file types and extensions, see “Summary of Files” on page 4-116.

- New** Clears the present data to start from initial setting.
- Open...** Opens the Open File dialog box used to open a specified setup file or measurement data file. The present data is cleared by opening the file.
- Save** Saves the present data as the same file name.
- Save Setup As...** Opens the Save Data File dialog box used to save the present setup data as the specified setup file.
- Save Data As...** Opens the Save Data File dialog box used to save the present setup data and measurement data as the specified measurement data file.

Change Device ID...

Changes the device ID recorded in the measurement data file.
This opens the Change Device ID dialog box, and changes the device ID recorded in the selected measurement data file(s). See “Change Device ID Dialog Box” on page 4-113.

Recent Setup Files

Lists a maximum of 10 names of the setup files that were recently edited, as menu items. You can easily open a setup file by using them.

- Exit** Exits the capacitance measurement software. Unsaved data is destroyed.

Edit Menu

Displays the following menu items to edit the setup.

- Cut** Moves the selected text to the clipboard.
- Copy** Copies the selected text to the clipboard.
- Paste** Pastes the text from the clipboard to the insertion point.

On-screen keyboard... Displays the on-screen keyboard.

View Menu

Displays the following menu items for the display setting.

Go to Palette Displays the software palette in fullscreen mode.

Main Window Displays the following menu item.

Fullscreen Changes the display style of the main window.

If this is marked, the main window does not have the titlebar and is displayed in fullscreen mode.

If this is unmarked, the main window has the titlebar and is displayed in the regular window style.

This is initially marked.

Color Settings... Opens the Color Setting dialog box to set the color for parts in this software. See “Color Setting Dialog Box” on page 4-114.

Calibration Menu

Displays the following menu items for the calibration.

Start Opens the Calibration dialog box to get the calibration data. See “Calibration Dialog Box” on page 4-114.

Select Data Opens a dialog box for the file selection, and then applies the selected calibration data file to the measurement.

Load Factory

Default Applies the factory default calibration data file to the measurement.

Measurement Menu

Displays the following menu items for controlling the measurement.

Start Starts a measurement. During the measurement, the measurement status indicator on the front panel lights up.

To stop the measurement, select the Measurement > Stop menu, click the Stop Measurement button  on the toolbar, or press the Stop key on the front panel.

Stop Stops the measurement.

Configuration Menu

Displays the following menu item to administrate the configuration of the built-in modules in the mainframe and test fixture.

Module... Opens the Module Configuration dialog box. See “Module Configuration Dialog Box” on page 4-183.

Help Menu

Displays the following menu item.

About... Opens the about box. See “About Box” on page 4-115.

Dialog Boxes

Change Device ID Dialog Box

The Change Device ID dialog box is used to change the device ID in all selected measurement data files at once.

This dialog box is opened by selecting the main menu File > Change Device ID....

- Device ID field** Enter a new device ID. You can also select it from the history.
- Add... button** Opens the file selection dialog box to select the measurement data file(s) that you want to change the device ID. The selected files are displayed into the list.
- Remove button** Excludes the selected measurement data file from the list.
- Execute button** Changes the device ID.
- Close button** Closes this dialog box.

Color Setting Dialog Box

The Color Setting dialog box is used to set colors of the following parts in this software. The setting in the Color Setting dialog box is saved as a user setting.

- Graph Background
- Graph Axis
- Graph Grid
- Graph Text
- Marker
- Trace
 - First
 - Second
 - Third

This dialog box is opened by selecting the main menu View > Color Settings....

Clicking the color pattern opens the dialog box for selecting a color.

- | | |
|----------------------|---|
| Apply button | Applies the present setting to the graph. |
| Reset button | Resets to the default setting. |
| OK button | Applies the present setting to the graph, and closes this dialog box. |
| Cancel button | Closes this dialog box without applying the present setting. |

Calibration Dialog Box

The Calibration dialog box is used to acquire the calibration data regarding the leakage conductance, parasitic capacitance, residual resistance, and inductance on the signal paths, and apply it to the measurement.

If you change the signal paths to DUT, you need to acquire the calibration data for the new paths.

The calibration data supports the situation that the signal paths in the test fixture are automatically switched.

This dialog box is opened by selecting the main menu Calibration > Start.

Full Path Calibration Measurement

Select to acquire the calibration data for all available signal paths.

Minimum Path Calibration Measurement

Select to acquire the calibration data for the signal paths used in the present setup.

For signal paths except for them, the factory default calibration data is applied.

Start button

Starts to acquire the calibration data. Open or short the capacitance measurement circuit according to instructions of the wizard.

Save and Apply button

Saves the acquired calibration data to a file, and applies it to the measurement.

Cancel button

Destroys the acquired calibration data and closes this dialog box.

About Box

The about box displays the model number, the software revision number, download URL for software updating, and so on.

This dialog box is opened by selecting the main menu Help > About....

Summary of Files

The following shows the summary of the files handled by the capacitance measurement software.

Table 4-22 Summary of Files

File Type	Description	Extension	Folder as Initial Setting
Setup File	This has the setup data only. You can save this using the File menu anytime.	*.pda-cap	(You can specify the folder when saving the data)
Measurement Data File	This has the setup data and measurement data including the device ID and comment. The setup data and measurement data are automatically saved to this file in the specified folder at the end of the measurement. And, you can also save this using the File menu anytime.	*.pda-cap.txt	C:\Users\ <user name="">\Documents\Keysight\SeriesB150x\PowerDevice Analyzer\DeviceCapacitance\DataStore (You can change this)</user>
Calibration Data File	Calibration data This is automatically saved after the calibration execution.	*.pda-cap.cal	C:\ProgramData\Keysight\SeriesB150x\PowerDevice Analyzer\DeviceCapacitance\UserCalibrationData
	Factory Default Calibration data This is used when there is no user calibration data.		C:\ProgramData\Keysight\SeriesB150x\PowerDevice Analyzer\DeviceCapacitance\CalibrationData

File name of Measurement Data File on Auto-saving

An auto-saved measurement data file is named as follows:

<DeviceID>_<TEMP>_<TIME>.pda-cap.txt

<DeviceID>: Device ID

<TEMP>: Temperature

<TIME>: Time stamp on auto-saving

Example)

Device-1_@Ch1=30degC_Ch2=30degC_2014-10-30_18-56-55.pda-cap.txt

And, the file name is decided according to the following rule.

1. <TEMP> is the characters of the available thermometer identifiers and the thermometer readings. To enable thermometers, use the Thermal Monitor/Control Software. See “Thermal Monitor/Control Software” on page 4-163.

@<thermometer>=<reading>degC

- <thermometer>: An identifier of the available thermometer
 - Ch1** Channel 1 thermometer of B1506A
 - Ch2** Channel 2 thermometer of B1506A
 - Air** Thermometer on the air outlet port of the thermostream
 - DUT** Thermometer on the DUT port of the thermostream
- <reading>: A reading value of the thermometer in degrees centigrade
If multiple thermometers are available, the temperature information is concatenated by an underscore (_). The @ is attached only at the beginning of the temperature information.

Example) @Ch1=25degC_Ch2=75degC_Air=100degC

2. <TIME> is the characters of year, month, day, hour, minute, and second. The time stamp representation depends on the time setting on Windows. And, an invalid character is replaced with an underscore (_).

Example 1) 2014-10-30_18-56-55

Example 2) 30-10-2014_6-56-55_PM

3. If the file name duplicates the existing file name, the serial number from 2 enclosed by brackets is concatenated before the file extension.

Example)

Device-1_@Ch1=30degC_Ch2=30degC_2014-10-30_18-56-55(3).pda-cap.txt

Gate Charge Measurement Software

NOTE

This software is available for the B1506A-H21/H51/H71.

Gate charge measurement Software provides:

- Support for both constant current load mode and resistive load mode
- Correction of parasitic capacitance and residual resistance in the gate path
- Monitoring of gate and drain/collector voltage/ and current waveforms during the DUT turn-on period phase
- JESD24-2 compliant Qg curve, line fitting and parameter extraction

GUI Overview

The GUI (Graphical User Interface) of the gate charge measurement software is comprised of the following areas.

Figure 4-24

Gate Charge Measurement Software GUI

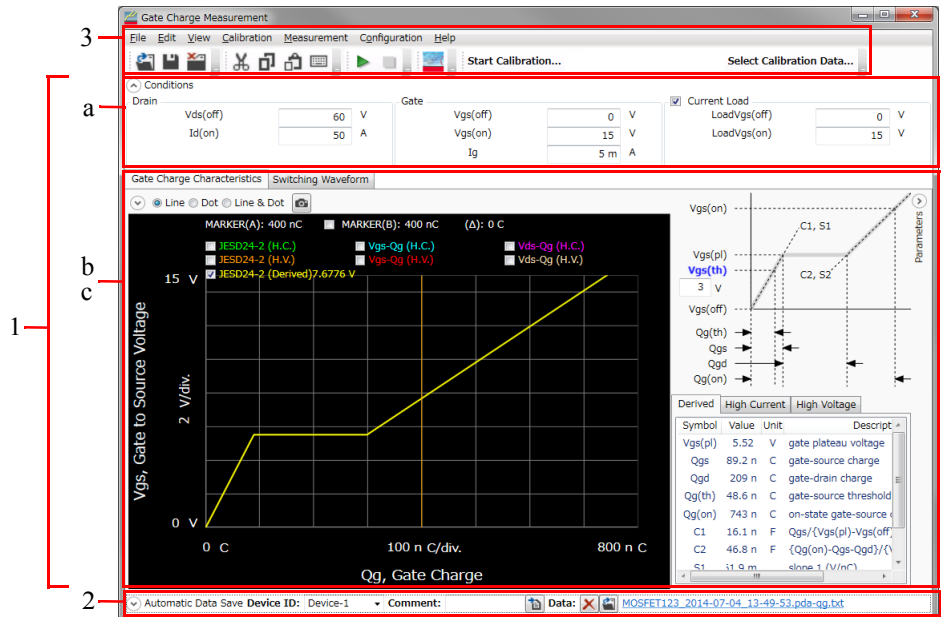

1. Work Area (See p. 4-120.)

This area provides the functions to set the measurement conditions and observe the measurement results. This is separated to the following areas.

- a. Conditions (See p. 4-120.)
- b. Gate Charge Characteristics (See p. 4-123.)
- c. Switching Waveform (See p. 4-127.)

2. Automatic Data Save (See p. 4-132.)

This area provides the functions regarding the automatic saving of the measurement data files.

3. Operating Tools

- Toolbar (See p. 4-133.)

This provides the functions that are very frequently used in the button format.

- Main Menu (See p. 4-135.)

This provides the functions needed for various operations in the menu format.

For the dialog boxes displayed during this software operation, see “Dialog Boxes” on page 4-137.

For the files handled by this software, see “Summary of Files” on page 4-140.

Work Area

In this area, set the measurement conditions and observe the measurement results. This is separated to the following areas.

- Conditions (See p. 4-120.)
- Gate Charge Characteristics (See p. 4-123.)
- Switching Waveform (See p. 4-127.)

Conditions

This is an area to enter your measurement conditions. For the setting range of the condition parameters, see Table 4-23 on page 4-122.

This area can be hidden or shown by clicking the line of  Conditions.

Figure 4-25

Conditions



Section	Parameter	Value	Unit
Drain	Vds(off)	60	V
	Id(on)	200	A
Gate	Vgs(off)	0	V
	Vgs(on)	15	V
	Ig	5 m	A
Current Load (checked)	LoadVgs(off)	0	V
	LoadVgs(on)	15	V

Drain

Set the conditions for driving the drain of DUT.

Vds(off) Enter a value of the drain-source voltage at the off-state.

Id(on) Enter a value of the drain current at the on-state when the constant current load is used.

When the constant current load is not used, the on-state current is decided by the off-state voltage, resistance of the resistive load, and the on-state resistance/saturation voltage. For the current output range of the power supply, the minimum range including $I_{d(on)}$ is automatically selected.

Gate

Set the conditions for driving the gate of DUT.

- Vgs(off)** Enter a value of the gate-source voltage to change the DUT to the off-state.
- Vgs(on)** Enter a value of the gate-source voltage to completely change the DUT to the on-state.
- Ig** Enter a limit value of the gate current. This value impacts on the switching time. Large I_g shortens the switching time, and small I_g elongates it.

Current Load

Mark the check box when you want to use the constant current load.

Set the conditions for driving the gate of the transistor for the constant current load, that is the source of the on-state current described in “Drain” on page 4-120.

When you use the resistive load (not use the constant current load), unmark the check box to disable the constant current load.

- LoadVgs(off)** Enter a value of the gate-source voltage to change the transistor for the constant current load to the off-state.
- LoadVgs(on)** Enter a value of the gate-source voltage to completely change the transistor for the constant current load to the on-state.

Before the gate charge measurement, DUT is completely changed to the on-state. During this situation, the gate-drain voltage of the transistor is searched from $V_{gs(off)}$ to $V_{gs(on)}$ so that the specified on-state current $I_{d(on)}$ flows. The transistor is driven by the searched gate-source voltage, and then the gate charge measurement is executed. Where, “DUT is completely changed to the on-state” means the state that the gate-source voltage of the DUT is set to the $V_{gs(on)}$ entered for the gate drive condition.

Table 4-23

Setting Range for Parameters

Setting Parameter	Setting Range		
	B1506A-H21	B1506A-H51	B1506A-H71
Vds(off) @High Voltage	0 V to +3000 V		
Vds(off) @High Current	-40 V to +40 V	-60 V to +60 V	
Id(on) max.	20 A	450 A	1100 A
Vgs(off)	-30 V to +30 V		
Vgs(on)	-30 V to +30 V		
Ig	1 μ A to 1 A		
LoadVgs(off)	-30 V to +30 V		
LoadVgs(on)	-30 V to +30 V		

Gate Charge Characteristics

This page shows the graph and extracted parameters of the gate charge characteristics as the measurement results. To display this page, click the Gate Charge Characteristics tab.

Figure 4-26 Gate Charge Characteristics



a. Displaying Characteristic Curves

This area can display multiple characteristics curves as shown in the following list. To display curves, mark the check boxes for the characteristics curves you want to display.

- JESD24-2 (Derived)

Shows the gate charge characteristics when the off-state voltage and the on-state current specified in “Drain” are applied.

- Vgs-Qg (H.C.)

Shows the gate charge characteristics when the on-state current specified in “Drain” is applied.

When the constant current load is not used, the on-state current is decided by the off-state voltage, resistance of the resistive load, on-state resistance, and the output voltage of UHCU/HCSMU.

- Vgs-Qg (H.V.)

Shows the gate charge characteristics when the off-state voltage specified in “Drain” is applied.

- JESD24-2 (H.C.)

Shows an approximation straight line of V_{gs} - Q_g (H.C.) gate charge characteristics. The approximation is calculated on sloops (S_1 , S_2 , and S_3) defined in JEDEC Standard JESD24-2.

- JESD24-2 (H.V.)

Shows an approximation straight line of V_{gs} - Q_g (H.V.) gate charge characteristics. The approximation is calculated on sloops (S_1 , S_2 , and S_3) defined in JEDEC Standard JESD24-2.

- V_{ds} - Q_g (H.C.)

Shows the relationship between the drain-source voltage and gate charge when the V_{gs} - Q_g (H.C.) is measured.

For HCSMU, the drain-source voltage is a voltage between the drain of the constant current load transistor and the source of DUT.

- V_{ds} - Q_g (H.V.)

Shows the relationship between the drain-source voltage and gate charge when the V_{gs} - Q_g (H.V.) is measured.

- I_d - Q_g (H.C.)

Shows the relationship between the drain current and gate charge when the V_{gs} - Q_g (H.C.) is measured.

- I_d - Q_g (H.V.)

Shows the relationship between the drain current and gate charge when the V_{gs} - Q_g (H.V.) is measured.

b. Adjusting Scale The following buttons are available for adjusting the graph scale.

 : Auto scale button for Y-axis

 : Auto scale button for X-axis

 : Scale mode button when the auto scale mode is selected

 : Scale mode button when the fixed scale mode is selected

Clicking the auto scale button fits the measurement data at that time in the graph scale.

In the auto scale mode, the measurement data is automatically fit according to the progress of the measurement.

In the fixed scale mode, the scale is fixed until changing the scale manually or clicking the auto scale button.

The string left next to the auto scale button indicates the scale resolution and the minimum value of the graph. For example, [2 V/div 0 V] means the scale resolution 2 V and the minimum value 0 V. Clicking the value allows to change the value.

c. Markers

This graph supports two markers (A and B). Marker A is always available. To use the Marker B, mark the check box for the Marker B. The Marker B is a break line. To move the marker position, use the rotary knob or mouse.



The marker annotation on the graph has X-axis values for markers, and a difference value (Δ) between the Marker B and A (B–A). And, each curve annotation has Y-axis values and difference values (Δ) between the Marker B and A (B–A).

d. Trace Representation

The curves can be represented as Line, Dot, or combination (Line & Dot). Select any trace representation using the radio buttons shown in the bottom part of the graph.

e. Reference Traces

You can register the presently-displayed curves as reference traces to compare with other measurement results on the graph. If you register them as reference traces, the reference traces are displayed as dimmed thin lines on the graph when you open other measurement data files or execute the next measurement. To register as the reference traces, click the Capture button  shown in the bottom part of the graph.

You can register a maximum of 10 reference traces. The measurement data files registered as the reference traces are listed in the References field under the Capture button . You can show or hide the reference traces using the check boxes at the head of the measurement data file names. The References field can be hidden or shown by clicking the line of the  button on top of the graph.

To remove unnecessary reference traces, select the measurement data file in the References field, and then click the Remove button .

The registration of the reference traces is cleared when you exit the gate charge measurement software.

f. Parameters

To extract and show the gate charge parameter values according to JESD24-2 (Derived), JESD24-2 (H.C.), and JESD24-2 (H.V.) in this area, enter the threshold voltage $V_{gs(th)}$ of the DUT. You can change the display contents by clicking the tabs.

$V_{gs(pl)}$ Gate plateau voltage

Qgs	Gate-source charge Gate charge for slope S_1 according to JEDEC Standard JESD24-2
Qgd	Gate-drain charge Gate charge for slope S_3 according to JEDEC Standard JESD24-2
Qg(th)	Gate-source threshold charge Gate charge from $V_{gs(off)}$ to $V_{gs(th)}$
Qg(on)	On-state gate-source charge Gate charge from $V_{gs(off)}$ to $V_{gs(on)}$
C1	$Q_{gs}/\{V_{gs(pl)}-V_{gs(off)}\}$ Equivalent capacitance for S_1 in JESD24-2
C2	$\{Q_{g(on)}-Q_{gs}-Q_{gd}\}/\{V_{gs(on)}-V_{gs(pl)}\}$ Equivalent capacitance for S_2 in JESD24-2
S1	S_1 in JESD24-2
S2	S_2 in JESD24-2

This area can be hidden or shown by clicking the column of  Parameters at the right side of the window.

Switching Waveform

This page shows the switching waveforms of DUT to observe the switching behavior. And, you can also set detailed parameters before the measurement. To display this page, click the Switching Waveform tab.

The gate charge characteristics is calculated from the gate current and waveform data of the gate-source voltage obtained from the switching, and the calibration data.

There are the following switching modes.

- “High Current Switching Mode”

UHCU or HCSMU is used as a power supply to force the on-state current specified in “Drain” to DUT via the constant current load specified in “Current Load”.

And, the applied voltage is determined as follows, depending on the off-state voltage specified in “Drain”.

- If the off-state voltage is within the output voltage range of UHCU/HCSMU, they force the specified voltage. The maximum output voltage of UHCU is 60 V and it of HCSMU is 20 V at 20 A range.
- If the off-state voltage exceeds the output voltage range of UHCU/HCSMU, UHCU forces 60 V and HCSMU forces 20 V.

If you don't use the constant current load, the applied current is determined from the load resistance, on-state resistance of DUT, and the output voltage of the power supply.

- “High Voltage Switching Mode”

HVSMU is used as a power supply to force the off-state voltage specified in “Drain” to DUT.

This page has the graph area to display the time-domain switching waveforms and the advanced setup area to set the detailed parameters for the measurement in the above modes. To switch the mode, click the tab (High Current or High Voltage) on the left side.

High Current Switching Mode

Figure 4-27 Switching Waveform (High Current Switching Mode)

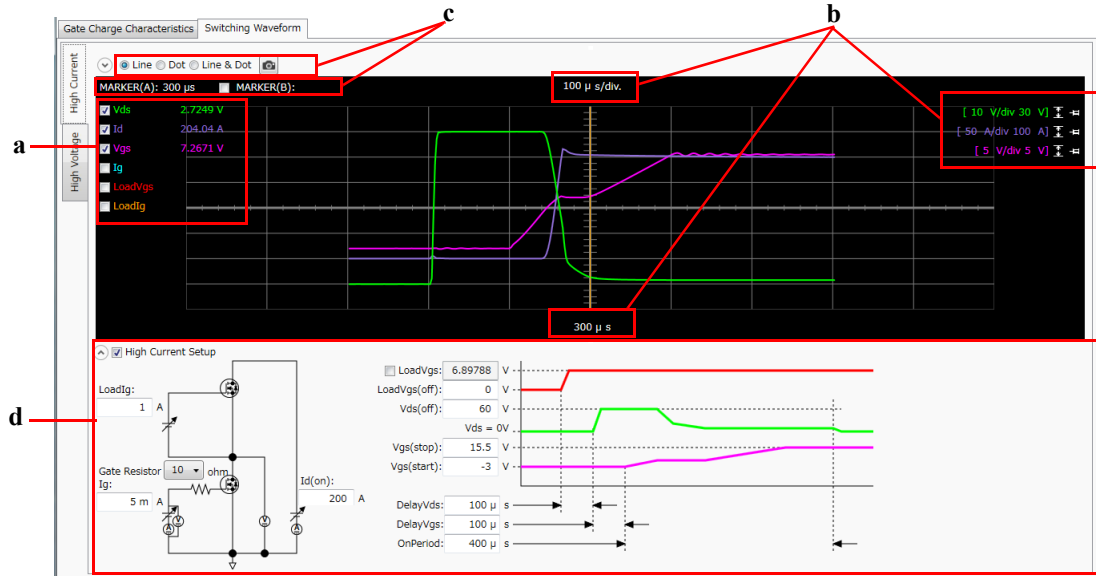

a. Displaying Characteristic Curves

This area can display the following switching waveforms in the high current switching mode. To display switching waveform(s), mark the check boxes for the waveforms.

- Vds: Drain-source voltage waveform
- Id: Drain current waveform
- Vgs: Gate-source voltage waveform
- Ig: Gate current waveform
- LoadVgs: Gate-source voltage waveform of the current load
- LoadIg: Gate current waveform of the current load

b. Adjusting Scale

The following buttons are available for adjusting the graph scale.

: Auto scale button for Y-axis

: Auto scale button for X-axis

: Scale mode button when the auto scale mode is selected

: Scale mode button when the fixed scale mode is selected

Clicking the auto scale button fits the measurement data at that time in the graph scale.

In the auto scale mode, the measurement data is automatically fit according to the progress of the measurement.

In the fixed scale mode, the scale is fixed until changing the scale manually or clicking the auto scale button.

The string left next to the auto scale button indicates the scale resolution and the minimum value of the graph. For example, [2 V/div 0 V] means the scale resolution 2 V and the minimum value 0 V. Clicking the value allows to change the value.

c. Other Graph Functions

On the graph, you can read values using the markers, change the trace representation, and use the reference traces. For details, see “c. Markers” on page 4-125, “d. Trace Representation” on page 4-125, and “e. Reference Traces” on page 4-125.

d. Advanced Setup

This area is hidden as default. You can show this area under the graph area by clicking the line of  High Current Setup.

This area shows the setup items on the measurement circuit and timing chart. To edit the setting values, mark the check box of the High Current Setup.

LoadIg	Gate current limit for Current Load
Ig	Gate current limit for DUT
Gate Resistor	Gate resistance for DUT (Same value is used between the both switching modes.)
Id(on)	On-state drain current
LoadVgs	Gate to-source voltage for Current Load adjusted to Id(on) By marking the check box, you can overwrite the gate-source voltage of the current load that was adjusted according to the Id(on).
LoadVgs(off)	Off-state gate-source voltage for Current Load
Vds(off)	Off-state drain-source voltage
Vgs(stop)	Stop value for Vgs
Vgs(start)	Start value for Vgs
DelayVds	Delay time from Current Load gating to off-state drain-source voltage application

DelayVgs Delay time from off-state drain-source voltage application to start of Vgs swing

OnPeriod Period from start of Vgs swing to Vds zero

High Voltage Switching Mode

Figure 4-28 Switching Waveform (High Voltage Switching Mode)

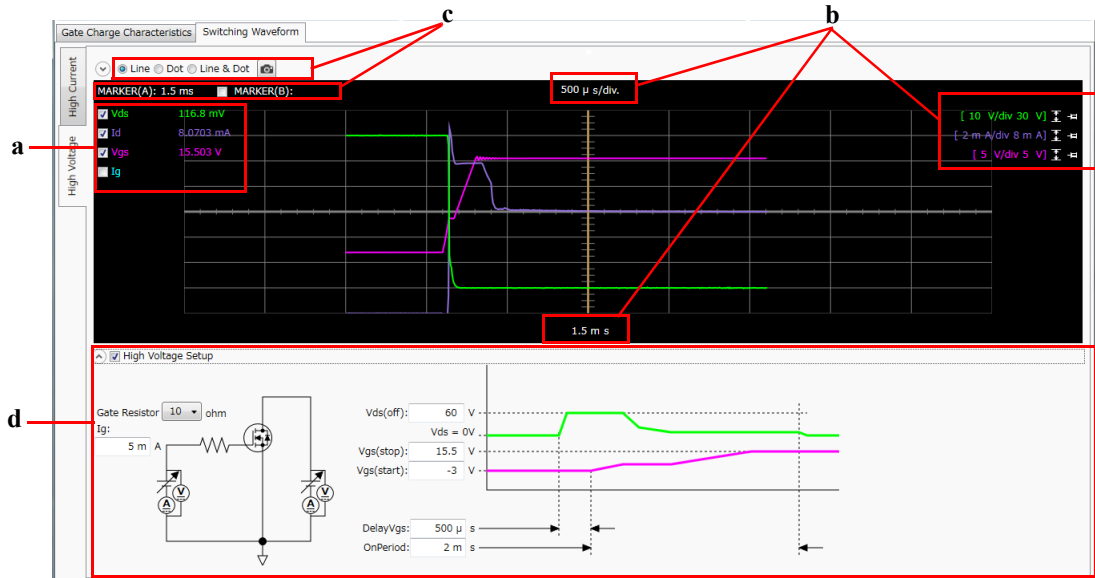

a. Displaying Characteristic Curves

This area can display the following switching waveforms in the high voltage switching mode. To display switching waveform(s), mark the check boxes for the waveforms.

- Vds: Drain-source voltage waveform
- Id: Drain current waveform
- Vgs: Gate-source voltage waveform
- Ig: Gate current waveform

b. Adjusting Scale The following buttons are available for adjusting the graph scale.



: Auto scale button for Y-axis



: Auto scale button for X-axis



: Scale mode button when the auto scale mode is selected



: Scale mode button when the fixed scale mode is selected

Clicking the auto scale button fits the measurement data at that time in the graph scale.

In the auto scale mode, the measurement data is automatically fit according to the progress of the measurement.

In the fixed scale mode, the scale is fixed until changing the scale manually or clicking the auto scale button.

The string left next to the auto scale button indicates the scale resolution and the minimum value of the graph. For example, [2 V/div 0 V] means the scale resolution 2 V and the minimum value 0 V. Clicking the value allows to change the value.

c. Other Graph Functions

On the graph, you can read values using the markers, change the trace representation, and use the reference traces. For details, see “c. Markers” on page 4-125, “d. Trace Representation” on page 4-125, and “e. Reference Traces” on page 4-125.

d. Advanced Setup This area is hidden as default. You can show this area under the graph area by clicking the line of High Voltage Setup.

This area shows the setup items on the measurement circuit and timing chart. To edit the setting values, mark the check box of the High Voltage Setup.

Ig	Gate current limit for DUT
Gate Resistor	Gate resistance for DUT (Same value is used between both switching modes.)
Vds(off)	Off-state drain-source voltage
Vgs(stop)	Stop value for Vgs
Vgs(start)	Start value for Vgs
DelayVgs	Delay time from off-state drain-source voltage application to start of Vgs swing
OnPeriod	Period from start of Vgs swing to Vds zero

Automatic Data Save

This area sets the automatic saving for the setup data and measurement data. These data are automatically saved to a new measurement data file in the specified folder at the end of the measurement.

The Data folder and Recent data fields can be shown or hidden by clicking the line of  Automatic Data Save.

Figure 4-29

Automatic Data Save

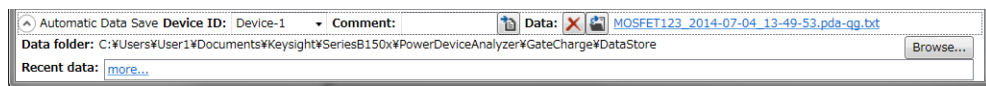

Device ID Enter device ID string to the Device ID field. The maximum 10 recently-entered device IDs can be kept as history, and you can also select one from the history list.

The entered device ID is automatically saved to the measurement data file at the end of the measurement.



You can also change the device ID in the latest measurement data file after the measurement here. To change it, change the device ID in the Device ID field, and then click the Apply button .

Comment Enter a comment string to the Comment field.

The entered comment is automatically saved to the measurement data file at the end of the measurement.

You can also change the comment in the latest measurement data file after the measurement here. To change it, change the comment in the Comment field, and then click the Apply button .

Data The Data field shows the latest auto-saved or last-opened measurement data file name. You can do the following operations.

- Open the measurement data file by clicking the Open button .
- Rename the measurement data file by clicking the measurement data file name.
- Delete the measurement data file by clicking the Delete button .

- Data folder** Shows the absolute path of the auto-saved measurement data file. To change this, click the Browse button to open the folder selection dialog box. Select your desired folder in the dialog box.
- For the initial setting of the data folder, see “Summary of Files” on page 4-140.
- Recent data** Shows up to 10 auto-saved measurement data files that were automatically saved recently, in the hyper-link format. Clicking the hyper-link opens the selected measurement data file. This destroys the presently-editing data.
- If the number of the auto-saved measurement data files is over ten, this field shows “more...”. Clicking this opens the file selection dialog box. Select a measurement data file to open.



Toolbar

Figure 4-30







The toolbar has five tool button groups. The following shows the tool buttons in the tool button groups.

File tool button group

-  **Open** Opens the Open File dialog box used to open a specified setup file or measurement data file. The present data is cleared by opening the file.
-  **Save** Saves the present data as the same file name.
-  **Exit** Exits the gate charge measurement software. Unsaved data is destroyed.



Edit tool button group

-  **Cut** Moves the selected text to the clipboard.

- | | | |
|---|---------------------------|--|
|  | Copy | Copies the selected text to the clipboard. |
|  | Paste | Pastes the text from the clipboard to the insertion point. |
|  | On-screen keyboard | Displays the on-screen keyboard. |

Measurement tool button group

- | | | |
|---|--------------------------|---|
|  | Start Measurement | Starts a measurement. During the measurement, the measurement status indicator on the front panel lights up.

To stop the repeat measurement, select the Measurement > Stop menu, click the Stop Measurement button  on the toolbar, or press the Stop key on the front panel. |
|  | Stop Measurement | Stops the measurement. |

View tool button group

- | | | |
|---|----------------------|---|
|  | Go to Palette | Displays the software palette in fullscreen mode. |
|---|----------------------|---|

Calibration tool button group

- | | |
|-----------------------------------|--|
| Start Calibration... | Opens the Calibration dialog box to get the calibration data. See “Calibration Dialog Box” on page 4-138. |
| Select Calibration Data... | Opens a dialog box for the file selection, and then applies the selected calibration data file to the measurement. |

Main Menu

Figure 4-31

Main Menu

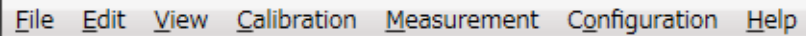

The following describes the functions of the main menu.

File Menu

Displays the following menu items to operate the setup file and measurement data file. For the file types and extensions, see “Summary of Files” on page 4-140.

- New** Clears the present data to start from initial setting.
- Open...** Opens the Open File dialog box used to open a specified setup file or measurement data file. The present data is cleared by opening the file.
- Save** Saves the present data as the same file name.
- Save Setup As...** Opens the Save Data File dialog box used to save the present setup data as the specified setup file.
- Save Data As...** Opens the Save Data File dialog box used to save the present setup data and measurement data as the specified measurement data file.

Change Device ID...

Changes the device ID recorded in the measurement data file.
This opens the Change Device ID dialog box, and changes the device ID recorded in the selected measurement data file(s). See “Change Device ID Dialog Box” on page 4-137.

Recent Setup Files

Lists a maximum of 10 names of the setup files that were recently edited, as menu items. You can easily open a setup file by using them.

- Exit** Exits the gate charge measurement software. Unsaved data is destroyed.

Edit Menu

Displays the following menu items to edit the setup.

- Cut** Moves the selected text to the clipboard.
- Copy** Copies the selected text to the clipboard.
- Paste** Pastes the text from the clipboard to the insertion point.

On-screen keyboard... Displays the on-screen keyboard.

View Menu

Displays the following menu items for the display setting.

Go to Palette Displays the software palette in fullscreen mode.

Main Window Displays the following menu item.

Fullscreen Changes the display style of the main window.

If this is marked, the main window does not have the titlebar and is displayed in fullscreen mode.

If this is unmarked, the main window has the titlebar and is displayed in the regular window style.

This is initially marked.

Color Settings... Opens the Color Setting dialog box to set the color for parts in this software. See “Color Setting Dialog Box” on page 4-137.

Calibration Menu

Displays the following menu items for the calibration.

Start Opens the Calibration dialog box to get the calibration data. See “Calibration Dialog Box” on page 4-138.

Select Data Opens a dialog box for the file selection, and then applies the selected calibration data file to the measurement.

Load Factory

Default Applies the factory default calibration data file to the measurement.

Measurement Menu

Displays the following menu items for controlling the measurement.

Start Starts a measurement. During the measurement, the measurement status indicator on the front panel lights up.

To stop the repeat measurement, select the Measurement > Stop menu, click the Stop Measurement button  on the toolbar, or press the Stop key on the front panel.

Stop Stops the measurement.

Configuration Menu

Displays the following menu item to administrate the configuration of the built-in modules in the mainframe and test fixture.

Module... Opens the Module Configuration dialog box. See “Module Configuration Dialog Box” on page 4-183.

Help Menu

Displays the following menu item.

About... Opens the about box. See “About Box” on page 4-139.

Dialog Boxes

Change Device ID Dialog Box

The Change Device ID dialog box is used to change the device ID in all selected measurement data files at once.

This dialog box is opened by selecting the main menu File > Change Device ID....

- Device ID field** Enter a new device ID. You can also select it from the history.
- Add... button** Opens the file selection dialog box to select the measurement data file(s) that you want to change the device ID. The selected files are displayed into the list.
- Remove button** Excludes the selected measurement data file from the list.
- Execute button** Changes the device ID.
- Close button** Closes this dialog box.

Color Setting Dialog Box

The Color Setting dialog box is used to set colors of the following parts in this software. The setting in the Color Setting dialog box is saved as a user setting.

- Graph Background
- Graph Axis
- Graph Grid
- Graph Text
- Marker

- Gate Charge Characteristics
 - JESD24-2 (H.C.)
 - Vgs-Qg (H.C.)
 - Vds-Qg (H.C.)
 - Id-Qg (H.C.)
 - JESD24-2 (H.V.)
 - Vgs-Qg (H.V.)
 - Vds-Qg (H.V.)
 - Id-Qg (H.V.)
 - JESD24-2 (Derived)
- Switching Waveform
 - Vds
 - Id
 - Vgs
 - Ig
 - LoadVgs
 - LoadIg

This dialog box is opened by selecting the main menu View > Color Settings....

Clicking the color pattern opens the dialog box for selecting a color.

- | | |
|----------------------|---|
| Apply button | Applies the present setting to the graph. |
| Reset button | Resets to the default setting. |
| OK button | Applies the present setting to the graph, and closes this dialog box. |
| Cancel button | Closes this dialog box without applying the present setting. |

Calibration Dialog Box

The Calibration dialog box is used to acquire the calibration data regarding the residual resistance and parasitic capacitance on the signal paths, and apply it to the measurement.

If you change the signal paths to DUT, you need to acquire the calibration data for the new paths.

This dialog box is opened by selecting the main menu Calibration > Start.

Default Calibration tab This page is used to acquire the calibration data for “Open” and “Short” of the DUT gate drive circuit under the predetermined measurement condition.

User Series

Resistor Enter the value of the external series resistor to be not measured by the “Short” calibration.

The residual resistance measured by the “Short” calibration and this resistance value are used for the calibration.

Measure button Starts to acquire the calibration data. Open or short the gate charge measurement circuit according to instructions of the wizard.

Save and Apply button Saves the acquired calibration data to a file, and applies it to the measurement.

Cancel button Destroys the acquired calibration data and closes this dialog box.

Advanced tab This page is used to acquire the calibration data for “Open” of the DUT gate drive circuit under the present setup.

Measure button Starts to acquire the calibration data. Open the gate charge measurement circuit according to instructions of the wizard.

Clear button Destroys the calibration data acquired on this tab page, and cancels to apply. The factory default calibration data is used for the “Open” calibration.

Close button Closes this dialog box.

About Box

The about box displays the model number, the software revision number, download URL for software updating, and so on.

This dialog box is opened by selecting the main menu Help > About....

Summary of Files

The following shows the summary of the files handled by the gate charge measurement software.

Table 4-24 Summary of Files

File Type	Description	Extension	Folder as Initial Setting
Setup File	This has the setup data only. You can save this using the File menu anytime.	*.pda-qg	(You can specify the folder when saving the data)
Measurement Data File	This has the setup data and measurement data including the device ID and comment. The setup data and measurement data are automatically saved to this file in the specified folder at the end of the measurement. And, you can also save this using the File menu anytime.	*.pda-qg.txt	C:\Users\ <user name="">\Documents\Keysight\SeriesB150x\PowerDevice Analyzer\GateCharge\Data Store (You can change this)</user>
Calibration Data File	Calibration data This is automatically saved after the calibration execution.	*.pda-qg.cal	C:\ProgramData\Keysight\SeriesB150x\PowerDevice Analyzer\GateCharge\User CalibrationData
	Factory Default Calibration data This is used when there is no user calibration data.		C:\ProgramData\Keysight\SeriesB150x\PowerDevice Analyzer\GateCharge\CalibrationData

File name of Measurement Data File on Auto-saving

An auto-saved measurement data file is named as follows:

<DeviceID>_<TEMP>_<TIME>.pda-qg.txt

<DeviceID>: Device ID

<TEMP>: Temperature

<TIME>: Time stamp on auto-saving

Example)

Device-1_@Ch1=30degC_Ch2=30degC_2014-10-30_18-56-55.pda-qg.txt

And, the file name is decided according to the following rule.

1. <TEMP> is the characters of the available thermometer identifiers and the thermometer readings. To enable thermometers, use the Thermal Monitor/Control Software. See “Thermal Monitor/Control Software” on page 4-163.

@<thermometer>=<reading>degC

- <thermometer>: An identifier of the available thermometer
 - Ch1** Channel 1 thermometer of B1506A
 - Ch2** Channel 2 thermometer of B1506A
 - Air** Thermometer on the air outlet port of the thermostream
 - DUT** Thermometer on the DUT port of the thermostream
- <reading>: A reading value of the thermometer in degrees centigrade
If multiple thermometers are available, the temperature information is concatenated by an underscore (_). The @ is attached only at the beginning of the temperature information.

Example) @Ch1=25degC_Ch2=75degC_Air=100degC

2. <TIME> is the characters of year, month, day, hour, minute, and second. The time stamp representation depends on the time setting on Windows. And, an invalid character is replaced with an underscore (_).

Example 1) 2014-10-30_18-56-55

Example 2) 30-10-2014_6-56-55_PM

3. If the file name duplicates the existing file name, the serial number from 2 enclosed by brackets is concatenated before the file extension.

Example)

Device-1_@Ch1=30degC_Ch2=30degC_2014-10-30_18-56-55(3).pda-qg.txt

Power Loss Calculation Software

NOTE

This software is available for the B1506A-H21/H51/H71.

Power loss calculation software provides:

- Calculation of switching device power loss for:
 - Hard switching mode
 - Soft switching mode
- Inputs to characterize the following parameters:
 - Gate resistance
 - On resistance
 - Gate charge
 - Gate switching charge
 - Equivalent output capacitance (energy related)
 - Equivalent output capacitance (time related)
 - Input parameter assistance using related measurement data including:
 - Display of source measurement data
- Switching condition parameter input
 - Support of parameter sweep for one parameter
- Power loss calculation results of:
 - Total power loss
 - Conductive power loss
 - Driving power loss
 - Switching power loss (inductive load)
 - Graph representation of loss components for optional parameter sweep

GUI Overview

The GUI (Graphical User Interface) of the Power loss calculation software is comprised of the following areas.

Figure 4-32

Power Loss Calculation Software GUI

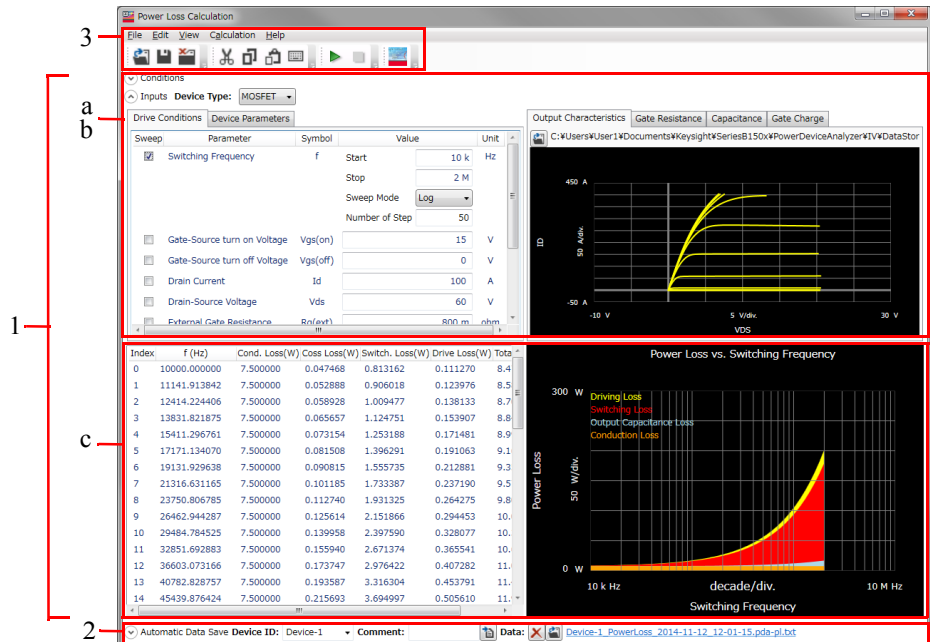

1. Work Area (See p. 4-144.)

This area provides the functions to set the calculation conditions and observe the calculation results. This is separated to the following areas.

- a. Conditions (See p. 4-144.)
- b. Inputs (See p. 4-145.)
- c. Results (See p. 4-152.)

2. Automatic Data Save (See p. 4-155.)

This area provides the functions regarding the automatic saving of the calculation data files.

3. Operating Tools

- Toolbar (See p. 4-156.)

This provides the functions that are very frequently used in the button format.

- Main Menu (See p. 4-158.)

This provides the functions needed for various operations in the menu format.

For the dialog boxes displayed during this software operation, see “Dialog Boxes” on page 4-160.

For the files handled by this software, see “Summary of Files” on page 4-161.

Work Area

In this area, set the calculation conditions and observe the calculation results. This is separated to the following areas.

- Conditions (See p. 4-144.)
- Inputs (See p. 4-145.)
- Results (See p. 4-152.)

Conditions

This is an area to specify your assumption to calculate the power loss on your switching device.

This area can be shown or hidden by clicking the line of Conditions.

Figure 4-33

Conditions

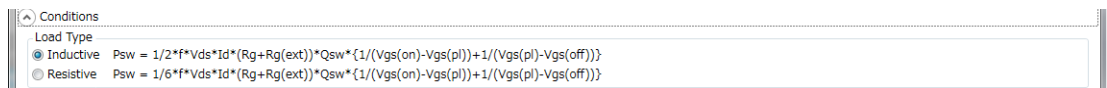

Load Type

Select the assumed load type to calculate the power loss. You can select one from the following load types.

- Inductive: Inductive load
- Resistive: Resistive load

Inputs

This is an area to specify the device type of your DUT, and driving condition and device characteristic parameters that are used as the input data for calculation. The driving condition parameters and device characteristic parameters are separated by tabs.

Other than manually entering the parameter values with referring the device data sheet, you can also enter them using existing measurement data files. This area is equipped with the functions to read existing measurement data files, display the characteristic curve graphs, and extract some parameter values from them. The following measurement data files are readable.

- I/V measurement data file
- Capacitance measurement data file
- Gate charge measurement data file

They are separated by tabs.

This area can be hidden or shown by clicking the line of  Inputs.

Figure 4-34



a. Device Type

Select the device type of your DUT from below.

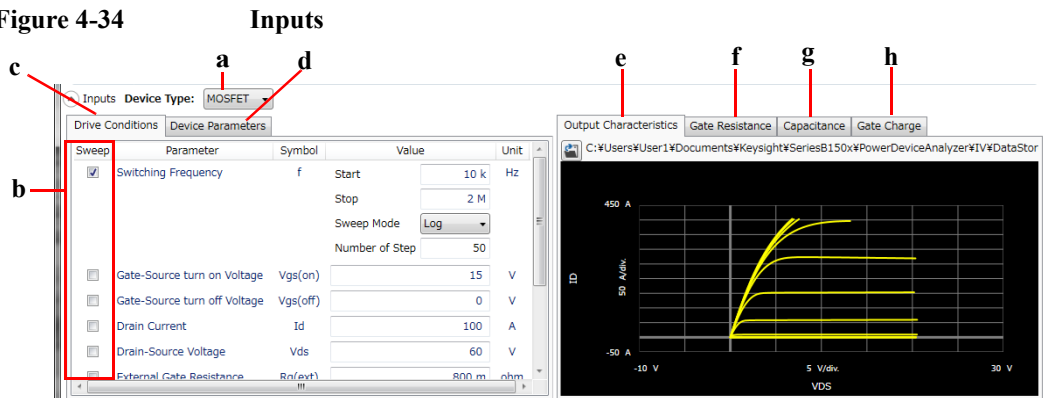
- MOSFET
- IGBT

b. Sweep Parameter

Select one parameter that is swept to observe the loss changes for the changes of this parameter, from the driving condition parameters and device characteristic parameters. To select it, mark the check box of the parameter. As the default, the Switching Frequency parameter in the Driving parameters is selected.

Specify the following items for the selected parameter as the sweep parameter.

- **Start**
Specify the sweep start value.
- **Stop**
Specify the sweep stop value.
- **Sweep Mode**
Select one from the following sweep modes.
 - Linear (Sweep from start to stop in a linear incremental step)
 - Log (Sweep from start to stop in a logarithmic incremental step)
- **Number of Step**
Specify the number of sweep steps from start to stop.

c. Drive Conditions

Specify the driving condition parameter values.

For MOSFET:

- **f: Switching Frequency**
Specify the switching frequency.
- **V_{gs(on)}: Gate-source turn on Voltage**
Specify the gate-source voltage required to turn the device on.
- **V_{gs(off)}: Gate-source turn off Voltage**
Specify the gate-source voltage required to turn the device off.
- **I_d: Drain Current**
Specify the On-state drain current.
- **V_{ds}: Drain-source Voltage**
Specify the Off-state drain-source voltage.
- **R_{g(ext)}: External Gate Resistance**
Specify the gate resistance included in the external driving circuit.

- **Irms: Effective Drain Current**
Specify the effective drain current (the root mean square of the load current).
The effective drain current (Irms) is the product of the square root of the drain current (Id) and the duty cycle (D).
- **D: Duty Cycle**
Specify the duty cycle within the range from 0 to 1.

For IGBT:

- **f: Switching Frequency**
Specify the switching frequency.
- **Vge(on): Gate-Emitter turn on Voltage**
Specify the gate-emitter voltage required to turn the device on.
- **Vge(off): Gate-Emitter turn off Voltage**
Specify the gate-emitter voltage required to turn the device off.
- **Ic: Collector Current**
Specify the On-state collector current.
- **Vce: Collector-Emitter Voltage**
Specify the Off-state collector-emitter voltage.
- **Rg(ext): External Gate Resistance**
Specify the gate resistance included in the external driving circuit.
- **Irms: Effective Collector Current**
Specify the effective collector current (the root mean square of the load current).
The effective collector current (Irms) is the product of the square root of the collector current (Ic) and the duty cycle (D).
- **D: Duty Cycle**
Specify the duty cycle within the range from 0 to 1.

d. Device Parameters

Specify the device characteristic parameter values.

For MOSFET:

- **Qg(on): Gate Charge at on**

Specify the On-state gate charge.

$Qg(\text{on}) - Qg(\text{off})$ is regarded as the gate charge required to turn the device on.

- $Qg(\text{off})$: Gate Charge at off

Specify the Off-state gate charge.

$Qg(\text{on}) - Qg(\text{off})$ is regarded as the gate charge required to turn the device on.

- Rg : Gate Resistance

Specify the gate resistance.

- Qsw : Gate Switching Charge ($Crss$)

Specify the required gate charge (Mirror Charge) so that the drain-source voltage is same as the gate-source voltage when the device state changes from Off to On.

- $Vgs(\text{pl})$: Gate Plateau Voltage

Specify the gate plateau voltage.

- $Rds(\text{on})$: On Resistance

Specify the On-state resistance.

For IGBT:

- $Qg(\text{on})$: Gate Charge at on

Specify the On-state gate charge.

$Qg(\text{on}) - Qg(\text{off})$ is regarded as the gate charge required to turn the device on.

- $Qg(\text{off})$: Gate Charge at off

Specify the Off-state gate charge.

$Qg(\text{on}) - Qg(\text{off})$ is regarded as the gate charge required to turn the device on.

- Rg : Gate Resistance

Specify the gate resistance.

- Qsw : Gate Switching Charge ($Cres$)

Specify the required gate charge (Mirror Charge) so that the collector-emitter voltage is same as the gate-emitter voltage when the device state changes from Off to On.

- $Vge(\text{pl})$: Gate Plateau Voltage

Specify the gate plateau voltage.

- $Vce(\text{sat})$: Saturation Voltage

Specify the collector-emitter saturation voltage.

It is the saturation voltage when the collector current (I_c) carries under the Drive Condition settings.

e. Output Characteristics

Specify the measurement data file taken by the I/V measurement software. To read the file, click the Load Measurement Data button  in the top left corner. The file selection dialog box opens to read the file. The file name to be read is displayed next to the Load Measurement Data button. And, the output characteristic data is displayed on the graph.

You can change the minimum and maximum values on the X and Y-axes by clicking the value.

For MOSFET:

The measurement data file that has any of the following output characteristics is readable.

- ID-VDS
- RDS-ID
- VDS-VGS
- RDS-VGS

The following parameter value is extracted from the $V_{gs(on)}$ parameter value specified in the Drive Conditions and the output characteristic data to be read.

- Device Parameters
 - $R_{ds(on)}$: On Resistance

For IGBT:

The measurement data file that has any of the following output characteristics is readable.

- IC-VCE
- $V_{ce(sat)}$
- VCE-VGE

The following parameter value is extracted from the $V_{ge(on)}$ parameter value specified in the Drive Conditions and the output characteristic data to be read.

- Device Parameters
 - $V_{ce(sat)}$: Saturation Voltage

f. Gate Resistance Specify the Rg characteristic measurement data file taken by the capacitance measurement software. To read the file, click the Load Measurement Data button  in the top left corner. The file selection dialog box opens to read the file. The file name to be read is displayed next to the Load Measurement Data button. And, the Rg characteristic data is displayed on the graph.

You can change the minimum and maximum values on the X and Y-axes by clicking the value.

For MOSFET:

The following parameter value is extracted from the Vgs(off) parameter value specified in the Drive Conditions and the Rg characteristic data to be read.

- Device Parameters
 - Rg: Gate Resistance

For IGBT:

The following parameter value is extracted from the Vge(off) parameter value specified in the Drive Conditions and the Rg characteristic data to be read.

- Device Parameters
 - Rg: Gate Resistance

g. Capacitance Specify the measurement data file taken by the capacitance measurement software. To read the file, click the Load Measurement Data button  in the top left corner. The file selection dialog box opens to read the file. The file name to be read is displayed next to the Load Measurement Data button. And, the characteristic data is displayed on the graph.

You can change the minimum and maximum values on the X and Y-axes by clicking the value.

For MOSFET:

The measurement data file that has the following capacitance characteristics is readable.

- Ciss, Coss, Crss (Coss or Crss)

The Coss characteristics data is used to calculate the output capacitance loss.

The following parameter value is extracted from the Vgs(off) and Vds(off) parameter values specified in the Drive Conditions and the Crss characteristic data to be read.

- Device Parameters
 - Qsw: Gate Switching Charge

Charge when the Crss is charged from 0 V to $V_{ds(off)} - V_{gs(off)}$.

For IGBT:

The measurement data file that has the following capacitance characteristics is readable.

- Cies, Coes, Cres (Coes or Cres)

The Coes characteristics data is used to calculate the output capacitance loss.

The following parameter value is extracted from the $V_{ge(off)}$ and $V_{ce(off)}$ parameter values specified in the Drive Conditions and the Cres characteristic data to be read.

- Device Parameters
 - Qsw: Gate Switching Charge

Charge when the Cres is charged from 0 V to $V_{ds(off)} - V_{gs(off)}$.

h. Gate Charge

Specify the measurement data file taken by the gate charge measurement software. To read the file, click the Load Measurement Data button  in the top left corner. The file selection dialog box opens to read the file. The file name to be read is displayed next to the Load Measurement Data button. And, the gate charge characteristic data is displayed on the graph.

You can change the minimum and maximum values on the X and Y-axes by clicking the value.

The following parameter values are extracted from the gate charge characteristic data to be read.

For MOSFET:

- Drive Conditions
 - $V_{gs(on)}$: Gate-source turn on Voltage
 - $V_{gs(off)}$: Gate-source turn off Voltage
 - Id: Drain Current
 - V_{ds} : Drain-source Voltage

- Device Parameters
 - Qg(on): Gate Charge at on
 - Qg(off): Gate Charge at off
 - Qsw: Gate Switching Charge (Crss)
 - Vgs(pl): Gate Plateau Voltage

For IGBT:

- Drive Conditions
 - Vge(on): Gate-source turn on Voltage
 - Vge(off): Gate-source turn off Voltage
 - Ic: Collector Current
 - Vce: Collector-Emitter Voltage
- Device Parameters
 - Qg(on): Gate Charge at on
 - Qg(off): Gate Charge at off
 - Qsw: Gate Switching Charge (Cres)
 - Vge(pl): Gate Plateau Voltage

Results

This area shows the power loss data in the list and the trend chart formats, that was calculated along your parameter settings specified in the Inputs.

Figure 4-35



a. List

Shows the loss data for the swept parameter values as the calculation result in the list format.

- Index

Shows the index number of the sweep step.

- Sweep parameter

Shows the sweep parameter value specified in the Inputs.

- Conduction Loss

Shows the conduction loss as the calculation result.
This is calculated from the following expression.

For MOSFET:

$$R_{ds(on)} \times I_{rms}^2$$

For IGBT:

$$\frac{V_{ce(sat)}}{I_c} \times I_{rms}^2$$

- Coss (or Coes) Loss

Shows the output capacitance loss as the calculation result.
This is calculated from the following expression.

For MOSFET:

$$f \times \int_a^b (C_{oss} \times V \cdot dV)$$

$$a = R_{ds(on)} \times I_d(on)$$

$$b = V_{ds}$$

For IGBT:

$$f \times \int_a^b (C_{oes} \times V \cdot dV)$$

$$a = V_{ce(sat)}$$

$$b = V_{ce}$$

- Switching Loss

Shows the switching loss as the calculation result.
This is calculated from either of the following expressions.

When the Load Type specified in the Conditions is “Inductive” (MOSFET):

$$\frac{1}{2} \times f \times Vds \times Id \times \{Rg + Rg(ext)\} \times Qsw \times \left\{ \frac{1}{Vgs(on) - Vgs(pI)} + \frac{1}{Vgs(pI) - Vgs(off)} \right\}$$

When the Load Type is “Resistive” (MOSFET):

$$\frac{1}{6} \times f \times Vds \times Id \times \{Rg + Rg(ext)\} \times Qsw \times \left\{ \frac{1}{Vgs(on) - Vgs(pI)} + \frac{1}{Vgs(pI) - Vgs(off)} \right\}$$

When the Load Type specified in the Conditions is “Inductive” (IGBT):

$$\frac{1}{2} \times f \times Vce \times Ic \times \{Rg + Rg(ext)\} \times Qsw \times \left\{ \frac{1}{Vge(on) - Vge(pI)} + \frac{1}{Vge(pI) - Vge(off)} \right\}$$

When the Load Type is “Resistive” (IGBT):

$$\frac{1}{6} \times f \times Vce \times Ic \times \{Rg + Rg(ext)\} \times Qsw \times \left\{ \frac{1}{Vge(on) - Vge(pI)} + \frac{1}{Vge(pI) - Vge(off)} \right\}$$

- **Driving Loss**

Shows the driving loss as the calculation result.
This is calculated from the following expression.

For MOSFET:

$$f \times \{ |Qg(on)| \times Vgs(on) - |Qg(off)| \times Vgs(off) \}$$

For IGBT:

$$f \times \{ |Qg(on)| \times Vge(on) - |Qg(off)| \times Vge(off) \}$$

- **Total Loss**

Shows the total sum of the conduction loss, output capacitance loss, switching loss, and driving loss.

b. Trend Chart

Shows the loss data for the swept parameter values as the calculation result in the trend chart format. Where, the sweep parameter is assigned to the data for the X-axis, and the conduction loss, output capacitance loss, switching loss, and driving loss are assigned to the data for the Y-axis and are accumulated in this order.

You can change the minimum and maximum values on the X and Y-axes by clicking the value.

Automatic Data Save

This area sets the automatic saving for the setup data and measurement data. These data are automatically saved to a new measurement data file in the specified folder at the end of the measurement.

The Data folder and Recent data fields can be shown or hidden by clicking the line of  Automatic Data Save.

Figure 4-36

Automatic Data Save

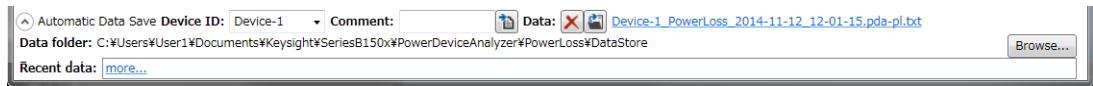

Device ID

Enter device ID string to the Device ID field. The maximum 10 recently-entered device IDs can be kept as history, and you can also select one from the history list.

The entered device ID is automatically saved to the calculation data file at the end of the calculation.

You can also change the device ID in the latest calculation data file after the calculation here. To change it, change the device ID in the Device ID field, and then click the Apply button .

Comment



Enter a comment string to the Comment field.

The entered comment is automatically saved to the calculation data file at the end of the calculation.

You can also change the comment in the latest calculation data file after the calculation here. To change it, change the comment in the Comment field, and then click the Apply button .

Data

The Data field shows the latest auto-saved or last-opened calculation data file name. You can do the following operations.

- Open the calculation data file by clicking the Open button .
- Rename the calculation data file by clicking the calculation data file name.
- Delete the calculation data file by clicking the Delete button .

- Data folder** Shows the absolute path of the auto-saved calculation data file. To change this, click the Browse button to open the folder selection dialog box. Select your desired folder in the dialog box.
- For the initial setting of the data folder, see “Summary of Files” on page 4-161.
- Recent data** Shows up to 10 auto-saved calculation data files that were automatically saved recently, in the hyper-link format. Clicking the hyper-link opens the selected calculation data file. This destroys the presently-editing data.
- If the number of the auto-saved calculation data files is over ten, this field shows “more...”. Clicking this opens the file selection dialog box. Select a calculation data file to open.

Toolbar



Figure 4-37

Toolbar







The toolbar has four tool button groups. The following shows the tool buttons in the tool button groups.

File tool button group



-  **Open** Opens the Open File dialog box used to open a specified setup file or calculation data file. The present data is cleared by opening the file.
-  **Save** Saves the present data as the same file name.
-  **Exit** Exits the power loss calculation software. Unsaved data is destroyed.

Edit tool button group

-  **Cut** Moves the selected text to the clipboard.

-  **Copy** Copies the selected text to the clipboard.
-  **Paste** Pastes the text from the clipboard to the insertion point.
-  **On-screen keyboard** Displays the on-screen keyboard.

Calculation tool button group

-  **Start Calculation** Starts a calculation.
To stop the calculation, select the Calculation > Stop menu, click the Stop Calculation button  on the toolbar, or press the Stop key on the front panel.
-  **Stop Calculation** Stops the calculation.

View tool button group

-  **Go to Palette** Displays the software palette in fullscreen mode.

Main Menu

Figure 4-38

Main Menu

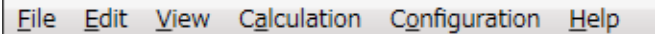

The image shows a horizontal menu bar with six items: File, Edit, View, Calculation, Configuration, and Help. Each item is underlined and has a small square icon to its left. The menu bar is set against a light gray background.

The following describes the functions of the main menu.

File Menu

Displays the following menu items to operate the setup file and calculation data file. For the file types and extensions, see “Summary of Files” on page 4-161.

- | | |
|-------------------------|---|
| New | Clears the present data to start from initial setting. |
| Open... | Opens the Open File dialog box used to open a specified setup file or calculation data file. The present data is cleared by opening the file. |
| Save | Saves the present data as the same file name. |
| Save Setup As... | Opens the Save Data File dialog box used to save the present setup data as the specified setup file. |
| Save Data As... | Opens the Save Data File dialog box used to save the present setup data and calculation data as the specified calculation data file. |

Change Device ID...

Changes the device ID recorded in the calculation data file.

This opens the Change Device ID dialog box, and changes the device ID recorded in the selected calculation data file(s). See “Change Device ID Dialog Box” on page 4-160.

Recent Setup Files

Lists a maximum of 10 names of the setup files that were recently edited, as menu items. You can easily open a setup file by using them.

- | | |
|-------------|---|
| Exit | Exits the power loss calculation software. Unsaved data is destroyed. |
|-------------|---|

Edit Menu

Displays the following menu items to edit the setup.

- | | |
|--------------|--|
| Cut | Moves the selected text to the clipboard. |
| Copy | Copies the selected text to the clipboard. |
| Paste | Pastes the text from the clipboard to the insertion point. |

	On-screen keyboard...	Displays the on-screen keyboard.
View Menu		Displays the following menu items for the display setting.
	Go to Palette	Displays the software palette in fullscreen mode.
	Main Window	Displays the following menu item.
	Fullscreen	Changes the display style of the main window. If this is marked, the main window does not have the titlebar and is displayed in fullscreen mode. If this is unmarked, the main window has the titlebar and is displayed in the regular window style. This is initially marked.
	Color Settings...	Opens the Color Setting dialog box to set the color for parts in this software. See “Color Setting Dialog Box” on page 4-160.
Calculation Menu		Displays the following menu items for controlling the calculation.
	Start	Starts a calculation. To stop the present calculation, select the Calculation > Stop menu, click the Stop Calculation button  on the toolbar, or press the Stop key on the front panel.
	Stop	Stops the calculation.
Help Menu		Displays the following menu item.
	About...	Opens the about box. See “About Box” on page 4-161.

Dialog Boxes

Change Device ID Dialog Box

The Change Device ID dialog box is used to change the device ID in all selected calculation data files at once.

This dialog box is opened by selecting the main menu File > Change Device ID....

- | | |
|------------------------|---|
| Device ID field | Enter a new device ID. You can also select it from the history. |
| Add... button | Opens the file selection dialog box to select the calculation data file(s) that you want to change the device ID. The selected files are displayed into the list. |
| Remove button | Excludes the selected calculation data file from the list. |
| Execute button | Changes the device ID. |
| Close button | Closes this dialog box. |

Color Setting Dialog Box

The Color Setting dialog box is used to set colors of the following parts in this software. The setting in the Color Setting dialog box is saved as a user setting.

- Graph Background
- Graph Axis
- Graph Grid
- Graph Text
- Trend
 - Driving Loss
 - Output Capacitance Loss
 - Switching Loss
 - Conduction Loss
- Trace

This dialog box is opened by selecting the main menu View > Color Settings....

Clicking the color pattern opens the dialog box for selecting a color.

- | | |
|---------------------|---|
| Apply button | Applies the present setting to the graph. |
|---------------------|---|

- Reset button** Resets to the default setting.
- OK button** Applies the present setting to the graph, and closes this dialog box.
- Cancel button** Closes this dialog box without applying the present setting.

About Box

The about box displays the model number, the software revision number, download URL for software updating, and so on.

This dialog box is opened by selecting the main menu Help > About....

Summary of Files

The following shows the summary of the files handled by the power loss calculation software.

Table 4-25 Summary of Files

File Type	Description	Extension	Folder as Initial Setting
Setup File	This has the setup data only. You can save this using the File menu anytime.	*.pda-pl	(You can specify the folder when saving the data)
Calculation data File	This has the setup data and calculation data including the device ID and comment. The setup data and calculation data are automatically saved to this file in the specified folder at the end of the calculation. And, you can also save this using the File menu anytime.	*.pda-pl.txt	C:\Users\ <user name="">\Documents\Keysight\SeriesB150x\PowerDeviceAnalyzer\PowerLoss\DataStore (You can change this)</user>

File name of calculation data File on Auto-saving

An auto-saved calculation data file is named as follows:

<DeviceID>_<TIME>.pda-pl.txt

<DeviceID>: Device ID

<TIME>: Time stamp on auto-saving

Example)

Device-1_2014-10-30_18-56-55.pda-pl.txt

And, the file name is decided according to the following rule.

1. <TIME> is the characters of year, month, day, hour, minute, and second. The time stamp representation depends on the time setting on Windows. And, an invalid character is replaced with an underscore (_).

Example 1) 2014-10-30_18-56-55

Example 2) 30-10-2014_6-56-55_PM

2. If the file name duplicates the existing file name, the serial number from 2 enclosed by brackets is concatenated before the file extension.

Example)

Device-1_2014-10-30_18-56-55(3).pda-pl.txt

Thermal Monitor/Control Software

Thermal monitor/control software provides:

- Thermometer indication
- Thermal profile with measurement triggers
- Control of thermostream/thermal plate

The thermal monitor/control software has two view modes: Monitor mode and Control mode. Just after starting this software, the control mode GUI is displayed.

The following sections describes about GUI (Graphical User Interface) in two view modes.

- Monitor Mode GUI
- Control Mode GUI

Monitor Mode GUI

The monitor mode GUI is a panel without a frame, and is displayed at the upper-right corner of the screen. It always stays on top of other windows. You can move this panel by dragging and releasing it.

The monitor mode GUI is comprised of the following areas.

Figure 4-39

Thermal Monitor/Control Software GUI (Monitor Mode)

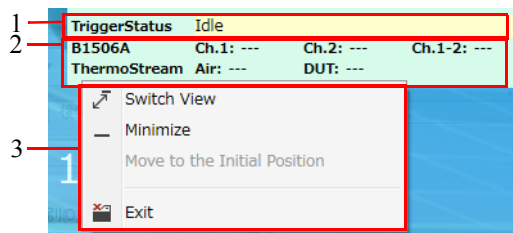

1. Trigger Status (See p. 4-164.)

This displays the thermal condition for the idled DUT characteristics measurement and the target temperature.

2. Thermometer Readings (See p. 4-165.)

This displays the readings on the thermometers.

3. Context Menu (See p. 4-165.)

This provides the functions needed for various operations in the menu format.

Trigger Status

This displays the thermal condition for the idled DUT characteristics measurement and the target temperature. When no thermo-trigger list is executing, this displays “Idle”.

- During the DUT characteristics measurement is waiting until the thermal condition is true, this displays the thermal condition for the idled measurement.
- During controlling the temperature, this displays the target temperature and the thermometer position.

For details, see “Thermo-Trigger” on page 4-171. Also see “Thermal Source” on page 4-167 for selecting the thermostream or the thermal plate.

Thermometer Readings

This displays the readings of the following thermometers. It displays invalid value for invalid thermometers.

- B1506A** Displays temperatures measured by thermocouples connected to the test fixture.
- Ch.1
Displays a temperature measured by a thermocouple connected to the thermocouple connector 1.
 - Ch.2
Displays a temperature measured by a thermocouple connected to the thermocouple connector 2.
 - Ch.1 - 2
Displays a gap between the above Ch.1 and 2 values.
- ThermoStream** Displays temperatures measured by thermometers on the thermostream when ThermoStream is set to Thermal Source.
- Air: Displays a temperature at the air outlet.
 - DUT:
Displays a temperature measured by the DUT thermometer.
- ThermalPlate** Displays temperature measured by thermometer on the thermal plate when ThermalPlate is set to Thermal Source.
- Plate:
Displays a temperature measured by the thermal plate.

Context Menu

The following context menu is displayed by right-clicking on the panel.

- Switch View** Switches the view mode to the Control mode.
You can also switch to the Control mode by double-clicking on the panel.
- Minimize** Minimizes the panel.
- Move to the Initial Position** Moves the panel to the initial position.
- Exit** Closes the panel and exits the thermal monitor/control software.

Control Mode GUI

The control mode GUI is comprised of the following areas.

Figure 4-40

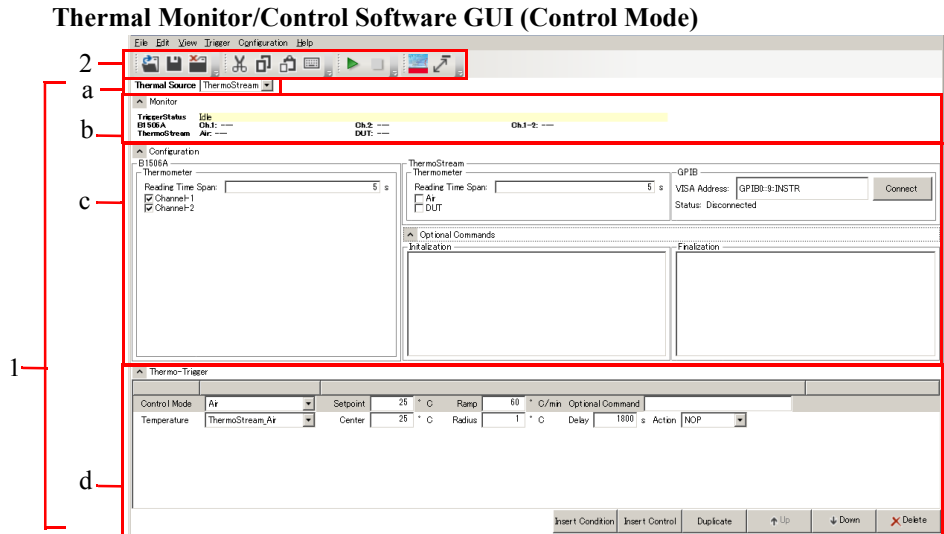

1. Work Area (See p. 4-167.)

This area provides the functions to set the thermometers and thermal source, and create the thermo-trigger list, in addition to all the functions on the monitor mode panel. This is separated to the following areas.

- a. Thermal Source (See p. 4-167.)
- b. Monitor (See p. 4-167.)
- c. Configuration (See p. 4-168.)
- d. Thermo-Trigger (See p. 4-171.)

2. Operating Tools

- **Toolbar** (See p. 4-175.)

This provides the functions that are very frequently used in the button format.

- **Main Menu** (See p. 4-176.)

This provides the functions needed for various operations in the menu format.

For the dialog box displayed during this software operation, see “Dialog Boxes” on page 4-181.

For the files handled by this software, see “Summary of Files” on page 4-182.

Work Area

In this area, set the thermometers and thermal source, and create the thermo-trigger list. This is separated to the following areas.

- Thermal Source (See p. 4-167.)
- Monitor (See p. 4-167.)
- Configuration (See p. 4-168.)
- Thermo-Trigger (See p. 4-171.)

Thermal Source

This field selects the thermal source used for the thermal control/monitor.

ThermoStream Thermostream is used.

ThermalPlate Thermal plate is used.

Monitor

This is an area to display the following items that are common information on the monitor mode panel.

The following fields can be hidden or shown by clicking the line of  Monitor.

Figure 4-41

Monitor



Trigger Status

This displays the thermal condition for the idled DUT characteristics measurement and the target temperature. When no thermo-trigger list is executing, this displays “Idle”.

- During the DUT characteristics measurement is waiting until the thermal condition is true, this displays the thermal condition for the idled measurement.
- During controlling the temperature, this displays the target temperature and the thermometer position.

For details, see “Thermo-Trigger” on page 4-171.

- B1506A** Displays temperatures measured by thermocouples connected to the test fixture.
- Ch.1
Displays a temperature measured by a thermocouple connected to the thermocouple connector 1.
 - Ch.2
Displays a temperature measured by a thermocouple connected to the thermocouple connector 2.
 - Ch.1 - 2
Displays a gap between the above Ch.1 and 2 values.
- ThermoStream** Displays temperatures measured by thermometers on the thermostream when ThermoStream is set to Thermal Source.
- Air: Displays a temperature at the air outlet.
 - DUT:
Displays a temperature measured by the DUT thermometer.
- ThermalPlate** Displays temperature measured by thermometer on the thermal plate when ThermalPlate is set to Thermal Source.
- Plate:
Displays a temperature measured by the thermal plate.

Configuration

This is an area to set the following items regarding the B1506A's thermometers and the thermometers and control of the thermostream/thermal plate.

Figure 4-42

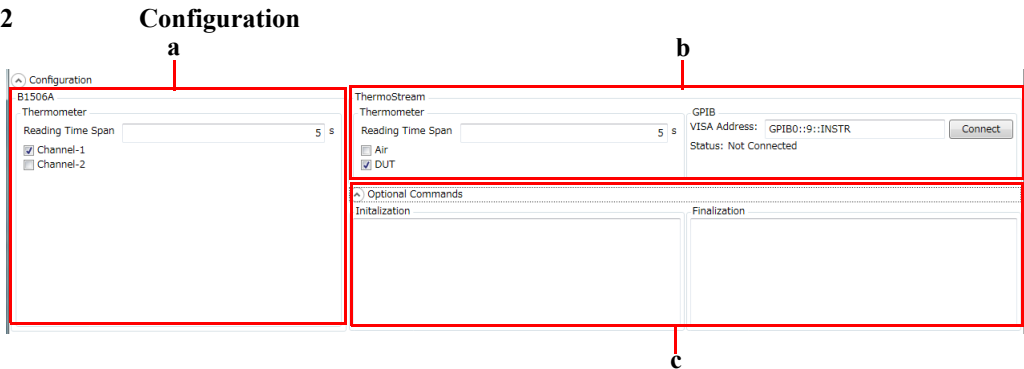

The following fields can be hidden or shown by clicking the line of  Configuration.

a. B1506A Thermometer

This is an area to set the following items regarding the B1506A's thermometers.

Reading Time

Span

Specify the reading time span for the thermometer.
Setting range: 2 s to 3600 s (resolution: 1 s). The default setting is 5 s.
While executing a measurement by any measurement software, the reading is delayed.

Channel 1

check box

Enable (On) or disable (Off) a thermocouple connected to the thermocouple connector 1 on the test fixture.

Channel 2

check box

Enable (On) or disable (Off) a thermocouple connected to the thermocouple connector 2 on the test fixture.

b. ThermoStream or ThermalPlate

This is an area to set the following items regarding the thermal source.

Thermometer

Set up the thermometers of the thermal source.

- Reading Time Span

Specify the reading time span for the thermometer.
Setting range: 2 s to 3600 s (resolution: 1 s). The default setting is 5 s.

- Air check box, for ThermoStream

Enable (On) or disable (Off) the thermometer at the air outlet.

- DUT check box, for ThermoStream

Enable (On) or disable (Off) the DUT thermometer.

- Plate check box, for ThermalPlate

Enable (On) or disable (Off) the thermometer.

GPIB Set up the communication with thermal source using the GPIB.

NOTE

To control the thermal source from B1506A, set B1506A to the system controller.

- VISA Address
Specify the VISA address string of the thermal source.
The default value is "GPIB0::9::INSTR".
- Connect/Disconnect button
Tries to connect with the thermal source using the specified VISA Address, or to disconnect from it.
- Connection Status
Displays the result of the connection trial.
 - Connected
Means that it is successfully connected.
 - Disconnected
Means that it is NOT connected or is disconnected.

c. Optional Commands

This function allows to send additional command string to the thermal source when executing the thermo-trigger list. For the commands, see manual of the thermal source.

This field can be shown or hidden by clicking the line of Optional Commands.

- Initialization
Specify command string that is sent at the beginning of the thermo-trigger list execution.
You can specify multiple commands in list format.
- Finalization
Specify command string that is sent at the end of the thermo-trigger list execution.
You can specify multiple commands in list format.

Thermo-Trigger This is an area to create a thermo-trigger list.

Insert thermal condition steps and thermal control steps using the edition buttons on the bottom of the thermo-trigger list area, and set up the parameters of their steps to create a thermo-trigger list.

The following fields can be hidden or shown by clicking the line of  Thermo-Trigger.

Figure 4-43 Thermo-Trigger



a. Thermo-Trigger List

The thermo-trigger list is a sequence comprised of thermal condition steps and thermal control steps.

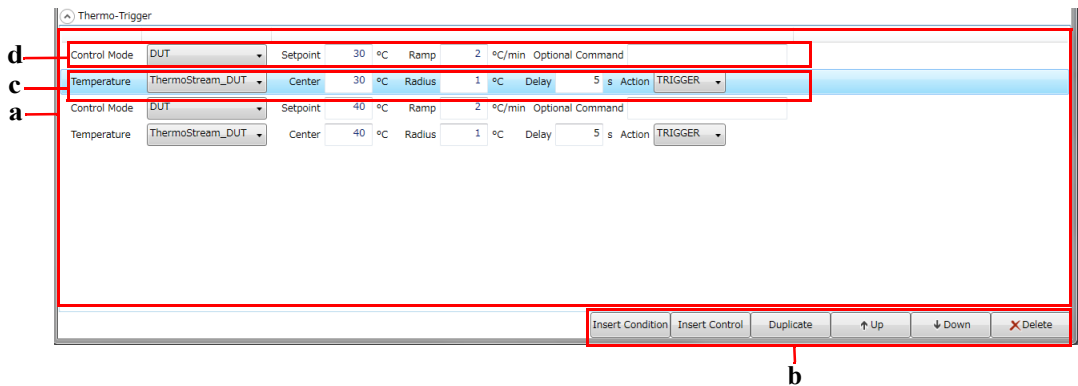
The thermo-trigger list is executed from the top to the bottom of the list. If the thermostream is not connected, all thermal control steps in the list are skipped.

During executing one thermo-trigger list, a measurement on the measurement software waits until the thermal condition is true. Then, when it is true, the measurement is executed.

A thermo-trigger list can have maximum 100 steps.

Create a thermo-trigger list using the following edition buttons.

b. Edition Buttons

- **Insert Condition**
Inserts a new thermal condition step just before the selected step.
A new thermal condition step is added if the list is empty.
- **Insert Control**

Inserts a new thermal control step just before the selected step.

A new thermal control step is added if the list is empty.

- Duplicate

Makes a duplicate of the selected step and insert it just before the selected step.

- Up

Move the selected step up one line.

- Down

Moves the selected step down one line.

- Delete

Deletes the selected step.

c. Parameters of Thermal Condition Step

The thermal condition step compares the specified temperature reading with the specified temperature window, and do the specified action such as triggering the DUT characteristics measurement if the temperature is within the window.

Specify a thermal condition (used thermometer and temperature window) and an action if the condition is true, in a thermal condition step.

Temperature Select a temperature that is used for the condition judgment.

- Channel1

Temperature measured by a thermocouple connected to the thermocouple connector 1 on the test fixture.

- Channel2

Temperature measured by a thermocouple connected to the thermocouple connector 2 on the test fixture.

- Channel1_2

A gap between the above Channel 1 and 2 values.

- ThermoStream_Air, for ThermoStream

Temperature at the air outlet of thermostream.

- ThermoStream_DUT, for ThermoStream

Temperature measured by the DUT thermometer of thermostream.

- ThermalPlate, for ThermalPlate
Temperature measured by the thermometer of thermal plate.
- Center** Specify the center of the temperature window of the thermal condition.
- Radius** Specify the range of the temperature window of the thermal condition. If you specify the Center parameter to 30 °C and the Radius parameter to 2 °C, the range of the thermal condition is from 28 °C to 32 °C.
- Delay** Specify a time after that the condition is true and before the specified action is done.
- Action** Select an action if the condition is true.
- TRIGGER
Sends the start trigger for DUT characteristics measurement.
 - NOP
No operation, and goes to the next step.
This is useful to set multiple thermal conditions for a measurement.
 - END
Finishes the thermo-trigger list execution.

d. Parameters of Thermal Control Step

NOTE

These parameters are used for the thermal control using the thermal source. Skip this section if you do not perform thermal control via GPIB.

The thermal control step controls the thermal source so that the temperature of the specified observation point reaches to the specified target temperature.

If there is a thermal condition step before a thermal control step in the thermo-trigger list, the thermal control step is executed after finishing the measurement triggered from the thermal condition step.

Specify a temperature observation point (control mode) and a target temperature in a thermal control step.

Control Mode Select the thermal control mode from below.

- Air, for ThermoStream
Controls the temperature with referring to the thermometer at the air outlet of thermostream.
- DUT, for ThermoStream
Controls the temperature with referring to the DUT thermometer of the thermostream.
- Plate, for ThermalPlate
Controls the temperature with referring to the thermometer of the thermal plate.

Setpoint

Specify the target temperature.

Ramp

Specify the ramp rate of the temperature.

**Optional
Command**

This function allows to send additional command string to the thermal source when executing the thermal control step. For the commands, see manual of the thermal source.

You can specify multiple commands in list format.

Toolbar

Figure 4-44

Toolbar



The toolbar has four tool button groups. The following shows the tool buttons in the tool button groups.

File tool button group



Open

Opens the Open File dialog box used to open a specified setup file. The present data is cleared by opening the file.



Save

Saves the present data as the same file name.



Exit

Exits the thermal monitor/control software. Unsaved data is destroyed.

Edit tool button group



Cut

Moves the selected text to the clipboard.



Copy

Copies the selected text to the clipboard.



Paste

Pastes the text from the clipboard to the insertion point.



On-screen keyboard

Displays the on-screen keyboard.

Trigger tool button group



Start

Starts to execute the thermo-trigger list, and then switches the view mode to the monitor mode.

To stop the thermo-trigger list execution, select the Trigger > Stop menu, or click the Stop button  on the toolbar.

 **Stop** Stops the thermo-trigger list execution.

View tool button group

 **Go to Palette** Displays the software palette in fullscreen mode.

 **Switch View** Switches the view mode to the Monitor mode.

Main Menu

Figure 4-45

Main Menu

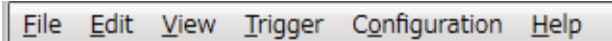

The following describes the functions of the main menu.

File Menu

Displays the following menu items to operate the setup file. For the file types and extensions, see “Summary of Files” on page 4-182.

- New** Clears the present data to start from initial setting.
- Open...** Opens the Open File dialog box used to open a specified setup file. The present data is cleared by opening the file.
- Save** Saves the present data as the same file name.
- Save Setup As...** Opens the Save Data File dialog box used to save the present setup data as the specified setup file.

Recent Setup Files

Lists a maximum of 10 names of the setup files that were recently edited, as menu items. You can easily open a setup file by using them.

- Exit** Exits the thermal monitor/control software. Unsaved data is destroyed.

Edit Menu

Displays the following menu items to edit the setup.

- Cut** Moves the selected text to the clipboard.

Copy	Copies the selected text to the clipboard.
Paste	Pastes the text from the clipboard to the insertion point.
On-screen keyboard...	Displays the on-screen keyboard.

View Menu

Displays the following menu items for the display setting.

Go to Palette	Displays the software palette in fullscreen mode.
Switch View	Switches the view mode to the Monitor mode.
Main Window	Displays the following menu item.

Fullscreen	Changes the display style of the main window. If this is marked, the main window does not have the titlebar and is displayed in fullscreen mode. If this is unmarked, the main window has the titlebar and is displayed in the regular window style. This is initially marked.
-------------------	---

Trigger Menu

Displays the following menu items for controlling the thermo-trigger list execution.

Start	Starts to execute the thermo-trigger list, and then switches the view mode to the monitor mode. The thermo-trigger list is a sequence comprised of thermal condition steps and thermal control steps. For details, see “Thermo-Trigger” on page 4-171. During executing one thermo-trigger list, you can execute a measurement on one of the following software in synchronization if the thermal conditions are respectively true. <ul style="list-style-type: none">• Datasheet Characterization Software (See p. 4-5.)• I/V Measurement Software (See p. 4-56.)• Capacitance Measurement Software (See p. 4-90.)• Gate Charge Measurement Software (See p. 4-118.)
--------------	--

During executing one thermo-trigger list, a measurement on the measurement software waits until the thermal condition is true. Then, when it is true, the measurement is executed. For the measurement execution in synchronization with the thermo-trigger list, see “Executing Measurement in Synchronization with Thermo-trigger List” on page 4-179.

Stop Stops the thermo-trigger list execution.
The measurement software cancels the idled measurement. Hence, the measurement is not executed.

Configuration Menu

Displays the following menu item for the thermostream parameter setting.

Define

ThermoStream

Parameters... Opens the ThermoStream Parameters dialog box. See “ThermoStream Parameters Dialog Box” on page 4-181.

Define

ThermalPlate

Parameters... Opens the ThermalPlate Parameters dialog box. See “ThermalPlate Parameters Dialog Box” on page 4-182.

Help Menu

Displays the following menu item.

About... Opens the about box. See “About Box” on page 4-182.

Executing Measurement in Synchronization with Thermo-trigger List

You can execute a DUT characteristics measurement using one of the following software in synchronization with the thermo-trigger list. Along the progress of the thermo-trigger list, the temperature around DUT is controlled and the measurement is executed if it reaches within the target temperature window.

- Datasheet Characterization Software
- I/V Measurement Software
- Capacitance Measurement Software
- Gate Charge Measurement Software

If you use the thermal source to control the temperature around DUT, do the following preparation for the measurement in synchronization with the thermo-trigger list.

- On the measurement software:
Set up the measurement conditions, and confirm the measurement is successfully executed at normal temperature. And then, save the setup data to a setup file or measurement data file.
- On the thermal monitor/control software:
Set up the thermal condition and the thermal source control, and create a thermo-trigger list in the control mode. And then, save the setup data to a setup file.

After this preparation, follow the step below to execute the measurement in synchronization with the thermo-trigger list.

1. Start the thermal monitor/control software.
2. Switch the view mode to the Control mode.
3. Open the prepared setup file on the thermal monitor/control software.
4. Start the measurement software.
5. Open the prepared setup file or measurement data file on the measurement software.
6. Click Start tool button in the toolbar (or select Trigger > Start menu) on the thermal monitor/control software. The thermo-trigger list is executed.

7. Click Start tool button in the toolbar (or select Measurement > Start menu) on the measurement software.

At this time, the measurement is not executed, and waits until the temperature reaches within the target temperature window. Along the progress of the thermo-trigger list, the temperature around DUT is controlled and the measurement is executed if it reaches within the target temperature window.

If you control the thermal source manually, you can execute the measurement in synchronization with the thermo-trigger list using the similar manner as above. The following shows the differences.

- Preparation on the thermal monitor/control software:
Set up the thermal conditions only, and create a thermo-trigger list that has only thermal condition steps, not thermal control steps.
- With checking the present temperature around DUT and the next target temperature window (thermal condition) using the monitor mode panel of the thermal monitor/control software, control the thermal source manually.
When the present temperature reaches within the target temperature window, the measurement is executed. Wait until finishing the measurement, control the thermal source again so that the temperature goes to the next target temperature window.

Dialog Boxes

ThermoStream Parameters Dialog Box

This dialog box is used to define the thermostream parameters. For details of the parameters, see manual of thermostream.

This dialog box is opened by selecting the main menu Configuration > Define ThermoStream Parameters....

DUT sensor	Select the type of the thermocouple used as the DUT thermometer. <ul style="list-style-type: none">• OFF (disable)• K• T
DUT self tuning control	Select OFF or ON to disable or enable the self tuning control regarding the overshoot and speed of the DUT thermal controlling.
DUT thermal constant	Specify a thermal constant for DUT thermal controlling.
Air to DUT max	Specify the maximum acceptable difference between the DUT temperature and the temperature at the air outlet of thermostream.
Air temperature max	Specify the maximum temperature at the air outlet of thermostream.
Air temperature min	Specify the minimum temperature at the air outlet of thermostream.
Apply button	Applies the present setting to the thermostream.
OK button	Applies the present setting to the thermostream, and closes this dialog box.
Cancel button	Closes this dialog box without applying the present setting.

ThermalPlate Parameters Dialog Box

This dialog box is used to define the thermal plate parameters. For details of the parameters, see manual of thermal plate.

This dialog box is opened by selecting the main menu Configuration > Define ThermalPlate Parameters....

Frequency Specify the line frequency.

- 50Hz
- 60Hz

Upper Temperature Limit

Specify the maximum programmable temperature.

Apply button Applies the present setting to the thermal plate.

OK button Applies the present setting to the thermal plate, and closes this dialog box.

Cancel button Closes this dialog box without applying the present setting.

About Box

The about box displays the model number, the software revision number, download URL for software updating, and so on.

This dialog box is opened by selecting the main menu Help > About....

Summary of Files

The following shows the summary of the files handled by the thermal monitor/control software.

Table 4-26 Summary of Files

File Type	Description	Extension	Folder as Initial Setting
Setup File	This has the setup data. You can save this using the File menu anytime.	*.pda-th	(You can specify the folder when saving the data)

Common GUI Components

This section describes the following GUI components commonly used in the Keysight Easy Test Navigator software.

- “Module Configuration Dialog Box”

Module Configuration Dialog Box

You can do the following operations in the Module Configuration dialog box.

- Checking the revision of the firmware
- Setting the power line cycle
- Checking the status of the hardware modules
- Resetting the hardware modules
- Executing the self-test
- Executing the self-calibration
- Executing the self-diagnostics

This dialog box is opened by selecting the main menu Configuration > Module....

Firmware Revision Shows the revision of the firmware.

Line Frequency Sets the power line frequency. Select one from below.

- 50 Hz
- 60 Hz

Module Name and Status Shows the module’s model numbers and the result of the self-test, self-calibration, and self-diagnostics for the modules.

- B1506A-H20
Table 4-27 shows the configuration and status for B1506A-H20.
- B1506A-H21
Table 4-28 shows the configuration and status for B1506A-H21.

- B1506A-H50/H70

Table 4-29 shows the configuration and status for B1506A-H50/H70.

- B1506A-H51/H71

Table 4-30 shows the configuration and status for B1506A-H51/H71.

Operation Buttons The Module Configuration dialog box has the following buttons for operations.

Reset	Initializes and re-acknowledges all the modules.
Self Test	Starts the self-test for all the modules.
Self Calibration	Starts the self-calibration for all the modules.
Diagnosis	Starts the self-diagnostics for all the output selectors. After clicking this button, a dialog box is opened to instruct the terminal connections. Connect the terminals according to the displayed instructions.
Abort	Aborts the process in progress.
Close	Closes the Module Configuration dialog box.

Error Log This is a display area situated between the Abort and Close buttons. Error messages are displayed when errors occur during a process. The error messages are cleared when you do any new operation.

Table 4-27

B1506A-H20 Configuration and Status

Configuration	Status
GNDU : B1500-66505	<ul style="list-style-type: none"> • Pass
MPSMU (SMU1) : B1511B	Passed
MCSMU (SMU2) : B1514A	<ul style="list-style-type: none"> • Testing
HCSMU (SMU3) : B1512A	Self-testing now
HVSMU (SMU4) : B1513C	<ul style="list-style-type: none"> • Calibrating Calibrating now <ul style="list-style-type: none"> • Fail Self-test failed or self-calibration failed <ul style="list-style-type: none"> • Unavailable Not acknowledged
I/V Selector	<ul style="list-style-type: none"> • Pass Passed <ul style="list-style-type: none"> • Diagnosing Diagnosing now <ul style="list-style-type: none"> • Fail Self-diagnostics failed <ul style="list-style-type: none"> • Unavailable ^a Not acknowledged

a. This also occurs before it is turned on.

Table 4-28

B1506A-H21 Configuration and Status

Configuration	Status
GNDU : B1500-66505	<ul style="list-style-type: none"> • Pass
MPSMU (SMU1) : B1511B	Passed
MFCMU : B1520A	<ul style="list-style-type: none"> • Testing
MCSMU (SMU2) : B1514A	Self-testing now
MCSMU (SMU3) : B1514A	<ul style="list-style-type: none"> • Calibrating
HCSMU (SMU4) : B1512A	Calibrating now
HVSMU (SMU5) : B1513C	<ul style="list-style-type: none"> • Fail Self-test failed or self-calibration failed <ul style="list-style-type: none"> • Unavailable Not acknowledged
I/V Selector	<ul style="list-style-type: none"> • Pass
Device Capacitance Selector	Passed <ul style="list-style-type: none"> • Diagnosing Diagnosing now <ul style="list-style-type: none"> • Fail Self-diagnostics failed <ul style="list-style-type: none"> • Unavailable ^a Not acknowledged

a. This also occurs before it is turned on.

Table 4-29

B1506A-H50/H70 Configuration and Status

Configuration	Status
GNDU : B1500-66505	<ul style="list-style-type: none"> • Pass
MPSMU (SMU1) : B1511B	Passed
MCSMU (SMU2) : B1514A	<ul style="list-style-type: none"> • Testing
MCSMU (SMU3) : B1514A	Self-testing now
MCSMU (SMU4) : B1514A	<ul style="list-style-type: none"> • Calibrating
HVSMU (SMU5) : B1513C	Calibrating now
UHCU	<ul style="list-style-type: none"> • Fail Self-test failed or self-calibration failed
I/V Selector	<ul style="list-style-type: none"> • Unavailable Not acknowledged
	<ul style="list-style-type: none"> • Pass Passed
	<ul style="list-style-type: none"> • Diagnosing Diagnosing now
	<ul style="list-style-type: none"> • Fail Self-diagnostics failed
	<ul style="list-style-type: none"> • Unavailable ^a Not acknowledged

a. This also occurs before it is turned on.

Table 4-30

B1506A-H51/H71 Configuration and Status

Configuration	Status
GNDU : B1500-66505	<ul style="list-style-type: none"> • Pass
MPSMU (SMU1) : B1511B	Passed
MFCMU : B1520A	<ul style="list-style-type: none"> • Testing
MCSMU (SMU2) : B1514A	Self-testing now
MCSMU (SMU3) : B1514A	<ul style="list-style-type: none"> • Calibrating
MCSMU (SMU4) : B1514A	Calibrating now
MCSMU (SMU5) : B1514A	<ul style="list-style-type: none"> • Fail
HVSMU (SMU6) : B1513C	Self-test failed or self-calibration failed
UHCU	<ul style="list-style-type: none"> • Unavailable
	Not acknowledged
I/V Selector	<ul style="list-style-type: none"> • Pass
Device Capacitance Selector	<ul style="list-style-type: none"> Passed • Diagnosing Diagnosing now • Fail Self-diagnostics failed • Unavailable ^a Not acknowledged

a. This also occurs before it is turned on.

This information is subject to change without notice.

© Keysight Technologies 2014, 2016

Edition 3, January 2016

