

BK PRECISION

5490C Series

5 ½ and 6 ½ Digit Multimeters

Models: 5492C/5492CGPIB, 5493C/5493CGPIB

USER MANUAL



Safety Summary

The following safety precautions apply to both operating and maintenance personnel and must be followed during all phases of operation, service, and repair of this instrument.

WARNING

Before applying power to this instrument:

- Read and understand the safety and operational information in this manual.
- Apply all the listed safety precautions.
- Verify that the voltage selector at the line power cord input is set to the correct line voltage. Operating the instrument at an incorrect line voltage will void the warranty.
- Make all connections to the instrument before applying power.
- Do not operate the instrument in ways not specified by this manual or by B&K Precision.

Failure to comply with these precautions or with warnings elsewhere in this manual violates the safety standards of design, manufacture, and intended use of the instrument. B&K Precision assumes no liability for a customer's failure to comply with these requirements.

Category rating

The IEC 61010 standard defines safety category ratings that specify the amount of electrical energy available and the voltage impulses that may occur on electrical conductors associated with these category ratings. The category rating is a Roman numeral of I, II, III, or IV. This rating is also accompanied by a maximum voltage of the circuit to be tested, which defines the voltage impulses expected and required insulation clearances. These categories are:

Category I (CAT I): Measurement instruments whose measurement inputs are not intended to be connected to the mains supply. The voltages in the environment are typically derived from a limited-energy transformer or a battery.

Category II (CAT II): Measurement instruments whose measurement inputs are meant to be connected to the mains supply at a standard wall outlet or similar sources. Example measurement environments are portable tools and household appliances.

Category III (CAT III): Measurement instruments whose measurement inputs are meant to be connected to the mains installation of a building. Examples are measurements inside a building's circuit breaker panel or the wiring of permanently-installed motors.

Category IV (CAT IV): Measurement instruments whose measurement inputs are meant to be connected to the primary power entering a building or other outdoor wiring.

⚠️ WARNING

Do not use this instrument in an electrical environment with a higher category rating than what is specified in this manual for this instrument.

⚠️ WARNING

You must ensure that each accessory you use with this instrument has a category rating equal to or higher than the instrument's category rating to maintain the instrument's category rating. Failure to do so will lower the category rating of the measuring system.

Electrical Power

This instrument is intended to be powered from a CATEGORY II mains power environment. The mains power should be 120 V RMS or 240 V RMS. Use only the power cord supplied with the instrument and ensure it is appropriate for your country of use.

Ground the Instrument

⚠️ WARNING

To minimize shock hazard, the instrument chassis and cabinet must be connected to an electrical safety ground. This instrument is grounded through the ground conductor of the supplied, three-conductor AC line power cable. The power cable must be plugged into an approved three-conductor electrical outlet. The power jack and mating plug of the power cable meet IEC safety standards.

⚠️ WARNING

Do not alter or defeat the ground connection. Without the safety ground connection, all accessible conductive parts (including control knobs) may provide an electric shock. Failure to use a properly-grounded approved outlet and the recommended three-conductor AC line power cable may result in injury or death.

⚠️ WARNING

Unless otherwise stated, a ground connection on the instrument's front or rear panel is for a reference of potential only and is not to be used as a safety ground.

Do not operate in an explosive or flammable atmosphere

⚠️ WARNING

Do not operate the instrument in the presence of flammable gases or vapors, fumes, or finely-divided particulates.

⚠️ WARNING

The instrument is designed to be used in office-type indoor environments. Do not operate the instrument

- In the presence of noxious, corrosive, or flammable fumes, gases, vapors, chemicals, or

finely-divided particulates.

- In relative humidity conditions outside the instrument's specifications.
- In environments where there is a danger of any liquid being spilled on the instrument or where any liquid can condense on the instrument.
- In air temperatures exceeding the specified operating temperatures.
- In atmospheric pressures outside the specified altitude limits or where the surrounding gas is not air.
- In environments with restricted cooling airflow, even if the air temperatures are within specifications.
- In direct sunlight.

CAUTION

This instrument is intended to be used in an indoor pollution degree 2 environment. The operating temperature range is 0 °C to 40 °C and the operating humidity range is up to 80% relative humidity with no condensation allowed.

Measurements made by this instrument may be outside specifications if the instrument is used in non-office-type environments. Such environments may include rapid temperature or humidity changes, sunlight, vibration and/or mechanical shocks, acoustic noise, electrical noise, strong electric fields, or strong magnetic fields.

Do not operate instrument if damaged

If the instrument is damaged, appears to be damaged, or if any liquid, chemical, or other material gets on or inside the instrument, remove the instrument's power cord, remove the instrument from service, label it as not to be operated, and return the instrument to B&K Precision for repair. Notify B&K Precision of the nature of any contamination of the instrument.

Clean the instrument only as instructed

Do not clean the instrument, its switches, or its terminals with contact cleaners, abrasives, lubricants, solvents, acids/bases, or other such chemicals. Clean the instrument only with a clean dry lint-free cloth or as instructed in this manual.

Not for critical applications

WARNING

This instrument is not authorized for use in contact with the human body or for use as a component in a life-support device or system.

Do not touch live circuits

⚠ WARNING

Instrument covers must not be removed by operating personnel. Component replacement and internal adjustments must be made by qualified service-trained maintenance personnel who are aware of the hazards involved when the instrument's covers and shields are removed. Under certain conditions, even with the power cord removed, dangerous voltages may exist when the covers are removed. To avoid injuries, always disconnect the power cord from the instrument, disconnect all other connections (for example, test leads, computer interface cables, etc.), discharge all circuits, and verify there are no hazardous voltages present on any conductors by measurements with a properly-operating voltage-sensing device before touching any internal parts. Verify the voltage-sensing device is working properly before and after making the measurements by testing with known-operating voltage sources and test for both DC and AC voltages. Do not attempt any service or adjustment unless another person capable of rendering first aid and resuscitation is present.

Do not insert any object into an instrument's ventilation openings or other openings.

⚠ WARNING

Hazardous voltages may be present in unexpected locations in circuitry being tested when a fault condition in the circuit exists.

Fuse replacement

⚠ WARNING

Fuse replacement must be done by qualified service-trained maintenance personnel who are aware of the instrument's fuse requirements and safe replacement procedures. Disconnect the instrument from the power line before replacing fuses. Replace fuses only with new fuses of the fuse types, voltage ratings, and current ratings specified in this manual or on the back of the instrument. Failure to do so may damage the instrument, lead to a safety hazard, or cause a fire. Failure to use the specified fuses will void the warranty.

Servicing

⚠ CAUTION

Do not substitute parts that are not approved by B&K Precision or modify this instrument. Return the instrument to B&K Precision for service and repair to ensure that safety and performance features are maintained.

Cooling fans

⚠ CAUTION

This instrument contains one or more cooling fans. For continued safe operation of the instrument, the air inlet and exhaust openings for these fans must not be blocked nor must accumulated dust or other debris be allowed to reduce airflow. Maintain at least 25 mm clearance around the sides of the instrument that contain air inlet and exhaust ports. If mounted in a rack, position power devices in the rack above the instrument to minimize instrument heating while rack mounted. Do not continue to operate the instrument if you cannot verify the fan is operating (note some fans may have intermittent duty cycles). Do not insert any object into the fan's inlet or outlet.

For continued safe use of the instrument

- Do not place heavy objects on the instrument.
- Do not obstruct cooling airflow to the instrument.
- Do not place a hot soldering iron on the instrument.
- Do not pull the instrument with the power cord, connected probe, or connected test lead.
- Do not move the instrument when a probe is connected to a circuit being tested

Compliance Statements

Disposal of Old Electrical & Electronic Equipment (Applicable in the European Union and other European countries with separate collection systems)

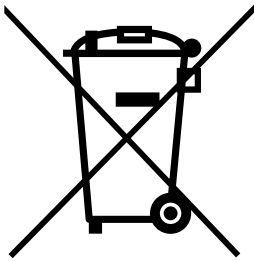

This product is subject to Directive 2002/96/EC of the European Parliament and the Council of the European Union on waste electrical and electronic equipment (WEEE), and in jurisdictions adopting that Directive, is marked as being put on the market after August 13, 2005, and should not be disposed of as unsorted municipal waste. Please utilize your local WEEE collection facilities in the disposition of this product and otherwise observe all applicable requirements.

CE Declaration of Conformity

This instrument meets the requirements of 2014/35/EU Low Voltage Directive and 2014/30/EU Electromagnetic Compatibility Directive with the following standards.













Low Voltage Directive

- EN 61010-1: 2010

EMC Directive

- EN 61326-1: 2013

Safety Symbols

	Refer to the user manual for warning information to avoid hazard or personal injury and prevent damage to instrument.
	Electric Shock hazard
	This is the AC mains connect/disconnect mechanical power switch.
	On (Power). This is the In position of the power switch when instrument is ON.
	Off (Power). This is the Out position of the power switch when instrument is OFF.
	Power standby. The unit is not completely disconnected from the AC mains in off state.
	Alternating current (line)
	Chassis (earth ground) symbol
	Ground terminal
	Protective earth ground
	CAUTION indicates a hazardous situation which, if not avoided, will result in minor or moderate injury
	WARNING indicates a hazardous situation which, if not avoided, could result in death or serious injury
	DANGER indicates a hazardous situation which, if not avoided, will result in death or serious injury.

Contents

Safety Summary.....	ii
Compliance Statements.....	vi
CE Declaration of Conformity	vii
Safety Symbols.....	viii
1 General Information	3
1.1 Operating Environment	3
1.2 Package Contents.....	3
1.3 Product Dimensions.....	4
1.4 Front Panel Overview	4
1.5 Rear Panel Overview.....	5
2 Getting Started	6
2.1 Input Power and Fuse Requirements.....	6
2.2 Check and/or Change Fuse	7
2.3 Carrying Handle Adjustment	8
3 Front Panel Operation.....	9
3.1 Front Panel Menu Reference	9
3.2 Display	11
3.2.1 Change Display Mode	11
3.2.2 Display Label Text	12
3.2.3 Digit Mask.....	13
3.2.4 Probe Hold Function.....	13
3.2.5 Screen Capture and File Transfer	14
3.3 Basic Measurements.....	14
3.3.1 DC Voltage	14
3.3.2 DCV Ratio.....	16
3.3.3 AC Voltage.....	16
3.3.4 DC Current	18
3.3.5 AC Current	19
3.3.6 Resistance 2W (2-wire).....	20
3.3.7 Resistance 4W (4-wire).....	22
3.3.8 Capacitance Measurement.....	23
3.3.9 Diode	24
3.3.10 Continuity	25
3.3.11 Temperature test	26
3.3.12 Frequency measurement.....	27
4 Secondary Measurement	28
5 Math Functions.....	29

5.1 Null Operation	29
5.2 Statistics	29
5.3 Limit	30
5.4 dB Calculation	30
5.5 dBm Calculation	30
5.6 mX+b	30
5.7 Percent	30
6 Save / Recall	31
6.1 Save Readings	31
6.2 Save Settings	31
6.3 Recall Settings	31
6.4 Power On	32
7 System Settings	33
7.1 Set the language	33
7.2 Setting the date/time	33
7.3 Setting the buzzer and brightness	33
7.4 Setting the format of the digital display	33
8 Interface	34
8.1 RS232 interface	34
8.1.1 RS232 Interface Operation	34
8.2 USB Interface	37
8.2.1 USB Device	37
8.2.2 USB Host	37
8.3 LAN Interface	37
8.4 GPIB Interface	38
8.4.1 GPIB Bus	38
8.4.2 Setting the GPIB Address	40
8.4.3 General Bus Commands	40
8.4.4 Setting through the interface	40
9 Specifications - 5492C / 5492CGPIB	41
10 Specifications - 5493C / 5493CGPIB	43
10.1 Supplementary specifications – 5493C / 5493CGPIB	46
11 Service Information	47

1 General Information

The 5490C Series 5 ½ and 6 ½-digit benchtop multimeters offer a broad measurement range with speeds up to 1000 readings per second, and a basic DC Voltage accuracy up to 35 ppm delivering measurement results quickly and accurately.

5492C/5493C has broad measurement ranges:

- DC voltage from 0.1 μ V to 1000 V
- AC voltage from 0.1 μ V to 750 VAC, peak value of 1000 V
- DC current from 10 nA to 10 A
- AC current from 10 nA to 10 A
- Resistance measurement from 0.01 m Ω to 120 M Ω
- Capacitance from 0.1 pF to 10 mF
- Frequency from 2.2 Hz to 1 MHz

Some additional capabilities:

- Full range of functions: In addition to those listed above, 5492C/5493C functions include period, dB, dBm, continuity, DC V ratio, diode testing, arithmetical operation (mX+b), and percentage calculation.
- Programming languages and remote control interfaces: This instrument supports SCPI commands. The remote control interface ports include USB Device, RS232, LAN, and optional GPIB interface (Model 5492CGPIB/5493CGPIB)
- Readings and instrument settings: Up to 10,000 readings can be stored in local mode.
- Completed calibration: The unit can be calibrated through a remote control interface.

1.1 Operating Environment

Power supply: 110V/220V \pm 10%

Line frequency: 50Hz / 60Hz \pm 5%

Power consumption: \leq 30 VA

Operating temperature: 0°C to 40°C

Humidity: \leq 90% RH

1.2 Package Contents

5492C/5493C was carefully inspected mechanically and electrically before shipment. After unpacking all items from the shipping carton, please check for any obvious signs of physical damage that may have occurred during transportation. Report any damage to the shipping agent immediately. Save the original packing carton for possible future shipments. The following items are included with every 5490C Series model:

- **1 x Model 5492C/5492CGPIB, 5493C/5493CGPIB Digital Multimeter**
- **1 x Test leads (Model TL37)**

- 1 x USB interface connection cable
- 1 x AC power cord
- 1 x T500 mAL fuse
- 1 x Test report
- 1 x Certificate of Calibration

Verify that you have received all the items above when you get the multimeter. If anything is missing, please contact B&K Precision.

1.3 Product Dimensions

Dimensions (W×H×D): 225mm×100mm×355mm

Net weight: Approximately 5.51 lbs (2.5 kg)

1.4 Front Panel Overview

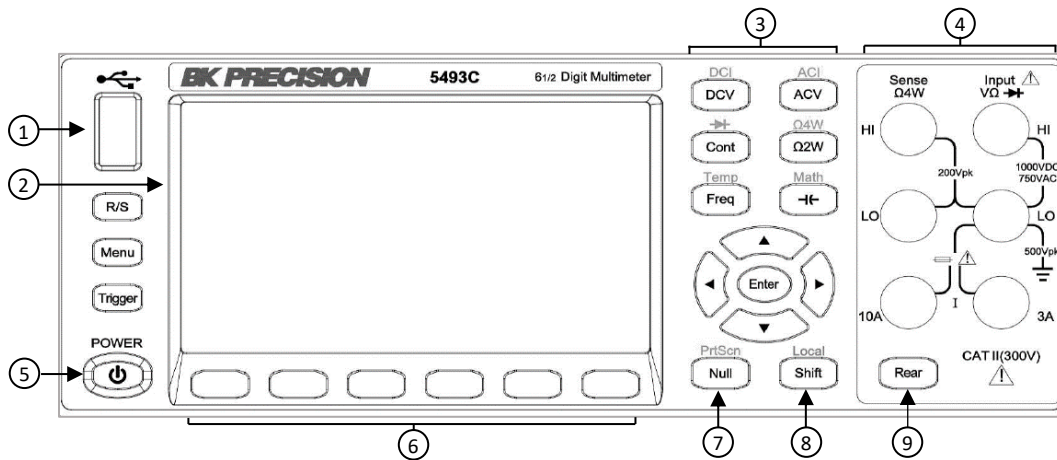

Front Panel Description

- ① USB host port
- ② 4.3-inch LCD
- ③ Main function keys
- ④ Input terminals
- ⑤ Power standby button
- ⑥ Softkeys
- ⑦ Null/Screenshot key
- ⑧ Shift/Local key
- ⑨ Rear panel input button (on 6 ½-digit models only)

1.5 Rear Panel Overview

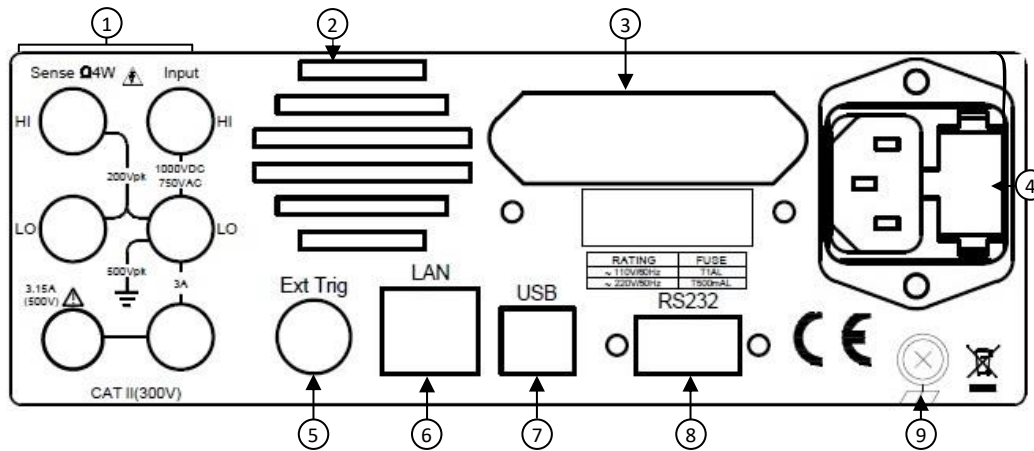

Rear Panel Description

- ① Rear input terminals (6 ½-digit models only)
- ② Cooling fan
- ③ GPIB interface (5492CGPIB/5493CGPIB models only)
- ④ AC power input receptacle & fuse box
- ⑤ External Trigger BNC connector
- ⑥ LAN interface
- ⑦ USB interface
- ⑧ RS232 interface
- ⑨ Chassis ground

2 Getting Started

Before connecting and powering up the instrument, please review the instructions in this chapter.

2.1 Input Power and Fuse Requirements

The 5490C Series digital multimeters can operate on 110 V or 220 V with +/-10% tolerance at 60 Hz or 50 Hz. Before powering the instrument, please check for the correct power input setup that corresponds to the line voltage to be used for operation. Note the label on the rear panel of the instrument as shown below:

RATING	FUSE
~ 110V/60Hz	T1 AL
~ 220 V/50Hz	T500mAL

Table 2.1 – Fuse Table

Before connecting to an AC outlet or external power source, verify that the AC power cord, including the extension line, is compatible with the rated voltage/current and that there is sufficient circuit capacity for the power source. Once verified, connect the cable firmly.

WARNING



The included AC power cord is safety certified for this instrument operating in rated range. To change a cable or add an extension cable, be sure that it can meet the required power ratings for this instrument. Any misuse with wrong or unsafe cables will void the warranty.

SHOCK HAZARD:



The power cord provides a chassis ground through a third conductor. Verify that your power outlet is of the three-conductor type with the correct pin connected to earth ground.

2.2 Check and/or Change Fuse

⚠ WARNING

For safety, no power should be applied to the instrument while changing line voltage operation. Disconnect all cables connected to the instrument before proceeding.

Check and/or Change Fuse

- Locate the fuse box next to the AC input connector in the rear panel
- Remove the fuse box as shown in Figure 2.2 – AC Input Fuse Removal below
- Check and replace fuse if necessary

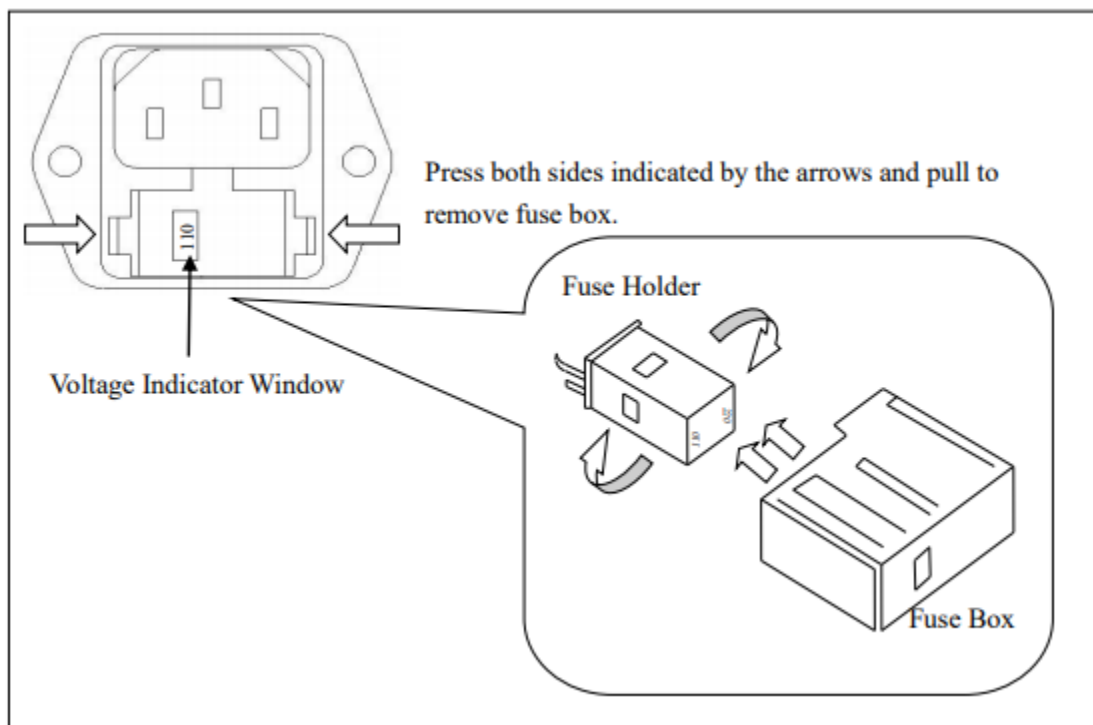

Figure 2.2 – AC Input Fuse Removal

⚠ WARNING

Any disassembling of the case or changing the fuse should be performed by an authorized service technician.

There is a second fuse with a fuse holder located in the rear panel of the multimeter. This is an overcurrent protection fuse for the low current measurement input. It is a 5 x 20 mm 250 V, 3.15 A slow blow 50T glass fuse.



To remove the fuse holder and access the fuse, use a flat head screw driver and turn counter-clockwise. Similarly, push the fuse holder inward and turn clockwise to replace the fuse.

A third fuse is located inside the instrument which protects the 10 A input terminal if the input current exceeds the maximum rating. It is a 6 x 32 mm 250 V, 12 A fast blow fuse.

2.3 Carrying Handle Adjustment

To adjust the position, grasp the handle on both sides of the instrument at the pivot point and rotate the handle to the desired position. Be sure the handle locks in its new position.

Bench Operation

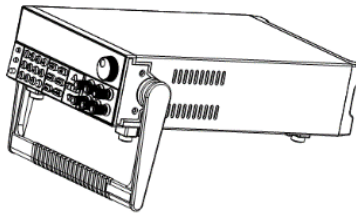
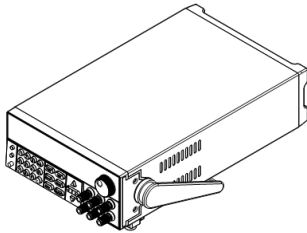

Handle transport position



⚠ WARNING

Be sure the handle is locked in position and avoid twisting movements while transporting as the handle can damage and drop the instrument.

3 Front Panel Operation

This chapter covers available function settings and how to make basic measurements.

3.1 Front Panel Menu Reference

Key	Usage
DCV(DCI)	To configure the DC voltage measurement, including DC ratio measurement Range: 100mV, 1V, 10V, 100V, 1000V Range is set to Auto by default NPLC: {0.02, 0.2, 1, 10, 100} Default: 10 PLC Auto zero setting: OFF or ON (default: ON) Input impedance: 10M or HighZ (>1G) DC ratio: OFF (default) or ON
Shift + DCV(DCI)	To configure the DC current measurement Range: 3 A terminal (100uA, 1mA, 10mA, 100mA, 1A, 3A) auto range (default) 10A port 10A range NPLC: {0.02, 0.2, 1, 10, 100} Default: 10 PLC Range is set to Auto by default NPLC: {0.02, 0.2, 1, 10, 100} Default: 10 PLC Auto zero setting: OFF or ON (default: ON)
ACV(ACI)	To configure the ACV AC voltage Range: Auto (default), 100mV, 1V, 10V, 100V, 750V Filter: 3Hz (slow speed) 20Hz (medium, slow speed) 200Hz (fast, medium and slow speed) Default: 20Hz filter, medium speed
Shift + ACV(ACI)	To configure the ACV AC current measurement Test terminal: 3 A 10 A Range: 3 A terminal (100uA, 1mA, 10mA, 100mA, 1A, 3A) auto range (default)10 A port 10 A range Filter: 3Hz (slow speed) 20Hz (medium, slow speed) 200Hz (fast, medium and slow speed) Default: 20Hz filter, medium speed
Ω 2W(Ω 4W)	To configure the two-wire resistance test Range: Auto Range (default) {10 Ω , 100 Ω , 1k Ω , 10k Ω , 100k Ω , 1M Ω , 10M Ω , 100M Ω } NPLC: {0.02, 0.2, 1, 10, 100} Default: 10 PLC Auto zero setting: OFF or ON (default: ON)
Shift + Ω 2W(Ω 4W)	To configure the four-wire resistance test Range: Auto Range (default) {10 Ω , 100 Ω , 1k Ω , 10k Ω , 100k Ω , 1M Ω , 10M Ω , 100M Ω }

	NPLC: {0.02, 0.2, 1, 10, 100} Default: 10 PLC
Freq (Temp)	To configure the frequency and period measurements Filter: 3 Hz, 20 Hz, 200 Hz Gating time: 10ms, 100ms (default), 1s
Shift + Freq (Temp)	To configure the temperature test Probe type: two-wire test (default) or four-wire test R0: resistance at 0 °C, default: 100 Ω NPLC: {1, 10, 100} Default: 10 PLC Unit: °C, °F, K,
Cont (diode)	Conduction (continuous) configuration Test range: 1 kΩ Test current: 1 mA Buzzer: ON (default) or OFF Door threshold: default 10 Ω, can be set separately
Shift + Cont (diode)	Diode configuration Test voltage range: 0~5V Test current: 1 mA Buzzer: ON (default) or OFF
CAP(MATH)	Capacitance measurement configuration Range: Auto (default) {1nF, 10F, 100nF, 1uF, 10uF, 100uF, 1mF, 10mF}
Shift+ CAP(MATH)	Math zero calculation (NULL), you can set parameters dB/dBm operation smoothing scal: Mx+b, Percent Statistics, Limit
NULL (PrtScn)	Mathematical zeroing calculation, the calculated value is the current measured data
Shift+NULL (PrtScn)	Print the picture and save the current display interface
R/S	Run or Stop
Trigger	Single trigger
Menu	Menu Settings Display: display settings Acquire: trigger option Utility: general function

3.2 Display

The multimeters display can be set to number, bar meter, trend chart, or histogram. By default, the meter will be set to number display.

3.2.1 Change Display Mode

To change the display mode, press Menu → Display → Display to access the display options. Use the softkey to select the desired display mode.



Bar Meter



The bar meter displays live measurements on a horizontal bar graph. Press 'Auto Scale' to automatically adjust the upper and lower limits or set the limits manually using. Use the softkeys and directional keypad to adjust the Low/High values.

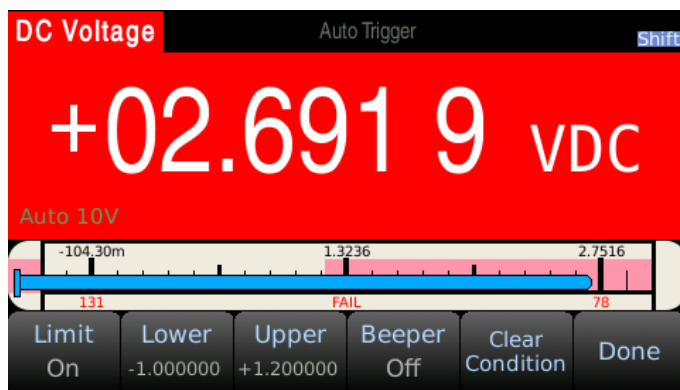

The bar meter display mode can also be enabled with Limit mode. The upper and lower limits are displayed on the bar meter in red.

Trend Chart

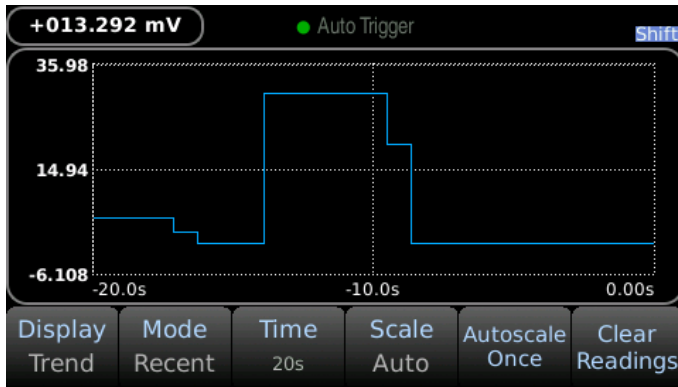

The trend chart plots data as a trend line over time. The mode can be changed to display recent data where the time in seconds before present can be adjusted. Press the 'Scale' softkey to then select 'Manual' and use the directional keypad to adjust top/bottom boundaries.

Histogram

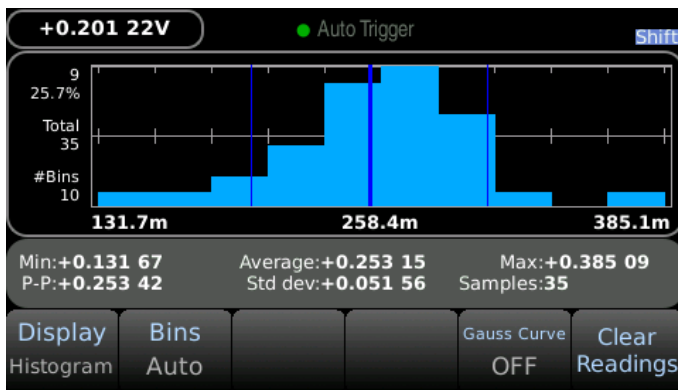

The histogram display mode groups data into bins represented graphically in vertical bars. By default the Bin count is set to Auto. The Bin count can be changed manually to 10, 20, 40, 100, 200, or 400. When using manual Bins, the high/low bounds can be adjusted using the directional keypad. When statistics are displayed in histogram mode, the dark blue line in the middle represents the average, and the outside blue lines represent one standard deviation from the average.

3.2.2 Display Label Text

Label text can be added to the measurement display. To set label text and display a label, press Menu → Display → Label Text and use the on-screen keyboard to enter text. Press 'Done' then press the softkey for 'Label OFF/ON' to display the text.

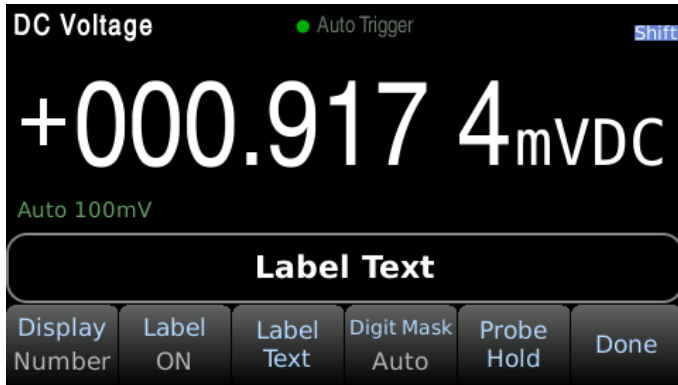

3.2.3 Digit Mask

The number of display digits can be changed manually. By default, the digit mask will change automatically based on other function settings and PLC settings.

To change the digit mask press Menu → Display → Digit Mask.



3.2.4 Probe Hold Function

The probe hold function records and displays up to 8 stable measurements adding them to an on-screen list. To enable this function, press Menu → Display → Probe Hold → Probe Hold OFF/ON. In the probe hold settings, the beeper can be enabled to output an audible beep when a stable reading is recorded and added to the list. Note: the screen capture function can be used to save the displayed list of measurements as an image.



3.2.5 Screen Capture and File Transfer

Press **Shift** then press **PrtScn** **Null** to save a screen capture to the multimeters internal memory as a .png file. Screen captures can be transferred from internal memory to a USB flash drive using the built-in file management system. Press Menu → Utility → Manage Files to access stored files. Use the directional keypad to highlight the file to be transferred then press Copy. Highlight the USB resource then press Paste to save a copy of the file.

3.3 Basic Measurements

3.3.1 DC Voltage

Step 1: Connect the input terminals as shown below.

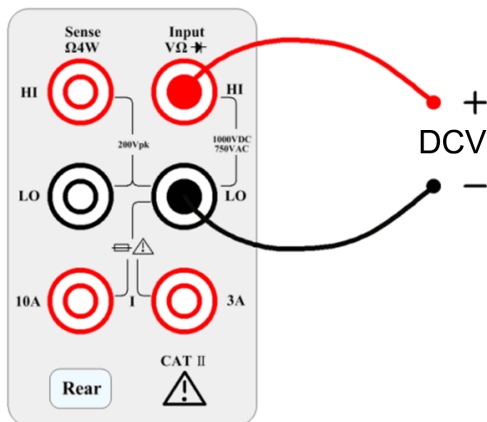

WARNING



Do not apply more than 1000 V peak to the input or it will damage the instrument.

Step 2: Press the **DCV** button on the front panel to enter the DCV measurement function.

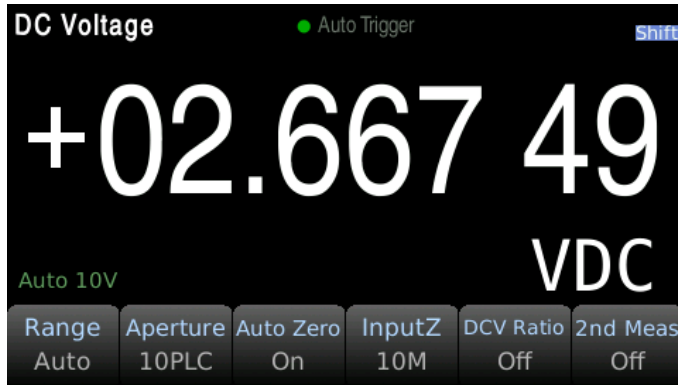

Step 3: Range selection.

Press Range and select the range. Auto range (Auto) can automatically select the appropriate range for measurement based on the input signal. The auto range is adjusted upwards to 120% of the existing range and down to 10% of the existing range.



Step 4: Set the integration time.

The setting of the integration time affects the measurement speed and measurement accuracy. The longer the integration time, the higher the accuracy but the slower the measurement. 1PLC, 10PLC, and 100PLC can inhibit noise. Selecting 100PLC can provide the best noise rejection, but at a slower rate.

Step 5: Auto Zero.

Auto-zeroing results in more accurate measurements but requires more test time. With auto zero enabled, the digital multimeter measures the offset once and subtracts the offset from all subsequently measured parameters. This avoids the effect of the offset voltage on the input circuit of the digital multimeter on the measurement accuracy. The DMM makes a new offset measurement each time you change the function, range, or integration time. The default state is ON.

Step 6: Input Z internal resistance selection

Select the data input impedance. The input impedance can be automatic or 10MΩ. Automatic mode selects high impedance (HighZ), which is appropriate for 100 mV, 1 V, 10 V ranges. The internal resistance of the 100 V and 1000 V ranges is fixed at 10 MΩ.

Note: When attempting to measure a unipolar AC+DC signal in DCV mode, manual ranges should be used for best accuracy.

3.3.2 DCV Ratio

The DCV Ratio measurement function takes the ratio between two DC voltage measurements. The ratio is calculated by dividing the input voltage (DCV1) by a reference voltage (DCV2), refer to Figure 3.2.2 – DCV Ratio below.

Step 1: Properly connect the input terminals as shown:

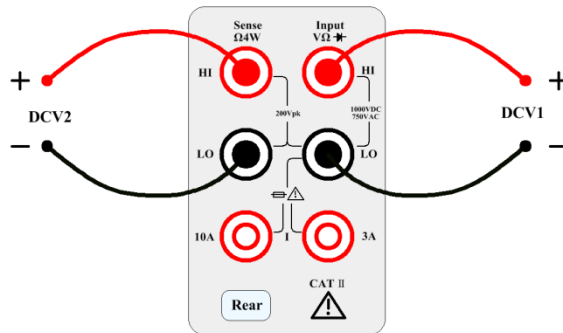
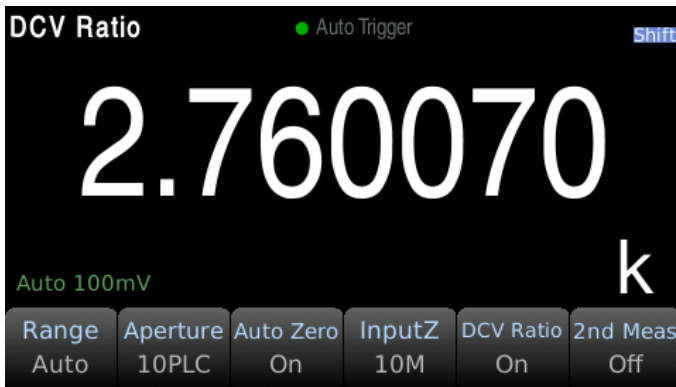

Figure 3.2.2 – DCV Ratio

Step 2: Turn on the DCV Ratio function. In DCV mode, enable DCV Ratio by pressing the softkey.



3.3.3 AC Voltage

This section describes how to configure the 5490C Series for AC voltage measurements. In order to get the most accurate measurement, the corresponding RC time constant must be stable to 1/50 of the input AC signal level.

Signals greater than 300 V (RMS) or 1 A (RMS) can cause self-heating of the signal conditioning components. These errors are included in the instrument's specifications. Internal temperature changes caused by self-heating may cause additional errors in other functions or ranges. Additional errors typically disappear within a few minutes. Example: Consider a 100 VAC signal with a 5 VDC bias voltage as an example, the 5 VDC bias voltage should be stable at 1/50 of 100 VAC or 2 VDC.

Calculate the corresponding settling time using the RC time constant 0.22 s:

$$\text{settling time} = \ln(\text{bias}/\text{settled value}) * 0.22 \text{ s}$$

$$\text{settling time} = \ln(5 \text{ VDC} / 2 \text{ VDC}) * 0.22 \text{ s}$$

$$\text{settling time} = 0.20 \text{ s}$$

The ACV function should be selected after the signal is connected to the digital multimeter's ACV input or when the signal has been connected, enough extra delay should be given to stabilize the signal. If the DC bias remains the same, a completely accurate subsequent measurement can be made without additional stabilization delay.

Step 1: Configure the test leads as shown below.

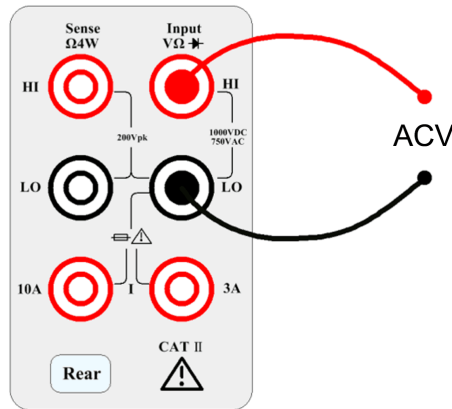

Step 2: Press the ACV button on the front panel to enter the ACV function interface.



Step 3: Range adjustment.

Press Range and select the range. Auto range (Auto) automatically selects the appropriate range for measurement based on the input signal. The auto range is adjusted upwards to 110% of the existing range and down to 10% of the existing range.



Step 4: AC Filter Selection.

The instrument offers three filter options consisting of 3Hz, 20Hz and 200Hz. The filter you choose should be the highest filter which is less than the frequency of your test signal.

For example, if the input signal is 300 Hz, the stable data can be obtained using the 200 Hz filter.

Step 5: Speed selection.

Filter	Slow	Medium	Fast
3Hz	√	–	–
20Hz	√	√	–
200Hz	√	√	√

Each filter has a different test speed, choosing the right measurement speed based on the filter will result in more accurate test results and/or faster test speeds.

3.3.4 DC Current

Step 1: Using either the 3 A or 10 A input terminal, configure the test leads as follows:

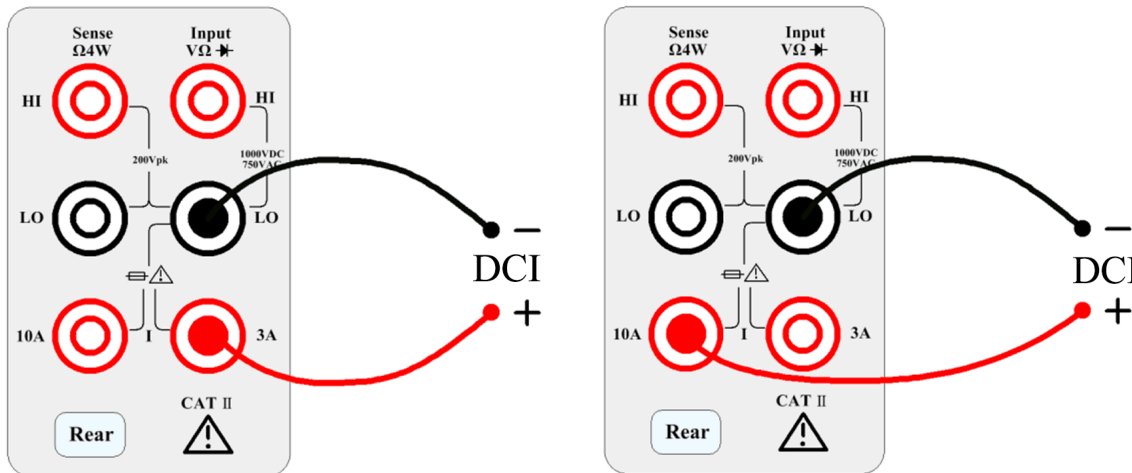

Use the 10 A terminal for current measurements greater than 3 A.

Step 2: Press **Shift** on the front panel then press **DCV** to select the DCI function and enter the DCI function interface.

Step 3: Range adjustment.

Select the input terminal for the test signal. If you select 10 A input terminal, there is only 10 A range. If you select 3 A input terminal: 100 uA, 1 mA, 10 mA, 100 mA, 1 A, 3 A, or Auto ranges are available. Select the range using the softkeys:

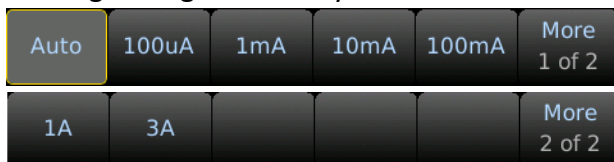

Step 4: Set the integration time.

The setting of the integration time affects the measurement speed and measurement accuracy. The longer the integration time, the higher the accuracy but the slower the measurement.

PLC (power-line cycle) 1PLC, 10PLC, 100PLC can inhibit AC input noise. Selecting 100PLC can provide

the best noise rejection, but at a slower rate.



Step 5: Auto Zero.

Auto-zeroing results in more accurate measurements but requires more test time. With auto zero enabled, the digital multimeter measures the offset once and subtracts the offset from all subsequently measured parameters. This avoids the effect of the offset voltage on the input circuit of the digital multimeter on the measurement accuracy. The DMM makes a new offset measurement each time you change the function, range, or integration time. The default state is ON.

3.3.5 AC Current

Step 1: Using either the 3 A or 10 A input terminal, configure the test leads as follows:

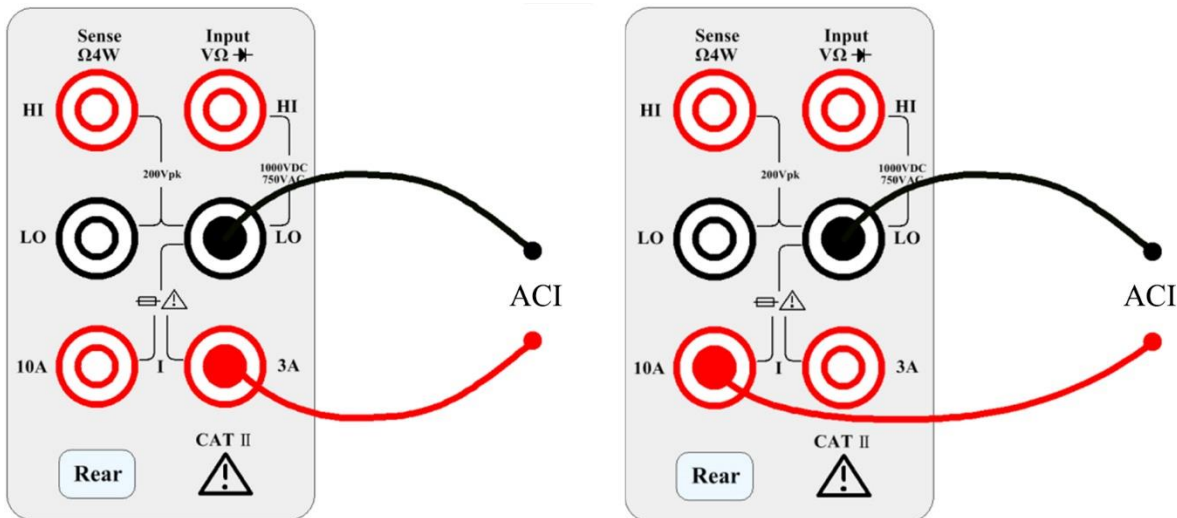

Use the 10 A terminal for current measurements greater than 3 A.

Step 2: Press **Shift** then press **ACV** on the front panel to enter the ACI test interface.

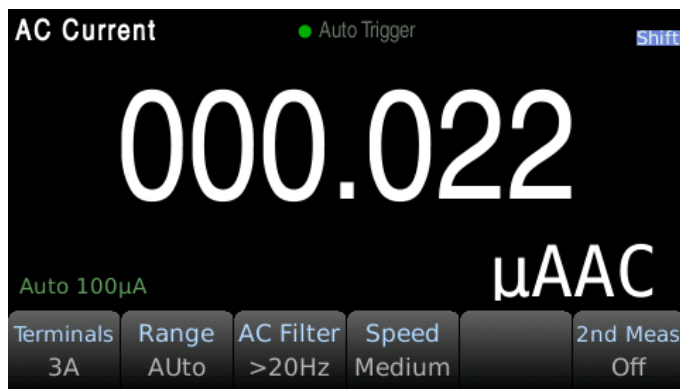

Step 3: Range adjustment

Use the softkeys to select the range. Auto range (Auto) can automatically select the appropriate range for measurement based on the input signal. The auto range is adjusted upwards to 110% of the existing range and down to 10% of the existing range.

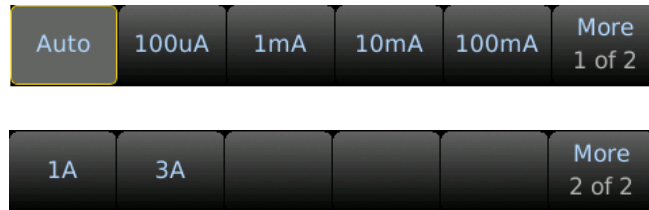

Step 4: AC Filter Selection

The instrument offers three filter options of 3Hz, 20Hz and 200Hz. The filter you choose should be the highest filter which is less than the frequency of your test signal. For example, if the input signal is 300Hz, the stable data can be obtained using the 200 Hz filter.

Step 5: Speed selection

Filter	Slow	Medium	Fast
3Hz	√	-	-
20Hz	√	√	-
200Hz	√	√	√

Different filters have different test speeds, so choosing the right measurement speed based on the filter can result in more accurate test results or faster test speeds.

3.3.6 Resistance 2W (2-wire)

Step 1: Configure the test leads as follows:

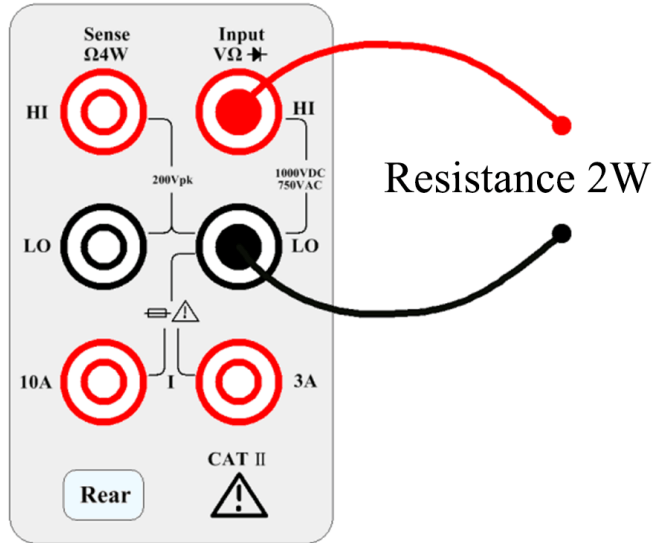

Step 2: Press $\Omega 2W$ on the front panel to enter the two-wire resistance test interface.

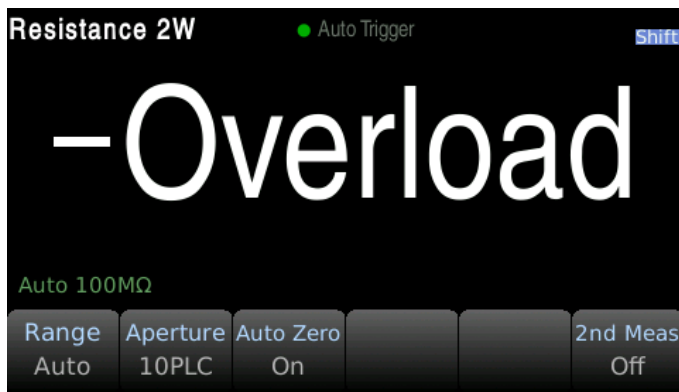

Step 3: Select the range.

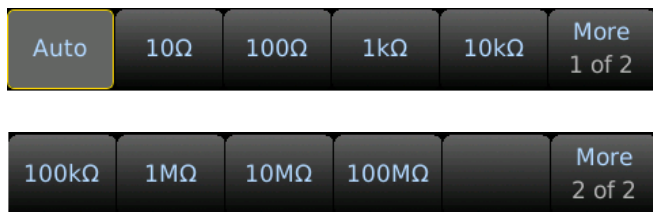

Press Range and select the range. Auto range (Auto) can automatically select the appropriate range for measurement based on the input signal. The auto range is adjusted upwards to 110% of the existing range and down to 10% of the existing range.

Step 4: Set the integration time.

The setting of the integration time affects the measurement speed and measurement accuracy. The longer the integration time, the higher the accuracy but the slower the measurement. PLC (power-line cycle) 1PLC, 10PLC, 100PLC can inhibit AC input noise. Selecting 100PLC can provide the best noise rejection, but at a slower rate.



Step 5: Auto Zero.

Auto-zeroing results in more accurate measurements but requires more test time. With auto zero enabled, the digital multimeter measures the offset once and subtracts the offset from all subsequently measured parameters. This avoids the effect of the offset voltage on the input circuit of the digital multimeter on the measurement accuracy. The DMM makes a new offset measurement each time you change the function, range, or integration time. The default state is ON.

3.3.7 Resistance 4W (4-wire)

Step 1: Configure the test leads as follows:

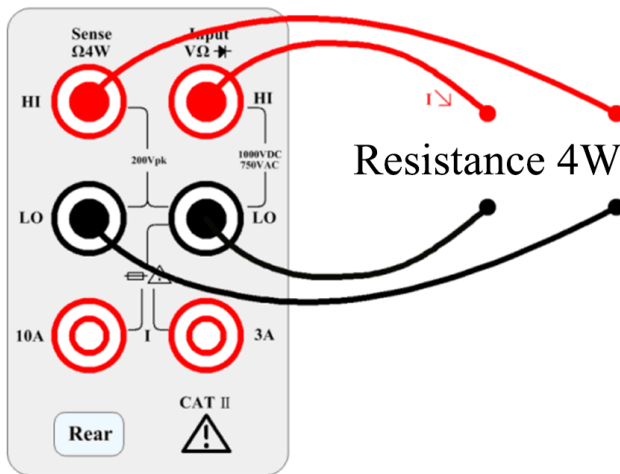

Step 2: Press **Shift** then press **Ω2W** on the front panel to enter the four-wire resistance test interface.

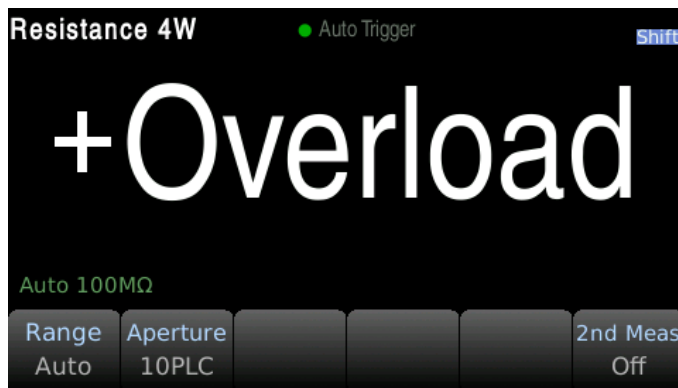

Step 3: Select the range.





Press Range and select the range. Auto range (Auto) can automatically select the appropriate range for measurement based on the input signal. The auto range is adjusted upwards to 110% of the existing range and down to 10% of the existing range.

Step 4: Set the integration time.

The setting of the integration time affects the measurement speed and measurement accuracy. The longer the integration time, the higher the accuracy but the slower the measurement. PLC (power-line cycle) 1PLC, 10PLC, 100PLC can inhibit AC input noise. Selecting 100PLC can provide the best noise rejection, but at a slower rate.



3.3.8 Capacitance Measurement

Step 1: Configure the test leads as follows:

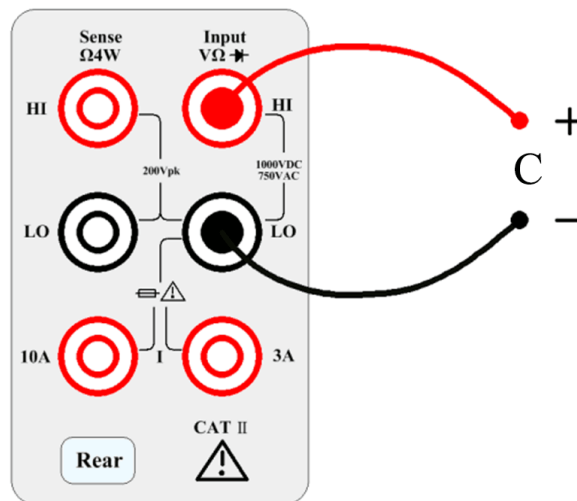

Step 2: Press  on the front panel to enter the capacitance function interface.

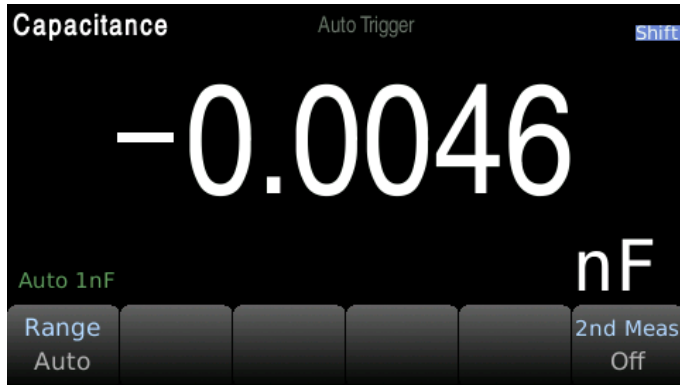

Step 3: Select the range.

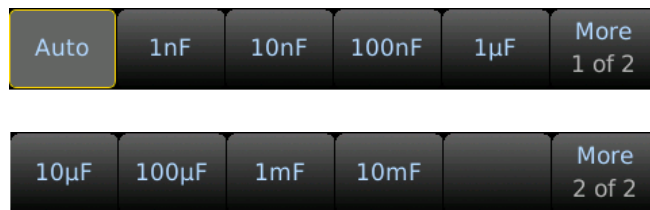

Press Range and select the range. Auto range (Auto) can automatically select the appropriate range for measurement based on the input signal. The auto range is adjusted upwards to 110% of the existing range and down to 10% of the existing range.

3.3.9 Diode

This section describes how to configure the diode test from the front panel. The range and resolution are fixed and the range is 10 VDC with 1 mA current source output.

Step 1: Configure the test leads as follows:

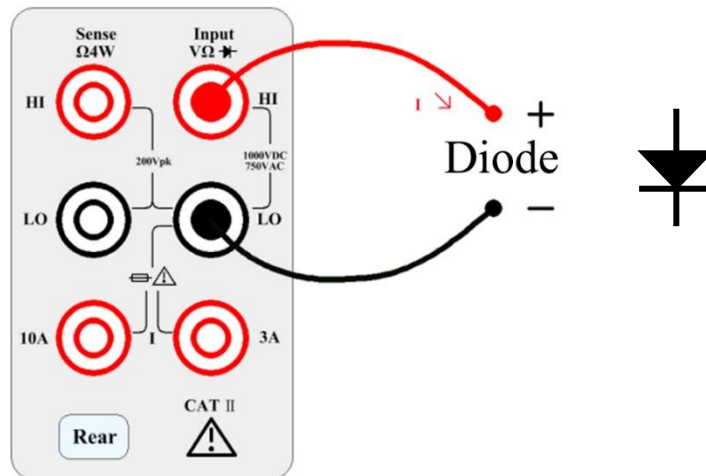

Step 2: Press **Shift** then press **Cont** on the front panel to enter the diode test interface.

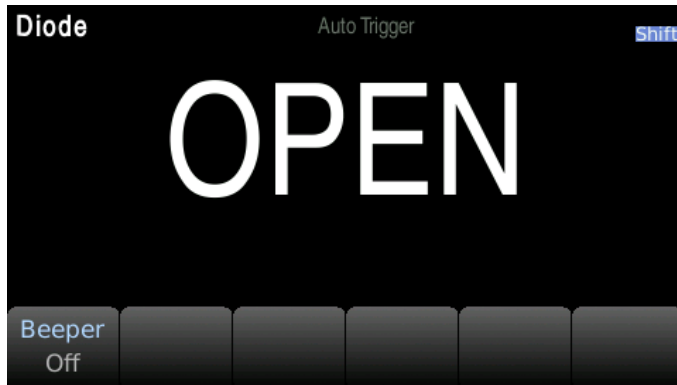

When converted to a 0.3V to 0.8V threshold, the instrument beeps (if a beep is enabled). A voltage of 0 to 5V is displayed on the front panel. When the measured break-over voltage is greater than 5V, the front panel will display OPEN.

3.3.10 Continuity

This section describes how to configure the continuity test from the front panel.

Step 1: Configure the test leads as follows:

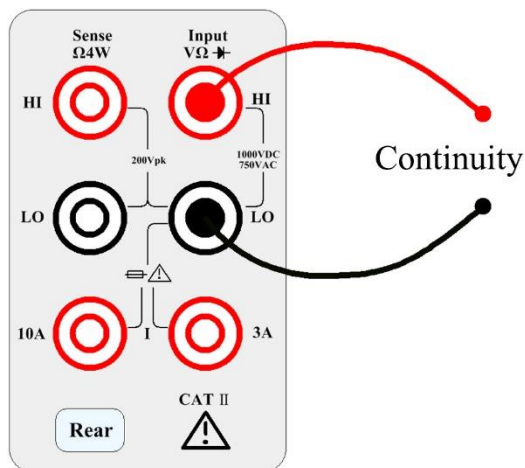

Step 2: Press **Cont** on the front panel to open a menu that specifies whether the digital multimeter will beep to indicate the continuity.

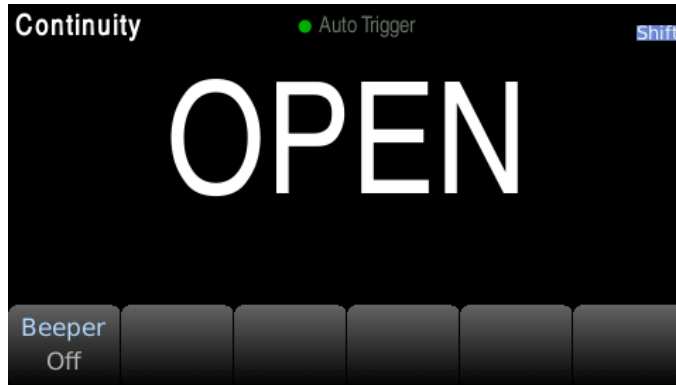

The continuity measurement behavior is as follows:

$\leq 10 \Omega$	Display the measured resistance and beeps (if the beeper is enabled).
10 Ω to 1.2 k Ω	Display measured resistance, no buzzer.
> 1.2 k Ω	Display OPEN (ON), no buzzer.

3.3.11 Temperature test

This section describes how to configure 2-wire and 4-wire temperature measurements from the front panel. Temperature measurements require a temperature transducer probe.

Step 1: Configure the test leads as follows:

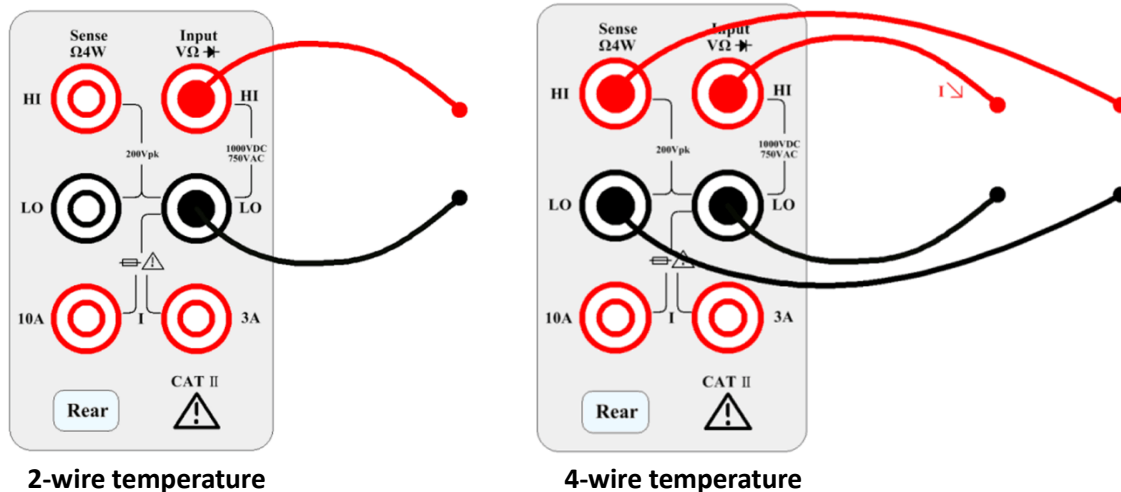

Step 2: Press **Shift** then press **Freq** on the front panel. The following menu will appear. Please note that Auto Zero is only available for 2-wire measurements.

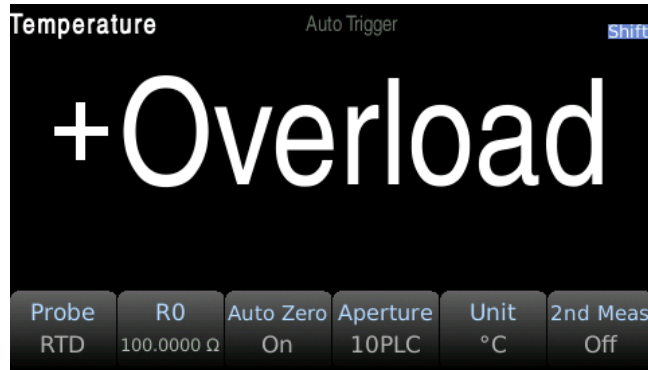

Step 3: Press Probe to select the probe type. If you choose to use RTD, this menu will have a softkey to specify the resistance of the RTD at 0 degrees Celsius (R0).

Step 4: Specify if you want to use Auto Zero. Auto-zeroing provides the most accurate measurements but takes more time to perform a zero measurement.

With auto zero enabled, the digital multimeter internally measures the offset after each measurement. This prevents the offset voltage on the digital multimeter (DMM) input circuit from affecting the measurement accuracy. With auto zero disabled, the digital multimeter measures the offset once and subtracts the offset from all subsequently measured parameters. The DMM makes a new offset measurement each time you change the function, range, or integration time.

Step 5: Press Aperture and select the number of power line cycles (PLC) to measure. Normal mode (line frequency noise) suppression is only available for 1, 10, and 100 PLCs. Selecting 100 PLCs provides the best noise rejection and resolution, but the measurement is the slowest.

Step 6: Use the Unit softkey to display Celsius, Fahrenheit, or Kelvin.

3.3.12 Frequency measurement

This section describes how to configure frequency and period measurements from the front panel.

Step 1: Configure the test leads as shown below.

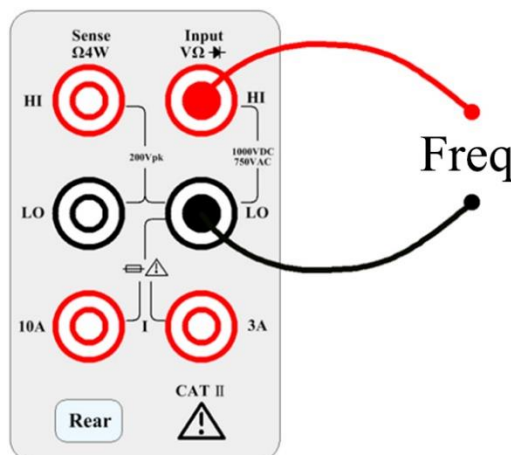

Step 2: Press the  button to enter the frequency measurement.

Use the Type softkey to select frequency or period measurement. Freq is the frequency measurement and Period is the period measurement.

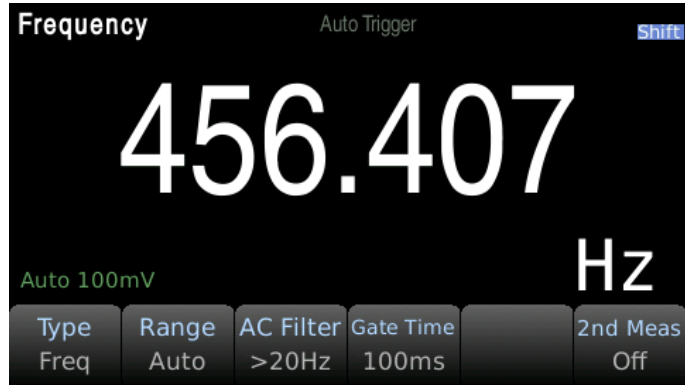

Step 3: Range adjustment

Press Range and select the range. Auto range (Auto) can automatically select the appropriate range for measurement based on the input signal. The auto range is adjusted upwards to 110% of the existing range and down to 10% of the existing range.



Step 4: AC Filter Selection.

The instrument offers three filter options of 3Hz, 20Hz and 200Hz. The filter you choose should be the highest filter which is less than the frequency of your test signal. For example, if the input signal is 300Hz, the stable data can be obtained using the 200 Hz filter.

Step 5: Speed selection.

Filter	Slow	Medium	Fast
3Hz	√	-	-
20Hz	√	√	-
200Hz	√	√	√

Different filters have different test speeds, so choosing the right measurement speed based on the filter can result in more accurate test results or faster test speeds.

4 Secondary Measurement



Several measurement functions support secondary measurements. Secondary display measurements

are only available when using Number or Bar Meter display modes only.

Primary measurement function	Available secondary measurement function(s)
DCV	BeforeMath
DCI	BeforeMath
ACV	BeforeMath, Frequency
ACI	BeforeMath, Frequency
2W, 4W Resistance	Before math
Frequency	BeforeMath, AC Voltage, Period
Temperature	BeforeMath, Resistance
Capacitance	BeforeMath

The BeforeMath secondary function displays raw measurement values when a Math function is applied to the primary measurement.

5 Math Functions

Press  then press  to enter the math settings interface.



5.1 Null Operation

When using the Null function, the instrument takes the existing reading as a reference value, and the subsequent readings subtract the reference value based on the actual input value.

Display reading = actual reading – reference value

Different measurement functions can set different reference values; once the reference value is set, the reference values are the same for all ranges under the function.

Using the Null function does not increase the maximum allowed input signal for this range.

Set a user-defined null value using the softkeys and cursor navigation keys.

5.2 Statistics

Display the minimum (Min), maximum (Max), peak-to-peak (P-P), average (Average), standard deviation (Std dev), and the total number of samples in the reading buffer.

The reading buffer can hold up to 10,000 data samples. When the reading buffer overflows, the oldest data will be discarded. Press 'Clear Readings' using the softkey to reset the reading buffer.

5.3 Limit

The limit test allows the user to perform a Pass/Fail test. By setting the upper and lower limit values, the results will display the amount of Low and High failures. Use the softkeys to adjust Lower and

Upper limits. Set the limits by using the cursor navigation keys and  button.

5.4 dB Calculation

The dB and dB math functions apply to DC V and ACV measurements only. This function allows measurements to be scaled relative to a reference value.

Each dB measurement is the difference between the input signal and the stored reference value (both converted to dBm): $\text{dB} = \text{reading in dBm} - \text{reference value in dBm}$

The relative value must be between -200 and +200 dBm (default is 0). You can measure this value by pressing 'Measure Ref Value' or input a specified value using the softkeys.

5.5 dBm Calculation

The dBm function is a logarithmic expression that compares the power delivered to the reference resistance, relative to 1 mW:

$$\text{dBm} = 10 \times \log_{10} (\text{reading}^2 / \text{reference resistance} / 1 \text{ mW})$$

5.6 mX+b

The calculation of reading X on screen is performed as follows:

$$Y = mX + b$$

Where,

X is the normal display reading on the screen

m and b are the user-entered values

Y is the displayed result

5.7 Percent

If the percent calculation is selected, a reference value must be specified. The percentage calculation is performed as follows:

$$\text{Percent} = \frac{\text{Input} - \text{Reference}}{\text{Reference}} \times 100\%$$

- Input is the measured reading
- Reference is the user-entered constant
- Percent is the displayed result

6 Save / Recall

Measurement readings or instrument setting configurations can be saved into the instruments nonvolatile memory or a USB flash drive connected to the front panel USB host port.

6.1 Save Readings

This function saves measurement data stored in the instrument buffer.

Press Menu → Utility → Save / Recall to access the Save / Recall settings then press Save Reading to access the file management system. Use the softkeys and navigation keys to select a save location and file type (.csv, .dat, or .txt). The folder named 'files' is the instruments nonvolatile memory. If a USB flash drive is connected on the front panel, it will be displayed as 'usb'. Folders and filenames can also be modified. The save action can be set to 'New' to create a new file or 'Replace' to overwrite an existing file. Press the 'Save Readings' softkey to complete the save process.

6.2 Save Settings

This function saves the current instrument state such as function selected and function settings.

Press Menu → Utility → Save / Recall to access the Save / Recall settings then press Save Settings to access the file management system. Use the softkeys and navigation keys to select a save location and file type (.sta or .prf). The folder named 'files' is the instruments nonvolatile memory. If a USB flash drive is connected on the front panel, it will displayed as 'usb'. Folders and filenames can also be modified. The save action can be set to 'New' to create a new file or 'Replace' to overwrite an existing file. Press the 'Save Settings' softkey to complete the save process.

6.3 Recall Settings

This function recalls instrument states stored in the instruments nonvolatile memory or on a USB flash drive.

Press Menu → Utility → Save / Recall to access the Save / Recall settings then press Recall Settings to access the file management system. Use the navigation keys to highlight an instrument state file which have a .sta or .prf file extension. Press the 'Recall' softkey to complete the recall process.

6.4 Power On

This function sets the instrument power on state which can be set to last, factory default, or a user defined state. Press Menu → Utility → Save / Recall to access the Power On settings. By default the power on state will be set to 'Last'. To set a user defined power on state, an instrument state file saved as .sta must first be saved to the instruments internal memory or on a USB flash drive. See section 6.2 *Save Settings* above for details on how to save an instrument state file. After a state file is created set the 'Power On' settings to 'User Defined' using the softkeys. Select an instrument state file using the 'User File' softkey which will be enabled when the power on state is set to user defined as shown:

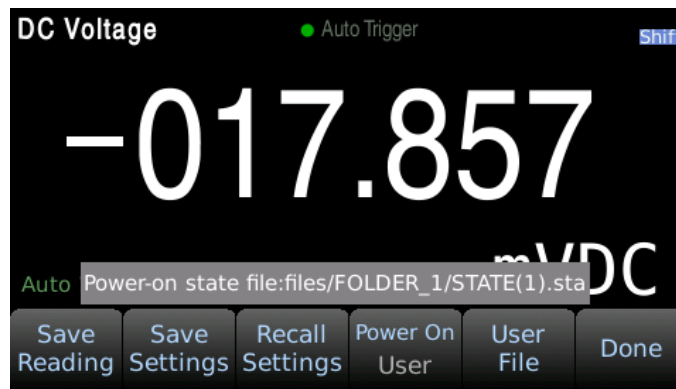

7 System Settings

7.1 Set the language

Press Menu → Utility → System → User Settings → Language to switch the language.

The language can be set to English or Chinese.

7.2 Setting the date/time

Press Menu → Utility → System → Date Time to set the date and time.

Note: Setting the second is not supported using the front panel. The second can be set using the command SYST: TIME <hour>, <minute>, <second> can be used.

7.3 Setting the buzzer and brightness

Press Menu → Utility → System → User Settings to enter the setup menu to set the sound and brightness.

Beeper and Key Click are independent and do not affect each other.

In order to prevent the screen from being completely black, the minimum brightness is 20.

Tip: You can quickly adjust the brightness by using the  then pressing up or down keys.

7.4 Setting the format of the digital display

Press Menu → Utility → System → User Settings → Number to set the format of the digit display.

In order to support the digital format commonly used in the U.S. and Europe, you can choose the decimal point and separator type.

- The decimal point can be set to '.' (Period) or ',' (Comma).
- The separator can be a space, ',' or '.' (On), or no separator (None).

8 Interface

8.1 RS232 interface

RS232 standard, also called asynchronous serial communication standard, has already been widely used for data communication between computers and external equipment.

The most commonly used RS232 signals are shown in the table:

Signal	Code	25 Pin Connector Pin number	9 Pin Connector Pin number
Request To Send	RTS	4	7
Clear To Send	CTS	5	8
Data Set Ready	DSR	6	6
Data Carrier Detect	DCD	8	1
Data Terminal Ready	DTR	20	4
Transmitted the data	TXD	2	3
Receive the data	RXD	3	2
Grounding	GND	7	5

The RS232 interface on the 5490C Series uses a 9-pin DB9 connector. The pinouts are defined in the table below:

Function	Code	Pin Connector Pin Number
Transmitted Data	TXD	3
Received Data	RXD	2
Signal Ground Common	GND	5



Rear panel connector

It can be directly connected to it using a standard DB type 9-pin plug.

8.1.1 RS232 Interface Operation

(1) Connection

Pin connection diagram between 5492C/5493C and a computer shown in figure:

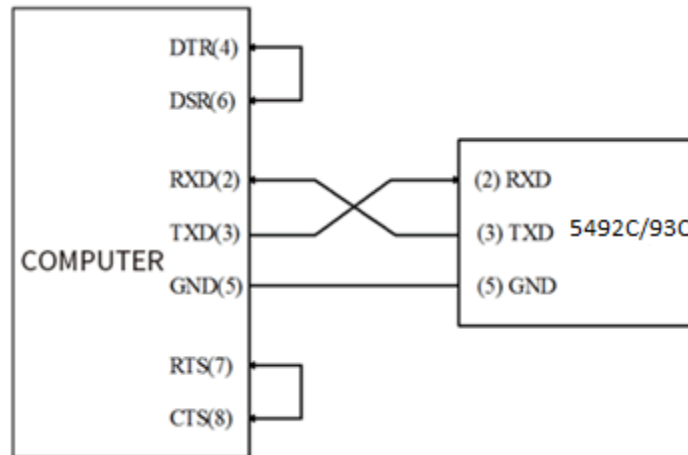

RS232 Connection Diagram

Users can use the double-core shielded cable to make a three-wire connection cable (the length should be less than 1.5m).

When making the connection cable, pins 4-> 6 and pins 7-> 8 should be shorted at the computer connector.

(2) Sending and receiving data format

The 5492C/5493C uses full-duplex asynchronous communication transmission mode with a start bit and stop bit.

The data transmission format of RS232 is:

- Data bits: 8
- Stop bit: 1
- Parity: None
- Termination character: <LF> (newline, ASCII code is 10)

(3) Selecting Baud Rate

The baud rate is the rate at which Model 5492C/5493C multimeter and the computer communicate. Choose one of these available rates:

- 115200
- 57600
- 38400
- 19200
- 9600
- 4800

Note: Factory default baud rate is 9600.

Before you choose a baud rate, make sure the programming terminal that you are connecting to the 5492C/5493C can support the baud rate you selected.

(4) Configure the serial communication

Press Menu → Utility → I/O config to enter the port configuration interface. Select the RS232 option to configure RS232 communication.

Select the Baudrate option to set the baud rate.

Select Data bits to select the data bits.

Parity: Select the check mode. There is no check bit by default.

Stop bits: set the stop bit, default 1 bit.

(5) Software Protocol

Since the hardware communication check (handshaking lines CTS and RTS) is not used in the RS232 interface, the multimeter uses the character return method to reduce the possibility of data loss or data error in the communication. Please refer to the following when compiling computer communication software:

1. For command syntax and format, refer to Chapter 8 Command Reference.
2. The controller transmits the command using the ASCII code with <LF> as the terminal character. The multimeter executes the command after the terminal character is received.
3. The character received by the multimeter will be sent back to the controller again. The controller will not send the next character until the last returned character is received correctly from the multimeter. If the controller fails to receive the character sent back from the multimeter, the possible reasons are listed as follows:
 - The serial interface is not connected correctly.
 - Check if the multimeter has opened the RS232 interface function and the baud rate is selected correctly.
 - When the multimeter is busy with executing a bus command, it will not accept any character from the serial interface at the same time. So the character sent by the controller will be ignored. In order to make sure the whole command is sent and received correctly, the character without a return character should be sent again by the controller.
4. The multimeter only sends information under the following two conditions.
 - When a character is received normally, the multimeter will send the character back as a handshake.
 - When a query command is received, the multimeter will send the query response information.
5. Once a query command is received, the multimeter will send the query response information immediately even if the rest commands have not been finished. So if the command includes two queries, the controller should read the query responses twice. One query is recommended to be included in a single command.
6. A query response is sent out in ASCII codes with the preset terminal character.
7. Several query responses will be sent continuously with a 1ms interval. The controller should be ready to receive the responses; otherwise the response information will be lost.
8. The controller should receive the query response terminal character. Otherwise you will confuse a terminal character with a returned character. At the same time the controller should receive the

last returned character before receiving a query response.

9. For some commands that will take a long time to execute, for example reset command, the controller should keep waiting to avoid the next command being lost when 5492C/5493C is executing the previous command.
10. Communication software compiled with DOS application software should run under the pure DOS environment supporting serial port. If it is running under WINDOWS, it may cause errors due to different management methods of the serial port.

8.2 USB Interface

This instrument has a USB Device and USB Host port. USB Device serves as the communication interface, that is, the instrument is used as a device. The USB interface on the front panel is used to read the USB flash drive, the instrument is used as the host.

8.2.1 USB Device

The 5490C Series can communicate with a PC through the USBTMC protocol. This multimeter uses a square type socket on the rear panel with the following pin sequence:



This unit uses a USB-B type interface, which can communicate via a standard square USB interface cable. There are no settings in the menu system for USB configuration. The only requirement is that a USBTMC driver is installed. A USBTMC driver is included with VISA software.

8.2.2 USB Host

The instrument acts as a host to read and write data in the U disk.

Press Menu → Utility → Manage Files to copy and paste files between the instrument and a connected flash drive.

8.3 LAN Interface

You may need to set a few parameters to use the LAN interface to establish network communication. First, you need to create an IP address. You may need the help of your network administrator during the process of establishing communication with the LAN interface.

Press Menu → Utility → I/O Config → LAN to Enter LAN Settings Screen. You can select **Modify** to

change the settings or restore LAN settings to its default values. Some LAN setup functions can only be performed through SCPI. See SYSTEM Subsystem - I/O Settings for all LAN configuration commands.

8.4 GPIB Interface

This section will introduce the GPIB bus standards, connection methods, and some settings of the instrument. This section only applies to GPIB models: 5492CGPIB and 5493CGPIB.

8.4.1 GPIB Bus

IEEE488 (GPIB) is an international bus interface standard used on intelligent instruments. IEEE is the English abbreviation of Institute of Electrical and Electronics Engineers, and 488 is the standard number. Multiple test instruments can be connected simultaneously on the same bus. This instrument adopts the IEEE488.2 standard. The control command system is open so that the user can use the PC operation interface provided by 5492CGPIB/5493CGPIB or take measurements by the control command system. The control command system supports most functions of the instrument, that is to say, the user can execute almost all operations on PC.

When configuring a GPIB system, the following restrictions must be adhered to.

- 1 · The total length of cable in one bus system must be less than or equal to two meters times the number of devices connected on the bus (the GPIB controller counts as one device) and the total length of cable must not exceed 20 meters.
- 2 · A maximum of 15 devices can be connected to one bus system.
- 3 · There are no restrictions on how the cables are connected together. However, it is recommended that no more than four piggyback connectors be stacked together on any one device.

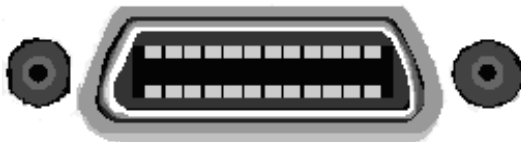

Method 1 of GPIB cable connection:

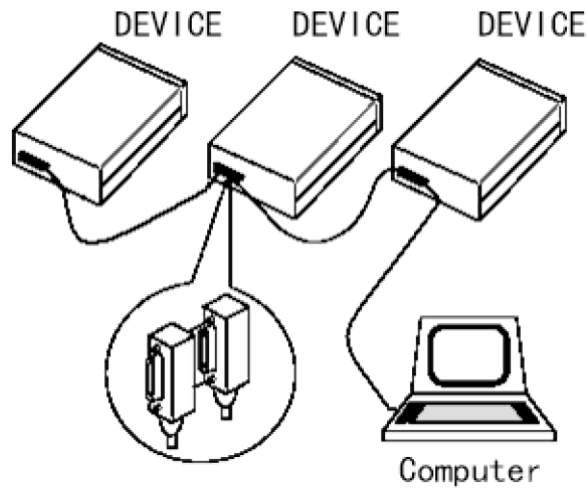

GPIB System Interconnection for Double-piggyback Connector

Method 2 of GPIB cable connection:

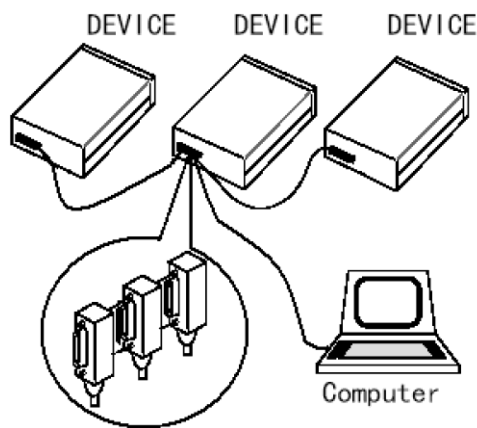

GPIB System Interconnection for 3-piggyback Connector

GPIB interface function

This instrument provides most of the general functions of GPIB except the controller, see the following table:

Code name	Function
SH1	Support all data source contact function
AH1	Support all receiver contact function
T5	Basic talker function, talk only function, talk is canceled when in MLA, serial point name is not supported
L4	Basic Listener function, the MTA is canceled, no listening

	function
RL1	Remote control / local function
DC1	Device clear function
DT1	Device trigger function
C0	No controller function
E1	Open collector drive

8.4.2 Setting the GPIB Address

The instrument's GPIB is addressed in a single address mode with no secondary address; the default GPIB address is 8. Users can set their own GPIB address (0~30), and the address value can be automatically saved in non-volatile memory. In a GPIB bus system, it is not allowed to assign the same address as other devices or controllers (computers).

8.4.3 General Bus Commands

General bus commands (like DCL) are the same meaning regardless of the machine. General commands and auxiliary instructions:

Command	Description	Control instructions for the 5493C multimeter
REM	REMOTE 8	Bring the instrument into remote control mode
IFC	ABORT 8	Reset the instrument interface to the idle state
LLO	LOCAL LOCKOUT	Block local messages so that all keys on the panel are inoperable
GTL	LOCAL 8	The instrument returns to local control and the buttons on the panel are active.
DCL	CLEAR	Clear all instrument input and output buffers
SDC	CLEAR 8	Clear the input and output buffer of 5493C
GET	TRIGGER 8	Trigger the instrument once, the measurement result will be sent to the output buffer after measurement.
SPE,SPD	SROLL 8	Serial point command

For a detailed description of the General Bus Command (SCPI), see the programming manual.

8.4.4 Setting through the interface

Press Menu → Utility → I/O Config → GPIB to Enter GPIB Settings Screen.

9 Specifications - 5492C / 5492CGPIB

Specifications are based on the following conditions:

- One year calibration cycle
- Calibration temperature $T_{CAL} = 23\text{ }^{\circ}\text{C}$
- Accuracy specifications: \pm (% of reading + % of range), valid for $T_{CAL} \pm 5\text{ }^{\circ}\text{C}$
- For DC: The technical specifications are valid after a warm-up time of 60 minutes, with the integration time set to 10 or 100 NPLC, and auto zero enabled.
- For AC: The technical specifications are valid after a warm-up time of 60 minutes, slow AC filtering enabled, using a sine wave input signal.

DC Voltage

Range ⁽¹⁾	Resolution	Full Scale Reading	Accuracy (1 year)
100 mV	1 μV	119.999 mV	0.012 + 0.008
1 V	10 μV	1.19999 V	0.010 + 0.005
10 V	100 μV	11.9999 V	0.010 + 0.005
100 V	1 mV	119.999 V	0.010 + 0.005
1000 V	10 mV	1050.00 V	0.010 + 0.005

(1) 20% overrange on all ranges except 1000 V can only test 5% overrange.

DC Current

Range	Burden Voltage	Resolution	Full Scale Reading	Accuracy (1 year)
100 μA	< 0.011 V	1 nA	119.999 μA	0.050 + 0.008
1 mA	< 0.11 V	10 nA	1.19999 mA	0.050 + 0.005
10 mA	< 0.05 V	0.1 μA	11.9999 mA	0.050 + 0.008
100 mA	< 0.5 V	1 μA	119.999 mA	0.050 + 0.005
1 A	< 0.7 V	10 μA	1.19999 A	0.100 + 0.010
3 A	< 2.0 V	10 μA	3.1500 A	0.150 + 0.020
10 A	< 0.5 V	100 μA	11.9999 A	0.200 + 0.010

DC Resistance⁽²⁾

Range ⁽³⁾	Test Current	Resolution	Full Scale Reading	Accuracy (1 year)
10 Ω	10 mA	0.1 m Ω	11.9999 Ω	0.050 + 0.008
100 Ω	10 mA	1 m Ω	119.999 Ω	0.040 + 0.005
1 k Ω	1 mA	10 m Ω	1.19999 k Ω	0.030 + 0.004
10 k Ω	100 μA	0.1 m Ω	11.9999 k Ω	0.030 + 0.004
100 k Ω ⁽⁴⁾	50 μA	1 Ω	119.999 k Ω	0.030 + 0.004
1 M Ω	5 μA	10 Ω	1.19999 M Ω	0.030 + 0.004
10 M Ω	500 nA	100 Ω	11.9999 M Ω	0.100 + 0.004
100 M Ω	500 nA 10 M Ω	1 k Ω	119.999 M Ω	1.000 + 0.010

(2) Specifications apply to 2-wire and 4-wire resistance measurements using NULL for offset. Without NULL, add 0.2 Ω additional error for 2-wire measurements.

(3) 20% overrange on all ranges

(4) To eliminate noise interference, it is recommended to use shielded test cables for resistance measurements above 100 k Ω .

Capacitance

Range ⁽⁵⁾	Test Current	Full Scale Reading	Accuracy (1 year)
1 nF	10 μA	1.19999 nF	2.0 + 0.5
10 nF	10 μA	11.9999 nF	0.5 + 0.1
100 nF	10 μA	119.999 nF	0.5 + 0.1
1 μF	100 μA	1.19999 μF	0.5 + 0.1
10 μF	100 μA	11.9999 μF	0.5 + 0.1
100 μF	1 mA	119.999 μF	0.5 + 0.1
1 mF	10 mA	1.19999 mF	0.5 + 0.1
10 mF	10 mA	11.9999 mF	1.0 + 0.50

(5) 20% overrange on all ranges.

Frequency⁽⁶⁾⁽⁷⁾

Frequency Range	Resolution	Full Scale Reading	Accuracy (1 year)
3 Hz to 10 Hz	10 μHz	9.99999 Hz	0.050 + 50
10 Hz to 100 Hz	100 μHz	99.9999 Hz	0.010 + 10
100 Hz to 1 kHz	1 mHz	999.999 Hz	0.005 + 2
1 kHz to 10 kHz	10 mHz	9.99999 kHz	0.005 + 2
10 kHz to 100 kHz	0.1 Hz	99.9999 kHz	0.005 + 2
100 kHz to 300 kHz	1 Hz	300.000 kHz	0.005 + 2
300 kHz to 1 MHz ⁽⁸⁾	1 Hz	999.999 kHz	0.005 + 2

(6) Applies to sine wave input and gate time set to 1 second.

(7) For sine wave input larger than 100 mV. For a 10 mV to 100 mV input, multiply the % of reading error by 10.

(8) For frequency measurements greater than 750 kHz, use manual ranges for best accuracy.

Specifications – 5492C / 5492CGPIB

True RMS AC Voltage⁽¹⁾⁽²⁾

100 mV, 1 V, 10 V, 100 V, and 750 V ranges

Frequency	Accuracy (1 Year)
3 Hz to 5 Hz	1.00 + 0.03
5 Hz to 20 Hz	0.38 + 0.03
20 Hz to 20 kHz	0.10 + 0.03
20 kHz to 50 kHz	0.15 + 0.05
50 kHz to 100 kHz	0.63 + 0.08
100 kHz to 300 kHz	4.00 + 0.50

Range ⁽³⁾	Resolution	Full Scale Reading
100 mV	1 μ V	119.999 mV
1 V	10 μ V	1.19999 V
10 V	100 μ V	11.9999 V
100 V	1 mV	119.999 V
750 V ⁽⁴⁾	10 mV	787.50 V

(1) Valid for sine wave input > 0.3% of range and greater than 1 mVrms.

(2) Three filters are available for low-frequency performance: 3 Hz, 20 Hz, and 200 Hz. No additional errors will occur for frequencies above these filter settings.

(3) 20% overrange on all ranges except 750 V range can only test 5% overrange.

(4) 750 V range is limited to 8×10^7 Volt-Hz.

True RMS AC Current⁽⁵⁾⁽⁶⁾

Range ⁽⁷⁾	Burden Voltage	Resolution	Full Scale Reading	Accuracy (1 year)		
				3 Hz to 5 Hz	5 Hz to 20 Hz	20 Hz to 10 kHz
100 μ A	< 0.011 V	1 nA	119.999 μ A	1.00 + 0.03	0.5 + 0.03	0.20 + 0.04
1 mA	< 0.11 V	10 nA	1.19999 mA	1.00 + 0.03	0.5 + 0.03	0.20 + 0.04
10 mA	< 0.05 V	0.1 μ A	11.9999 mA	1.00 + 0.03	0.5 + 0.03	0.20 + 0.04
100 mA	< 0.5 V	1 μ A	119.999 mA	1.00 + 0.03	0.5 + 0.03	0.20 + 0.04
1 A	< 0.7 V	10 μ A	1.19999 A	1.00 + 0.03	0.5 + 0.03	0.20 + 0.04
3 A	< 2.0 V	10 μ A	3.1500 A	1.00 + 0.03	0.5 + 0.03	0.25 + 0.04
10 A ⁽⁸⁾	< 0.5 V	100 μ A	11.9999 A	1.00 + 0.03	0.5 + 0.03	0.30 + 0.05

(5) Three filters are available for low-frequency performance: 3 Hz, 20 Hz, and 200 Hz. No additional errors will occur for frequencies above these filter settings.

(6) Valid for sine wave input > 1% of range and greater than 10 μ A AC.

(7) 20% overrange on all ranges except 3 A range can only test 5% overrange.

(8) 10 A range available on front panel only.

Continuity

Range	Test Current	Accuracy (1 year)	Temperature Coefficient / °C
1 k Ω	1 mA	0.030 + 0.004	0.0010 + 0.0020

Temperature

Type	Accuracy
Pt100 (DIN / IEC 751)	Probe accuracy + 0.05 °C
5 k Ω thermistor	Probe accuracy + 0.10 °C

Diode⁽⁹⁾

Range	Test Current	Accuracy (1 year)	Temperature Coefficient / °C
5 V	1 mA	0.010 + 0.005 ⁽¹⁾	0.0010 + 0.0020

(9) Applicable to the voltage measured at the input terminal. A 1 mA test current is typical. Changes in the current source will cause variations in voltage drop across the diode junction.

10 Specifications - 5493C / 5493CGPIB

Specifications are based on the following conditions:

- One year calibration cycle
- Calibration temperature $T_{CAL} = 23\text{ }^{\circ}\text{C}$
- Accuracy specifications: \pm (% of reading + % of range), valid for $T_{CAL} \pm 5\text{ }^{\circ}\text{C}$
- All 24 hours accuracy specifications are typical
- Add temperature coefficient for every $^{\circ}\text{C}$ outside $T_{CAL} \pm 5\text{ }^{\circ}\text{C}$
- For DC: The technical specifications are valid after a warm-up time of 60 minutes, with the integration time set to 10 or 100 NPLC, and auto zero enabled.
- For AC: The technical specifications are valid after a warm-up time of 60 minutes, slow AC filtering enabled, using a sine wave input signal.

DC Voltage

Range ⁽¹⁾	Resolution	Full Scale Reading	Accuracy			Temperature Coefficient / $^{\circ}\text{C}$
			24 Hours ⁽²⁾ $T_{CAL} \pm 1\text{ }^{\circ}\text{C}$	90 Days $T_{CAL} \pm 5\text{ }^{\circ}\text{C}$	1 Year $T_{CAL} \pm 5\text{ }^{\circ}\text{C}$	
100 mV	0.1 μV	119.9999 mV	0.0030 + 0.0030	0.0040 + 0.0035	0.0050 + 0.0035	0.0005 + 0.0005
1 V	1 μV	1.199999 V	0.0020 + 0.0006	0.0030 + 0.0007	0.0040 + 0.0007	0.0005 + 0.0001
10 V	10 μV	11.99999 V	0.0015 + 0.0004	0.0020 + 0.0005	0.0035 + 0.0005	0.0005 + 0.0001
100 V	100 μV	119.9999 V	0.0020 + 0.0006	0.0035 + 0.0006	0.0045 + 0.0006	0.0005 + 0.0001
1000 V	1 mV	1050.000 V	0.0020 + 0.0006	0.0035 + 0.0010	0.0045 + 0.0010	0.0005 + 0.0001

(1) 20% overrange on all ranges except 1000 V range which can only test 5% overrange.

(2) Relative to calibration standards.

DC Current

Range	Burden Voltage	Resolution	Full Scale Reading	Accuracy			Temperature Coefficient / $^{\circ}\text{C}$
				24 Hours $T_{CAL} \pm 1\text{ }^{\circ}\text{C}$	90 Days $T_{CAL} \pm 5\text{ }^{\circ}\text{C}$	1 Year $T_{CAL} \pm 5\text{ }^{\circ}\text{C}$	
100 μA	< 0.011 V	0.1 nA	119.9999 μA	0.010 + 0.020	0.040 + 0.025	0.050 + 0.025	0.0020 + 0.0030
1 mA	< 0.11 V	1 nA	1.199999 mA	0.010 + 0.006	0.030 + 0.006	0.050 + 0.006	0.0020 + 0.0005
10 mA	< 0.05 V	10 nA	11.99999 mA	0.010 + 0.020	0.030 + 0.020	0.050 + 0.020	0.0020 + 0.0020
100 mA	< 0.5 V	0.1 μA	119.9999 mA	0.010 + 0.004	0.030 + 0.005	0.050 + 0.005	0.0020 + 0.0005
1 A	< 0.7 V	1 μA	1.199999 A	0.050 + 0.006	0.080 + 0.010	0.100 + 0.010	0.0050 + 0.0010
3 A	< 2.0 V	1 μA	3.15000 A	0.180 + 0.020	0.200 + 0.020	0.200 + 0.020	0.0050 + 0.0020
10 A ⁽³⁾	< 0.5 V	10 μA	11.99999 A	0.050 + 0.010	0.120 + 0.010	0.120 + 0.010	0.0050 + 0.0010

(3) 10 A range available on front panel only.

DC Resistance⁽⁴⁾

Range ⁽⁵⁾	Test Current	Resolution	Full Scale Reading	Accuracy			Temperature Coefficient / $^{\circ}\text{C}$
				24 Hours $T_{CAL} \pm 1\text{ }^{\circ}\text{C}$	90 Days $T_{CAL} \pm 5\text{ }^{\circ}\text{C}$	1 Year $T_{CAL} \pm 5\text{ }^{\circ}\text{C}$	
10 Ω	10 mA	10 $\mu\Omega$	11.99999 Ω	0.0050 + 0.0040	0.0080 + 0.0060	0.0100 + 0.0080	0.0006 + 0.0008
100 Ω	10 mA	0.1 m Ω	119.9999 Ω	0.0030 + 0.0020	0.0080 + 0.0030	0.0100 + 0.0040	0.0006 + 0.0005
1 k Ω	1 mA	1 m Ω	1.199999 k Ω	0.0020 + 0.0005	0.0080 + 0.0010	0.0100 + 0.0010	0.0006 + 0.0001
10 k Ω	100 μA	10 m Ω	11.99999 k Ω	0.0020 + 0.0005	0.0080 + 0.0010	0.0100 + 0.0010	0.0006 + 0.0001
100 k Ω ⁽⁶⁾	50 μA	100 m Ω	119.9999 k Ω	0.0020 + 0.0005	0.0080 + 0.0010	0.0100 + 0.0010	0.0006 + 0.0001
1 M Ω	5 μA	1 Ω	1.199999 M Ω	0.0020 + 0.0010	0.0080 + 0.0010	0.0100 + 0.0010	0.0010 + 0.0002
10 M Ω	500 nA	10 Ω	11.99999 M Ω	0.0150 + 0.0010	0.0200 + 0.0010	0.0400 + 0.0010	0.0030 + 0.0004
100 M Ω	500 nA 10 M Ω	100 Ω	119.9999 M Ω	0.3000 + 0.0100	0.8000 + 0.0100	0.8000 + 0.0100	0.1500 + 0.0002

(4) Specifications apply to 2-wire and 4-wire resistance measurements using NULL for offset. Without NULL, add 0.2 Ω additional error for 2-wire measurements.

(5) 20% overrange on all ranges

(6) To eliminate noise interference, it is recommended to use shielded test cables for resistance measurements above 100 k Ω .

Specifications – 5493C / 5493CGPIB

Capacitance

Range ⁽¹⁾	Full Scale Reading	Accuracy			Temperature Coefficient / °C
		24 Hours T _{CAL} ± 1 °C	90 Days T _{CAL} ± 5 °C	1 Year T _{CAL} ± 5 °C	
1 nF	1.199999 nF	0.5 + 0.10	0.5 + 0.40	2.0 + 0.50	0.02 + 0.001
10 nF	11.99999 nF	0.2 + 0.05	0.5 + 0.10	1.0 + 0.10	0.02 + 0.001
100 nF	119.9999 nF	0.2 + 0.05	0.5 + 0.10	1.0 + 0.10	0.02 + 0.001
1 µF	1.199999 µF	0.2 + 0.05	0.5 + 0.05	1.0 + 0.10	0.02 + 0.001
10 µF	11.99999 µF	0.2 + 0.05	0.5 + 0.05	1.0 + 0.10	0.02 + 0.001
100 µF	119.9999 µF	0.2 + 0.05	0.5 + 0.05	1.0 + 0.10	0.02 + 0.001
1 mF	1.199999 mF	0.2 + 0.05	0.5 + 0.05	1.0 + 0.20	0.02 + 0.001
10 mF	11.99999 mF	0.5 + 0.20	0.5 + 0.30	1.0 + 0.50	0.02 + 0.001

(1) 20% overrange on all ranges.

True RMS AC Voltage⁽²⁾⁽³⁾

100 mV, 1 V, 10 V, 100 V, and 750 V ranges

Frequency	24 Hours T _{CAL} ± 1 °C	90 Days T _{CAL} ± 5 °C	1 Year T _{CAL} ± 5 °C	Temperature Coefficient / °C
3 Hz to 5 Hz	1.00 + 0.02	1.00 + 0.02	1.00 + 0.03	1.00 + 0.03
5 Hz to 10 Hz	0.35 + 0.02	0.35 + 0.03	0.35 + 0.03	0.35 + 0.03
10 Hz to 20 kHz	0.04 + 0.02	0.05 + 0.03	0.06 + 0.03	0.07 + 0.03
20 kHz to 50 kHz	0.10 + 0.04	0.11 + 0.05	0.12 + 0.05	0.13 + 0.05
50 kHz to 100 kHz	0.55 + 0.08	0.60 + 0.08	0.60 + 0.08	0.60 + 0.08
100 kHz to 300 kHz	4.00 + 0.50	4.00 + 0.50	4.00 + 0.50	4.00 + 0.50

Range ⁽⁴⁾	Resolution	Full Scale Reading
100 mV	1 µV	119.9999 mV
1 V	10 µV	1.199999 V
10 V	100 µV	11.99999 V
100 V	1 mV	119.9999 V
750 V ⁽⁵⁾	10 mV	787.500 V

(2) Valid for sine wave input > 0.3% of range and greater than 1 mVrms.

(3) Three filters are available for low-frequency performance: 3 Hz, 20 Hz, and 200 Hz. No additional errors will occur for frequencies above these filter settings.

(4) 20% overrange on all ranges except 750 V range which can only test 5% overrange.

(5) 750 V range is limited to 8 x 10⁷ Volt-Hz.

Continuity

Range	Test Current	Accuracy			Temperature Coefficient / °C
		24 Hours T _{CAL} ± 1 °C	90 Days T _{CAL} ± 5 °C	1 year T _{CAL} ± 5 °C	
1 kΩ	1 mA	0.002 + 0.030	0.008 + 0.030	0.010 + 0.030	0.0010 + 0.0020

Diode⁽⁶⁾

Range	Test Current	Accuracy			Temperature Coefficient / °C
		24 Hours T _{CAL} ± 1 °C	90 Days T _{CAL} ± 5 °C	1 year T _{CAL} ± 5 °C	
5 V	1 mA	0.002 + 0.030	0.008 + 0.030	0.010 + 0.030	0.0010 + 0.0020

(6) Applicable to the voltage measured at the input terminal. A 1 mA test current is typical. Changes in the current source will cause variations in voltage drop across the diode junction.

Specifications – 5493C / 5493CGPIB

True RMS AC Current⁽¹⁾⁽²⁾

Range ⁽³⁾ , Burden Voltage	Frequency	Accuracy			Temperature Coefficient / °C
		24 Hours $T_{CAL} \pm 1\text{ }^{\circ}\text{C}$	90 Days $T_{CAL} \pm 5\text{ }^{\circ}\text{C}$	1 Year $T_{CAL} \pm 5\text{ }^{\circ}\text{C}$	
100 μA , < 0.011 V 1 mA, < 0.11 V 10 mA, < 0.05 V 100 mA, < 0.5 V	3 Hz to 5 Hz	1.00 + 0.02	1.00 + 0.02	1.00 + 0.04	0.100 + 0.006
	5 Hz to 10 Hz	0.30 + 0.02	0.30 + 0.03	0.30 + 0.04	0.035 + 0.006
	10 Hz to 5 kHz	0.10 + 0.04	0.10 + 0.04	0.10 + 0.04	0.015 + 0.006
	5 kHz to 10 kHz	0.10 + 0.04	0.10 + 0.04	0.10 + 0.04	0.030 + 0.006
1 A, < 0.7 V	3 Hz to 5 Hz	1.00 + 0.02	1.00 + 0.02	1.00 + 0.04	0.100 + 0.006
	5 Hz to 10 Hz	0.30 + 0.02	0.30 + 0.03	0.30 + 0.04	0.035 + 0.006
	10 Hz to 5 kHz	0.10 + 0.04	0.10 + 0.04	0.10 + 0.04	0.015 + 0.006
	5 kHz to 10 kHz	0.30 + 0.04	0.30 + 0.04	0.30 + 0.04	0.030 + 0.006
3 A, < 2.0 V	3 Hz to 5 Hz	1.00 + 0.02	1.00 + 0.02	1.00 + 0.04	0.100 + 0.006
	5 Hz to 10 Hz	0.35 + 0.02	0.35 + 0.03	0.35 + 0.04	0.035 + 0.006
	10 Hz to 5 kHz	0.23 + 0.04	0.23 + 0.04	0.23 + 0.04	0.015 + 0.006
	5 kHz to 10 kHz	0.30 + 0.04	0.30 + 0.04	0.30 + 0.04	0.030 + 0.006
10 A ⁽⁴⁾ , < 0.5 V	3 Hz to 5 Hz	1.00 + 0.02	1.00 + 0.02	1.00 + 0.04	0.100 + 0.006
	5 Hz to 10 Hz	0.30 + 0.02	0.35 + 0.03	0.30 + 0.04	0.035 + 0.006
	10 Hz to 5 kHz	0.15 + 0.04	0.15 + 0.04	0.2 + 0.08	0.015 + 0.006
	5 kHz to 10 kHz	0.15 + 0.04	0.15 + 0.04	0.2 + 0.08	0.030 + 0.006

(1) Three filters are available for low-frequency performance: 3 Hz, 20 Hz, and 200 Hz. No additional errors will occur for frequencies above these filter settings.

(2) Valid for sine wave input > 1% of range and greater than 10 μA AC.

(3) 20% overrange on all ranges except 3 A range which can only test 5% overrange.

(4) 10 A range available on front panel only.

Frequency \pm (% of reading)⁽⁵⁾⁽⁶⁾

100 mV, 1 V, 10 V, 100 V, and 750 V ranges

Frequency Range	Accuracy			Temperature Coefficient / °C
	24 Hours $T_{CAL} \pm 1\text{ }^{\circ}\text{C}$	90 Days $T_{CAL} \pm 5\text{ }^{\circ}\text{C}$	1 Year $T_{CAL} \pm 5\text{ }^{\circ}\text{C}$	
2 Hz to 10 Hz	0.1	0.100	0.100	0.0002
10 Hz to 100 Hz	0.030	0.030	0.030	0.0002
100 Hz to 1 kHz	0.003	0.008	0.010	0.0002
1 kHz to 300 kHz	0.002	0.006	0.010	0.0002
300 kHz to 1 MHz ⁽⁷⁾	0.002	0.006	0.010	0.0002
Square wave ⁽⁸⁾	0.001	0.006	0.010	0.0002

(5) Applies for sine wave input and gate time set to 1 second.

(6) For sine and square wave input larger than 100 mV. For a 10 mV to 100 mV input, multiply the % reading error by 10.

(7) For frequency measurements greater than 750 kHz, use manual ranges for best accuracy.

(8) Square input specified for 10 Hz to 300 kHz.

Additional gate time errors \pm (% of reading)

Frequency	1 second	0.1 second	0.01 second
3 Hz to 40 Hz	0	0.200	0.200
40 Hz to 100 Hz	0	0.060	0.200
100 Hz to 1 kHz	0	0.020	0.200
1 Hz to 300 kHz	0	0.004	0.030
Square wave ⁽⁸⁾	0	0	0

Temperature

Type	Accuracy
Pt100 (DIN / IEC 751)	Probe accuracy + 0.05 °C
5 k Ω thermistor	Probe accuracy + 0.10 °C

General		
AC Input	110 V/220 V ±10%, 50/60 Hz	
Power Consumption	≤ 30 VA	
I/O Interface	RS232, USB host, USB (USBTMC-compliant) device, LAN, GPIB (5492CGPIB and 5493CGPIB only)	
Temperature	Operating	32 °F to 104 °F (0 °C to 40 °C)
	Storage	-40 °F to 158 °F (-40 °C to 70 °C)
Humidity	Indoor use, ≤ 95 %	
Safety	EN 6110-1:2010, Low Voltage Directive (LVD) 2014/35/EU	
Electromagnetic Compatibility	EN 61326-1:2013, EMC directive 2014/30/EU	
Dimensions (W x H x D)	8.85" x 3.93" x 13.97" (225 mm x 100 mm x 355 mm)	
Weight	5.51 lbs (2.5 kg)	
Warranty	3 years	
Standard Accessories	Power cord, USB cable, test leads, spare fuses, test report and certificate of calibration	
Optional Accessories	Rack mount kit (RK02), high performance bench DMM accessory kit (TL500B), general purpose DMM kit (TL130B), Maxi-Pro DMM kit (TL50B), replacement probes (TL37)	

10.1 Supplementary specifications – 5493C / 5493CGPIB

Display readings and measuring speed

DC resistance, DC voltage, DC current ^[1]

Integration time	Digits ^[2]	Readings/second ^[3]	Noise error
100PLC/2s(1.67s)	6 ¹ / ₂	0.5(0.6)	0
10PLC/200ms(167ms)	6 ¹ / ₂	5(6)	0
1PLC/20ms(16.7ms)	5 ¹ / ₂	45(55)	0.001% range
0.2PLC/4ms	5 ¹ / ₂	200	0.001% range ^[4]
0.02PLC/400µs	4 ¹ / ₂	1000	0.01% range ^[4]

[1]. Reading rate for 60 Hz and 50 Hz operating conditions, auto zero off, using a fixed range.

[2]. Digit mask set to Auto. If a fixed number of digits are selected, the number of displayed digits does not change due to the test speed.

[3]. The average speed at which the ADC continuously samples data to the display.

[4]. Add 20 µV for DCV; add 20 mΩ for resistance. Add 0.2 uA + 10 times the above noise error range for the 100 uA and 10 mA ranges for DC current.

11 Service Information

Warranty Service:

Please go to the support and service section to obtain a RMA #. Return the product in the original packaging with proof of purchase to the address below. Clearly state on the RMA the performance problem and return any leads, probes, connectors and accessories that you are using with the device.

Non-Warranty Service:

Please go to the support and service section to obtain a RMA #. Return the product in the original packaging to the address below. Clearly state on the RMA the performance problem and return any leads, probes, connectors and accessories that you are using with the device. Customers not on an open account must include payment in the form of a money order or credit card. For the most current repair charges please refer to the service and support section on our website.

Return all merchandise to B&K Precision Corp. with prepaid shipping. The flat-rate repair charge for Non-Warranty Service does not include return shipping. Return shipping to locations in North America is included for Warranty Service. For overnight shipments and non-North American shipping fees please contact B&K Precision Corp.

Include with the returned instrument your complete return shipping address, contact name, phone number and description of problem.

LIMITED THREE YEAR WARRANTY

B&K Precision Corp. warrants to the original purchaser that its products and the component parts thereof, will be free from defects in workmanship and materials for a period of three years from date of purchase.

B&K Precision Corp. will, without charge, repair or replace, at its option, defective product or component parts. Returned product must be accompanied by proof of the purchase date in the form of a sales receipt.

To help us better serve you, please complete the warranty registration for your new instrument via our website www.bkprecision.com

Exclusions: This warranty does not apply in the event of misuse or abuse of the product or as a result of unauthorized alterations or repairs. The warranty is void if the serial number is altered, defaced or removed.

B&K Precision Corp. shall not be liable for any consequential damages, including without limitation damages resulting from loss of use. Some states do not allow limitations of incidental or consequential damages. So the above limitation or exclusion may not apply to you. This warranty gives you specific rights and you may have other rights, which vary from state-to- state.

BK PRECISION[®]