

User Manual



Test Equipment  
Depot  
1-800-517-8431

5 Commonwealth Ave  
Woburn, MA 01801  
Phone 781-665-1400  
Toll Free 1-800-517-8431

Visit us at [www.TestEquipmentDepot.com](http://www.TestEquipmentDepot.com)

# BR750

## High Definition Videoscope



## ***Introduction***

---

Congratulations on your purchase of the Triplet Model BR750 Video Scope. The Video Scope is a compact handheld instrument that allows the user to view hard to reach spaces that could not normally be seen when connecting with camera probe. This Video Scope is supplied in a sturdy carrying case and consists of a display unit, insertion tube, main adapter and side view adapter. The display unit, with a 5" wide angle TFT LCD screen, has the capacity of viewing, storing and reviewing photos and video images. Images can also be displayed directly on a TV screen or stored and transferred to a PC for viewing later. The display unit is powered by rechargeable Li-polymer batteries and a 5V charger is included.

## ***Safety***

---

### Warning

1. Do not modify or disassemble the unit.
2. Do not use this item in explosive atmospheres.





### Caution



1. Keep the device out of the reach of children.
2. Do not look directly into the objective lens at the end of the insertion tube, your eyesight may be seriously damaged.
3. Do not forcibly bend, twist or elongate the insertion tube.
4. Strong impact on the device may result in the breakage of the objective lens (made of glass) at the tip of the insertion tube.
5. Do not use or store the device at a temperature higher than 60 °C or lower than -20 °C.
6. Don't use the device in the direct sunshine.
7. Store the device in a dry and adequately ventilated environment.

8. Keep the device away from acid or alkaline solutions, oil or petrol, and do not use it in an atmosphere containing their vapors.
9. Do not remove the SD Memory Card while data is being saved to the card. This may cause the data to be lost or the card to be damaged.

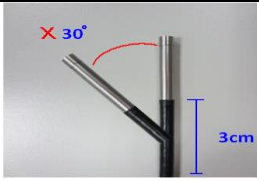
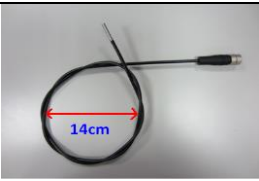

### **Warning Notice for Insert Tube**

|   |   |  |
|---|---|--|
| 1 | DO NOT bend the tube over 30° angle.                            |   |
| 2 | DO NOT bundle the insert tube less than a 14cm diameter circle. |   |
| 3 | DO NOT bend the tube after installation.                        |  |

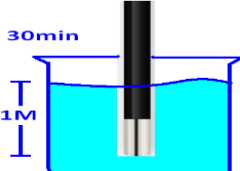
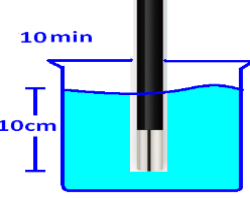
|   |  |   |
|---|--|---|
| 4 | DO tighten the screw for all accessories before use.   |    |
| 5 | Prohibited of high temperature access for the tubes, the maximum working temperature shall not exceed 65°C.                  |    |
| 6 | Prohibited of collision or any impacts on the front tips.  |    |
| 7 | DO NOT immerse Insert Tube deeper than 1M depth and over 30 minutes.   |    |
| 8 | DO NOT immerse Insert Tube deeper than 10cm depth and over 10 minutes besides water. (Such as lubricant oil, gasoline, etc.) |  |

## Meter Description

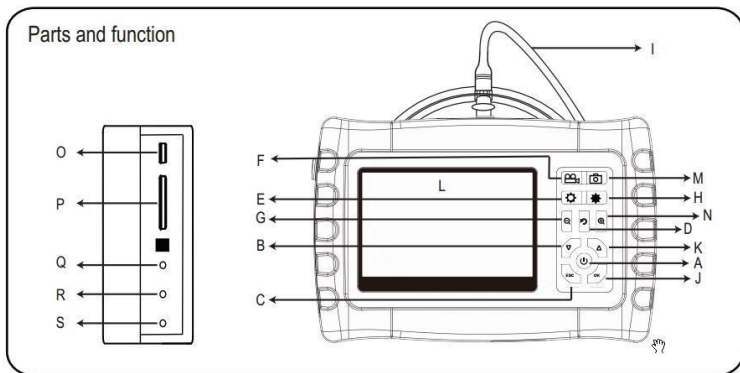

- |  |                               |                       |
|--|-------------------------------|-----------------------|
| A. POWER button                            | G. Zoom out<br>LED brightness | M. REC<br>button      |
| B. DOWN button                             | H. increase                   | N. Zoom in            |
| C. Escape                                  | I. Insertion tube             | O. USB Port           |
| D. Mirror Image & Rotate<br>LED Brightness | J. OK button                  | P. SD Slot            |
| E. Decrease                                | K. UP button                  | Q. Video Out<br>Reset |
| F. PHOTO button                            | L. Display unit               | R. Button             |
|  |                               | S. DC In              |

## ***Preparation for Use***

---

On first use it is important that the SD card is inserted as shown.

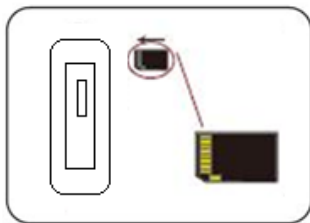

Connect the insertion tube to the display Unit as shown in the figure and tighten the locking collar:

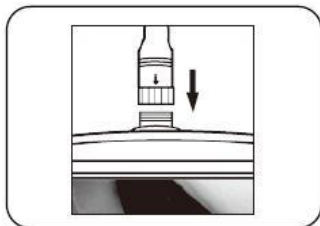

Press the POWER button for 3-5 seconds to turn the display unit on.  
The Start-up screen is shown briefly followed by the status screen for five seconds.

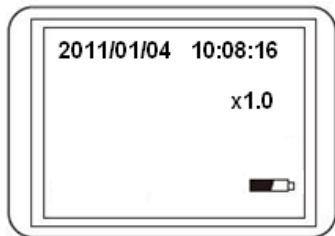

The status screen shows the capacity of the SD card and the internal battery. If the Video Scope has been stored for a long time then the display might not turn on. The most likely cause is that the battery has run out. Please use power adapter to re-charge the battery.

Directly on the screen, a “live” picture can be seen. This is the camera mode. It is strongly advised to properly set-up the Video Scope before first use. The indexing of saved photos and video is based on date and time only. Other parameters, if set before first use, can make the operation of the Video Scope easier in the future. Press POWER button for 3-5 seconds to turn the display unit off.

## ***Operation***

---

### **Menu setup**

- Switch the unit on. Ensure that camera mode is active (i.e. a “live” picture can be seen)
- Press the OK button to access the menus. Use the UP or DOWN button to select the menu item. Press OK to confirm.

The options displayed are as follows;

- Delete All
- Video Output
- Date / Time setup
- Language
- Video Format
- Auto Power off

### **Delete All**

Take care in selecting this option, as everything will be deleted from the SD card!

Navigate to DELETE ALL in the menu, press the OK button. Select YES or NO using the UP or DOWN buttons. Confirm with the OK button.

## Video Output

This function allows live pictures or recorded photos and videos to be displayed on a TV screen or beamer. First make sure that the Video format is set correctly to the used TV system (PAL or NTSC). (See the Menu set up section.) Connect the scope video cable to the display unit TV out jack. Ensure that the other end of the video cable is well connected to the TV or beamer.

Press the OK button to select menu options, select Video Output and press the OK button.

The scope unit screen will turn black and the display will be shown on the TV. You can transfer the screen back to the display unit by selecting the same function.

## Date/Time Setup

Press UP button & DOWN button to select year/month/day or hour/minute/second. Press

PHOTO button to increase the value and the REC button to decrease

the value

The date and time can be displayed in the preview

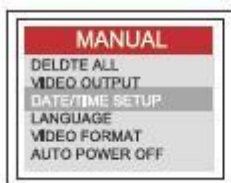

image mode. Use either the PHOTO or REC button to toggle between display "ON" and "OFF" Confirm selection and exit menu by pressing OK.



## Language

Navigate to LANGUAGE in the menu, press the OK button. Select the required language using the UP or DOWN buttons and confirm with the OK button.



## Video Format

Navigate to VIDEO FORMAT in the menu, press the OK button. Select the required video format (NTSC or PAL) using the UP or DOWN buttons. Confirm with the OK button.

## Auto Power Off

Navigate to AUTO POWER OFF in the menu, press the OK button. Select the required auto power off time (5, 10, 15, 30 minutes or Disable) using the UP or DOWN buttons.

Confirm with the OK button.



## Digital Zoom

The picture in preview mode could be magnifying by press Zoom in button and Zoom out button back to normal.

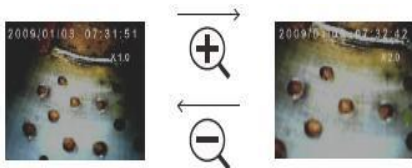

## LED Adjustment

The LED Adjustment button is located in the function key board, designed for user adjusting the brightness of LED to choose a suitable illumination condition for different environment.

H. LED brightness increase —   — E. LED brightness decrease

## Mirror / Reflecting Object Surface

When press  button, you will get a mirrored image to original image. The phenomenon is shown as follows:

Press  button first time:



Original image



Horizontal

Press  button second time:



Original image



Folding

Press  button third time:



Original image



Vertical

## Snapshot and Recording Functions

### Snapshot

In Camera mode, press the PHOTO button to take a photo. The photo is stored to the SD card in jpg format with a file name of running number. For example IMG00001.jpg.

Users can capture the picture that they wanted during the video playing and recording by pressing the PHOTO bottom

## Recording

In Camera mode, press the REC button to take a video. The video icon is shown in the top right corner. To stop recording, press the REC button again. The video icon disappears. The display reverts to preview mode. The video is automatically stored to the SD card in asf format with a file name of running number. For example IMG00002.asf.

## Snapshot While Recording

“SWR” function allows user to take photo snap-shot while recording or playback the video.

## Surfing mode

In the camera mode, press the UP or DOWN key, the last photo or video will be displayed. Press the UP or DOWN keys to navigate to the photo or video to be viewed.

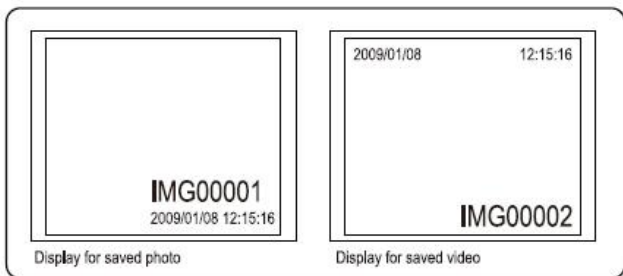



To play the video, press the REC button. To revert to preview mode, press the ESC button

To delete a saved photo, press the OK button while it is displayed. To delete a saved video, make sure the video is not in play mode, press the OK button. A delete menu will show. Toggle between the Yes and No options using the UP and DOWN buttons. Press the OK button to confirm.

## Photo Compare Function

A build-in photo compare function compares two photos on screen at the same time, allow user to see the difference at inspection site without using computer software.

In the surfing mode press  to select first photo, press UP/DOWN buttons again to find second photo and press , to start compare press  button.



## Transferring Photos and Videos to a PC

The computer must be running MS Windows™ 2000 or later. Turn the Video scope on. Connect the USB cable to the scope unit and the computer. Look for the drive with the SD card files, this should look similar to the following figure:

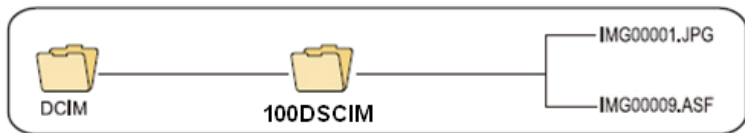

The files can then be transferred and viewed on the PC. In general, on a PC running MS Windows™ 2000 or later with Windows™ Media player, no special software is required to display JPG and ASF files.

## Troubleshooting

Q: No image on the display after turning the power on, what should I do?

A: Battery is exhausted. Connect the scope unit to the power adapter supplied and recharge batteries. The Video scope can be used when connected to ac power.

Q: No image, only words on the LCD monitor after turning the power on, what should I do?

A: Check that the insertion tube is correctly connected to the display unit.

Q: Unable to take photos or record video, what should I do?

A: SD card not present, wrongly inserted, full or faulty. Check SD card is present, check SD card insertion, check SD capacity, check if SD card is faulty (check if SD card works in other devices).

Q: How to reset the unit?

A: When all functions freeze or fail, insert an insulated needle into the hole on the back of the main unit. The system will restart automatically.

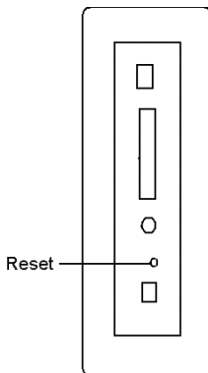

## **Specifications**

### **Display Unit**

|  |  |
|--|--|
| Power  | DC5V   |
| Display  | 5" TFT LCD Monitor 800 X 480 Pixels  |
| Interface  | Mini USB 1.1/ AV out   |
| Battery (not user serviceable)                       | Rechargeable Li-Polymer Battery (3.7V)   |
| Power adapter  | 100 - 240V AC in / 5.5V DC out.  |
| Video Out Format                                     | NTSC & PAL   |
| Recording medium                                     | SD card  |
| Compression Format                                   | MPEG4  |
| Still Image Storage Format                           | JPEG (640 X 480)   |
| Video Recording Format                               | ASF (640 X 480)  |
| Working & Storage/Battery charging temperature range | -20 °C to 60 °C / 0 to 40 °C   |
| Functions  | Snapshot, Video recording, Audio recording, Picture & video review on LCD screen, TV Out, transfer of picture & video from SD Card to PC |



## Camera

|                       |   |
|-----------------------|---|
| Image Sensor          | CMOS  |
| Resolution            | 640x480 pixels  |
| Insertion Tube Length | 1m (3.3')   |
| Tube Type             | Flexible  |
| Camera Diameter       | 6mm (0.24")   |
| Field of View         | 60°   |
| Depth of View         | 20~60mm   |
| Light Source          | Four (LED) lamps with intensity control<br>Dial on Left of Unit                               |
| Camera Tip Bending    | All way joystick control joystick control<br>(135° to all direction)                          |
| Ingress Protection    | IP67  |
| Keys on Handle        | Snap Shot, Record, Brightness Adjust,<br>and<br>rotation keys on handle for easy<br>operation |

## **Warranty**

---

Triplett / Jewell Instruments extends the following warranty to the original purchaser of these goods for use. Triplett warrants to the original purchaser for use that the products sold by it will be free from defects in workmanship and material for a period of (1) one year from the date of purchase. This warranty does not apply to any of our products which have been repaired or altered by unauthorized persons in any way or purchased from unauthorized distributors so as, in our sole judgment, to injure their stability or reliability, or which have been subject to misuse, abuse, misapplication, negligence, accident or which have had the serial numbers altered, defaced, or removed. Accessories, including batteries are not covered by this warranty

**Copyright © 2021 Triplett**