

BT3563A
BT3562A
BT3561A

HIOKI

BT3563
BT3563-01
BT3562
BT3562-01

Instruction Manual



5 Commonwealth Ave
Woburn, MA 01801
Phone 781-665-1400
Toll Free 1-800-517-8431

Visit us at www.TestEquipmentDepot.com

BATTERY HiTESTER



! Be sure to read this manual before using the instrument. ▶ p.3

✓ When using the instrument for the first time

- Names and Functions of Parts ▶ p.11
- Measurement Preparations ▶ p.19

📖 Troubleshooting

- Maintenance and Service ▶ p.189
- Error Display ▶ p.191

EN



Contents

| | |
|---|-----------|
| Introduction..... | 1 |
| Verifying Package Contents | 2 |
| Safety Information | 3 |
| Operating Precautions..... | 5 |
| Chapter 1 | |
| Overview | 9 |
| 1.1 Product Overview | 9 |
| 1.2 Features | 10 |
| 1.3 Names and Functions of Parts | 11 |
| 1.4 Menu Display Sequence (SHIFT → ENTER) | 16 |
| 1.5 Measurement Flowchart | 17 |
| Chapter 2 | |
| Measurement Preparations | 19 |
| 2.1 Preparation Flowchart | 19 |
| 2.2 Connecting the Power Cord..... | 20 |
| 2.3 Connecting the Optional Test Leads..... | 21 |
| 2.4 Turning the Power On and Off | 22 |
| 2.5 Selecting the Line Frequency | 24 |
| Chapter 3 | |
| Measurement | 25 |
| 3.1 Pre-Operation Inspection | 25 |
| 3.2 Basic Measurement Example | 26 |
| ■ Preparations | 26 |
| ■ Instrument Settings | 27 |
| ■ Zero-Adjustment | 28 |
| ■ Measurement | 29 |
| 3.3 Selecting Measurement Mode | 30 |
| 3.4 Setting Measurement Range | 31 |
| ■ Resistance measurement range | 31 |
| ■ Voltage measurement range | 32 |
| ■ Auto-Ranging | 33 |
| 3.5 Setting Sampling Rate | 34 |
| 3.6 Zero-Adjust Function | 35 |
| ■ Wiring Method for Zero-Adjustment | 35 |
| ■ Executing Zero-Adjustment..... | 35 |
| 3.7 Displaying Measurement Results | 38 |

| | |
|-------------------------------------|----|
| ■ Measurement Fault Detection | 39 |
| ■ Overflow Display | 40 |

Chapter 4

Applied Measurement 41

| | | |
|------|--|----|
| 4.1 | Comparator Function | 42 |
| | ■ Comparator Setting Example 1 (Upper and Lower Threshold Judgment) | 43 |
| | ■ Comparator Setting Example 2 (Reference Value and Tolerance Judgment) | 47 |
| | ■ Comparator Judgment Beeper Setting | 52 |
| | ■ Comparator Execution Mode Setting | 52 |
| | ■ Comparator Threshold Method Selection | 53 |
| | ■ Upper and Lower Thresholds Setting (by Reference Value and Tolerance) | 54 |
| | ■ Configuring the Absolute Value Judgment Function (Voltage) | 55 |
| | ■ Enabling and Disabling the Comparator Function | 56 |
| | ■ Comparator Judgment Results | 57 |
| | ■ Switching Between Measurement Value and Comparator Setting Displays | 58 |
| 4.2 | Trigger Function | 59 |
| | ■ Trigger Source Settings | 59 |
| | ■ Trigger Delay Settings | 60 |
| 4.3 | Measurement Current Pulse Output Function | 61 |
| 4.4 | Averaging Function | 63 |
| 4.5 | Statistical Calculation Functions | 64 |
| 4.6 | Memory Function | 68 |
| 4.7 | Key-Lock Function | 70 |
| 4.8 | Panel Save Function | 71 |
| 4.9 | Panel Load Function | 72 |
| 4.10 | Self-Calibration | 73 |
| 4.11 | Measurement Value Output Function | 74 |
| 4.12 | Key Beeper Setting | 75 |
| 4.13 | Reset Function | 76 |

Chapter 5

External Control (EXT I/O) 79

| | | |
|-----|-----------------------------|----|
| 5.1 | Overview | 79 |
| 5.2 | Signal Descriptions | 80 |
| | ■ Pinout | 80 |
| | ■ Input Signals | 81 |
| | ■ Output Signals | 82 |
| | ■ ERR Output | 83 |
| | ■ Instrument Settings | 84 |

| | | |
|-----|----------------------------|----|
| 5.3 | Timing Chart | 85 |
| 5.4 | Internal Circuitry | 87 |
| 5.5 | External Control Q&A | 90 |

Chapter 6

Printing _____ **91**

| | | |
|-----|--|----|
| 6.1 | Connecting the Printer | 91 |
| | ■ Connecting the PRINTER to the Instrument | 92 |
| 6.2 | Selecting the Interface | 93 |
| 6.3 | Printing | 94 |

Chapter 7

Analog Output _____ **97**

| | | |
|-----|------------------------------------|----|
| 7.1 | Connecting Analog Output | 97 |
| 7.2 | Analog Output Specifications | 98 |

Chapter 8

RS-232C/GP-IB/LAN Interfaces _____ **99**

| | | |
|-----|--|-----|
| 8.1 | Overview and Features | 99 |
| 8.2 | Specifications | 100 |
| | ■ RS-232C Specification | 100 |
| | ■ LAN Specifications | 100 |
| | ■ GP-IB Specifications (Model BT3562-01 only) | 101 |
| 8.3 | Selecting the Connections and Protocol | 102 |
| | ■ Attaching the Connector | 102 |
| | ■ Selecting the Interface | 105 |
| | ■ Setting LAN communications | 106 |
| 8.4 | Communication Methods | 108 |
| | ■ Message Format | 108 |
| | ■ Output Queue and Input Buffer | 112 |
| | ■ Status Byte Register | 113 |
| | ■ Event Registers | 115 |
| | ■ Initialization Items | 118 |
| | ■ Local Function..... | 118 |
| 8.5 | Message List | 119 |
| | ■ Standard Commands | 119 |
| | ■ Device-Specific Commands | 121 |
| 8.6 | Message Reference | 126 |
| | ■ Standard Commands | 127 |
| | ■ Device-Specific Commands | 131 |
| | ■ Measurement Value Formats | 159 |
| | ■ Command Compatibility with the Model 3560 AC m Ω HiTESTER..... | 160 |

| | | |
|-----|---|-----|
| 8.7 | Basic Data Importing Methods | 165 |
| 8.8 | Sample Programs | 166 |
| ■ | To be prepared in Visual Basic® 5.0/6.0 | 166 |
| ■ | To be prepared in Visual Basic® 2005 | 176 |
| ■ | Creation Procedure(Visual Basic® 2005) | 176 |
| ■ | Sample Programs(Visual Basic® 2005) | 178 |

Chapter 9
Specifications _____ 181

| | | |
|-----|------------------------------|-----|
| 9.1 | Basic Specifications | 181 |
| 9.2 | Accuracy | 186 |
| 9.3 | General Specifications | 188 |

Chapter 10
Maintenance and Service _____ 189

| | | |
|------|-----------------------|-----|
| 10.1 | Troubleshooting | 189 |
| 10.2 | Cleaning | 191 |
| 10.3 | Error Display | 191 |

Chapter 11
License Information _____ 193

Appendix _____ A 1

| | | |
|-------------|---|------|
| Appendix 1 | Precautions for Making Custom Test Leads | A 1 |
| Appendix 2 | AC Four-terminal Method | A 4 |
| Appendix 3 | Measurement values when using four-terminal measurement (Differences in measurement values due to measurement leads used) | A 5 |
| Appendix 4 | Synchronous Detection System | A 6 |
| Appendix 5 | Configuration and Extension of the Test Leads | A 7 |
| Appendix 6 | Effect of Eddy Currents | A 8 |
| Appendix 7 | Calibration Procedure..... | A 9 |
| Appendix 8 | Zero Adjustment..... | A 10 |
| Appendix 9 | Test Lead Options..... | A 15 |
| Appendix 10 | Rack Mounting..... | A 17 |
| Appendix 11 | Dimensional Diagram..... | A 19 |

Index _____ Index i

Introduction

Thank you for purchasing the HIOKI "Model BT3561A, BT3562A, BT3562, BT3562-01, BT3563A, BT3563, and BT3563-01 BATTERY HiTESTER." To obtain maximum performance from the instrument, please read this manual first, and keep it handy for future reference.

Please review the separate "Operating Precautions" before using the instrument.

This manual uses the following conventions:

The Model BT3561A, BT3562A, BT3562, BT3562-01, BT3563A, BT3563, and BT3563-01 are referred to as "the instrument."

Unless otherwise noted, the Model BT3562, BT3562-01, and BT3562A are referred to collectively as "Model BT3562," while the Model BT3563, BT3563-01, and BT3563A are referred to collectively as "Model BT3563."

Trademarks

Microsoft, Windows, Visual Studio, Visual Basic, Edge, and Visual C# are either registered trademarks or trademarks of Microsoft Corporation in the United States and other countries.

Verifying Package Contents

When you receive the instrument, inspect it carefully to ensure that no damage occurred during shipping. In particular, check the accessories, panel switches, and connectors. If damage is evident, or if it fails to operate according to the specifications, contact your dealer or Hioki representative. Use the original packing materials when transporting the instrument, if possible.

Confirm that these contents are provided. (One each)

- Model BT3561A BATTERY HiTESTER
- Model BT3562 BATTERY HiTESTER
- Model BT3562-01 (GP-IB version) BATTERY HiTESTER
- Model BT3562A (LAN version) BATTERY HiTESTER
- Model BT3563 BATTERY HiTESTER
- Model BT3563-01 (GP-IB version) BATTERY HiTESTER
- Model BT3563A (LAN version) BATTERY HiTESTER

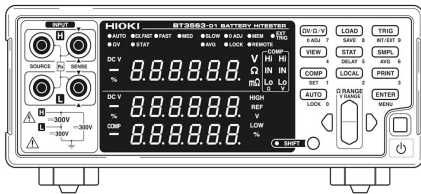

- Power Cord

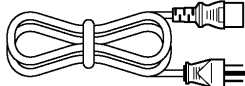

- Instruction Manual

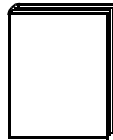

- Operating Precautions (0990A903)

Options

The following options are available for the instrument. Contact your authorized Hioki distributor or reseller when ordering. The options are subject to change. Visit our website for updated information.









- Model L2107 CLIP TYPE LEAD (60 VDC or less)
- Model 9453 FOUR TERMINAL LEAD (60 VDC or less)
- Model 9467 LARGE CLIP TYPE LEAD (50 VDC or less)
- Model 9770 PIN TYPE LEAD (60 VDC or less)
- Model 9771 PIN TYPE LEAD (60 VDC or less)
- Model L2100 PIN TYPE LEAD (1000 VDC or less)
- Model L2110 PIN TYPE LEAD (1000 VDC or less)
- Model Z5038 0 ADJ BOARD (for model L2100 and L2110)
- Model 9637 RS-232C CABLE (9-pin to 9-pin/cross cable)
- Model 9638 RS-232C CABLE (9-pin to 25-pin/cross cable)
- Model 9151-02 GP-IB CONNECTOR CABLE (2 m)
- Model 9642 LAN CABLE

Safety Information





WARNING

This instrument is designed to comply with IEC 61010 Safety Standards, and has been thoroughly tested for safety prior to shipment. However, mishandling during use could result in injury or death, as well as damage to the instrument. Be certain that you understand the instructions and precautions in the manual before use. We disclaim any responsibility for accidents or injuries not resulting directly from instrument defects.

This manual contains information and warnings essential for safe operation of the instrument and for maintaining it in safe operating condition. Before using it, be sure to carefully read the following safety precautions.

| | |
|---|---|
|  | In the manual, the  symbol indicates particularly important information that the user should read before using the instrument. |
|  | The  symbol printed on the instrument indicates that the user should refer to a corresponding topic in the manual (marked with the  symbol) before using the relevant function. |
|  | Indicates a grounding terminal. |
|  | Indicates DC (Direct Current). |
|  | Indicates the ON side of the power switch. |
|  | Indicates the OFF side of the power switch. |



The following symbols in this manual indicate the relative importance of cautions and warnings.

| | |
|---|---|
|  | DANGER Indicates that incorrect operation presents an extreme hazard that could result in serious injury or death to the user. |
|  | WARNING Indicates that incorrect operation presents a significant hazard that could result in serious injury or death to the user. |
|  | CAUTION Indicates that incorrect operation presents a possibility of injury to the user or damage to the instrument. |
|  | NOTE Indicates advisory items related to performance or correct operation of the instrument. |

Symbols for Various Standards

| | |
|---|---|
|  | This symbol indicates that the product conforms to regulations set out by the EU Directive. |
|---|---|

Other Symbols

| | |
|---|--|
|  | Indicates a prohibited action. |
| (p.) | Indicates the location of reference information. |
|  | Indicates quick references for operation and remedies for troubleshooting. |
| * | Indicates that descriptive information is provided below. |

Screen display

The screen of this instrument displays characters in the following manner.



Measurement categories

To ensure safe operation of measurement instruments, IEC 61010 establishes safety standards for various electrical environments, categorized as CAT II to CAT IV, and called measurement categories.

| | |
|---------|---|
| CAT II | Primary electrical circuits in equipment connected to an AC electrical outlet by a power cord (portable tools, household appliances, etc.) CAT II covers directly measuring electrical outlet receptacles. |
| CAT III | Primary electrical circuits of heavy equipment (fixed installations) connected directly to the distribution panel, and feeders from the distribution panel to outlets. |
| CAT IV | The circuit from the service drop to the service entrance, and to the power meter and primary overcurrent protection device (distribution panel). |

Using a measurement instrument in an environment designated with a higher-numbered category than that for which the instrument is rated could result in a severe accident, and must be carefully avoided.

Use of a measurement instrument that is not CAT-rated in CAT II to CAT IV measurement applications could result in a severe accident, and must be carefully avoided.

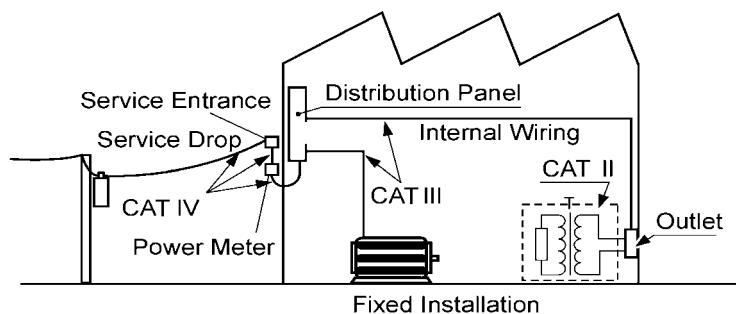

Accuracy

Hioki expresses accuracy as error limit values specified in terms of percentages relative to reading and full scale, and digits.

Full scale (Maximum displayable value)

Refers to the maximum displayable value of each measurement range. The instrument has measurement ranges whose values are equal to the maximum displayable values. The limit values of full-scale errors are expressed in percent of full scale (% of full scale, % f.s.).

Reading (Displayed value)

Refers to the displayed value of the measuring instrument. The limit values of reading errors are expressed in percent of reading (% of reading, % rdg).

Digits (Resolution)

Refers to the smallest change in the indication on the digital measuring instrument, i.e., the numeral one in the rightmost place. The limit values of digit errors are expressed in terms of digits (dgt).

Operating Precautions



Follow these precautions to ensure safe operation and to obtain the full benefits of the various functions.

Use of the instrument should conform not only to its specifications, but also to the specifications of all accessories, options, and other equipment in use.

Instrument Installation and Operating Environment

Operating temperature and humidity:

0 to 40°C (32 ± 104°F), 80%RH or less (non-condensating)

Temperature and humidity range for guaranteed accuracy:

23 ± 5°C (73 ± 9°F), 80% RH or less (non-condensating)

Avoid the following locations that could cause an accident or damage to the instrument.

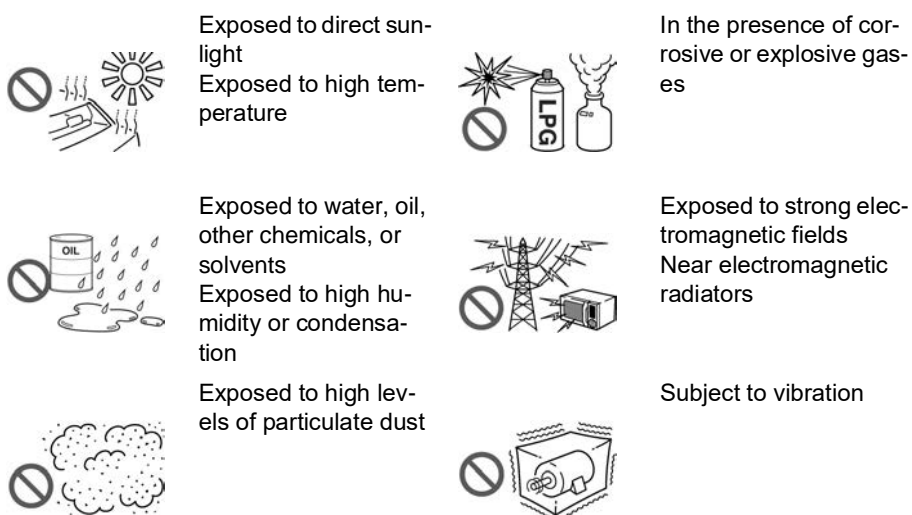

DANGER

To avoid electric shock, do not remove the instrument's case. The internal components of the instrument carry high voltages and may become very hot during operation.

NOTE

Avoid using near electrically noisy devices, as the noise may impinge upon the test object and cause unreliable measurements.

Installation Precautions

- The instrument should be operated only with the bottom downwards.
- Do not place the instrument on an unstable or slanted surface.

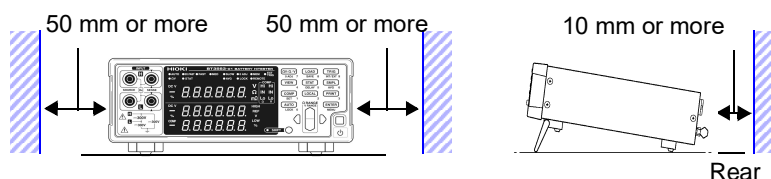

The instrument can be used with the stand. (p.15)

It can also be rack-mounted. Appendix (p. A17)

Preliminary Checks

Before using the instrument the first time, verify that it operates normally to ensure that no damage occurred during storage or shipping. If you find any damage, contact your dealer or Hioki representative.

WARNING

Before using the instrument, make sure that the insulation on the power cord and test leads is undamaged and that no bare conductors are improperly exposed. Using the instrument in such conditions could cause an electric shock, so contact your dealer or Hioki representative for replacements.

Measurement Precautions

DANGER

- To avoid electrical shock, be careful to avoid shorting live lines with the test leads.
- Do not use the instrument to measure circuits that exceed its ratings or specifications. Damage to the instrument or overheating can cause an electric shock.
- The maximum input voltage and maximum rated voltage are shown in the following table.

| Model | Maximum input voltage | Maximum rated voltage to earth |
|---------------------|-----------------------|--------------------------------|
| BT3561A | ±60 V DC | ±60 V DC |
| BT3562 BT3562-02 | ±60 V DC | ±70 V DC |
| BT3562A | ±100 V DC | ±100 V DC |
| BT3563 | ±300 V DC | ±300 V DC |

See: "9.1 Basic Specifications" (p.181)

- Never connect a battery cell or module to a motor or other load while it is being measured. Doing so may result in a surge voltage, which may damage the instrument or cause injury.

WARNING

- To prevent electrical shock, verify the ratings of the measurement leads before measurement and exercise care not to measure voltages that exceed those ratings.
- Do not touch the metallic tip of probes after measuring high-voltage batteries. Doing so may result in electrical shock since internal instrument components could retain a charge under those conditions. (Internal discharge time: Approx. 20 sec.)
- To avoid short-circuit accidents, connect the probe's banana terminals to the instrument before connecting the probes to the battery.

NOTE

- Use only the specified test leads and cables. Using a non-specified cable may result in incorrect measurements due to poor connection or other reasons.
- To ensure certified measurement accuracy, allow at least 30 minutes warm-up. After warm-up, be sure to execute self-calibration.

See "4.10 Self-Calibration" (p.73).

- The input circuitry includes a protective fuse. Measurement is not possible when the fuse is blown.
- This instrument internally stores (backs up) all settings (except memory function and measurement values), such as measurement range, comparator settings and etc., but only when no operation is performed for a certain time. Therefore, to preserve settings, do not turn the power off for a short time (about five seconds) after changing a setting. However, measurement settings made through the RS-232C, LAN, or GP-IB interface and measurement settings loaded by LOAD signals of the EXT I/O connector are not memorized.
- Select an appropriate measurement range when measuring batteries. Using a low range such as 3 mΩ to measure a button cell or other battery that has high internal resistance may result in an open-terminal voltage (approx. 4 V), causing the battery to be charged.

Before Connecting and Powering On**! WARNING**

- Before turning the instrument on, make sure the supply voltage matches that indicated on the its power connector. Connection to an improper supply voltage may damage the instrument and present an electrical hazard.
- To avoid electrical accidents and to maintain the safety specifications of this instrument, connect the power cord provided only to a 3-contact (two-conductor + ground) outlet.

NOTE

To suppress noise, the instrument needs to be set to match the frequency of the power source. Before operating, set the instrument to the frequency of your commercial power. If the supply frequency is not set properly, measurements will be unstable.

See "2.5 Selecting the Line Frequency" (p.24).

Make sure the power is turned off before connecting or disconnecting the power cord.

Handling the Instrument**! CAUTION**

- To avoid damage to the instrument, protect it from physical shock when transporting and handling. Be especially careful to avoid physical shock from dropping.
- Do not apply heavy downward pressure with the stand extended. The stand could be damaged.

NOTE

This instrument may cause interference if used in residential areas. Such use must be avoided unless the user takes special measures to reduce electromagnetic emissions to prevent interference to the reception of radio and television broadcasts.

Handling the Test Leads and Cables



- To avoid breaking the test leads and cables, do not bend or pull them.
 - Avoid stepping on or pinching cables, which could damage the cable insulation.
 - To avoid equipment failure, do not disconnect the communications cable while communications are in progress.
 - Use a common ground for both the instrument and the computer. Using different ground circuits will result in a potential difference between the instrument's ground and the computer's ground. If the communications cable is connected while such a potential difference exists, it may result in equipment malfunction or failure.
 - Before connecting or disconnecting any the communications cable, always turn off the instrument and the computer. Failure to do so could result in equipment malfunction or damage.
 - After connecting the communications cable, tighten the screws on the connector securely. Failure to secure the connector could result in equipment malfunction or damage.
-

Overview

Chapter 1

1

1.1 Product Overview

The Model BT3561A, BT3562 and BT3563 Battery Hitester measure battery internal resistance using a four-terminal, 1-kHz AC method, while simultaneously measuring DC voltage (electromotive force [emf]). The high-precision, fast measurement performance and extensive interface capabilities make these models ideal for incorporating into battery testing production lines.

1.2 Features

◆ Simultaneously Measures Battery Internal Resistance and Voltage

The four-terminal AC method measures resistance and DC voltage simultaneously, so battery internal resistance and emf are measured and judged at once.

◆ High-Precision Measurements

Resistance measurement resolution of 1 $\mu\Omega$ or 0.1 $\mu\Omega$ and voltage measurement resolution of 10 μV . The voltage measurement accuracy of $\pm 0.01\%$ of reading is achieved.

◆ High-Speed Measurements

Simultaneous resistance and voltage measurements can be performed as fast as once every 20 ms.

(Response time of approx. 10 ms + sampling time of approx. 8 ms)

◆ High-voltage measurement

The Model BT3563 supports measurement of high-voltage batteries of up to 300 V. (the Model BT3561A, BT3562, and BT3562-01 supports measurement of up to 60 V) (the Model BT3562A supports measurement of up to 100 V)

◆ Comparator Functions

Resistance and voltage measurement values are judged in three categories (Hi, IN and Lo), with results clearly displayed. A comparator judgment beeper also provides distinct sounds to indicate pass/fail judgments and to facilitate correct recognition of judgment results.

◆ Statistical Calculation Functions

Maximum, minimum and average measurement values, standard deviation, process capability indices and other values can be automatically calculated for applications such as production management. Calculation results can also be applied as comparator setting values.

◆ Measurement Value Memory Function

The instrument includes a Memory function and storage capacity for up to 400 pairs of measurement values. When making many sequential measurements at high speed and sending the measured values to a PC after each measurement, the time to switch test objects can become unsatisfactorily long. The Memory function can avoid the slow-down by sending stored measurements in batches during idle times.

◆ EXT I/O Interface

EXT I/O and RS-232C interfaces are equipped as standard, supporting transfer rates up to 38,400 bps.

- Model BT3562-01 and BT3563-01 also supports GP-IB and analog output.
- Model BT3561A, BT3562A, and BT3563A also supports LAN and analog output.

◆ Printing Measurement Values and Statistical Results

Connect the printer to print measurement values and statistical calculation results.

1.3 Names and Functions of Parts

1

Chapter 1 Overview

Front Panel

Input Terminals (INPUT)

Connect the optional test leads.

See "2.3 Connecting the Optional Test Leads" (p.21)

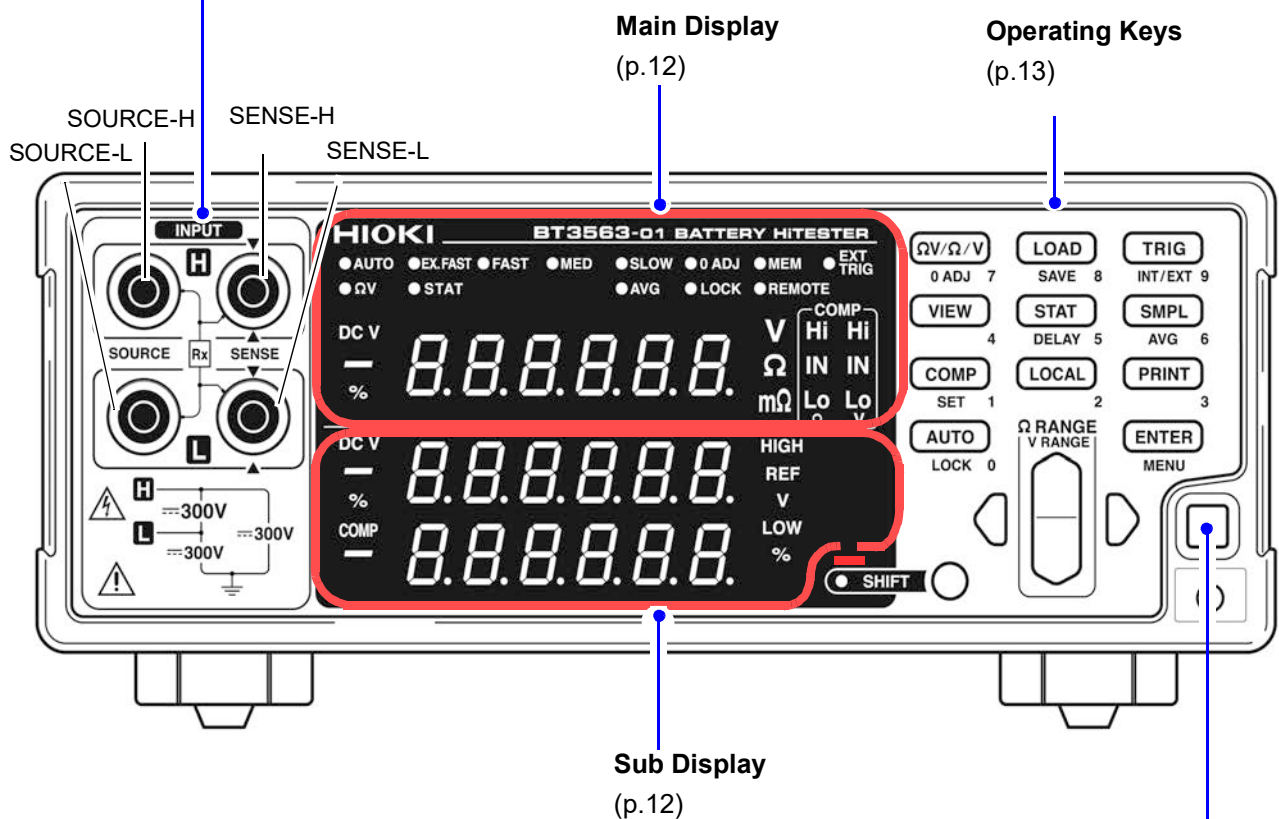

POWER Switch

Turns the instrument on and off (Standby).

Turns the power on and off (standby).

Off (standby) → On (cancel standby)

On (press and hold for 1 second) → Off (standby)

(The main power switch is located on the back of the instrument.)

See "2.4 Turning the Power On and Off" (p.22)

Main Display

The current measurement mode is indicated while measuring, and the setting item is displayed while making settings.

(Upper row)

AUTO Lit when measuring with Auto-Ranging.

EX.FAST, FAST, MED, SLOW

The selected Sampling Rate is lit.

0 ADJ Lit when measuring in a range for which Zero-Adjustment has been performed.

MEM Lit when the Memory function is enabled.

EXT TRIG Lit when the External Trigger function is enabled.

(Lower row)

Ω V Lit when the Ω V (Resistance and Voltage measurement) mode is selected.

STAT Lit when the Statistical Calculation function is enabled.

AVG Lit when measuring with the Averaging setting enabled.

LOCK Lit when the keys are locked.

REMOTE Lit during communications.

Lit when measuring voltage.

Indicates percentage units during relative value comparator operation.

Shows measured value or setting item.

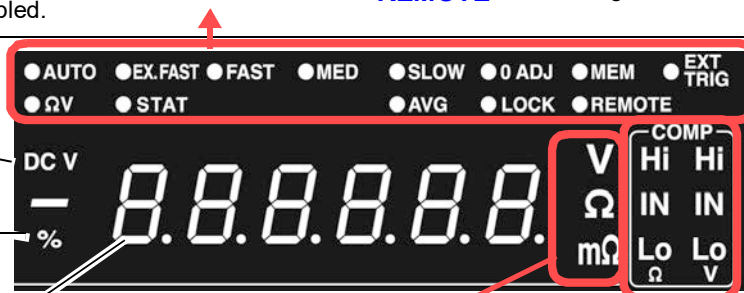

Units of displayed measurement

- V** Unit of voltage
- Ω** Unit of resistance (lit when the 3 Ω to 3000 Ω range is selected)
- m Ω** Unit of resistance (lit when the 3 m Ω to 300 m Ω range is selected)

Shows Comparator Decision Result.

- Hi** Indicates that the measured value is above the upper threshold.
- IN** Indicates that the measured value is between the upper and lower thresholds.
- Lo** Indicates that the measured value is below the lower threshold.

Sub Display

Upper and lower thresholds and other settings are displayed (when set).

Indicates Voltage measurement mode

Indicates percentage units during relative value comparator operation

While measuring, indicates the Comparator function is enabled.



HIGH, LOW Indicates that absolute value comparator operation is enabled (while measuring), and also when setting.

REF, % Indicates that relative value comparator operation is enabled (while measuring), and also when setting.

V Indicates voltage measurement units.

Operating Keys

To use a function marked on a key, just press the key.

To use a function printed under a key (blue letter), press the **SHIFT** key first (and confirm the SHIFT lamp is lit), and then the key.

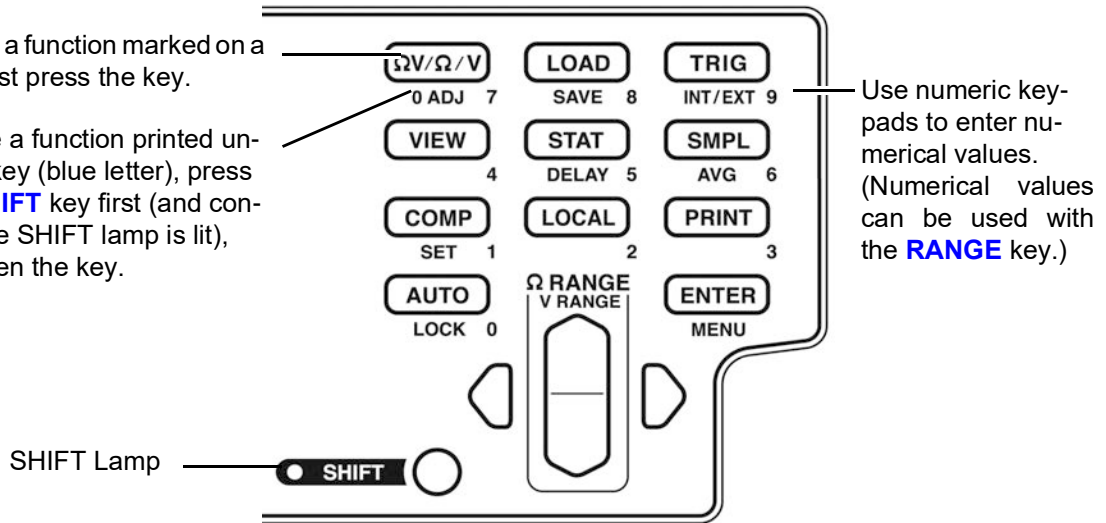

[]: Enabled after pressing the **SHIFT** key (SHIFT lamp lit).

| Operating Key | Description |
|------------------|---|
| ΩV/Ω/V | Selects Measurement mode. (Resistance and voltage measurement, Resistance measurement or Voltage measurement) |
| [0 ADJ] | Executes Zero-Adjustment. |
| LOAD | Loads a saved measurement configuration (Panel settings). |
| [SAVE] | Saves the current measurement configuration (Panel settings). |
| TRIG | Executes a Manual Trigger event. |
| [INT/EXT] | Selects internal/external triggering. |
| VIEW | Switches the view mode of the ΩV mode. |
| STAT | Displays and sets Statistical Calculation results. |
| [DELAY] | Sets the Trigger Delay. |
| SMPL | Selects the Sampling Rate. |
| [AVG] | Activates Averaging function settings. |
| COMP | Switches the Comparator function on and off. |
| [SET] | Activates Comparator function setting. |
| LOCAL | Cancels remote control (RMT) and re-enables key operations. |

| Operating Key | Description |
|------------------|--|
| PRINT | Sends measurement values and statistical calculation results to the printer. |
| AUTO | Switches between Auto and Manual range selection. |
| [LOCK] | Switches the Key-Lock function on and off. |
| ENTER | Applies settings. |
| [MENU] | Selects various operating functions and settings. |
| Ω RANGE | Up/Down: Changes setting value or numerical value, and sets the resistance measurement range. Left/Right: Moves the setting item or digit. |
| [V RANGE] | Up/Down: Sets voltage measurement range. |
| SHIFT | <ul style="list-style-type: none"> Enables the functions of the operating keys marked in blue. The lamp is lit when the SHIFT state is active. Cancels settings in various setting displays. (Returns to the Measurement display without applying settings.) However, this does not apply to Menu display. However, from a menu item display, changed settings are not canceled, but accepted as the display returns to measurement display (except after Zero-Adjustment clear or resetting). |

Rear Panel

* The illustration shows the Model BT3563-01 Battery Hitester (GP-IB version).

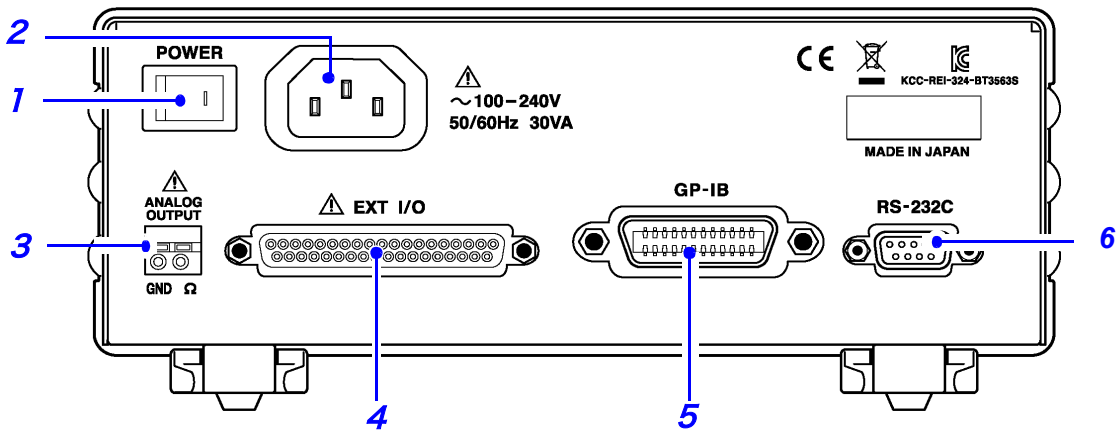

* The illustration shows the Model BT3563A Battery Hitester (LAN version).

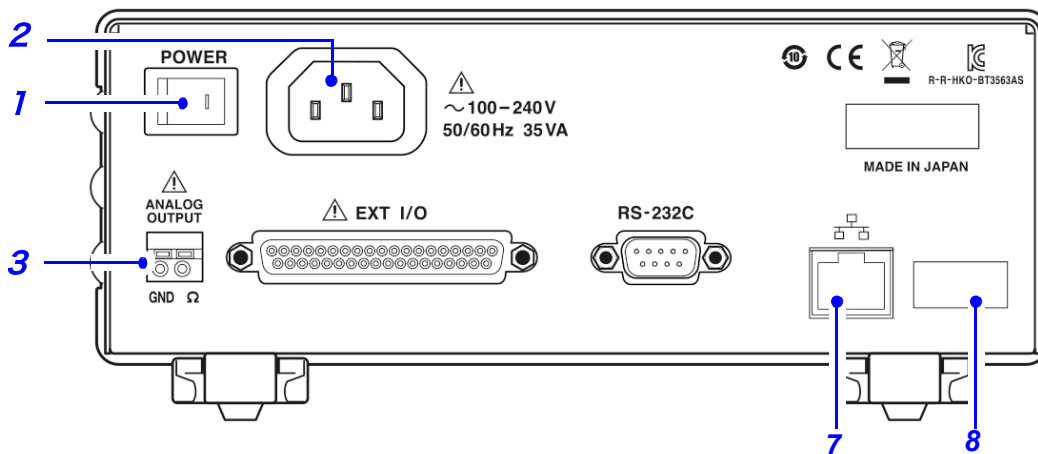

| No. | Name | Description | Reference |
|-----|---|---|-----------|
| 1 | Main power switch | ⊙: Main power off ⊐: Main power on | p. 22 |
| 2 | Power Inlet | Connect the supplied power cord here. | p. 20 |
| 3 | Analog output connector (Model BT3561A, BT3562A, BT3562-01, BT3563A, and BT3563-01 only) | Connect when using analog output (of resistance measured values). | p. 99 |
| 4 | EXT I/O Connector | Connect here to use the EXT I/O interface. | p. 80 |
| 5 | GP-IB Connector (Model BT3562-01, BT3563-01 only) | Connect here to use the GP-IB interface. | p. 102 |
| 6 | RS-232C Connector | Connection for the printer or RS-232C interface. | p. 102 |
| 7 | LAN Connector (Model BT3561A, BT3562A, and BT3563A only) | Connect here to use the LAN interface. | p. 102 |
| 8 | MAC address | MAC address of the LAN. | |

Side View

Stand

Can be opened to tilt the front panel upwards.

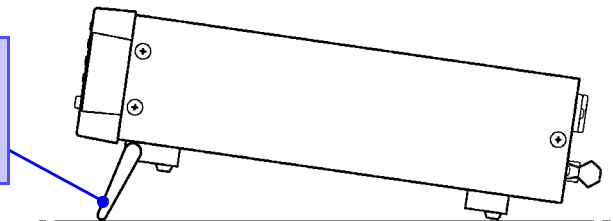

CAUTION

Do not apply heavy downward pressure with the stand extended. The stand could be damaged.

1.4 Menu Display Sequence (SHIFT → ENTER)

Various auxiliary settings can be performed from the menu item displays.

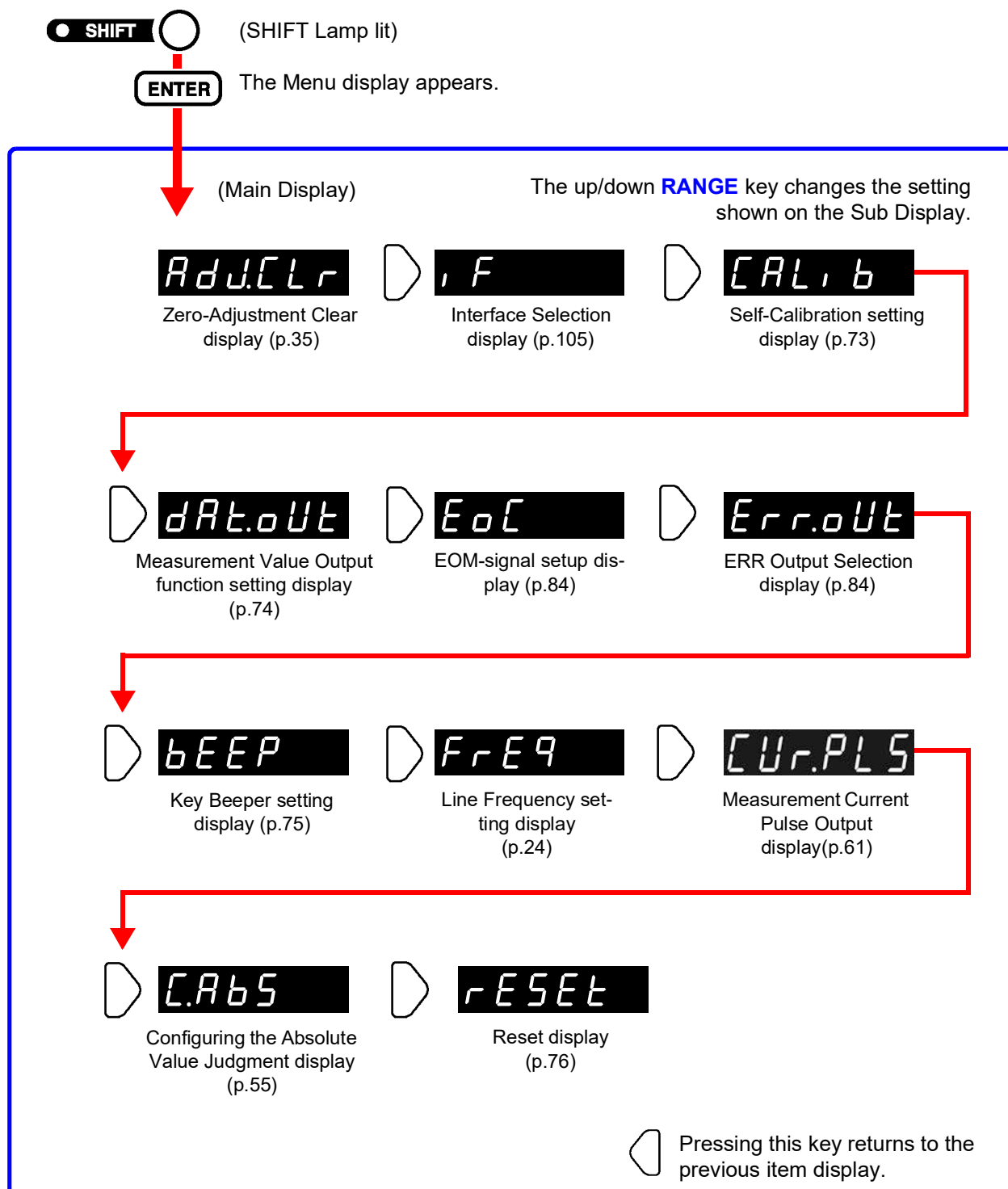

NOTE

Settings on the menu item displays are applied and saved internally when changed.

1.5 Measurement Flowchart

The basic measurement process flow is as follows:

Measurement Preparations

Connecting the power cord (p.20)



Connecting the test leads (p.21)



Turning the power on (p.22)



Selecting the line frequency (p.24)

Instrument's Settings

Selecting measurement mode (p.30)



Selecting measurement range (p.31)



Selecting sampling rate (p.34)

Zero-Adjustment

Short the test leads together (p.35)



Executing zero-adjustment

Measurement Start

Connect the test leads to a test object.



Read the measured value (p.38)

For details about the functions that can be applied to measurement values such as comparator, trigger and averaging functions, refer to "Chapter 4 Applied Measurement" (p.41).

Measurement Preparations

Chapter 2

2

Chapter 2 Measurement Preparations

2.1 Preparation Flowchart

This procedure describes instrument preparations such as making connections and turning power on.

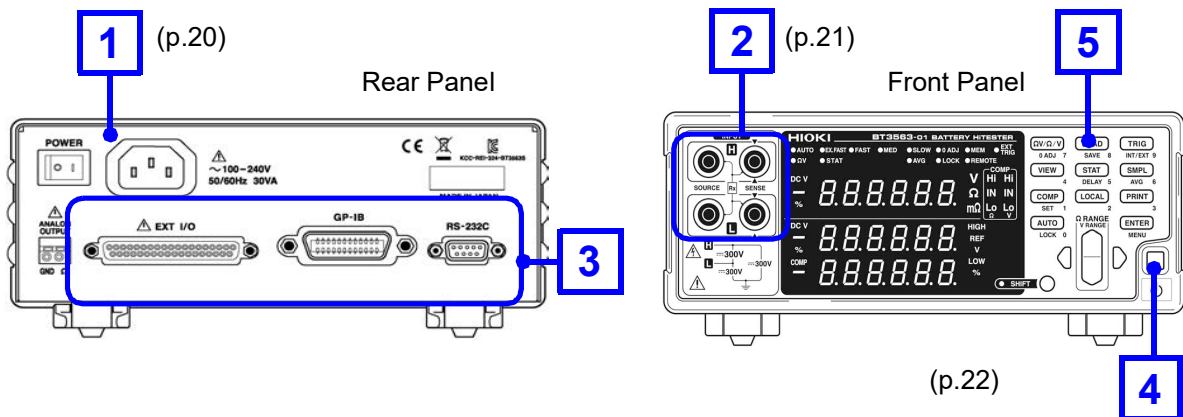

1 Connecting the power cord. (p.20)

2 Connect the test leads to the instrument. (p.21)

3 Connect the EXT I/O connector and interface connector. (p.102)

4 Turn the power on. (p.22)

5 Set measurement settings. (p.25)

6 Start measurement.

NOTE

Verify that the instrument's line frequency is correctly set when using it for the first time and after initialization following repair or recalibration.
See "2.5 Selecting the Line Frequency" (p.24).

2.2 Connecting the Power Cord



! WARNING

To avoid electrical accidents and to maintain the safety specifications of this instrument, connect the power cord provided only to a 3-contact (two-conductor + ground) outlet.

! CAUTION

To avoid damaging the power cord, grasp the plug, not the cord, when unplugging it from the power outlet.

NOTE

To suppress noise, the instrument needs to be set to match the line frequency. Before operating, set the instrument to the frequency of your commercial power. If the supply frequency is not set properly, measurements will be unstable.

See "2.5 Selecting the Line Frequency" (p.24).

Make sure the power is turned off before connecting or disconnecting the power cord.

Rear Panel

- 1.** Confirm that the instrument's Main power switch (rear panel) is OFF (○).
- 2.** Check that the power supply voltage (100 V to 240 V) is correct, and connect the power cord to the power inlet socket on the rear of the instrument.
- 3.** Plug the power cord into the AC outlet.

2.3 Connecting the Optional Test Leads



! WARNING

- To prevent an accident caused by short-circuiting the battery, be sure to verify that nothing is connected to the tips of the measurement leads before connecting the leads to or disconnecting them from the instrument. (Contact between the banana terminals while the tips of the measurement leads are connected to the battery will short-circuit the battery, possibly resulting in serious injury.)
- To prevent electrical shock, verify the ratings of the measurement leads before measurement and exercise care not to measure voltages that exceed those ratings.

Test leads are not included as standard accessories with the instrument, so the appropriate options need to be purchased separately or constructed according to the user's application requirements. To construct custom test leads, refer to "Precautions for Making Custom Test Leads"(p.A1). The resistance measurement terminals on this instrument consist of four separate banana jacks.

See "Appendix 1 Precautions for Making Custom Test Leads"(p.A1).

1. Confirm that the instrument's Power switch is OFF.
2. Verify that nothing is connected to the tips of the four-terminal measurement leads.
3. Connect four-terminal test leads such as the L2107 CLIP TYPE LEAD to INPUT.

Plug the ▲ mark on the red lead into the red ▲ marked jack on the instrument, and plug the ▲ mark on the black lead into the black ▲ marked jack on the instrument.

Example: Optional model L2107 CLIP TYPE LEAD

About Test Leads

(Example: Model L2107 CLIP TYPE LEAD)

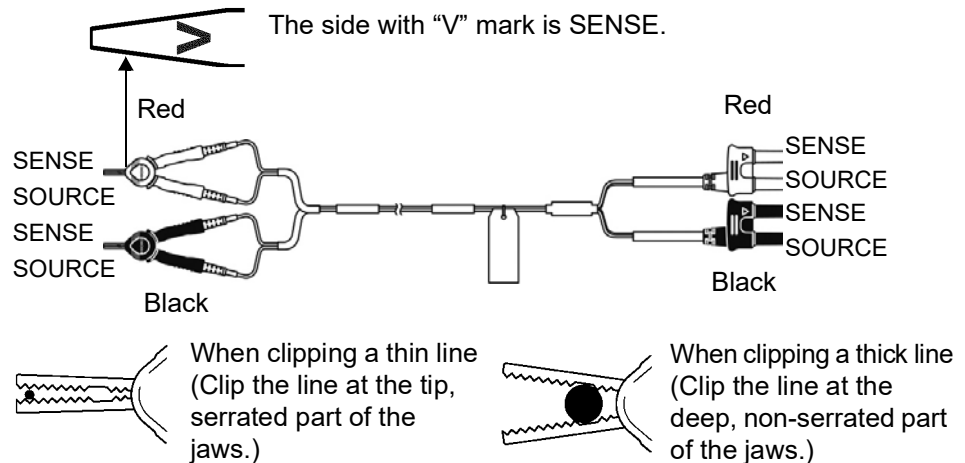

2.4 Turning the Power On and Off

⚠ WARNING

Before turning the instrument on, make sure the supply voltage matches that indicated on the its power connector. Connection to an improper supply voltage may damage the instrument and present an electrical hazard.

NOTE

- The measurement setting state is the same as when the power was previously turned off (backup).
To preserve changes to settings, wait a short time (about five seconds) after changing a setting before turning power off.
- However, measurement settings made through the RS-232C, LAN, or GPIB interface and measurement settings loaded by $\overline{\text{LOAD}}$ signals of the EXT I/O connector are not memorized.
- Before starting to measure, allow 30 minutes for warm-up.
After warm-up, be sure to perform a self-calibration.
See "4.10 Self-Calibration" (p.73).

Turning On (I) the Main Power Switch (Rear of Instrument)

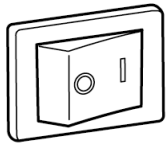

Power ON I

Turn on the main power switch on (I) the rear of the instrument.
The instrument will start up in the standby state in which it was last turned off. (The instrument ships in the standby state.)

Turning the Power Off

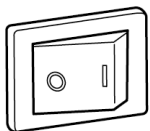

Power OFF ○

Turn off the main power switch on the rear of the instrument.(○).

Canceling the Standby State



Press the power switch on the front of the instrument while it is in the standby state.

bt3563 (Main Display)
Model name



1.00 (Main Display)
Software version

50 (Sub Display)
Line frequency

r5 Interface



The measurement display appears.

Placing the Instrument in the Standby State



Press and hold the power switch on the front of the instrument for approximately 1 second while it is in the operating state.

2.5 Selecting the Line Frequency

The instrument's power supply frequency must be set in order to eliminate noise. Although the power supply frequency setting is configured automatically ("AUTO") by default, it can also be set manually. Measured values will not stabilize if the power supply frequency is not set properly.

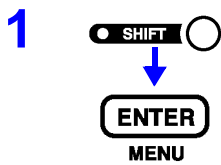

(The SHIFT indicator lights up.)

The Menu display appears.



Select the Line Frequency setting display.
See "1.4 Menu Display Sequence (SHIFT → ENTER)" (p.16).

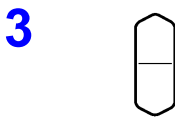

Select the frequency of the AC mains supply being used.

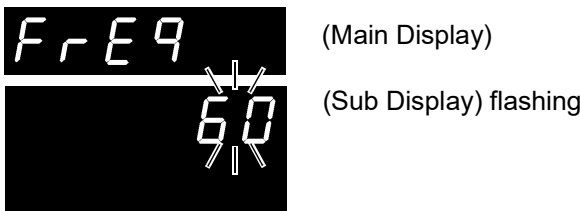

AUTO Automatic configuration of power supply frequency

50 50 Hz

60 60 Hz



Applies settings and returns to the Measurement display.

NOTE

- When set to automatic configuration (AUTO), a power supply frequency of either 50 Hz or 60 Hz will be automatically detected whenever the instrument is turned on or reset.
- Changes in the power supply frequency occurring at other times will not be detected.
- The power supply frequency will be set to either 50 Hz or 60 Hz, whichever is closer.

Measurement

Chapter 3

Before starting measurement, please read **Operating Precautions (Page 5)** and **"Chapter 2 Measurement Preparations" (p.19)**.



- To avoid electrical shock, be careful to avoid shorting live lines with the test leads.
- Do not use the instrument to measure circuits that exceed its ratings or specifications. Damage to the instrument or overheating can cause an electric shock. The maximum input voltage and maximum rated voltage are shown in the following table. see: "9.1 Basic Specifications" (p.181)

| Model | Maximum input voltage | Maximum rated voltage to earth |
|---------------------|-----------------------|--------------------------------|
| BT3561A | ±60 V DC | ±60 V DC |
| BT3562 BT3562-02 | ±60 V DC | ±70 V DC |
| BT3562A | ±100 V DC | ±100 V DC |
| BT3563 | ±300 V DC | ±300 V DC |



To prevent electrical shock, verify the ratings of the measurement leads before measurement and exercise care not to measure voltages that exceed those ratings.

3.1 Pre-Operation Inspection

Before using the instrument for the first time, verify that it operates normally to ensure that no damage occurred during storage or shipping. If you find any damage, contact your dealer or Hioki representative.

Before using the instrument, perform the following inspection to ensure that it is operating properly.

| Check Point | Check Contents |
|--|---|
| Instrument Chassis (both front and rear panels) | <ul style="list-style-type: none"> • No damage or cracks • No internal circuitry is exposed |
| Test Leads and Power Cord | <ul style="list-style-type: none"> • Metal parts that should be insulated are not exposed |
| Good Test Sample | <ul style="list-style-type: none"> • Measures as good and displays the correct measurement value |
| Bad Test Sample | <ul style="list-style-type: none"> • Measures as bad and displays the correct measurement value |

If the inspection reveals a defect, stop using the instrument and contact your dealer or Hioki representative.

3.2 Basic Measurement Example

The following example describes the measurement process.

Example: Measuring resistance and voltage of a 30 mΩ lithium-ion battery

| | |
|-------------------------|--|
| Required items: | Lithium-ion battery (30 mΩ) Test leads: Model 9770 PIN TYPE LEAD are used here. |
| Measurement conditions: | Measurement mode..... ΩV (Resistance and Voltage measurement) Range 30 mΩ, 6 V Sampling range SLOW Zero adjustment..... Enabled |

Preparations

- 1 Connect the power cord.
See "2.2 Connecting the Power Cord" (p.20).

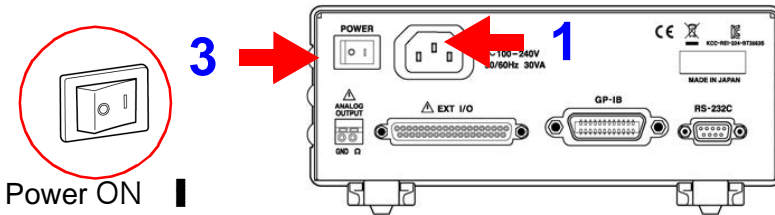

- 2 Connect the test leads.
See "2.3 Connecting the Optional Test Leads" (p.21).

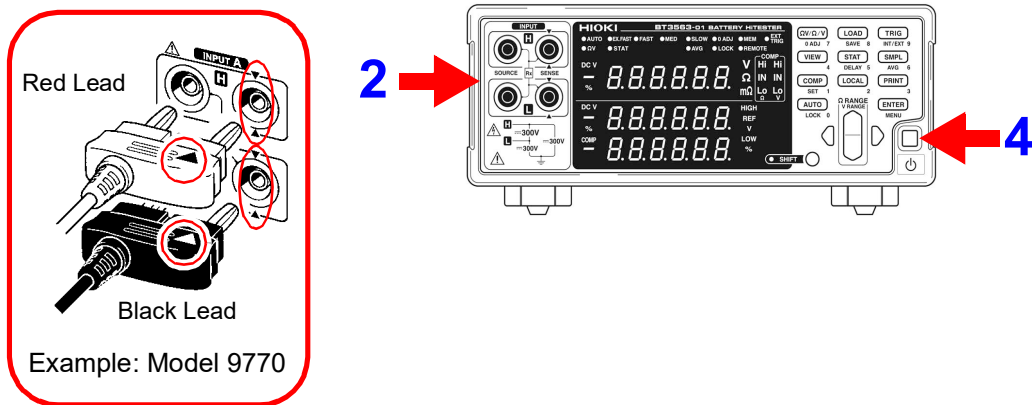

- 3 Turn the main power switch on.
See "2.4 Turning the Power On and Off" (p.22).
See "2.5 Selecting the Line Frequency" (p.24).

- 4 Cancel the standby state.
See "2.4 Turning the Power On and Off" (p.22).

Instrument Settings

- 5 Confirm the SHIFT lamp is not lit.
If this is lit, press the **SHIFT** key to turn it off.

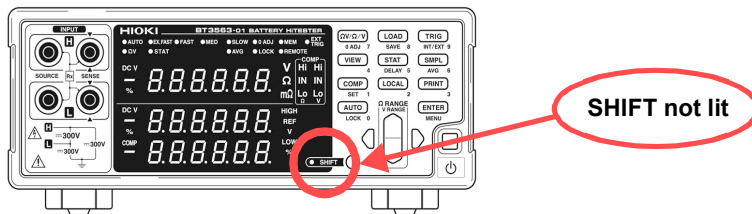

- 6 **ΩV/Ω/V** Select the Resistance Measurement mode.
(Here, resistance and voltage measurement is selected.)
See "3.3 Selecting Measurement Mode" (p.30).

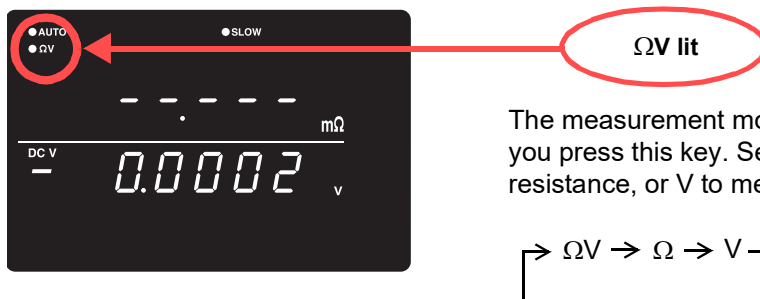

- 7 Set the measurement range. (Here, 30 mΩ range is selected.)
See "3.4 Setting Measurement Range" (p.31).

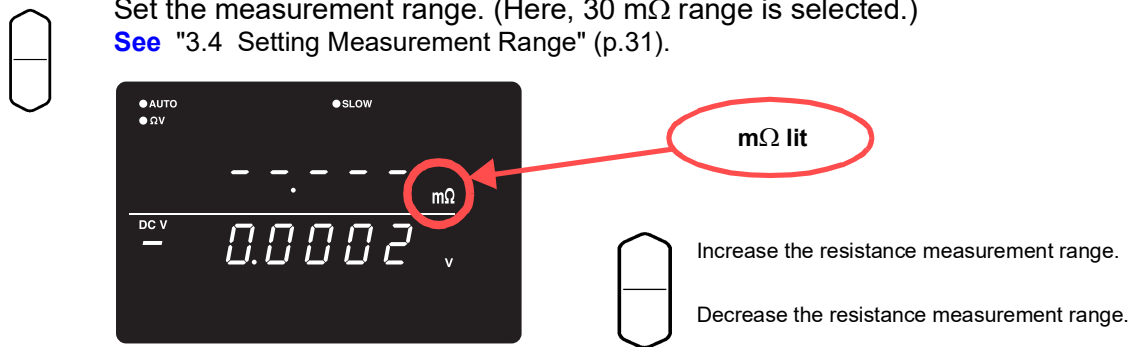

- 8 (SHIFT Lamp lit)
Set the voltage measurement range. (Here, the 6 V setting has been selected.)
See "Voltage measurement range" (p.32)

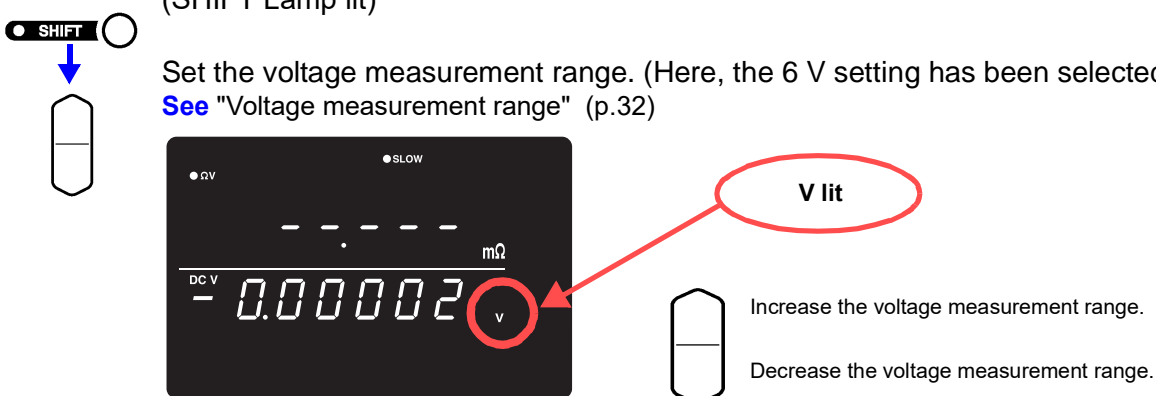

- 9 **SMPL** Set the sampling rate. (Here, SLOW is selected.)
See "3.5 Setting Sampling Rate" (p.34).

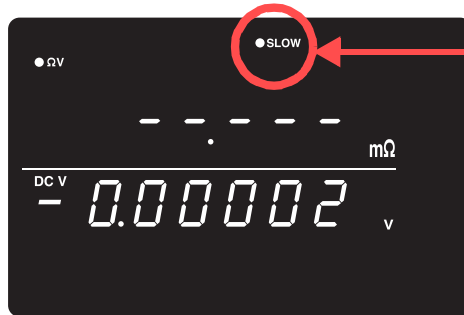

SLOW lit

The sampling rate changes each time you press this key.

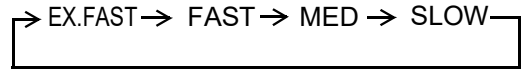

Zero-Adjustment

- 10 Short the test leads together.
Proper Zero-Adjustment is not possible with incorrect wiring.

See "3.6 Zero-Adjust Function" (p.35).

Example: Model 9770 Pin Type Lead

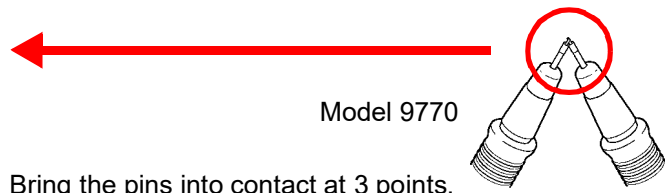
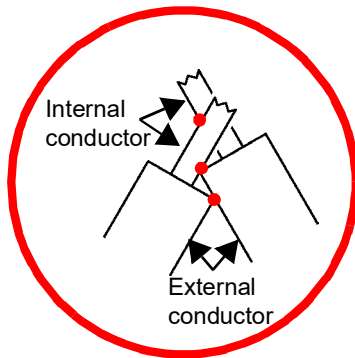

- Bring the pins into contact at 3 points.
- Internal conductor and internal conductor
 - Internal conductor and external conductor
 - External conductor and external conductor

- 11 **SHIFT** (The SHIFT indicator lights up.)

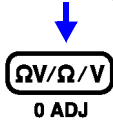

Execute Zero-Adjust.
After zero-adjustment, the display returns to the measurement mode.

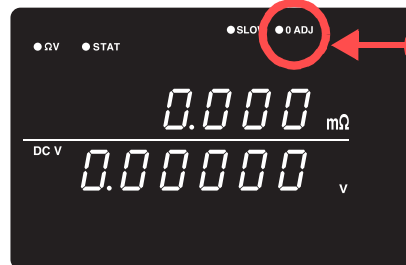

"Err.02" appears if Zero-Adjustment fails. Verify that the test lead tips are properly shorted, and try zero-adjustment again.

Measurement

- 12** Connect the test leads to a battery.

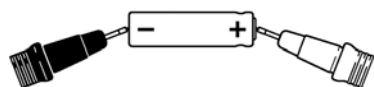

NOTE

Open-terminal voltages for the instrument are as follows:

3 m Ω and 30 m Ω ranges: 25 V peak

300 m Ω range: 7 V peak

3 Ω to 3000 Ω range: 4 V peak

These voltages derive from the load associated with charging the 1.2 μ F capacitor inside the instrument.

- The open-terminal voltage for the 3 m Ω , 30 m Ω , and 300 m Ω ranges peaks at 4 V approximately 500 ms after the terminal is placed in the open state.
- When building a measurement line using scanners, use a relay with a dielectric strength that is greater than or equal to the open-terminal voltage for the range being used.

- 13** Read the measured resistance and voltage.

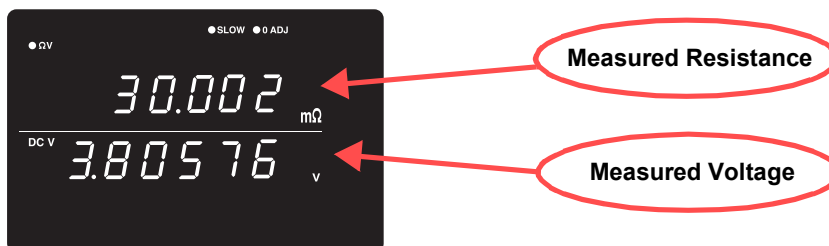

See "3.7 Displaying Measurement Results" (p.38).

See "10.3 Error Display" (p.191).

NOTE

Please refer to "Before returning for repair." of "Measured value is unstable." (p.190) as a measurement and attention.

3.3 Selecting Measurement Mode

Select the measurement mode from ΩV (both resistance and voltage measurement), Ω (resistance measurement only) or V (voltage measurement only).

- 1 Confirm the SHIFT lamp is not lit.
If this is lit, press the **SHIFT** key to turn it off.

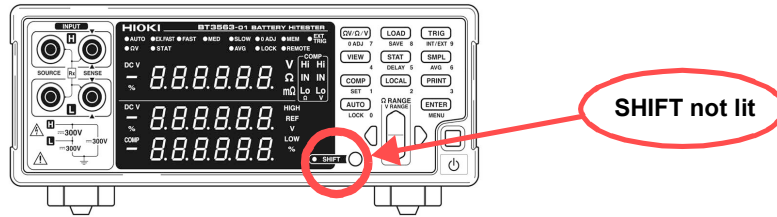

- 2 **ΩV/Ω/V** Switches the displayed measurement mode.
Each key-press switches the measurement mode.

ΩV mode
(Resistance and Voltage measurement) measurement)



Ω mode
(Resistance measurement)

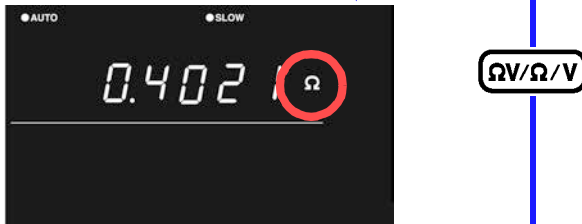

V mode
(Voltage measurement)

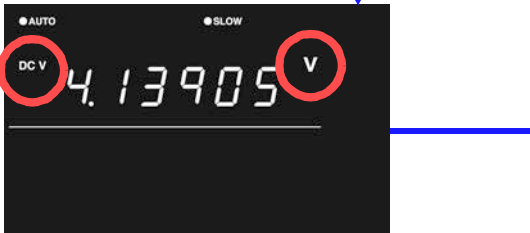

NOTE

The fastest measurements are provided by selecting the Ω or V mode when measuring resistance or voltage, respectively.
See " Sampling Time" (p.182).

3.4 Setting Measurement Range

This section describes how to set the measurement range for resistance or voltage measurement.

Choose a resistance measurement range from among the following ranges:

- Six ranges, including the 30 m Ω through 3000 Ω ranges (For the BT3561A)
- Seven ranges, including the 3 m Ω through 3000 Ω ranges (For the BT3562 and BT3563)

Choose a voltage measurement range from among the following ranges:

- Two ranges, including the 6 V through 60 V ranges (For the BT3561A, BT3562, and BT3562-01)
- Three ranges, including the 6 V through 100 V ranges (For the BT3562A)
- Three ranges, including the 6 V through 300 V ranges (For the BT3563)

There is also an auto-range function, which determines the optimal range automatically.

Resistance measurement range

1



Select the resistance measurement range.

The position of the decimal point and unit of measurement on the display will be switched according to the selected range.

2

Select the range to use.

When the 3 Ω range is selected

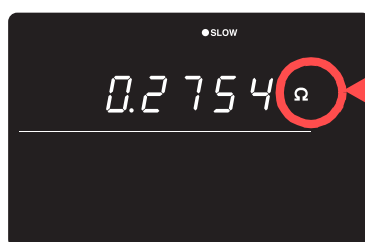

Ω lit

When the 300 m Ω range is selected

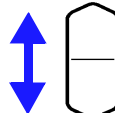

Increase the resistance measurement range.

Decrease the resistance measurement range.

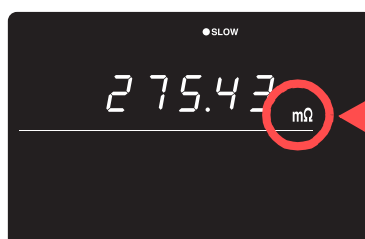

m Ω lit

NOTE

Pressing the up or down keys while in auto-range mode will cancel auto-ranging, leaving the current measurement range as the manually set range.

Voltage measurement range

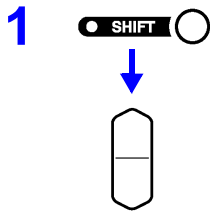

Select the voltage measurement range.
The position of the decimal point and unit of measurement on the display will be switched according to the selected range.

2 Select the range to use.

When the 60 V range is selected

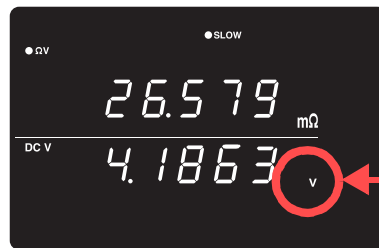

V lit

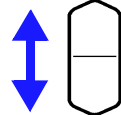

Increase the voltage measurement range.

When the 6 V range is selected

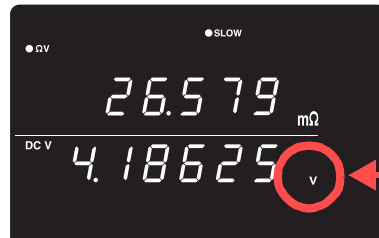

V lit

Decrease the voltage measurement range.

Auto-Ranging

AUTO

When manual range selection is enabled, pressing this enables auto-ranging. The most suitable measurement range is then selected automatically.

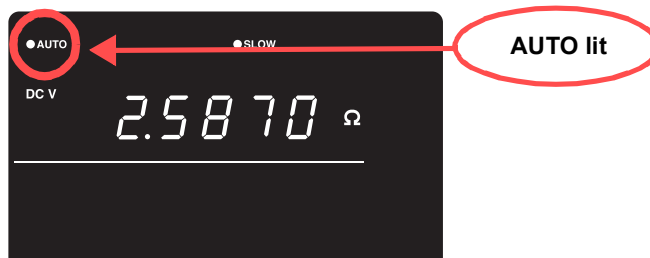

NOTE

The auto-range setting (on/off) for the Ω V function applies to both resistance and voltage measurement.



Switching from Auto-ranging back to Manual range selection

Press the **AUTO** key again. The range can now be changed manually.

NOTE

- Depending on the state of the test object, auto-ranging may be unstable. In this case, select the range manually, or increase the Delay time.
- Auto-ranging is not available when Comparator or Memory functions are enabled (ON).
- Refer to "Specifications" (p.181) for details about accuracy.

| Range | Displayed Values | Resistance Measurement Mode | |
|---------------------|-------------------------------|-----------------------------|-----------------------|
| | | Measured Current | Open-Terminal Voltage |
| 3 m Ω | -0.1000 to 3.1000 m Ω | 100 mA | 25 V peak |
| 30 m Ω | -1.000 to 31.000 m Ω | 100 mA | 25 V peak |
| 300 m Ω | -10.00 to 310.00 m Ω | 10 mA | 7 V peak |
| 3 Ω | -0.1000 to 3.1000 Ω | 1 mA | 4 V peak |
| 30 Ω | -1.000 to 31.000 Ω | 100 μ A | 4 V peak |
| 300 Ω | -10.00 to 310.00 Ω | 10 μ A | 4 V peak |
| 3000 Ω | -100.0 to 3100.0 k Ω | 10 μ A | 4 V peak |
| 6 V | -6.00000 V to \pm 6.00000 V | -- | -- |
| 60 V | -60.0000 V to \pm 60.0000 V | -- | -- |
| 100 V ^{*1} | -100.000 V to \pm 100.000 V | -- | -- |
| 300 V ^{*2} | -300.000 V to \pm 300.000 V | -- | -- |

*1: BT3562A only

*2: BT3563A, BT3563 or BT3563-01 only

3.5 Setting Sampling Rate

The sampling rate can be selected from EX.FAST, FAST, MEDIUM and SLOW. Slower sampling rates generally provide greater measurement precision.

SMPL Selects the sampling rate

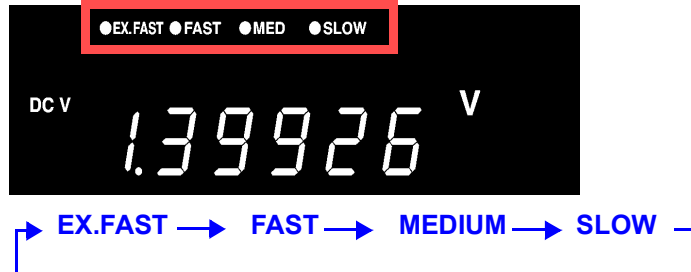

NOTE

- Measurements are especially susceptible to interference from the environment when EX.FAST is selected, so countermeasures such as shielding or twisting of test leads, cables and wiring around the test object may be necessary.
See "Appendix 1 Precautions for Making Custom Test Leads" (p.1)
- When SLOW sampling is selected, self-calibration is executed during each measurement. At other sampling rates, self-calibration is executed manually or automatically every 30 minutes.
See "4.10 Self-Calibration" (p.73).
- Refer to the specifications for details of sampling rates.
See " Sampling Time" (p.182).

3.6 Zero-Adjust Function

Execute zero adjustment before measuring to nullify any residual offset voltage from the instrument or measurement environment. Measurement accuracy specifications are applicable after zero adjustment. Zero adjustment can also be executed by the 0ADJ terminal of the EXT I/O connector.

See "5.2 Signal Descriptions" (p.80).

Wiring Method for Zero-Adjustment

- Before executing zero adjustment, connect the test leads (probes) as follows:
1. Connect SENSE-H to SENSE-L.
 2. Connect SOURCE-H to SOURCE-L.
 3. Connect the joined SENSE and SOURCE leads together as shown below.

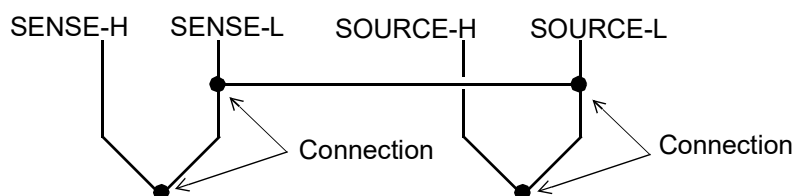

Executing Zero-Adjustment

1

Position the measurement leads in the actual measurement state. Since the amount of zero adjustment varies with the position and state of the measurement leads (probes) (i.e., their length, shape, position, etc.), the measurement leads must be positioned in the actual measurement state before performing zero adjustment.

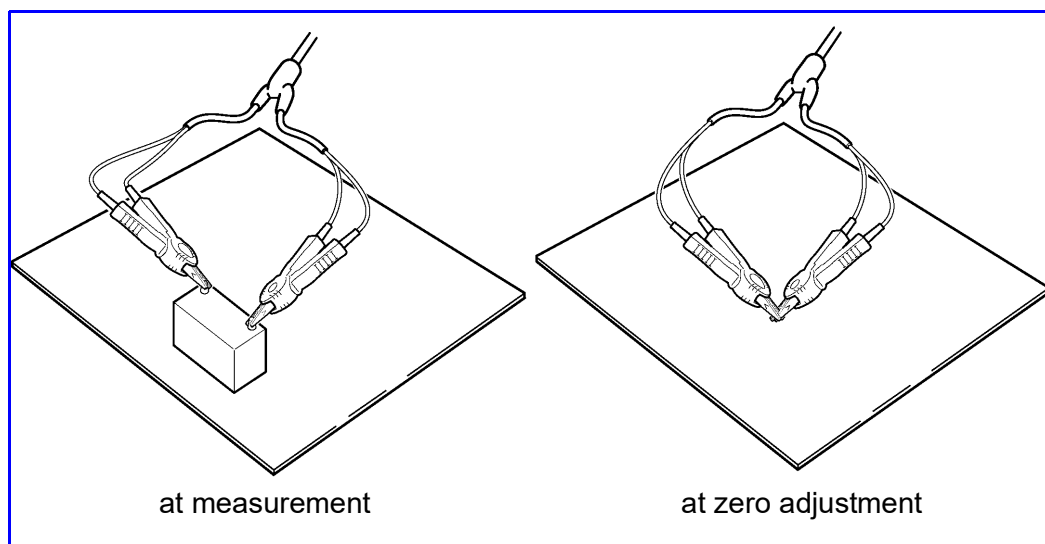

These variations are particularly pronounced in the 3 mΩ and 30 mΩ ranges, so be sure to position the leads in same state as will be used to perform actual measurement when using those configurations.

2

Short the test leads together.
Proper zero adjustment is not possible with incorrect wiring.

Example: Model L2107 CLIP TYPE LEAD

Correct

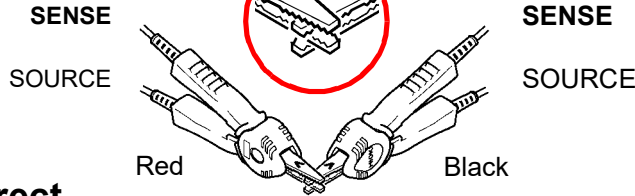

Incorrect

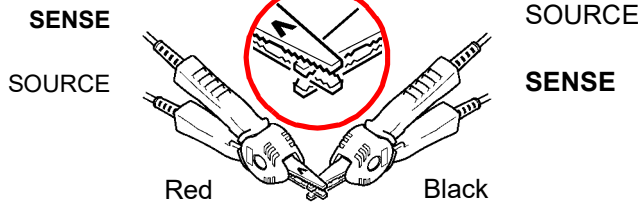

Model 9453 (Option)

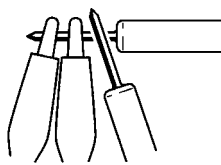

Perform zero adjustment with the alligator clips and lead rods placed as above.

Model 9770 (Option)

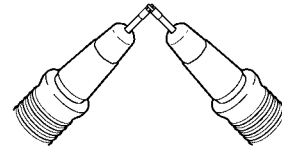

Bring the pins into contact at 3 points.

Model 9771 (Option)

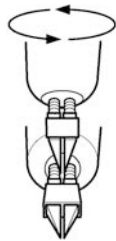

When the resistance measurement value is displayed as "----", change the facing direction.

Let the two points of the pin tip touch the spring part perpendicularly (be careful not to short the springs).

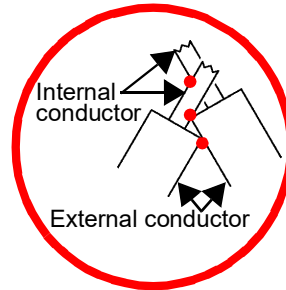

Model L2100 (Option)

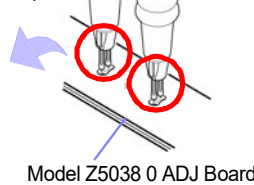
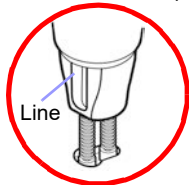

Each SENSE pin has a line affixed to its base. When using the zero-adjust feature, orient the test lead so that the surface the same direction.
 Choose a hole suited to the distance between the terminals on the battery subject to measurement and hold the test lead against the zero-adjust board so that it remains symmetrical to the central plus sign (+) on the board, inserting each SENSE (the side with a line) pin into the larger side of each elongate hole.

Model L2110 (Option)

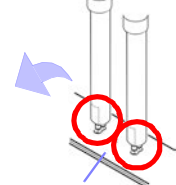
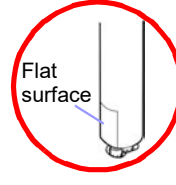



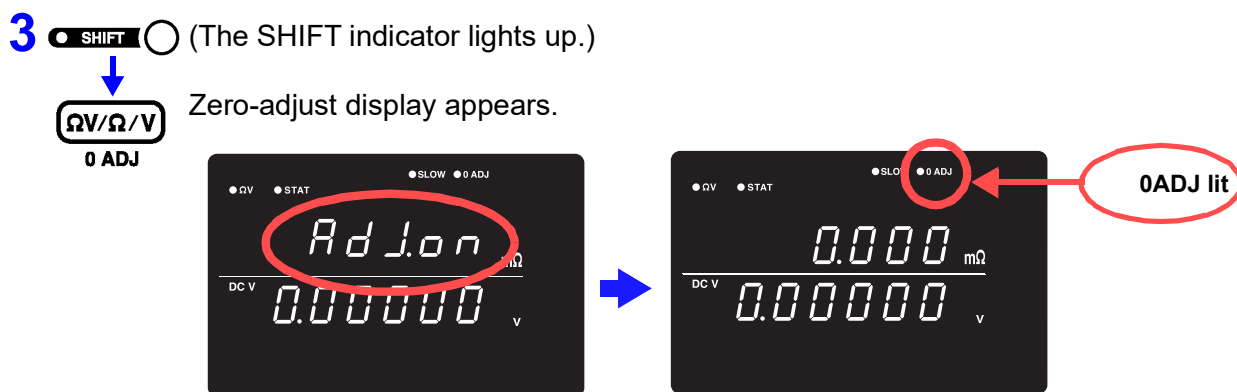



The SENSE side of the tip of the test lead has a flat surface. When using the zero-adjust feature, orient the test lead so that the surface the same direction.
 Choose a hole suited to the distance between the terminals on the battery subject to measurement and hold the test lead against the zero-adjust board so that it remains symmetrical to the central plus sign (+) on the board, inserting each SENSE (the side with the surface) pin into the larger side of each elongate hole.



After measurement, the measured value of the compensation applied by the zero-adjust function is displayed.

The range of zero adjustment is up to 1000 digits.

Clearing Zero-Adjustment

- 1**  (The SHIFT indicator lights up.)
- ↓
-  The Menu display appears.
- MENU**
-  (Main Display)
-  (Sub Display) flashing
- 2**  The zero-adjust value is cleared. (**0ADJ** not lit)
-  (Main Display)



If Err02 is displayed

Indicates that zero adjustment could not be executed, either because the range to be adjusted exceeds ± 1000 digits or a measurement fault condition exists. The zero adjust function is canceled, so repeat the operation after correcting the cause of the error.

NOTE

- Zero adjustment is limited to ± 1000 digits (all ranges)
- Perform zero adjustment for each range that will be used in measurement.
- When using the auto-range function, perform zero adjustment for all ranges.
- When using the ΩV function, the 0ADJ indicator lights up or turns off according to the resistance measurement range zero-adjust state.
- Zero-adjustment values are retained even when power is turned off.
- The 0ADJ terminal of the EXT I/O connector also executes zero adjustment. See "5.2 Signal Descriptions" (p.80).

3.7 Displaying Measurement Results

In the ΩV mode, resistance measurements appear on the upper display, and voltage measurements appear on the lower display.

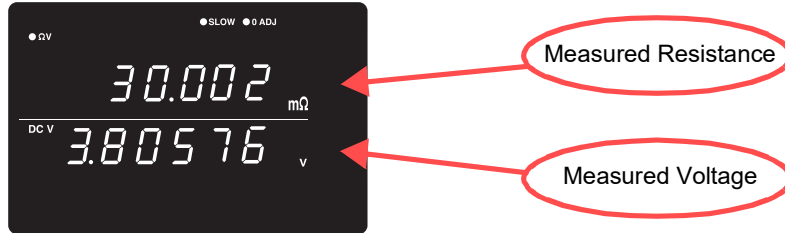

In the Ω mode, resistance measurements appear on the upper display.

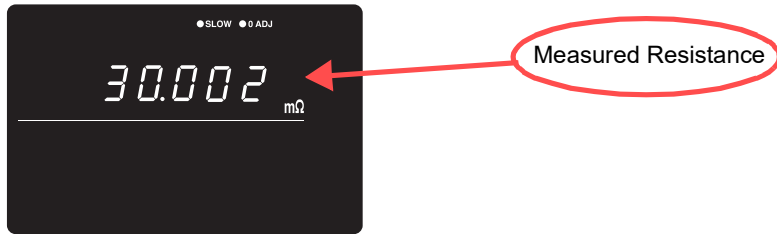

In the V mode, voltage measurements appear on the upper display.

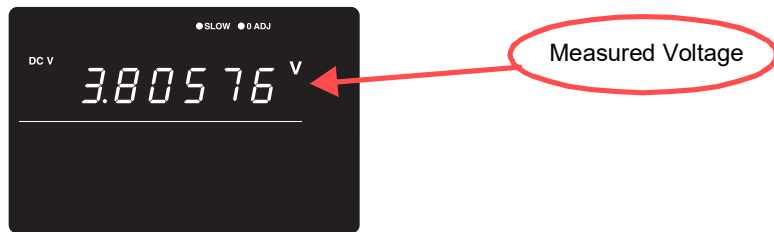

Measurement Fault Detection

If a measurement does not execute properly, a measurement fault " - - - - " is indicated on the display.

In addition, a measurement fault signal (ERR) is output at the EXT I/O connector.

See " ERR Output" (p.83).

A measurement fault is displayed in the following cases.

- When a test lead is not connected to the test object
- When the resistance of the measured object is over-range
Example: Attempting to measure 30 Ω with the 300 m Ω range selected.
- When there is a break in a probe wire
- When the contact resistance is high due to probe wear, dirt, or other factors, or when the wiring resistance is high (see chart below)
- If the circuit protection fuse is blown

See "10.1 Troubleshooting" (p.189).

Levels at which a measurement fault is detected

A measurement fault will result when the resistance values (contact resistance + wiring resistance + test object resistance) between the source H and L or the sense H and L leads is greater than or equal to the values in the following table:

BT3562, BT3562-01, BT3563, BT3563-01

| Range | SOURCE H-L | SENSE H-L |
|----------------|----------------|----------------|
| 3 m Ω | 2 Ω | 2 Ω |
| 30 m Ω | 2 Ω | 2 Ω |
| 300 m Ω | 15 Ω | 15 Ω |
| 3 Ω | 150 Ω | 15 Ω |
| 30 Ω | 1.5 k Ω | 150 Ω |
| 300 Ω | 6 k Ω | 1.5 k Ω |
| 3000 Ω | 6 k Ω | 15 k Ω |

* Large contact resistance and/or wiring resistance values may increase the error component in measured values. (Accuracy is not guaranteed when the sum of contact resistance and wiring resistance is greater than or equal to 20 Ω [for the 3 m Ω and 30 m Ω ranges, 2 Ω].)

* The instrument may be unable to detect measurement faults when the measurement lead capacitance is greater than or equal to 1 nF.

BT3561A, BT3562A, BT3563A

| Range | SOURCE H-L | SENSE H-L |
|--------|------------|-----------|
| 3 mΩ | 5.5 Ω | 6.5 Ω |
| 30 mΩ | 5.5 Ω | 6.5 Ω |
| 300 mΩ | 15 Ω | 30 Ω |
| 3 Ω | 150 Ω | 30 Ω |
| 30 Ω | 1.5 kΩ | 150 Ω |
| 300 Ω | 6 kΩ | 2.5 kΩ |
| 3000 Ω | 6 kΩ | 25 kΩ |

- A high contact resistance or a high wiring resistance may cause an increase in measurement errors.
Hioki cannot guarantee the measurement accuracy if the sum of contact resistance and wiring resistance reaches 40 Ω (4 Ω for the 3 mΩ and 30 mΩ ranges).
- The instrument may not detect measurement malfunctions if the measurement lead has a capacitance of 1 nF or more.

Overflow Display

Overflow is indicated by “OF” or “-OF” on the display, caused by one of the following:

| Display | Condition |
|---------|---|
| OF | <ul style="list-style-type: none"> • The measured value exceeds the limit of the current measurement range • The test object impedance exceeds the input level. • When the result of relative value calculation is larger than +99.999%. |
| -OF | <ul style="list-style-type: none"> • The measured value is below the limit of the current measurement range • The test object impedance exceeds the input level (in the negative direction). • When the result of relative value calculation is smaller than -99.999%. |

Applied Measurement

Chapter 4

This chapter describes advanced operations employing the Comparator, Statistical Calculation and Memory functions.

| | | |
|---|-----------------------------------|--------|
| Judge measurement values against specified thresholds | Comparator Function | (p.42) |
| Measure when trigger events occur | Trigger Function | (p.59) |
| Output averaged measurement values | Averaging Function | (p.63) |
| Display the results of calculation expressions applied to measurement values | Statistical Calculation Functions | (p.64) |
| Store measurement values | Memory Function | (p.68) |
| Lock the keys | Key-Lock Function | (p.70) |
| Save measurement configurations | Panel Save Function | (p.71) |
| Load saved measurement configurations | Panel Load Function | (p.72) |
| Increase measurement precision | Self-Calibration | (p.73) |
| Output measurement values via the RS-232C interface according to trigger input timing | Measurement Value Output Function | (p.74) |
| Enable/disable key-press beeps | Key Beeper Setting | (p.75) |
| Re-initialize the instrument | Reset Function | (p.76) |

4.1 Comparator Function

The comparator function compares measured values to preset upper and lower thresholds, judges the measurements according to their relative levels within the preset range, and indicates the results of the comparisons.

Comparator thresholds can be set either by specifying upper and lower thresholds, or by specifying a reference value and tolerance.

Comparator results can be indicated by the Hi, IN and Lo LEDs, beeper sound and signal output at the EXT I/O connector.

See "Chapter 5 External Control (EXT I/O)" (p.79).

The comparator setting process flow is as follows:

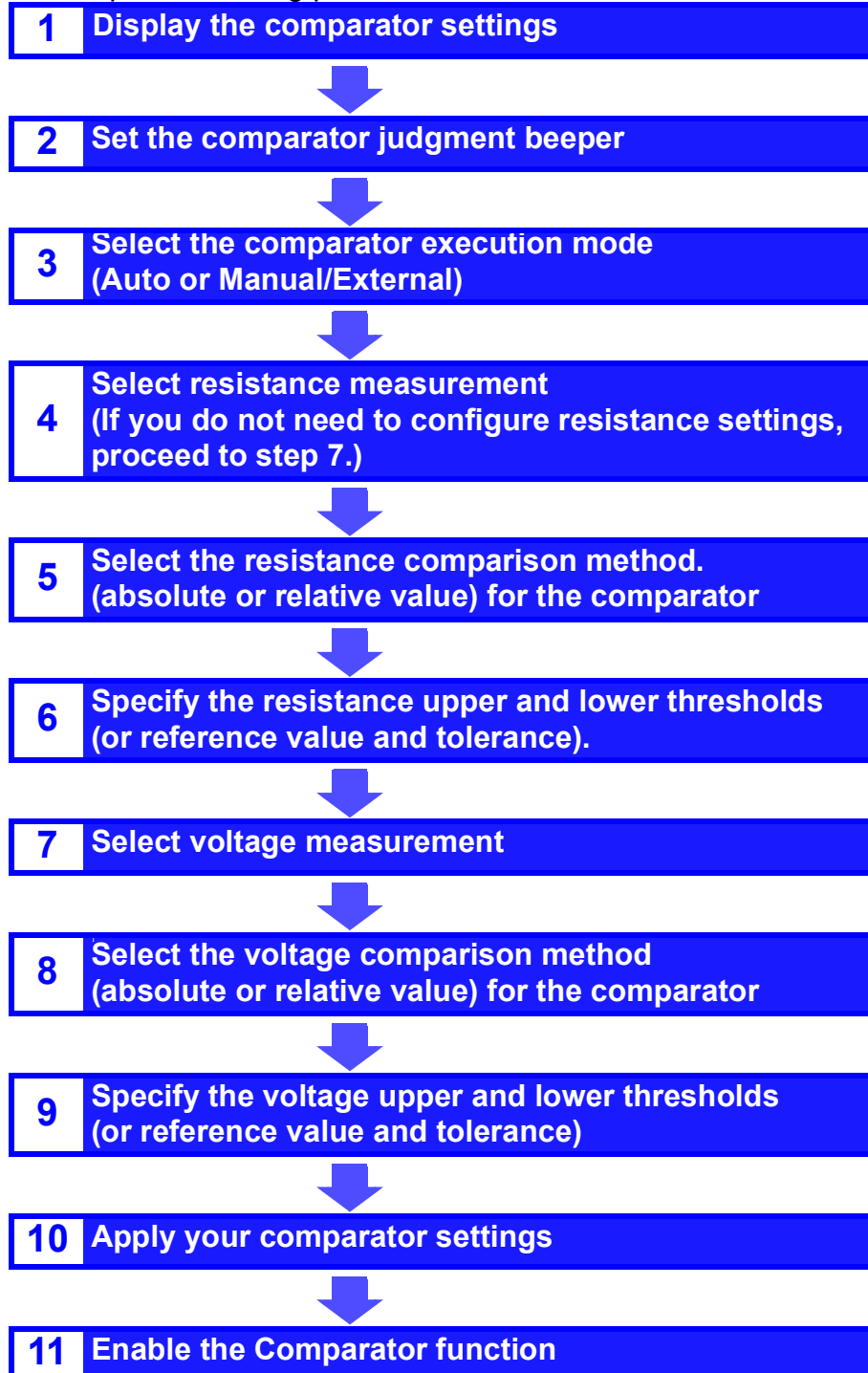

Comparator Setting Example 1 (Upper and Lower Threshold Judgment)

This example describes the comparator setting method.

Example:

Set the upper and lower thresholds for resistance and voltage in the ΩV mode (300 m Ω range), and indicate whether the measurement value exceeds the upper or lower thresholds by sounding the beeper.

Resistance : Upper threshold value 150.00 m Ω , Lower threshold value 100.00 m Ω
 Voltage : Upper threshold value 15.2000 V, Lower threshold value 15.0000 V

- 1 Confirm that the Comparator function is OFF.
 First make sure the Comparator function is disabled. Settings cannot be changed while the Comparator function is enabled. Press the **COMP** key, if necessary, to disable the Comparator function.

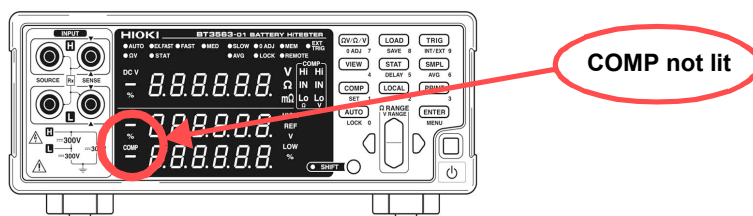

- 2 **$\Omega V / \Omega / V$** Select the ΩV measurement mode.



- 3 Select the Resistance measurement range (for this example, the 300 m Ω range).

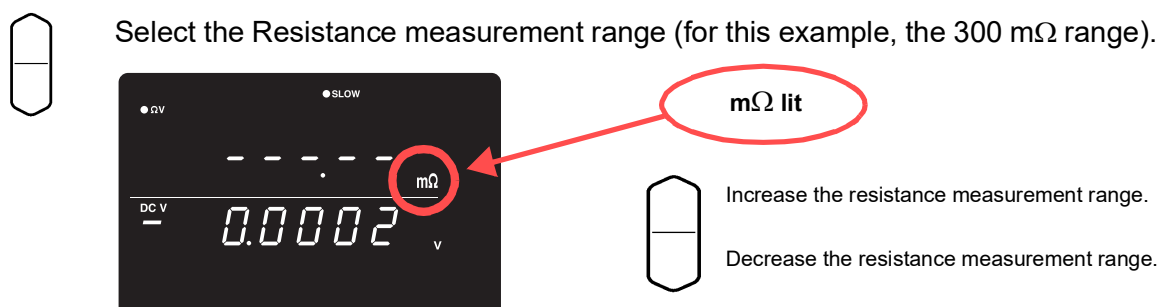

- 4 **SHIFT** Select the voltage measurement range (for this example, the 60 V range).

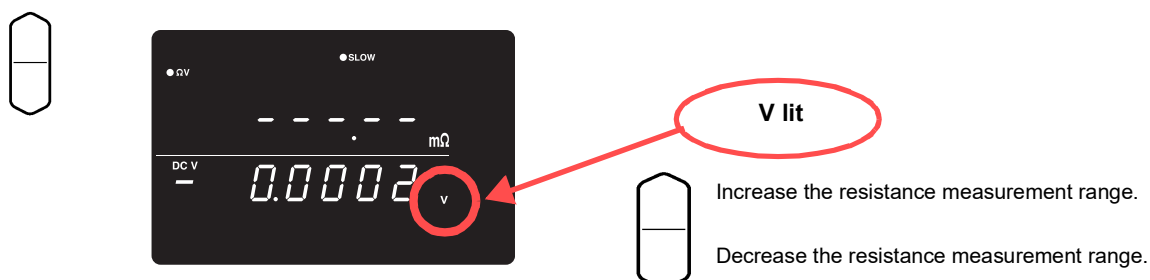

5 **SHIFT** ○ The Comparator setting display appears.

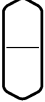

6  Set the comparator judgment beeper (for this example, select HL).



- oFF**no beeps sound
- HL**beeps repeatedly (when measurements are Hi or Lo)
- in**beeps continuously (when measurements are IN)
- btH1**beeps continuously while measurements are within the thresholds (IN), and beeps repeatedly when measurements are Hi or Lo.
- btH2**beeps once when measurements move into the threshold range (IN), and beeps repeatedly when measurements go Hi or Lo.

7  Press so that the indicated position blinks, and select the comparator execution mode (for this example, Auto).

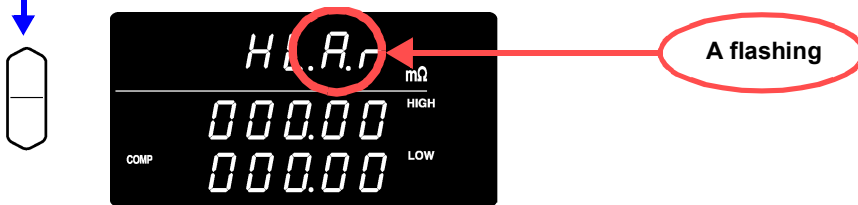

- A** Auto Comparator (default setting)
- E** Manual Comparator

8  Press so that the indicated position blinks, and select resistance.

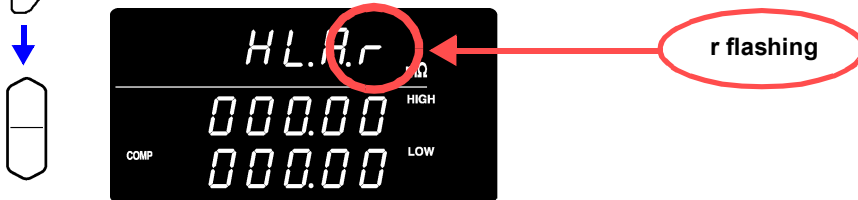

- r**Resistance
- u**Voltage

9



Press so that the indicated position blinks, and select the comparison method for the comparator (here, HIGH/LOW).



HIGH & LOW flashing

HIGH, LOW Compare by upper and lower thresholds (default setting)

REF, % Compare by reference value and tolerance

10

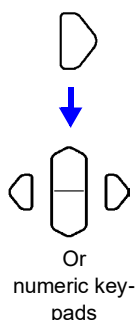

Switch to the upper/lower threshold setting display, and specify the thresholds.



For this example,
Upper Threshold: 150 mΩ

Upper Threshold: 100 mΩ

| | | | | | | | | | | | | | | | | | | | | | | | | | |
|--|--|-----------|--|--|---------|--------|-----------|--|--|--|---|---------|-------|--|--|--|-------|---|---|--|--|--|--------|--|------|
| <p>Using the RANGE keys:</p> <p>Select a digit to change by moving the blinking location, then select the new numerical value.</p> <p> Select a digit</p> <p> Select numerical value</p> | <p>Using the numeric keypads:</p> <p>Press the numeric keys corresponding to the digits to be entered.</p> <table border="0"> <tr> <td></td> <td></td> <td></td> </tr> <tr> <td>0 ADJ 7</td> <td>SAVE 8</td> <td>INT/EXT 9</td> </tr> <tr> <td></td> <td></td> <td></td> </tr> <tr> <td>4</td> <td>DELAY 5</td> <td>AVG 6</td> </tr> <tr> <td></td> <td></td> <td></td> </tr> <tr> <td>SET 1</td> <td>2</td> <td>3</td> </tr> <tr> <td></td> <td></td> <td></td> </tr> <tr> <td>LOCK 0</td> <td></td> <td>MENU</td> </tr> </table> | | | | 0 ADJ 7 | SAVE 8 | INT/EXT 9 | | | | 4 | DELAY 5 | AVG 6 | | | | SET 1 | 2 | 3 | | | | LOCK 0 | | MENU |
| | | | | | | | | | | | | | | | | | | | | | | | | | |
| 0 ADJ 7 | SAVE 8 | INT/EXT 9 | | | | | | | | | | | | | | | | | | | | | | | |
| | | | | | | | | | | | | | | | | | | | | | | | | | |
| 4 | DELAY 5 | AVG 6 | | | | | | | | | | | | | | | | | | | | | | | |
| | | | | | | | | | | | | | | | | | | | | | | | | | |
| SET 1 | 2 | 3 | | | | | | | | | | | | | | | | | | | | | | | |
| | | | | | | | | | | | | | | | | | | | | | | | | | |
| LOCK 0 | | MENU | | | | | | | | | | | | | | | | | | | | | | | |

To enter the current measurement as the setting value: **AUTO** key
(Press on a screen other than the upper/lower threshold setting display.)
To enter the result of statistical calculation as the setting value: **STAT** key
(Press on a screen other than the upper/lower threshold setting display.)
See " Upper and Lower Thresholds Setting (by Reference Value and Tolerance)" (p.54).

11



Press so that the indicated position blinks, and select voltage.



u flashing

r Resistance
u Voltage

4.1 Comparator Function

12



Press so that the indicated position blinks, and select the comparison method for the comparator (here, HIGH/LOW).



HIGH & LOW flashing

HIGH, LOW Compare by upper and lower thresholds (default setting)
REF, %..... Compare by reference value and tolerance

13

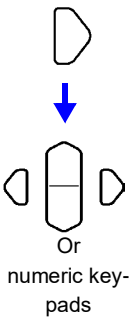

Switch to the upper/lower threshold setting display, and specify the thresholds.



For this example,
 Upper Threshold: 15.2 V
 Upper Threshold: 15 V

14



Applies setting and returns to the Measurement display. The comparator function is enabled.

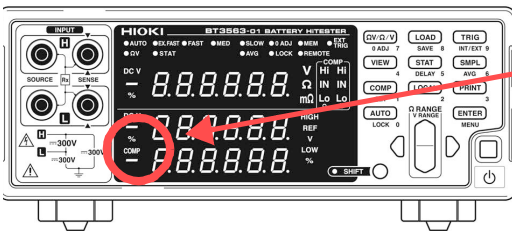

COMP lit

To cancel the settings: **SHIFT** key

15

Connect a test object and judge the measured value.

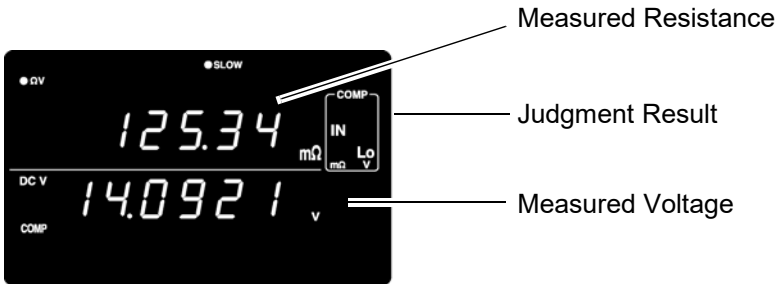

Measured Resistance

Judgment Result

Measured Voltage

In the ΩV mode, you can verify comparator settings by pressing the **VIEW** key. See " Switching Between Measurement Value and Comparator Setting Displays" (p.58).

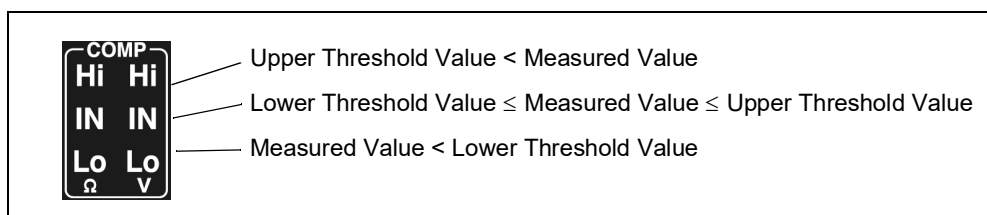

Upper Threshold Value < Measured Value

Lower Threshold Value ≤ Measured Value ≤ Upper Threshold Value

Measured Value < Lower Threshold Value

NOTE

- The upper and lower thresholds are saved as the displayed counts (independent of measurement mode and range). Therefore, changing the measurement mode or range results in the same display counts representing different absolute values.

Example:

To specify the lower threshold as 150 mΩ in the 300 mΩ range, enter "15000". Switching to the 3 Ω range after making this setting changes the lower threshold to 1.5 Ω.

- The instrument can also base judgments on the absolute value of voltage measured values (to prevent Lo judgments when the positive and negative terminals are connected backwards).

See "Configuring the Absolute Value Judgment Function (Voltage)" (p.55)

Comparator Setting Example 2 (Reference Value and Tolerance Judgment)

This example describes the comparator setting method.

Example:

Set a reference value and tolerance in the ΩV mode (3 Ω range), and set the beeper to sound while measured values are within tolerance.

Resistance : Reference value 1.5 Ω, Tolerance 5%
Voltage : Reference value 4.2 V, Tolerance 0.5%

1

Confirm that the Comparator function is OFF.

First make sure the Comparator function is disabled. Settings cannot be changed while the Comparator function is enabled. Press the **COMP** key, if necessary, to disable the Comparator function.

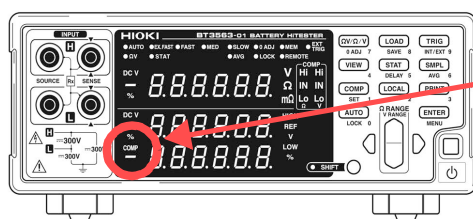

2

ΩV/Ω/V

Select the ΩV measurement mode.



3



Select the measurement range (for this example, the 3 Ω range).



Increase the resistance measurement range.

Decrease the resistance measurement range.

4.1 Comparator Function

4 Select the voltage measurement range (for this example, the 6 V range).

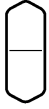

V lit

5 The Comparator setting display appears.



oFF flashing

6 Set the comparator judgment beeper (for this example, select IN).

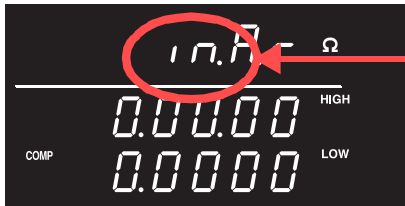
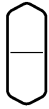

in flashing

- oFF**no beeps sound
- HL**beeps repeatedly (when measurements are Hi or Lo)
- in**beeps continuously (when measurements are IN)
- btH1**beeps continuously while measurements are within the thresholds (IN), and beeps repeatedly when measurements are Hi or Lo.
- btH2**beeps once when measurements move into the threshold range (IN), and beeps repeatedly when measurements go Hi or Lo.

7 Press so that the indicated position blinks, and select the comparator execution mode (for this example, Auto).



A flashing

- A** Auto Comparator (default setting)
- E** Manual Comparator

8



Press so that the indicated position blinks, and select resistance.

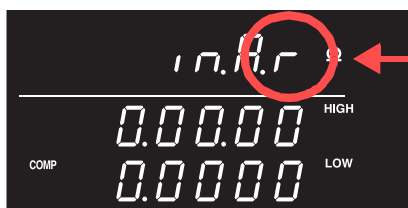

r flashing

r..... Resistance
u..... Voltage

9



Press so that the indicated position blinks, and select the comparison method for the comparator (here, REF/%).

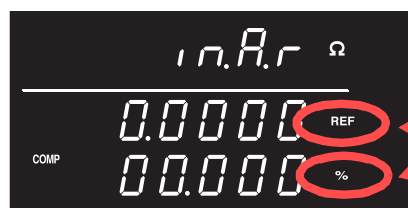

REF & % flashing

HIGH, LOW Compare by upper and lower thresholds (default setting)
REF, % Compare by reference value and tolerance

10

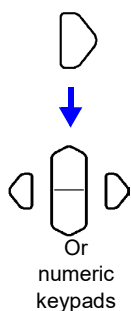

Switch to the Ref/% threshold setting display, and specify the thresholds.

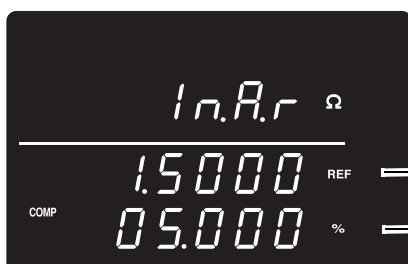

For this example,
Reference value: 1.5 Ω

Tolerance: 5%

Using the **RANGE** keys:
Select a digit to change by moving the blinking location, then select the new numerical value.



Select a digit

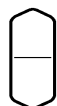

Select numerical value

Using the numeric keypads:
Press the numeric keys corresponding to the digits to be entered.

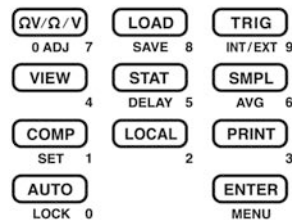

To enter the current measurement as the setting value: **AUTO** key
(Press on a screen other than the upper/lower threshold setting display.)
To enter the result of statistical calculation as the setting value: **STAT** key
(Press on a screen other than the upper/lower threshold setting display.)
See " Upper and Lower Thresholds Setting (by Reference Value and Tolerance)" (p.54).

4.1 Comparator Function

11



Press so that the indicated position blinks, and select voltage.

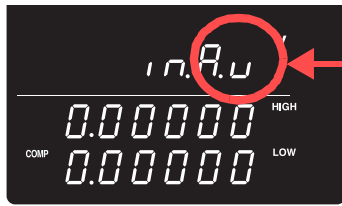

u flashing

r Resistance
u Voltage

12



Press so that the indicated position blinks, and select the comparison method for the comparator (here, REF%).



REF & % flashing

HIGH, LOW Compare by upper and lower thresholds (default setting)
REF, % Compare by reference value and tolerance

13

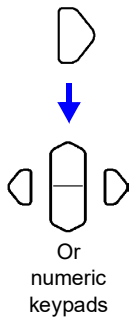

Switch to the Ref/% threshold setting display, and specify the thresholds.



For this example,
Reference value: 4.2 V
Tolerance: 0.5%

14



Applies setting and returns to the Measurement display. The comparator function is enabled.

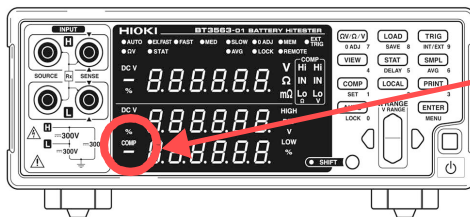

COMP lit

To cancel the settings: SHIFT key

15

Connect a test object and judge the measured value.

Resistance measurements are displayed as their relative percentage offset from the reference value (%)

Judgment Result

$$\text{Relative percentage} = \frac{\text{Measured resistance} - \text{Reference value}}{\text{Reference value}} \times 100$$

DC V

COMP

COMP

Hi

IN

Ω

V

Voltage measurements are displayed as their relative percentage offset from the reference value (%)

In the ΩV mode, you can verify comparator settings by pressing the **VIEW** key.
See " Switching Between Measurement Value and Comparator Setting Displays" (p.58).

COMP

Hi Hi

IN IN

Lo Lo

Ω

V

Upper Threshold Value of setting range < Measured value

Lower Threshold Value of setting range ≤ Measured value ≤ Upper Threshold Value of setting range

Measured value < Lower Threshold Value of setting range



NOTE



The instrument can also base judgments on the absolute value of voltage measured values (to prevent Lo judgments when the positive and negative terminals are connected backwards).

See "Configuring the Absolute Value Judgment Function (Voltage)" (p.55)

Comparator Judgment Beeper Setting

Four beeper settings are available to audibly indicate comparator judgment results.

1  (The SHIFT indicator lights up.)

 The Comparator setting display appears.

2  Set the comparator judgment beeper.
 (Main Display)



- oFF**..... no beeps sound
- HL**..... beeps repeatedly (when measurements are Hi or Lo)
- in** beeps continuously (when measurements are IN)
- btH1**..... beeps continuously while measurements are within the thresholds (IN), and beeps repeatedly when measurements are Hi or Lo.
- btH2**..... beeps once when measurements move into the threshold range (IN), and beeps repeatedly when measurements go Hi or Lo.





NOTE

- The beeper does not sound when the comparator judgment beeper setting is disabled (oFF).
 - The beeper does not sound when there is no judgment result.
- See " Comparator Judgment Results" (p.57).**

Comparator Execution Mode Setting

Comparator judgment execution is selected by setting the auto or manual/external comparator mode. Comparator judgment can be enabled and disabled by EXT I/O signals. Refer to Input Signals (Page 81).

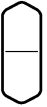
1  (The SHIFT indicator lights up.)

 The Comparator setting display appears.

2  Press so that the indicated position blinks, and set the comparator execution mode.

  (Main Display)



- A**.....Auto comparator (comparator results are always output [default setting])
- E**Manual comparator (comparator results are output only when the MANU EXT I/O input is enabled [ON])

NOTE

The auto setting is appropriate for normal use. Use the manual/external setting when you need to control comparator judgment timing.

Comparator Threshold Method Selection

Two methods are available for setting comparator thresholds.

- 1  (The SHIFT indicator lights up.)
 The Comparator setting display appears.

- 2  Press so that the indicated position blinks, and set the comparator threshold method.



HIGH, LOW Compare against specified upper and lower thresholds (default setting method)

REF, % Compare against upper and lower thresholds internally calculated from a specified reference value and tolerance

About comparisons based on a reference value and tolerance

When the reference value and tolerance method is selected, thresholds are calculated as follows:



$$\text{Upper threshold} = \text{reference value} \times (100 + \text{tolerance} [\%]) / 100$$



$$\text{Lower threshold} = \text{reference value} \times (100 - \text{tolerance} [\%]) / 100$$

Measured values are displayed as a percentage relative to the reference value, calculated as follows:

$$\text{Relative value} = (\text{measured value} - \text{reference value}) / \text{reference value} \times 100 [\%]$$



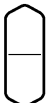

Upper and Lower Threshold Setting (by Reference Value and Tolerance)

1  (The SHIFT indicator lights up.)
 The Comparator setting display appears.

2 

 Press so that the indicated position blinks, and select resistance or voltage.















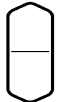























r Resistance
 u Voltage

3 

  Or numeric keypads

Select the threshold setting display, and enter upper and lower threshold values.



For example,
 Upper Threshold: 150 mΩ
 Lower Threshold: 100 mΩ

| | | | | | | | | | | | | | |
|---|---|--|---|--|--|--|--|--|--|--|---|---|--|
| <p>Using the RANGE keys:</p> <p>Select a digit to change by moving the blinking location, then select the new numerical value.</p> <p>  Select a digit</p> <p> Select numerical value</p> | <p>Using the numeric keypads</p> <p>Press the numeric keys corresponding to the digits to be entered.</p> <table border="0"> <tr> <td> 0 ADJ 7</td> <td> SAVE 8</td> <td> INT/EXT 9</td> </tr> <tr> <td> 4</td> <td> DELAY 5</td> <td> AVG 6</td> </tr> <tr> <td> SET 1</td> <td> 2</td> <td> 3</td> </tr> <tr> <td> LOCK 0</td> <td colspan="2"> MENU</td> </tr> </table> |  0 ADJ 7 |  SAVE 8 |  INT/EXT 9 |  4 |  DELAY 5 |  AVG 6 |  SET 1 |  2 |  3 |  LOCK 0 |  MENU | |
|  0 ADJ 7 |  SAVE 8 |  INT/EXT 9 | | | | | | | | | | | |
|  4 |  DELAY 5 |  AVG 6 | | | | | | | | | | | |
|  SET 1 |  2 |  3 | | | | | | | | | | | |
|  LOCK 0 |  MENU | | | | | | | | | | | | |

To enter the current measurement as the setting value: **AUTO** key

Press on a screen other than the upper/lower threshold (reference value/tolerance) setting display. This key is used as a numeric key on the upper/lower threshold (reference value/tolerance) setting display.

The current measurement value is set as the upper or lower threshold (during upper/lower threshold setting), or as the reference value (during reference value and tolerance setting). If the measured value is faulty or \pm OF, it is ignored (not entered).

To enter a statistical calculation result as the setting value: **STAT** key

Press on a screen other than the upper/lower threshold (reference value/tolerance) setting display. This key is used as a numeric key on the upper/lower threshold (reference value/tolerance) setting display.

The result of statistical calculation is set as follows:

| | |
|--|--|
| During upper/lower threshold setting | Upper threshold = average value + 3σ Lower threshold = average value - 3σ |
| During reference value and tolerance setting | Reference value = average value Tolerance = $3\sigma / \text{average value} \times 100\%$ |

Where " σ " represents population standard deviation (σ_n).

No setting occurs if statistical calculation is disabled and no statistical calculation result exists.

See "4.5 Statistical Calculation Functions" (p.64).

Setting thresholds from the **AUTO** and **STAT** keys is possible only when the selected (blinking) character is non-numeric.

NOTE

Threshold and reference values can be set from 0 to 99999 (or 999999 for voltage), and tolerance can be set from 0.000 to 99.999%. Negative values are not settable. Entries using statistical calculation results that exceed the valid range are restricted to the range limit.

Configuring the Absolute Value Judgment Function (Voltage)

This section describes how to configure functionality for acquiring the absolute value of the voltage measured value when judging comparators, allowing a judgment to be made based on the absolute value of the voltage even if polarity is reversed when the probes are connected to the battery.

Ordinarily, connecting the probes with the polarity reversed results in a negative voltage measured value, yielding a Lo comparator judgment result. To generate an IN judgment whenever the reading falls within the specified range, even if the probes have been connected backwards (resulting in a negative voltage measured value), set the absolute value judgment function to "On."

This function is configured on the menu screen.

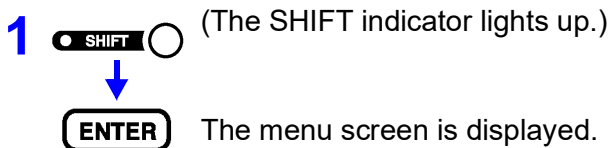

2 Display the absolute value judgment function configuration screen.

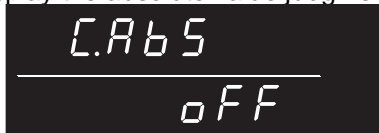

See "1.4 Menu Display Sequence (SHIFT → ENTER)" (p.16)

3 Set the absolute value judgment function to either "On" or "Off."

on Absolute value judgment function on.

oFF Absolute value judgment function off.

4 Accept the setting and return to the measurement screen.

For example, the following judgment results would be obtained when connecting the probes backwards to a 3.7 V battery (resulting in a displayed voltage measured value of -3.7 V) with an upper threshold of 3.9 V and a lower threshold of 3.6 V:

Absolute value judgment function off: Lo

Absolute value judgment function on: IN

Enabling and Disabling the Comparator Function

COMP

Enables the comparator

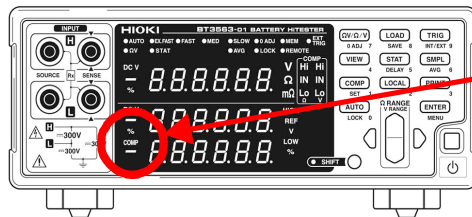

When the comparator is enabled, the following key operations are disabled to avoid inadvertent operations.

- **ΩV/ΩV** key (Measurement mode setting)
- **SHIFT** → **ΩV/ΩV** key (Zero-Adjustment)
- **SHIFT** → **COMP** key (Comparator setting)
- **AUTO** key (Auto-ranging setting)
- **SMPL** key (Sampling rate setting)
- **SHIFT** → **SMPL** key (Averaging setting)
- **SHIFT** → **TRIG** key (Trigger source setting)
- **SHIFT** → **ENTER** key (Menu display)
- **SHIFT** → **STAT** key (Delay setting)
- Range keys

NOTE

When the comparator is enabled, auto-ranging is automatically disabled.

Comparator Judgment Results

Resistance and voltage measurements are judged independently. Both judgment results are indicated on the display.

Judgment Operation

The comparator compares measured values with the preset threshold values, and judges whether the measurement is within the thresholds. Resistance and voltage measurements are judged independently.

The absolute value of the measurement is compared to the upper and lower thresholds.

When the absolute value judgment function is on, the absolute value of the measured value is compared to the upper and lower thresholds.

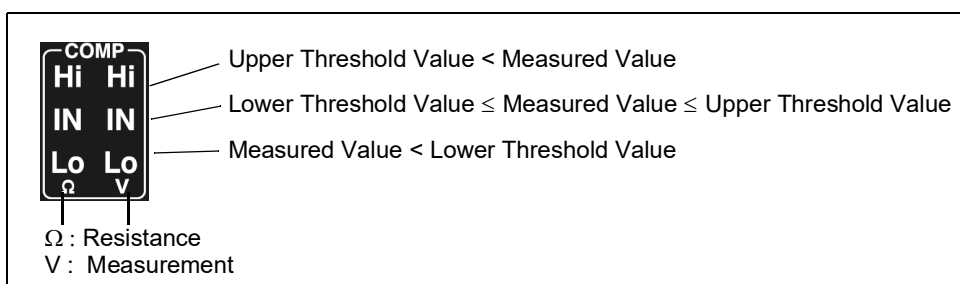

Measurement fault values are judged as follows:

| Display | Judgment |
|---------|------------------------------------|
| ----- | No judgment |
| OF | Hi (exceeds the upper threshold) |
| -OF | Lo (less than the lower threshold) |

PASS/FAIL Judgment Output

Judgment results (Hi, IN or Lo for both resistance and voltage) are output to EXT I/O connectors.

Additionally, the instrument can generate PASS/FAIL judgment output to facilitate easy judgments. In this configuration, it outputs a PASS judgment when the resistance and voltage are both IN and otherwise a FAIL judgment.

See " Output Signals" (p.82).

NOTE

With the relative value comparison method (thresholds defined by a reference value and tolerance), the upper and lower thresholds are calculated internally for comparison with measurements. Therefore, even if a relative display value is equal to a judgment threshold (tolerance limit), it may be judged Hi or Lo.

Switching Between Measurement Value and Comparator Setting Displays

In ΩV mode, both resistance and voltage measurement values are displayed. Although comparator setting values are not normally displayed when the comparator is enabled, they can be displayed for confirmation by the display switching function.

Example:
 Resistance: Upper threshold value 150.00 m Ω , Lower threshold value 100.00 m Ω
 Voltage: Upper threshold value 15.2000 V, Lower threshold value 15.0000 V

VIEW

Press this key to switch the display between measurement values and comparator setting values.

Resistance and voltage measurement display
 (Shows resistance and voltage measurement values simultaneously)



Resistance measurement and comparator display
 (Shows resistance measurement and resistance comparator setting values)

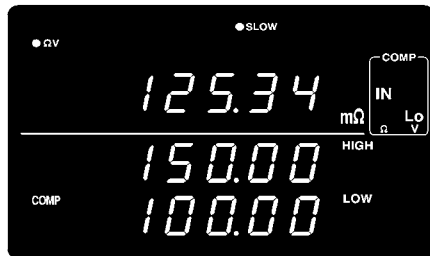

Voltage measurement and comparator display
 (Shows voltage measurement and voltage comparator setting values)



VIEW

Measurement display switching is available only with the comparator enabled, and in the ΩV mode.

Use it to confirm comparator setting values.

4.2 Trigger Function

Trigger Source Settings

Two trigger sources are available: internal and external.

| | |
|------------------|--|
| Internal Trigger | Trigger signals are automatically generated internally. (free-run) |
| External Trigger | Trigger signals are provided externally or manually. |

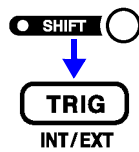

(The SHIFT indicator lights up.)

Switches the selected trigger source.

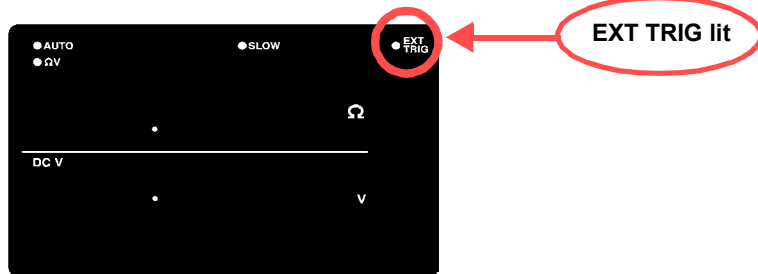

EXT.TRIG lit..... External triggering is selected.

EXT.TRIG not lit..... Internal triggering is selected.

Measurement with External Triggering

An external trigger can be applied in three ways.

- Applying a trigger manually by operating key
Pressing the **TRIG** key causes one measurement.
- Applying a trigger at the EXT I/O connector.
Shorting the TRIG terminal to the ISO_COM of the EXT I/O connector on the rear panel causes one measurement.
- Applying a trigger through RS-232C or GP-IB interface
Sending the ***TRG** command via the RS-232C or GP-IB interface causes one measurement.



NOTE



- When Internal triggering is enabled, external input at the EXT I/O TRIG terminal and the ***TRG** command are ignored.
- The normal state of operation with the front panel controls is continuous measurement. Setting the trigger source to Internal enables the free-run condition in which triggering occurs continuously. When the trigger source is set to External, a measurement occurs each time an external trigger is applied. Continuous measurement can be disabled via RS-232C, LAN, or GP-IB interface signals, in which case triggering occurs only when signaled by the external host (PC or PLC).



See " Triggering System Description" (p.153).

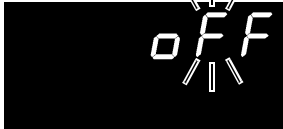

Trigger Delay Settings

Specify the delay from the moment a trigger is applied to the start of measurement. By using this function, even when a trigger is applied immediately after connecting a test object, the start of measurement can be delayed to allow sufficient time for the measurement value to stabilize. Trigger delay can be set with 1 ms resolution from 0.000 to 9.999 seconds.



- 1**  (The SHIFT indicator lights up.)
 The Trigger Delay setting display appears.

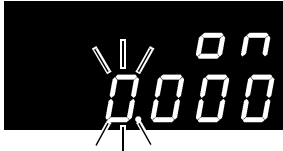
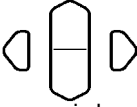

 (Main Display)
 (Sub Display)
 The current setting blinks.
- 2**  Select **ON**.

 (Sub Display)
- 3**  The numerals indicating the trigger delay blink.

 (Sub Display)
- 4**  Set the trigger delay.
 Or numeric keypads
- 5**  Applies setting and returns to the Measurement display.
 To cancel the settings: **SHIFT** key

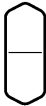
Disabling the Trigger Delay Function





- 1**  (The SHIFT indicator lights up.)
 The Trigger Delay setting display appears.
- 2**  Select **OFF**.

 (Sub Display)
- 3**  The Trigger Delay is disabled.

4.3 Measurement Current Pulse Output Function



When using multiple instruments to take measurements at the same time, you may experience interference as a result of electromagnetic induction caused by the devices' measurement currents, causing measured values to gradually oscillate between increasingly large values. To prevent this phenomenon, the measurement current pulse output function can be used to apply the measurement current only while measurement is being performed. (This functionality is only available during external trigger measurement or while continuous measurement is off.)

When this function is turned on, the measurement current is only applied at the time of measurement. By staggering the timing of trigger measurement, measurement current interference can be eliminated.

- 1  (The SHIFT indicator lights up.)
 The menu screen is displayed.
- 2  Display the measurement current pulse function configuration screen.

```

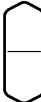
CUR.PLS
-----
OFF

```
- 3  Set the constant current pulse function to either "On" or "Off."
on Measurement current pulse function on.
off Measurement current pulse function off.
- 4  Accept the setting and return to the measurement screen.

4.3 Measurement Current Pulse Output Function

Measurement current application timing when measurement current pulse mode is on

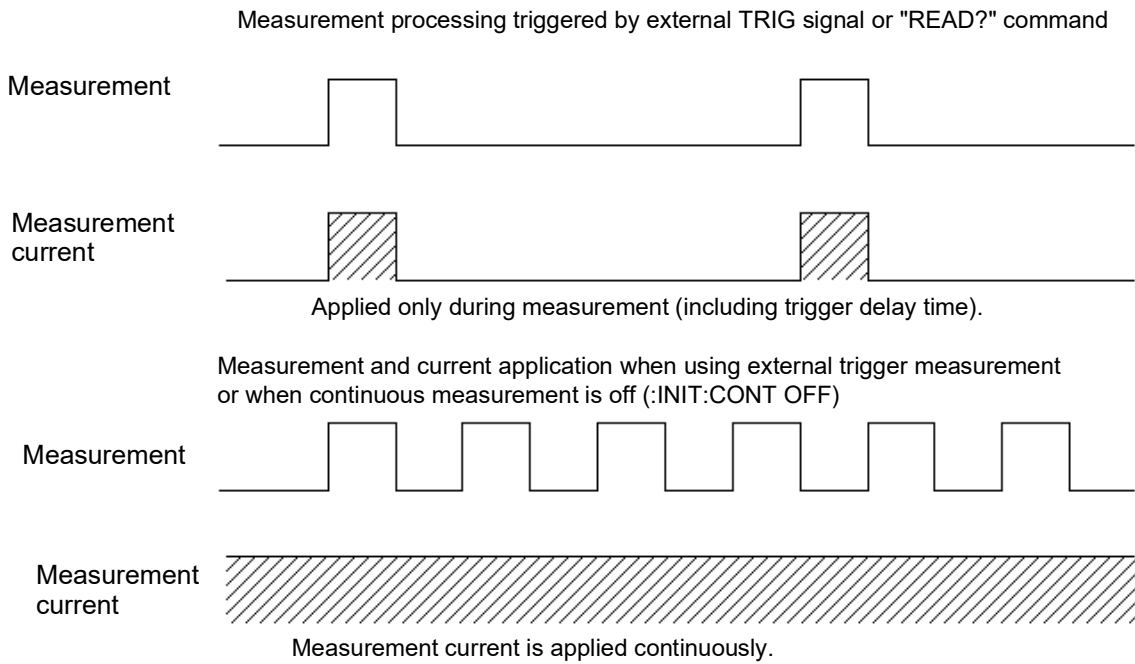

Measurement current application when using normal internal trigger measurement
(The measurement current is applied continuously when measurement current pulse mode is off.)

NOTE

- When using the instrument with the measurement current pulse output function enabled, always enable the trigger delay function and set the delay time to 10 ms or more.
See "Trigger Delay Settings" (p.60)
- When the measurement current pulse output function is on, the below is added to the sampling time.
When using the ΩV mode: +1 ms
When using the Ω mode: +4 ms



4.4 Averaging Function



The Averaging Function averages measurement values for output. This function can minimize instability of displayed values. The number of samples to average can be set from 2 to 16.

- 1**  (The SHIFT indicator lights up.)

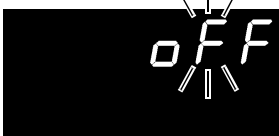
 The Averaging Function setting display appears.

 (Main Display)

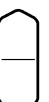

 (Sub Display)
The current setting blinks.
- 2**  Select **ON**.



 (Sub Display)
- 3**  The number of samples to average setting blinks.
- 4**  Select the number of samples to average.

Or
numeric keypads
- 5**  The Average Measurement display appears. (**AVG** lit)
To cancel the settings: **SHIFT** key

Disabling the Averaging Function

- 1**  (The SHIFT indicator lights up.)

 The Averaging Function setting display appears.
- 2**  Select **OFF**.

 (Sub Display)
- 3**  The Averaging Function is disabled. (**AVG** not lit)

NOTE

When the internal trigger is used for continuous measurement (free-run), the display shows the moving average. Otherwise, the display shows the integrating average.

See "4.2 Trigger Function" (p.59).

4.5 Statistical Calculation Functions

The mean, maximum, minimum, standard deviation of population, standard deviation of sample and process capability indices are calculated and displayed for up to 30000 measurement values.

The calculation formulas are as follows:

Mean

$$\bar{x} = \frac{\sum x}{n}$$

Standard deviation of population

$$\sigma = \sqrt{\frac{\sum x^2 - n\bar{x}^2}{n}} \quad (= \sigma_n)$$

Standard deviation of sample

$$s = \sqrt{\frac{\sum x^2 - n\bar{x}^2}{n-1}} \quad (= \sigma_{n-1})$$

Process capability index (dispersion)

$$Cp = \frac{|Hi - Lo|}{6\sigma_{n-1}}$$

Process capability index (bias)

$$CpK = \frac{|Hi - Lo| - |Hi + Lo - 2\bar{x}|}{6\sigma_{n-1}}$$

- In these formulas, n represents the number of valid data samples.
- Hi and Lo are the upper and lower thresholds of the comparator.
- The process capability indices represent the quality achievement capability created by a process, which is the breadth of the dispersion and bias of the process' quality. Generally, depending on the values of Cp and CpK, process capability is evaluated as follows:
 Cp, CpK>1.33..... Process capability is ideal
 1.33 ≥ Cp, CpK>1.00..... Process capability is adequate
 1.00 ≥ Cp, CpK..... Process capability is inadequate

NOTE

- When only one valid data sample exists, standard deviation of sample and process capability indices are not displayed.
- When σ_{n-1} is 0, Cp and CpK are 99.99.
- The upper limit of Cp and CpK is 99.99. Values of Cp and CpK>99.99 are displayed as 99.99.
- Negative values of CpK are handled as CpK=0.
- When comparator, range or auto-ranging settings are changed while statistical data is displayed, the display of Cp and CpK values changes to "- . . -".
- When normal measurement values and relative display values (%) are mixed, correct calculation results cannot be obtained.

Enabling/Disabling the Statistical Calculation Function

1  The Statistical Calculation display appears.

 (Main Display)

 (Sub Display)

2  The function enable/disable display appears.

(press three times)

 (Sub Display)

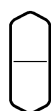

Enable or disable the Calculation Function on the Sub Display.

on..... enables the calculation function on.

off disables the calculation function off.

3  Applies setting and returns to the Measurement display.

To cancel the settings: **SHIFT** key

NOTE

- Statistical Calculation function setting (ON, OFF) is not available when the Comparator is enabled.
- If Statistical Calculation is turned off and then back on without first clearing calculation results, it resumes calculating from the point when it was turned off.
- The Statistical Calculation function slows measurements when it is ON.

Clearing Statistical Calculation Results

1  The Statistical Calculation display appears.

 (Main Display)

 (Sub Display)

2  The Clearing screen will appear.

(press once)

 (Sub Display)

3  Clears statistical calculation results.

Automatic Clearing of Statistical Calculation Results after Printing

The instrument can be set to automatically clear statistical calculation results after results are output to the printer.

- 1**  The Statistical Calculation display appears.



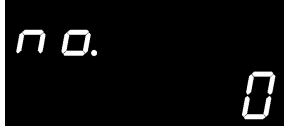

(Main Display)



(Sub Display)
- 2**  Bring up Auto Clearing After Printing in the Setup screen.

(Press twice)



(Sub Display)
- 3**  Turn Automatic Clearing After Printing on or off.

on..... Automatically clears statistical calculation results after they are output to the printer.

off..... Does not clear the results themselves.
- 4**  Applies setting and returns to the Measurement display.

To cancel the settings: **SHIFT** key

Importing Data





Pressing the **TRIG** key while Statistical Calculation is ON executes one of the following operations:

- External Trigger: Takes one measurement and performs statistical calculation on the result
- Internal Trigger: Performs statistical calculation on the value displayed immediately after pressing

NOTE

- ***TRG** command executes the same operation.
- Shorting the $\overline{\text{TRIG}}$ terminal to the ISO_COM of the EXT I/O connector executes the same operation.

Confirming Statistical Calculation Results

- 1**  The Statistical Calculation display appears.
- 2**  The indication on the display changes as follows with each key-press.

Example: when the ΩV mode is selected
(not displayed in V mode)

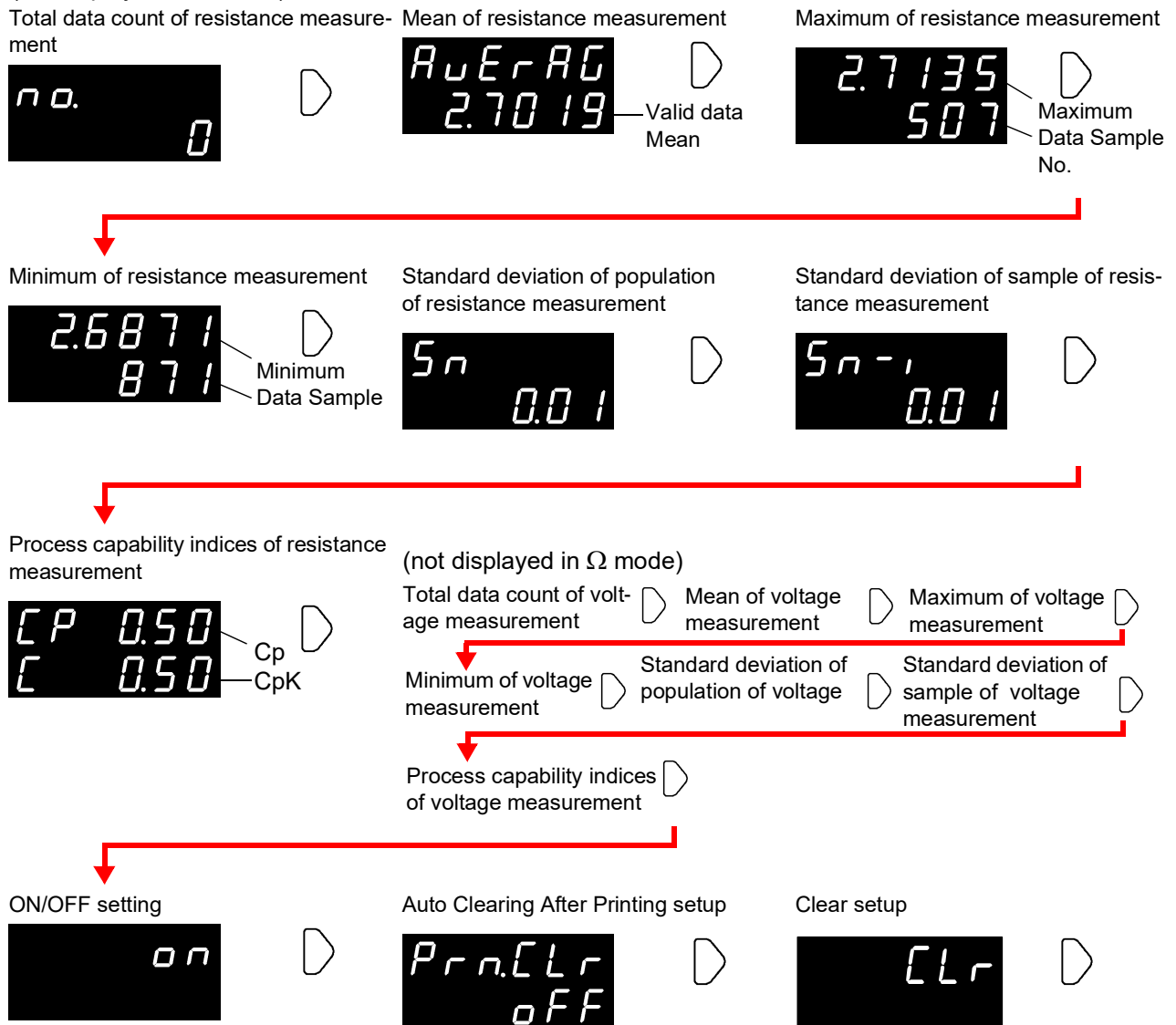

NOTE

- When a valid data count (measurement fault other than ± OF) is zero, no calculation result is displayed.
- When only one valid data sample exists, standard deviation of sample and process capability indices cannot be displayed.
- When comparator, range or auto-ranging settings are changed while statistical data is displayed, the display of Cp and CpK values changes to "- . - . -".

Sending Statistical Calculation Results to the Printer



With the statistical calculation results displayed, press the **PRINT** key. The statistical calculation results are output to the optional printer. See "Chapter 6 Printing" (p.91).

4.6 Memory Function

The Memory function is only available via communication commands.

When the Memory function is enabled, measurement values are stored in the instrument's internal memory according to trigger input sequence (up to 400 values). Stored data can be downloaded later upon command.

When measuring using a scanner to switch multiple test objects, switching time can be quite long if measurement values are downloaded to the PC after each measurement. Test cycle time can be minimized by using this function to store measurement values internally until all channel measurements are finished, at which time the stored values are downloaded together during the next idle period.

- 1 Select the RS-232C, LAN, or GP-IB interface.
See " Selecting the Interface" (p.105).
- 2 Send the command to enable the Memory function.
:MEMory:STATe ON
- 3 The MEM indicator lights.

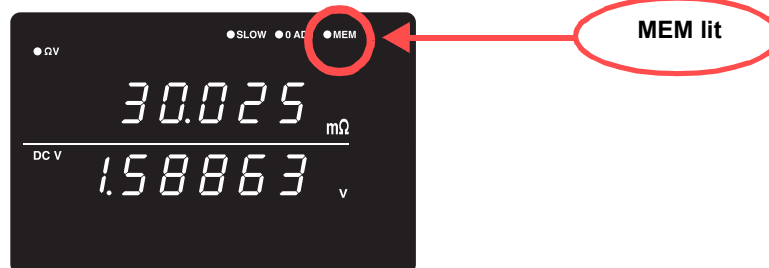

- 4 Measurement values are stored.
When a trigger is applied by the **TRIG** key, $\overline{\text{TRIG}}$ EXT I/O input signal or ***TRG** command, the MEM indicator blinks once and the measured value is stored.

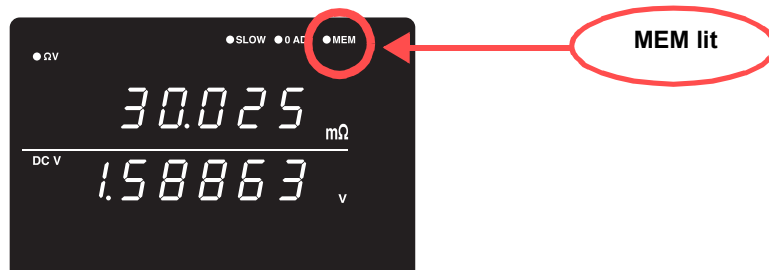

If an external trigger source is selected, one measurement is stored after each trigger event. In the internal triggering case, the first measurement value after triggering is stored. Apply a trigger as many times as is necessary.

5 Send the command to download the data from memory.

:MEMory:DATA?

The stored measurement values are returned in response.

```
:MEM:DATA?
1, 290.60E-3, 1.3924E+0
2, 290.54E-3, 1.3924E+0
3, 290.50E-3, 1.3923E+0
4, 290.43E-3, 1.3923E+0
5, 290.34E-3, 1.3924E+0
END
```

The “END” character is sent as the last line of the data.

To download stored data one measurement at a time, send this command:

:MEMory:DATA? STEP

The instrument sends one stored data object and enters the wait state.

When the instrument receives an “N” from the PC or other device, the next stored data object is sent.

Repeat until the last data object is downloaded.

When all stored data has been downloaded, the instrument sends an “END” character.

```
:MEM:DATA? STEP
1, 290.60E-3, 1.3924E+0
N (sent from PC)
2, 290.54E-3, 1.3924E+0
N (sent from PC)
3, 290.50E-3, 1.3923E+0
N (sent from PC)
4, 290.43E-3, 1.3923E+0
N (sent from PC)
5, 290.34E-3, 1.3924E+0
N (sent from PC)
END
```

6 To clear the instrument's memory, send it the following command.

:MEMory:CLEAr

Unless the memory is cleared, measurement data continues to be stored upon each trigger event.

NOTE

- The instrument's memory storage capacity is 400 measurements. Be aware that attempting to store more data (by applying a trigger) results in nothing further being stored.
- Refer to Chapter 8 RS-232C/GP-IB/LAN Interfaces (Page 99), for details about the communication methods and sending and receiving commands.
- When the Memory function is enabled, auto-ranging is not available.
- Memory contents are cleared when performing the following operations:
 - When enabling the Memory function (off to on)
 - When changing the measurement range
 - When changing comparator settings
 - When sending the **:Memory:Clear** command
 - When Reset is executed from the menu display
 - When sending ***RST**
 - When sending **:SYSTEM:RESet**
 - When turning power on

Disabling the Memory Function

- 1 Send the command to enable the Memory function Off.
:MEMory:STATe OFF
- 2 The Memory function is disabled. (**MEM** not lit)

4.7 Key-Lock Function

Executing Key-Lock disables the operating keys on the front of the instrument. This function can be useful for protecting settings.

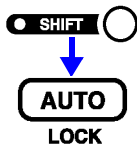

(The SHIFT indicator lights up.)

Enable the Key-Lock function.

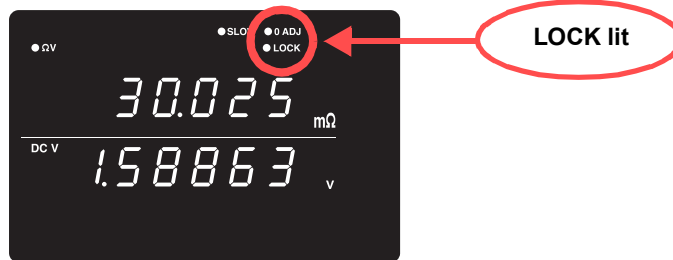

NOTE

- Even if the power supply is interrupted, the Key-Lock function is not canceled.
- The **TRIG** key remains operational.

Disabling Key-Lock

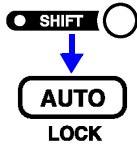

(The SHIFT indicator lights up.)

Disable the Key-Lock function. (**LOCK** not lit)

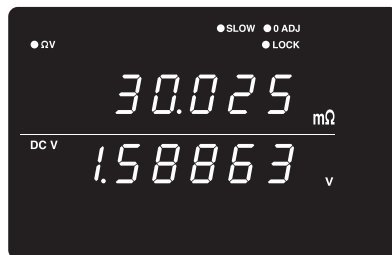

NOTE

When communicating by remote control, the remote control status is canceled.

4.8 Panel Save Function

The current measurement setting state is stored (saved) in non-volatile memory. Up to 126 sets of measurement states can be saved.

The measurement settings (state) at the time this function is executed are saved.

Saved measurement states can be reloaded using the Panel Load function, described later.

- 1**

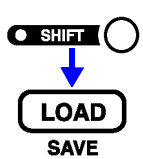

(The SHIFT indicator lights up.)

The Panel Saving display appears.

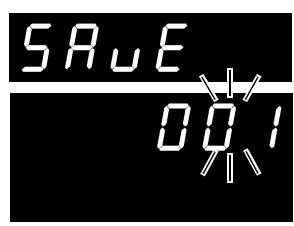

(Main Display)

(Sub Display)
The panel number blinks.
- 2**

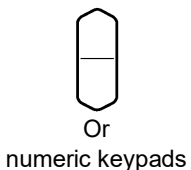

Select the panel number to save.



(Sub Display)
(To save measurement settings as Panel No. 3)

When selecting a saved panel, "USED" is displayed.
- 3**



Saves the measurement setting state and returns to the Measurement display.

To cancel the settings: **SHIFT** key

NOTE

- If you select a Panel number that was previously saved and press the **ENTER** key, the contents are overwritten.
- The Key-Lock state can be saved only by the **:SYSTEM:SAVE** remote command.

Saved Items

- Measurement mode setting
- Range setting
- Auto-ranging setting
- Sampling rate setting
- Comparator settings
- Internal/External trigger setting
- Switching displays setting
- Delay setting
- Zero-Adjust setting
- Averaging setting
- Key-Lock
- Statistical Calculation setting

(The absolute value judgment function setting is not saved.)

4.9 Panel Load Function

Loads the measurement settings saved by the Panel Save function from internal non-volatile memory.

1

LOAD

The Panel Loading display appears.

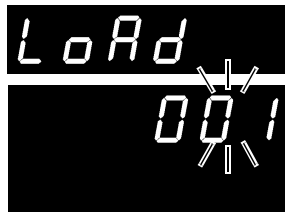

(Main Display)

(Sub Display)

The panel number blinks.

2

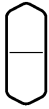

Or
numeric keypads

Select the panel number to load.



(Sub Display)

(To load measurement settings from Panel No.3)

3

ENTER

Loads the measurement setting state and returns to the Measurement display.

To cancel the settings: **SHIFT** key

NOTE

- If an unsaved Panel No. is selected, a warning beep sounds when you press **ENTER** key.
- When selecting a Panel No. with the up/down **RANGE** keys, only the numbers of previously saved panels appear.
- Loading can also be executed using the $\overline{\text{TRIG}}$ signal and the $\overline{\text{LOAD0}}$ to $\overline{\text{LOAD6}}$ pins of the EXT I/O interface.

See " Input Signals" (p.81).



4.10 Self-Calibration

The self-calibration function adjusts offset voltage and gain drift of the instrument's internal circuitry to improve measurement precision.

The instrument's measurement accuracy specifications depend on self-calibration, so it must be executed frequently. In particular, always execute self-calibration after warm-up and when the ambient temperature changes by more than 2°C. However, regardless of this setting, self-calibration is executed during every measurement when SLOW sampling is used.

Self-calibration can be executed by the following two methods:



| | |
|--------|--|
| Auto | Executes self-calibration automatically once every 30 minutes. |
| Manual | Self-calibration can be executed manually by applying a CAL input signal (shorting the CAL terminal to the ISO_COM of the EXT I/O connector). It can also be executed with the SYSTem:CALibration command. (p.147) |

- 1**  (The SHIFT indicator lights up.)
 The Menu display appears.
- 2**  The Self-Calibration setting display appears.
See "1.4 Menu Display Sequence (SHIFT → ENTER)" (p.16).

CAL, b

(Main Display)

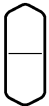

(Sub Display)
The current setting blinks.
- 3**  Select Auto or Manual on the Sub Display.
AUto Auto self-calibration
in..... Manual self-calibration
- 4**  Applies setting and returns to the Measurement display.



NOTE





Self-calibration requires about 55 ms, during which measurement processing is temporarily suspended.

4.11 Measurement Value Output Function

This function causes output of measured values via the RS-232C or LAN interface in the same sequence as trigger input.

This function is useful when measuring using internal (free-run) triggering, and for obtaining measured values on a PC when using a footswitch for triggering.

- 1**  (The SHIFT indicator lights up.)
 The Menu display appears.
- 2**  The Measurement Value Output function setting display appears.
See "1.4 Menu Display Sequence (SHIFT → ENTER)" (p.16).



 (Main Display)
  (Sub Display)
 The current setting blinks.
- 3**  Turn Measurement Value Output Function on or off.
on..... enables the measurement value output function on.
off..... disables the measurement value output function off.
- 4**  Applies setting and returns to the Measurement display.
- 5**  The measured value is output from the RS-232C or LAN interface when you press the **TRIG** key or when a signal is applied to the EXT I/O TRIG terminal.
 Set the PC to the receiving state beforehand. When a measurement value is received, the PC should perform appropriate processing such as recording or displaying, then re-enable the receiving state.

NOTE

- When external triggering is enabled, a measurement is performed and the value is sent after each trigger event. When internal triggering is enabled, the first value measured after triggering is sent.
- The measurement output function is not applicable to the GP-IB interface or printer.

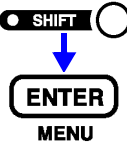

4.12 Key Beeper Setting

Select whether a beep sounds when an operating key on the front of the instrument is pressed.

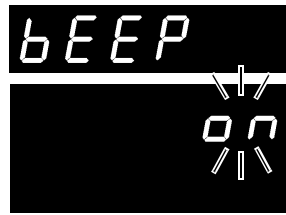
- 1**  (The SHIFT indicator lights up.)
The Menu display appears.
- 2**  The Key Beeper setting display appears.
See "1.4 Menu Display Sequence (SHIFT → ENTER)" (p.16).



(Main Display)

(Sub Display)
The current setting blinks.
- 3**  Select the key beeper state on the Sub Display.
on..... Key beeper enabled.
off Key beeper disabled.
- 4**  Applies setting and returns to the Measurement display.

4.13 Reset Function

The reset function can be used to re-initialize current measurement settings (excluding saved panel data) to their factory defaults, or to re-initialize all measurement settings including saved panel data to factory defaults.

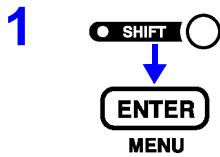

1 (The SHIFT indicator lights up.)

The Menu display appears.



2 The Reset display appears.

See "1.4 Menu Display Sequence (SHIFT → ENTER)" (p.16).

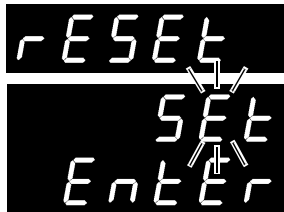

(Main Display)

(Sub Display)

The current setting blinks.

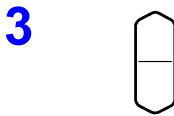

3 Select the Reset method on the Sub Display.

SEt..... Reset (initializes measurement settings other than those stored with Panel Save)

SYS..... System Reset (initialize all measurement settings)



4 **ENTER** blinks.



(Sub Display)

When SYS (system reset) is selected



5 Executes the Reset.

To cancel the settings: **SHIFT** key

NOTE

System Reset also initializes Panel Save data.

Executing either of them cannot initialize the LAN interface settings. To initialize the LAN interface settings, execute the reset from the **SEt** item of the LAN settings. (p.105)

Initial Factory Default Settings

| Description | Default |
|--|--|
| Measurement Mode | Ω V |
| Resistance Measurement Range | 3 m Ω (BT3562, BT3563) 30 m Ω (BT3561A) |
| Voltage Measurement Range | 6 V |
| Auto Range | ON |
| Zero-Adjust | OFF |
| Delay | OFF |
| Delay Time | 0.000s |
| Sampling Rate | SLOW |
| Averaging Function | OFF |
| Average Times | 2 |
| Self-Calibration | AUTO |
| Continuous Measurement | ON |
| Trigger Source | Internal trigger |
| Line Frequency | AUTO |
| Key Beeper Setting | ON |
| Key-Lock Function | OFF |
| Comparator | OFF |
| Comparator Threshold Method (resistance and voltage) | Hi, Lo |
| Comparator Upper Threshold (resistance and voltage) | 0 |
| Comparator Lower Threshold (resistance and voltage) | 0 |
| Comparator Judgment Beeper | OFF |
| Comparator Execution Mode | AUTO |
| Statistical Calculation Functions | OFF |
| Automatic Clearing of Statistical Calculation Results | OFF |
| Interface | RS-232C |
| Baud Rate | 9600 bps |
| GP-IB Address | 1 |
| GP-IB Delimiter | LF |
| Print Interval | 0 (The interval print disabled) |
| Error Output | ASync |
| Measurement Value Output Function | OFF |
| EOM Output | HOLD |
| EOM Pulse Width | 1 ms |
| Measurement current pulse function | OFF |
| Comparator absolute value judgment function | OFF |

External Control (EXT I/O)

Chapter 5

5.1 Overview



External Control Input Functions

- External trigger input ($\overline{\text{TRIG}}$)
- Select Panel No. to load ($\overline{\text{LOAD0}}$ to $\overline{\text{LOAD6}}$)
- Zero-adjust signal input ($\overline{\text{0ADJ}}$)
- Print Signal input ($\overline{\text{PRINT}}$)
- Self-calibration signal input ($\overline{\text{CAL}}$)
- Manual comparator judgment input ($\overline{\text{MANU}}$)

External Output Terminal Func- tions

- End-of-Conversion signal output ($\overline{\text{EOM}}$)
- Reference signal output ($\overline{\text{INDEX}}$)
- Measurement Fault signal output ($\overline{\text{ERR}}$)
- Comparator decision signal output ($\overline{\text{R-Hi}}$, $\overline{\text{R-IN}}$, $\overline{\text{R-Lo}}$, $\overline{\text{V-Hi}}$, $\overline{\text{V-IN}}$, $\overline{\text{V-Lo}}$, $\overline{\text{PASS}}$, $\overline{\text{FAIL}}$)

WARNING

To avoid electric shock or damage to the equipment, always observe the following precautions when connecting to the EXT I/O terminals.

- Always turn off the power to the instrument and to any devices to be connected before making connections.
- During operation, a wire becoming dislocated and contacting another conductive object can be serious hazard. Make sure that connections are secure and use screws to secure the external connectors.
- Ensure that devices and systems to be connected to the EXT I/O terminals are properly isolated.

CAUTION

To avoid damage to the instrument, observe the following cautions:

- Do not apply voltage or current to the EXT I/O terminals that exceeds their ratings.
- When driving relays, be sure to install diodes to absorb counter-electromotive force.
- Be careful not to short-circuit ISO_5V to ISO_COM.

See: "5.2 Signal Descriptions" (p.80)

5.2 Signal Descriptions

Pinout

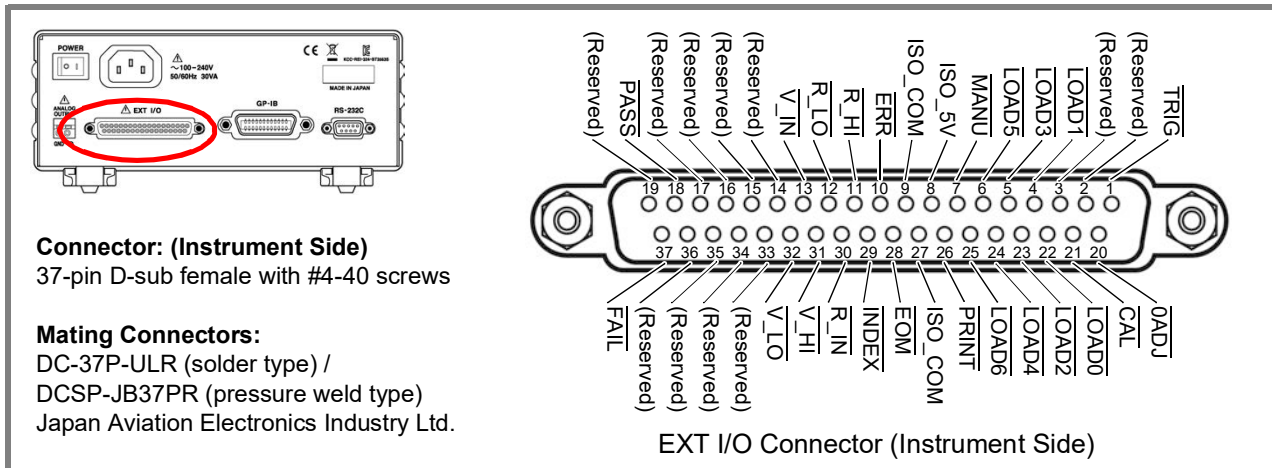

| Pin | Signal name | I/O | Function | Logic |
|-----|---------------------------|-----|-------------------------------|------------------|
| 1 | $\overline{\text{TRIG}}$ | IN | External trigger | Pos/ Neg Edge |
| 2 | (Reserved) | - | - | - |
| 3 | (Reserved) | - | - | - |
| 4 | $\overline{\text{LOAD1}}$ | IN | Load no. bit 1 | Neg Level |
| 5 | $\overline{\text{LOAD3}}$ | IN | Load no. bit 3 | Neg Level |
| 6 | $\overline{\text{LOAD5}}$ | IN | Load no. bit 5 | Neg Level |
| 7 | $\overline{\text{MANU}}$ | IN | Comparator manual control | Neg Level |
| 8 | ISO_5V | - | Isolated 5 V power output | - |
| 9 | ISO_COM | - | Isolated common signal ground | - |
| 10 | $\overline{\text{ERR}}$ | OUT | Measurement fault | Neg Level |
| 11 | $\overline{\text{R_HI}}$ | OUT | HI resistance judgment result | Neg Level |
| 12 | $\overline{\text{R_LO}}$ | OUT | LO resistance judgment result | Neg Level |
| 13 | $\overline{\text{V_IN}}$ | OUT | IN voltage judgment result | Neg Level |
| 14 | (Reserved) | OUT | - | - |
| 15 | (Reserved) | OUT | - | - |
| 16 | (Reserved) | OUT | - | - |
| 17 | (Reserved) | OUT | - | - |
| 18 | PASS | OUT | PASS judgment result | Neg Level |
| 19 | (Reserved) | OUT | - | - |

| Pin | Signal name | I/O | Function | Logic |
|-----|---------------------------|-----|-------------------------------|-----------|
| 20 | $\overline{\text{0ADJ}}$ | IN | Zero adjustments | Neg Edge |
| 21 | $\overline{\text{CAL}}$ | IN | Self-calibration execution | Neg Edge |
| 22 | $\overline{\text{LOAD0}}$ | IN | Load no. bit 0 | Neg Level |
| 23 | $\overline{\text{LOAD2}}$ | IN | Load no. bit 2 | Neg Level |
| 24 | $\overline{\text{LOAD4}}$ | IN | Load no. bit 4 | Neg Level |
| 25 | $\overline{\text{LOAD6}}$ | IN | Load no. bit 6 | Neg Level |
| 26 | $\overline{\text{PRINT}}$ | IN | Print measured value | Neg Edge |
| 27 | ISO_COM | - | Isolated common signal ground | - |
| 28 | $\overline{\text{EOM}}$ | OUT | End of measurement | Neg Edge |
| 29 | $\overline{\text{INDEX}}$ | OUT | Analog measurement finished | Neg Edge |
| 30 | $\overline{\text{R_IN}}$ | OUT | IN resistance judgment result | Neg Level |
| 31 | $\overline{\text{V_HI}}$ | OUT | Hi voltage judgment result | Neg Level |
| 32 | $\overline{\text{V_LO}}$ | OUT | Lo voltage judgment result | Neg Level |
| 33 | (Reserved) | - | - | - |
| 34 | (Reserved) | - | - | - |
| 35 | (Reserved) | - | - | - |
| 36 | (Reserved) | - | - | - |
| 37 | FAIL | OUT | Judgment result FAIL | Neg Level |

Reserved pins are not connected inside the instrument.
Do not connect to reserved pins.

NOTE

The connector frame is connected to (continuous with) both the instrument's case (the metal cabinet surrounding the instrument) and the power inlet's protective ground pin. Note that the frame is not isolated from the ground.

Input Signals

$\overline{\text{LOAD0}}$ to $\overline{\text{LOAD6}}$

Select a Panel No. to load and apply a $\overline{\text{TRIG}}$ signal to load the selected Panel No. and measure. $\overline{\text{LOAD0}}$ is the LSB, and $\overline{\text{LOAD6}}$ is the MSB.

When a TRIG signal is applied, if $\overline{\text{LOAD0}}$ through $\overline{\text{LOAD6}}$ are unchanged from the previous trigger event, panel settings are not loaded. In this case, using external triggering, one measurement is taken as usual when the $\overline{\text{TRIG}}$ signal is applied.

| Panel No. | $\overline{\text{LOAD6}}$ | $\overline{\text{LOAD5}}$ | $\overline{\text{LOAD4}}$ | $\overline{\text{LOAD3}}$ | $\overline{\text{LOAD2}}$ | $\overline{\text{LOAD1}}$ | $\overline{\text{LOAD0}}$ |
|-----------|---------------------------|---------------------------|---------------------------|---------------------------|---------------------------|---------------------------|---------------------------|
| * | 0 | 0 | 0 | 0 | 0 | 0 | 0 |
| 1 | 0 | 0 | 0 | 0 | 0 | 0 | 1 |
| 2 | 0 | 0 | 0 | 0 | 0 | 1 | 0 |
| 3 | 0 | 0 | 0 | 0 | 0 | 1 | 1 |
| 4 | 0 | 0 | 0 | 0 | 1 | 0 | 0 |
| 5 | 0 | 0 | 0 | 0 | 1 | 0 | 1 |
| 6 | 0 | 0 | 0 | 0 | 1 | 1 | 0 |
| 7 | 0 | 0 | 0 | 0 | 1 | 1 | 1 |
| 8 | 0 | 0 | 0 | 1 | 0 | 0 | 0 |
| ... | | | | | | | |
| 122 | 1 | 1 | 1 | 1 | 0 | 1 | 0 |
| 123 | 1 | 1 | 1 | 1 | 0 | 1 | 1 |
| 124 | 1 | 1 | 1 | 1 | 1 | 0 | 0 |
| 125 | 1 | 1 | 1 | 1 | 1 | 0 | 1 |
| 126 | 1 | 1 | 1 | 1 | 1 | 1 | 0 |
| * | 1 | 1 | 1 | 1 | 1 | 1 | 1 |

0: HIGH: Open or from 5 V to 24 V

1: LOW: 0 V to 0.9 V

* When a $\overline{\text{TRIG}}$ signal is applied with $\overline{\text{LOAD0}}$ to $\overline{\text{LOAD6}}$ set to all 1's or all 0's, no Panel Load occurs.

- At least 70 ms is required for the settings to change after executing a Panel Load (the actual time depends on the particular function, range and sampling rate).
- When set to external trigger mode, one measurement is taken upon load completion.

$\overline{\text{TRIG}}$

When the external trigger, one measurement is taken each time the $\overline{\text{TRIG}}$ signal transitions from High to Low.

This trigger signal is ignored when internal triggering is enabled.

Trigger functions are also available for statistical calculation, recording to memory and output of measured values (valid also with internal triggering).

$\overline{\text{CAL}}$

When manual self-calibration is selected with $\overline{\text{EX.FAST}}$, $\overline{\text{FAST}}$ or $\overline{\text{MEDIUM}}$ sampling rate, self-calibration begins when the $\overline{\text{CAL}}$ signal transitions from High to Low.

Self-calibration takes about 55 ms.

When $\overline{\text{SLOW}}$ sampling is selected, the $\overline{\text{CAL}}$ signal is ignored.

See "4.10 Self-Calibration" (p.73).

| | |
|--------------------|--|
| $\overline{0ADJ}$ | Zero adjustment executes once when the $\overline{0ADJ}$ signal transitions from High to Low. |
| \overline{PRINT} | The current measurement value prints when the \overline{PRINT} signal transitions from High to Low. |
| \overline{MANU} | When the \overline{MANU} comparator mode is selected, comparator judgment is enabled while the \overline{MANU} signal is Low. See " Comparator Execution Mode Setting" (p.52). |

Output Signals

| | |
|--|---|
| \overline{ERR} | Indicates a measurement fault. The Synchronous \overline{ERR} output setting causes \overline{ERR} output to be synchronous with \overline{EOM} output, while with the Asynchronous \overline{ERR} output setting causes \overline{ERR} output to follow actual (asynchronous) contact of the probes with the test object. See " ERR Output" (p.83). |
| \overline{INDEX} | The \overline{INDEX} signal is output during the Trigger Wait, Delay, Self-Calibration and Calculation states. This signal is not output while measuring the resistance of test objects. This signal transitions from Hi (Off) to Lo (On) to indicate that the test object can be removed. |
| \overline{EOM} | This signal indicates the end of a measurement (End-Of-Conversion). This signal indicates when comparator judgment results and \overline{ERR} output (when SYNC is enabled) are available. |
| $\overline{R-Hi}, \overline{R-IN}, \overline{R-Lo}$ $\overline{V-Hi}, \overline{V-IN}, \overline{V-Lo}$ | These are the results of comparator decision. |
| \overline{PASS} | This signal indicates when both resistance and voltage judgment results are IN (ΩV mode). It transitions to Low (ON) when both the resistance and voltage judgment results are IN. In the Ω and V modes, this signal is the same as $\overline{R-IN}$ and $\overline{V-IN}$ outputs, respectively. |
| \overline{FAIL} | This signal transitions to Low (ON) when \overline{PASS} is High (OFF). |

NOTE

- I/O signals should not be used while measurement settings have been changed.
- The \overline{EOM} and \overline{INDEX} signals are initialized HIGH (OFF) at power on.
- If it is not necessary to change the measurement conditions, set $\overline{LOAD0}$ through $\overline{LOAD6}$ to either Hi or Lo.
- To avoid erroneous comparator judgments, both the \overline{PASS} and \overline{FAIL} signals should be checked.

ERR Output

The ERR output signal indicates the occurrence of measurement fault conditions (such as open test leads, or a bad contact). There are two ERR output methods.

Synchronized with EOM Output (SYNC)

Measurement faults detected while measuring (not while awaiting trigger or during delay or calculation intervals), are indicated by ERR output synchronous with EOM output (the end-of-measurement signal).

ERR Output Low (On): A measurement fault has prevented correct measurement
ERR Output High (Off): Correct measurement obtained (OF or -OF: Out-of-range cases are included)

Asynchronous with EOM Output (ASYNC)





Measurement faults (test lead connection conditions) are output in real time. The output is asynchronous with the $\overline{\text{TRIG}}$ signal and EOM output.

ERR Output Low (On): Measurement fault condition (open test leads, or a bad contact)



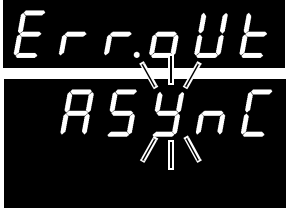

ERR Output High (Off): Test lead connections are normal

Instrument Settings

Measurement Fault Output Signal ($\overline{\text{ERR}}$) Setting

- 1**  (The SHIFT indicator lights up.)
 The Menu display appears.
- 2**  Select the ERR Output Selection display.
See "1.4 Menu Display Sequence (SHIFT → ENTER)" (p.16).
 (Main Display)
 (Sub Display)
 The current setting blinks.
- 3**  Select the type of signal to be output on the Sub Display.
Sync Synchronous output (synchronized with EOM output)
ASync Asynchronous output (not synchronized with EOM output)
- 4**  Applies settings and returns to the Measurement display.

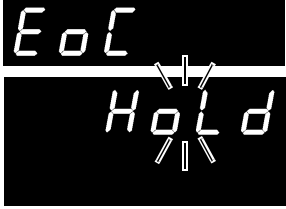
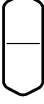
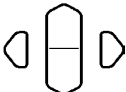
Setting the $\overline{\text{EOM}}$ Signal

- 1**  (The SHIFT indicator lights up.)
 The Menu display appears.
- 2**  Select the $\overline{\text{EOM}}$ -signal setup display.
See "1.4 Menu Display Sequence (SHIFT → ENTER)" (p.16).
 (Main Display)
 (Sub Display)
 The current setting blinks.
- 3**  Choose the output method for the $\overline{\text{EOM}}$ signal.
HoLd Holds the $\overline{\text{EOM}}$ signal after measurement.
 → Go to Step 5.
PULSE Outputs the specified pulse after measurement.
 → Go to the next step.
- 4**  (When PULSE is selected)
 The number representing the pulse width of the $\overline{\text{EOM}}$ signal will start blinking.
 Set the pulse width in ms.
 Or numeric keypads
- 5**  Applies settings and returns to the Measurement display.

5.3 Timing Chart

External Trigger Timing Chart

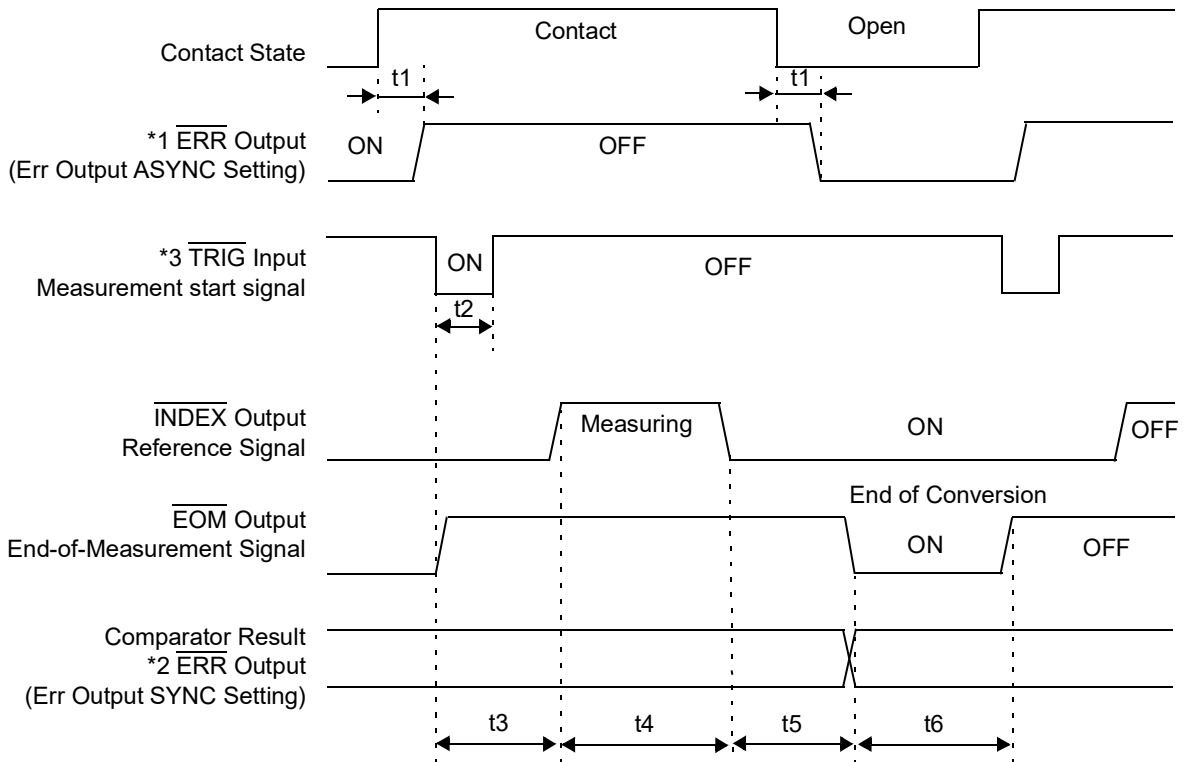

*1: For details, see "'ERR Output" (p.83)."

*2: When ERR output is set to the SynChronous mode, measurement fault detection results can be obtained when measurement is finished, as with comparator results.

*3: After connecting to the test object, wait for longer than the response time (approximately 10 ms) before inputting the TRIG signal (It is necessary to wait out the response time for the measurement values to stabilize after connection. Response times depend on the test object).

Internal Trigger Timing Chart

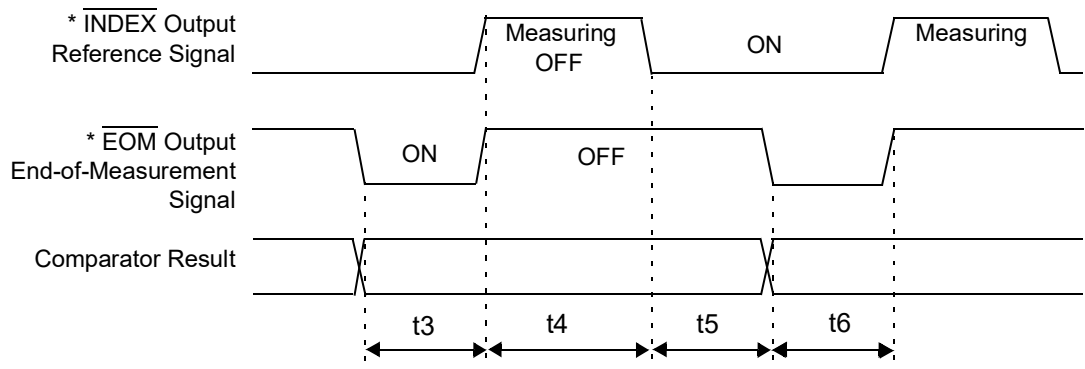

* When the $\overline{\text{EOM}}$ signal is set to PULSE, the signal will remain on only for the specified period upon completion of conversion.

5.3 Timing Chart

| Description | Time | | | | | | | | | | | | | | | | | | | | | | | | | | | | | | | | |
|---|--|-------------------------|---|-------------------------|--|---------|--------|---------|--------|------|---------|------|---------|--------|---------|--------|--|--|---------|--|--|------|----------|--|--|--|----------|------|---|--|--|--|---|
| t1 $\overline{\text{ERR}}$ Output response time ^{*1} | 1.5 ms | | | | | | | | | | | | | | | | | | | | | | | | | | | | | | | | |
| t2 Measurement trigger pulse width | 0.5 ms or more. | | | | | | | | | | | | | | | | | | | | | | | | | | | | | | | | |
| t3 Delay Time | per setting See " Trigger Delay Settings" (p.60). | | | | | | | | | | | | | | | | | | | | | | | | | | | | | | | | |
| t4 Measurement time ^{*2} | <table border="0"> <tr> <td>ΩV mode</td> <td></td> <td>Ω mode or V mode</td> <td></td> </tr> <tr> <td>EX.FAST</td> <td>7.8 ms</td> <td>EX.FAST</td> <td>3.4 ms</td> </tr> <tr> <td>FAST</td> <td>23.8 ms</td> <td>FAST</td> <td>11.4 ms</td> </tr> <tr> <td>MEDIUM</td> <td>83.8 ms</td> <td>MEDIUM</td> <td>41.4 ms (50 Hz line frequency setting)</td> </tr> <tr> <td></td> <td>69.8 ms</td> <td></td> <td>34.4 ms (60 Hz line frequency setting)</td> </tr> <tr> <td>SLOW</td> <td>258.8 ms</td> <td></td> <td></td> </tr> <tr> <td></td> <td>252.2 ms</td> <td>SLOW</td> <td>156.4 ms (50 Hz line frequency setting)</td> </tr> <tr> <td></td> <td></td> <td></td> <td>149.8 ms (60 Hz line frequency setting)</td> </tr> </table> | Ω V mode | | Ω mode or V mode | | EX.FAST | 7.8 ms | EX.FAST | 3.4 ms | FAST | 23.8 ms | FAST | 11.4 ms | MEDIUM | 83.8 ms | MEDIUM | 41.4 ms (50 Hz line frequency setting) | | 69.8 ms | | 34.4 ms (60 Hz line frequency setting) | SLOW | 258.8 ms | | | | 252.2 ms | SLOW | 156.4 ms (50 Hz line frequency setting) | | | | 149.8 ms (60 Hz line frequency setting) |
| Ω V mode | | Ω mode or V mode | | | | | | | | | | | | | | | | | | | | | | | | | | | | | | | |
| EX.FAST | 7.8 ms | EX.FAST | 3.4 ms | | | | | | | | | | | | | | | | | | | | | | | | | | | | | | |
| FAST | 23.8 ms | FAST | 11.4 ms | | | | | | | | | | | | | | | | | | | | | | | | | | | | | | |
| MEDIUM | 83.8 ms | MEDIUM | 41.4 ms (50 Hz line frequency setting) | | | | | | | | | | | | | | | | | | | | | | | | | | | | | | |
| | 69.8 ms | | 34.4 ms (60 Hz line frequency setting) | | | | | | | | | | | | | | | | | | | | | | | | | | | | | | |
| SLOW | 258.8 ms | | | | | | | | | | | | | | | | | | | | | | | | | | | | | | | | |
| | 252.2 ms | SLOW | 156.4 ms (50 Hz line frequency setting) | | | | | | | | | | | | | | | | | | | | | | | | | | | | | | |
| | | | 149.8 ms (60 Hz line frequency setting) | | | | | | | | | | | | | | | | | | | | | | | | | | | | | | |
| t5 Calculation time ^{*3} | 0.3 ms | | | | | | | | | | | | | | | | | | | | | | | | | | | | | | | | |
| t6 $\overline{\text{EOM}}$ Output pulse width | <p>When the external trigger is selected</p> <p>HOLD setting : Holds until the next trigger is detected</p> <p>PULSE setting : Remains only for the specified pulse width</p> <p>See " Instrument Settings" (p.84).</p> <p>When the internal trigger is selected</p> <p>HOLD setting : EX.FAST 1 ms, FAST 5 ms, MEDIUM 20 ms (50 Hz line frequency setting)/ 16 ms (60 Hz line frequency setting), SLOW 50 ms</p> <p>PULSE setting : Remains only for the specified pulse width</p> | | | | | | | | | | | | | | | | | | | | | | | | | | | | | | | | |

*1: For details, see ""ERR Output" (p.83)."

*2: About t4 measurement time

When averaging is enabled, the running average is obtained with internal triggering, so measurement time t4 does not change. The measurement time for external triggering is as follows:

With SLOW sampling

| | |
|---------------|--|
| Ω V | $(t4 - 57.8) \times n + 57.8$ ms (50 Hz) |
| | $(t4 - 51.2) \times n + 51.2$ ms (60 Hz) |
| Ω or V | $(t4 - 56.4) \times n + 56.4$ ms (50 Hz) |
| | $(t4 - 49.8) \times n + 49.8$ ms (60 Hz) |

With other than SLOW sampling

| | |
|---------------|--------------------------------|
| Ω V | $(t4 - 2.8) \times n + 2.8$ ms |
| Ω or V | $(t4 - 1.4) \times n + 1.4$ ms |

(n represents the number of values averaged)

*3: About t5 calculation time

In the following cases, add the indicated times to calculation time t5:

| | |
|--|---------|
| When the Statistical Calculation function is enabled | 0.3 ms |
| When the reference value/tolerance method of comparator decision is selected | 0.15 ms |

5.4 Internal Circuitry

Input Circuit

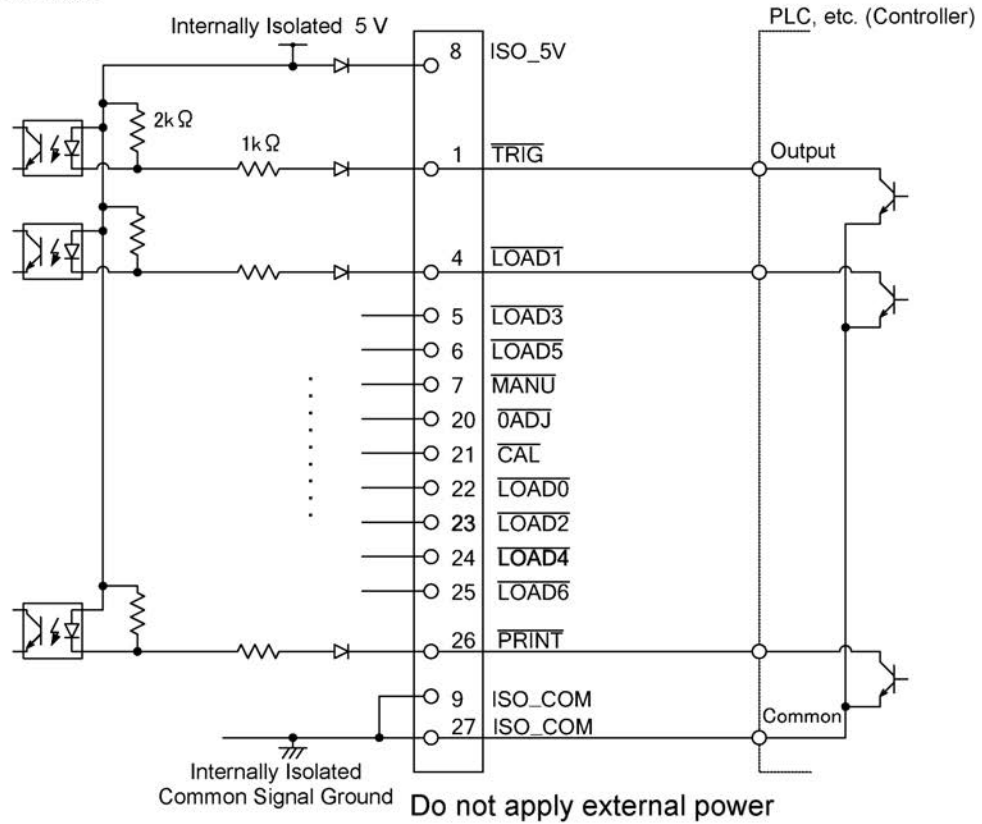

Output Circuit

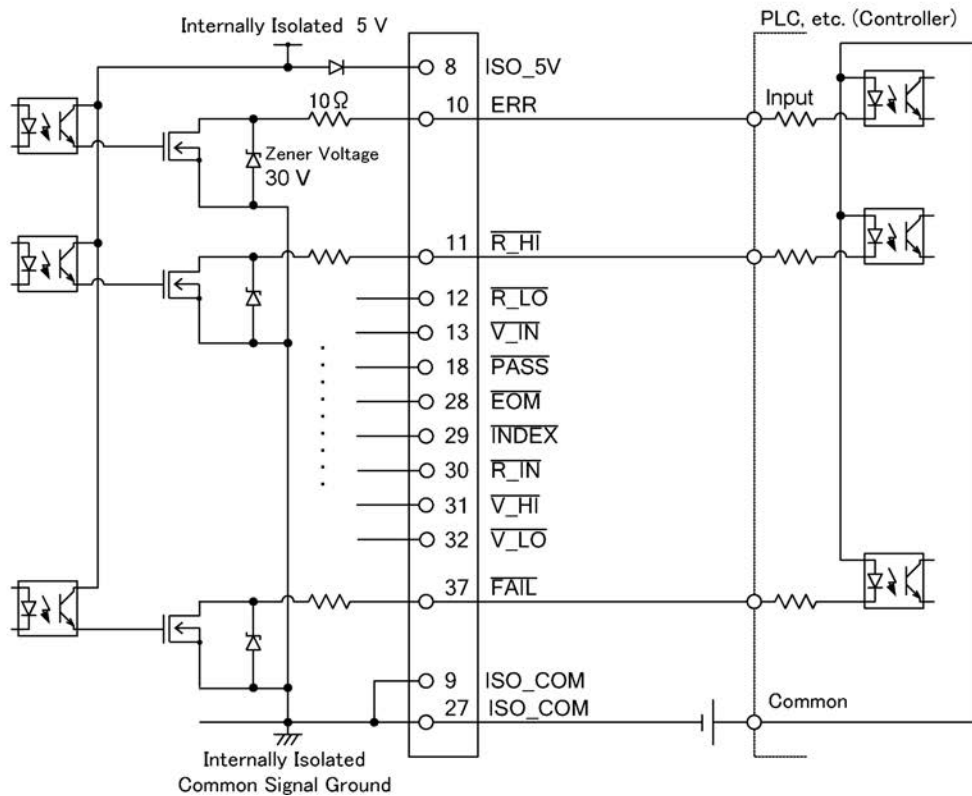

Electrical Specifications

| | | |
|---|---------------------------------|---|
| Input Signals | Input type | Optocoupler-isolated, non-voltage contact inputs (source input, active-low) |
| | Input asserted (ON) voltage | 1 V or less |
| | Input de-asserted (OFF) voltage | Open or 5 to 30 V |
| | Input asserted (ON) current | 3 mA/ch |
| | Maximum applied voltage | 30 V |
| Output Signals | Output type | Optocoupler-isolated Nch open-drain outputs (current sink) |
| | Maximum load voltage | 30 V |
| | Maximum output current | 50 mA/ch |
| | Residual voltage | 1 V (10 mA), 1.5 V (50 mA) |
| Internally Isolated Power Output | Output Voltage | 4.5 to 5.0 V |
| | Maximum output current | 100 mA |
| | External power input | none |

Connection Examples

Input Circuit Connection Examples

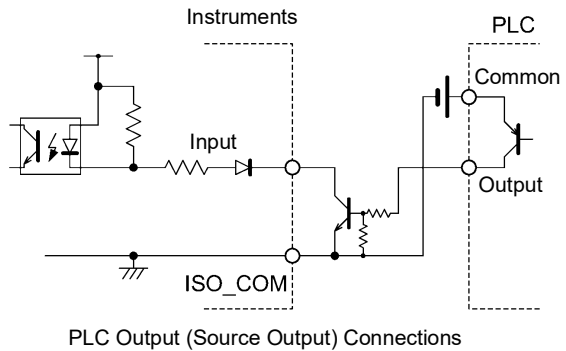
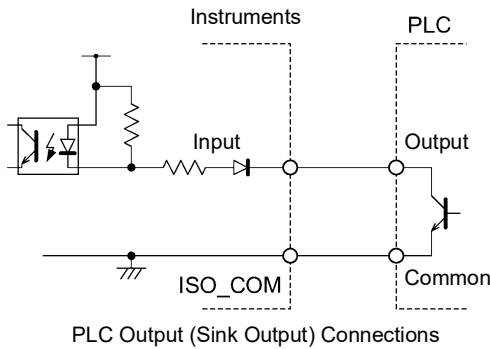
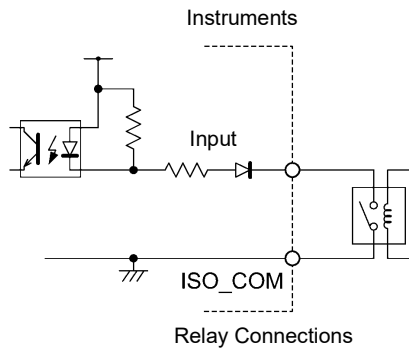
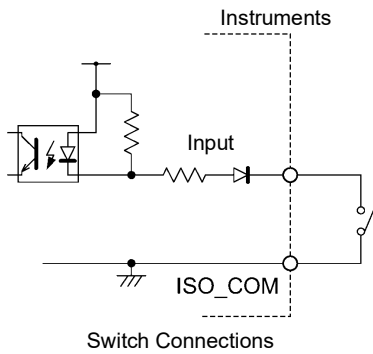

Output Circuit Connection Examples

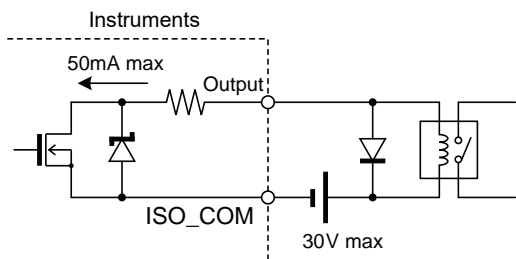

Relay Connections

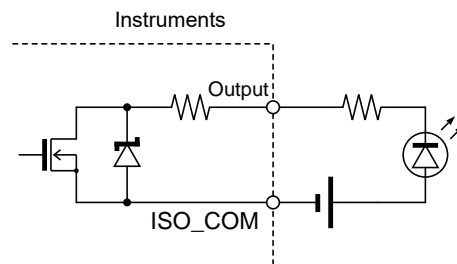

LED Connection

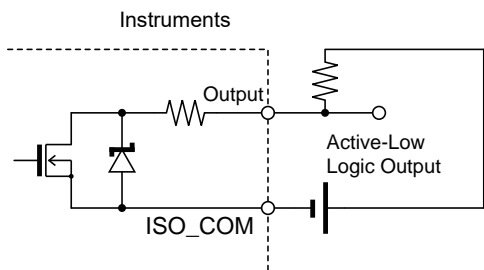

Active-Low Logic Output

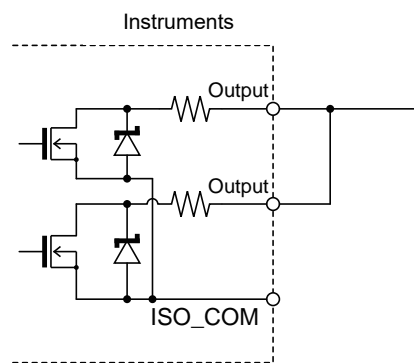

Wired OR

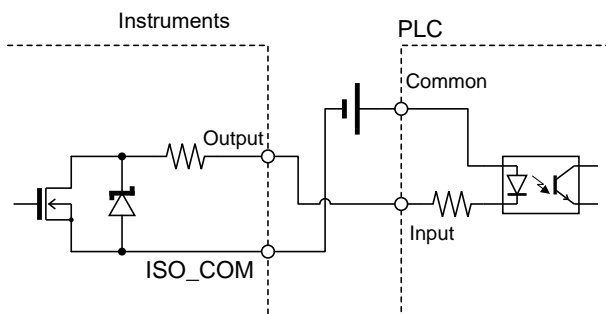

PLC Input (Source Input) Connections

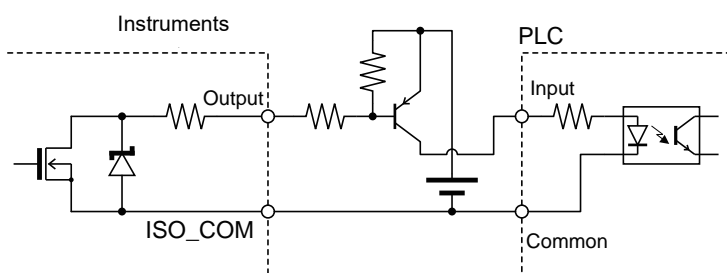

PLC Input (Sink Input) Connections

5.5 External Control Q&A

| Common Questions | Answers |
|---|--|
| How do I connect external trigger input? | Connect the (active low) $\overline{\text{TRIG}}$ input pin to an ISO_COM pin using a switch or open-collector output. |
| Which pins are common ground for input and output signals? | The ISO_COM pins. |
| Are the common (signal ground) pins shared by both inputs and outputs? | Both common ground pins can be shared by inputs and outputs. |
| How do I confirm output signals? | Confirm voltage waveforms with an oscilloscope. To do this, the output pins such as $\overline{\text{EOM}}$ and comparator decision outputs need to be pulled up (through several k Ω). |
| How do I troubleshoot input (control) signal issues? | For example, if triggering does not operate properly, bypass the PLC and short the TRIG pin directly to an ISO_COM pin. Be careful to avoid power shorts. |
| Are the comparator decision signals retained during measurement (or can they be off)? | The state is determined at the end of measurement, and is off once at the start of measurement. |
| Why would the $\overline{\text{EOM}}$ signal not be detected? | Try using the Pulse setting for EOM output. When the measurement time is short and EOM output is set to Hold, the time to de-assert may be too short to be detected by the PLC. When the EOM output is set to Pulse, the signal is asserted (ON) for the specified pulse width before turning off. |
| What situations cause measurement faults to occur? | An error is displayed in the following cases: <ul style="list-style-type: none"> • A probe is not connected • A contact is unstable • A probe or measurement object is dirty or corroded • Measurement object resistance is much higher than the measurement range |
| Is a connector or flat cable for connection provided? | A solder-type connector is supplied. The cable must be prepared at the user's side. |
| Is direct connection to a PLC possible? | Direct connection is supported for relay or open-collector outputs and positive-ground optocoupler inputs. (Before connecting, confirm that voltage and current ratings will not be exceeded.) |
| Can external I/O be used at the same time as RS-232C or other communications? | After setting up <u>communications</u> , it is possible to control measurement with the $\overline{\text{TRIG}}$ signal while acquiring measurement data via a communications interface. |
| How should external power be connected? | The instrument's external I/O input and output signals all operate from an internal isolated power source, so power must not be supplied from the PLC side. |
| Can free-running measured values be acquired using a footswitch? | Please use the free software for acquiring measured values available for download from our website. |

Printing

Chapter 6

6.1 Connecting the Printer

Before connecting the printer

WARNING

Because electric shock and instrument damage hazards are present, always follow the steps below when connecting the printer.

- Always turn off the instrument and the printer before connecting.
- A serious hazard can occur if a wire becomes dislocated and contacts another conductor during operation. Make certain connections are secure.

NOTE

- As much as possible, avoid printing in hot and humid environments. Otherwise, printer life may be severely shortened.
- Use only compatible recording paper in the printer. Using non-specified paper may not only result in faulty printing, but printing may become impossible.
- If the recording paper is skewed on the roller, paper jams may result.

Recommended printer

The requirements for a printer to be connected to the instrument are as follows. Confirm compatibility and make the appropriate settings on the printer before connecting it to the instrument.

- Interface RS-232C
- Characters per line..... At least 45
- Communication speed 9600 bps
- Data bits..... 8
- Parity..... none
- Stop bits 1
- Flow control..... none
- Control codes Capable of directly printing plain text

NOTE

The optional printer model 9670 is no longer available. Their model 9670 printers can still use.

Connecting the PRINTER to the Instrument

4 Model BT3562 (BT3562-01)

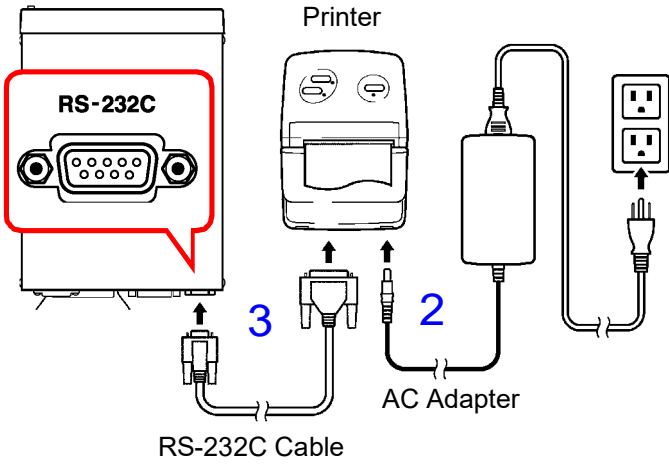

- 1.** Confirm that the instrument and Printer are turned off.
- 2.** Connect the AC Adapter to the Printer, and insert the power plug into an outlet.
- 3.** Connect the RS-232C Cable to the RS-232C connectors on the instrument and printer.
- 4.** Turn the instrument and printer on.

Connector Pinouts

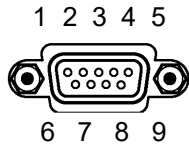

Instrument (9-pin) Connector

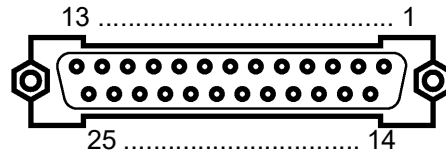

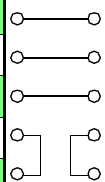

Printer (25-pin) Connector (Example)

| Function | Signal Name | Pin |
|-------------------------|-------------|-----|
| Receive Data | RxD | 2 |
| Transmit Data | TxD | 3 |
| Signal or Common Ground | GND | 5 |
| | | |
| | | |



| Pin | Signal Name | Function |
|-----|-------------|-------------------------|
| 2 | TxD | Transmit Data |
| 3 | RxD | Receive Data |
| 7 | GND | Signal or Common Ground |
| 4 | RTS | Request to Send |
| 5 | CTS | Clear to Send |

6.2 Selecting the Interface

- 1**  (SHIFT Lamp lit)
 The Menu display appears.
- 2**  Select the Interface Selection display.
See "1.4 Menu Display Sequence (SHIFT → ENTER)" (p.16).





(Main Display)



(Sub Display)
The current setting blinks.

Select Printer on the Sub Display.

rS RS-232C
LAn LAN
GP-Ib GP-IB
Prn Printer
- 3**   
Or
numeric keypads

Set the print interval time.

0000Interval printing is OFF. (Printing is carried out once when **PRINT** key is pressed.)
0001 to 3600Sets the print interval time in seconds.
- 4**  Applies setting and returns to the Measurement display.

6.3 Printing

Printing Measured Values and Decision Results

From the Measurement display, press the **PRINT** key or short the $\overline{\text{PRINT}}$ pin to the ISO_COM of the EXT I/O connector to print the measured value and decision result.

NOTE

- When using the external trigger, if you want to print after a triggered measurement finishes, connect the $\overline{\text{EOM}}$ signal of the EXT I/O to the $\overline{\text{PRINT}}$ signal.
- To print all measurements continuously, connect the $\overline{\text{EOM}}$ signal to the $\overline{\text{PRINT}}$ signal and enable the internal trigger.
- When the statistical calculation function is on and the internal trigger is selected, the **TRIG** key or $\overline{\text{TRIG}}$ signal will trigger statistical calculation and printing of the current measurement value.
- Valid counts are 1 to 30000. Above 30000, the count returns to 1.

Interval Printing

This function allows you to automatically print out measurement results at preset intervals. The print interval time must be set from the Interface Selection display. See "6.2 Selecting the Interface" (p.93). The setting range is 1 to 3600 seconds.

When the print interval time is set to "0", interval printing is disabled, and only normal printing is carried out.

Operation when interval printing is selected:

1. Start printing by pressing the **PRINT** key or sending the $\overline{\text{PRINT}}$ signal via EXT I/O.
2. Elapsed time (hours/minutes/seconds) and measurement values are printed automatically at intervals corresponding to the preset interval time.
3. Stop printing by pressing the **PRINT** key or sending the $\overline{\text{PRINT}}$ signal via EXT I/O again.

NOTE

- When the printed elapsed time reaches 100 hours, it resets to 00:00:00 and continues from zero.
(Example)
After 99 hours, 59 minutes and 50 seconds: 99:59:50
After 100 hours, 2 minutes and 30 seconds: 00:02:30
- Selecting a display other than the measurement display causes interval printing to stop.

Printing Statistical Calculation Results

From the Statistical Calculation display, press the **PRINT** key to print statistical calculation results. If no valid data exists, only the data count is printed. When only one valid data sample exists, standard deviation of sample and process capability indices cannot be printed.

Example Printouts

| Measurement values (Ω V mode) | Measurement values (Ω mode) | Measurement values (V mode) |
|--|--|--------------------------------|
| 1 2.5375mOhm, 4.70056 V | 43 17.855mOhm | 100 3.70079 V |
| 2 - 0.9730mOhm, 4.70055 V | 44 0.641 Ohm | 101 -58.3306 V |
| 3 15.142mOhm, -0.00002 V | 45 1.9984kOhm | 102 203.086 V |
| 4 160.68mOhm, 267.031 V | | |
| 5 15.039 Ohm, - 50.254 V | | |
| 6 200.12 Ohm, 11.3176 V | | |
| 7 2.9984kOhm, -11.3099 V | | |
| 8 0.1615 Ohm, -4.70054 V | | |
| 9 0.166 Ohm, - 4.7006 V | | |
| 10 0.16 Ohm, - 4.700 V | | |

With the Comparator ON

| | |
|-----------------------------|----|
| 50 5.033 Ohm Hi, 1.60427 V | IN |
| 51 5.033 Ohm Hi, -0.00001 V | Lo |
| 52 17.855mOhm | IN |
| 53 18.354mOhm | Hi |
| 54 15.322mOhm | Lo |
| 55 4.70072 V | IN |
| 56 -4.70070 V | Lo |

With comparator reference percentages

| | | | |
|----------------|------|---------|----|
| 3120 28.653 % | Hi, | 0.111 % | Hi |
| 3121 - 0.192 % | Lo,- | 0.001 % | IN |
| 3122 O.F. | Hi, | 0.317 % | Hi |

With erroneous measurement values

| | |
|----------------|--------------|
| 90 O.F. | , -4.70053 V |
| 91 1.0647 Ohm, | O.F. |
| 92 O.F. | , O.F. |
| 93 - O.F. | , 4.70051 V |
| 94 ----- | , ----- |
| 95 Invalid | , Invalid |

Statistical Calculations (Comparator ON)

*** RESISTANCE ***

| | | |
|---------|-------------|---------------|
| Number | 85 | |
| Valid | 85 | Max/Min count |
| Average | 13.06mOhm | ↓ |
| Max | 13.78mOhm (| 74) |
| Min | 12.10mOhm (| 3) |
| Sn | 0.38mOhm | |
| Sn-1 | 0.38mOhm | |
| Cp | 1.32 | |
| CpK | 0.09 | |
| Comp Hi | 40 | |
| Comp IN | 45 | |
| Comp Lo | 0 | |

Interval print

| | |
|----------|-----------------------|
| 00:00:00 | 16.020mOhm, 3.70052 V |
| 00:00:01 | 16.015mOhm, 3.70052 V |
| 00:00:02 | 16.010mOhm, 3.70052 V |
| 00:00:03 | 16.006mOhm, 3.70051 V |
| 00:00:04 | 16.002mOhm, 3.70052 V |
| 00:00:05 | 15.999mOhm, 3.70051 V |
| 00:00:06 | 15.998mOhm, 3.70051 V |

*** VOLTAGE ***

| | | |
|---------|-------------|-----|
| Number | 85 | |
| Valid | 85 | |
| Average | 10.0074 V | |
| Max | 10.0197 V (| 57) |
| Min | 9.9938 V (| 31) |
| Sn | 0.0068 V | |
| Sn-1 | 0.0068 V | |
| Cp | 0.35 | |
| CpK | 0.32 | |
| Comp Hi | 10 | |
| Comp IN | 59 | |
| Comp Lo | 16 | |

NOTE

Measurement values indicated as "Invalid" cannot be displayed by the instrument.

The number of statistical calculation results indicated as "Valid" equals the count of valid data excluding measurement faults and overflows.

Analog Output

Chapter 7

The Model BT3561A, BT3562A, BT3562-01, BT3563A, and BT3563-01 are capable of generating analog output for resistance measured values. Changes in resistance values can be recorded by connecting the instrument's analog output to a logger or similar device.

! WARNING

To avoid electrical shock and instrument damage, turn the instrument and connected equipment off and/or disconnect the probes from the test object before connecting the analog output terminals.

! CAUTION

To avoid damaging the instrument, do not short the output terminals or input voltage to them.

7.1 Connecting Analog Output

This section describes how to connect cables to the analog output terminals on the instrument's rear panel.

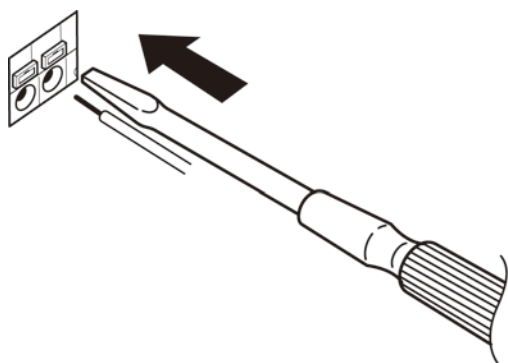

- 1** Push down on the button with a flat-head screwdriver or similar tool.
- 2** Insert the wire into the connection port while holding the button down.
- 3** Release the button to lock the wire in place. A similar procedure can be used to remove the lead.

Recommended wire type : AWG16 (1.2 mm diameter) solid conductor, AWG16 (1.25 mm²) stranded conductor

Compatible wire types : AWG26 (0.4 mm diameter) to AWG16 (1.2 mm diameter) solid conductor, AWG24 (0.2 mm²) to AWG16 (1.25 mm²) stranded conductor

Standard bare wire length : 11 mm

7.2 Analog Output Specifications

| | |
|-------------------|---|
| Output voltage | 0 V to 3.1 V DC (full scale) |
| Resolution | 12-bit (approx. 1 mV) |
| Output resistance | 1 k Ω |
| Output | Resistance measured value (display count value) Fixed at 3.1 V at OF or measurement fault. Fixed at 0 V for negative values. |
| Output rate | 0 counts to 31000 counts \rightarrow 0 V to 3.1 V |
| Output accuracy | Resistance measurement accuracy $\pm 0.2\%$ of full scale. (temperature coefficient $\pm 0.02\%$ of full scale/ $^{\circ}\text{C}$) |
| Response time | Resistance measurement response time + sampling time + 1 ms |

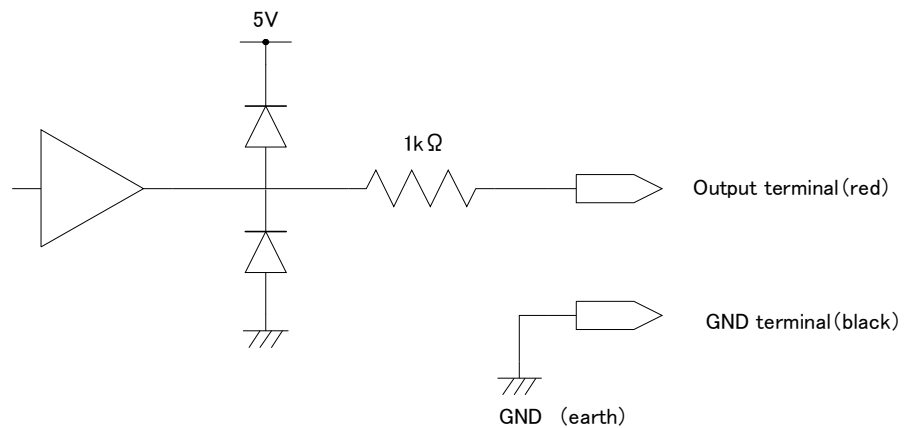

NOTE

- The instrument has an output impedance of 1 k Ω . Connected devices must have an input impedance of at least 10 M Ω . (The output voltage is divided by the output resistance and input impedance, resulting in a reduction of 0.1% for 1 M Ω .)
- Connecting a cable may result in external noise. Implement a bandpass filter or other measures as needed in the connected device.
- The analog output's GND pin is grounded (to the metallic part of the case).
- The output voltage is updated at the resistance measurement sampling timing.
- Recorded waveforms are stepped (since the output circuit response is extremely fast compared to the update period).
- When using auto-ranging, the same resistance value may result in 1/10 (or 10 times) the output voltage due to range switching. It is recommend to set the range manually.
- Output is set to 0 V when changing settings (range switching, etc.) and when the instrument is turned off.

RS-232C/GP-IB/LAN Interfaces

Chapter 8

This chapter describes the GP-IB, LAN, and RS-232C interfaces, using the following symbols to indicate which information pertains to each interface. Descriptions with no mark can be applied to the three of them.

GP-IB : GP-IB only

LAN : LAN only

RS-232C : RS-232C only

Before Use

- GP-IB is available only on Model BT3562-01 and BT3563-01.
- LAN is available only on Model BT3561A, BT3562A or BT3563A.
- Always make use of the connector screws to affix the GP-IB or RS-232C connectors.
- When issuing commands that contain data, make certain that the data is provided in the specified format.

8.1 Overview and Features

All instrument functions other than power on/off switching can be controlled via GP-IB, LAN, and RS-232C interfaces.

- Resetting is supported.

GP-IB

- IEEE 488.2-1987 Common (essential) Commands are supported.
- Complies with the following standard:
Applicable standard IEEE 488.1-1987^{*1}
- This instrument is designed with reference to the following standard:
Reference standard IEEE 488.2-1987^{*2}
- If the output queue becomes full, a query error is generated and the output queue is cleared. Therefore, clearing the output queue and query error output from the deadlocked condition^{*3} as defined in IEEE 488.2 is not supported.

*1. ANSI/IEEE Standard 488.1-1987, IEEE Standard Digital Interface for Programmable Instrumentation.

*2. ANSI/IEEE Standard 488.2-1987, IEEE Standard Codes, Formats, Protocols, and Common Commands.

*3. The situation in which the input buffer and the output queue become full, so that processing cannot continue.

8.2 Specifications

RS-232C Specifications

RS-232C

| | |
|-----------------------------------|---|
| Transfer method | Communications : Full duplex Synchronization : Start-stop synchronization |
| Baud rate | 9600 bps/ 19200 bps/ 38400 bps |
| Data length | 8 bit |
| Parity | none |
| Stop bit | 1 bit |
| Message terminator (delimiter) | Receiving : CR+LF, CR Transmitting : CR+LF |
| Flow control | none |
| Electrical specification | Input voltage levels 5 to 15 V: ON, -15 to -5 V: OFF Output voltage levels 5 to 9 V: ON, -9 to -5 V: OFF |
| Connector | RS-232C Interface Connector Pinout (Male 9-pin D-sub, with #4-40 attachment screws) The I/O connector is a DTE (Data Terminal Equipment) configuration Recommended cables: <ul style="list-style-type: none"> • Model 9637 RS-232C CABLE (for PC/AT-compatibles) • Model 9638 RS-232C CABLE (for PC98-series) See " Attaching the Connector" (p.102). |

LAN Specifications

LAN

| | |
|---------------------------|--|
| Applicable standard | IEEE802.3 |
| Transmission method | 10BASE-T / 100BASE-TX automatic recognition Half/Full Duplex Auto MDI-X |
| Protocol | TCP/IP |
| Connector | RJ-45 |
| Cable length | Up to 30 m |
| Communication description | Setting and measured value acquisition by using communications commands |

GP-IB Specifications (Model BT3562-01 only)

GP-IB is available only on Model BT3562-01.



Interface Functions

| | |
|-----|--|
| SH1 | All Source Handshake functions are supported. |
| AH1 | All Acceptor Handshake functions are supported. |
| T6 | Basic talker functions are supported. Serial poll function are supported. No talk-only mode. The talker cancel function with MLA (My Listen Address) is supported. |
| L4 | Basic listener functions are supported. No listen-only mode. The listener cancel function with MTA (My Talk Address) is supported. |
| SR1 | All Service Request functions are supported. |
| RL1 | All Remote/Local functions are supported. |
| PP0 | No Parallel Poll function. |
| DC1 | All Device Clear functions are supported. |
| DT1 | All Device Trigger functions are supported. |
| C0 | No Controller functions are supported. |

Operating Code: ASCII codes

8.3 Selecting the Connections and Protocol

Attaching the Connector



- Always turn both devices OFF when connecting and disconnecting an interface connector. Otherwise, an electric shock accident may occur.
- After connecting, always tighten the connector screws. The mounting screws must be firmly tightened or the RS-232C connector may not perform to specifications, or may even fail.
- To avoid damage to the instrument, do not short-circuit the connector and do not input voltage to the connector.



RS-232C Connector

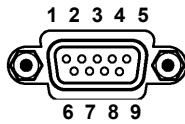

Male 9-pin D-sub
#4-40 attaching screws

Connect the RS-232C cable.

To connect the instrument to a controller (DTE), use a crossover cable compatible with the connectors on both the instrument and the controller.

The I/O connector is a DTE (Data Terminal Equipment) configuration. This instrument uses only pins 2, 3 and 5. The other pins are unconnected.

| Pin No. | Signal Name | | | Signal | Notes |
|---------|-------------|-----|-----|---------------------|------------------------------|
| | Common | EIA | JIS | | |
| 1 | DCD | CF | CD | Unused | No connection |
| 2 | RxD | BB | RD | Receive Data | |
| 3 | TxD | BA | SD | Transmit Data | |
| 4 | DTR | CD | ER | Data Terminal Ready | Internally connected to +5 V |
| 5 | GND | AB | SG | Signal Ground | |
| 6 | DSR | CC | DR | Unused | No connection |
| 7 | RTS | CA | RS | Request to Send | Internally connected to +5 V |
| 8 | CTS | CB | CS | Unused | No connection |
| 9 | RI | CE | CI | Unused | No connection |

RS-232C

Connecting to a PC/
AT-Compatible (DOS/
V) Machine

Use a **crossover cable** with **female 9-pin D-sub** connectors.

Crossover Wiring

Female 9-pin
D-sub
Model BT3562(-01),
BT3563(-01) end

Female 9-pin
D-sub
PC/AT-end

Recommended cable:

HIOKI
Model 9637 RS-232C
CABLE (1.8 m)

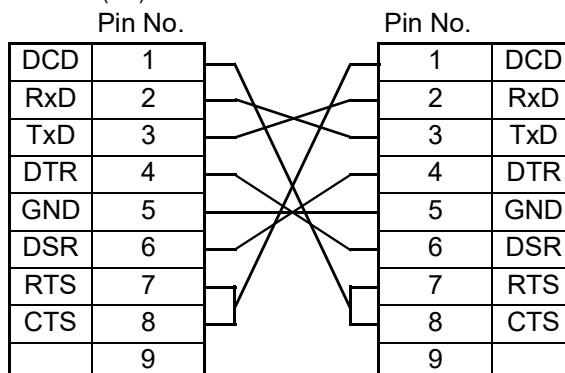

Connecting to an NEC
PC9801 or PC9821
Series Desktop PC
(excluding NX)

Use a **crossover cable** with a **female 9-pin D-sub** and a **male 25-pin D-sub** connector.

As the figure shows, RTS and CTS pins are shorted together and crossed to DCD in the other connector.

Crossover Wiring

Female 9-pin
D-sub
Model BT3562(-01),
BT3563(-01) end

Male 25-pin
D-sub
PC-end

Recommended cable:

HIOKI
Model 9638 RS-232C
CABLE (1.8 m)

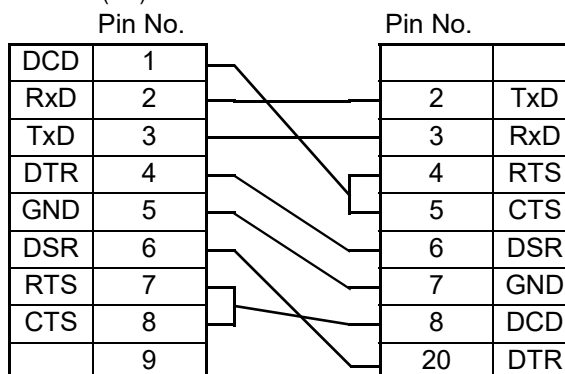

Note that the combination of a dual male 25-pin D-sub cable and a 9- to 25-pin adapter cannot be used.

LAN

Thoroughly read "Handling the Test Leads and Cables" (p.8) beforehand.
Connect a LAN cable to the LAN connector of the device.

! CAUTION

When connecting the device to your LAN with a LAN cable laid outdoors, take appropriate countermeasures that include installing a surge protector for LANs. Such signal wiring is susceptible to induced lightning, which can cause damage to the device.

Recommended cable: Model 9642 LAN cable (optional), 100BASE-TX or 10BASE-T compatible LAN cable (up to 30 m, straight cable and cross cable can be used)

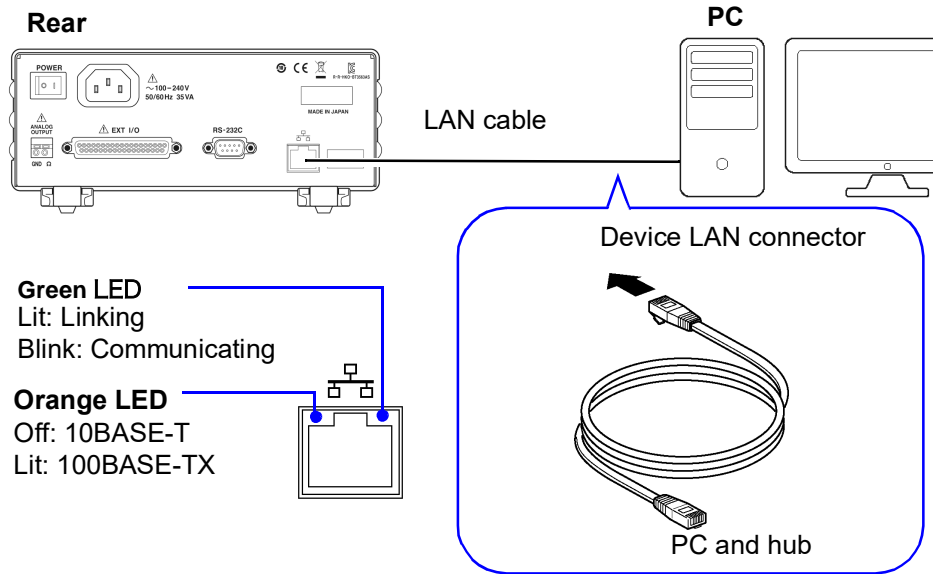

If the green LED on the LAN connector is not lit even after the device has been connected to the LAN, the device or connection device may be malfunctioning or the LAN cable may have a broken wire.

GP-IB

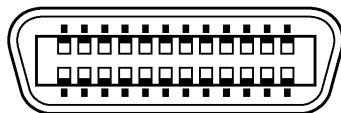

GP-IB Connector



Connecting a GP-IB cable.

Recommended cable:
Model 9151-02 GP-IB Connector Cable (2 m)

Selecting the Interface

- 1**  (The SHIFT indicator lights up.)
 The Menu display appears.

- 2**  Select the Interface Selection display.
 See "1.4 Menu Display Sequence (SHIFT → ENTER)" (p.16).

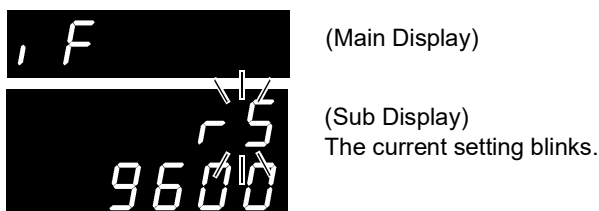

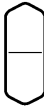
- 3**  Select RS-232C, LAN, or GP-IB on the Sub Display.
rS..... RS-232C
LAN LAN (Model BT3561A, BT3562A, BT3563A only)
GP-ib..... GP-IB (Model BT3562-01, BT3563-01 only)
Prn..... Printer

When you select RS-232C, set the communications speed.



When you select LAN, set the IP address etc. on the Web browser. On the instrument, you can initialize the settings by selecting the **SEt** item.
 See "Setting LAN communications" (p.106)

Default value

| | |
|-------------|----------------|
| IP address | 192.168.1.1 |
| Subnet mask | 255.255.0.0 |
| Gateway | None (0.0.0.0) |
| Port number | 23 |



When you select **GP-IB**, set the Address and Message Terminator.

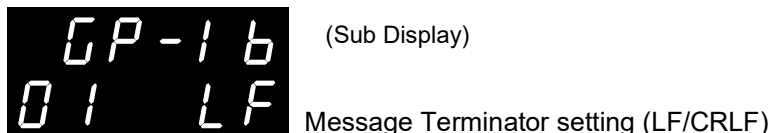

Address setting (0 to 30)

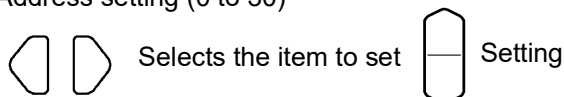

- 4**  Applies settings and returns to the Measurement display.

Setting LAN communications

To be checked before setting

The settings are different when the device and external device are connected to the existing network and when the device and a PC are connected to a new network.

Connecting the device to the existing network

The network administrator (department) needs to assign the following items in advance. Be sure to assign them so that they do not overlap with other devices.

- Address settings of the device
IP address::.....:.....:.....
Subnet mask::.....:.....:.....
- Gateway
Whether or not to use a gateway: Use / Not use
IP address (if used)::.....:.....:.....
..... (Set to 0.0.0.0 if not used)
Communication command port No. to be used: ____ (Default setting: 23)

Creating a new network using the device and a PC

(Using a local network that is not connected externally)

The addresses shown below are recommended if there is no administrator or you are responsible for setting.

| | |
|--|---|
| IP address | Set sequential IP addresses as shown below. |
| PC: | 192.168.1.100 |
| First device: | 192.168.1.1 |
| Second device: | 192.168.1.2 |
| Third device: | 192.168.1.3 |
| | ↓ |
| Subnet mask: | 255.255.0.0 |
| Gateway: | OFF |
| Communication command port number: | .23 |

1 Start a web browser.

You can change the instrument's LAN interface settings using a web browser, such as Microsoft Edge®.

The description below uses Microsoft Edge® as an example.

- (1) Click the start button on the bottom-left corner of the computer screen, and then click **[Microsoft Edge]** in the menu.
- (2) Enter the character string **[http://]** followed by the IP address or the computer name in the address bar

When the IP address of the instrument is "192.168.1.1"

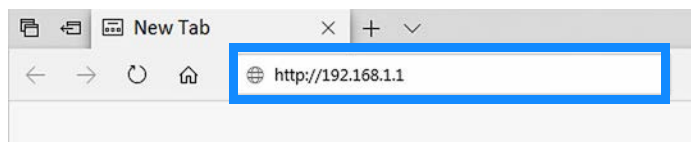

- 2** **Configure settings of the instrument using the web browser**
Enter the settings, and then press the **[SET]** button.

HIOKI Network Setting

IP Address :

Subnet Mask :

Gateway (Off=0.0.0.0) :

Port Number[11-79 or 81-65535] :

Setting items

| | |
|-------------|---|
| IP Address | The IP addresses are used to identify individual devices on the network. Assign a unique address different from that of other devices. |
| Subnet Mask | The subnet mask divides the IP address into the network address and the host address. Configure the subnet mask settings in the same way as those of other devices on the network. |
| Gateway | For network connection When the communication PC and the device are in different networks, specify the IP address of the device that becomes a gateway. If the PC is in the same network, set a gateway address that is the same as the default gateway in the general PC settings. For one-to-one connection between the device and PC or when no gateway is used Set the IP address to 0.0.0.0 . |
| Port Number | Specify the TCP/IP port number to use for communications command connections. |

8.4 Communication Methods

Various messages are supported for controlling the instrument through the interfaces.

Messages can be either program messages, sent from the PC to the instrument, or response messages, sent from the instrument to the PC.

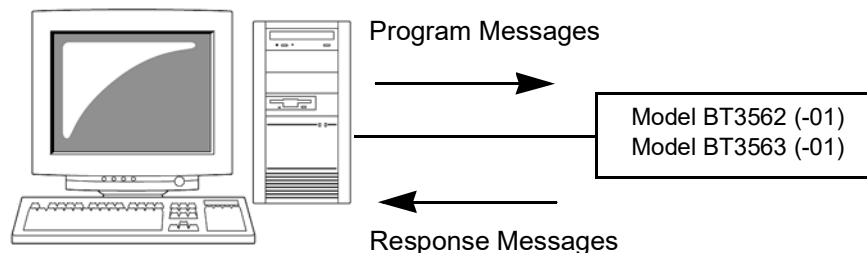

Message types are further categorized as follows:

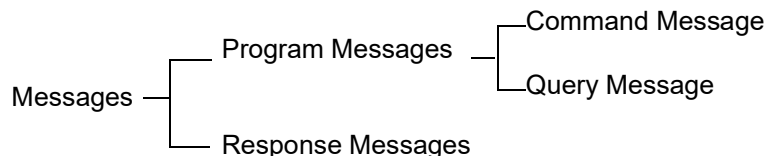

Message Format

Program Messages

Program messages can be either Command Messages or Query Messages.

- **Command Messages**
Instructions to control the instrument, such as to change settings or reset

Example: (instruction to set the measurement range)

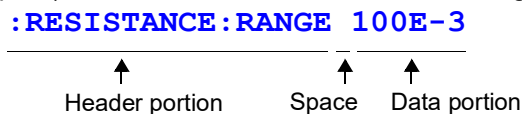

- **Query Messages**
Requests for responses relating to results of operation or measurement, or the state of instrument settings.

Example: (request for the current measurement range)

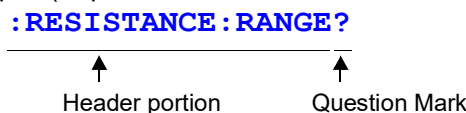

See For details: See Section " Headers" (p.109), " Separators" (p.110) and " Data Formats" (p.111).

Response Messages

When a query message is received, its syntax is checked and a response message is generated.

The **:SYSTEM:HEADER** command determines whether headers are prefixed to response messages.

Header ON **:RESISTANCE:RANGE 300.00E-3**

Header OFF **300.00E-3**

(the current resistance measurement range is 300 mΩ)

At power-on, Header OFF is selected.

If an error occurs when a query message is received, no response message is generated for that query.

No header is applied to commands used only for queries, such as **:FETCh?**, **:MEASure** and **:CALCulate:LIMit:RESistance:RESult?**.

Command Syntax

Command names are chosen to mnemonically represent their function, and can be abbreviated. The full command name is called the "long form", and the abbreviated name is called the "short form".

The command references in this manual indicate the short form in upper-case letters, extended to the long form in lower case letters, although the commands are not case-sensitive in actual usage.

Response messages generated by the instrument are in long form and in upper

FUNCTION OK (long form)

FUNC OK (short form)

FUNCT Error

FUN Error

case letters.

Headers

Headers must always be prefixed to program messages.

(1) Command Program Headers

There are three types of commands: Simple, Compound and Standard.

- Headers for Simple Commands

This header type is a sequence of letters and digits

***ESE 0**

- Headers for Compound Commands

These headers consist of multiple simple command type headers separated by colons ":"

:SAMPLE:RATE

- Headers for Standard Commands

This header type begins with an asterisk "*", indicating that it is a standard command defined by IEEE 488.2.

***RST**

(2) Query Program Header

These commands are used to interrogate the instrument about the results of operations, measured values and the current states of instrument settings.

As shown by the following examples, a query is formed by appending a question mark "?" after a program header.

:FETCh?

:MEASure:RESistance?

Message Terminators

This instrument recognizes the following message terminators:

GP-IB

- LF
- CR+LF
- EOI
- LF with EOI

LAN

- CR
- CR+LF

RS-232C

- CR
- CR+LF

From the instrument's interface settings, the following can be selected as the terminator for response messages.

GP-IB

- LF with EOI
(initial setting)
- LF with CR and EOI

LAN

- CR + LF

RS-232C

- CR + LF

See " Selecting the Interface" (p.105).

Separators

(1) Message Unit Separator

Multiple message can be written in one line by separating them with semicolons ";".

```
: SYSTEM: LFREQUENCY 60;*IDN?
```

- When messages are combined in this way and if one command contains an error, all subsequent messages up to the next terminator will be ignored.
- A query error occurs if a query command is combined with an immediately following semicolon and subsequent command.

(2) Header Separator

In a message consisting of both a header and data, the header is separated from the data by a space " ".

```
: SYSTEM: ELOCK ON
```

(3) Data Separator

In a message containing multiple data items, commas are required to separate the data items from one another.

Data Formats

The instrument uses character data and decimal numeric data, depending on the command.

(1) Character Data

Character data always begins with an alphabetic character, and subsequent characters may be either alphabetic or numeric. Character data is not case-sensitive, although response messages from the instrument are only upper case. As with command syntax, both long and short forms are acceptable.

```
:SYSTEM:ELOCK ON
```

(2) Decimal Numeric Data

Three formats are used for numeric data, identified as NR1, NR2 and NR3. Numeric values may be signed or unsigned. Unsigned numeric values are handled as positive values.

Values exceeding the precision handled by the instrument are rounded to the nearest valid digit.

- NR1 Integer data (e.g.: +12, -23, 34)
- NR2 Fixed-point data(e.g.: +1.23, -23.45, 3.456)
- NR3 Floating-point exponential representation data (e.g.: +1.0E-2, -2.3E+4)

The term "NRf format" includes all three of the above numeric decimal formats. The instrument accepts NRf format data.

The format of response data is specified for each command, and the data is sent in that format.

```
:ESR0 106  
:FETCH? +106.57E-3
```



The instrument does not fully support IEEE 488.2. As much as possible, please use the data formats shown in the Reference section.

Also, be careful to avoid constructing single commands that could overflow the input buffer or output queue.

Compound Command Header Omission

When several commands having a common header are combined to form a compound command (e.g., `:CALCulate: LIMit:RESistance:UPPer:` and `:CALCulate: LIMit:RESistance:LOWer`), if they are written together in sequence, the common portion (here, `:CALCulate: LIMit:RESistance`) can be omitted after its initial occurrence. This common portion is called the "current path" (analogous to the path concept in computer file storage), and until it is cleared, the interpretation of subsequent commands presumes that they share the same common portion.

This usage of the current path is shown in the following example:

Full expression

```
:CALCulate: LIMit:RESistance:UPPer 30000; :CALCulate: LIMit:LOWer 29000
```

Compacted expression

```
:CALCulate: LIMit:RESistance:UPPer 30000; LOWer 29000
```

↑
This portion becomes the current path, and can be omitted from the messages immediately following.

The current path is cleared when the power is turned on, when reset by key input, by a colon ":" at the start of a command, and when a message terminator is detected.

Standard command messages can be executed regardless of the current path. They have no effect upon the current path.

A colon ":" is not required at the start of the header of a Simple or Compound command. However, to avoid confusion with abbreviated forms and operating mistakes, we recommend always placing a colon at the start of a header.

Output Queue and Input Buffer

Output Queue

Response messages are stored in the output queue until read by the controller. The output queue is also cleared in the following circumstances:

- Power on
- Device clear
- Query Error

The output queue capacity of the instrument is 64 bytes. If response messages overflow the buffer, a query error is generated and the output queue is cleared. Also, with GP-IB, if a new message is received while data remains in the output queue, the output queue is cleared and a query error is generated.

Input Buffer

The input buffer capacity of the instrument is 256 bytes. If 256 bytes are allowed to accumulate in this buffer so that it becomes full, the GP-IB interface bus enters the waiting state until space is cleared in the buffer. The RS-232C interface will not accept data beyond 256 bytes.

NOTE

Ensure that the no command ever exceeds 256 bytes.

Status Byte Register

This instrument implements the status model defined by IEEE 488.2 with regard to the serial poll function using the service request line.

The term "event" refers to any occurrence that generates a service request.

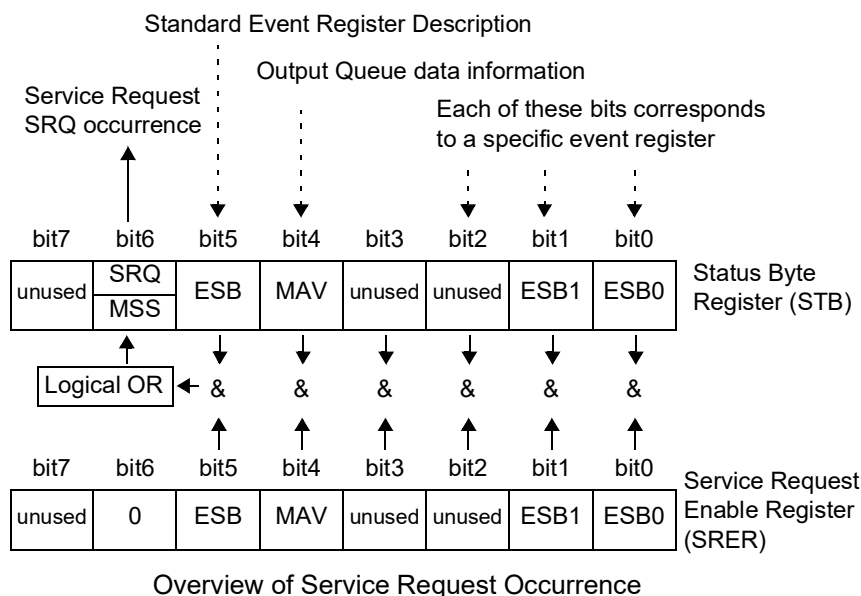

The Status Byte Register contains information about the event registers and the output queue. Required items are selected from this information by masking with the Service Request Enable Register. When any bit selected by the mask is set, bit 6 (MSS; the Master Summary Status) of the Status Byte Register is also set, which generates an SRQ (Service Request) message and dispatches a service request.

Status Byte Register (STB)

During serial polling, the contents of the 8-bit Status Byte Register are sent from the instrument to the controller.

When any Status Byte Register bit enabled by the Service Request Enable Register has switched from 0 to 1, the MSS bit becomes 1. Consequently, the SRQ bit is set to 1, and a service request is dispatched.

The SRQ bit is always synchronous with service requests, and is read and simultaneously cleared during serial polling. Although the MSS bit is only read by an ***STB?** query, it is not cleared until a clear event is initiated by the ***CLS** command.

| | |
|---------------------|--|
| Bit 7 | unused |
| Bit 6 SRQ MSS | Set to 1 when a service request is dispatched. This is the logical sum of the other bits of the Status Byte Register. |
| Bit 5 ESB | Standard Event Status (logical OR) bit This is logical sum of the Standard Event Status Register. |
| Bit 4 MAV | Message available Indicates that a message is present in the output queue. |
| Bit 3 | unused |
| Bit 2 | unused |
| Bit 1 ESB1 | Event Status (logical OR) bit 1 This is the logical sum of Event Status Register 1. |
| Bit 0 ESB0 | Event Status (logical OR) bit 0 This is the logical sum of Event Status Register 0. |

Service Request Enable Register (SRER)

This register masks the Status Byte Register. Setting a bit of this register to 1 enables the corresponding bit of the Status Byte Register to be used.

Event Registers

Standard Event Status Register (SESR)

The Standard Event Status Register is an 8-bit register.

If any bit in the Standard Event Status Register is set to 1 (after masking by the Standard Event Status Enable Register), bit 5 (ESB) of the Status Byte Register is set to 1.

The Standard Event Status Register is cleared in the following situations:

- When a ***CLS** command is executed
- When an event register query (***ESR?**) is executed
- When the instrument is powered on

| | | |
|-------|-----|---|
| Bit 7 | PON | Power-On Flag Set to 1 when the power is turned on, or upon recovery from an outage. |
| Bit 6 | | User Request unused |
| Bit 5 | CME | Command Error (The command to the message terminator is ignored.) This bit is set to 1 when a received command contains a syntactic or semantic error: <ul style="list-style-type: none"> • Program header error • Incorrect number of data parameters • Invalid parameter format • Received a command not supported by the instrument |
| Bit 4 | EXE | Execution Error This bit is set to 1 when a received command cannot be executed for some reason. <ul style="list-style-type: none"> • The specified data value is outside of the set range • The specified setting data cannot be set • Execution is prevented by some other operation being performed |
| Bit 3 | DDE | Device-Dependent Error This bit is set to 1 when a command cannot be executed due to some reason other than a command error, a query error or an execution error. <ul style="list-style-type: none"> • Execution is impossible due to an internal instrument fault |
| Bit 2 | QYE | Query Error (the output queue is cleared) This bit is set to 1 when a query error is detected by the output queue control. <ul style="list-style-type: none"> • When an attempt has been made to read an empty output queue (GP-IB only) • When the data overflows the output queue • When data in the output queue has been lost |
| Bit 1 | | unused |
| Bit 0 | OPC | Operation Complete (GP-IB only) <ul style="list-style-type: none"> • This bit is set to 1 in response to an *OPC command. • It indicates the completion of operations of all messages up to the *OPC command |

Standard Event Status Enable Register (SESER)

Setting any bit of the Standard Event Status Enable Register to 1 enables access to the corresponding bit of the Standard Event Status Register.

Standard Event Status Register (SESR) and Standard Event Status Enable Register (SESER)

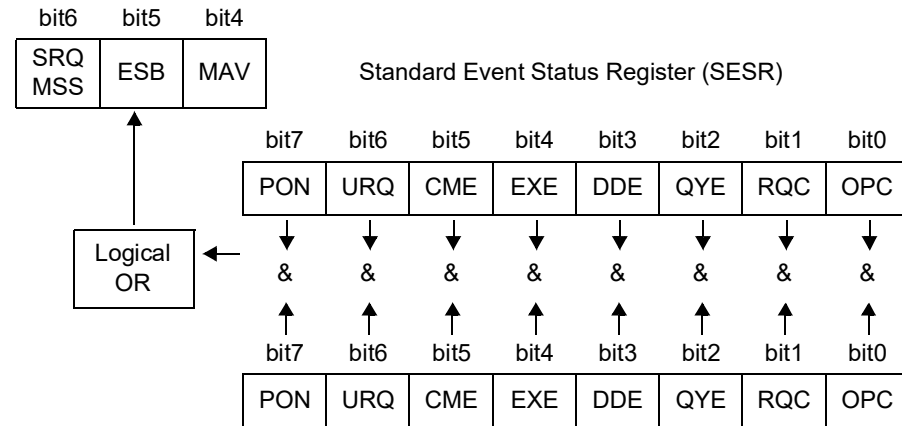

Standard Event Status Enable Register (SESER)

Device-Specific Event Status Registers (ESR0 and ESR1)

This instrument provides two event status registers for controlling events. Each event register is an 8-bit register.

When any bit in one of these event status registers enabled by its corresponding event status enable register is set to 1, the following happens:

- For Event Status Register 0, bit 0 (ESB0) of the Status Byte Register is set to 1.
- For Event Status Register 1, bit 1 (ESB1) of the Status Byte Register is set to 1.

Event Status Registers 0 and 1 are cleared in the following situations:

- When a ***CLS** command is executed
- When an Event Status Register query (**:ESR0?** or **:ESR1?**) is executed
- When the instrument is powered on

| | Event Status Register 0 (ESR0) | | Event Status Register 1 (ESR1) | |
|-------|--------------------------------|--------------------|--------------------------------|-----------------------------------|
| Bit 7 | -- | Unused | -- | unused |
| Bit 6 | -- | Unused | AND | AND |
| Bit 5 | ERR | Measurement Faults | V-Hi | Voltage High Comparator Result |
| Bit 4 | -- | Unused | V-IN | Voltage IN Comparator Result |
| Bit 3 | -- | Unused | V-Lo | Voltage Low Comparator Result |
| Bit 2 | -- | Unused | R-Hi | Resistance High Comparator Result |
| Bit 1 | INDEX | End of Measurement | R-IN | Resistance IN Comparator Result |
| Bit 0 | EOM | End of Conversion | R-Lo | Resistance Low Comparator Result |

Event Status Registers 0 (ESR0) and 1 (ESR1), and Event Status Enable Registers 0 (ESER0) and 1 (ESER1)

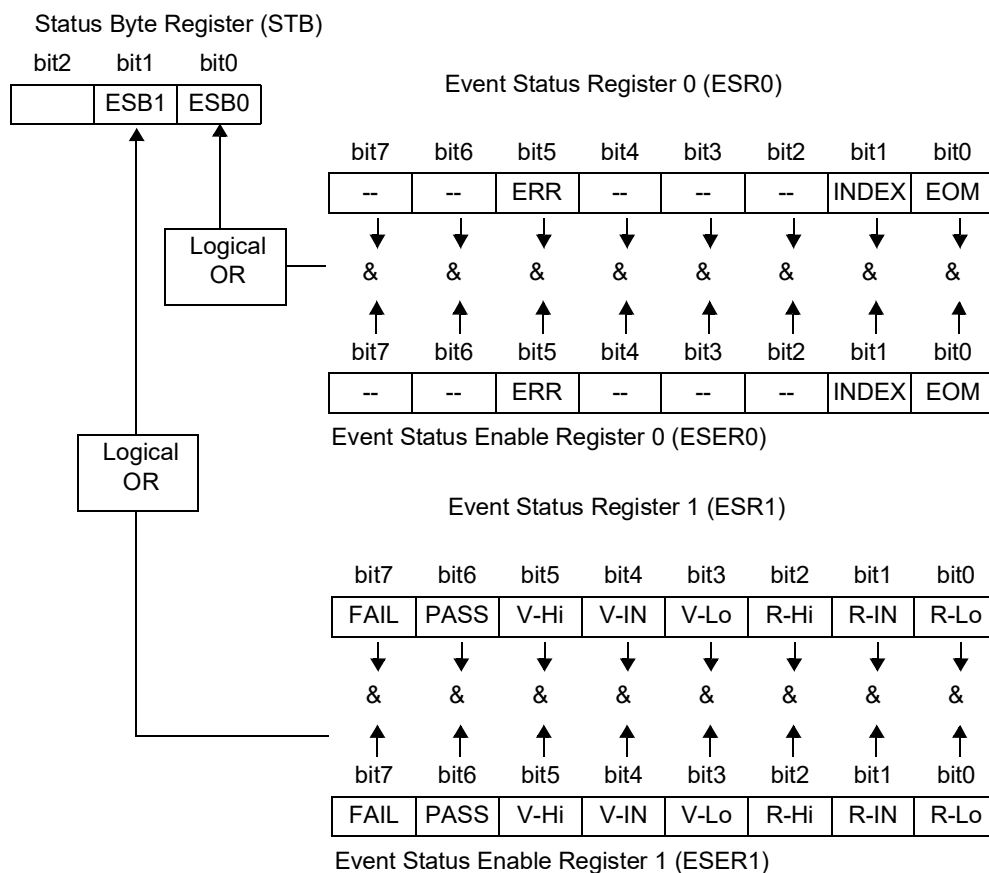

Register Reading and Writing

| Register | Read | Write |
|---------------------------------------|--------|-------|
| Status Byte Register | *STB? | -- |
| Service Request Enable Register | *SRE? | *SRE |
| Standard Event Status Register | *ESR? | -- |
| Standard Event Status Enable Register | *ESE? | *ESE |
| Event Status Register 0 | :ESR0? | -- |
| Event Status Enable Register 0 | :ESE0? | :ESE0 |
| Event Status Register 1 | :ESR1? | -- |
| Event Status Enable Register 1 | :ESE1? | :ESE1 |

GP-IB Commands

The following commands can be used for performing interface functions.

| Command | Description |
|---------|---|
| GTL | Go To Local Cancels the Remote state and enters the Local state. |
| LLO | Local Lock Out Disables all keys, including the LOCAL key. |
| DCL | Device Clear Clears the input buffer and the output queue. |
| SDC | Selected Device Clear Clears the input buffer and the output queue. |
| GET | Group Execute Trigger When an external trigger occurs, processes one sample. |

Initialization Items

✓ : initialized, – : not initialized

| Item | Initialization Method | At Power-on | *RST Command | Device Clear | *CLS Command |
|---|-----------------------|-------------|--------------|--------------|--------------|
| Device-specific functions (Range, etc.) | | – | ✓ | – | – |
| Output Queue | | ✓ | – | ✓ | – |
| Input buffer | | ✓ | – | ✓ | – |
| Status Byte Register | | ✓ | – | –*1 | ✓*2 |
| Event registers | | ✓*3 | – | – | ✓ |
| Enable register | | ✓ | – | – | – |
| Current path | | ✓ | – | ✓ | – |
| Headers on/off | | ✓ | ✓ | – | – |

*1: Only the MAV bit (bit 4) is cleared.

*2: All bits except the MAV bit are cleared.

*3: Except the PON bit (bit 7).

Local Function

During communications, **REMOTE** is lit to indicate the remote control state.

To cancel the Remote state

LOCAL **REMOTE** off

NOTE

- Remote control can be canceled by pressing the **SHIFT** key and then the **AUTO** key.
- If the Local Lock Out (p.109) GP-IB command has been issued, the Remote state cannot be canceled.

8.5 Message List

This chapter describes the GP-IB, LAN, and RS-232C interfaces, using the following symbols to indicate which information pertains to each interface.

Descriptions with no mark can be applied to the three of them.

GP-IB : GP-IB only

LAN : LAN only

RS-232C : RS-232C only

NOTE

- Any spelling mistake in a message results in a command error.
- < > = contents of the data portion.
[Numeric data values are indicated by format as (NR1), (NR2) and (NR3), representing integer, fixed-point and floating point decimal data values respectively, or as (NRf), representing any of these formats]
- []: optional

Standard Commands

| Command | Data Formats (Response data if a Query) | Description | Error | Ref page |
|---------|---|--|-------|----------|
| *IDN? | <Manufacturer's name>, <Model name>,0, <Software version> | Queries the device ID | *2 | 127 |
| *RST | | Initializes the device | *1 | 127 |
| *TST? | 0 to 3 (NR1) | Initiates a self-test and queries the result | *2 | 127 |
| *OPC | | Requests an SRQ after execution completion | *1 | 128 |
| *OPC? | 1 | Queries execution completion | *2 | 128 |
| *WAI | | Waits for operations to finish | *1 | 128 |
| *CLS | | Clears the Event Registers and the Status Byte Register | *1 | 128 |
| *ESE | 0 to 255 (NR1) | Sets the contents of the Standard Event Status Enable Register | *3 | 129 |
| *ESE? | 0 to 255 (NR1) | Queries the Standard Event Status Enable Register | *2 | 129 |
| *ESR? | 0 to 255 (NR1) | Queries and clear the Standard Event Status Register | *2 | 129 |
| *SRE | 0 to 255 (NR1) | Sets the Service Request Enable Register | *3 | 130 |

Error description (an error occurs when executing messages in the following cases):

- *1 Command Error..... When data is present after the command
- *2 Query Error When the response message exceeds 64 bytes
- *3 Execution Error When invalid character or numeric data is present

8.5 Message List

| Command | Data Formats (Response data if a Query) | Description | Error | Ref page |
|---------|---|---|-------|----------|
| *SRE? | 0 to 255 (NR1) | Queries the contents of the Service Request Enable Register | *2 | 130 |
| *STB? | 0 to 255 (NR1) | Queries the Status Byte Register | *2 | 130 |
| *TRG | | Requests a sampling | *1 | 130 |

Error description (an error occurs when executing messages in the following cases):

- *1 Command ErrorWhen data is present after the command
 - *2 Query Error.....When the response message exceeds 64 bytes
 - *3 Execution Error.....When invalid character or numeric data is present
-

Device-Specific Commands

| Message ([] = optional) | Data Contents () = response data | Description | Ref page |
|---------------------------|--------------------------------------|--|-------------|
| Event Registers | | | |
| :ESE0 | 0 to 255 | Sets Event Status Enable Register 0 | 131 |
| :ESE0? | 0 to 255 | Queries Event Status Enable Register 0 | 131 |
| :ESR0? | 0 to 255 | Queries Event Status Register 0 | 131 |
| :ESE1 | 0 to 255 | Sets Event Status Enable Register 1 | 131 |
| :ESE1? | 0 to 255 | Queries Event Status Enable Register 1 | 131 |
| :ESR1? | 0 to 255 | Queries Event Status Register 1 | 131 |
| Measurement Mode | | | |
| :FUNction | RV/ RESistance/VOLT- age | Sets measurement mode | 132 |
| :FUNction? | RV/ RESistance/VOLT- age | Queries measurement mode | 132 |
| Measurement Range | | | |
| :RESistance:RANGe | 0 to 3100 | Sets resistance measurement range | 132 |
| :RESistance:RANGe? | 3.000E-3 to 3.0000E+3 | Queries resistance measurement range | 132 |
| :VOLTage:RANGe | -300 to 300 | Sets voltage measurement range | 132 |
| :VOLTage:RANGe? | 6.00000E+0 to 300.000E+0 | Queries voltage measurement range | 132 |
| Auto Range | | | |
| :AUTorange | 1/ 0/ ON/ OFF | Sets the auto range | 133 |
| :AUTorange? | ON/ OFF | Queries the auto range setting | 133 |
| Zero-Adjust | | | |
| :ADJust:CLEAr | | Cancels zero-adjustment | 133 |
| :ADJust? | 0/ 1 | Executes zero-adjustment and queries the result | 133 |
| Sampling Rate | | | |
| :SAMPle:RATE | EXFast/ FAST/MEDI- um/ SLOW | Sets the sampling rate | 133 |
| :SAMPle:RATE? | EXFast/ FAST/MEDI- um/ SLOW | Queries the sampling rate setting | 133 |
| Averaging Function | | | |
| :CALCulate:AVERage:STATe | 1/ 0/ ON/ OFF | Sets averaging function execution | 134 |
| :CALCulate:AVERage:STATe? | ON/ OFF | Queries the averaging function execution setting | 134 |
| :CALCulate:AVERage | 2 to 16 | Sets the no. of samples to average | 134 |
| :CALCulate:AVERage? | 2 to 16 | Queries the no. of samples to average setting | 134 |
| Comparator | | | |
| :CALCulate:LIMit:STATe | 1/ 0/ ON/ OFF | Sets comparator execution | 134 |
| :CALCulate:LIMit:STATe? | ON/OFF | Queries the comparator execution setting | 134 |

| Message ([] = optional) | Data Contents () = response data | Description | Ref page |
|--|--------------------------------------|--|-------------|
| Comparator | | | |
| :CALCulate:LIMit:BEEPer | OFF/ HL/ IN/ BOTH1 / BOTH2 | Sets the comparator judgment beeper setting | 135 |
| :CALCulate:LIMit:BEEPer? | OFF/ HL/ IN/ BOTH1 / BOTH2 | Queries the comparator judgment beeper setting | 135 |
| :CALCulate:LIMit:RESistance:MODE | HL/ REF | Sets the resistance comparator execution mode setting | 135 |
| :CALCulate:LIMit:RESistance:MODE? | HL/ REF | Queries the resistance comparator execution mode setting | 135 |
| :CALCulate:LIMit:VOLTage:MODE | HL/ REF | Sets the voltage comparator execution mode setting | 135 |
| :CALCulate:LIMit:VOLTage:MODE? | HL/ REF | Queries the voltage comparator execution mode setting | 135 |
| :CALCulate:LIMit:RESistance:UPPer | <Upper threshold> | Sets the resistance comparator upper threshold setting | 136 |
| :CALCulate:LIMit:RESistance:UPPer? | <Upper threshold> | Queries the resistance comparator upper threshold setting | 136 |
| :CALCulate:LIMit:VOLTage:UPPer | <Upper threshold> | Sets the voltage comparator upper threshold setting | 136 |
| :CALCulate:LIMit:VOLTage:UPPer? | <Upper threshold> | Queries the voltage comparator upper threshold setting | 136 |
| :CALCulate:LIMit:RESistance:LOWer | <Lower threshold> | Sets the resistance comparator lower threshold setting | 137 |
| :CALCulate:LIMit:RESistance:LOWer? | <Lower threshold> | Queries the resistance comparator lower threshold setting | 137 |
| :CALCulate:LIMit:VOLTage:LOWer | <Lower threshold> | Sets the voltage comparator lower threshold setting | 137 |
| :CALCulate:LIMit:VOLTage:LOWer? | <Lower threshold> | Queries the voltage comparator lower threshold setting | 137 |
| :CALCulate:LIMit:RESistance:REFerence | <Reference value> | Sets the resistance comparator reference value | 138 |
| :CALCulate:LIMit:RESistance:REFerence? | <Reference value> | Queries the resistance comparator reference value | 138 |
| :CALCulate:LIMit:VOLTage:REFerence | <Reference value> | Sets the voltage comparator reference value | 138 |
| :CALCulate:LIMit:VOLTage:REFerence? | <Reference value> | Queries the voltage comparator reference value | 138 |
| :CALCulate:LIMit:RESistance:PERCent | <Tolerance (%)> | Sets the resistance comparator decision tolerance setting | 139 |
| :CALCulate:LIMit:RESistance:PERCent? | <Tolerance (%)> | Queries the resistance comparator decision tolerance setting | 139 |
| :CALCulate:LIMit:VOLTage:PERCent | <Tolerance (%)> | Sets the voltage comparator decision Tolerance setting | 139 |
| :CALCulate:LIMit:VOLTage:PERCent? | <Tolerance (%)> | Queries the voltage comparator decision tolerance setting | 139 |
| :CALCulate:LIMit:RESistance:RESult? | HI/ IN/ LO/ OFF/ ERR | Queries resistance comparator judgment results | 140 |
| :CALCulate:LIMit:VOLTage:RESult? | HI/ IN/ LO/ OFF/ ERR | Queries voltage comparator judgment results | 140 |
| :CALCulate:LIMit:ABS | 1/0/ON/OFF | Sets the comparator absolute value judgment function | 140 |
| :CALCulate:LIMit:ABS? | ON/OFF | Queries the comparator absolute value judgment function | 140 |

| Message ([] = optional) | Data Contents () = response data | Description | Ref page |
|---|--|--|-------------|
| Statistical Functions | | | |
| :CALCulate:STATistics:STATe | 1/ 0/ ON/ OFF | Sets statistical calculation function execution | 141 |
| :CALCulate:STATistics:STATe? | ON/ OFF | Queries the statistical calculation function execution setting | 141 |
| :CALCulate:STATistics:CLEAR | | Clears statistical calculation results | 141 |
| :CALCulate:STATistics:RESistance:NUMBer? | <Total data count>, <Valid data count> | Queries the resistance data count | 142 |
| :CALCulate:STATistics:VOLTage:NUMBer? | <Total data count>, <Valid data count> | Queries the voltage data count | 142 |
| :CALCulate:STATistics:RESistance:MEAN? | <Mean> | Queries the resistance mean value | 142 |
| :CALCulate:STATistics:VOLTage:MEAN? | <Mean> | Queries the voltage mean value | 142 |
| :CALCulate:STATistics:RESistance:MAXimum? | <Maximum value>, <Data No. of Maximum value> | Queries the resistance maximum value | 143 |
| :CALCulate:STATistics:VOLTage:MAXimum? | <Maximum value>, <Data No. of Maximum value> | Queries the voltage maximum value | 143 |
| :CALCulate:STATistics:RESistance:MINimum? | <Minimum value>, <Data No. of Maximum value> | Queries the resistance minimum value | 143 |
| :CALCulate:STATistics:VOLTage:MINimum? | <Minimum value>, <Data No. of Maximum value> | Queries the voltage minimum value | 143 |
| :CALCulate:STATistics:RESistance:LIMit? | <Hi count>, <IN count>, <Lo count>, <Measurement fault count > | Queries comparator results of resistance measurement | 144 |
| :CALCulate:STATistics:VOLTage:LIMit? | <Hi count>, <IN count>, <Lo count>, <Measurement fault count > | Queries comparator results of voltage measurement | 144 |
| :CALCulate:STATistics:RESistance:DEViation? | < σ_n >, < σ_{n-1} > | Queries standard deviation of resistance measurement | 144 |
| :CALCulate:STATistics:VOLTage:DEViation? | < σ_n >, < σ_{n-1} > | Queries standard deviation of voltage measurement | 144 |
| :CALCulate:STATistics:RESistance:CP? | <Cp>, <CpK> | Queries process capability indices of resistance measurement | 145 |
| :CALCulate:STATistics:VOLTage:CP? | <Cp>, <CpK> | Queries process capability indices of voltage measurement | 145 |
| Memory Function | | | |
| :MEMory:STATe | 1/ 0/ ON/ OFF | Sets the memory function state | 145 |
| :MEMory:STATe? | ON/ OFF | Queries the memory function state | 145 |
| :MEMory:CLEAR | | Clears instrument memory | 145 |
| :MEMory:COUNT? | 0 to 400 | Queries the memory data count | 146 |
| :MEMory:DATA? | [STEP] | Queries the memory data | 146 |
| Self-Calibration | | | |
| :SYSTem:CALibration | | Executes self-calibration | 147 |
| :SYSTem:CALibration:AUTO | 1/ 0/ ON/ OFF | Sets automatic self-calibration | 147 |

| Message ([] = optional) | Data Contents () = response data | Description | Ref page |
|--|--------------------------------------|---|-------------|
| :SYSTem:CALibration:AUTO? | ON/ OFF | Queries the automatic self-calibration setting | 147 |
| Trigger Input Measured Value Output | | | |
| :SYSTem:DATAout | 1/ 0/ ON/ OFF | Sets measurement value output upon triggering | 147 |
| :SYSTem:DATAout? | ON/ OFF | Queries measurement value output upon triggering | 147 |
| Key Beeper | | | |
| :SYSTem:BEEPer:STATe | 1/ 0/ ON/ OFF | Sets the key beeper | 148 |
| :SYSTem:BEEPer:STATe? | ON/ OFF | Queries the key beeper setting | 148 |
| Line Frequency | | | |
| :SYSTem:LFRequency | AUTO/50/ 60 | Selects the AC line frequency | 148 |
| :SYSTem:LFRequency? | AUTO/50/ 60 | Queries the AC line frequency selection | 148 |
| Key-Lock | | | |
| :SYSTem:KLOCK | 1/ 0/ ON/ OFF | Sets the key-lock | 148 |
| :SYSTem:KLOCK? | ON/ OFF | Queries the key-lock setting | 148 |
| EXT I/O Output | | | |
| :SYSTem:ELOCK | 1/ 0/ ON/ OFF | Sets the external input terminal lock | 149 |
| :SYSTem:ELOCK? | ON/ OFF | Queries the external input terminal lock on/off setting | 149 |
| Local | | | |
| :SYSTem:LOCAl | | Sets local control | 149 |
| Saving and Loading Measurement Setting States | | | |
| :SYSTem:SAVE | <Table No.> | Saves the measurement setting state | 149 |
| :SYSTem:LOAD | <Table No.> | Loads a measurement setting state | 149 |
| :SYSTem:BACKup | | Backups current measurement configuration | 149 |
| Header Present | | | |
| :SYSTem:HEADer | 1/ 0/ ON/ OFF | Sets header present | 150 |
| :SYSTem:HEADer? | ON/ OFF | Queries the header present setting | 150 |
| ERR Output | | | |
| :SYSTem:ERRor | SYNChronous/ ASYNchronous | Sets error output timing | 150 |
| :SYSTem:ERRor? | SYNCHRONOUS/ ASYNCHRONOUS | Queries the error output timing setting | 150 |
| EOM Output | | | |
| :SYSTem:EOM:MODE | <HOLD/PULSE> | Selects the EOM output mode | 151 |
| :SYSTem:EOM:MODE? | (<HOLD/PULSE>) | Queries the EOM output mode setting | 151 |

| Message ([] = optional) | Data Contents () = response data | Description | Ref page |
|--|---|---|-------------|
| :SYSTem:EOM:PULSe | <HOLD/PULSe> | Selects the EOM pulse width | 151 |
| :SYSTem:EOM:PULSe? | (0.001 to 0.099) | Queries the EOM pulse width setting | 151 |
| Measurement current pulse output function setting | | | |
| :SYSTem:CURRent | CONTInuous/PULSe | Sets the measurement current pulse output function | 151 |
| :SYSTem:CURRent? | CONTINUOUS/PULSE | Queries the measurement current pulse output function | 151 |
| Terminator | | | |
| :SYSTem:TERMinator | 0/ 1 | Sets the terminator | 150 |
| :SYSTem:TERMinator? | 0/ 1 | Queries the terminator | 150 |
| System Reset | | | |
| :SYSTem:RESet | | Executes a system reset, including saved measurement setting state data | 151 |
| EXT I/O | | | |
| :IO:OUT | 0 to 1023 | EXT I/O output | 152 |
| :IO:IN? | 0 to 31 | EXT I/O input | 152 |
| Trigger | | | |
| :INITiate:CONTInuous | 1/ 0/ ON/ OFF | Sets continuous measurement | 155 |
| :INITiate:CONTInuous? | ON/ OFF | Queries the continuous measurement setting | 155 |
| :INITiate[:IMMediate] | | Trigger wait setting | 155 |
| Trigger Source Setting | | | |
| :TRIGger:SOURce | IMMediate/ EXTernal | Sets the trigger source | 156 |
| :TRIGger:SOURce? | IMMEDIATE/EXTERNAL | Queries the trigger source setting | 156 |
| :TRIGger:DELay:STATe | 1/ 0/ ON/ OFF | Sets the trigger delay | 156 |
| :TRIGger:DELay:STATe? | ON/ OFF | Queries the trigger delay setting | 156 |
| :TRIGger:DELay | <Delay time> | Sets trigger delay time | 157 |
| :TRIGger:DELay? | 0 to 9.999 | Queries the trigger delay time | 157 |
| Reading Measured Values | | | |
| :FETCh? | <Resistance measured value>, <Voltage measured value> ΩV mode <Resistance measured value> Ω mode <Voltage measured value> V mode | Reads the most recent measurement | 157 |
| :READ? | <Resistance measured value>, <Voltage measured value> ΩV mode <Resistance measured value> Ω mode <Voltage measured value> V mode | Executes a measurement and read the measured values | 158 |

8.6 Message Reference

< >: Indicates the contents (character or numeric parameters) of the data portion of a message.
 Character parameters are returned as all capital letters.

Numeric Parameters:

- NRf Number format may be any of NR1, NR2 and NR3
- NR1 Integer data (e.g.: +12, -23, 34)
- NR2 Fixed-point data(e.g.: +1.23, -23.45, 3.456)
- NR3 Floating-point exponential representation data (e.g.: +1.0E-2, -2.3E+4)

Shows the command description. —>
 Shows the message syntax. —>
 Explains the command data or response message.

Describes the message. —>

Shows an example of an actual command application. (Normally described with HEADER ON, (except the HEADER command itself).) —>

Read/Write the Standard Event Status Enable Register (SESER)

Syntax Command ***ESE <0 to 255 (NR1)>**
 Query ***ESE?**
 Response **<0 to 255 (NR1)>**

Description Command The SESER mask is set to the numerical value 0 to 255. The initial value (at power-on) is 0.
 Query The contents of the SESER, as set by the ***ESE** command, are returned as an NR1 value (0 to 255).

| | | | | | | | |
|-------|-------|-------|-------|-------|-------|-------|-------|
| 128 | 64 | 32 | 16 | 8 | 4 | 2 | 1 |
| bit 7 | bit 6 | bit 5 | bit 4 | bit 3 | bit 2 | bit 1 | bit 0 |
| PON | URQ | CME | EXE | DDE | QYE | RQC | OPC |

Example Command ***ESE 36**
 (Sets bits 5 and 2 of SESER)

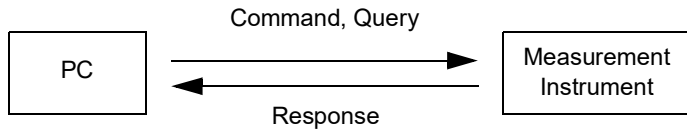

Standard Commands

Messages specific to the RS-232C, LAN, or GP-IB interface are identified by their corresponding symbols.

System Data Command

Queries device ID.

| | | |
|--------------------|---|--|
| Syntax | Query | *IDN? |
| | Response | <Manufacturer's name>,<Model name>,0,<Software version> <Model name>=BT3561A/ BT3562A/ BT3562/ BT3562-01/ BT3563A/ BT3563 /BT3563-01 |
| Description | Query | Queries the device manufacturer's name, model name and software version. |
| Example | Query | *IDN? |
| | Response | HIOKI ,BT3562 , 0 ,V1 . 00 The Device ID is HIOKI BT3562, 0, software version 1.00. |
| Note | <ul style="list-style-type: none"> The response message has no header. | |

Internal Operation Command

Initialize Device

| | | |
|--------------------|--|--|
| Syntax | Command | *RST |
| Description | Command | Resets instrument settings (other than saved data) to factory defaults. Operation returns to the initial display after initialization. |
| Note | <ul style="list-style-type: none"> The communications state is not initialized. To initialize saved data as well, send the :SYSTEM:RESet command. | |

Execute Self-Test and Query the Result

| | | |
|--------------------|----------|---|
| Syntax | Query | *TST? |
| | Response | <0 to 3> 0..... No Errors 1..... RAM Error 2..... EEPROM Error 3..... RAM and EEPROM Errors |
| Description | Query | Perform instrument self-test and return the result as numerical value 0 to 3. |
| Example | Query | *TST? |
| | Response | 1 A RAM Error occurred. |

Synchronization Commands

Set the OPC bit of SESR When Finished All Pending Operations

| | | |
|--------------------|---------|---|
| Syntax | Command | *OPC |
| Description | Command | Sets OPC bit 0 of the Standard Event Status Register (SESR) when all prior commands have finished processing. |
| Example | Command | A;B;*OPC;C The OPC bit of the SESR is set after commands A and B have finished processing. |

Respond "1" When Finished All Pending Operations



| | | |
|--------------------|----------|--|
| Syntax | Query | *OPC? |
| | Response | 1 |
| Description | Query | Responds "1" when all prior commands have finished processing. |

Wait for Pending Commands to Finish

| | | |
|--------------------|---------|--|
| Syntax | Command | *WAI |
| Description | Command | The instrument waits until all prior commands finish before executing any subsequent commands. |
| Note | | The *WAI command is supported because it is defined in IEEE 488.2-1987, but because all Model BT3562(BT3562-01) device-specific commands are sequential types, this command has no actual affect. |

Status and Event Control Commands

Clear the Status Byte and Related Queues (Except the Output Queue)

| | | |
|--------------------|---|---|
| Syntax | Command | *CLS |
| Description | Command | Clears the event registers corresponding to each bit of the Status Byte Register. Also clears the Status Byte Register. |
| Note |  | The output queue is unaffected. |
| |  | The output queue is unaffected. |
| |  | The output queue, the various enable registers and MAV bit 4 of the Status Byte Register are unaffected. |

Set and Query the Standard Event Status Enable Register (SESER)

Syntax Command ***ESE** <0 to 255>

Query ***ESE?**

Response <0 to 255 (NR1)>

Description Command The SESER mask is set to the numerical value 0 to 255. The initial value (at power-on) is 0.

Query The contents of the SESER, as set by the ***ESE** command, are returned as an NR1 value (0 to 255).

| 128 bit 7 | 64 bit 6 | 32 bit 5 | 16 bit 4 | 8 bit 3 | 4 bit 2 | 2 bit 1 | 1 bit 0 |
|--------------|-------------|-------------|-------------|------------|------------|------------|------------|
| PON | URQ | CME | EXE | DDE | QYE | RQC | OPC |

Example Command ***ESE 36**
Sets bits 5 and 2 of SESER.

Query ***ESE?**

Response **36**
SESER has been set to bit 5 and bit 2.

Query and Clear the Standard Event Status Register (SESR)

Syntax Query ***ESR?**

Response <0 to 255 (NR1)>

Description Query Returns the contents of the SESR as an NR1 value from 0 to 255, then clears register contents. The response message has no header.

| RS-232C | | LAN | | | | | |
|--------------|-------------|-------------|-------------|------------|------------|------------|------------|
| 128 bit 7 | 64 bit 6 | 32 bit 5 | 16 bit 4 | 8 bit 3 | 4 bit 2 | 2 bit 1 | 1 bit 0 |
| PON | unused | CME | EXE | DDE | QYE | unused | unused |

| GP-IB | | | | | | | |
|--------------|-------------|-------------|-------------|------------|------------|------------|------------|
| 128 bit 7 | 64 bit 6 | 32 bit 5 | 16 bit 4 | 8 bit 3 | 4 bit 2 | 2 bit 1 | 1 bit 0 |
| PON | URQ | CME | EXE | DDE | QYE | RQC | OPC |

Example Query ***ESR?**

Response **32**
Bit 5 of the SESR was set to 1.

Set and Query the Service Request Enable Register (SRER)

- Syntax** Command ***SRE** <0 to 255>
- Query ***SRE?**
- Response <0 to 255 (NR1)>
- Description** Command The SRER mask is set to the numerical value 0 to 255. Although NRf numerical values are accepted, values to the right of the decimal are rounded to the nearest integer. Bit 6 and unused bits 2, 3 and 7 are ignored. The data is initialized to zero at power-on.
- Query The contents of the SRER, as set by the ***SRE** command, are returned as an NR1 value (0 to 255). Bit 6 and unused bits 2, 3 and 7 always return as zero.

| 128 bit 7 | 64 bit 6 | 32 bit 5 | 16 bit 4 | 8 bit 3 | 4 bit 2 | 2 bit 1 | 1 bit 0 |
|--------------|-------------|-------------|-------------|------------|------------|------------|------------|
| unused | 0 | ESB | MAV | unused | unused | ESE1 | ESE0 |

- Example** Command ***SRE 33**
Set SRER bits 0 and 5 to 1.
- Query ***SRE?**
- Response **33**
SRER bits 0 and 5 have been set to 1.

Query the Status Byte and MSS Bit

- Syntax** Query ***STB?**
- Response <0 to 255 (NR1)>
- Description** Query The contents of the STB are returned as an NR1 value (0 to 255). The response message has no header.

| 128 bit 7 | 64 bit 6 | 32 bit 5 | 16 bit 4 | 8 bit 3 | 4 bit 2 | 2 bit 1 | 1 bit 0 |
|--------------|-------------|-------------|-------------|------------|------------|------------|------------|
| unused | MSS | ESB | MAV | unused | unused | ESE1 | ESE0 |

- Example** Query ***STB?**
- Response **16**
STB bit 4 has been set to 1.

Request a Sample

- Syntax** Command ***TRG**
- Description** Command Performs one measurement when external triggering is enabled. When Statistical Calculation is ON, imports calculation data. Wait 100 ms before applying the trigger with ***TRG** immediately after changing the measuring conditions during measurement.

Device-Specific Commands

Set and Query Device-Specific Event Status Enable Registers ESER0

Syntax Command : **ESE0** <0 to 255>

Query : **ESE0?**

Response <0 to 255 (NR1)>

Description Command Sets the mask pattern in Event Status Enable Register 0 (ESER0) for the Event Status Register.

Query Queries the mask pattern in Event Status Enable Register 0 (ESER0) for the Event Status Register.

| 128 bit 7 | 64 bit 6 | 32 bit 5 | 16 bit 4 | 8 bit 3 | 4 bit 2 | 2 bit 1 | 1 bit 0 |
|--------------|-------------|-------------|-------------|------------|------------|------------|------------|
| unused | unused | ERR | unused | unused | unused | INDEX | EOC |

Note Data initializes to zero at power-on.

Set and Query Device-Specific Event Status Enable Registers ESER1

Syntax Command : **ESE1** <0 to 255>

Query : **ESE1?**

Response <0 to 255 (NR1)>

Description Command Sets the mask pattern in Event Status Enable Register 1 (ESER1) for the Event Status Register.

| 128 bit 7 | 64 bit 6 | 32 bit 5 | 16 bit 4 | 8 bit 3 | 4 bit 2 | 2 bit 1 | 1 bit 0 |
|--------------|-------------|-------------|-------------|------------|------------|------------|------------|
| FAIL | AND | V-Hi | V-IN | V-Lo | R-Hi | R-IN | R-Lo |

Note Data initializes to zero at power-on.

Read Device-Specific Event Status Registers ESR0 and ESR1

Syntax Query : **ESR0?**
: **ESR1?**

Response <0 to 255 (NR1)>

Note Executing : **ESR0?** clears the contents of ESR0.
Executing : **ESR1?** clears the contents of ESR1.

Select and Query the Measurement Mode Setting

| | | |
|----------------|----------|---|
| Syntax | Command | :FUNCTION <RV/ RESistance/ VOLTage> |
| | Query | :FUNCTION? |
| | Response | <RV/ RESISTANCE/ VOLTAGE> RV Ω V mode (Resistance and voltage measurement) RESISTANCE Ω mode (Resistance measurement) VOLTAGEV mode (Voltage measurement) |
| Example | Command | :FUNC RV Selects the Ω V mode. |
| | Query | :FUNC? |
| | Response | RV Ω V mode has been selected. |

Set and Query the Resistance Measurement Range

| | | |
|----------------|---|---|
| Syntax | Command | :RESistance:RANGE < 0 to 3100> |
| | Query | :RESistance:RANGE? |
| | Response | < measurement range (NR3)> < measurement range (NR3)> = 3.0000E-3/ 30.000E-3/ 300.00E-3/ 3.0000E+0/ 30.000E+0/ 300.00E+0/ 3.0000E+3 |
| Example | Command | :RES:RANG 120E-3 Selects the most suitable resistance measurement range for measuring 120 m Ω . |
| | Query | :RES:RANG? |
| | Response | 300.00E-3 The current resistance measurement range is 300 m Ω . |
| Note | Changing the resistance measurement range clears stored measurement data (memory function). | |

Set and Query the Voltage Measurement Range

| | | |
|----------------|----------|--|
| Syntax | Command | :VOLTage:RANGE <-300 to 300> |
| | Query | :VOLTage:RANGE? |
| | Response | < measurement range(NR3)> <measurement range(NR3)> = 6.00000E+0/ 60.0000E+0/100.000E+0/ 300.000E+0 |
| Example | Command | :VOLT:RANG 15 Selects the voltage measurement range for measuring 15 V. |
| | Query | :VOLT:RANG? |
| | Response | 60.0000E+0 The BT3561A and BT3562 accept values of up to ± 300 V; however, each maximum range will be set. |

Set and Query the Auto-Ranging Setting

Syntax Command :AUTorange <1, 0, ON or OFF>

Query :AUTorange?

Response <ON or OFF>

Example Command :AUT ON

- Note**
- Attempting to enable auto-ranging when the Comparator or Memory function is enabled results in a execution error.
 - The auto-ranging setting applies to both resistance measurement and voltage measurement.

Cancel Zero-Adjustment

Syntax Command :ADJust:CLEAr

Description Command Clears zero adjustment.

Execute Zero Adjustment and Query the Result

Syntax Query :ADJust?

Response <0/ 1 (NR1)>

0..... Zero adjustment succeeded

1..... Zero adjustment failed

The acceptable range of zero adjustment for both resistance and voltage is ± 1000 dgt.

Description Query Queries whether zero adjustment has succeeded or failed.

Example Query :ADJ?

Response 0

Zero adjustment executed successfully.

Select and Query the Sampling Rate setting

Syntax Command :SAMPle:RATE <EXFast/ FAST/ MEDIum/ SLOW>

Query :SAMPle:RATE?

Response <EXFAST/ FAST/ MEDIUM/ SLOW>

Example Command :SAMP:RATE MED

Query :SAMP:RATE?

Response MEDIUM

Set and Query the Averaging Function Setting

Syntax Command **:CALCulate:AVERage:STATe** <1, 0, ON or OFF>
Query **:CALCulate:AVERage:STATe?**
Response <ON or OFF>

Example Command **:CALC:AVER:STAT OFF**
Query **:CALC:AVER:STAT?**
Response **OFF**

Set and Query the No. of samples to average

Syntax Command **:CALCulate:AVERage** <2 to 16>
Query **:CALCulate:AVERage?**
Response <2 to 16 (NR1)>

Example Command **:CALC:AVER 10**
Query **:CALC:AVER?**
Response **10**

Set and Query the Comparator

Syntax Command **:CALCulate:LIMit:STATe** <1, 0, ON or OFF>
Query **:CALCulate:LIMit:STATe?**
Response <ON or OFF>

Example Command **:CALC:LIM:STAT ON**
Query **:CALC:LIM:STAT?**
Response **ON**

Note

- When the Comparator function is enabled, auto-ranging is disabled.
- Switching the Comparator function on/off or changing its settings clears stored measurement data (memory function).

Set and Query Comparator Judgments

Syntax Command :CALCulate:LIMit:BEEPer <OFF/HL/IN/BOTH1/BOTH2>
 Query :CALCulate:LIMit:BEEP?
 Response <OFF/ HL/ IN/ BOTH1/ BOTH2>
 OFF.....No beeps sound.
 HLThe beeper sounds upon Hi and Lo judgments.
 INThe beeper sounds upon IN judgments.
 BOTH1.....The beeper sounds continuously upon IN judgments,
 and repeatedly upon Hi and Lo judgments.
 BOTH2.....The beeper sounds once (briefly) upon IN judgments,
 and repeatedly upon Hi and Lo judgments.

Example Command :CALC:LIM:BEEP IN
 Query :CALC:LIM:BEEP?
 Response IN

Set and Query the Comparator Execution Mode Setting

(Resistance Measurement)

Syntax Command :CALCulate:LIMit:RESistance:MODE <HL/ REF>
 Query :CALCulate:LIMit:RESistance:MODE?
 Response <HL/ REF>
 HLDecision by preset upper and lower thresholds.
 REF.....Decision by a reference value and tolerance.

Example Command :CALC:LIM:RES:MODE REF
 Query :CALC:LIM:RES:MODE?
 Response REF

(Voltage Measurement)

Syntax Command :CALCulate:LIMit:VOLTage:MODE <HL/ REF>
 Query :CALCulate:LIMit:VOLTage:MODE?
 Response <HL/ REF>
 HLDecision by preset upper and lower thresholds.
 REF.....Decision by a reference value and tolerance.

Set and Query the Comparator Upper Threshold Setting

(Resistance Measurement)

| | | |
|----------------|---|--|
| Syntax | Command | :CALCulate:LIMit:RESistance:UPPer <Upper threshold> |
| | Query | :CALCulate:LIMit:RESistance:UPPer? |
| | Response | <Upper threshold> <Upper threshold> = 0 to 99999 (NR1) |
| Example | Command | :CALC:LIM:RES:UPP 28593 Sets the upper threshold to 285.93 mΩ (with the 300 mΩ range selected) (If the 3 Ω range is selected, the threshold is set to 2.8593 Ω) |
| | Query | :CALC:LIM:RES:UPP? |
| | Response | 28593 |
| Note | The value is sent as a whole integer (count). To set 120.53 mΩ with the 300 mΩ range, send the following: :CALC:LIM:RES:UPP 12053 | |

(Voltage Measurement)

| | | |
|----------------|--|--|
| Syntax | Command | :CALCulate:LIMit:VOLTage:UPPer <Upper threshold> |
| | Query | :CALCulate:LIMit:VOLTage:UPPer? |
| | Response | <Upper threshold> <Upper threshold> = 0 to 999999 (NR1) |
| Example | Command | :CALC:LIM:VOLT:UPP 380000 Sets the upper threshold to 3.80000 V. (with the 6 V range selected) |
| | Query | :CALC:LIM:VOLT:UPP? |
| | Response | 380000 |
| Note | The value is sent as a whole integer (count). To set 48.5003 V with the 60 V range, send the following: :CALC:LIM:VOLT:UPP 485003 | |

Set and Query the Comparator Lower Threshold Setting

(Resistance Measurement)

Syntax Command **:CALCulate:LIMit:RESistance:LOWer**
<Lower threshold>

Query **:CALCulate:LIMit:RESistance:LOWer?**

Response <Lower threshold>
<Lower threshold> = 0 to 99999 (NR1)

Example Command **:CALC:LIM:RES:LOW 28406**
Sets the lower threshold to 284.06 m Ω (with the 300 m Ω range selected)
(If the 3 Ω range is selected, the threshold is set to 2.8406 Ω)

Query **:CALC:LIM:RES:LOW?**

Response **28406**

Note The value is sent as a whole integer (count). To set 120.53 m Ω with the 300 m Ω range, send the following:
:CALC:LIM:RES:LOW 12053

(Voltage Measurement)

Syntax Command **:CALCulate:LIMit:VOLTage:LOWer**
<Lower threshold>

Query **:CALCulate:LIMit:VOLTage:LOWer?**

Response <Lower threshold>
<Lower threshold> = 0 to 999999 (NR1)

Example Command **:CALC:LIM:VOLT:LOW 360000**
Sets the lower threshold to 3.60000 V. (with the 6 V range selected)

Query **:CALC:LIM:VOLT:LOW?**

Response **360000**

Note The value is sent as a whole integer (count).
To set 45.9997 V with the 60 V range, send the following:
:CALC:LIM:VOLT:LOW 459997

Set and Query the Comparator Reference Value

(Resistance Measurement)

| | | |
|----------------|---|--|
| Syntax | Command | :CALCulate:LIMit:RESistance:REFerence <Reference value> |
| | Query | :CALCulate:LIMit:RESistance:REFerence? |
| | Response | <Reference value> <Reference value> = 0 to 99999 (NR1) |
| Example | Command | :CALC:LIM:RES:REF 5076 Sets the reference value to 50.76 mΩ (with the 300 mΩ range selected) (If the 3 Ω range is selected, the threshold is set to 0.5076 Ω) |
| | Query | :CALC:LIM:RES:REF? |
| | Response | 5076 |
| Note | The value is sent as a whole integer (count). To set 120.53 mΩ with the 300 mΩ range, send the following: :CALC:LIM:RES:REF 12053 | |

(Voltage Measurement)

| | | |
|----------------|--|--|
| Syntax | Command | :CALCulate:LIMit:VOLTage:REFerence <Reference value> |
| | Query | :CALCulate:LIMit:VOLTage:REFerence? |
| | Response | <Reference value> <Reference value> = 0 to 999999 (NR1) |
| Example | Command | :CALC:LIM:VOLT:REF 370000 Sets the reference value to 3.70000 V. (with the 6 V range selected) |
| | Query | :CALC:LIM:VOLT:REF? |
| | Response | 370000 |
| Note | The value is sent as a whole integer (count). To set 47.0000 V with the 60 V range, send the following: :CALC:LIM:VOLT:REF 470000 | |

Set and Query the Comparator Decision Tolerance Setting (Comparator Function)

(Resistance Measurement)

Syntax Command :CALCulate:LIMit:RESistance:PERCent
<Tolerance (%)>
Query :CALCulate:LIMit:RESistance:PERCent?
Response <Tolerance (%)>
<Tolerance (%)> = 0 to 99.999 (NR2)

Example Command :CALC:LIM:RES:PERC 0.3
Query :CALC:LIM:RES:PERC?
Response 0.300

(Voltage Measurement)

Syntax Command :CALCulate:LIMit:VOLTage:PERCent
<Tolerance (%)>
Query :CALCulate:LIMit:VOLTage:PERCent?
Response <Tolerance (%)>
<Tolerance (%)> = 0 to 99.999 (NR2)

Example Command :CALC:LIM:VOLT:PERC 1.538
Query :CALC:LIM:VOLT:PERC?
Response 1.538

Query Comparator Judgment Results

(Resistance Measurement)

Syntax Query **:CALCulate:LIMit:RESistance:RESult?**
 Response **<HI/ IN/ LO/ OFF/ ERR>**

Example Query **:CALC:LIM:RES:RES?**
 Response **HI**

(Voltage Measurement)

Syntax Query **:CALCulate:LIMit:VOLTage:RESult?**
 Response **<HI/ IN/ LO/ OFF/ ERR>**

Set and query the comparator absolute value judgment function

Syntax Command **:CALCulate:LIMit:ABS <1, 0, ON or OFF>**
 Query **:CALCulate:LIMit:ABS?**
 Response **<ON or OFF>**
 ON..... Absolute value judgment function on
 OFF..... Absolute value judgment function off

Note The absolute value is only taken for voltage measured values.

Execute Statistical Functions

Syntax Command **:CALCulate:STATistics:STATE** <1, 0, ON or OFF>
 Query **:CALCulate:STATistics:STATE?**
 Response <ON or OFF>

Example Command **:CALC:STAT:STAT ON**
 Query **:CALC:STAT:STAT?**
 Response **ON**

NOTE

About the Statistical Calculation function

Data samples can be acquired by the following three methods:

- Press the **TRIG** key
- Apply an EXT I/O TRIG signal
- Send the ***TRG** command

The **:CALCulates:STATistics:STATE** command does not clear calculation results.

When the valid data count is zero, σ_{n-1} returns 0.

Clearing calculation results does not disable the Statistical Calculation function.

The upper limit of Cp and CpK is 99.99. Cp and CpK values greater than 99.99 are returned as 99.99.

The lower limit of Cp and CpK is 0. Cp and CpK values less than 0 are returned as 0.00.

Clear Statistical Calculation Results

Syntax Command **:CALCulate:STATistics:CLEAr**

Query the Data Count

(Resistance Measurement)

| | | |
|----------------|---|---|
| Syntax | Query | :CALCulate:STATistics:RESistance:NUMBER? |
| | Response | <Total data count (NR1)>,<Valid data count (NR1)> <Total data count (NR1)> = 0 to 30000 (NR1) <Valid data count (NR1)> = 0 to 30000 (NR1) |
| Example | Query | :CALC:STAT:RES:NUMB? |
| | Response | 22,20 |
| Note | Measurement faults and out-of-range "OF" measurements are ignored for statistical calculations. | |

(Voltage Measurement)

| | | |
|----------------|---|---|
| Syntax | Query | :CALCulate:STATistics:VOLTage:NUMBER? |
| | Response | <Total data count (NR1)>,<Valid data count (NR1)> |
| Example | Query | :CALC:STAT:VOLT:NUMB? |
| | Response | 22,20 |
| Note | Measurement faults and out-of-range "OF" measurements are ignored for statistical calculations. | |

Query the Mean value

(Resistance Measurement)

| | | |
|----------------|----------|---|
| Syntax | Query | :CALCulate:STATistics:RESistance:MEAN? |
| | Response | <Mean (NR3)> |
| Example | Query | :CALC:STAT:RES:MEAN? |
| | Response | 295.76E-3 |

(Voltage Measurement)

| | | |
|----------------|----------|--|
| Syntax | Query | :CALCulate:STATistics:VOLTage:MEAN? |
| | Response | <Mean (NR3)> |
| Example | Query | :CALC:STAT:VOLT:MEAN? |
| | Response | 1.3923E+0 |

Query the Maximum value

(Resistance Measurement)

Syntax Query **:CALCulate:STATistics:RESistance:MAXimum?**
 Response <Maximum value (NR3)>,<Data No. of Maximum value (NR1)>

Example Query **:CALC:STAT:RES:MAX?**
 Response **297.28E-3,15**

(Voltage Measurement)

Syntax Query **:CALCulate:STATistics:VOLTage:MAXimum?**
 Response <Maximum value (NR3)>,<Data No. of Maximum value (NR1)>

Example Query **:CALC:STAT:VOLT:MAX?**
 Response **1.3924E+0,1**

Query the Minimum value

(Resistance Measurement)

Syntax Query **:CALCulate:STATistics:RESistance:MINimum?**
 Response <Minimum value (NR3)>,<Data No. of Minimum value (NR1)>

Example Query **:CALC:STAT:RES:MIN?**
 Response **294.88E-3,8**

(Voltage Measurement)

Syntax Query **:CALCulate:STATistics:VOLTage:MINimum?**
 Response <Minimum value (NR3)>,<Data No. of Minimum value (NR1)>

Example Query **:CALC:STAT:VOLT:MIN?**
 Response **1.3923E+0,2**

Query Comparator Judgment Results (Statistical Calculation Function)

(Resistance Measurement)

| | | |
|----------------|----------|--|
| Syntax | Query | :CALCulate:STATistics:RESistance:LIMit? |
| | Response | <Hi (NR1) count>,<IN (NR1) count>,<Lo (NR1) count>,<Measurement fault count (NR1)> |
| Example | Query | :CALC:STAT:RES:LIM? |
| | Response | 6,160,13,2 |

(Voltage Measurement)

| | | |
|----------------|----------|--|
| Syntax | Query | :CALCulate:STATistics:VOLTage:LIMit? |
| | Response | <Hi (NR1) count>,<IN (NR1) count>,<Lo (NR1) count>,<Measurement fault count (NR1)> |
| Example | Query | :CALC:STAT:VOLT:LIM? |
| | Response | 1,19,0,2 |

Query Standard Deviation

(Resistance Measurement)

| | | |
|----------------|----------|--|
| Syntax | Query | :CALCulate:STATistics:RESistance:DEViation? |
| | Response | < σ_n (NR3)>,< σ_{n-1} (NR3)> |
| Example | Query | :CALC:STAT:RES:DEV? |
| | Response | 0.82E-3,0.84E-3 |

(Voltage Measurement)

| | | |
|----------------|----------|---|
| Syntax | Query | :CALCulate:STATistics:VOLTage:DEViation? |
| | Response | < σ_n (NR3)>,< σ_{n-1} (NR3)> |
| Example | Query | :CALC:STAT:VOLT:DEV? |
| | Response | 0.0000E+0,0.0000E+0 |

Query the Process Capability Indices

(Resistance Measurement)

Syntax Query **:CALCulate:STATistics:RESistance:CP?**
 Response <Cp (NR2)>,<CpK (NR2)>

Example Query **:CALC:STAT:RES:CP?**
 Response **0.04, 0.04**

(Voltage Measurement)

Syntax Query **:CALCulate:STATistics:VOLTage:CP?**
 Response <Cp (NR2)>,<CpK (NR2)>

Example Query **:CALC:STAT:VOLT:CP?**
 Response **0.91, 0.00**

Set and Query the Memory Function State

Syntax Command **:MEMory:STATe** <1/0/ON/OFF>
 Query **:MEMory:STATe?**
 Response <ON/OFF>

Example Command **:MEM:STAT ON**
 Query **:MEM:STAT?**
 Response **ON**

Clear Instrument Memory

Syntax Command **:MEMory:CLEAR**

Query the Memory Data Count

| | | |
|----------------|----------|---|
| Syntax | Query | :MEMory:COUNT? |
| | Response | <Memory data count> <Memory data count> = 0 to 400 (NR1) |
| Example | Query | :MEM:COUNT? |
| | Response | 5 |

Query (Download) Memory Data

| | | |
|----------------|----------|--|
| Syntax | Query | :MEMory:DATA? [STEP] |
| | Response | <Memory data No. (NR1)>,<Measured resistance (NR3)>,<Measured voltage (NR3)> Memory data values are returned as data objects. If [STEP] is omitted, all memory data objects are returned continuously. |
| Example | Query | :MEM:DATA? |
| Example | Response | 1, 290.60E-3, 1.3924E+0 2, 290.54E-3, 1.3924E+0 3, 290.50E-3, 1.3923E+0 4, 290.43E-3, 1.3923E+0 5, 290.34E-3, 1.3924E+0 END |
| | Query | :MEM:DATA? STEP |
| | Response | 1, 290.60E-3, 1.3924E+0 N (Sent from PC) 2, 290.54E-3, 1.3924E+0 N (Sent from PC) 3, 290.50E-3, 1.3923E+0 N (Sent from PC) 4, 290.43E-3, 1.3923E+0 N (Sent from PC) 5, 290.34E-3, 1.3924E+0 N (Sent from PC) END |

- Note**
- Stored memory data objects are returned continuously, or one data object at a time. The "END" character is returned as the last data object. When the "STEP" parameter is specified, one data object is returned at a time. Sending "N" to the instrument after receiving the data causes the next data object to be returned. The memory index is an unsigned three-digit integer. Refer to "Measurement Value Formats" for format details of returned measurement values.
 - A terminator is appended to the end of each returned memory data object. When sending "N" from the PC or other device, a terminator is required. **See** " Message Terminators" (p.110).
 - Measured values are stored in memory when pressing the **TRIG** key, applying a signal to the TRIG EXT I/O connector or sending the ***TRG** command (while the Memory function is enabled). Up to 400 data objects can be stored. When the memory is full, additional measurement data is not stored.
 - When the Memory function is enabled, auto-ranging is disabled.

Execute Self-Calibration

Syntax Command : **SYSTem:CALibration**

Self-Calibration State and Setting

Command : **SYSTem:CALibration:AUTO** <1, 0, ON or OFF>

Query : **SYSTem:CALibration:AUTO?**

Response <ON or OFF>
 ON ... AUTO Self-Calibration selected
 (executes approximately every 30 minutes)
 OFF . MANUAL Self-Calibration selected

Example Command : **SYST:CAL:AUTO ON**

Query : **SYST:CAL:AUTO?**

Response **ON**

Note Even when AUTO is selected, Self-Calibration can be manually performed at any time by sending the : **SYSTem:CALibration** command.

Set and Query Measurement Value Output Upon Triggering

Command : **SYSTem:DATAout** <1, 0, ON or OFF>

Query : **SYSTem:DATAout?**

Response <ON or OFF>
 ON ... Measured values are output automatically when a trigger occurs.
 OFF . Measured values are not output.

Example Command : **SYST:DATA OFF**

Query : **SYST:DATA?**

Response **OFF**

Note

- This function is convenient when you want to obtain measured values by applying EXT I/O trigger input. When this function is enabled and a footswitch is connected to the TRIG terminal of the EXT I/O connector, a measured value is sent to the PC automatically each time the footswitch is pressed, so there is no need to send a command from the PC to obtain measurement values.
- Refer to "Measurement Value Formats" for format details of returned measurement values.
- This function is not available when the GP-IB interface is selected.

See "4.11 Measurement Value Output Function" (p.74).

Set and Query the Key Beeper Setting

| | | |
|----------------|---|---|
| Syntax | Command | :SYSTem:BEEPer:STATe <1, 0, ON or OFF> |
| | Query | :SYSTem:BEEPer:STATe? |
| | Response | <ON or OFF> |
| Example | Command | :SYST:BEEP:STAT ON |
| | Query | :SYST:BEEP:STAT? |
| | Response | ON |
| Note | Only key-press beeps are set on or off. Comparator judgment beeps are unaffected. | |

Select and Query the Line Frequency Setting

| | | |
|----------------|----------|---|
| Syntax | Command | :SYSTem:LFRequency <AUTO/50/ 60> |
| | Query | :SYSTem:LFRequency? |
| | Response | <AUTO/50/ 60> |
| Example | Command | :SYST:LFR 60 |
| | Query | :SYST:LFR? |
| | Response | 60 |

Set and Query the Key-Lock State

| | | |
|----------------|----------|--|
| Syntax | Command | :SYSTem:KLOCK <1, 0, ON or OFF> |
| | Query | :SYSTem:KLOCK? |
| | Response | <ON or OFF> |
| Example | Command | :SYST:KLOC ON |
| | Query | :SYST:KLOC? |
| | Response | ON |

Set and Query EXT I/O Lock

Syntax Command : **SYSTem:ELock** <1, 0, ON or OFF>
 Query : **SYSTem:ELock?**
 Response <ON or OFF>
 ON EXT I/O control is disabled (preventing inadvertent operations from electrical noise).
 OFF EXT I/O control is enabled.

Example Command : **SYST:ELOC ON**
 Query : **SYST:ELOC?**
 Response **ON**

Note This function affects only command input.

Set Local Control

Syntax Command : **SYSTem:LOCal**

Note Switches from remote control (REMOTE indicator lit) to local control (by panel keys).

Save and Load Measurement Values

Syntax Command : **SYSTem:SAVE** <1 to 126>
 : **SYSTem:LOAD** <1 to 126>

Note

- Attempting to load a panel number that has not been saved results in an execution error.
- Up to 126 measurement configurations can be saved and loaded. Refer to “Panel Save and Load Functions” for details.

Backup Current Measurement Configuration

Syntax Command : **SYSTem:BACKup**

Description Command The current measurement configuration (settings) is backed up so that when power is turned on the next time, the same configuration is restored.

Note Saved panel and backup settings are stored in the instrument’s EEPROM. Be aware that the number of times that the EEPROM can be rewritten is limited (to about a million times).

Set and Query the Header Present Setting

| | | |
|--------------------|----------|--|
| Syntax | Command | :SYSTem:HEADer <1, 0, ON or OFF> |
| | Query | :SYSTem:HEADer? |
| | Response | <ON or OFF> |
| Description | Command | Specifies whether a header is sent with response messages. |
| Example | Command | :SYST:HEAD ON |
| | Query | :SYST:HEAD? |
| | Response | :SYSTEM:HEADER ON |
| | Command | :SYST:HEAD OFF |
| | Query | :SYST:HEAD? |
| | Response | :OFF |

Set and Query Error Output Timing

| | | |
|----------------|----------|--|
| Syntax | Command | :SYSTem:ERRor <SYNChronous/ ASYNchronous> |
| | Query | :SYSTem:ERRor? |
| | Response | <SYNCHRONOUS/ ASYNCHRONOUS> SYNCHRONOUS.....Synchronize with EOM output ASYNCHRONOUSAsynchronous with EOM output |
| Example | Command | :SYST:ERR ASYN |
| | Query | :SYST:ERR? |
| | Response | ASYNCHRONOUS |

Set and Query the terminator

| | | |
|----------------|--|--|
| Syntax | Command | :SYSTem:TERMinator <0/ 1> |
| | Query | :SYSTem:TERMinator? |
| | Response | <0/ 1> 0 LF+EOI 1 CR ,LF+EOI |
| Example | Command | :SYST:TERM 1 |
| | Query | :SYST:TERM? |
| | Response | 0 |
| Note | The RS-232C delimiter is fixed as CR + LF. See " Message Terminators" (p.110). | |

EOM Signal Output Method Settings (software version 1.15 or later)

The following 2 methods can be selected as the EOM signal output method for external I/O. (The EOM signal is set to ON at end-of-measurement and set to OFF according to the output method that has been set)

- **HOLD** Holds the EOC signal until measurement starts by the next trigger signal.
- **PULSE** Sets EOM=OFF according to the specified pulse width.

Also, the pulse width can be set between 0.001 to 0.099 seconds when PULSE is selected.

EOC Output Mode Setting

Syntax Command **:SYSTem:EOM:MODE** <HOLD/PULSE>
 Query **:SYSTem:EOM:MODE?**
 Response <HOLD/PULSE>
 ONHolds the EOC signal until measurement starts by the next trigger signal.
 OFFSets EOM=OFF according to the specified pulse width.

Example Command **:SYST:EOC:MODE PULS**

EOM Pulse Width Setting

Syntax Command **:SYSTem:EOM:PULSe** <Pulse width>
 Query **:SYSTem:EOM:PULSe?**
 Response <Pulse width> = 0.001 to 0.099 (NR2)[second]

Example Command **:SYST:EOM:PULS 0.005**

Set and query the measurement current pulse output function

Syntax Command **:SYSTem:CURRent** <CONTInuous/PULSe>
 Query **:SYSTem:CURRent?**
 Response <CONTINUOUS/PULSE>
 CONTInuous.....Measurement current continuous output
 PULSe.....Measurement current pulse output

Note The measurement current is applied continuously when performing continuous measurement with the internal trigger (:INIT:CONT ON), even if the measurement current pulse output function is set to generate pulse output.

System Reset

Syntax Command **:SYSTem:RESet**

Description Command All settings including saved panel settings are returned to factory defaults. Refer to "Reset Function" for details.

Example Command **:SYST:RES**

Note

- If you want to preserve saved data, use the ***RST** command instead.
- The communications settings are not re-initialized.

EXT I/O Output

Syntax Command : **IO:OUT** <0 to 1023>

Description Command Any 10-bit data can be output from the EXT I/O connectors.
See "Output Signals" (p.82).

| | bit9 | bit8 | bit7 | bit6 | bit5 | bit4 | bit3 | bit2 | bit1 | bit0 |
|---------|------|------|------|------|------|------|------|------|------|------|
| | OUT | OUT | OUT | OUT | OUT | OUT | OUT | OUT | OUT | OUT |
| | 9 | 8 | 7 | 6 | 5 | 4 | 3 | 2 | 1 | 0 |
| Pin No. | 36 | 18 | 35 | 17 | 34 | 16 | 33 | 15 | 32 | 14 |

EXT I/O Input

Syntax Query : **IO:IN?**

Response 0 to 31(NR1)

Description Query Signals at the EXT I/O ($\overline{IN0}$ to $\overline{IN4}$) input terminals are read at the leading edge.
 Each bit (edge data) is cleared upon reading by this query.
 A bit is set when the leading edge (short between each signal terminal and the ISO_COM terminal) is detected, and is cleared when read by this query command.
See " Input Signals" (p.81).

| | bit4 | bit3 | bit2 | bit1 | bit0 |
|---------|---|---|--|---------------------------------------|--|
| | $\overline{IN4}$ ($\overline{MA-NU}$) | $\overline{IN3}$ (\overline{PRINT}) | $\overline{IN2}$ ($\overline{0ADJ}$) | $\overline{IN1}$ (\overline{CAL}) | $\overline{IN0}$ (\overline{TRIG}) |
| Pin No. | 26 | 7 | 21 | 20 | 1 |

Note The **TRIG** key and ***TRG** command are detected in the same way as the TRIG terminal signal.

Triggering System Description

Triggering operates as follows depending on the continuous measurement setting (: **INITIATE:CONTINUOUS**) and the trigger source setting (: **TRIGGER:SOURCE**).

See "8.7 Basic Data Importing Methods" (p.165).

| | | Continuous Measurement (: INITIATE:CONTINUOUS) | |
|--|--|--|--|
| | | ON | OFF ^{*1} |
| Trigger Source (: TRIGGER:SOURCE) | IMMEDIATE (EXT.TRIG not lit) | Free-Run state. Measurement continues automatically. See next page (1) | Trigger by : INITIATE (or : READ?) command. See next page (2) |
| | EXTERNAL (EXT.TRIG lit) | Trigger by TRIG terminal, TRIG key or * TRG command. After measurement, enters the trigger wait state. See next page (3) | Issue : INITIATE (or : READ?) command to wait for trigger. Trigger by $\overline{\text{TRIG}}$ terminal, TRIG key or * TRG command. See next page (4) ^{*2} |

*1: : **INITIATE:CONTINUOUS OFF**

Can only be set by Remote command.

If this has been set to OFF when operation is returned to the Local state or power is turned off, the following state occurs when power is turned back on.

: **INITIATE:CONTINUOUS ON**

See " Local Function" (p.118).

*2: The ***TRG** command cannot be used for triggering while awaiting a trigger after issuing a : **READ?** command. In this case, use the $\overline{\text{TRIG}}$ terminal or **TRIG** key for triggering.

Measurement Flow

1 : INITIATE:CONTINUOUS ON
: TRIGGER:SOURCE IMMEDIATE

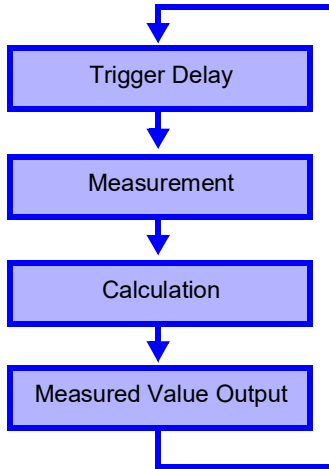

2 : INITIATE:CONTINUOUS OFF
: TRIGGER:SOURCE IMMEDIATE

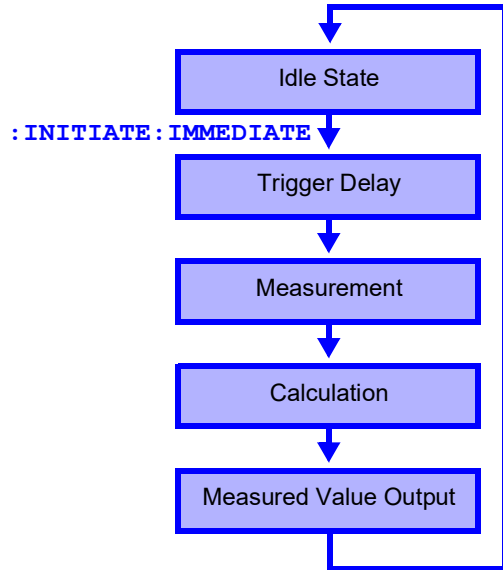

3 : INITIATE:CONTINUOUS ON
: TRIGGER:SOURCE EXTERNAL

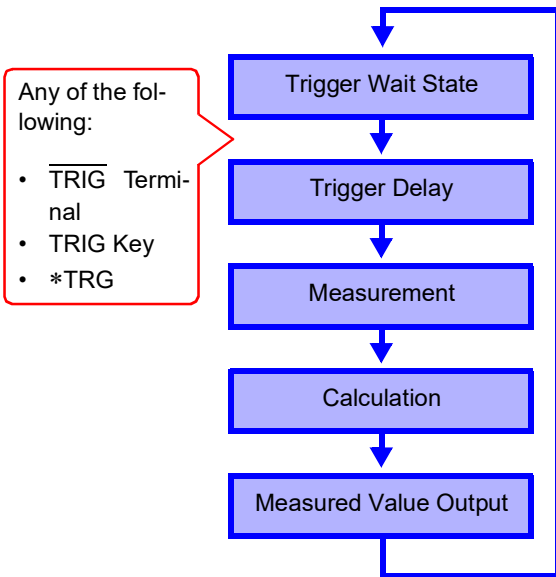

4 : INITIATE:CONTINUOUS OFF
: TRIGGER:SOURCE EXTERNAL

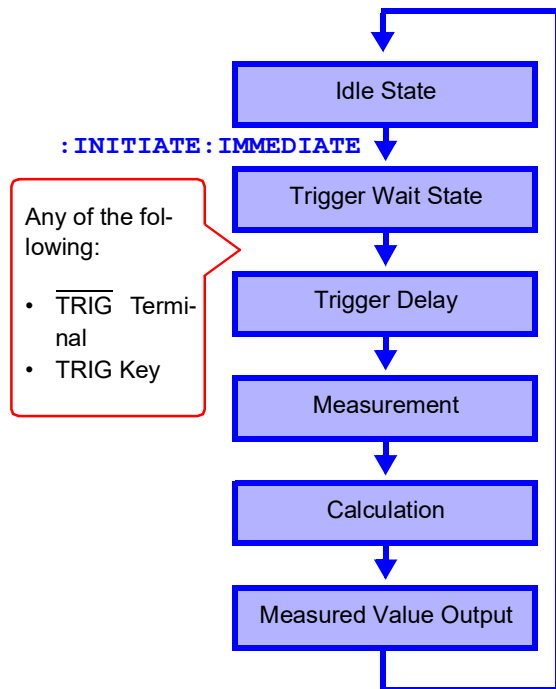

Continuous Measurement Setting

| | |
|--------------------|---|
| Syntax | Command :INITiate:CONTinuous <1, 0, ON or OFF> |
| | Query :INITiate:CONTinuous? |
| | Response <ON or OFF> ON Continuous Measurement Enabled OFF Continuous Measurement Disabled |
| Description | Command Sets continuous measurement. Query Queries the continuous measurement setting. |
| Example | Command :INIT:CONT OFF Disables continuous measurement. Query :INIT:CONT? Response ON Enables continuous measurement. |
| Note | <ul style="list-style-type: none"> • Continuous Measurement Enabled: After measurement, enters the Trigger Wait State. When the trigger source setting is IMMEDIATE, the next trigger occurs immediately (the Free-Run State). • Continuous Measurement Disabled: After measurement, enters the Idle State instead of the Trigger Wait State. • Triggering is ignored in the Idle State. Executing :INITiate[:IMMEDIATE] enables the Trigger Wait State. • Continuous measurement is enabled upon exit from the Remote State. |

Trigger Wait Setting

| | |
|--------------------|--|
| Syntax | Command :INITiate[:IMMEDIATE] |
| Description | Command Switches triggering from the Idle State to the Trigger Wait State. |
| Example | <p>Command Disable continuous measurement, and read one value for each trigger event</p> <p>Send :TRIG:SOUR IMM.... Trigger immediately when entering Trigger Wait State :INIT:CONT OFF.... Disables continuous measurement :INIT Enable Trigger Wait Trigger immediately upon :TRIG:SOUR IMM :FETC? Fetch measured value</p> <p>Response 2.1641E+0 Measured value is 2.1641 Ω</p> |
| Error | <ul style="list-style-type: none"> • An execution error occurs when continuous measurement is enabled (:INITiate:CONTINUOUS ON). |
| Note | <ul style="list-style-type: none"> • When the trigger source is IMMEDIATE, triggering occurs immediately before entering the Idle State. • When the trigger source is EXTERNAL, the Trigger Wait State is enabled to wait for an external trigger, and when a trigger occurs, one measurement is taken before entering the Idle State. |

Set and Query the Trigger Source

| | | |
|--------------------|----------|--|
| Syntax | Command | :TRIGger:SOURce <IMMediate/ EXTernal> |
| | Query | :TRIGger:SOURce? |
| | Response | <IMMEDIATE/ EXTERNAL> IMMEDIATE Internal triggering EXTERNAL External trigger source. Triggering by TRIG key, TRIG terminal or *TRG command. |
| Description | Command | Selects the trigger source. |
| | Query | Queries the trigger source selection. |
| Example | Command | :TRIG:SOUR IMM Sets the trigger source to internal triggering. |
| | Query | :TRIG:SOUR? |
| | Response | IMMEDIATE The trigger source is set to internal triggering. |

Enable/Disable and Query Trigger Delay

| | | |
|----------------|----------|---|
| Syntax | Command | :TRIGger:DELAy:STATe <1, 0, ON or OFF> |
| | Query | :TRIGger:DELAy:STATe? |
| | Response | <ON or OFF> ON..... Trigger delay enabled OFF..... Trigger delay disabled |
| Example | Command | :TRIG:DEL:STAT ON Enables trigger delay. |
| | Query | :TRIG:DEL:STAT? |
| | Response | ON Trigger delay is enabled (ON). |

Set and Query Trigger Delay Interval

| | | |
|--------------------|----------|--|
| Syntax | Command | :TRIGger:DElay <0 to 9.999> |
| | Query | :TRIGger:DElay? |
| | Response | <0 to 9.999 (NR2)> |
| Description | Command | Sets the trigger delay interval. |
| | Query | Queries the trigger delay interval setting. |
| Example | Command | :TRIG:DEL 0.058 Sets the trigger delay to 0.058 seconds. |
| | Query | :TRIG:DEL? |
| | Response | 0.058 The trigger delay is set to 0.058 seconds. |
| | | |

Read the Latest Measurement

| | | |
|--------------------|----------|--|
| Syntax | Query | :FETCh? |
| | Response | <Measured resistance (NR3)>, <Measured voltage (NR3)> (Ω V mode) |
| | | <Measured resistance (NR3)> (Ω mode) <Measured voltage (NR3)> (V mode) |
| Description | Query | Reads the most recent measurement. No trigger occurs. |
| Example | Query | :FETC? |
| | Response | 288.02E-3, 1.3921E+0 (Ω V mode) The last measured resistance is 288.02 m Ω , and the last measured voltage is 1.3921 V. See " Measurement Value Formats" (p.159). |

Execute a Measurement and Read the Measured Values

| Syntax | Query | :READ? | | | | | | |
|--------------------|--|--|----------------|-----------|-----------|------------------------------------|----------|--|
| | Response | <Measured resistance (NR3)>, <Measured voltage (NR3)> (Ω V mode) <Measured resistance (NR3)> (Ω mode) <Measured voltage (NR3)> (V mode) | | | | | | |
| Description | Query | Switches from the Idle State to the Trigger Wait State, then reads the next measured value. With auto-ranging enabled, the most suitable range is selected before measurement. | | | | | | |
| | | <table border="1"> <thead> <tr> <th>Trigger Source</th> <th>Operation</th> </tr> </thead> <tbody> <tr> <td>IMMediate</td> <td>Triggers and reads measured value.</td> </tr> <tr> <td>EXTernal</td> <td>After triggering by the TRIG terminal (EXT I/O) or TRIG key, reads the measured value.</td> </tr> </tbody> </table> | Trigger Source | Operation | IMMediate | Triggers and reads measured value. | EXTernal | After triggering by the TRIG terminal (EXT I/O) or TRIG key, reads the measured value. |
| Trigger Source | Operation | | | | | | | |
| IMMediate | Triggers and reads measured value. | | | | | | | |
| EXTernal | After triggering by the TRIG terminal (EXT I/O) or TRIG key, reads the measured value. | | | | | | | |
| Example | Query | :READ? | | | | | | |
| | Response | 289.68E-3, 1.3921E+0 (Ω V mode) Measured resistance is 289.68 m Ω , and voltage is 1.3921 V. | | | | | | |
| Error | This command causes an execution error if issued during the Continuous Measurement state (after :INITIATE:CONTINUOUS ON). | | | | | | | |
| Note | <ul style="list-style-type: none"> • The next command does not execute until measurement is finished. • When the trigger source is external, the *TRG command does not trigger measurement. • Wait 100 ms before applying the trigger with :READ? immediately after changing the measuring conditions during measurement. <p>See " Measurement Value Formats" (p.159).</p> | | | | | | | |

Measurement Value Formats

For the commands that acquire measurement values (:**FETCH?** and :**READ?**), the response formats are as follows.

Measured Resistance

| Measurement range | Measured Value | ±OF | Measurement Fault |
|-------------------|----------------|-------------|-------------------|
| 3 mΩ | ±**.*E-3 | ±10.0000E+8 | +10.0000E+9 |
| 30 mΩ | ±***.*E-3 | ±100.000E+7 | +100.000E+8 |
| 300 mΩ | ±****.*E-3 | ±1000.00E+6 | +1000.00E+7 |
| 3 Ω | ±**.*E+0 | ±10.0000E+8 | +10.0000E+9 |
| 30 Ω | ±***.*E+0 | ±100.000E+7 | +100.000E+8 |
| 300 Ω | ±****.*E+0 | ±1000.00E+6 | +1000.00E+7 |
| 3000 Ω | ±**.*E+3 | ±10.0000E+8 | +10.0000E+9 |

Measured Voltage

| Measurement range | Measured Value | ±OF | Measurement Fault |
|---------------------|----------------|-------------|-------------------|
| 6 V | ±*.*E+0 | ±1.00000E+9 | +1.00000E+10 |
| 60 V | ±**.*E+0 | ±10.0000E+8 | +10.0000E+9 |
| 100 V ^{*1} | ±***.*E+0 | ±100.000E+7 | +100.000E+8 |
| 300 V ^{*2} | ±****.*E+0 | ±100.000E+7 | +100.000E+8 |

*1: The 100 V range is only available on the Model BT3562A.

*2: The 300 V range is only available on the Model BT3563A, BT3563 and BT3563-01.

Relative Value Indication

(same as voltage and resistance)

| Measurement range | Measured Value | ±OF | Measurement Fault |
|-------------------|----------------|-------------|-------------------|
| All ranges | ±***.*E+0 | ±100.000E+7 | +100.000E+8 |

For positive measurements, the sign position is blank (20H).

When a measurement fault occurs during voltage measurement in the 6 V range, one more digit is used (for the exponent) for the measured value string than in other modes.

| | |
|---------------------------|----------|
| 6 V normal measured value | ±*.*E+0 |
| At 6 V measurement fault | ±*.*E+00 |

Unneeded zeroes to the left of the decimal point are replaced by blank space (20H).

Example :_0001.36E-3 → ____1.36E-3

-0007.51E+0 → -__7.51E+0

("_" indicates blanks space [20H].)

Command Compatibility with the Model 3560 AC m Ω HiTESTER

Model BT3562 and BT3563 Battery Hitester accept all of the commands supported by the HIOKI 3560 AC m Ω Hitester. However the following differences result from the functional differences.

Comparator Tables

Up to 30 comparator settings can be saved with the Model 3560. The settings of each table can be changed directly by specifying the table number. With this instrument, up to 126 measurement configurations (including comparator settings) can be saved (Panel Save). Settings for each configuration cannot be set directly. To recall saved configuration settings, specify the table (panel) number and execute Panel Load. A table number does not need to be specified for comparator settings.

Comparator Operations

Model 3560 judges resistance and voltage measurements together as PASS/FAIL. This instrument judges resistance and voltage independently. Also, when the Comparator function is enabled (ON), auto-ranging is disabled (OFF).

Voltage Limiter

This instrument does not include a voltage limiter function (limiting open-terminal voltage to 20 mV). This instrument's open-terminal voltage is maximum 25 V (peak). The voltage will drop to several mV within 100 μ s of the measurement leads being connected to the target. Note that a maximum 4 V peak will be applied when the test object resistance exceeds the range's measurement range by a significant margin.

Sense Line Disconnect Detection

The sense line disconnect detection function cannot be switched on/off with this instrument. Detection is always enabled.

Resistance Value Digits with FAST Sampling

When FAST sampling is enabled on Model 3560, the number of resistance measurement digits is decreased from five to four. With this instrument, measurement values are always five digits (31000 counts) regardless of sampling rate.

Voltage Measurement

Model 3560 provides 5 and 50 V ranges, with five-digit (50000 count) measurement values.

The instrument offers 6 V, 60 V, 100 V^{*1}, and 300 V^{*2} ranges and generates measured values that have one more digit (for a total of six digits) than the Model 3560.

*1: The 100 V range is only available on the Model BT3562A.

*2: The 300 V range is only available on the Model BT3563A, BT3563, or BT3563-01.

Compatibility of each of the Model 3560 commands is described below with details of the functional differences with this instrument.

For the Model BT3560, the command header is set to OFF when the instrument is turned on or reset (including *RST).

| Message ([] = optional) | Data Contents () = response data | Differences Model BT3562 (BT3562-01) Model 3560 | |
|---------------------------|---|---|--|
| Standard Commands | | | |
| *IDN? | <Manufacturer's name>,<Model name>,0,<Software version> | Model name in response data: BT3561A BT3562A BT3562 BT3562-01 BT3563A BT3563 BT3563-01 | Model name in response data: 3560 |
| *OPC | _____ | | |
| *OPC? | 1 | | |
| *RST | _____ | Initialization contents Measurement mode: Ω V mode (Resistance and voltage measurement) Header: OFF (Model BT3562) Power supply frequency: AUTO Zero-adjust value: Initialized to 0 (Model 3560) Power supply frequency: 50 Hz Zero-adjust value: Not initialized | Initialization contents Measurement mode: Resistance measurement mode Header: ON |
| *SRE | 0 to 255 (NR1) | | |
| *SRE? | | | |
| *STB? | 0 to 255 (NR1) | | |
| *TRG | _____ | | |
| *TST? | 0 to 3 (NR1) | Response data bit2: -, bit1: EEP-ROM, bit0: RAM | Response data bit2: EEP-ROM, bit1: RAM, bit0: ROM |
| *WAI | | | |

Device-Specific Commands

| | | | |
|-------------|------------------------------|---|---|
| :MODE | R/ RV | | |
| :MODE? | | | |
| :RRANge | 0 to 3.1E+3 | | |
| :RRANge? | 3E-3 to 3E+3 | | |
| :VRANge | -300 to 300 | Voltage range: -300 to 300 | Voltage range: -50 to 50 |
| :VRANge? | 6E+0/60E+0/100E+0/ 300E+0 | 6 V, 60 V, 100 V ^{*1} , and 300 V ^{*2} ranges are supported. ^{*1} : The 100 V range is only available on the Model BT3562A. ^{*2} : The 300 V range is only available on the Model BT3563A, BT3563, or BT3563-01. | Response: 5E+0/ 50E+0 |
| :AUTorange | 1/ 0/ ON/ OFF | Setting is not possible when the comparator is enabled (when the comparator is set to ON, auto-ranging is turned OFF). | Setting is possible even when the comparator is enabled (ON). |
| :AUTorange? | ON/ OFF | | |

8.6 Message Reference

| Message ([] = optional) | Data Contents () = response data | Differences | |
|---------------------------------------|--|---|---|
| | | Model BT3562 (BT3562-01) | Model 3560 |
| :ADJust? | 0/ 1 | Performs a measurement to generate the zero-adjustment value Zero-adjustment range: 1000 counts | Applies the currently displayed value as the zero-adjustment value Zero-adjustment range: 2400 counts |
| :SAMPle :SAMPle? | FAST/ MEDium/ SLOW | | |
| :COMParator :COMParator? | 0 to 30 | Range of panel numbers: Turns Off when the panel number is 0, and turns On when the panel number is 1 to 30 Response: Returns 0 when the comparator is disabled (OFF), and 1 when enabled (ON) | Range of Comparator Numbers: 0 to 30 Response: Returns the response number |
| :CSET:MODE :CSET:MODE? | R/ RV | | |
| :CSET:NUMBer :CSET:NUMBer? | 1 to 126 | (function not available) | Specifies the comparator table number to set |
| :CSET:RPARAmeter :CSET:RPARAmeter? | <Upper threshold/ Lower threshold> | Setting range: 0 to 3.1000E+3 *Be sure to set the measurement range first. Otherwise, this setting will not be properly configured. | Setting range: 0 to 3.1000E+3 |
| :CSET:RRANge :CSET:RRANge? | 0 to 3E+0 3E-3 to 3E+3 | Resistance range: 0 to 3.1E+3 3 mΩ ranges are supported. | Resistance range: 0 to 3.1E+3 |
| :CSET:VPARAmeter :CSET:VPARAmeter? | <Upper threshold/ Lower threshold> | Setting range: 0 to 300 V * Negative setting values are invalid. *Be sure to set the measurement range first. Otherwise, this setting will not be properly configured. | Setting range: -5.0000 to 5.0000 (5 V range) -50.000 to 50.000 (50 V range) |
| :CSET:VRANge :CSET:VRANge? | -300 to 300 6E+0/60E+0/100E+0/ 300E+0 | Voltage range: -300 to 300 V, 60 V, 100 V ^{*1} , and 300 V ^{*2} ranges are supported. *1: The 100 V range is only available on the Model BT3562A. *2: The 300 V range is only available on the Model BT3563A, BT3563, or BT3563-01. | Voltage range: -50 to 50 Response: 5E+0/ 50E+0 |
| :CTMode :CTMode? | AUTo/ MANual | | |
| :MEASure:BATTery? | <Measured resistance, Measured voltage, Judgment result> FAIL/ PASS/ OFF/ NG | Resistance measurement values consist of five digits with FAST sampling Voltage measured values: 1 digit for sign + 6 digits for value * Numerical values do not include a decimal point. | Resistance measurement values consist of four digits with FAST sampling Voltage measured values: 1 digit for sign + 5 digits for value * Numerical values do not include a decimal point. |
| :MEASure:RESistance? | <Measured resistance, Judgment result> FAIL/ PASS/ OFF/ NG (ΩV) HI/ IN/ LO/ OFF/ NG (Ω) | Resistance measurement values consist of five digits with FAST sampling * Numerical values do not include a decimal point. | Resistance measurement values consist of four digits with FAST sampling * Numerical values do not include a decimal point. |

| Message ([] = optional) | Data Contents () = response data | Differences | |
|-----------------------------------|---|---|---|
| | | Model BT3562 (BT3562-01) | Model 3560 |
| :MEASure:VOLTage? | <Measured voltage, Judgment result> FAIL/ PASS/ OFF/ NG | Response: Mark: one character + six numerals * Numerical values do not include a decimal point. | Response: * Numerical values do not include a decimal point. |
| :FREQuency :FREQuency? | AUTO/50/60 | Setting range: AUTO/50/60 Power supply frequency setting: Support for AUTO detection | Setting range: 50/60 |
| :LOCK:KEY :LOCK:KEY? | ON/OFF | | |
| :HEADer :HEADer? | ON/OFF | | |
| :LOCK:EXTernal :LOCK:EXTernal? | ON/OFF | | |
| :CSET:BEEPPer :CSET:BEEPPer? | OFF/ PASS/ FAIL (Ω V) OFF/ IN/ HL (Ω) | | |
| :HOLD :HOLD? | ON/ OFF | | |
| :LIMit :LIMit? | ON/ OFF | (function not available) | Open terminal voltage is limited to 20 mV |
| :SENSecheck :SENSecheck? | ON/ OFF | (function not available) | Sense line disconnect detection is provided |
| :ZERoclear | | | |

Measurement Value Formats (commands compatible with Model 3560)

For the commands that acquire measurement values

(**:MEASure:BATTeRY?**, **:MEASure:RESistance?** and **:MEASure:VOLTagE?**), the response formats are as follows.

Measured Resistance

| Measurement Range | Measured Value |
|-------------------|----------------|
| 3 m Ω | *.****E-3 |
| 30 m Ω | **.*E-3 |
| 300 m Ω | ***.*E-3 |
| 3 Ω | *.****E+0 |
| 30 Ω | **.*E+0 |
| 300 Ω | ***.*E+0 |
| 3000 Ω | *.****E+3 |
| \pm OF | 1.0000E+8 |
| Measurement Fault | 1.0000E+9 |

Measured Voltage

| Measurement Range | Measured Value |
|-------------------|-----------------|
| 6 V | \pm *.****E+0 |
| 60 V | \pm **.*E+0 |
| 100 V/300 V | \pm ***.*E+0 |
| \pm OF | \pm 1.0000E+8 |
| Measurement Fault | 1.0000E+9 |

- The positive sign for measured voltage values is returned as a space character.
- The number of displayed digits is unaffected by sampling rate.

Reference: Model 3560 Measurement Value Formats

Measured Resistance

| Measurement Range | FAST | MEDIUM/ SLOW |
|-------------------|-----------|--------------|
| 30 m Ω | ***.*E-3 | ***.*E-3 |
| 300 m Ω | ***.*E-3 | ***.*E-3 |
| 3 Ω | *.****E+0 | *.****E+0 |
| 30 Ω | **.*E+0 | **.*E+0 |
| 300 Ω | ***.*E+0 | ***.*E+0 |
| 3000 Ω | *.****E+3 | *.****E+3 |
| \pm OF | 1.0000E+8 | 1.0000E+8 |
| Measurement Fault | 1.0000E+9 | 1.0000E+9 |

Measured Voltage

| Measurement Range | All sampling rates |
|-------------------|--------------------|
| 5 V | \pm *.****E+0 |
| 50 V | \pm **.*E+0 |
| \pm OF | \pm 1.0000E+8 |
| Measurement Fault | 1.0000E+9 |

8.7 Basic Data Importing Methods

Flexible data importing is available depending on the application.

Free-Run Data Importing

Initial Setup **:INITiate:CONTinuous ON** (enable continuous measurement)
 :TRIGger:SOURce IMM (internal triggering)

Importing **:FETCh?**
 Imports the most recent measurement

Importing by Host Triggering

Initial Setup **:INITiate:CONTinuous OFF** (disable continuous measurement)
 :TRIGger:SOURce IMM (internal triggering)

Importing **:READ?**
 A trigger occurs, and a measurement is taken and the result is transferred.

Importing Data by TRIG Key or $\overline{\text{TRIG}}$ Terminal

Initial Setup **:INITiate:CONTinuous OFF** (disable continuous measurement)
 :TRIGger:SOURce EXT (external triggering)

Importing **:READ?**
 When triggered by the **TRIG** key or TRIG terminal, a measurement is taken and the result is transferred.

8.8 Sample Programs

These sample programs are written in Microsoft Visual Basic® 5.0 and 6.0.

To be prepared in Visual Basic® 5.0/6.0

- The following are used for communication:
For RS-232C communication: MSComm from Visual Basic® Professional
For GP-IB communication: National Instruments GP-IB Board, Driver and Module for Visual Basic®
- During communications, the terminator setting is supposed to be as follows:
RS-232C: CR+LF
GP-IB: LF

RS-232C Communications

(Using Microsoft Visual Basic® Professional MSComm)

(1) Simple Resistance Measurement

Imports measured values 10 times, and saves measurements in a text file.

```

Private Sub MeasureSubRS()
Dim rcvstr As String           'Receiving char string
Dim i As Integer

MSComm1.Settings = "9600,n,8,1"   'Comm port setting
MSComm1.PortOpen = True          'Open a port
Open App.Path & "\data.csv" For Output As #1 'Open a text file for saving

MSComm1.Output = ":TRIG:SOUR IMM" & vbCrLf 'Select internal triggering
MSComm1.Output = ":INIT:CONT ON" & vbCrLf 'Continuous measurement ON
For i = 1 To 10
  MSComm1.Output = ":FETCH?" & vbCrLf 'Send ":FETCH?" to import the most recent mea-
                                     'surement
  rcvstr = "" 'From here on, continue receiving until an LF code
                                     'occurs

  While Right(rcvstr, 1) <> Chr(10)
    rcvstr = rcvstr + MSComm1.Input
    DoEvents
  Wend
  rcvstr = Left(rcvstr, Len(rcvstr) - 2) 'Delete the terminator (CR+LF)
  Print #1, Str(i) & ", " & rcvstr 'Write to the file
Next

Close #1
MSComm1.PortOpen = False
End Sub

```

(2) Measure Resistance by PC Key

Measures and imports by key input on the PC, and saves measurements in a text file.

```

Private Sub MeasureReadSubRS()
Dim recvstr As String           'Receiving char string
Dim i As Integer

MSComm1.Settings = "9600,n,8,1" 'Comm port setting
MSComm1.PortOpen = True        'Open a port
Open App.Path & "data.csv" For Output As #1 'Open a text file for saving

MSComm1.Output = ":TRIG:SOUR IMM" & vbCrLf 'Select internal triggering
MSComm1.Output = ":INIT:CONT OFF" & vbCrLf 'Continuous measurement OFF
For i = 1 To 10
    'Wait for PC key input
    'Create a key input check routine to set InputKey() = True when a key is pressed
    Do While 1
        If InputKey() = True Then Exit Do
        DoEvents
    Loop

    'After confirming key input, measure once, and read the measured value
    MSComm1.Output = ":READ?" & vbCrLf 'Send ":READ?" to measure and import the mea-
                                        'surement
    recvstr = "" 'From here on, continue receiving until an LF code
                                        'occurs

    While Right(recvstr, 1) <> Chr(10)
        recvstr = recvstr + MSComm1.Input
        DoEvents
    Wend
    recvstr = Left(recvstr, Len(recvstr) - 2) 'Delete the terminator (CR+LF)
    Print #1, Str(i) & ", " & recvstr 'Write to the file
Next

Close #1
MSComm1.PortOpen = False
End Sub

```

(3) External Trigger Measurement 1

Measure and import according to external triggering of the instrument (**TRIG** key or EXT I/O TRIG terminal input) and save measurements in a text file.

```

Private Sub MeasureTrigSubRS()
Dim recvstr As String           'Receiving char string
Dim i As Integer

MSComm1.Settings = "9600,n,8,1" 'Comm port setting
MSComm1.PortOpen = True       'Open a port
Open App.Path & "\data.csv" For Output As #1 'Open a text file for saving

MSComm1.Output = ":TRIG:SOUR EXT" & vbCrLf 'Select external triggering
MSComm1.Output = ":INIT:CONT OFF" & vbCrLf 'Continuous measurement OFF
For i = 1 To 10
  MSComm1.Output = ":READ?" & vbCrLf 'Send ":READ?" to measure and import the mea-
                                     'surement

  recvstr = "" 'From here on, continue receiving until an LF code
               'occurs

  While Right(recvstr, 1) <> Chr(10)
    recvstr = recvstr + MSComm1.Input
    DoEvents
  Wend
  recvstr = Left(recvstr, Len(recvstr) - 2) 'Delete the terminator (CR+LF)
  Print #1, Str(i) & ", " & recvstr 'Write to the file
Next

Close #1
MSComm1.PortOpen = False
End Sub

```

(4) External Trigger Measurement 2

Measure and import according to external triggering of the instrument (**TRIG** key or EXT I/O TRIG terminal input), and save measurements in a text file.

(The instrument imports the most recent measurement by trigger input timing with the continuous measurement state)

```

Private Sub MeasureTrig2SubRS()
Dim recvstr As String           'Receiving char string
Dim i As Integer

MSComm1.Settings = "9600,n,8,1"   'Comm port setting
MSComm1.PortOpen = True         'Open a port
Open App.Path & "data.csv" For Output As #1 'Open a text file for saving

MSComm1.Output = ":TRIG:SOUR IMM" & vbCrLf 'Select internal triggering
MSComm1.Output = ":INIT:CONT ON" & vbCrLf 'Continuous measurement ON

'Clear confirmation of External I/O TRIG input
MSComm1.Output = ":IO:IN?" & vbCrLf
recvstr = ""
While Right(recvstr, 1) <> Chr(10)
    recvstr = recvstr + MSComm1.Input
    DoEvents
Wend

For i = 1 To 10
    'Wait for External I/O TRIG input
    Do While 1
        MSComm1.Output = ":IO:IN?" & vbCrLf
        recvstr = ""
        While Right(recvstr, 1) <> Chr(10)
            recvstr = recvstr + MSComm1.Input
            DoEvents
        Wend
        If Left(recvstr, 1) = "1" Then Exit Do
        DoEvents
    Loop

    MSComm1.Output = ":FETCH?" & vbCrLf 'Send ":FETCH?" to import the most recent measurement

    recvstr = "" 'From here on, continue receiving until an LF code occurs

    While Right(recvstr, 1) <> Chr(10)
        recvstr = recvstr + MSComm1.Input
        DoEvents
    Wend
    recvstr = Left(recvstr, Len(recvstr) - 2) 'Delete the terminator (CR+LF)
    Print #1, Str(i) & ", " & recvstr 'Write to the file
Next

Close #1
MSComm1.PortOpen = False
End Sub

```

(5) Set Measurement State

Sets up the measurement setting state.

```
'Function: ΩV
'Range: 300 mΩ
'Sampling: SLOW
'Triggering: Internal
'Comparator: ON, Beeper HL,
    Resistance High/Low mode, Upper threshold 20000 (200.00 mΩ), Lower threshold 10000 (100.00 mΩ)
    Voltage REF/%, Reference value 150000 (15.0000 V), toTolerance 0.1%

Private Sub SettingsSubRS()
MSComm1.Settings = "9600,n,8,1"           'Comm port setting
MSComm1.PortOpen = True                  'Open a port

MSComm1.Output = ":FUNC RV" & vbCrLf    'Select ΩV mode
MSComm1.Output = ":RES:RANG 300E-3" & vbCrLf 'Select 300 mΩ range
MSComm1.Output = ":SAMP:RATE SLOW" & vbCrLf 'Select SLOW sampling
MSComm1.Output = ":TRIG:SOUR IMM" & vbCrLf 'Select internal triggering
MSComm1.Output = ":INIT:CONT ON" & vbCrLf 'Continuous measurement ON
MSComm1.Output = ":CALC:LIM:BEEP HL" & vbCrLf 'From here on, comparator settings
MSComm1.Output = ":CALC:LIM:RES:MODE HL" & vbCrLf
MSComm1.Output = ":CALC:LIM:RES:UPP 20000" & vbCrLf
MSComm1.Output = ":CALC:LIM:RES:LOW 10000" & vbCrLf
MSComm1.Output = ":CALC:LIM:VOLT:MODE REF" & vbCrLf
MSComm1.Output = ":CALC:LIM:VOLT:REF 150000" & vbCrLf
MSComm1.Output = ":CALC:LIM:VOLT:PERC 0.1" & vbCrLf
MSComm1.Output = ":CALC:LIM:STAT ON" & vbCrLf 'Comparator ON

MSComm1.PortOpen = False
End Sub
```

GP-IB Communications

(Using National Instruments GP-IB Board)

(1) Simple Resistance Measurement

Imports measured values 10 times, and saves measurements in a text file.

| | |
|---|---|
| Private Sub MeasureSub() | |
| Dim buffer As String * 40 | 'Receiving butter |
| Dim recvstr As String | 'Receiving char string |
| Dim pad As Integer | 'Controller access |
| Dim gpibad As Integer | 'Device Address |
| Dim timeout As Integer | 'Timeout period |
| Dim ud As Integer | 'State (unused) |
| Dim i As Integer | |
| | |
| pad = 0 | 'Board Address 0 |
| gpibad = 1 | 'BT3562-01, BT3563-01 Address 1 |
| timeout = T10s | 'Timeout about 10s |
| | |
| Call ibfind("gpib0", 0) | 'Initialize GP-IB |
| Call ibdev(pad, gpibad, 0, timeout, 1, 0, ud) | |
| Call SendIFC(pad) | |
| Open App.Path & "\data.csv" For Output As #1 | 'Open a text file for saving |
| | |
| Call Send(pad, gpibad, ":TRIG:SOUR IMM", NLEnd) | 'Select internal triggering |
| Call Send(pad, gpibad, ":INIT:CONT ON", NLEnd) | 'Continuous measurement ON |
| For i = 1 To 10 | |
| Call Send(pad, gpibad, ":FETCH?", NLEnd) | 'Send ":FETCH?" to import the most recent measurement |
| Call Receive(pad, gpibad, buffer, STOPend) | 'Receive |
| recvstr = Left(buffer, InStr(1, buffer, Chr(10)) - 1) | |
| Print #1, Str(i) & ", " & recvstr | 'Write to the file |
| Next | |
| | |
| Close #1 | |
| Call ibonl(pad, 0) | |
| End Sub | |

(2) Measure Resistance by PC Key

Measures and imports by key input on the PC, and saves measurements in a text file.

```

Private Sub MeasureReadSub()
Dim buffer As String * 40           'Receiving buffer
Dim recvstr As String              'Receiving char string
Dim pad As Integer                 'Controller access
Dim gpibad As Integer              'Device Address
Dim timeout As Integer             'Timeout period
Dim ud As Integer                  'State (unused)
Dim i As Integer

pad = 0                             'Board Address 0
gpibad = 1                          'BT3562-01, BT3563-01 Address 1
timeout = T10s                       'Timeout about 10s

Call ibfind("gpib0", 0)              'Initialize GP-IB
Call ibdev(pad, gpibad, 0, timeout, 1, 0, ud)
Call SendIFC(pad)
Open App.Path & "\data.csv" For Output As #1 'Open a text file for saving

Call Send(pad, gpibad, ":TRIG:SOUR IMM", NLEnd) 'Select internal triggering
CCall Send(pad, gpibad, ":INIT:CONT OFF", NLEnd) 'Continuous measurement OFF
For i = 1 To 10
  'Wait for PC key input
  'Create a key input check routine to set InputKey() = True when a key is pressed
  Do While 1
    If InputKey() = True Then Exit Do
    DoEvents
  Loop

  'After confirming key input, measure once, and read the measured value
  Call Send(pad, gpibad, ":READ?", NLEnd) 'Send ":READ?" to measure and import the measurement
  'Receive
  Call Receive(pad, gpibad, buffer, STOPend)
  recvstr = Left(buffer, InStr(1, buffer, Chr(10)) - 1)
  Print #1, Str(i) & ", " & recvstr 'Write to the file
Next

Close #1
Call ibonl(pad, 0)
End Sub

```

(3) External Trigger Measurement 1

Measure and import according to external triggering of the instrument (**TRIG** key or EXT I/O TRIG terminal input), and save measurements in a text file.

```

Private Sub MeasureTrigSub()
Dim buffer As String * 40           'Receiving butter
Dim recvstr As String             'Receiving char string
Dim pad As Integer                'Controller access
Dim gpibad As Integer            'Device Address
Dim timeout As Integer           'Timeout period
Dim ud As Integer                'State (unused)
im i As Integer

pad = 0                           'Board Address 0
gpibad = 1                        'BT3562-01, BT3563-01 Address 1
timeout = T100s                   'Timeout 100s (because of external trigger wait
                                  state)

Call ibfind("gpib0", 0)           'Initialize GP-IB
Call ibdev(pad, gpibad, 0, timeout, 1, 0, ud)
Call SendIFC(pad)
Open App.Path & "\data.csv" For Output As #1 'Open a text file for saving

Call Send(pad, gpibad, ":TRIG:SOUR EXT", NLEnd) 'Select external triggering
Call Send(pad, gpibad, ":INIT:CONT OFF", NLEnd) 'Continuous measurement OFF
For i = 1 To 10
  Call Send(pad, gpibad, ":READ?", NLEnd) 'Send ":READ?" to measure and import the mea-
                                          surement
  Call Receive(pad, gpibad, buffer, STOPend) 'Receive
  recvstr = Left(buffer, InStr(1, buffer, Chr(10)) - 1)
  Print #1, Str(i) & ", " & recvstr 'Write to the file
Next

Close #1
Call ibonl(pad, 0)
End Sub

```

(4) External Trigger Measurement 2

Measure and import according to external triggering of the instrument (**TRIG** key or EXT I/O TRIG terminal input), and save measurements in a text file.

(The instrument imports the most recent measurement by trigger input timing with the continuous measurement state)

```

Private Sub MeasureTrig2Sub()
Dim buffer As String * 40           'Receiving buffer
Dim rcvstr As String               'Receiving char string
Dim pad As Integer                 'Controller access
Dim gpibad As Integer              'Device Address
Dim timeout As Integer             'Timeout period
Dim ud As Integer                  'State (unused)
Dim i As Integer

pad = 0                             'Board Address 0
gpibad = 1                          'BT3562-01, BT3563-01 Address 1
timeout = T100s                      'Timeout 100s (because of external trigger wait
                                     state)

Call ibfind("gpib0", 0)              ' Initialize GP-IB
Call ibdev(pad, gpibad, 0, timeout, 1, 0, ud)
Call SendIFC(pad)
Open App.Path & "data.csv" For Output As #1 'Open a text file for saving

Call Send(pad, gpibad, ":TRIG:SOUR IMM", NLEnd) 'Select internal triggering
Call Send(pad, gpibad, ":INIT:CONT ON", NLEnd) 'Continuous measurement ON

'Clear confirmation of External I/O TRIG input
Call Send(pad, gpibad, ":IO:IN?", NLEnd)
Call Receive(pad, gpibad, buffer, STOPend)
rcvstr = Left(buffer, InStr(1, buffer, Chr(10)) - 1)
For i = 1 To 10
  'Wait for External I/O TRIG input
  Do While 1
    Call Send(pad, gpibad, ":IO:IN?", NLEnd)
    Call Receive(pad, gpibad, buffer, STOPend)
    If Left(buffer, 1) = "1" Then Exit Do
    DoEvents
  Loop

  Call Send(pad, gpibad, ":FETCH?", NLEnd) 'Send ":FETCH?" to import the most recent mea-
                                         surement
  Call Receive(pad, gpibad, buffer, STOPend) 'Receive
  rcvstr = Left(buffer, InStr(1, buffer, Chr(10)) - 1)
  Print #1, Str(i) & ", " & rcvstr        'Write to the file
Next

Close #1
Call ibonl(pad, 0)
End Sub

```

(5) Set Measurement State

Sets up the measurement setting state.

```

'Function: ΩV
'Range: 300 mΩ
'Sampling: SLOW
'Triggering: Internal
'Comparator: ON, Beeper HL,
Resistance High/Low mode, Upper threshold 20000 (200.00 mΩ), Lower threshold 10000 (100.00 mΩ)
Voltage REF/%, Reference value 150000 (15.0000 V), toTolerance 0.1%

Private Sub SettingsSub()
Dim pad As Integer           'Controller access
Dim gpibad As Integer       'Device Address
Dim timeout As Integer      'Timeout period
Dim ud As Integer           'State (unused)

pad = 0                       'Board Address 0
gpibad = 1                   'BT3562-01, BT3563-01 Address 1
timeout = T10s              'Timeout about 10s

Call ibfind("gpib0", 0)      'Initialize GP-IB
Call ibdev(pad, gpibad, 0, timeout, 1, 0, ud)
Call SendIFC(pad)

Call Send(pad, gpibad, ":FUNC RV", NLEnd)      'Select ΩV mode
Call Send(pad, gpibad, ":RES:RANG 300E-3", NLEnd) 'Select 300 mΩ range
Call Send(pad, gpibad, ":SAMP:RATE SLOW", NLEnd) 'Select SLOW sampling
Call Send(pad, gpibad, ":TRIG:SOUR IMM", NLEnd)  'Select internal triggering
Call Send(pad, gpibad, ":INIT:CONT OFF", NLEnd)  'Continuous measurement OFF
Call Send(pad, gpibad, ":CALC:LIM:BEEP HL", NLEnd) 'From here on, comparator settings
Call Send(pad, gpibad, ":CALC:LIM:RES:MODE HL", NLEnd)
Call Send(pad, gpibad, ":CALC:LIM:RES:UPP 20000", NLEnd)
Call Send(pad, gpibad, ":CALC:LIM:RES:LOW 10000", NLEnd)
Call Send(pad, gpibad, ":CALC:LIM:VOLT:MODE REF", NLEnd)
Call Send(pad, gpibad, ":CALC:LIM:VOLT:REF 150000", NLEnd)
Call Send(pad, gpibad, ":CALC:LIM:VOLT:PERC 0.1", NLEnd)
Call Send(pad, gpibad, ":CALC:LIM:STAT ON", NLEnd) 'Comparator ON

Call ibonl(pad, 0)
End Sub

```

To be prepared in Visual Basic® 2005

This section describes an example of how to use the Windows® development language Visual Basic®2005 Express Edition to operate the BT3562 unit from a PC via RS-232C, incorporate measurement values, and save measurement values to a file.

Creation Procedure(Visual Basic® 2005)

This section describes the procedure for using Visual Basic®2005 to create programs.

NOTE

Depending on the environment of the PC and Visual Basic®2005, the procedure may differ slightly from the one described here. For a detailed explanation on how to use Visual Basic®2005, refer to the instruction manual or Help of Visual Basic®2005.

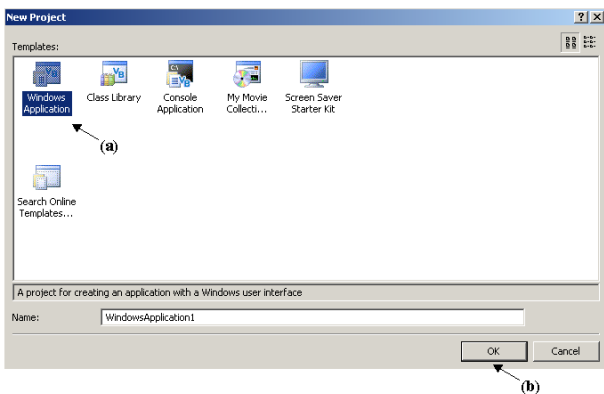

1. Startup Visual Basic®2005, select [**Windows Application**] from [**File**] - [**New Project**] (a), and click the "OK" button (b).

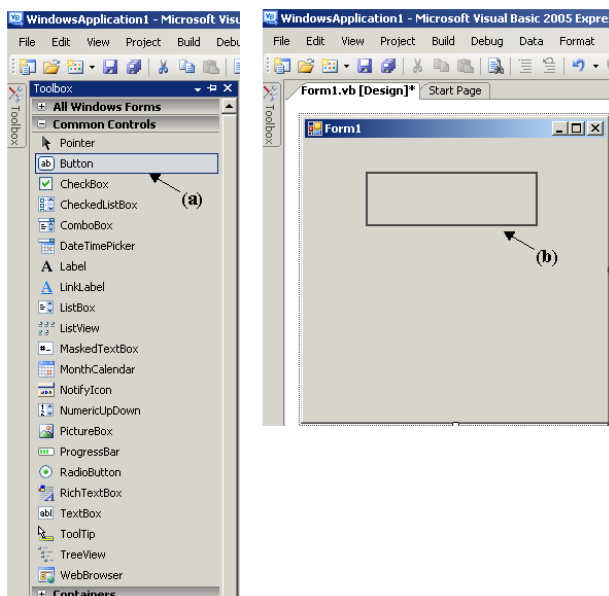

2. Click on the common control [**Button**] icon (a), and then drag the mouse over the form layout window (b) to insert the button.

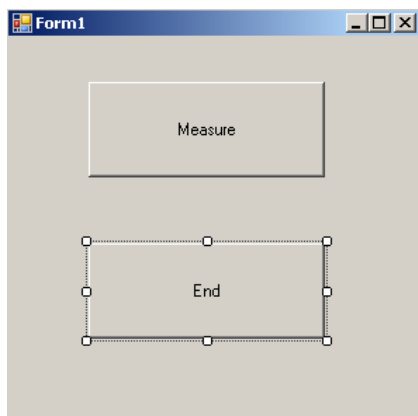

3. Use the method in step 2 to create another button, and edit the text in the property window of each button to appear as in the diagram.

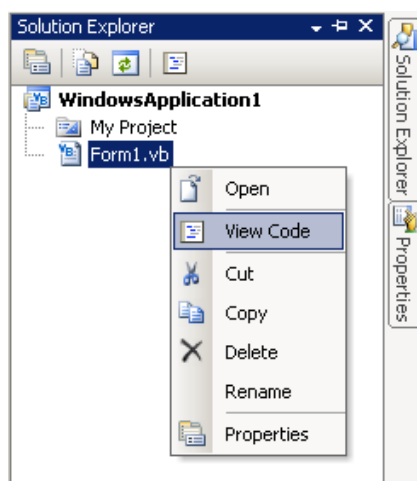

4. Right-click above [**Form1**] in the solution explorer, and select [**View Code**].

Follow the procedure below so that the Visual Basic®2005 window becomes as shown in the diagram below.

Write a program referring to " [Sample Programs\(Visual Basic® 2005\)](#)" (p.178), and execute the

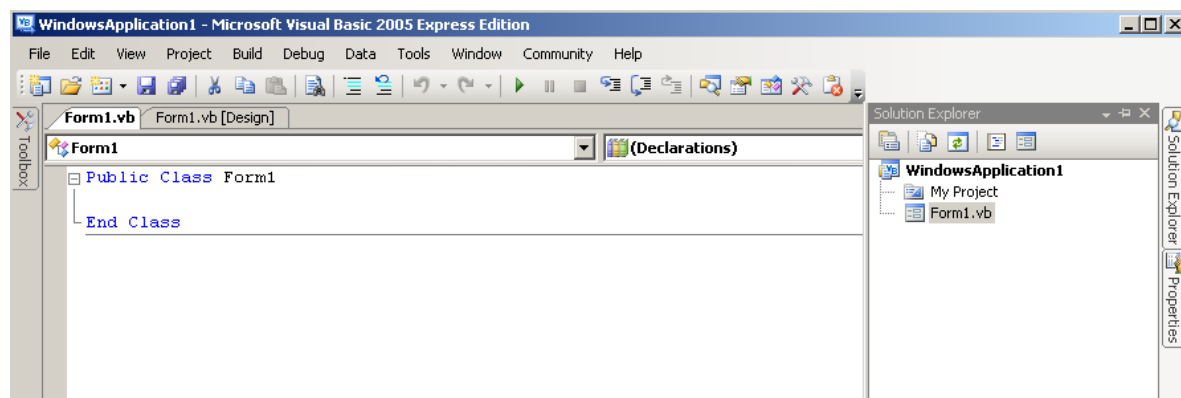

Sample Programs(Visual Basic® 2005)

Shown below is a sample program which uses Visual Basic®2005 to enact RS-232C communication, set the measurement conditions, read measurement results and then save them to file. The sample program will be written in the following manner.

" [Creation Procedure\(Visual Basic® 2005\)" \(p.176\)](#) description

..... Write using sample program
 Button created to begin measurementButton1
 Button created to close applicationButton2
 When the [Begin Measurement] is pressed, takes 10 measurements and writes the measurement values to a [data.csv] file.

When the [Quit] button is pressed the program closes.

The following program is written entirely in [Form1] code.

```
Imports System
Imports System.IO
Imports System.IO.Ports

Public Class Form1
'Perform process when Button1 is pressed
Private Sub Button1_Click(ByVal sender As System.Object, ByVal e As System.EventArgs) Handles Button1.Click
Dim recvstr As String
    Dim i As Integer

    Try
        Button1.Enabled = False                'Disable buttons during communication ..... (a)
        Button2.Enabled = False
        Dim sp As New SerialPort("COM1", 9600, Parity.None, 8, StopBits.One) 'Communication port setting ... (b)
        sp.NewLine = vbCrLf                    'Terminator setting ..... (c)
        sp.ReadTimeout = 2000                  '2 second time out ..... (d)
        sp.Open()                              'Open port
        SendSetting(sp)                        'BT3562-01 or BT3563-01 settings
        FileOpen(1, "data.csv", OpenMode.Output) 'Create text file to be saved ..... (e)
        For i = 1 To 10
            sp.WriteLine("*FETCH?")           'Begin measurement and read measurement
                                                results command ..... (f)

            recvstr = sp.ReadLine()           'Read measurement results
            PrintLine(1, recvstr)             'Write to file
        Next i
        FileClose(1)                           'Close file
        sp.Close()                             'Close port
        Button1.Enabled = True
        Button2.Enabled = True
    Catch ex As Exception
        MessageBox.Show(ex.Message, "Error", MessageBoxButtons.OK, MessageBoxIcon.Error)
    End Try
End Sub

'Set measurement conditions
Private Sub SendSetting(ByVal sp As SerialPort)
    Try
        sp.WriteLine(":TRIG:SOUR IMM")        'Select internal triggering
        sp.WriteLine(":INIT:CONT ON")        'Continuous measurement ON
    Catch ex As Exception
        MessageBox.Show(ex.Message, "Error", MessageBoxButtons.OK, MessageBoxIcon.Error)
    End Try
End Sub

'Close program when Button2 is pressed
Private Sub Button2_Click(ByVal sender As System.Object, ByVal e As System.EventArgs) Handles Button2.Click
Me.Dispose()
End Sub
End Class
```

- (a) This makes it so that during communication the [Begin Measurement] and [Close] buttons cannot be pressed.
- (b) Matches communication conditions and the computer usage conditions.
 - The port to be used on the computer: 1
 - Transmission speed: 9600 bps
 - Parity: none
 - Data length: 8 bit
 - Stop bit: 1bit
- (c) Sets CR + LF as the terminator indicating the end of the sending and receiving character string.
- (d) Sets the reading operation time to 2 seconds.
- (e) Opens the "data.csv" file. However, if a file with this name already exists, the previous "data.csv" will be deleted and a new file created.
- (f) Sends the command to perform one measurement and return that measurement result to the computer.

Specifications

Chapter 9

9.1 Basic Specifications

Measurement Items

| | | |
|--------------------------------|---|--|
| Measurement items | Resistance and voltage | |
| Resistance measurement method | AC four-terminal method | |
| Measurement current frequency | 1 kHz | |
| Resistance measurement range | BT3561A: 0 Ω to 3.1 k Ω (minimum resolution 1 $\mu\Omega$) BT3562A, BT3562, BT3563A, BT3563: 0 Ω to 3.1 k Ω (minimum resolution 0.1 $\mu\Omega$) | |
| Voltage measurement range | BT3561A, BT3562: 0 V DC to ± 60 V DC (minimum resolution 10 μV) BT3562A: 0 V DC to ± 100 V DC (minimum resolution 10 μV) BT3563A, BT3563: 0 V DC to ± 300 V DC (minimum resolution 10 μV) | |
| Measurement modes | Ω V mode | (Resistance and voltage measurement) |
| | Ω mode | (Resistance measurement) |
| | V mode | (Voltage measurement) |
| Rated input voltage | BT3561A, BT3562: ± 60 V DC BT3562A: ± 100 V DC BT3563A, BT3563: ± 300 V DC | |
| Maximum rated voltage to earth | BT3561A: | ± 60 V DC |
| | BT3562: | ± 70 V DC anticipated transient overvoltage 330 V |
| | BT3562A: | ± 100 V DC anticipated transient overvoltage 500 V |
| | BT3563A, BT3563: | ± 300 V DC anticipated transient overvoltage 1500 V |
| Input impedance | 3 m Ω to 300 m Ω ranges: 90 k Ω 3 Ω to 3000 Ω ranges: 1 M Ω | |
| Open-terminal voltage | 3 m Ω and 30 m Ω ranges: 25 V peak 300 m Ω range: 7 V peak 3 Ω to 3000 Ω ranges: 4 V peak | |

Measurement Ranges

| | |
|------------------------|---|
| Resistance measurement | BT3561A: 30 m Ω / 300 m Ω / 3 Ω / 30 Ω / 300 Ω / 3000 Ω 6 ranges BT3562A, BT3562, BT3563A, BT3563: 3 m Ω / 30 m Ω / 300 m Ω / 3 Ω / 30 Ω / 300 Ω / 3000 Ω 7 ranges |
|------------------------|---|

Measurement Ranges

| | |
|---------------------|--|
| Voltage measurement | BT3561A, BT3562 : 6 V/ 60 V 2 ranges BT3562A : 6 V/ 60 V/ 100 V 3 ranges BT3563A, BT3563 : 6 V/ 60 V/ 300 V 3 ranges |
|---------------------|--|

| | |
|---------------------|---|
| Auto-range function | Yes (applies to both resistance and voltage measurement.) |
|---------------------|---|

Measurement Value Display

| | |
|---------------------|---|
| Display count value | Resistance measurement : “-1000 to 31000” Voltage measurement : “-600000 to 600000” (6 V/ 60 V ranges) “-100000 to 100000” (100 V range) “-300000 to 300000” (300 V range) |
|---------------------|---|

| | |
|------------------|--|
| Overflow display | OF indicates a measurement exceeds display count value -OF indicates a measurement is below display count value |
|------------------|--|

| | |
|---|---|
| Measurement fault detection (contact check) | Detected information: SOURCE HIGH-LOW connection faults SENSE HIGH-LOW connection faults Display: “- - - -” |
|---|---|

Sampling Time

| | |
|---------------|--|
| Sampling rate | EX.FAST/ FAST/ MEDIUM/ SLOW (four steps) |
|---------------|--|

Sampling time

| Sampling | EX.FAST | FAST | MEDIUM | SLOW |
|-------------------------------|---------|-------|----------------|------------------|
| ΩV (50 Hz) (60 Hz) | 8 ms | 24 ms | 84 ms 70 ms | 259 ms 253 ms |
| Ω (50 Hz) (60 Hz) | 4 ms | 12 ms | 42 ms 35 ms | 157 ms 150 ms |
| V (50Hz) (60Hz) | 4 ms | 12 ms | 42 ms 35 ms | 157 ms 150 ms |

- Tolerance for SLOW sampling is ± 5 ms, and ± 1 ms for other sampling rates
- Values within parentheses are power supply frequency settings
- * When the measurement current mode is set to pulse while using the instrument with an external trigger source or with continuous measurement set to "Off," 1 ms is added for ΩV function measurement, and 4 ms is added for Ω function and V function measurement.

Response Time

| | |
|---------------|---|
| Response time | Measurement response time: Approx. 10 ms The time from the moment the probes contact the test object in the open state until the signal stabilizes within the measurement accuracy in the internal measurement circuit (analog response time) *Response time is given as a reference value based on pure resistance measurement. Actual values depend on the impedance characteristics of the object being measured. |
|---------------|---|

| | |
|------------------------|--|
| Total measurement time | Overall time required for measurement: Response time + Sampling time |
|------------------------|--|

Zero-Adjustment

| | |
|--------------------------|---|
| Zero-adjustment function | <ul style="list-style-type: none"> Zero-adjustment setting ON/ OFF (Common to both resistance and voltage) Zero-adjustment clear Turns zero-adjustment off and clears all zero-adjustment offset data |
| Zero-adjustment range | Resistance measurement : -1000 to 1000 counts Voltage measurement : -1000 to 1000 counts |

Self-Calibration

| | |
|------------------|---|
| Calibration mode | AUTO/ MANUAL |
| AUTO | Executes automatically once every 30 minutes |
| MANUAL | Executes manually by EXT I/O signal or remote command |

* When SLOW sampling is selected, self-calibration is performed upon each measurement. In this state, the calibration mode setting is ignored.

Trigger

| | |
|----------------|--------------------|
| Trigger source | Internal/ External |
|----------------|--------------------|

Measurement current control

| | |
|--------------------------|-------------------|
| Measurement current mode | Pulse/ Continuous |
|--------------------------|-------------------|

* When using the instrument with an external trigger source or with continuous measurement set to "Off," application of the measurement current can be limited to when measurement is being performed. (This functionality is designed to prevent interference caused by measurement currents when using multiple instruments simultaneously.)

Delay

| | |
|----------------|----------------|
| Delay function | ON/ OFF |
| Delay time | 0 to 9.999 sec |

Averaging

| | |
|---------------------------|--|
| Averaging function | ON/ OFF |
| No. of samples to average | 2 to 16 times |
| Averaging method | Moving average with internal triggering, and simple average with external triggering |

Comparator

| | |
|---------------------|---|
| Comparator function | ON/ OFF (Common to both resistance and voltage) |
|---------------------|---|

Comparator

| | | | | | | | |
|--------------------|--|----|-------------|-----|-------------|-------------------|---------------------------------|
| Comparator setting | <p>Comparator execution mode: HIGH, LOW / REF, % Upper and lower threshold: 0 to 99999 (Resistance)/ 0 to 999999 (Voltage) Reference value and tolerance: 0 to 99999 (Resistance)/ 0 to 999999 (Voltage) %: 0.000% to 99.999% (percentage range setting applies to both positive and negative values) Comparator judgment beeper: OFF/ HIGH, LOW / IN/ ALL Operating mode: AUTO/ MANUAL * Measurement value or statistical 3σ (population standard deviation \times 3) can be set as upper threshold or reference values.</p> | | | | | | |
| Judgment | <p>Judgment result: Hi/ IN/ Lo (resistance and voltage judged independently) Calculates the logical AND of resistance and voltage judgment results and outputs a PASS/FAIL judgment (EXT I/O output). Measurement fault value judgments:</p> <table border="0"> <tr> <td>OF</td> <td>Hi judgment</td> </tr> <tr> <td>-OF</td> <td>Lo judgment</td> </tr> <tr> <td>Measurement fault</td> <td>Not judged (no judgment result)</td> </tr> </table> <p>* The voltage measurement value can be judged as an absolute value.</p> | OF | Hi judgment | -OF | Lo judgment | Measurement fault | Not judged (no judgment result) |
| OF | Hi judgment | | | | | | |
| -OF | Lo judgment | | | | | | |
| Measurement fault | Not judged (no judgment result) | | | | | | |

Statistical Calculation

| | |
|-------------------------|---|
| Statistical calculation | ON/ OFF/ Clear Auto-clear after printing statistical data |
| Calculations | Total data counts, Valid data counts, Maximum, Minimum, Mean, Standard deviation, Population standard deviation and Process capability indices (Cp and CpK) |
| Calculations trigger | Statistical calculation of measured values initiated by EXT I/O signals, key or remote command |

Measurement Memory and Batch Download Functions

| | |
|-----------------------------------|---|
| Measurement memory | ON/ OFF/ Clear |
| Memory trigger | <p>Up to 400 measurement values can be stored in internal memory by EXT I/O signals, key or remote command. Stored measurement values can be batch downloaded by remote command. * Data stored in memory cannot be displayed on the instrument.</p> |
| Measurement value output function | <p>Outputs measured values via the RS-232C interface upon triggering. Outputs measured values via the RS-232C or LAN interface upon triggering. (Only for the BT3561A, BT3562A, and BT3563A)</p> |

Key-Lock

| | |
|----------|---|
| Key-lock | ON/ OFF Key operations are disabled when ON. |
|----------|---|

Power Supply Frequency

| | |
|--------------------------------|---|
| Power supply frequency setting | AUTO (automatic selection of 50 Hz/ 60 Hz) / 50 Hz/ 60 Hz |
|--------------------------------|---|

Panel Save

| | |
|----------------------|--|
| Panel save function | Measurement configurations can be saved and reloaded by specifying a Panel number |
| No. of panel to save | 126 |
| Saved settings | Measurement mode, Resistance measurement range, Voltage measurement range, Auto-ranging setting, Zero-adjust on/off setting and value, Sampling rate, Trigger source, Delay setting, Averaging setting, Comparator setting, Statistical calculation setting, Switching display setting, and Key-lock setting |

Reset

| | |
|-------|--|
| Reset | Reset/ System reset * System Reset also initializes Panel Save data |
|-------|--|

Display Device

| | |
|----------------|-----|
| Display device | LED |
|----------------|-----|

External Interfaces

| | |
|-------------------------|--|
| EXT I/O | <p>Input: Optocoupler-isolated, no-voltage contacts (dielectric strength of 30 V DC)</p> <p>Output: Optocoupler-isolated, Nch Open drain output, 30 V DC, 50 mA max.</p> <p>Input signals: Measurement start trigger, print, zero-adjustment, calibration, manual comparator and panel load (7 bit)</p> <p>Output signals: End-of-measurement, End measurement, Comparator result (resistance Hi/ IN/ Lo, voltage Hi/ IN/ Lo, PASS/FAIL)</p> <p>Service power supply output: Voltage 4.5 V to 5 V C_{rent} 100 mA max. Isolation Isolated from the protective ground potential and the measurement circuit. Isolation rating; Input-to-ground voltage of 50 V DC, 30 V AC rms, 42.4 V AC peak or less</p> <p>* EXT I/O control (input) can be disabled by a remote command</p> |
| Communication interface | RS-232C/ Printer/ GP-IB (Only for the BT3562-01 and BT3563-01)/ LAN (Only for the BT3561A, BT3562A and BT3563A) |

External Interfaces

| | |
|--|--|
| RS-232C | Communications settings: Data length: 8 bit, stop bit: 1 bit, parity: none Baud rate: 9600 bps/ 19200 bps/ 38400 bps Flow control: none |
| Printer | Output to printer via RS-232C (multi-use) Communications settings: Data length: 8 bit, stop bit: 1 bit, parity: none Baud rate: 9600 bps |
| LAN (BT3561A, BT3562A, and BT3563A only) | The settings can be changed by accessing the instrument using a web browser. Applicable standard: IEEE802.3 Transmission method: 10BASE-T/ 100BASE-TX automatic recognition, Half/Full Duplex, Auto MDI-X Protocol: TCP/IP Connector: RJ-45 Maximum cable length: 30 m Communication description: Setting and measured value acquisition by using communications commands Settings: IP address, subnet mask, default gateway Communication command port number: 11 to 65535 (excluding 80) Default setting: IP address: 192.168.1.1 Subnet mask: 255.255.0.0 Default gateway: 0.0.0.0 (unused) Communication command port number: 23 |
| GP-IB (-01 only) | Applicable GP-IB Standards: IEEE488.2 Address: 0 to 30 Delimiter: LF/ CR+LF |
| Analog output (BT3561A, BT3562A, BT3562-01, BT3563A and BT3563-01 only) | Output: Resistance measured value (display value) Output voltage: 0 V DC (equivalent to 0 counts) to 3.1 V (equivalent to 31000 counts) Output impedance: 1 k Ω Conversion method: D/A converter No. of bits: 12 or more Output accuracy: Resistance measurement accuracy $\pm 0.2\%$ of full scale (temperature coefficient $\pm 0.02\%$ of full scale/ $^{\circ}\text{C}$) Conditions of accuracy guarantee: Temperature and humidity range: 23 \pm 5 $^{\circ}\text{C}$ (73 \pm 9 $^{\circ}\text{F}$), 80% RH or less (non-condensating) Warm-up time of at least 30 min. Response time: Resistance measurement response time + sampling time + 1 ms |

9.2 Accuracy

Guaranteed Accuracy Conditions

| | |
|--|---|
| Temperature and humidity range for guaranteed accuracy | 23 \pm 5 $^{\circ}\text{C}$ (73 \pm 9 $^{\circ}\text{F}$), 80% RH or less (non-condensating) |
| Zero-adjustment | After zero adjustment |

Guaranteed Accuracy Conditions

| | |
|-------------------|--|
| Warm-up time | At least 30 minutes |
| Self calibration | Except when using SLOW sampling, self-calibration should be executed after warm-up. Ambient temperature after self-calibration should be maintained within $\pm 2^{\circ}\text{C}$. |
| Measurement state | Measurement taken in the same set-up as was in place when zero adjustment was performed, including identical probe profile and placement. Probe profile must not be changed during measurement. |

Hioki expresses accuracy as error limit values specified in terms of percentages relative to reading and full scale, and digits.

Full scale (Maximum displayable value)

Refers to the maximum displayable value of each measurement range.

The instrument has measurement ranges whose values are equal to the maximum displayable values.

The limit values of full-scale errors are expressed in percent of full scale (% of full scale, % f.s.).

Reading (Displayed value)

Refers to the displayed value of the measuring instrument.

The limit values of reading errors are expressed in percent of reading (% of reading, % rdg.).

Digits (Resolution)

Refers to the smallest change in the indication on the digital measuring instrument, i.e., the numeral one in the rightmost place. The limit values of digit errors are expressed in terms of digits (dgt.).

Resistance Measurement

| Range | 3 m Ω ^{*1} | 30 m Ω | 300 m Ω | 3 Ω | 30 Ω | 300 Ω | 3000 Ω |
|--------------------------------|--|-------------------|-------------------|-----------------|-------------------|------------------|------------------|
| Maximum displayed values | 3.1000 m Ω | 31.000 m Ω | 310.00 m Ω | 3.1000 Ω | 31.000 Ω | 310.00 Ω | 3100.0 Ω |
| Resolution | 0.1 $\mu\Omega$ | 1 $\mu\Omega$ | 10 $\mu\Omega$ | 100 $\mu\Omega$ | 1 m Ω | 10 m Ω | 100 m Ω |
| Measured current ^{*2} | 100 mA | 100 mA | 10 mA | 1 mA | 100 μA | 10 μA | 10 μA |
| Measured current frequency | 1 kHz \pm 0.2 Hz | | | | | | |
| Accuracy ^{*3} | \pm 0.5% of reading \pm 5 digits \pm 0.5% of reading \pm 10 digits (3 m Ω Range) | | | | | | |
| Temperature coefficient | (\pm 0.05% of reading \pm 0.5 digits)/ $^{\circ}\text{C}$ (\pm 0.05% of reading \pm 1 digit)/ $^{\circ}\text{C}$ (3 m Ω Range) | | | | | | |

*1: BT3562A, BT3562, BT3563A, and BT3563 only

*2: Measurement current error within $\pm 10\%$

*3: Add \pm 3 digits for EX.FAST, or \pm 2 digits for FAST and MEDIUM sampling rates.

Add \pm 30 digits for EX.FAST, or \pm 10 digits for FAST, or \pm 5 digits for MEDIUM sampling rates (3 m Ω range).

Voltage Measurement

| Range | 6 V | 60 V | 100 V ^{*4} | 300 V ^{*5} |
|--------------------------|---|-------------------|---------------------|---------------------|
| Maximum displayed values | \pm 6.00000 V | \pm 60.0000 V | \pm 100.000 V | \pm 300.000 V |
| Resolution | 10 μV | 100 μV | 1 mV | 1 mV |
| Accuracy ^{*6} | \pm 0.01% of reading \pm 3 digits | | | |
| Temperature coefficient | (\pm 0.001% of reading \pm 0.3 digits)/ $^{\circ}\text{C}$ | | | |

*4: BT3562A only

*5: BT3563A and BT3563 only

*6: Add \pm 3 digits for EX.FAST, or \pm 2 digits for FAST and MEDIUM sampling rates.

9.3 General Specifications

| | |
|---|---|
| Operating temperature and humidity | 0 to 40°C (32 ± 104°F), 80% RH or less (non-condensating) |
| Storage temperature and humidity | -10 to 50°C (14 ± 122°F), 80% RH or less (non-condensating) |
| Temperature and humidity range for guaranteed accuracy | 23 ± 5°C (73 ± 9°F), 80% RH or less (non-condensating) |
| Period of guaranteed accuracy | 1 year |
| Operating environment | Indoors, pollution degree 2, up to 2000 m (6562 ft) ASL |
| Rated supply voltage | 100 V AC to 240 V AC (Figures reflect assumed voltage fluctuations of 10%.) (Auto selecting) Anticipated transient overvoltage: 2500 V |
| Rated supply frequency | 50 Hz/ 60 Hz |
| Power consumption | BT3562, BT3562-01, BT3563, BT3563-01: 30 VA BT3561A, BT3562A, BT3563A: 35 VA |
| Dielectric strength | 1.62 kV AC for 1 minute, Cutoff current 10 mA, between all power terminals and protective ground 3.00 kV AC for 1 minute, Cutoff current 1 mA, between all measurement terminals and Interfaces 1.62 kV AC for 1 minute, Cutoff current 1 mA, between all measurement terminals and protective ground |
| Dimensions | Approx. 215W × 80H × 295D mm (8.46"W × 3.15"H × 11.61"D) (excluding protrusions) |
| Mass | Approx. 2.4 kg (84.7 oz.) |
| Accessories | See: "Verifying Package Contents" (p.2) |
| Options | See: "Options" (p.2) |
| Applicable Standards | Safety EN61010 EMC EN61326 Class A |
| Effect of radiated radio-frequency electromagnetic field | Resistance measurement : ± 10% of reading ± 8000 digits at 10 V/m Voltage measurement : ± 0.01% of reading ± 50 digits at 10 V/m |
| Effect of conducted radio-frequency electromagnetic field | Resistance measurement : ± 0.5% of reading ± 1000 digits at 3 V Resistance measurement : ± 0.5% of reading ± 1000 digits at 10 V (BT3561A, BT3562A, and BT3563A only) |
| Product warranty period | 3 years |

Maintenance and Service

Chapter 10

10.1 Troubleshooting

- If damage is suspected, check the "Troubleshooting" section before contacting your dealer or Hioki representative.
- The fuse is housed in the power unit of the instrument. If the power does not turn on, the fuse may be blown. If this occurs, a replacement or repair cannot be performed by customers. Please contact your dealer or Hioki representative.
- If no measurement value is displayed even when the probes are shorted together, an internal fuse may have blown.
If the fuse blows, do not attempt to replace the fuse or repair the instrument: contact your dealer or Hioki representative.
- Pack the instrument so that it will not sustain damage during shipping, and include a description of existing damage. We cannot accept responsibility for damage incurred during shipping.



Never modify the instrument. Only Hioki service engineers should disassemble or repair the instrument. Failure to observe these precautions may result in fire, electric shock, or injury.

Before returning for repair.

| Symptom | Check Items | Countermeasure |
|---|---|--|
| The display does not appear when you turn the power on (main power switch or power switch). | Is the power cord disconnected? | Reconnect the power cord. |
| Keys do not operate. | Is the unit in the key-locked state? | Disable the key-lock state. See "4.7 Key-Lock Function"(p.70). |
| | Is the instrument being remotely controlled externally using GP-IB? | Set GP-IB to local. |
| | Is the instrument being remotely controlled externally using RS-232C? | Set RS-232C to local. |
| An error is displayed. | | See "10.3 Error Display"(p.191). |

| Symptom | Check Items | Countermeasure |
|-----------------------------|--|--|
| Operation is abnormal. | | External electrical noise may occasionally cause malfunctions. If operation seems abnormal, try executing a Reset. See "4.13 Reset Function"(p.76). |
| Measured value is unstable. | Are you using a two-terminal connection (is one probe pin in contact with each of the positive and negative electrodes)? | When using a two-terminal connection, the pins' contact resistance may affect the resistance value, resulting in unstable readings. Use a four-terminal connection (including contact pins). See "Appendix 1 Precautions for Making Custom Test Leads"(p.A1) |
| | Are there any metallic objects near the probes (near the battery being measured)? | When there is a metallic object near the battery being measured and probes, measured values may fluctuate as a result of induction caused by eddy currents. • Make measurements as far away from metallic objects as possible. • Twist the cable and minimize the area of the fork. See "Appendix 1 Precautions for Making Custom Test Leads"(p.A1) |
| | Is there signal noise? | • Twist cables and minimize the area of the fork (loops act as antennas and pick up noise). • Shield and ground cables. See "Appendix 1 Precautions for Making Custom Test Leads"(p.A1) |
| | Are you using multiple Model BT3562/BT3563 instruments to make simultaneous measurements? | Interference between measurement signals may cause measured values to vary. • Use the measurement current pulse output function to stagger the timing at which different instruments take readings. See "4.3 Measurement Current Pulse Output Function"(p.61) • Take care to keep probes' forked loops from overlapping (at the battery being measured). See "Appendix 1 Precautions for Making Custom Test Leads"(p.A1) • Avoid stacking the instruments on top of each other. |
| | Are you taking measurements immediately in front of the instruments? | Induced signals from the instruments' circuits can be picked up as noise, causing measured values to fluctuate. Take measurements at least 20 cm away from the instruments. |

10.2 Cleaning

To clean the instrument, wipe it gently with a soft cloth moistened with water or mild detergent. Never use solvents such as benzene, alcohol, acetone, ether, ketones, thinners or gasoline, as they can deform and discolor the case.

10.3 Error Display

| | Display | Description |
|-------|--------------------------------|---|
| Err02 | Zero-Adjust Range Error | The resistance measured value or voltage measured value prior to zero adjustment exceed 1000 digits |
| Err10 | Execution Error | The data portion of a remote command is invalid. Using the :READ? command with the :INITIATE:CONTINUOUS command set to ON will also cause the Err10 error. Set the :INITIATE:CONTINUOUS command to OFF before executing the :READ? command. |
| Err11 | Command Error | The command portion of a remote command is invalid. |
| Err90 | ROM Error | An internal program error occurred. Repair is required. |
| Err91 | RAM Error | An internal RAM error occurred. Repair is required. |
| Err92 | EEPROM (Adjustment Data) Error | Adjustment data is corrupted. Repair is required. |
| Err95 | A/D Communications Error | The A/D converter is damaged. Repair is required. |
| ----- | | <p>This indicates a measurement fault. It appears in cases of a disconnected test lead, poor probe contact or when the test object's measured value is far above the measurement range.</p> <p>The measurement fault signal is output from the ERR terminal of the EXT I/O connector. The following causes should be considered:</p> <ul style="list-style-type: none"> • A test lead may not be connected to the test object • Test object resistance may be too very large for the measurement range Example: Measuring 20 Ω with the 300 mΩ range • Any of the SOURCE-H, SOURCE-L, SENSE-H or SENSE-L leads may be disconnected or poorly connected • The probe may have a high contact resistance <p>See " Measurement Fault Detection"(p.39)</p> <ul style="list-style-type: none"> • The contact failure circuit protection fuse may have blown due to test lead damage, excessive wear, or impurities. |

License Information

Chapter 11

The device (Hioki BT3561A, BT3562A, BT3562, BT3562-01, BT3563A, BT3563, and BT3563-01) uses lwIP open-source software.

Amazon FreeRTOS

Copyright (C) 2020 Amazon.com, Inc. or its affiliates. All Rights Reserved.

Permission is hereby granted, free of charge, to any person obtaining a copy of this software and associated documentation files (the "Software"), to deal in the Software without restriction, including without limitation the rights to use, copy, modify, merge, publish, distribute, sublicense, and/or sell copies of the Software, and to permit persons to whom the Software is furnished to do so, subject to the following conditions:

The above copyright notice and this permission notice shall be included in all copies or substantial portions of the Software.

THE SOFTWARE IS PROVIDED "AS IS", WITHOUT WARRANTY OF ANY KIND, EXPRESS OR IMPLIED, INCLUDING BUT NOT LIMITED TO THE WARRANTIES OF MERCHANTABILITY, FITNESS FOR A PARTICULAR PURPOSE AND NONINFRINGEMENT. IN NO EVENT SHALL THE AUTHORS OR COPYRIGHT HOLDERS BE LIABLE FOR ANY CLAIM, DAMAGES OR OTHER LIABILITY, WHETHER IN AN ACTION OF CONTRACT, TORT OR OTHERWISE, ARISING FROM, OUT OF OR IN CONNECTION WITH THE SOFTWARE OR THE USE OR OTHER DEALINGS IN THE SOFTWARE.

lwip

lwIP is licenced under the BSD license:

Copyright (c) 2001-2004 Swedish Institute of Computer Science.
All rights reserved.

Redistribution and use in source and binary forms, with or without modification, are permitted provided that the following conditions are met:

1. Redistributions of source code must retain the above copyright notice, this list of conditions and the following disclaimer.
2. Redistributions in binary form must reproduce the above copyright notice, this list of conditions and the following disclaimer in the documentation and/or other materials provided with the distribution.
3. The name of the author may not be used to endorse or promote products derived from this software without specific prior written permission.

THIS SOFTWARE IS PROVIDED BY THE AUTHOR "AS IS" AND ANY EXPRESS OR IMPLIED WARRANTIES, INCLUDING, BUT NOT LIMITED TO, THE IMPLIED WARRANTIES OF MERCHANTABILITY AND FITNESS FOR A PARTICULAR PURPOSE ARE DISCLAIMED. IN NO EVENT SHALL THE AUTHOR BE LIABLE FOR ANY DIRECT, INDIRECT, INCIDENTAL, SPECIAL, EXEMPLARY, OR CONSEQUENTIAL DAMAGES (INCLUDING, BUT NOT LIMITED TO, PROCUREMENT OF SUBSTITUTE GOODS OR SERVICES; LOSS OF USE, DATA, OR PROFITS; OR BUSINESS INTERRUPTION) HOWEVER CAUSED AND ON ANY THEORY OF LIABILITY, WHETHER IN CONTRACT, STRICT LIABILITY, OR TORT (INCLUDING NEGLIGENCE OR OTHERWISE) ARISING IN ANY WAY OUT OF THE USE OF THIS SOFTWARE, EVEN IF ADVISED OF THE POSSIBILITY OF SUCH DAMAGE.



Appendix

Appendix 1 Precautions for Making Custom Test Leads

Bear the following in mind when making custom test leads.

- Be sure to twist together the SOURCE-H and L leads, and the SENSE-H and L leads. Also, connect the shields of all leads to the ground.

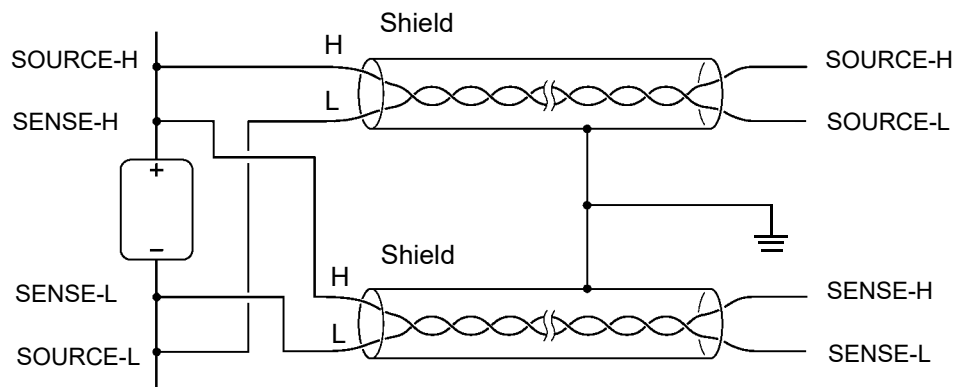

- The four-terminal design requires that all four terminals be used for measurement. Attempting to measure with two terminals (the two lines in the middle) may result in unstable or inconsistent measurements due to the effects of test lead contact resistance.

Wrong Connection

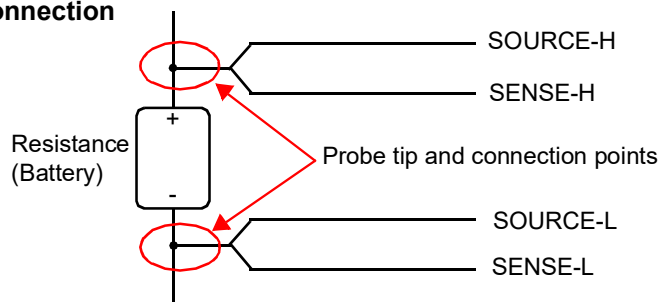

- When connecting to a test object, connect SOURCE-H and SOURCE-L toward the outside, and SENSE-H and SENSE-L toward the inside.

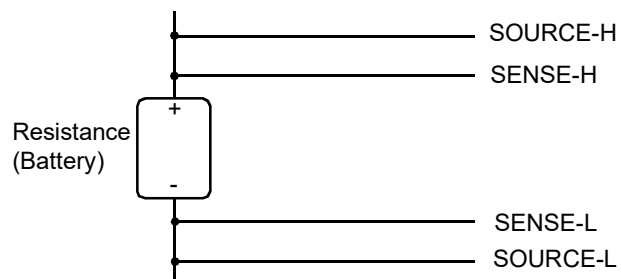

- Do not allow the test leads near metal surfaces. In particular, the lead portions that are not twisted together must be kept away from conductors to avoid unstable measurements resulting from the effects of induced current. See "Appendix 6 Effect of Eddy Currents" (p.A8).

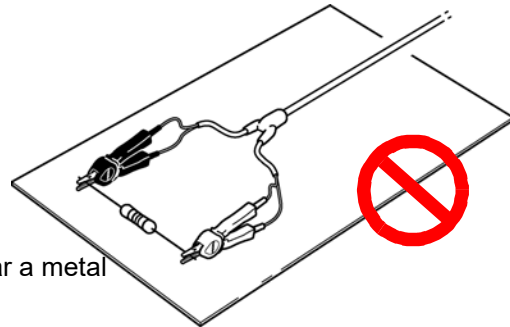

Do not place near a metal plate or frame.

- Observe the precautions illustrated in the following diagram concerning the shape and placement of measurement leads. Eddy currents and outside induced noise caused by nearby metallic objects can introduce an error component or variation into measured values, degrading repeatability. (The impact of these phenomena can be reduced as described below.)

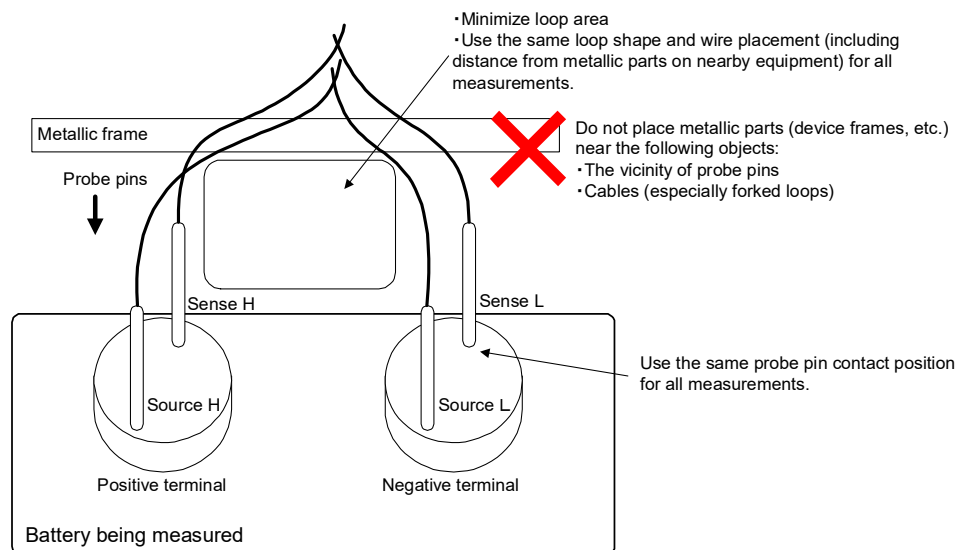

- Use the minimum necessary wire length (5 m or less). Longer wire runs are more susceptible to noise and may result in unstable measured values. The sum of the round-trip wiring resistance and measurement lead contact resistance should be $20\ \Omega$ (for $3\ \text{m}\Omega$ and $30\ \text{m}\Omega$ ranges, $2\ \Omega$) or less.
- Perform zero-adjustment prior to starting measurement. Make a zero-adjustment jig and perform the process using the same configuration (probe shape and placement) as will be used for actual measurement. Nearby metallic objects may introduce an error component (offset) to measured values due to the effects of eddy currents and other phenomena. This error component can be eliminated by performing zero-adjustment after measuring the ideal zero resistance state (using the zero-adjustment jig) for the same probe shape and placement that will be used to perform actual measurement. This is particularly important when using the $3\ \text{m}\Omega$ and $30\ \text{m}\Omega$ ranges, where the effects of eddy currents are more pronounced.
- Avoid the use of metal plates (short bars) as a zero-adjustment jig as the plate's resistance value will introduce an error component.

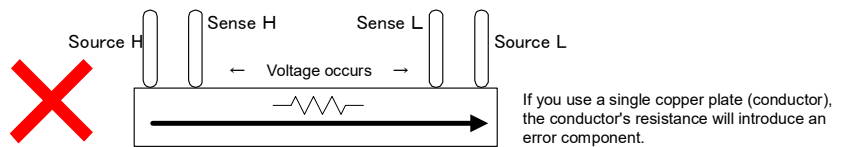
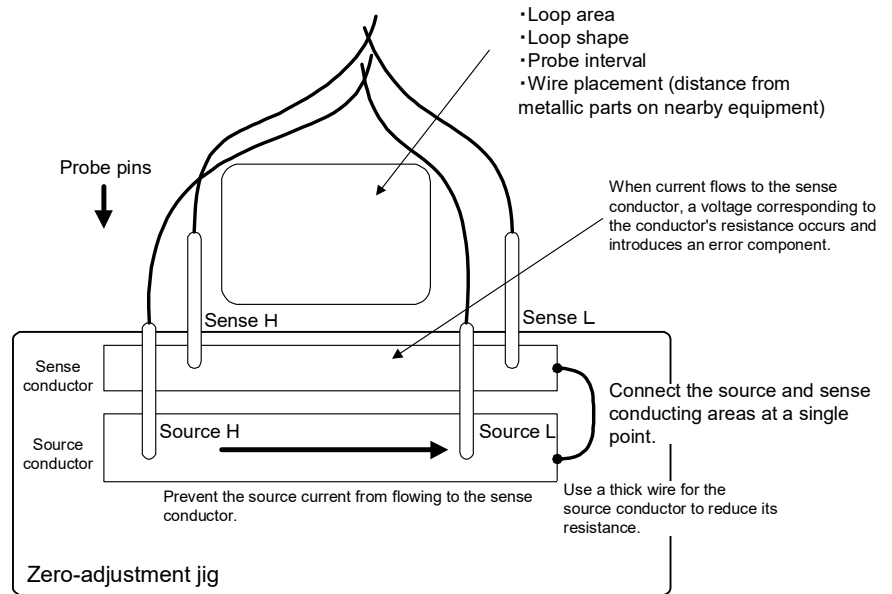

! WARNING

Do not touch the metallic tip of probes after measuring high-voltage batteries. Doing so may result in electrical shock since internal instrument components could retain a charge under those conditions. (Internal discharge time: Approx. 20 sec.)

NOTE

- When separating the tips of the optional measurement leads, take care that the SOURCE-H, SENSE-H, and SENSE-L shield wires do not come into contact with the core wires.
- When measuring high-voltage batteries, be sure to use cables with sufficient dielectric strength.
- To avoid short-circuit accidents, connect the probe's banana terminals to the instrument before connecting the probes to the battery.

Appendix 2 AC Four-terminal Method

The instrument uses the AC four-terminal method, so that resistance measurement can be carried out with the resistance of the leads and the contact resistance between the leads and the object to be measured canceled out. The following figure shows the principle of the AC four-terminal measurement method.

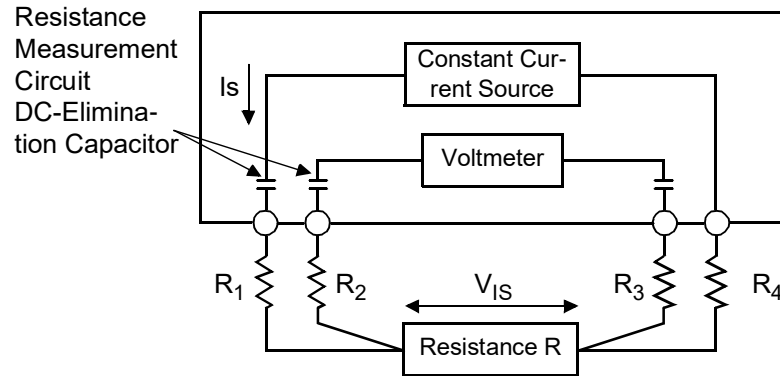

Values R_1 to R_4 are the resistances of the test leads plus contact resistances.

An AC current (I_s) is supplied from the SOURCE terminals of the instrument across the tested battery. The voltage drop across the internal impedance of the battery (V_{IS}) is measured by the SENSE terminals. At this point, since the SENSE terminals are connected to an internal voltmeter with a high impedance, almost no current flows through the resistances R_2 and R_3 which represent the lead resistances and contact resistances. As a result, there is almost no voltage drop across the resistances R_2 and R_3 . Thus the voltage drop due to the lead resistances and contact resistances is very small, and these can be canceled out. In the instrument, a synchronized wave detection system is used, whereby the internal impedance is separated into resistance and reactance, and the resistive component only displayed.

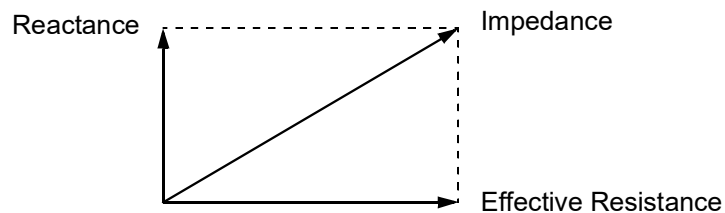

If the lead resistance, the contact resistance between measured object and lead, or the contact resistance between the lead and the instrument increases, the instrument can no longer supply normal current to the measured object, resulting in an abnormal measurement status indicated by "- - - -" within the measured resistance field. For more information on abnormal measurements, see Section " Measurement Fault Detection" (p.39).

Appendix 3 Measurement values when using four-terminal measurement (Differences in measurement values due to measurement leads used)

Depending on the subject of measurement, such as a lead-acid battery, measurement values may vary due to the measurement lead used. Since these differences in measurement values are due to the shapes and dimensions of the probes used in four-terminal measurement, measurement values taken using any probe represent the true values for that probe only.

When judging battery wear using changes in resistance values with time, be sure to use measurement leads having the same dimensions.

Reference example:(measurement of an MSE-200 valve-regulated stationary lead-acid battery)

Explanation

Differences in measurement values are physical phenomena resulting from differences in the distances (dimensions) between current-impression pins and voltage-measurement pins. The greater the battery terminal resistance in comparison to the battery's internal resistance, the more marked these differences become.

The following diagram shows how differences in voltage detected result from differences in distance when measuring a lead-acid battery.

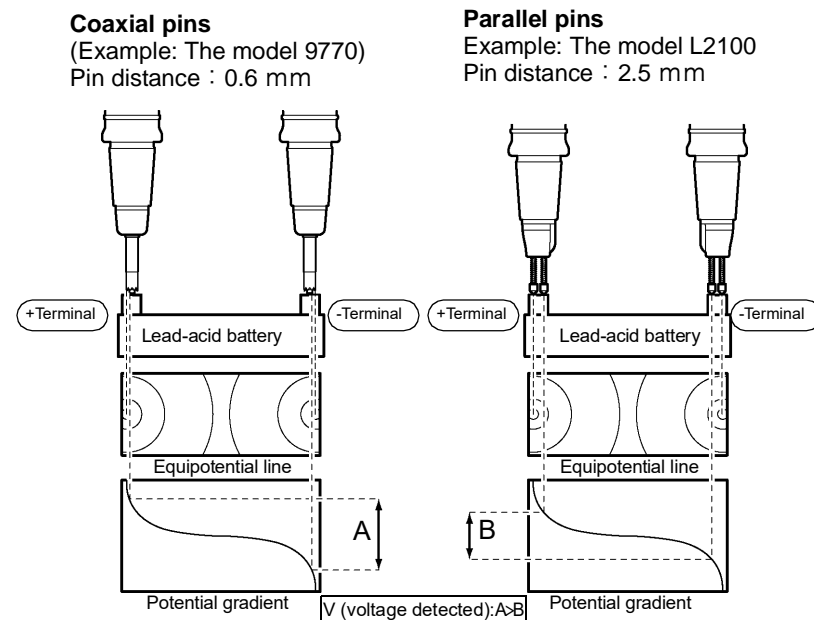

Appendix 4 Synchronous Detection System

The figure below shows an equivalent circuit for a battery. If the measured object exhibits other electrical characteristics in addition to resistance, as shown in this figure, we can use the synchronous detection system to obtain the effective resistance of the object. This synchronous detection system is also used to separate faint signals from noise.

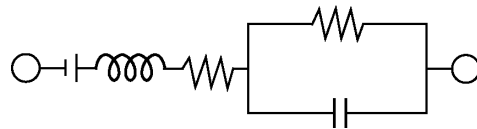

The synchronous detection system picks up the reference signal and those signals having the same phase components. The figure below gives a simplified schematic diagram of the synchronous detection system. The system consists of a multiplying circuit that multiplies two signals and a low-pass filter (LPF) that picks up only DC components from the output.

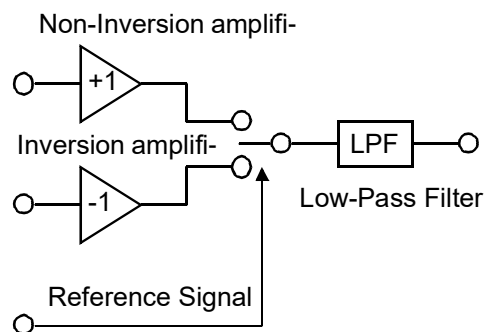

Given "v1," a reference signal voltage for the AC current generated in the instrument, and "v2," the signal voltage for use in synchronous detection, these parameters may be expressed by the equation given below. θ of v2 shows the phase difference against v1 and is generated by the reactance.

$$v1 = A \sin \omega t$$

$$v2 = B \sin (\omega t + \theta)$$

When synchronous detection is applied to both v1 and v2, they are expressed as follows:

$$v1 \times v2 = 1/2AB \cos \theta - 1/2AB \cos (2\omega t + \theta)$$

The first term indicates effective resistance. The second term is attenuated by the LPF. The instrument displays the first term.

Appendix 5 Configuration and Extension of the Test Leads

The test lead extension is normally performed by Hioki. If you want extension performed, contact your dealer or Hioki representative.

Observe the following points when extending test leads:

- Use the thickest lead available. Extend the lead only by the necessary amount.
- Maintain the AC four-terminal configuration while extending the lead. Changing the four-terminal configuration to a two-terminal configuration can result in measurement data being affected by lead resistance and/or contact resistance, resulting in inaccurate measurement.
- Make the branch section as short as possible. Try to extend the thick lead instead.
- Make sure the lead is insulated.
- While measuring, avoid as much as possible pulling or repositioning the test leads after executing zero adjustment.
- Extending test leads may result in excessive voltage drop. The total resistance of the test leads and contacts must remain below 20 Ω .
- To prevent eddy currents from affecting measurement, keep test leads away from metallic parts.
- After extending the test leads, confirm proper measurement operation and accuracy.

Reducing Induced Voltage

Since the instrument measures a minute resistance with AC power, it is affected by induced voltage. Induced voltage refers to voltage that allows the current generated in the instrument to build an inductive coupling in a lead and affect signal lines. Since the phase of the induced voltage is shifted from that of the AC current (reference signal) by 90 degrees, it can be eliminated with the synchronous detection circuit if the voltage is low. But for high levels, the induced voltage distorts the signals, causing incorrect synchronous detection. The instrument monitors induced voltage internally and generates an abnormal measurement signal if the level rises above a certain level. Reducing the length of the lead will lower induced voltage. Reducing the length of the branched section is particularly effective.

Appendix 6 Effect of Eddy Currents

The AC current generated in the instrument induces eddy currents in the surrounding metallic plates, which generate induced voltage in the test lead. Since the phase of this induced voltage is shifted from that of the AC current (reference signal) by 180 degrees, it cannot be eliminated by the synchronous detection circuit, resulting in measurement errors. The influence of eddy currents is a phenomenon unique to ohmmeters that measure resistance with AC power. To protect the test lead from such effects, keep metallic parts, including metallic plates, at a suitable distance from the test lead (branched section).

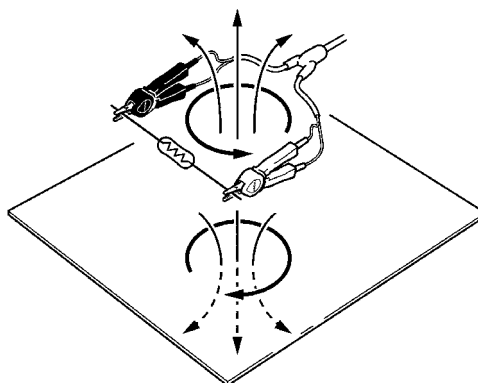

Appendix 7 Calibration Procedure

For the calibration environment, see Section "Chapter 9 Specifications" (p.181).

Calibration of the Ohmmeter

- Use the 9453 FOUR TERMINAL LEAD as the connection lead.
- Use standard resistors with excellent temperature characteristics that resist deterioration over time.
- To prevent influence by the lead, use four-terminal resistors (Non-inductive type).
- Use a resistor that will reflect the correct resistance at 1 kHz. With wire-wound resistors, the inductance element is so large that the pure resistance (DC resistance) does not equal the effective resistance (real part of impedance, displayed on the instrument).
- For connection of a standard resistor to the instrument, see the figure below.

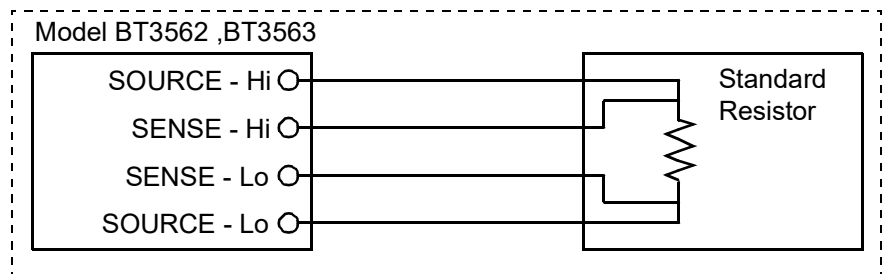

Calibration of the Voltmeter

- Use a generator that can output a DC voltage of 300 V DC.
- For connection of a generator to the instrument, see the figure below.
- Do not apply an alternating current from the instrument to the generator, as the generator may malfunction.
- Use a low-impedance voltage source.
- The instrument may not operate properly with some generators.

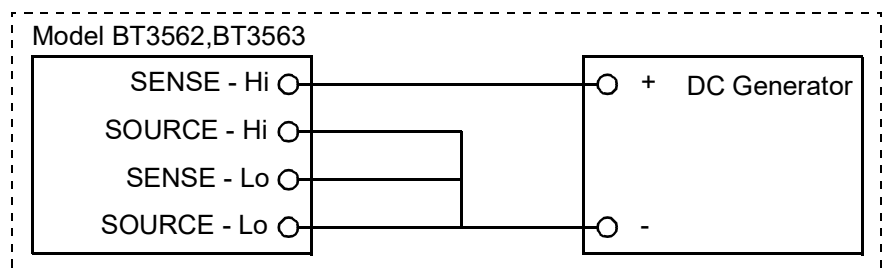

Appendix 8 Zero Adjustment

Zero adjustment is a function which adjusts the zero point by deducting the residual value obtained during $0\ \Omega$ measurement. For this reason, zero adjustment must be performed when connection is made to $0\ \Omega$. However, connecting a sample with no resistance is difficult and therefore is not practical.

In this respect, when performing the actual zero adjustment, create a pseudo connection to $0\ \Omega$ and then adjust the zero point.

To create $0\ \Omega$ connection state

If an ideal $0\ \Omega$ connection is made, the voltage between SENSE-H and SENSE-L becomes $0\ \text{V}$ according to the Ohm's Law of $E = I \times R$. In other words, if you set the voltage between SENSE-H and SENSE-L to $0\ \text{V}$, this gives you the same state of $0\ \Omega$ connection.

To perform zero adjustment using the instrument

The instrument uses a measurement fault detection function to monitor the state of connection between the four measurement terminals. For this reason, when performing zero adjustment, you need to make connections between the terminals appropriately in advance (Figure 1).

First, short between SENSE-H and SENSE-L to set the voltage between SENSE-H and SENSE-L to $0\ \text{V}$. If lead resistances R_{SEH} and R_{SEL} of the cable are less than few Ω , there will be no problem. Because the SENSE terminal is a voltage measurement terminal, almost no current I_0 flows. Therefore, in the $E = I_0 \times (R_{\text{SEH}} + R_{\text{SEL}})$ formula, $I_0 \approx 0$ is achieved; if lead resistances R_{SEH} and R_{SEL} are less than few Ω , voltage between SENSE-H and SENSE-L will become almost zero. Next, make connection between SOURCE-H and SOURCE-L. This is to avoid display of error when no measurement current flows through.

Lead resistances R_{SOH} and R_{SOL} of the cable must be less than the resistance for flowing measurement current.

Furthermore, if you also monitor the connection between SENSE and SOURCE, you need to make connection between SENSE and SOURCE. If lead resistance R_{Short} of the cable has only few Ω , there will be no problem.

If you wire in the way described above, measurement current I flowing out from SOURCE-H will go to SOURCE-L but not to the lead of SENSE-H or SENSE-L. This enables the voltage between SENSE-H and SENSE-L to be kept accurately at $0\ \text{V}$, and appropriate zero adjustment becomes possible.

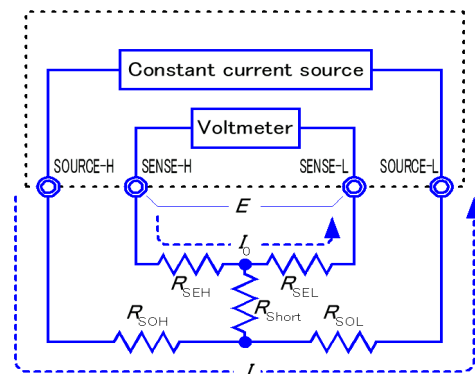

$$\begin{aligned} E &= (I_0 \times R_{\text{SEL}}) + (I_0 \times R_{\text{SEH}}) \\ &= (0 \times R_{\text{SEL}}) + (0 \times R_{\text{SEH}}) \\ &= 0 \text{ [V]} \end{aligned}$$

Figure 1 Pseudo connection to $0\ \Omega$

To perform zero adjustment appropriately

Table 1 shows the correct and wrong connections. The resistances in the figure indicate lead resistances; there will be no problem if they are less than few Ω respectively.

In (a), if you connect SENSE-H and SENSE-L as well as SOURCE-H and SOURCE-L respectively, and use one path to make connection between SENSE and SOURCE, no potential difference occurs between SENSE-H and SENSE-L, and 0 V is input. This enables zero adjustment to be carried out correctly.

In (b), on the other hand, if you connect SENSE-H and SOURCE-H as well as SENSE-L and SOURCE-L respectively, and use one path to make connection between Hi and Lo, $I \times R_{\text{Short}}$ voltage occurs between SENSE-H and SENSE-L. For this reason, the pseudo 0 Ω connection state cannot be achieved and zero adjustment cannot be carried out correctly.

Table 1: Connection methods

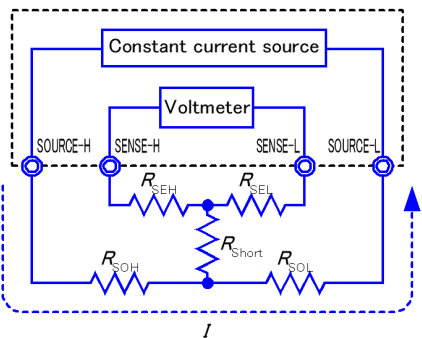
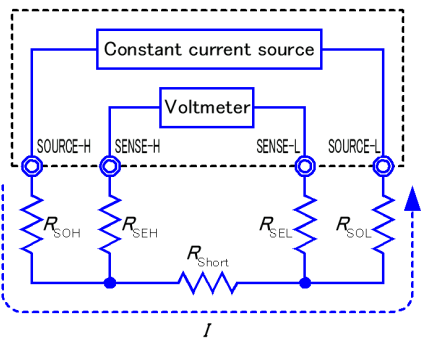
| Connection method |  <p>(a) Use one point each between SENSE and SOURCE for connection</p> |  <p>(b) Use one point each between Hi and Lo for connection</p> |
|---|--|---|
| Resistance between SENSE-H and SENSE-L | $R_{\text{SEH}} + R_{\text{SEL}}$ | $R_{\text{SEH}} + R_{\text{Short}} + R_{\text{SEL}}$ |
| Measurement current I 's flow path | $R_{\text{SOH}} \rightarrow R_{\text{SOL}}$ | $R_{\text{SOH}} \rightarrow R_{\text{Short}} \rightarrow R_{\text{SOL}}$ |
| Voltage occurring between SENSE-H and SENSE-L | 0 | $I \times R_{\text{Short}}$ |
| As connection method for zero adjustment | Correct | Wrong |

To perform zero adjustment using a probe

When you actually perform zero adjustment using a probe, you may unexpectedly make the connection shown in Table 1 (b). Therefore, when performing zero adjustment, you need to pay sufficient attention to the connection state of each terminal.

Here, L2107 CLIP TYPE LEAD as mentioned in "Executing Zero-Adjustment" (p.35) is used as an example for the connection explanation. Table 2 shows the connection state of the tip of the lead and equivalent circuit in the respective correct and wrong connections. Table 1 (a) indicates the correct connection method, resulting in 0 V between SENSE-H and SENSE-L. However, Table 1 (b) is the wrong connection method, so that 0 V is not obtained between SENSE-H and SENSE-L.

Table 2: Clip type lead connection methods used during zero adjustment

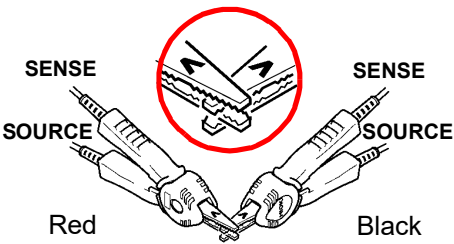
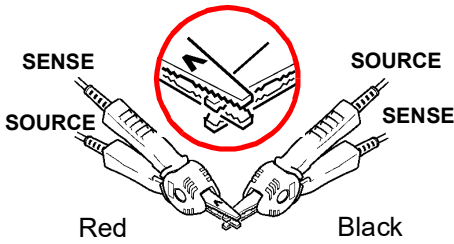
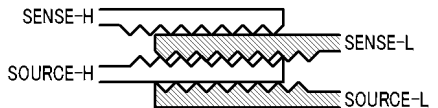
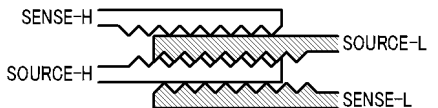
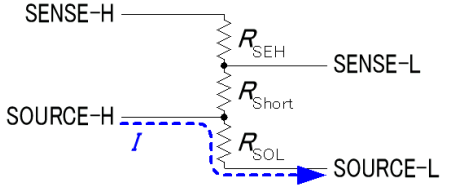
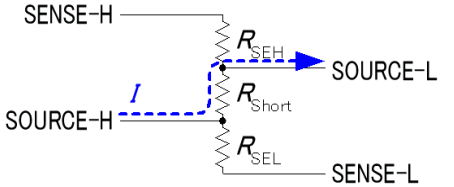
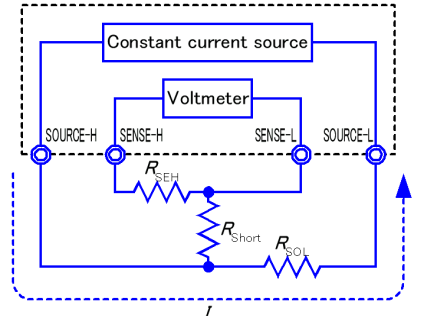
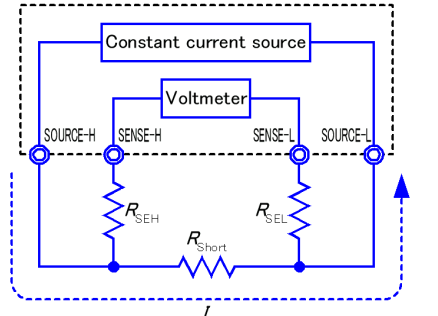
| | | |
|--|---|--|
| Connection method | <p style="text-align: center;">Correct</p>  | <p style="text-align: center;">Wrong</p>  |
| Tip of lead |  |  |
| Equivalent circuit |  |  |
| Deformed equivalent circuit |  |  |
| As connection method for zero adjustment | Correct | Wrong |

To perform zero adjustment using Z5038 0 ADJ BOARD

When performing zero adjustment, you cannot use a metal board or similar object to replace Z5038 0 ADJ BOARD.

The zero adjustment board is used when performing zero adjustment of L2100, L2110 PIN TYPE LEAD.

Table 3 shows cross sectional diagrams and equivalent circuits of the two connection methods: connecting PIN TYPE LEAD to zero adjustment board, and connecting that to a metal board or similar object. Table 1 (a) indicates the connection using zero adjustment board, resulting in 0 V between SENSE-H and SENSE-L. However, Table 1 (b) is the connection using a metal board or similar object, so that 0 V is not obtained between SENSE-H SENSE-L.

Table 3: Pin type lead connection methods in zero adjustment

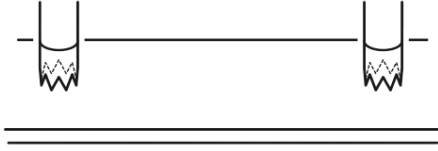
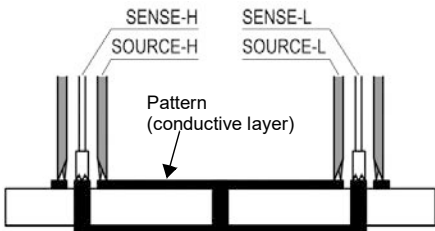
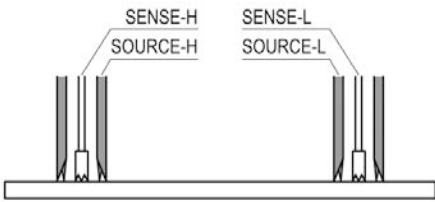
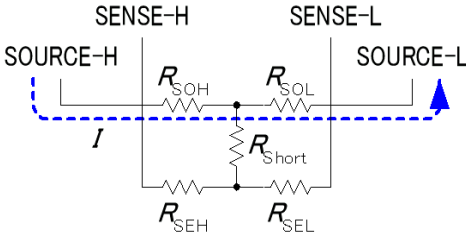
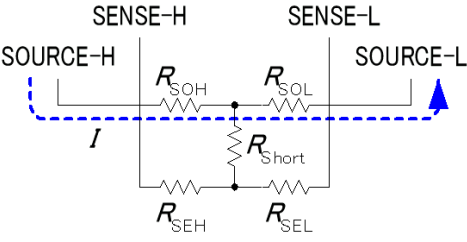
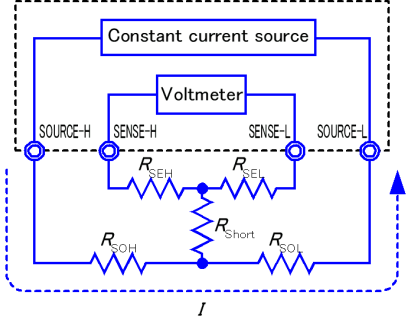
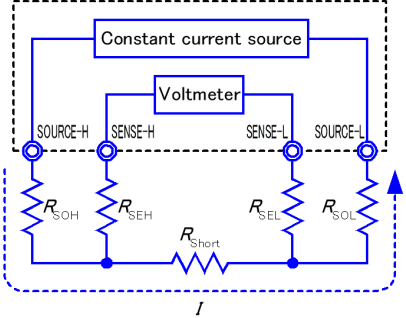
| | | |
|---|--|--|
| <p>Connection method</p> |  <p style="text-align: center;">+ If connection is made using Z5038 0 ADJ BOARD</p> |  <p style="text-align: center;">- If connection is made using metal board or similar object</p> |
| <p>Tip of lead</p> |  |  |
| <p>Equivalent circuit</p> |  |  |
| <p>Deformed equivalent circuit</p> |  |  |
| <p>As connection method for zero adjustment</p> | <p style="text-align: center;">Correct</p> | <p style="text-align: center;">Wrong</p> |

A14

Appendix 8 Zero Adjustment

If zero adjustment is difficult when using self-made probe to measure

When you perform zero adjustment using a self-made probe to do measurement, connect the tip of the self-made probe as shown in Table 1 (a). However, if such connection is difficult, you can try the following methods.

If DC resistance meter is used

The main purpose of performing zero adjustment is to remove offset of the measurement instrument. For this reason, the value to be deducted as a result of zero adjustment almost does not depend on the probe. Therefore, after using the standard probe to make the connection shown in Table 1 (a) and performing zero adjustment, you can replace it with a self-made probe to measure with offset removed from the measurement instrument.

If AC resistance meter is used

In addition to removing offset of the measurement instrument, another main purpose of performing zero adjustment is to remove influence of the probe shape. For this reason, when performing zero adjustment, try as much as possible to set the form of the self-made probe close to the measurement state. Then, you need to make the connection as shown in Table 1 (a) and perform zero adjustment. However, if a HIOKI product is used, even in AC resistance measurement, if the required resolution exceeds $100 \mu\Omega$, the same zero adjustment method used in DC resistance meter may be sufficient.

Appendix 9 Test Lead Options

Model L2107 CLIP TYPE LEAD (60 V DC or less)

These leads have clip tips. Four-terminal measurements are provided just by clipping on to the test object.

Maximum clip diameter: 8 mm

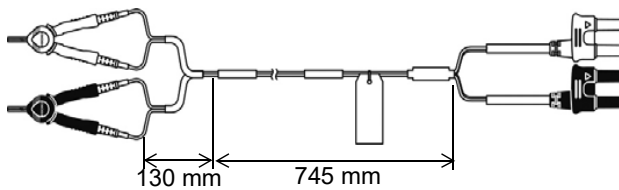

Model 9453 FOUR TERMINAL LEAD (60 V DC or less)

The SOURCE leads of this four-terminal lead set have covered alligator clips, and the SENSE leads have standard test probes. Use for measuring printed circuit board pattern resistance, and where SOURCE and SENSE leads need to be connected separately.

Bifurcation-to-probe length: approx. 300 mm

Plug-to-bifurcation length: approx. 800 mm

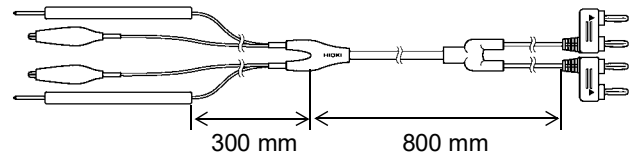

Model 9467 LARGE CLIP TYPE LEAD (50 V DC or less)

These leads are designed to attach to test object with large diameter contacts. Four-terminal measurements can be made just by clipping.

Bifurcation-to-probe length: approx. 250 mm

Plug-to-bifurcation length: approx. 850 mm

Maximum clip diameter: approx. 29 mm

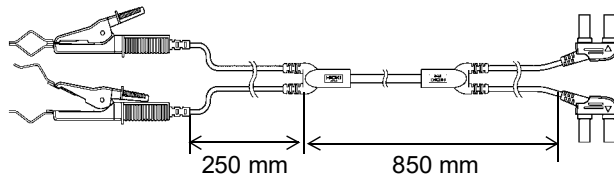

Model 9770 PIN TYPE LEAD (60 V DC or less)

Even on flat contact points that cannot be clipped to, or on test objects with small contacts such as relay terminals or connectors, four-terminal measurements are available by just pressing.

Bifurcation-to-probe length: approx. 250 mm

Plug-to-bifurcation length: approx. 400 mm

Pin base: ϕ 1.8 mm

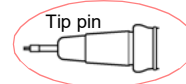
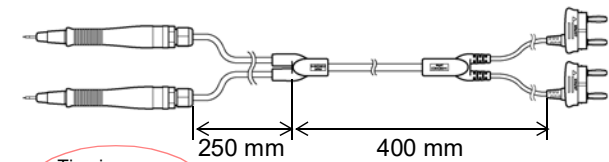

*Tip pins can be exchanged ahead.

Model 9771 PIN TYPE LEAD (60 V DC or less)

The tips have a four-terminal design developed for floating-foot testing of ICs mounted on boards. Resistance can be correctly measured even with small test objects.

Bifurcation-to-probe length: approx. 250 mm

Plug-to-bifurcation length: approx. 400 mm

Between pin bases: 0.2 mm

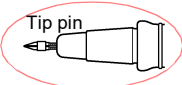
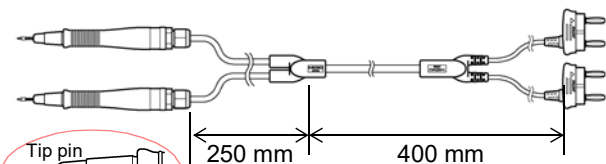

*Tip pins can be exchanged ahead.

A16

Appendix 9 Test Lead Options

Model L2100 PIN TYPE LEAD (1000 V DC or less)

These high-voltage pin-shaped leads incorporate a four-terminal design and can be used with up to 1000 V DC, making them ideal for use with high-voltage battery packs and cells with high input-to-ground voltages. The parallel two-pin type tips provide stable contact with the target object.

Bifurcation-to-probe length: approx. 300mm

Plug-to-bifurcation length: approx. 850 mm

Between pin bases: 2.5 mm

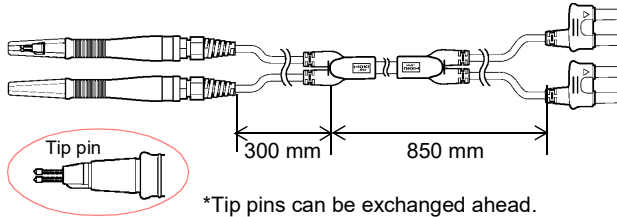

Model L2110 PIN TYPE LEAD (1000 V DC or less)

These high-voltage pin-shaped leads incorporate a four-terminal design and can be used with up to 1000 V DC, making them ideal for use with high-voltage battery packs and cells with high input-to-ground voltages. The parallel two-pin type tips provide stable contact with the target object.

Bifurcation-to-probe length: approx. 750 mm

Plug-to-bifurcation length: approx. 850 mm

Between pin bases: 2.5 mm

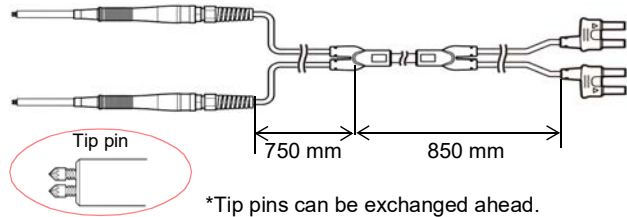

WARNING

Use measurement leads at or below their rated voltage.

Appendix 10 Rack Mounting

By removing the screws on the sides, this instrument can be installed in a rack mounting plate.

! WARNING

Observe the following precautions regarding the mounting screws to avoid instrument damage and electric shock accidents.

- When installing the Rack Mounting Plate, the screws must not intrude more than 6 mm into either side of the instrument.
- When removing the Rack Mounting Plate to return the instrument to stand-alone use, replace the same screws that were installed originally. (Feet: M3 x 6 mm, Sides: M4 x 6 mm)

Rack Mounting Plate Template Diagram and Installation Procedure

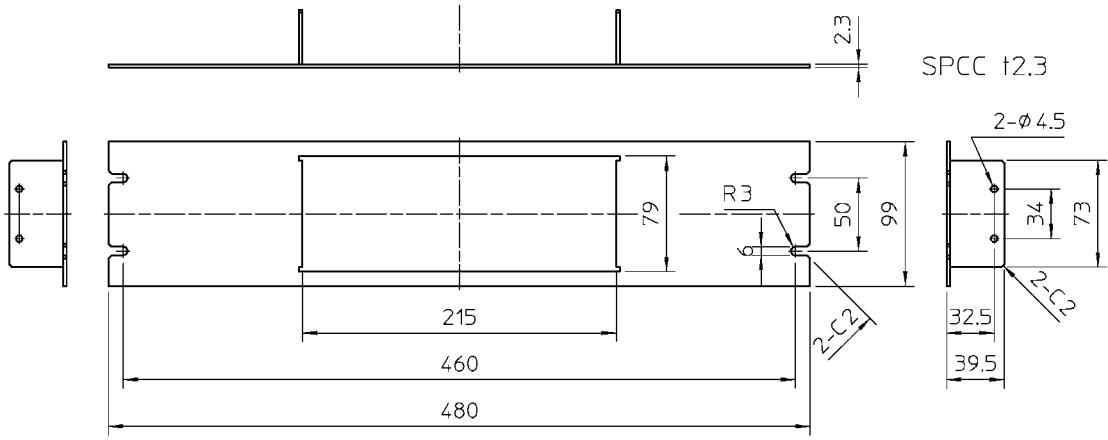

Rack Mounting Plate (JIS)

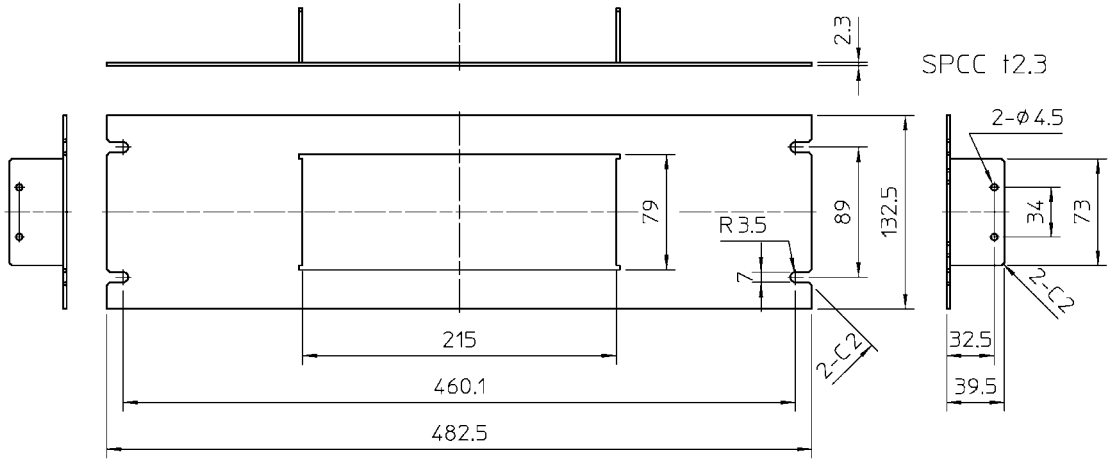

Rack Mounting Plate (EIA)

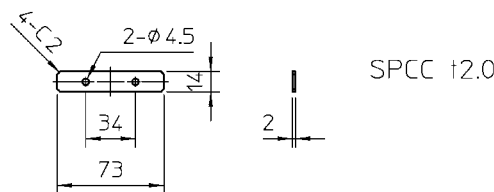

Spacer (Two Required)

A18

Appendix 10 Rack Mounting

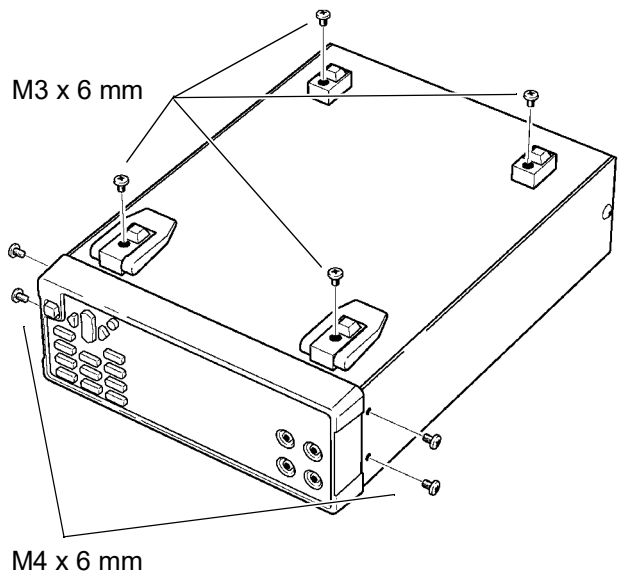

1. Remove the feed from the bottom of the instrument, and the screws from the sides (four near the front).

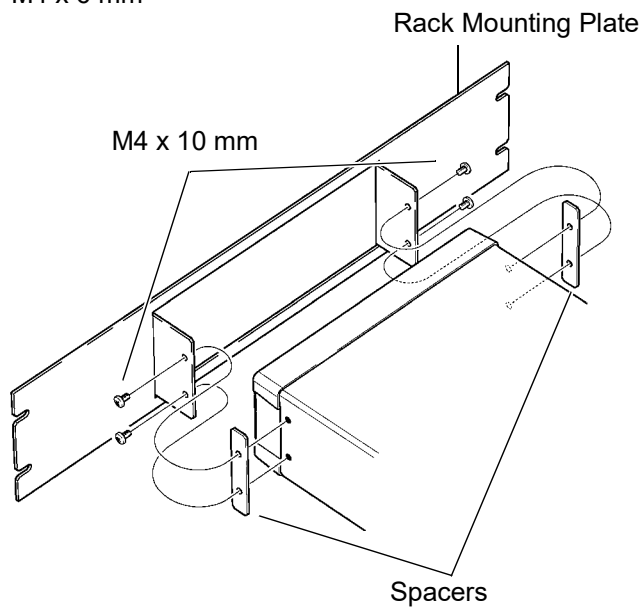

2. Installing the spacers on both sides of the instrument, affix the Rack Mounting Plate with the M4 x 10 mm screws.

When installing into the rack, reinforce the installation with a commercially available support stand.

Appendix 11 Dimensional Diagram

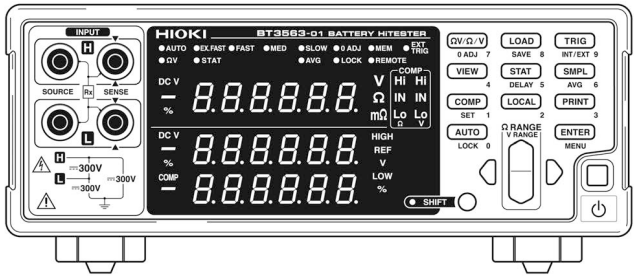
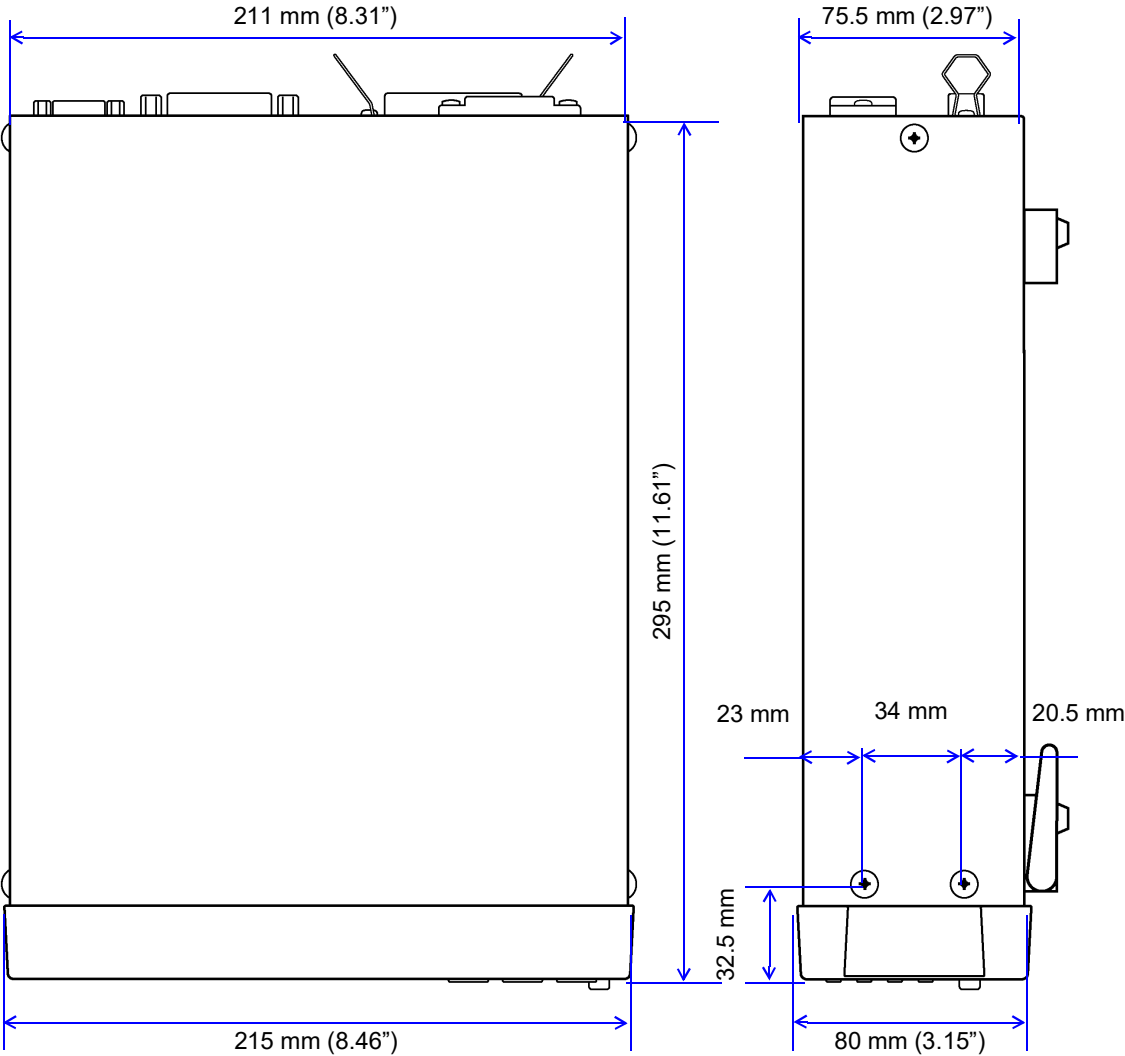

A20

Appendix 11 Dimensional Diagram

Index

Numerics

| | |
|------------|-----|
| 0ADJ | 82 |
| 3560 | 160 |

A

| | |
|-------------------------------|--------|
| AC four-terminal method | A4 |
| Accuracy | 186 |
| After warm-up | 73 |
| AND | 57, 82 |
| Auto-Ranging | 13 |
| Averaging | 13, 63 |

B

| | |
|---|---|
| Before connecting and powering on | 7 |
|---|---|

C

| | |
|--|--------|
| CAL | 73, 81 |
| Calibration | A9 |
| Character data | 111 |
| Cleaning | 191 |
| Clearing statistical calculation results | 65 |
| Command | 108 |
| Comparator | 13, 56 |
| Comparator function | 42 |
| Comparator judgment beeper | 52 |
| Compare | 42 |
| Connector | 102 |
| Continuous measurement | 153 |
| CR | 110 |
| CR+LF | 110 |
| Crossover cable | 103 |
| Custom test lead | A1 |

D

| | |
|-------------------------------|-----|
| Damage | 189 |
| Data Format | 111 |
| Decimal numeric data | 111 |
| Device-Specific command | 121 |
| Displayed value | 33 |

E

| | |
|-----------|------------|
| EOC | 82, 84, 86 |
| EOI | 110 |
| ERR | 82 |

| | |
|---------------------------------|--------|
| Error | 191 |
| EXT I/O | 15 |
| Connection examples | 88 |
| External control | 79 |
| External control Q&A | 90 |
| External control terminal | 87 |
| External trigger | 59, 85 |

F

| | |
|------------------------|-----|
| Factory defaults | 76 |
| Footswitch | 74 |
| Format | 159 |
| Free-run | 90 |
| Fuse | 189 |

G

| | |
|-------------------------------------|-------------|
| GP-IB | 15, 99, 119 |
| Ground | 7, 20 |
| Guaranteed accuracy condition | 186 |

H

| | |
|--------------|-----|
| Header | 109 |
|--------------|-----|

I

| | |
|--------------------------|---------|
| INDEX | 82 |
| Initialize | 76 |
| Input buffer | 112 |
| Input impedance | 181 |
| Input terminal | 11 |
| Inspection | 25 |
| Interface | 93, 105 |
| Internal circuitry | 87 |
| Internal trigger | 59, 85 |
| Interval printing | 93, 94 |

J

| | |
|------------------------|----|
| Judge | 42 |
| Judgment results | 82 |

K

| | |
|------------------|--------|
| Key beeper | 75 |
| Key-Lock | 13, 70 |

Index

| | | |
|--|------------------------------|----|
| L | | |
| <hr/> | | |
| LAN | 15, 104, 119 | |
| LF | 110 | |
| Line frequency | 20, 24 | |
| LOAD | 72, 81 | |
| Local | 117, 118, 149 | |
| LOCAL key | 117 | |
| M | | |
| <hr/> | | |
| MAC address | 15 | |
| Main display | 11, 12 | |
| Main power switch | 15 | |
| MANU | 82 | |
| Manual range | 13 | |
| Maximum rated voltage to earth | 181 | |
| Mean | 64 | |
| Measured current | 33, 187 | |
| Measurement Fault | 159 | |
| Measurement fault | 39, 57, 82, 83, 84, 164, 182 | |
| Measurement mode | 13, 30 | |
| measurement precision | 73 | |
| Measurement range | 31 | |
| Measurement setting state | 71 | |
| Measurement settings | 72 | |
| Measurement time | 86 | |
| Measurement value output | 74 | |
| Memory function | 68, 145 | |
| Menu display | 16 | |
| N | | |
| <hr/> | | |
| Noise | 5, 7, 149, 190 | |
| NR1 | 111 | |
| NR2 | 111 | |
| NR3 | 111 | |
| O | | |
| <hr/> | | |
| OF | 40, 182 | |
| Operating key | 11, 13, 75 | |
| Option | 2, A15 | |
| Output queue | 112 | |
| Overflow | 40, 182 | |
| P | | |
| <hr/> | | |
| Panel load function | 72 | |
| Panel save function | 71 | |
| Period of guaranteed accuracy | 188 | |
| Power cord | 20, 25 | |
| Power inlet | 15 | |
| POWER switch | 11 | |
| PRINT | 82 | |
| Printer | 13, 91 | |
| Printing statistical calculation results | | 94 |
| Process capability index | | 64 |
| Q | | |
| <hr/> | | |
| Query | 108 | |
| R | | |
| <hr/> | | |
| Rack mounting | A17 | |
| Range | 13 | |
| Reference value and tolerance | 53, 54 | |
| Relative value | 53 | |
| Remote | 13, 70, 117, 118, 149 | |
| Repair | 189 | |
| Reset | 190 | |
| Reset function | 76 | |
| Resistance and voltage measurement | 30 | |
| Resistance measurement | 30 | |
| Response time | 182 | |
| RS-232C | 15, 99, 102, 119 | |
| S | | |
| <hr/> | | |
| Sample program | 166 | |
| Sampling | 73 | |
| Sampling rate | 13, 34 | |
| Sampling time | 182 | |
| Self calibration | 73, 186 | |
| SENSE-H | 11, A1 | |
| SENSE-L | 11, A1 | |
| Separator | 110 | |
| sn | 55, 64 | |
| sn-1 | 64 | |
| SOURCE-H | 11, A1 | |
| SOURCE-L | 11, A1 | |
| Stand | 15 | |
| Standard deviation of population | 64 | |
| Statistical calculation | 13 | |
| Statistical calculation function | 64 | |
| Sub display | 11, 12 | |
| Supply frequency | 188 | |
| Supply voltage | 7, 22, 188 | |
| T | | |
| <hr/> | | |
| Temperature coefficient | 187 | |
| Terminator | 110 | |
| Test lead | 21, 25, 35, A15 | |
| Threshold method | 53 | |
| Timing chart | 85 | |
| TRIG | 59, 66, 68, 74, 81 | |
| Trigger | 13, 59, 153 | |
| Trigger delay | 13 | |
| Trigger source | 153 | |

U

Upper and lower thresholds53

V

Voltage measurement30

W

Warm-up time 186

Z

Zero-Adjustment 13, 35, 37, A10

Index

Warranty Certificate

HIOKI

| | | |
|-------|---------------|--|
| Model | Serial number | Warranty period Three (3) years from date of purchase (___ / ___) |
|-------|---------------|--|

Customer name: _____

Customer address: _____

Important

- Please retain this warranty certificate. Duplicates cannot be reissued.
- Complete the certificate with the model number, serial number, and date of purchase, along with your name and address. The personal information you provide on this form will only be used to provide repair service and information about Hioki products and services.

This document certifies that the product has been inspected and verified to conform to Hioki's standards. Please contact the place of purchase in the event of a malfunction and provide this document, in which case Hioki will repair or replace the product subject to the warranty terms described below.

Warranty terms

1. The product is guaranteed to operate properly during the warranty period (three [3] years from the date of purchase). If the date of purchase is unknown, the warranty period is defined as three (3) years from the date (month and year) of manufacture (as indicated by the first four digits of the serial number in YYMM format).
2. If the product came with an AC adapter, the adapter is warranted for one (1) year from the date of purchase.
3. The accuracy of measured values and other data generated by the product is guaranteed as described in the product specifications.
4. In the event that the product or AC adapter malfunctions during its respective warranty period due to a defect of workmanship or materials, Hioki will repair or replace the product or AC adapter free of charge.
5. The following malfunctions and issues are not covered by the warranty and as such are not subject to free repair or replacement:
 - 1. Malfunctions or damage of consumables, parts with a defined service life, etc.
 - 2. Malfunctions or damage of connectors, cables, etc.
 - 3. Malfunctions or damage caused by shipment, dropping, relocation, etc., after purchase of the product
 - 4. Malfunctions or damage caused by inappropriate handling that violates information found in the instruction manual or on precautionary labeling on the product itself
 - 5. Malfunctions or damage caused by a failure to perform maintenance or inspections as required by law or recommended in the instruction manual
 - 6. Malfunctions or damage caused by fire, storms or flooding, earthquakes, lightning, power anomalies (involving voltage, frequency, etc.), war or unrest, contamination with radiation, or other acts of God
 - 7. Damage that is limited to the product's appearance (cosmetic blemishes, deformation of enclosure shape, fading of color, etc.)
 - 8. Other malfunctions or damage for which Hioki is not responsible
6. The warranty will be considered invalidated in the following circumstances, in which case Hioki will be unable to perform service such as repair or calibration:
 - 1. If the product has been repaired or modified by a company, entity, or individual other than Hioki
 - 2. If the product has been embedded in another piece of equipment for use in a special application (aerospace, nuclear power, medical use, vehicle control, etc.) without Hioki's having received prior notice
7. If you experience a loss caused by use of the product and Hioki determines that it is responsible for the underlying issue, Hioki will provide compensation in an amount not to exceed the purchase price, with the following exceptions:
 - 1. Secondary damage arising from damage to a measured device or component that was caused by use of the product
 - 2. Damage arising from measurement results provided by the product
 - 3. Damage to a device other than the product that was sustained when connecting the device to the product (including via network connections)
8. Hioki reserves the right to decline to perform repair, calibration, or other service for products for which a certain amount of time has passed since their manufacture, products whose parts have been discontinued, and products that cannot be repaired due to unforeseen circumstances.

HIOKI E.E. CORPORATION

<http://www.hioki.com>

18-07 EN-3



5 Commonwealth Ave
Woburn, MA 01801
Phone 781-665-1400
Toll Free 1-800-517-8431



HIOKI

1906 EN

Edited and published by HIOKI E.E. CORPORATION

Printed in Japan

- CE declarations of conformity can be downloaded from our website.
- Contents subject to change without notice.
- This document contains copyrighted content.
- It is prohibited to copy, reproduce, or modify the content of this document without permission.
- Company names, product names, etc. mentioned in this document are trademarks or registered trademarks of their respective companies.