

CertiFiber[®] Pro

Optical Loss Test Set







Getting Started Guide

The CertiFiber Pro Optical Loss Test Set (OLTS) modules attach to Versiv™ and Versiv 2 main and remote units to make rugged, hand-held testers that let you certify, troubleshoot, and document fiber optic network cabling.

Accessing the Product Manuals

This guide provides basic information to help you get started using the tester. For more detailed information, see the latest versions of the *Versiv Series Users Manual* and the *Versiv Series Technical Reference Handbook* provided on the Fluke Networks website.

Symbols

	Warning or Caution: Risk of damage or destruction to equipment or software. See explanations in the manuals.
	Warning: Risk of fire, electric shock, or personal injury.
	Warning: Class 1 or Class 2 lasers. Risk of eye damage from hazardous radiation.
	Consult the user documentation.
	Do not connect this equipment to public communications networks, such as telephone systems.
	Conforms to the Appliance Efficiency Regulation (California Code of Regulations, Title 20, Sections 1601 through 1608), for small battery charging systems.



	<p>Certified by CSA Group to North American safety standards.</p>
	<p>This Product contains a lithium-ion battery. Do not mix with the solid waste stream. Spent batteries should be disposed of by a qualified recycler or hazardous materials handler per local regulations. Contact your authorized Fluke Service Center for recycling information.</p>
	<p>This product complies with the WEEE Directive marking requirements. The affixed label indicates that you must not discard this electrical/electronic product in domestic household waste. Product Category: With reference to the equipment types in the WEEE Directive Annex I, this product is classed as category 9 "Monitoring and Control Instrumentation" product. Do not dispose of this product as unsorted municipal waste. To return unwanted products, contact the manufacturer's web site shown on the product or your local sales office or distributor.</p>
	<p>40 year Environment Friendly Use Period (EFUP) under China Regulation - Administrative Measure on the Control of Pollution Caused by Electronic Information Products. This is the period of time before any of the identified hazardous substances are likely to leak out, causing possible harm to health and the environment.</p>
	<p>Conformite Europeene. Conforms to the requirements of the European Union and the European Free Trade Association (EFTA).</p>
	<p>Conforms to relevant Australian standards.</p>
	<p>Conforms to relevant Russian standards.</p>
	<p>EMC approval for Korea. Class A Equipment (Industrial Broadcasting Communication Equipment). This product meets requirements for industrial (Class A) electromagnetic wave equipment and the seller or user should take notice of it. This equipment is intended for use in business environments and is not to be used in homes.</p>
	<p>This key turns the Product on and off.</p>

Safety Information

Warning

To prevent possible fire, electric shock, or personal injury:

- Read all safety information before you use the Product.
- Carefully read all instructions.
- Do not open the case. You cannot repair or replace parts in the case.
- Do not modify the Product.
- Use only replacement parts that are approved by Fluke Networks.
- Do not touch voltages > 30 V AC rms, 42 V AC peak, or 60 V DC.
- Do not use the Product around explosive gas, vapor, or in damp or wet environments.
- Use this Product indoors only.
- Use the Product only as specified, or the protection supplied by the Product can be compromised.
- Do not use and disable the Product if it is damaged.
- Do not use the Product if it operates incorrectly.
- Batteries contain hazardous chemicals that can cause burns or explode. If exposure to chemicals occurs, clean with water and get medical aid.
- Remove the batteries if the Product is not used for an extended period of time, or if stored in temperatures above 50 °C. If the batteries are not removed, battery leakage can damage the Product.
- Replace the rechargeable battery after 5 years of moderate use or 2 years of heavy use. Moderate use is defined as recharged twice a week. Heavy use is defined as discharged to cutoff and recharged daily.
- Disconnect the battery charger and move the Product or battery to a cool, non-flammable location if the rechargeable battery becomes hot (>50 °C, >122 °F) during the charge period.
- The battery door must be closed and locked before you operate the Product.
- Repair the Product before use if the battery leaks.
- Recharge the batteries when the low battery indicator shows to prevent incorrect measurements.

- Do not disassemble or crush battery cells and battery packs.
- Do not put battery cells and battery packs near heat or fire. Do not put in sunlight.
- Have an approved technician repair the Product.
- For Products with rechargeable batteries, use only AC adapters approved by Fluke Networks for use with the Product to supply power to the Product and charge the battery.

Warning: Class 1 and Class 2 Laser Products

To prevent eye damage and personal injury:

- Do not look directly into optical connectors. Some optical equipment emits invisible radiation that can cause permanent damage to your eyes.
- Keep the module's OUTPUT ports covered with a dust cap or keep a test reference cord attached. The OUTPUT ports can emit radiation even when you do not do a test.
- Do not look into the laser. Do not point laser directly at persons or animals or indirectly off reflective surfaces.
- When you inspect fiber endfaces, use only magnification devices that have the correct filters.
- Use the Product only as specified or hazardous laser radiation exposure can occur.

Caution

To prevent damage to the Product or cables under test and to prevent data loss, read all safety information given in all documentation supplied with the Product.

Connectors, Keys, and LEDs

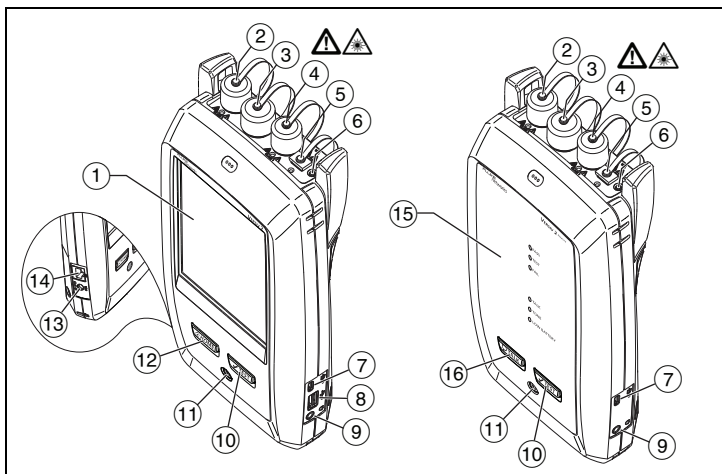







HGP00.EPS

Figure 1. Connectors, Keys, and LEDs (Versiv 2 shown)

- ① LCD display with touchscreen.
- ② Singlemode output port with removable connector adapter and dust cap. This port transmits optical signals for loss and length measurements.

The LED below the output port is red when the port transmits 1310 nm and green for 1550 nm.
- ③ Input port with removable connector adapter and dust cap. This port receives optical signals for loss, length, and power measurements.
- ④ Multimode output port with removable connector adapter and dust cap. This port transmits optical signals for loss and length measurements.

The LED below the output port is red when the port transmits 850 nm and green for 1300 nm.
- ⑤ Universal fiber connector (with dust cap) for the visual fault locator. The connector accepts 2.5 mm ferrules. The LED below the connector shows the locator's mode.
- ⑥ Button to manually control the output ports (② and ④) and the visual fault locator (⑤).
- ⑦ Micro USB port: This USB port lets you connect the tester to a PC so you can upload test results to the PC (main tester only) and install software updates in the tester.
- ⑧ Type A USB port: This USB host port lets you save test results on a USB flash drive and connect the FI-1000 video probe to the tester. Versiv: Also lets you connect a Wi-Fi adapter for access to Fluke Networks cloud services. (Versiv 2 testers have an internal Wi-Fi radio.)

- ⑨ Headset jack.
- ⑩ : Starts a test. To start a test, you can also tap **TEST** on the display.
- ⑪ Power button. Versiv 2: The LED in the power button shows the status of the battery charging process. See the Users Manual..
- ⑫ : Press  to go to the home screen.
- ⑬ Connector for the AC adapter. Versiv: The LED is red when the battery charges, and green when the battery is fully charged. The LED is yellow if the battery will not charge.
- ⑭ RJ45 connector: Lets you connect to a network for access to Fluke Networks cloud services.
- ⑮ **PASS** LED comes on when a test passes.
TEST LED comes on during a test and when you manually turn on one of the output ports.
FAIL LED comes on when a test fails.
TALK LED comes on when the talk function is on (see ⑯).
STONE LED flashes if you press  and the main tester is not connected to the remote or is in **Far End Source** mode.
LOW BATTERY LED comes on when the battery is low.
- ⑯ : Press  to use the headset to speak to the person at the other end of the link. Press again to adjust the volume. To turn off the talk function, hold down .

How to Certify Fiber Optic Cabling

1 Power the Tester

Charge the battery if necessary. Connect the AC adapter to AC power and to the adapter connector (⑬) shown in Figure 1. You can use the tester while the battery charges.

2 Select Settings

2-1 On the home screen, tap the test setup panel (Figure 2, number ②).

-continued-

2-2 On the **CHANGE TEST** screen, tap a fiber test, then tap **EDIT**.

2-3 On the **TEST SETUP** screen, tap the panels to change settings:

- **Test Type:** Select **Smart Remote**.
- **Bi-Directional:** Select **On**. The tester will do fiber tests in both directions.
- **Fiber Type:** Select a fiber type that is correct for the type you will test.
- **Test Limit:** Select **General Fiber Optic**.
- **Reference Method:** Select **1 Jumper Reference**.
- **No. of Connectors/Splices:** These settings are only for test limits that use a calculated limit for loss. They are not applicable to the **General Fiber Optic** limit.

2-4 To save the settings, tap **SAVE** on the **TEST SETUP** screen.

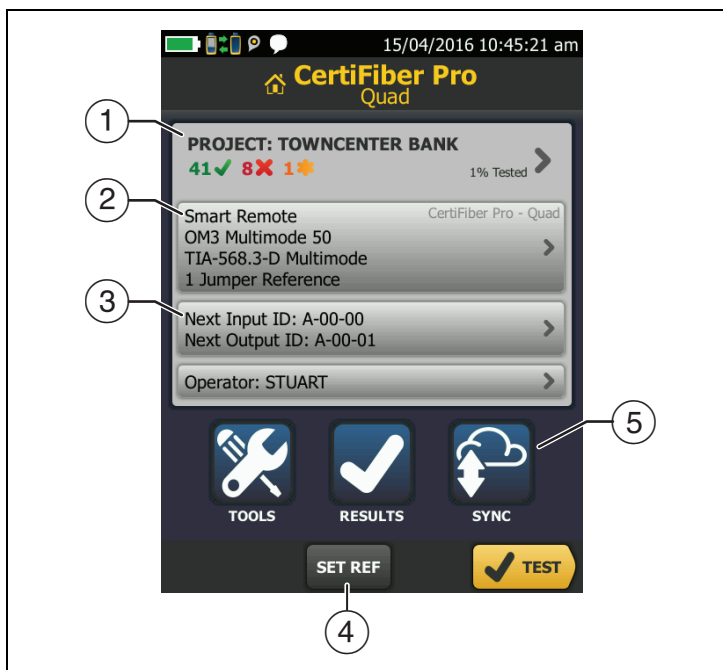

HGP01.EPS

Figure 2. Panels on the Home Screen

- ① To set up a project, tap the **PROJECT** panel.
- ② To change settings for the test or select a different test, tap the test setup panel.
- ③ To set up cable IDs and turn on **Auto Save**, tap the **Next ID** panel.
- ④ To set the reference and verify your test reference cords for loss/length tests, tap **SET REF**.
- ⑤ To upload test results to LinkWare Live, tap **SYNC**.

3 Clean and Inspect All Connectors

Caution

Use proper cleaning procedures to clean all fiber connectors before every use. Neglecting this step or using improper procedures can cause unreliable test results and may permanently damage the connectors. See the Users Manual for instructions.

4 Set the Reference and Verify Your Test Reference Cords

The reference procedure for fiber cable sets a baseline power level for loss measurements. It is important to set the reference frequently. You must also make sure your test reference cords are in good condition. See the Users Manual.

- 4-1 Turn on the tester and remote and let them sit for a minimum of 5 minutes. Let them sit longer if they are above or below ambient temperature.
- 4-2 Make sure that the home screen shows the correct settings
- 4-3 Clean and inspect the connectors on the tester, remote, and test reference cords.
- 4-4 On the home screen tap **SET REF.**
- 4-5 On the **SET REFERENCE** screen, tap **RUN WIZARD.**
- 4-6 Make the connections shown on the screen, then tap **NEXT** to see the completed connections (**Reference** in Figure 3).

Note

When you set the reference, align the testers as shown in Figure 3 to keep the fibers as straight as possible.

- 4-7 To enter the length of the test reference cords you will add to connect to the link, tap **TRC LENGTH** on the **SET REFERENCE** screen. The length you enter does not change the test results. The tester saves the length with the results to meet TIA reporting requirements.
- 4-8 Tap **SET REFERENCE**, tap **NEXT**, then make the connections shown on the screen (**TRC Verification** in Figure 3)
- 4-9 Tap **TRC VERIFICATION**. The tester measures and saves the loss of the test reference cords you added.

5 Make Connections and Do a Test

5-1 Tap **NEXT**. Connect the testers to the link as shown on the screen (**Fiber Link Test** in Figure 3).

5-2 Press **✓TEST** on the main or remote tester.

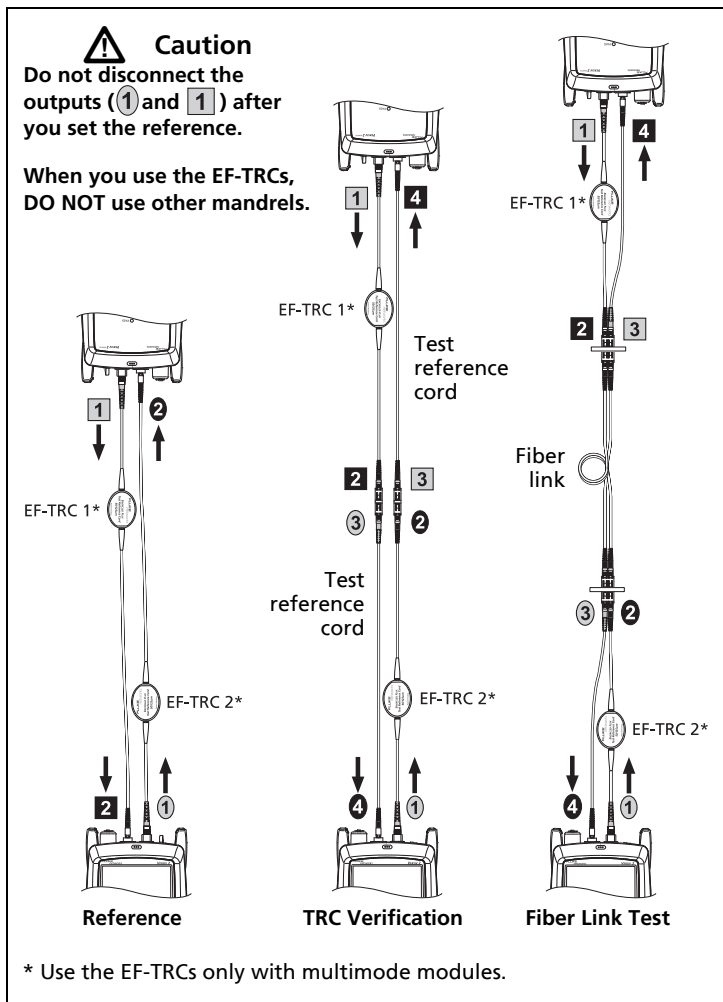

GPU122.EPS

**Figure 3. Connections for Smart Remote Mode
(1 Jumper Reference, Multimode Fiber)**

6 Examine the Results

The tester shows a summary of the test results for the fibers (Figure 4, left). To see more information (Figure 4, right), tap the window for a fiber.

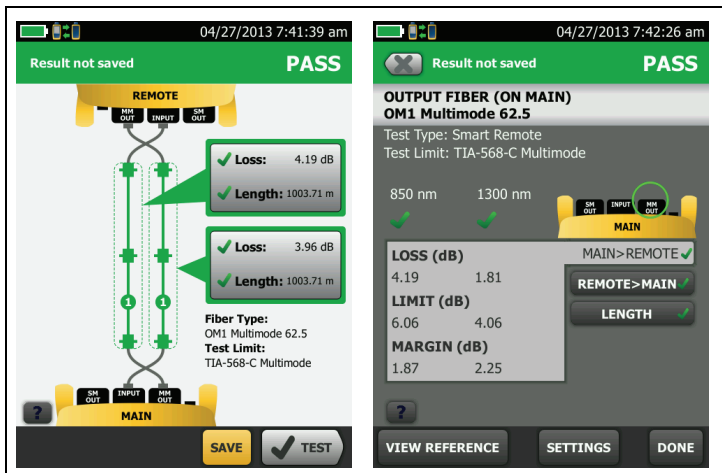

Figure 4. Examples of Fiber Test Results Screens

HGP02.EPS

7 Save the Results

- If **Auto Save** is on, the tester uses the next two IDs to save the results for the two fibers.
- If **Auto Save** is off, tap **SAVE** if the test passed or **FIX LATER** if the test failed. The **SAVE RESULT** screen shows the next two IDs available. You can change the IDs if necessary.

The tester saves the results in the **DEFAULT** project, unless you selected a different project.

About Projects

You can set up a project to specify the settings and tests necessary for a job, monitor the status of a job, and organize the test results.

To start a new project, tap **PROJECT** on the home screen, tap **CHANGE PROJECT**, then tap **NEW PROJECT**. See the Users Manual or Technical Reference Handbook for more information.

About Fluke Networks Cloud Services

With a Fluke Networks web account and a wired or wireless network connection, you can use the LinkWare™ Live web application to store and manage projects in the cloud.

Registration

Registering your product with Fluke Networks gives you access to valuable information on product updates, troubleshooting tips, and other support services. To register, use LinkWare PC software. Download LinkWare PC from the Fluke Networks website

Contact Fluke Networks

Fluke Networks operates in more than 50 countries worldwide. For more contact information, go to our website.

General Specifications

Battery Type	Lithium-ion
Power Adapter	Input: 100 to 240 VAC \pm 10%, 50/60Hz Output: 15 VDC, 2 A maximum Class II
Versiv 2 wireless radio*	Frequency ranges: 2.4 GHz band: 2412 MHz to 2484 MHz 5 GHz band: 4910 MHz to 5825 MHz Output power: <100 mW
Temperature	Operating: -10 °C to +45 °C Storage: -10 °C to +60 °C
Altitude	Operating: 4,000 m (3,200 m with AC adapter) Storage: 12,000 m

LIMITED WARRANTY AND LIMITATION OF LIABILITY

Fluke Networks mainframe products will be free from defects in material and workmanship for one year from the date of purchase, unless stated otherwise herein. Parts, accessories, product repairs and services are warranted for 90 days, unless otherwise stated. Ni-Cad, Ni-MH and Li-Ion batteries, cables or other peripherals are all considered parts or accessories. This warranty does not cover damage from accident, neglect, misuse, alteration, contamination, or abnormal conditions of operation or handling. Resellers are not authorized to extend any other warranty on Fluke Networks' behalf. To obtain service during the warranty period, contact your nearest Fluke Networks authorized service center to obtain return authorization information, then send your defective product to that Service Center with a description of the problem.

THIS WARRANTY IS YOUR ONLY REMEDY. NO OTHER WARRANTIES, SUCH AS FITNESS FOR A PARTICULAR PURPOSE, ARE EXPRESSED OR IMPLIED. FLUKE NETWORKS IS NOT LIABLE FOR ANY SPECIAL, INDIRECT, INCIDENTAL OR CONSEQUENTIAL DAMAGES OR LOSSES, ARISING FROM ANY CAUSE OR THEORY. Since some states or countries do not allow the exclusion or limitation of an implied warranty or of incidental or consequential damages, this limitation of liability may not apply to you.