



Courier 3000 Instruction Manual



TABLE OF CONTENTS

1.	INTRODUCTION	2
1.1.	Safety Precautions	2
1.2.	Intended Use	2
1.3.	Overview of Parts and Controls	3
1.4.	Control Functions	3
2.	INSTALLATION.....	5
2.1	Packing List	5
2.2	Unpacking the Scale	5
2.3	Setup	5
2.3.1	Power Supply Connection.....	5
2.3.2	Direct Wall Mounting	5
2.4	Leveling the Equipment.....	5
3.	OPERATION.....	6
3.1	Turning On/Off the Scale	6
3.2	Setting the Display to Zero	6
3.3	Changing the Units of Measure.....	6
3.4	Calibration	6
3.4.1	Linear calibration.....	6
3.5	Application Modes	7
3.5.1	Weighing	7
3.5.2	Display Hold	7
4.	MAINTENANCE	8
4.1	Cleaning	8
4.2	Troubleshooting.....	8
4.3	Service Information	8
5.	TECHNICAL DATA	9
5.1	Specifications	9
5.2	Drawings and Dimensions	10
6.	COMPLIANCE.....	11
	LIMITED WARRANTY	12

1. INTRODUCTION

This manual contains installation, operation, and maintenance instructions for Courier 3000. This instruction manual helps you to install and use this scale easily. Therefore, you must read it carefully before installation and operation.

1.1. Safety Precautions

Definition of Signal Warnings and Symbols

Safety notes are marked with signal words and warning symbols. These show safety issues and warnings. Ignoring the safety notes may lead to personal injury, damage to the instrument, malfunctions and false results.

Signal Words

WARNING	For a hazardous situation with medium risk, possibly resulting in severe injuries or death if not avoided.
CAUTION	For a hazardous situation with low risk, resulting in damage to the device or the property or in loss of data, or minor or medium injuries if not avoided.
ATTENTION	For important information about the product. May lead to equipment damage if not avoided.
NOTE	For useful information about the product.

Warning Symbols



General hazard



Explosion hazard



Electrical shock hazard

Safety Precautions



CAUTION: Read all safety warnings before installing, making connections, or servicing this equipment. Failure to comply with these warnings could result in personal injury and/or property damage. Retain all instructions for future reference.

- Before connecting power, verify that the equipment's input voltage range and plug type are compatible with the local AC mains power supply.
- Do not position the equipment such that it is difficult to reach the power connection.
- Make sure that the power cord does not pose a potential obstacle or tripping hazard.
- Operate the equipment only under ambient conditions specified in these instructions.
- The equipment is for indoor use only.
- Do not operate the equipment in wet, hazardous, or unstable environments.
- Do not allow liquids to enter the equipment.
- Do not load the equipment above its rated capacity.
- Do not drop loads on the platform.
- Do not place the equipment upside down on the platform.
- Use only approved accessories and peripherals.
- Disconnect the equipment from the power supply when cleaning.
- Service should only be performed by authorized personnel.



WARNING: Never work in an environment subject to explosion hazards! The housing of the instrument is not gas tight. (Explosion hazard due to spark formation, corrosion caused by the ingress of gases)



WARNING: Electrical shock hazards exist within the housing. The housing should only be opened by authorized and qualified personnel. Remove all power connections to the unit before opening.

1.2. Intended Use

This instrument is intended for use in pharmacies, schools, businesses and light industry. It must only be used for measuring the parameters described in these operating instructions. Any other type of use and operation beyond the limits of technical specifications, without written consent from OHAUS, is considered as not intended. This instrument complies with current industry standards and the recognized safety regulations; however, it can constitute a hazard in use. If the instrument is not used according to these operating instructions, the intended protection provided by the instrument may be impaired.

1.3. Overview of Parts and Controls

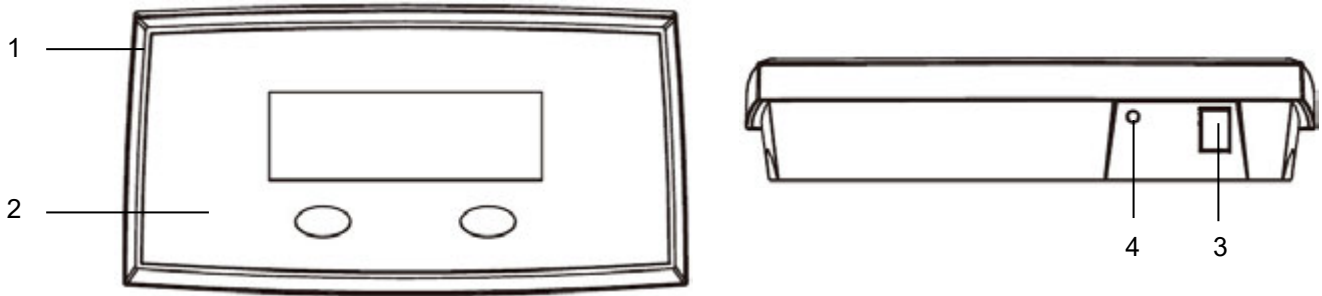

Figure 1-1 Courier 3000

Item	Description	Item	Description
1	Front housing	3	Load cell cable connector
2	Control panel	4	Power port

1.4. Control Functions

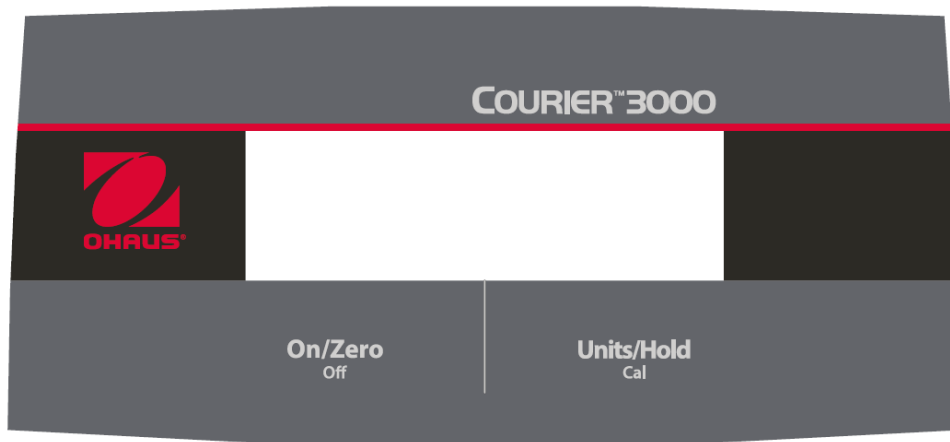



Figure 1-2 Courier 3000 Control Panel

Button	On/Zero Off	Units/Hold Cal
Primary Function (Short Press) 	<p>On/Zero</p> <p>If the scale is off, short press to turn on the scale.</p> <p>When the weight on the platform is less than or equal to 2% of the Capacity value, a short press will zero the instrument display.</p> <p>When the weight on the platform is greater than 2% of the Capacity value, a short press will set the tare weight.</p> <p>During the calibration, short press this button to capture the zero and the linearity calibration points.</p> <p>In Display Hold mode, short press this button to clear the reading shown on the instrument display.</p>	<p>Units/Hold</p> <p>Enter/exit the hold mode.</p>
Secondary Function (Long Press) 	<p>Off</p> <p>If the scale is on, long press to turn off the scale.</p>	<p>Cal</p> <p>Changes the weighing unit.</p> <p>Long press two buttons to enter the calibration mode.</p>

NOTE:

- Short Press: Press the key less than 3 seconds.
- Long Press: Press and hold the key for more than 3 seconds.







Figure 1-3 Display

Item	Description	Item	Description
1	Net weight symbol	5	Battery symbol
2	Negative symbol	6	Center of Zero symbol
3	Stable weight symbol	7	Kilogram symbol
4	Display Hold symbol	8	Pound

2. INSTALLATION

2.1 Packing List

Item	Description	Picture	Quantity
1	Base		1
2	Terminal		
3	Coiled cable		1
4	AC adapter		1

2.2 Unpacking the Scale

Steps

1. Take out documents, AC adapter and put them to the side.
2. Remove the foam blocks.
3. Take the Courier 3000 scale out of the box and put it on a stable surface.

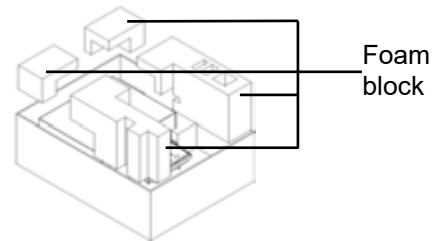

2.3 Setup

2.3.1 Power Supply Connection

AC Adapter Power

1. Connect the AC Adapter to the terminal.
2. Plug the AC Adapter into the electrical outlet.

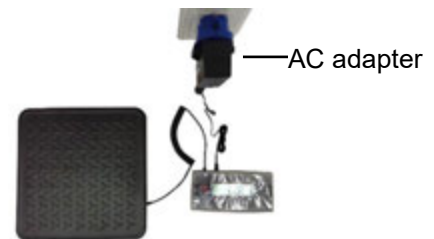

Dry Battery Power

3 disposable AA size dry batteries (not included) can supply power to the scale.

1. Remove the terminal.
2. Install the batteries in the battery compartment.



2.3.2 Direct Wall Mounting

The terminal may be mounted directly to a wall or table using two screws (not included).

You can select the appropriate size screws that fit into the holes at the bottom of the terminal housing. See **Figure A**. When mounting to a wall without a solid backing, you can use the appropriate anchoring hardware.

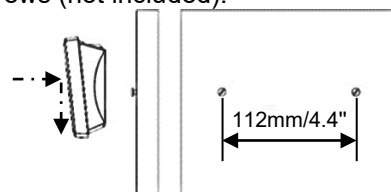

Figure A. Direct Wall Mount Arrangement

2.4 Leveling the Equipment

Place the scale on a firm and stable flat surface and avoid excessive airflow, vibration, heat sources, or rapid temperature changes. Afterwards, rotate the scale feet for leveling (for L-shaped bases only).

3. OPERATION

3.1 Turning On/Off the Scale

To turn on the scale, you can short press the **On/Zero** button. The scale displays the software version and enters the weighing mode.

To turn the scale off, you can long press the **Off** button until **OFF** is displayed.

3.2 Setting the Display to Zero

The value of the display can be set to zero in the following cases:

1. When the scale is turned on, it will perform an initial zero.
2. When the weight on the platform is less than or equal to 2% of the Capacity value, short press the **ON/ZERO Off** button to zero the instrument display.
3. When the weight on the platform is greater than 2% of the Capacity value, short press the **ON/ZERO Off** button to set the tare weight, then the instrument display will show a reading of 0.

If you want to set the value of the display by pressing the **ON/ZERO Off** button, please make sure that the scale is stable.

3.3 Changing the Units of Measure

To change the weighing unit, you can long press the **Units/Hold** button until the desired weighing unit appears on the display.

3.4 Calibration

3.4.1 Linear calibration

The scale performs linearity calibration with 3 calibration points. The zero calibration point is established with no load on the platform. The mid calibration point and the full calibration point are established with loads on the platform.

Calibration Procedures:

1. After powering on, long press the **UNITS/Hold** button and **On/Zero** button simultaneously until **CAL** appears on the instrument display.
2. Release the **UNITS/Hold** button and **On/Zero** button at the same time.
3. Short press the **On/Zero** button and **-[-** will appear on the instrument display. The scale will perform a zero calibration at this time (Do not place any weight on the platform).

When the zero calibration is completed, the display will show "C XXX kg" or "C XXX lb", depending on the current unit. For different models, the readings displayed are as follows:

C31M35R: 10 kg (20 lb)
 C31M75R: 25 kg (50 lb)
 C31M75L: 25 kg (50 lb)
 C31M200R: 100 kg (200 lb)
 C31M200L: 100 kg (200 lb)

4. Place the load on the platform.
5. Short press the **On/Zero** button and **-[-** will appear on the instrument display. The scale will perform a midpoint calibration at this time.

When the midpoint calibration is completed, the display will show "C XXX kg" or "C XXX lb", depending on the current unit. For different models, the readings displayed are as follows:

C31M35R: 30 kg (60 lb)
 C31M75R: 75 kg (150 lb)
 C31M75L: 75 kg (150 lb)
 C31M200R: 200 kg (400 lb)
 C31M200L: 200 kg (400 lb)

6. Place the load on the platform.
7. Short press the **On/Zero** button and **-[-** will appear on the instrument display. The scale will perform a top range calibration at this time.

NOTE:

- When the calibration is completed, the display will return to weighing.
- If the display shows CAL E and then exits the calibration mode, this indicates that calibration has failed.

3.5 Application Modes

3.5.1 Weighing

This mode is the default factory setting, and it is used to determine the weight of the loads in the selected unit of measure.

Starting to Weigh

1. Put a weight on the scale. Once the value is stable, you can see "" on the display.

If a container is used, place the empty container on the platform. The display will show the container's weight in the selected weight unit. Once the platform is stable, the stable weight symbol "" will appear on the display.

2. To capture the weight of the container (the Tare weight), press the **On/Zero** key. Once the platform is stable the weight will be captured, the display will return to zero and the stable weight symbol "" will appear on the display.
3. Fill the container as required. The net weight of the contents of the container will be shown on the display. Once the platform is stable, the stable weight symbol "" will appear on the display.

3.5.2 Display Hold

In Display Hold mode, the instrument will hold the displayed reading for the weight on the platform if that weight is greater than 5 divisions.

1. Short press the **Units/Hold** button.
2. Place the load on the platform. When the weight is greater than 5d and stable, the display will show the Hold symbol "o" and the weight display will remain even after the load is removed or changes. This is useful for large boxes.
3. To clear the Hold weight on the display and exit Display Hold mode, short press the **On/Zero** key once. The display will then show the current weight on the platform.

NOTE: After zeroing, the display will restart to capture the first reading with a stable weight value greater than 5 d.

4. MAINTENANCE

4.1 Cleaning

For Courier 3000, the housing may be cleaned with a cloth dampened with a mild detergent if necessary.

CAUTION: DISCONNECT THE UNIT FROM THE POWER SUPPLY BEFORE CLEANING.



WARNING: Electric Shock Hazard. Disconnect the equipment from the power supply before cleaning. Make sure that no liquid enters the interior of the instrument.



Attention: Do not use solvents, harsh chemicals, ammonia or abrasive cleaning agents.

The housing may be cleaned with a cloth dampened with a mild detergent if necessary.

4.2 Troubleshooting

Table 4-1 Troubleshooting

SYMPTOM	PROBABLE CAUSE (s)	REMEDY
Unable to turn on the scale.	<ol style="list-style-type: none"> 1. Power cord not plugged in or properly connected. 2. Power outlet not supplying power. 3. Batteries out of power. 4. Other failure. 	<ol style="list-style-type: none"> 1. Check power cord connections. Make sure power cord is plugged in properly into the power outlet. 2. Check power source. 3. Change batteries. 4. Service required.
Cannot zero the scale, or will not zero when turned on.	<ol style="list-style-type: none"> 1. Weights on the platform exceeds allowable limits. 2. Weight is not stable. 3. Load cell is damaged. 	<ol style="list-style-type: none"> 1. Remove weights from the platform. 2. Wait for platform to become stable, check area around the scale and weight on scale for excessive vibration. 3. Service required.
Error B.1	Weight reading exceeds the maximum capacity value.	<ol style="list-style-type: none"> 1. Remove weight from the platform. 2. Recalibrate the scale (See 3.4).
Error B.2	Weight reading below the minimum capacity value.	<ol style="list-style-type: none"> 1. Add weight to the platform. 2. Recalibrate the scale.
Error B.3	Weight reading exceeds Overload limit.	Reduce load on the platform.
Error B.4	Weight reading below Underload limit.	<ol style="list-style-type: none"> 1. Add weight to the platform. 2. Recalibrate the scale.
Battery symbol flashing	Low battery	Remove dry cell.
Lo bAt OFF	Low battery	Remove dry cell.
ERR E	Calibration failure	Use correct calibration weight.

4.3 Service Information

If the troubleshooting section does not resolve your problem, you can contact an authorized OHAUS Service Agent.

5. TECHNICAL DATA

5.1 Specifications

Equipment Ratings:

Indoor use only
 Altitude: 2,000m/6,562ft
 Operating temperature: -10°C to 40°C (14°F to 104°F)
 Humidity: Maximum relative humidity 80% for temperatures up to 31 °C (87.8°F) decreasing linearly to 50% relative humidity at 40°C (104°F).
 Electrical supply: 5VDC, 1A. (For use with certified or approved power supply, which must have a SELV and limited energy output.)
 or 3 x AA (LR6) Batteries.
 Voltage fluctuations: Mains supply voltage fluctuations up to ±10% of the nominal voltage.
 Overvoltage category: II
 (Installation category): II
 Pollution degree: 2

Table 5-1 Models Specification

Model	i-C31M35R	i-C31M75R	i-C31M200R	i-C31M75L	i-C31M200L
Capacity × Readability	35 kg x 0.02 kg 70 lb x 0.05 lb	75 kg x 0.05 kg 150 lb x 0.1 lb	200 kg x 0.1 kg 400 lb x 0.2 lb	75 kg x 0.05 kg 150 lb x 0.1 lb	200 kg x 0.1 kg 400 lb x 0.2 lb
Maximum Displayed Resolution	1:1,750	1:1,500	1:2,000	1:1,500	1:2,000
Weighing Units	kg, lb				
Application Mode	Weighing, Display Hold				
Operating Temperature Range	14°F to 104°F / -10°C to 40°C				
Keyboard	2 mechanical function keys				
Display	28 mm / 1.1 in digit height LCD display with white backlight				
Stabilization Time	1 second				
Power	Dry cell battery: 3 x AA (LR6) Batteries or AC Power adapter: 100-240VAC ~ 0.5A 50/60Hz; power output: 5.0 VDC 1.0 A				
Battery Life	100 hours continuous use with backlight off				
Safe Overload Capacity	150% of capacity				
Construction	ABS Plastic Indicator Housing Painted steel base with rubber feet - L models with smooth platform and adjustable feet, R models with raised, embossed tread				
Cable Length	2m				
Platform Dimensions (L x W x H)	329 x 319 x 43.5 mm / 13.0 x 12.6 x 1.7 in		520 x 400 x 52.9 mm / 20.5 x 15.7 x 2.1 in		
Net Weight	2.7 kg / 6.0 lb		8 kg / 17.6 lb		
Shipping Weight	3.4 kg / 7.5 lb		9 kg / 19.8 lb		
Shipping Dimensions	395 x 385 x 155 mm / 15.6 x 15.2 x 6.1 in		600 x 485 x 100 mm / 23.6 x 19.1 x 3.9 in		

5.2 Drawings and Dimensions



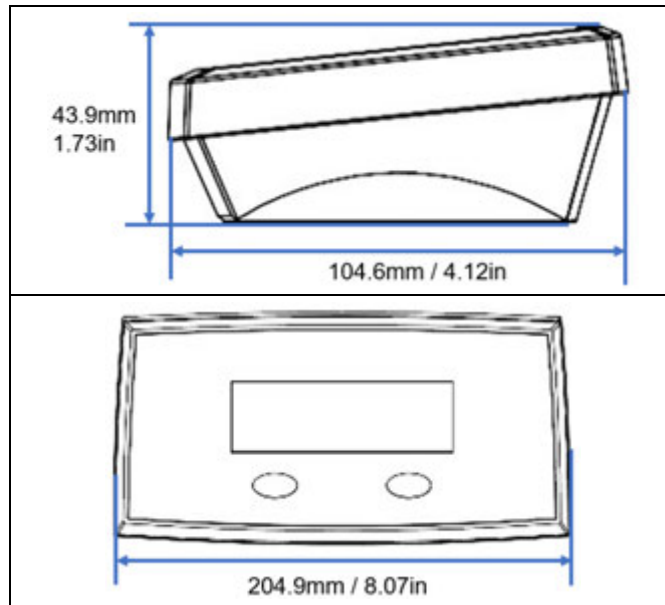

Terminal Dimensions (All Models)



Model	Base Dimensions	
i-C31MXXR		
i-C31MXXL		

6. COMPLIANCE

Compliance to the following standards is indicated by the corresponding mark on the product.

Mark	Standard
	This product complies with the applicable harmonized standards of EU Directives 2011/65/EU (RoHS), 2014/30/EU (EMC) and 2014/35/EU (LVD).
	This product complies with the applicable statutory standards of the Restriction of the Use of Certain Hazardous Substances in Electrical and Electronic Equipment Regulations 2012, UK Electromagnetic Compatibility Regulations 2016 and Electrical Equipment (Safety) Regulations 2016.
	This product complies with the EU Directive 2012/19/EU (WEEE). Please dispose of this product in accordance with local regulations at the collecting point specified for electrical and electronic equipment.
	EN 61326-1

ISED Canada Compliance Statement:

CAN ICES-003(A) / NMB-003(A)

ISO 9001 Registration

The management system governing the production of this product is ISO 9001 certified.

FCC Supplier Declaration of Conformity

Unintentional Radiator per 47CFR Part B

Trade Name: OHAUS CORPORATION

Model or Family identification: i-C31

FCC Compliance Statement:

Note: This equipment has been tested and found to comply with the limits for a Class A digital device, pursuant to part 15 of the FCC Rules. These limits are designed to provide reasonable protection against harmful interference when the equipment is operated in a commercial environment. This equipment generates, uses, and can radiate radio frequency energy and, if not installed and used in accordance with the instruction manual, may cause harmful interference to radio communications. Operation of this equipment in a residential area is likely to cause harmful interference in which case the user will be required to correct the interference at his own expense.

Changes or modifications not expressly approved by the party responsible for compliance could void the user's authority to operate the equipment.

LIMITED WARRANTY

OHAUS products are warranted against defects in materials and workmanship from the date of delivery through the duration of the warranty period. During the warranty period OHAUS will repair, or, at its option, replace any component(s) that proves to be defective at no charge, provided that the product is returned, freight prepaid, to OHAUS. This warranty does not apply if the product has been damaged by accident or misuse, exposed to radioactive or corrosive materials, has foreign material penetrating to the inside of the product, or as a result of service or modification by other than OHAUS. In lieu of a properly returned warranty registration card, the warranty period shall begin on the date of shipment to the authorized dealer. No other express or implied warranty is given by OHAUS Corporation. OHAUS Corporation shall not be liable for any consequential damages.

As warranty legislation differs from state to state and country to country, please contact OHAUS or your local OHAUS dealer for further details.