

HIOKI

CURRENT SENSOR Series
CURRENT PROBE Series

NEW



Application-optimized Current Sensors and Current Probes



5 Commonwealth Ave
Woburn, MA 01801

TestEquipmentDepot.com

Application-optimized current sensors and current probes

Hioki offers lineup of current sensors and current probes to accommodate current measurement requirements in a variety of applications, from development and evaluation in advanced fields to quality control of commercial power supplies.



Evaluating power conversion efficiency in EVs

Evaluate vehicles' overall power conversion efficiency in order to develop automobiles that run further with less energy.

CT6904A, CT687xA series + PW8001



Evaluating the fuel (energy) efficiency of finished vehicles

Measure fuel efficiency based on the international standard (WLTP) in order to evaluate the fuel efficiency of finished vehicles.

CT684xA series + PW3390

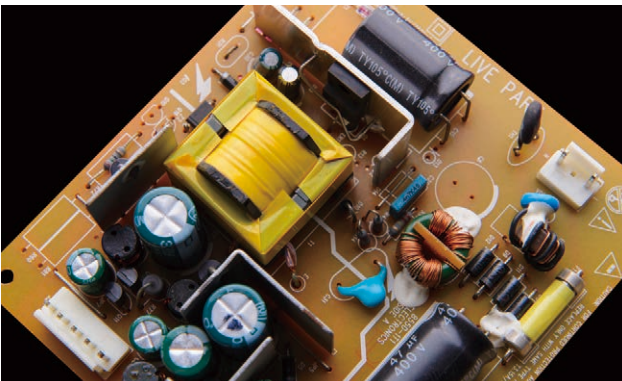

Evaluating power devices in power supply circuits

Observe the inputs and outputs of the current waveform in order to evaluate whether power devices are providing the required level of performance.

CT67xx series, 327x series + MR6000



Evaluating systems used to control accessory components in automobiles

Observe current waveforms of various magnitudes that fluctuate depending on the state of the device in question, including dark current, inrush current, and drive current, in order to evaluate accessory control.

CT67xx series, 327x series + MR6000



Maintaining power quality

Continuously monitor power quality and analyze the causes of power supply issues in order to maintain stable power quality.

CT7xxx series, CT9667-0x series + PQ3198, PQ3100



Assessing the power consumption of equipment and systems

Assess the power consumption of devices and systems in order to pursue energy-saving activities and achieve the goals of the UN's Sustainable Development Goals (SDGs).

CT7xxx series, CT9667-0x series + PW3365

Applications by operating current and operating frequency

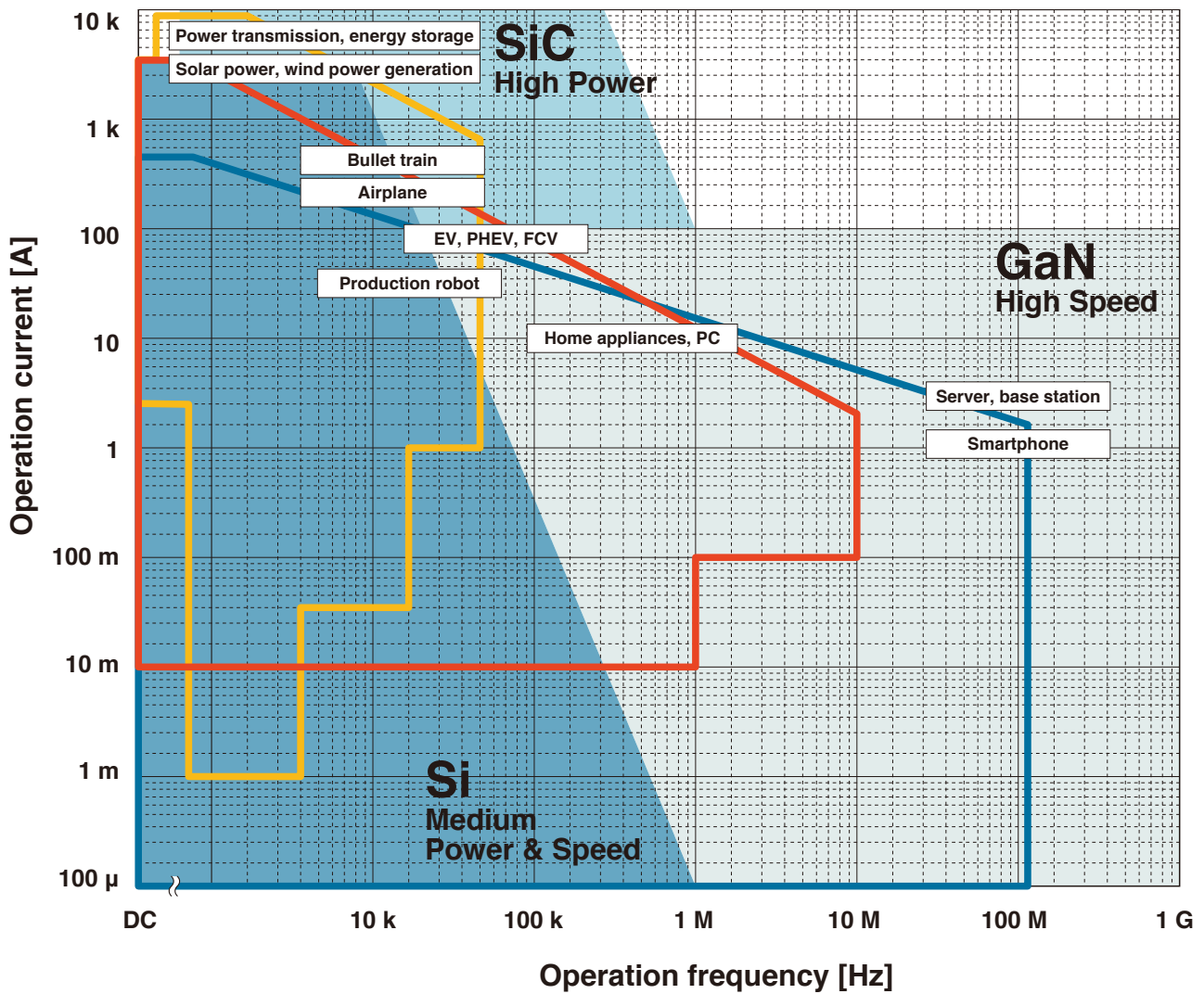

| | | | |
|----------------------------|--|-----------------------------------|--|
| High-accuracy measurement | | pass-through types | - EV inverter systems R&D - Assessment of reactor and transformer losses |
| | | clamp types | - WLTP-compliant fuel economy (electricity cost) performance testing |
| Waveform observation | | High-sensitivity observation | - Evaluation of automotive accessory control - Evaluation of power components in power supply circuits |
| | | Observation of minuscule currents | - Evaluation of automotive accessory control - Development and evaluation of power-saving devices such as wearables |
| | | Observation of large currents | - Fluctuations in fluctuation of load currents of large industrial equipment - Measurement of inrush currents flowing when starting an engine |
| Grid power quality control | | Measurement of load currents | - Assessment of power consumption - Periodic inspection of power supply equipment and monitoring of power quality |
| | | Measurement of large currents | |
| | | Measurement of leakage currents | - Detection of intermittent electrical leaks - Search for the locations of electrical leaks |

Current Sensors Current Probes Lineup

Hioki's first current sensor was a magnetic current sensor developed in-house in 1971. We've pursued sensing technologies over the past 50 years, providing a variety of current sensors for the full range of measurement applications.

High-accuracy measurement

These models, rated for 20 A to 2000 A, measure currents in a frequency band from DC to 10 MHz with a high degree of accuracy. They're used in applications that require high measurement accuracy, for example evaluation of inverter equipment and evaluation of loss in reactors and transformers.

Pass-through types

Pass-through sensors deliver the ultimate level of accuracy and stability. With a broadband measurement at up to 10 MHz and measurement of large currents of up to 2000 A, they're used in state-of-the-art research and development.



EV inverter system R&D

Evaluation of reactor and transformer losses

Clamp types

Clamp-type sensors are quick and easy to connect, and used for testing finished products, an application where it is difficult to cut wires. Capable of functioning at temperatures from -40°C to 85°C, they're used in high-temperature environments such as engine compartments.



WLTP-compliant fuel economy

(electricity cost) performance testing

Direct-wired types

Directly wired current sensors deliver world-class accuracy and frequency band characteristics (50 A model) by Hioki's proprietary DCCT (Direct Connection Current Transducer) method

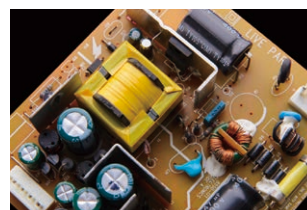

Evaluation of reactor and transformer losses

Evaluation of inverters in energy-saving household appliances

Waveform observation

These models, rated from 0.5 A to 500 A, measure current waveforms in a frequency band of DC to 120 MHz. They're used to analyze fluctuations during operation of various types of equipment operation, including standby current, inrush current, load current, and control current.

High-sensitivity observation

These models can measure current waveforms that range in magnitude from minuscule to large. With the high-sensitivity ranges and an output rate of 10 V/A, minuscule currents that fluctuate at high speeds can be clearly observed.



Evaluation of automotive accessory control

Evaluation of power devices in power supply circuits

Observation of minuscule currents

These models can measure minuscule current waveforms, including control currents flowing in control circuits and fluctuations in the current consumption of compact electronic devices that operate at small currents.



Evaluation of automotive accessory control

Development and evaluation of power-saving devices such as wearables

Observation of large currents

These models can measure large current waveforms, including fluctuations in load current from the operation of industrial equipment and inrush currents when power supplies are activated.



Fluctuations of load currents of large industrial equipment

Measurement of inrush currents flowing at engine start

Grid power quality control

These models are engineered primarily to measure current at commercial frequencies (50/60 Hz). They're used in applications such as power quality checks and power consumption assessments. We offer models with specifications suitable for a range of measurement locations, from leakage currents to large currents.

Measurement of load current

These sensors are primarily designed to measure commercial power supplies. They're used to monitor and analyze power quality and to measure power consumption.

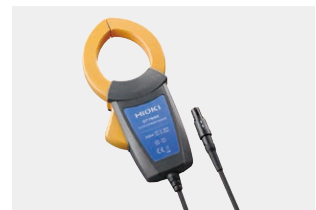

Assessment of power consumption

Periodic inspection of power supply equipment and monitoring of power quality

Measurement of large currents

These sensors can measure large currents of up to 6000 A. Their slim, flexible form make them easy to insert into narrow gaps and between wires.



Assessment of power consumption

Periodic inspection of power supply equipment and monitoring of power quality

Measurement of leakage currents

These sensors are used to measure minuscule currents such as leakage currents.

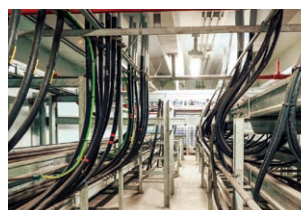

Detection of intermittent electrical leaks

Search for the locations of electrical leaks

High-accuracy measurement Output terminals: ME15W

Pass-through types

| | | | | |
|------------------|-------------------------|------------------------------------|-------------------------|-------------------------|
| 50 A | $\phi 24$ mm (0.94 in.) | $\phi 24$ mm (0.94 in.) NEW | | |
| | | | | |
| | 50 A | 50 A | | |
| | DC to 1 MHz | DC to 10 MHz | | |
| | CT6862-05 | CT6872, CT6872-01 | | |
| 200 A | $\phi 24$ mm (0.94 in.) | $\phi 24$ mm (0.94 in.) NEW | | |
| | | | | |
| | 200 A | 200 A | | |
| | DC to 500 kHz | DC to 10 MHz | | |
| | CT6863-05 | CT6873, CT6873-01 | | |
| 500 A | $\phi 36$ mm (1.42 in.) | $\phi 36$ mm (1.42 in.) | $\phi 32$ mm (1.26 in.) | $\phi 32$ mm (1.26 in.) |
| | | | | |
| | 500 A | 500 A | 500 A | 500 A |
| | DC to 2 MHz | DC to 1.5 MHz | DC to 4 MHz | DC to 2 MHz |
| | CT6875A | CT6875A-1 | CT6904A | CT6904A-1 |
| 800 A | $\phi 32$ mm (1.26 in.) | $\phi 32$ mm (1.26 in.) | | |
| | | | | |
| | 800 A | 800 A | | |
| | DC to 4 MHz | DC to 2 MHz | | |
| | CT6904A-2 | CT6904A-3 | | |
| 1000 A 2000 A | $\phi 36$ mm (1.42 in.) | $\phi 36$ mm (1.42 in.) | $\phi 80$ mm (3.15 in.) | |
| | | | | |
| | 1000 A | 1000 A | 2000 A | |
| | DC to 1.5 MHz | DC to 1.2 MHz | DC to 1 MHz | |
| | CT6876A | CT6876A-1 | CT6877A, CT6877A-1 | |

Clamp types

| | | | | |
|-----------------|-------------------------|-------------------------|-------------------------|--|
| 20 A 200 A | $\phi 20$ mm (0.79 in.) | $\phi 20$ mm (0.79 in.) | $\phi 46$ mm (1.81 in.) | |
| | | | | |
| | 20 A | 200 A | 20 A/200 A | |
| | DC to 2 MHz | DC to 700 kHz | 1 Hz to 100 kHz | |
| | CT6841A | CT6843A | 9272-05 | |
| 500 A 1000 A | $\phi 20$ mm (0.79 in.) | $\phi 50$ mm (1.97 in.) | $\phi 50$ mm (1.97 in.) | |
| | | | | |
| | 500 A | 500 A | 1000 A | |
| | DC to 500 kHz | DC to 200 kHz | DC to 100 kHz | |
| | CT6844A | CT6845A | CT6846A | |

Waveform observation Output terminals: BNC

Minuscule current waveforms can be observed more clearly by generating output at 10 V/A

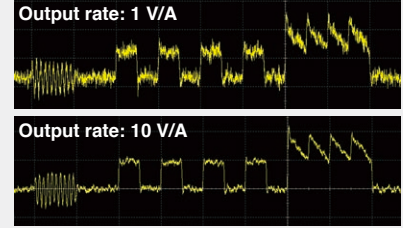

| Model | Measurement range | Output rate |
|------------------|-------------------|-------------|
| CT6710 CT6711 | 0.5 A | 10 V/A |
| | 5 A | 1 V/A |
| CT6700 CT6701 | 30 A | 0.1 V/A |
| | 5 A | 1 V/A |
| 3273-50 3276 | 30 A | 0.1 V/A |
| | 150 A | 0.01 V/A |
| 3275 | 500 A | 0.01 V/A |

High-sensitivity observation

| | | | |
|----------------------|------------------------|------------------------|--|
| 0.5 A 5 A 30 A | $\phi 5$ mm (0.20 in.) | $\phi 5$ mm (0.20 in.) | |
| | | | |
| | 0.5 A, 5 A, 30 A | 0.5 A, 5 A, 30 A | |
| | DC to 50 MHz | DC to 120 MHz | |
| | CT6710 | CT6711 | |

Observation of minuscule currents

| | | | |
|-----|------------------------|------------------------|--|
| 5 A | $\phi 5$ mm (0.20 in.) | $\phi 5$ mm (0.20 in.) | |
| | | | |
| | 5 A | 5 A | |
| | DC to 50 MHz | DC to 120 MHz | |
| | CT6700 | CT6701 | |

Observation of large currents

| | | | |
|----------------|-------------------------|-------------------------|--|
| 30 A | $\phi 5$ mm (0.20 in.) | $\phi 5$ mm (0.20 in.) | |
| | | | |
| | 30 A | 30 A | |
| | DC to 50 MHz | DC to 100 MHz | |
| | 3273-50 | 3276 | |
| 150 A 500 A | $\phi 20$ mm (0.79 in.) | $\phi 20$ mm (0.79 in.) | |
| | | | |
| | 150 A | 500 A | |
| | DC to 10 MHz | DC to 2 MHz | |
| | 3274 | 3275 | |

Grid power quality control Output terminals:
PL14

Measurement of load current

60 A
100 A

φ15 mm (0.59 in.)



60 A

40 Hz to 20 kHz

CT7126

φ15 mm (0.59 in.)



100 A

40 Hz to 20 kHz

CT7131

100 A

φ33 mm (1.30 in.)



100 A

DC to 5 kHz

CT7731

φ33 mm (1.30 in.)



100 A

DC to 10 kHz

CT7631

600 A

φ33 mm (1.30 in.)



600 A

DC to 5 kHz

CT7736

φ33 mm (1.30 in.)



600 A

DC to 10 kHz

CT7636

φ46 mm (1.81 in.)



600 A

40 Hz to 20 kHz

CT7136

2000 A

φ55 mm (2.17 in.)



2000 A

DC to 5 kHz

CT7742

φ55 mm (2.17 in.)



2000 A

DC to 10 kHz

CT7642

Measurement of large currents

6000 A

φ100 mm (3.94 in.)



6000 A

10 Hz to 50 kHz

CT7044

φ180 mm (7.09 in.)



6000 A

10 Hz to 50 kHz

CT7045

φ254 mm (10.0 in.)



6000 A

10 Hz to 50 kHz

CT7046

Measurement of leakage current

6 A

φ40 mm (1.57 in.)



6 A

40 Hz to 5 kHz

CT7116

Grid power quality control Output terminals:
BNC*1

Measurement of load current

5 A
50 A

φ15 mm (0.59 in.)



5 A

40 Hz to 5 kHz

9694

φ15 mm (0.59 in.)



50 A

40 Hz to 5 kHz

9695-02*1

100 A

φ15 mm (0.59 in.)



100 A

40 Hz to 5 kHz

9660

φ15 mm (0.59 in.)



100 A

40 Hz to 5 kHz

9695-03*1

500 A
1000 A

φ46 mm (1.81 in.)



10 A to 500 A*2

40 Hz to 1 kHz

9010-50

φ46 mm (1.81 in.)



10 A to 500 A*2

40 Hz to 3 kHz

9018-50

φ46 mm (1.81 in.)



20 A to 1000 A*3

40 Hz to 1 kHz

9132-50

φ46 mm (1.81 in.)



500 A

40 Hz to 1 kHz

CT6500

φ46 mm (1.81 in.)



500 A

40 Hz to 5 kHz

9661

φ55 mm (2.17 in.)



1000 A

40 Hz to 5 kHz

9669

*1: The 9695-02 and 9695-03 use an M3 terminal block for their output terminals. Optional Connection Cable 9219 is required.
*2: Range-switched (10, 20, 50, 100, 200, 500 A AC)
*3: Range-switched (20, 50, 100, 200, 500, 1000 A AC)

Measurement of large currents

500 A
5000 A

φ100 mm (3.94 in.)



500 A, 5000 A

10 Hz to 20 kHz

CT9667-01

φ180 mm (7.09 in.)



500 A, 5000 A

10 Hz to 20 kHz

CT9667-02

φ254 mm (10.0 in.)



500 A, 5000 A

10 Hz to 20 kHz

CT9667-03

Measurement of leakage current

10 A

φ40 mm (1.57 in.)



10 A

40 Hz to 5 kHz

9657-10

φ30 mm (1.18 in.)



10 A

















40 Hz to 5 kHz

9675







High-accuracy measurement

Output terminals: ME15W



Pass-through types

| Model | Appearance | Rated primary current | Maximum peak current | Withstand voltage*2 | Output voltage | Frequency range | Linearity error | Offset error | Amplitude errors |
|-----------|---|-----------------------|----------------------|---------------------|----------------|-----------------|-----------------|--------------|---|
| CT6862-05 |  | 50 Arms | ±141 A peak | 7.4 kV AC | 40 mV/A | DC to 1 MHz | - | - | - |
| CT6872 |  | 50 Arms | ±200 A peak | 7.4 kV AC | 40 mV/A | DC to 10 MHz | ±2 ppm | ±5 ppm | DC: 7 ppm 10 Hz to 100 Hz: 0.005% 100 Hz to 1 kHz: 0.01% 1 kHz to 50 kHz: 0.1% 50 kHz to 100 kHz: 0.3% 100 kHz to 300 kHz: 1% 300 kHz to 1 MHz: 3% |
| CT6872-01 |  | 50 Arms | ±200 A peak | 7.4 kV AC | 40 mV/A | DC to 10 MHz | ±2 ppm | ±5 ppm | |
| CT6863-05 |  | 200 Arms | ±565 A peak | 7.4 kV AC | 10 mV/A | DC to 500 kHz | - | - | - |
| CT6873 |  | 200 Arms | ±350 A peak*1 | 7.4 kV AC | 10 mV/A | DC to 10 MHz | ±2 ppm | ±5 ppm | DC: ±7 ppm 10 Hz to 500 Hz: ±0.005% 500 Hz to 3 kHz: ±0.01% 3 kHz to 30 kHz: ±0.1% 30 kHz to 100 kHz: ±0.4% 100 kHz to 400 kHz: ±1% 400 kHz to 1 MHz: ±3% |
| CT6873-01 |  | 200 Arms | ±350 A peak*1 | 7.4 kV AC | 10 mV/A | DC to 10 MHz | ±2 ppm | ±5 ppm | |
| CT6875A |  | 500 Arms | ±1500 A peak*1 | 7.4 kV AC | 4 mV/A | DC to 2 MHz | ±5 ppm | ±5 ppm | DC: ±10 ppm 10 Hz to 100 Hz: ±0.005% 100 Hz to 1 kHz: ±0.02% 1 kHz to 20 kHz: ±0.08% 20 kHz to 100 kHz: ±0.5% 100 kHz to 300 kHz: ±1% 300 kHz to 1 MHz: ±5% |
| CT6875A-1 |  | 500 Arms | ±1500 A peak*1 | 7.4 kV AC | 4 mV/A | DC to 1.5 MHz | ±5 ppm | ±5 ppm | |
| CT6904A |  | 500 Arms | ±1000 A peak*1 | 7.4 kV AC | 4 mV/A | DC to 4 MHz | ±5 ppm | ±10 ppm | - |
| CT6904A-1 |  | 500 Arms | ±1000 A peak*1 | 7.4 kV AC | 4 mV/A | DC to 2 MHz | ±5 ppm | ±10 ppm | - |
| CT6904A-2 |  | 800 Arms | ±1200 A peak*1 | 7.4 kV AC | 2 mV/A | DC to 4 MHz | ±12.5 ppm | ±10 ppm | - |
| CT6904A-3 |  | 800 Arms | ±1200 A peak*1 | 7.4 kV AC | 2 mV/A | DC to 2 MHz | ±12.5 ppm | ±10 ppm | - |
| CT6876A |  | 1000 Arms | ±1800 A peak*1 | 7.4 kV AC | 2 mV/A | DC to 1.5 MHz | ±5 ppm | ±5 ppm | DC: ±10 ppm 10 Hz to 100 Hz: ±0.005% 100 Hz to 1 kHz: ±0.03% 1 kHz to 10 kHz: ±0.2% 10 kHz to 100 kHz: ±1% 100 kHz to 300 kHz: ±3% 300 kHz to 1 MHz: ±15% |
| CT6876A-1 |  | 1000 Arms | ±1800 A peak*1 | 7.4 kV AC | 2 mV/A | DC to 1.2 MHz | ±5 ppm | ±5 ppm | |
| CT6877A |  | 2000 Arms | ±3200 A peak*1 | 7.4 kV AC | 1 mV/A | DC to 1 MHz | ±10 ppm | ±5 ppm | DC: ±15 ppm 10 Hz to 100 Hz: ±0.01% 100 Hz to 1 kHz: ±0.04% 1 kHz to 10 kHz: ±0.25% 10 kHz to 100 kHz: ±1% 100 kHz to 300 kHz: ±2% 300 kHz to 700 kHz: ±10% |
| CT6877A-1 |  | 2000 Arms | ±3200 A peak*1 | 7.4 kV AC | 1 mV/A | DC to 1 MHz | ±10 ppm | ±5 ppm | |

Clamp types

| | | | | | | | | | |
|---------|---|-------------------|-------------------------|------------|-------------------|-----------------|---------|---|---|
| 9272-05 |  | 20 Arms, 200 Arms | ±71 A peak, ±430 A peak | 5.4 kV AC | 100 mV/A, 10 mV/A | 1 Hz to 100 kHz | - | - | - |
| CT6841A |  | 20 Arms | ±60 A peak*1 | 4.26 kV AC | 100 mV/A | DC to 2 MHz | ±20 ppm | - | - |
| CT6843A |  | 200 Arms | ±600 A peak*1 | 4.26 kV AC | 10 mV/A | DC to 700 kHz | ±20 ppm | - | - |
| CT6844A |  | 500 Arms | ±800 A peak*1 | 4.26 kV AC | 4 mV/A | DC to 500 kHz | ±20 ppm | - | - |
| CT6845A |  | 500 Arms | ±1500 A peak*1 | 4.26 kV AC | 4 mV/A | DC to 200 kHz | ±20 ppm | - | - |
| CT6846A |  | 1000 Arms | ±1900 A peak*1 | 4.26 kV AC | 2 mV/A | DC to 100 kHz | ±20 ppm | - | - |

Direct-wired types

| | | | | | | | | | |
|-----------|---|---------|---------------|-----------|---------|---------------|---|---|---|
| PW9100A-3 |  | 50 Arms | ±200 A peak*1 | 5.4 kV AC | 40 mV/A | DC to 3.5 MHz | - | - | - |
| PW9100A-4 |  | 50 Arms | ±200 A peak*1 | 5.4 kV AC | 40 mV/A | DC to 3.5 MHz | - | - | - |

*1: Within 20 ms and 40°C (104°F) or less *2: Sensed current of 1 mA, 50/60 Hz, 1 min

High-accuracy measurement

Output terminals: ME15W

pass-through types

| Model | Amplitude accuracy | | Phase Shift Values | Delay times | Diameter of measurable conductors | Cable length | Operating temperature | Maximum rated voltage to earth | Automatic phase correction*3 |
|-----------|------------------------------|------------------------------|---------------------|-------------|-----------------------------------|---------------------|---------------------------------|--------------------------------|------------------------------|
| | DC | 50/60 Hz | | | | | | | |
| CT6862-05 | ±0.05% rdg. ±0.01% f.s. | ±0.05% rdg. ±0.01% f.s. | 300 kHz, -10.96° | 101 ns | φ24 mm (0.94 in.) | 3 m (9.84 ft.) | -30°C to 85°C -22°F to 185°F | 1000 V CAT III | - |
| CT6872 | ±0.03% rdg. ±0.002% f.s. | ±0.03% rdg. ±0.007% f.s. | 100 kHz, -1.28° | 46 ns | φ24 mm (0.94 in.) | 3 m (9.84 ft.) | -40°C to 85°C -40°F to 185°F | 1000 V CAT III | Yes |
| CT6872-01 | ±0.03% rdg. ±0.002% f.s. | ±0.03% rdg. ±0.007% f.s. | 100 kHz, -2.63° | 82 ns | φ24 mm (0.94 in.) | 10 m (32.81 ft.) | -40°C to 85°C -40°F to 185°F | 1000 V CAT III | Yes |
| CT6863-05 | ±0.05% rdg. ±0.01% f.s. | ±0.05% rdg. ±0.01% f.s. | 100 kHz, -4.60° | 128 ns | φ24 mm (0.94 in.) | 3 m (9.84 ft.) | -30°C to 85°C -22°F to 185°F | 1000 V CAT III | - |
| CT6873 | ±0.03% rdg. ±0.002% f.s. | ±0.03% rdg. ±0.007% f.s. | 100 kHz, -0.75° | 36 ns | φ24 mm (0.94 in.) | 3 m (9.84 ft.) | -40°C to 85°C -40°F to 185°F | 1000 V CAT III | Yes |
| CT6873-01 | ±0.03% rdg. ±0.002% f.s. | ±0.03% rdg. ±0.007% f.s. | 100 kHz, -2.10° | 69 ns | φ24 mm (0.94 in.) | 10 m (32.81 ft.) | -40°C to 85°C -40°F to 185°F | 1000 V CAT III | Yes |
| CT6875A | 0.04% rdg. ±0.008% f.s. | 0.04% rdg. ±0.008% f.s. | 200 kHz, -10.45° | 145 ns | φ36 mm (1.42 in.) | 3 m (9.84 ft.) | -40°C to 85°C -40°F to 185°F | 1000 V CAT III | Yes |
| CT6875A-1 | 0.04% rdg. ±0.008% f.s. | 0.04% rdg. ±0.008% f.s. | 200 kHz, 12.87° | 179 ns | φ36 mm (1.42 in.) | 10 m (32.81 ft.) | -40°C to 85°C -40°F to 185°F | 1000 V CAT III | Yes |
| CT6904A | ±0.025% rdg. ±0.007% f.s. | ±0.02% rdg. ±0.007% f.s. | 300 kHz, -9.82° | 91 ns | φ32 mm (1.26 in.) | 3 m (9.84 ft.) | -10°C to 50°C 14°F to 122°F | 1000 V CAT III | Yes |
| CT6904A-1 | ±0.025% rdg. ±0.007% f.s. | ±0.02% rdg. ±0.007% f.s. | 300 kHz, -9.82° | 91 ns | φ32 mm (1.26 in.) | 10 m (32.81 ft.) | -10°C to 50°C 14°F to 122°F | 1000 V CAT III | Yes |
| CT6904A-2 | ±0.030% rdg. ±0.009% f.s. | ±0.025% rdg. ±0.009% f.s. | 300 kHz, -9.82° | 91 ns | φ32 mm (1.26 in.) | 3 m (9.84 ft.) | -10°C to 50°C 14°F to 122°F | 1000 V CAT III | Yes |
| CT6904A-3 | ±0.030% rdg. ±0.009% f.s. | ±0.025% rdg. ±0.009% f.s. | 300 kHz, -9.82° | 91 ns | φ32 mm (1.26 in.) | 10 m (32.81 ft.) | -10°C to 50°C 14°F to 122°F | 1000 V CAT III | Yes |
| CT6876A | 0.04% rdg. ±0.008% f.s. | 0.04% rdg. ±0.008% f.s. | 200 kHz, -12.96° | 180 ns | φ36 mm (1.42 in.) | 3 m (9.84 ft.) | -40°C to 85°C -40°F to 185°F | 1000 V CAT III | Yes |
| CT6876A-1 | 0.04% rdg. ±0.008% f.s. | 0.04% rdg. ±0.008% f.s. | 200 kHz, -14.34° | 199 ns | φ36 mm (1.42 in.) | 10 m (32.81 ft.) | -40°C to 85°C -40°F to 185°F | 1000 V CAT III | Yes |
| CT6877A | 0.04% rdg. ±0.008% f.s. | 0.04% rdg. ±0.008% f.s. | 100 kHz, -2.63° | 73 ns | φ80 mm (3.15 in.) | 3 m (9.84 ft.) | -40°C to 85°C -40°F to 185°F | 1000 V CAT III | Yes |
| CT6877A-1 | 0.04% rdg. ±0.008% f.s. | 0.04% rdg. ±0.008% f.s. | 100 kHz, -3.34° | 93 ns | φ80 mm (3.15 in.) | 10 m (32.81 ft.) | -40°C to 85°C -40°F to 185°F | 1000 V CAT III | Yes |

clamp types

| | | | | | | | | | |
|---------|---------------------------|---------------------------|----------------------------------|-------------------|----------------------|-------------------|---------------------------------|------------------|-----|
| 9272-05 | - | ±0.3% rdg. ±0.01% f.s. | 50 kHz, -3.34° 50 kHz, -4.18° | 186 ns, 232 ns | φ46 mm (1.81 in.) | 3 m (9.84 ft.) | 0°C to 50°C 32°F to 122°F | 600 V CAT III | - |
| CT6841A | ±0.2% rdg. ±0.05% f.s. | ±0.2% rdg. ±0.01% f.s. | 100 kHz, -3.59° | 100 ns | φ20 mm (0.79 in.) | 3 m (9.84 ft.) | -40°C to 85°C -40°F to 185°F | - | Yes |
| CT6843A | ±0.2% rdg. ±0.02% f.s. | ±0.2% rdg. ±0.01% f.s. | 100 kHz, -3.96° | 110 ns | φ20 mm (0.79 in.) | 3 m (9.84 ft.) | -40°C to 85°C -40°F to 185°F | - | Yes |
| CT6844A | ±0.2% rdg. ±0.02% f.s. | ±0.2% rdg. ±0.01% f.s. | 100 kHz, -3.92° | 109 ns | φ20 mm (0.79 in.) | 3 m (9.84 ft.) | -40°C to 85°C -40°F to 185°F | - | Yes |
| CT6845A | ±0.2% rdg. ±0.02% f.s. | ±0.2% rdg. ±0.01% f.s. | 10 kHz, -0.94° | 261 ns | φ50 mm (1.97 in.) | 3 m (9.84 ft.) | -40°C to 85°C -40°F to 185°F | - | Yes |
| CT6846A | ±0.2% rdg. ±0.02% f.s. | ±0.2% rdg. ±0.01% f.s. | 10 kHz, -1.05° | 292 ns | φ50 mm (1.97 in.) | 3 m (9.84 ft.) | -40°C to 85°C -40°F to 185°F | - | Yes |









direct-wired types

| | | | | | | | | | |
|-----------|-----------------------------|-----------------------------|--------------------|-------|--------------------|------|------------------------------|--------------------------------|-----|
| PW9100A-3 | ±0.02% rdg. ±0.007% f.s. | ±0.02% rdg. ±0.005% f.s. | 300 kHz, -2.80° | 26 ns | M6 screw terminals | 3 ch | 0°C to 40°C 32°F to 104°F | 1000 V CAT II 600 V CAT III | Yes |
| PW9100A-4 | ±0.02% rdg. ±0.007% f.s. | ±0.02% rdg. ±0.005% f.s. | 300 kHz, -2.80° | 26 ns | M6 screw terminals | 4 ch | 0°C to 40°C 32°F to 104°F | 1000 V CAT II 600 V CAT III | Yes |

*3: When using PW8001

Waveform observation









Output terminals: BNC





| Model | Appearance | Rated current: output rate | Frequency range | Rise time (10% to 90%) | Delay time | Amplitude accuracy | Diameter of measurable conductors | Cable length*1 | Operating temperature |
|--|---|---|--------------------|---------------------------|---------------|-----------------------|---|------------------------------------|------------------------------|
| High-sensitivity observation of currents ranging in magnitude from minuscule to large | | | | | | | | | |
| CT6710 |  | 0.5 Arms: 10 V/A 5 Arms: 1 V/A 30 Arms: 0.1 V/A | DC to 50 MHz | 7.0 ns or less | 12 ns*2 | ±3.0% rdg. ±1 mV | φ5 mm (0.20 in.) | 1.5 m, 1 m (4.92 ft., 3.28 ft.) | 0°C to 40°C 32°F to 104°F |
| CT6711 |  | 0.5 Arms: 10 V/A 5 Arms: 1 V/A 30 Arms: 0.1 V/A | DC to 120 MHz | 2.9 ns or less | 12 ns*2 | ±3.0% rdg. ±1 mV | φ5 mm (0.20 in.) | 1.5 m, 1 m (4.92 ft., 3.28 ft.) | 0°C to 40°C 32°F to 104°F |
| Observation of minuscule currents | | | | | | | | | |
| CT6700 |  | 5 Arms: 1 V/A | DC to 50 MHz | 7.0 ns or less | 13 ns | ±3.0% rdg. ±1 mV | φ5 mm (0.20 in.) | 1.5 m, 1 m (4.92 ft., 3.28 ft.) | 0°C to 40°C 32°F to 104°F |
| CT6701 |  | 5 Arms: 1 V/A | DC to 120 MHz | 2.9 ns or less | 12 ns | ±3.0% rdg. ±1 mV | φ5 mm (0.20 in.) | 1.5 m, 1 m (4.92 ft., 3.28 ft.) | 0°C to 40°C 32°F to 104°F |
| Observation of large currents | | | | | | | | | |
| 3273-50 |  | 30 Arms: 0.1 V/A | DC to 50 MHz | 7.0 ns or less | 16 ns | ±1.0% rdg. ±1 mV | φ5 mm (0.20 in.) | 1.5 m, 1 m (4.92 ft., 3.28 ft.) | 0°C to 40°C 32°F to 104°F |
| 3276 |  | 30 Arms: 0.1 V/A | DC to 100 MHz | 3.5 ns or less | 14 ns | ±1.0% rdg. ±1 mV | φ5 mm (0.20 in.) | 1.5 m, 1 m (4.92 ft., 3.28 ft.) | 0°C to 40°C 32°F to 104°F |
| 3274 |  | 150 Arms: 0.01 V/A | DC to 10 MHz | 35 ns or less | 40 ns | ±1.0% rdg. ±1 mV | φ20 mm (0.79 in.) | 2.0 m, 1 m (6.56 ft., 3.28 ft.) | 0°C to 40°C 32°F to 104°F |
| 3275 |  | 500 Arms: 0.01 V/A | DC to 2 MHz | 175 ns or less | 66 ns | ±1.0% rdg. ±5 mV | φ20 mm (0.79 in.) | 2.0 m, 1 m (6.56 ft., 3.28 ft.) | 0°C to 40°C 32°F to 104°F |

*1: Sensor cable: cable between relay box and sensor for models with relay boxes (i.e. CT6710, CT6711), power supply cable for other models *2: When using 0.5 A range: 13 ns













Grid power quality control

Output terminals: PL14

| Model | Appearance | Rated current | Frequency range | Amplitude accuracy | Diameter of measurable conductors | Cable length | Operating temperature | CAT |
|------------------------------------|---|---------------|--------------------|---------------------------|---|---------------------|---------------------------------|--------------------------------|
| Measurement of load current | | | | | | | | |
| CT7126 |  | 60 A AC | 40 Hz to 20 kHz | ±0.3% rdg. ±0.01% f.s. | φ15 mm (0.59 in.) | 2.5 m (8.20 ft.) | -10°C to 50°C 14°F to 122°F | 300 V CAT III |
| CT7131 |  | 100 A AC | 40 Hz to 20 kHz | ±0.3% rdg. ±0.02% f.s. | φ15 mm (0.59 in.) | 2.5 m (8.20 ft.) | -10°C to 50°C 14°F to 122°F | 300 V CAT III |
| CT7731 |  | 100 A AC/DC | DC to 5 kHz | ±1.0% rdg. ±0.5% f.s. | φ33 mm (1.30 in.) | 2.5 m (8.20 ft.) | -25°C to 65°C -13°F to 149°F | 600 V CAT IV |
| CT7631 |  | 100 A AC/DC | DC to 10 kHz | ±1.0% rdg. ±0.5% f.s. | φ33 mm (1.30 in.) | 2.5 m (8.20 ft.) | -25°C to 65°C -13°F to 149°F | 600 V CAT IV |
| CT7736 |  | 600 A AC/DC | DC to 5 kHz | ±2.0% rdg. ±0.5% f.s. | φ33 mm (1.30 in.) | 2.5 m (8.20 ft.) | -25°C to 65°C -13°F to 149°F | 600 V CAT IV |
| CT7636 |  | 600 A AC/DC | DC to 10 kHz | ±2.0% rdg. ±0.5% f.s. | φ33 mm (1.30 in.) | 2.5 m (8.20 ft.) | -25°C to 65°C -13°F to 149°F | 600 V CAT IV 1000 V CAT III |
| CT7136 |  | 600 A AC | 40 Hz to 20 kHz | ±0.3% rdg. ±0.01% f.s. | φ46 mm (1.81 in.) | 2.5 m (8.20 ft.) | -10°C to 50°C 14°F to 122°F | 600 V CAT IV 1000 V CAT III |
| CT7742 |  | 2000 A AC/DC | DC to 5 kHz | ±1.5% rdg. ±0.5% f.s. | φ55 mm (2.17 in.) | 2.5 m (8.20 ft.) | -25°C to 65°C -13°F to 149°F | 600 V CAT IV 1000 V CAT III |
| CT7642 |  | 2000 A AC/DC | DC to 10 kHz | ±1.5% rdg. ±0.5% f.s. | φ55 mm (2.17 in.) | 2.5 m (8.20 ft.) | -25°C to 65°C -13°F to 149°F | 600 V CAT IV 1000 V CAT III |

| Model | Appearance | Rated current | Frequency range | Amplitude accuracy | Diameter of measurable conductors | Cable length | Operating temperature | CAT |
|---------------------------------------|---|---------------|-----------------|---------------------------|-----------------------------------|---------------------------------------|---------------------------------|--------------------------------|
| Measurement of large currents | | | | | | | | |
| CT7044 |  | 6000 A AC | 10 Hz to 50 kHz | ±1.5% rdg. ±0.25% f.s. | φ100 mm (3.94 in.) | 2.3 m, 0.2 m* (7.55 ft., 0.66 ft.) | -25°C to 65°C -13°F to 149°F | 600 V CAT IV 1000 V CAT III |
| CT7045 |  | 6000 A AC | 10 Hz to 50 kHz | ±1.5% rdg. ±0.25% f.s. | φ180 mm (7.09 in.) | 2.3 m, 0.2 m* (7.55 ft., 0.66 ft.) | -25°C to 65°C -13°F to 149°F | 600 V CAT IV 1000 V CAT III |
| CT7046 |  | 6000 A AC | 10 Hz to 50 kHz | ±1.5% rdg. ±0.25% f.s. | φ254 mm (10.00 in.) | 2.3 m, 0.2 m* (7.55 ft., 0.66 ft.) | -25°C to 65°C -13°F to 149°F | 600 V CAT IV 1000 V CAT III |
| Measurement of leakage current | | | | | | | | |
| CT7116 |  | 6 A AC | 40 Hz to 5 kHz | ±1.0% rdg. ±0.05% f.s. | φ40 mm (1.57 in.) | 2.5 m (8.20 ft.) | -25°C to 65°C -13°F to 149°F | - |

*Sensor cable: between flexible loop and circuit box for flexible sensors (e.g. CT7044), output cable for CT7116

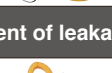
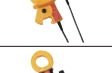
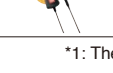

| Grid power quality control | | | | | | | | Output terminals: BNC |
|---------------------------------------|---|-------------------|-----------------|----------------------------|-----------------------------------|------------------------------------|---------------------------------|--------------------------------|
| Model | Appearance | Rated current | Frequency range | Amplitude accuracy | Diameter of measurable conductors | Cable length | Operating temperature | CAT |
| Measurement of load current | | | | | | | | |
| 9694 |  | 5 A AC | 40 Hz to 5 kHz | ±0.3% rdg. ±0.02% f.s. | φ15 mm (0.59 in.) | 3 m (9.84 ft.) | 0°C to 50°C 32°F to 122°F | 300 V CAT III |
| 9695-02*1 |  | 50 A AC | 40 Hz to 5 kHz | ±0.3% rdg. ±0.02% f.s. | φ15 mm (0.59 in.) | - | 0°C to 50°C 32°F to 122°F | 300 V CAT III |
| 9660 |  | 100 A AC | 40 Hz to 5 kHz | ±0.3% rdg. ±0.02% f.s. | φ15 mm (0.59 in.) | 3 m (9.84 ft.) | 0°C to 50°C 32°F to 122°F | 300 V CAT III |
| 9695-03*1 |  | 100 A AC | 40 Hz to 5 kHz | ±0.3% rdg. ±0.02% f.s. | φ15 mm (0.59 in.) | - | 0°C to 50°C 32°F to 122°F | 300 V CAT III |
| 9010-50 |  | 10 A to 500 A AC | 40 Hz to 1 kHz | ±2% rdg. ±1% f.s. | φ46 mm (1.81 in.) | 3 m (9.84 ft.) | 0°C to 50°C 32°F to 122°F | 600 V CAT III |
| 9018-50 |  | 10 A to 500 A AC | 40 Hz to 3 kHz | ±1.5% rdg. ±0.1% f.s. | φ46 mm (1.81 in.) | 3 m (9.84 ft.) | 0°C to 50°C 32°F to 122°F | 600 V CAT III |
| 9132-50 |  | 20 A to 1000 A AC | 40 Hz to 1 kHz | ±3% rdg. ±0.2% f.s. | φ55 mm (2.17 in.) | 3 m (9.84 ft.) | -10°C to 50°C 14°F to 122°F | 600 V CAT III |
| CT6500 |  | 500 A AC | 40 Hz to 1 kHz | ±1.5% rdg. ±0.03% f.s. | φ46 mm (1.81 in.) | 3 m (9.84 ft.) | 0°C to 50°C 32°F to 122°F | 600 V CAT III |
| 9661 |  | 500 A AC | 40 Hz to 5 kHz | ±0.3% rdg. ±0.01% f.s. | φ46 mm (1.81 in.) | 3 m (9.84 ft.) | 0°C to 50°C 32°F to 122°F | 600 V CAT III |
| 9669 |  | 1000 A AC | 40 Hz to 5 kHz | ±1.0% rdg. ±0.01% f.s. | φ55 mm (2.17 in.) | 3 m (9.84 ft.) | 0°C to 50°C 32°F to 122°F | 600 V CAT III |
| Measurement of large currents | | | | | | | | |
| CT9667-01 |  | 500 A, 5000 A AC | 10 Hz to 20 kHz | ±2% rdg. ±0.3% f.s. | φ100 mm (3.94 in.) | 2 m, 1 m*2 (6.56 ft., 3.28 ft.) | -25°C to 65°C -13°F to 149°F | 600 V CAT IV 1000 V CAT III |
| CT9667-02 |  | 500 A, 5000 A AC | 10 Hz to 20 kHz | ±2% rdg. ±0.3% f.s. | φ180 mm (7.09 in.) | 2 m, 1 m*2 (6.56 ft., 3.28 ft.) | -25°C to 65°C -13°F to 149°F | 600 V CAT IV 1000 V CAT III |
| CT9667-03 |  | 500 A, 5000 A AC | 10 Hz to 20 kHz | ±2% rdg. ±0.3% f.s. | φ254 mm (10.00 in.) | 2 m, 1 m*2 (6.56 ft., 3.28 ft.) | -10°C to 50°C 14°F to 122°F | 600 V CAT IV 1000 V CAT III |
| Measurement of leakage current | | | | | | | | |
| 9657-10 |  | 10 A AC | 40 Hz to 5 kHz | ±1.0% rdg. ±0.05% f.s. | φ40 mm (1.57 in.) | 3 m (9.84 ft.) | 0°C to 50°C 32°F to 122°F | - |
| 9675 |  | 10 A AC | 40 Hz to 5 kHz | ±1.0% rdg. ±0.005% f.s. | φ30 mm (1.18 in.) | 3 m (9.84 ft.) | 0°C to 50°C 32°F to 122°F | - |







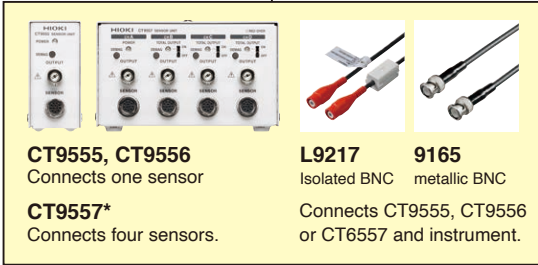











*1: The 9695-02 and 9695-03 use an M3 terminal block for their output terminals. The extra purchase of the connection cable 9219 is required.

*2: Sensor cable: between flexible loop and circuit box for flexible sensors (e.g. CT9667-01), output cable for others.

High-accuracy measurement

* Depending on the connected instruments, it may not be possible to measure up to the rated current of the current sensors.
For details, refer to the instruction manual of the connected instruments.

| ME15W | Directly wired | External power supply + connection cord | | | Conversion cable |
|-----------|----------------|---|--|--|---|
| CT6862-05 | |  <p>CT9555, CT9556 Connects one sensor</p> <p>CT9557* Connects four sensors.</p> <p>L9217 9165 Isolated BNC metallic BNC</p> <p>Connects CT9555, CT9556 or CT6557 and instrument.</p> | | |  <p>CT9901 Converts ME15W terminal to PL23 terminal</p> |
| CT6872 | | | | | |
| CT6872-01 | | | | | |
| CT6863-05 | | | | | |
| CT6873 | | | | | |
| CT6873-01 | | | | | |
| CT6875A | | | | | |
| CT6875A-1 | | | | | |
| CT6904A | | | | | |
| CT6904A-1 | | | | | |
| CT6904A-2 | | | | | |
| CT6904A-3 | | | | | |
| CT6876A | | | | | |
| CT6876A-1 | | | | | |
| CT6877A | | | | | |
| CT6877A-1 | | | | | |
| 9272-05 | | | | | |
| CT6841A | | | | | |
| CT6843A | | | | | |
| CT6844A | | | | | |
| CT6845A | | | | | |
| CT6846A | | | | | |
| PW9100A-3 | | | | | |
| PW9100A-4 | | | | | |

| ME15W | BNC | BNC | BNC | PL23 |
|---|---|--|---|---|
|  |  |  |  |  |
| PW8001 | PW3335-03 | U8975 | MR8870 | 8971+9318 |
| ME15W | BNC | BNC | BNC | |
|  |  |  |  | |
| PW6001 | PW3335-04 | U8976 | MR8880 | |
| ME15W | BNC | BNC | BNC | |
|  |  |  |  | |
| PW3390 | PW3336 | U8978 | MR8875 + MR8901 | |
| ME15W | BNC | BNC | BNC | |
|  |  |  | | |
| U8977 | PW3337 | 8966 | | |
| | | BNC | | |
| | |  | | |
| | | 8968 | | |
| | | BNC | | |
| | |  | | |
| | | 8972 | | |

CT9902 (ME15W-ME15W)
The CT9902 can be used to extend a current sensor's cable by 5 m. Up two of these cables can be used for a maximum extension of 10 m.
*When using the CT9902, an addition must be made to accuracy.
For details, see the sensor's user manual.

*The CT9557 can output four channels of input as an added waveform.

| | CONNECTION CABLE |
|--|-------------------------------|
| 1 Total RMS output (BNC) | L9217, 9165 BNC-BNC |
| 2 Total waveform output (BNC) | L9217, 9165 BNC-BNC |
| 3 Total waveform output (ME15W) | CT9904 ME15W-ME15W |

We accept special orders for extending sensor cables. For inquiries, please contact Hioki for more information.

Waveform observation

* Depending on the connected instruments, it may not be possible to measure up to the rated current of the current sensors. For details, refer to the instruction manual of the connected instruments.

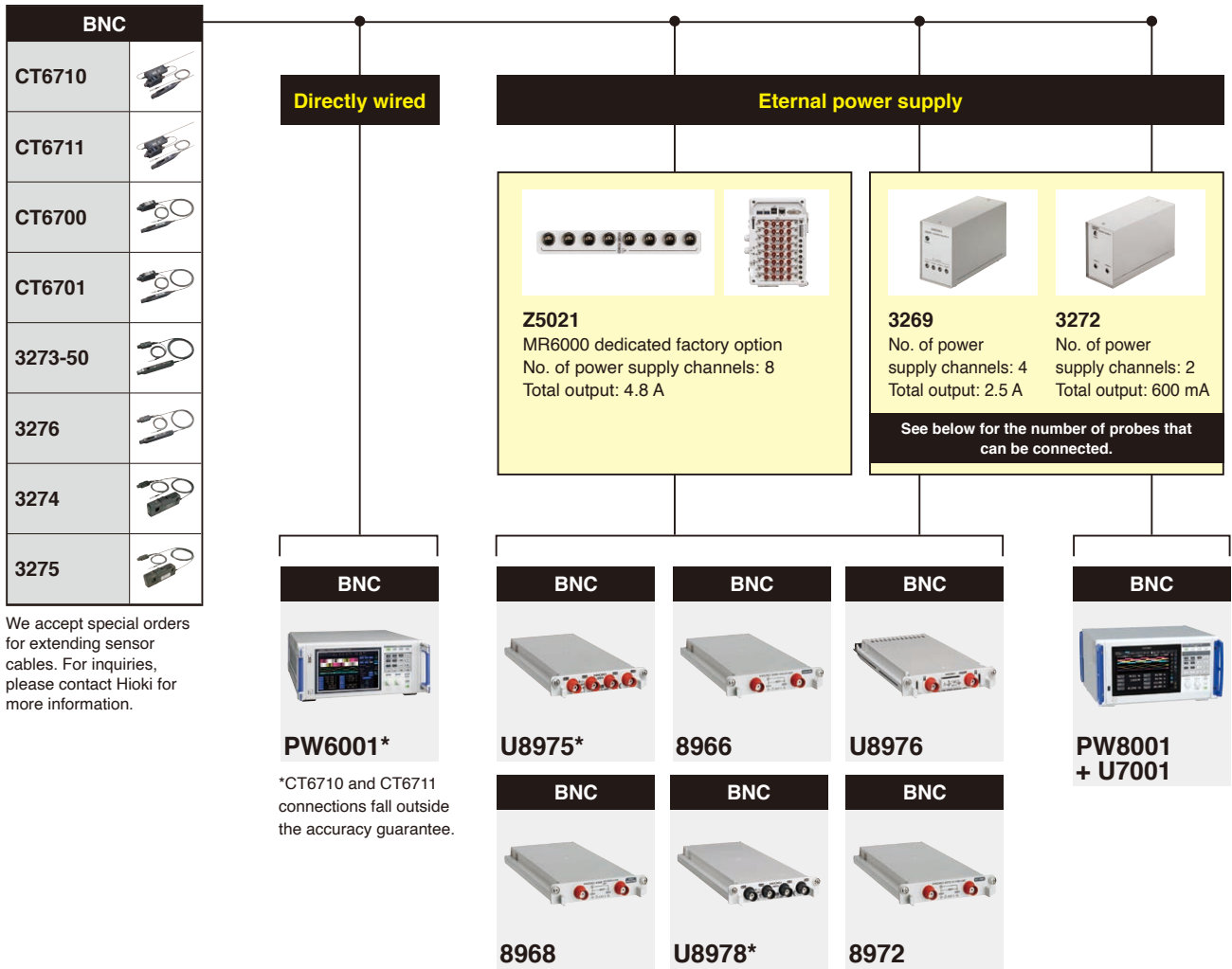

We accept special orders for extending sensor cables. For inquiries, please contact Hioki for more information.

PW6001*

*CT6710 and CT6711 connections fall outside the accuracy guarantee.

*Special-order cables are required when using three or more probes simultaneously. Please contact Hioki for details.

The following products can be used with the U8975, U8976, U8978, 8966, 8968, and 8972

| | | | | | | | | |
|--|-------|---|--|-------|---|--|-------|---|
| | U8975 | ✓ | | U8975 | ✓ | | U8975 | - |
| | U8976 | ✓ | | U8976 | - | | U8976 | - |
| | U8977 | ✓ | | U8977 | ✓ | | U8977 | - |
| | U8978 | ✓ | | U8978 | ✓ | | U8978 | - |
| | 8966 | ✓ | | 8966 | ✓ | | 8966 | ✓ |
| | 8968 | ✓ | | 8968 | ✓ | | 8968 | ✓ |
| | 8971 | ✓ | | 8971 | ✓ | | 8971 | ✓ |
| | 8972 | ✓ | | 8972 | ✓ | | 8972 | ✓ |
| | U8975 | ✓ | | U8975 | - | | U8975 | - |
| | U8976 | - | | U8976 | - | | U8976 | - |
| | U8977 | ✓ | | U8977 | - | | U8977 | - |
| | U8978 | ✓ | | U8978 | - | | U8978 | - |
| | 8966 | ✓ | | 8966 | ✓ | | 8966 | ✓ |
| | 8968 | ✓ | | 8968 | ✓ | | 8968 | ✓ |
| | 8971 | ✓ | | 8971 | ✓ | | 8971 | - |
| | 8972 | ✓ | | 8972 | ✓ | | 8972 | ✓ |

Current consumption per probe and number of probes per power supply

Current consumption varies by probe. The following table indicates how many probes can be utilized when using one type of probe per power supply.

| Sensor | Consumption current* | Z5021 | 3269 | 3272 |
|---------|----------------------|-------|------|------|
| CT6710 | approx. 650 mA | 4 | 2 | - |
| CT6711 | approx. 650 mA | 4 | 2 | - |
| CT6700 | approx. 250 mA | 8 | 4 | 2 |
| CT6701 | approx. 250 mA | 8 | 4 | 2 |
| 3273-50 | approx. 450 mA | 8 | 4 | 1 |
| 3274 | approx. 450 mA | 8 | 4 | 1 |
| 3275 | approx. 600 mA | 8 | 4 | 1 |
| 3276 | approx. 450 mA | 8 | 4 | 1 |

*When measuring the rated current.

Grid power quality control (PL14)

* Depending on the connected instruments, it may not be possible to measure up to the rated current of the current sensors. For details, refer to the instruction manual of the connected instruments.

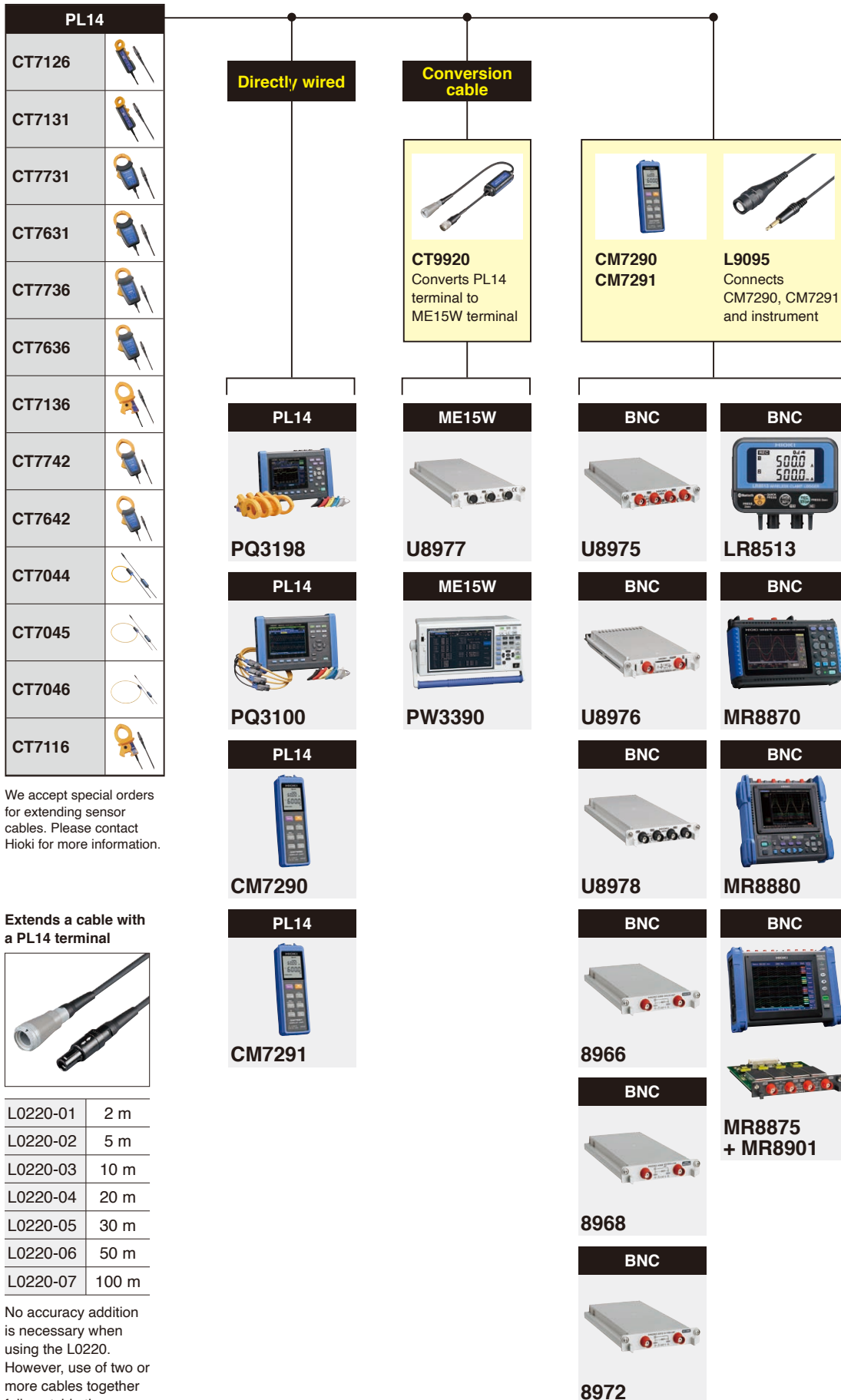

We accept special orders for extending sensor cables. Please contact Hioki for more information.

Extends a cable with a PL14 terminal



| | |
|----------|-------|
| L0220-01 | 2 m |
| L0220-02 | 5 m |
| L0220-03 | 10 m |
| L0220-04 | 20 m |
| L0220-05 | 30 m |
| L0220-06 | 50 m |
| L0220-07 | 100 m |

No accuracy addition is necessary when using the L0220. However, use of two or more cables together falls outside the accuracy guarantee.

Grid power quality control (BNC)

* Depending on the connected instruments, it may not be possible to measure up to the rated current of the current sensors. For details, refer to the instruction manual of the connected instruments.

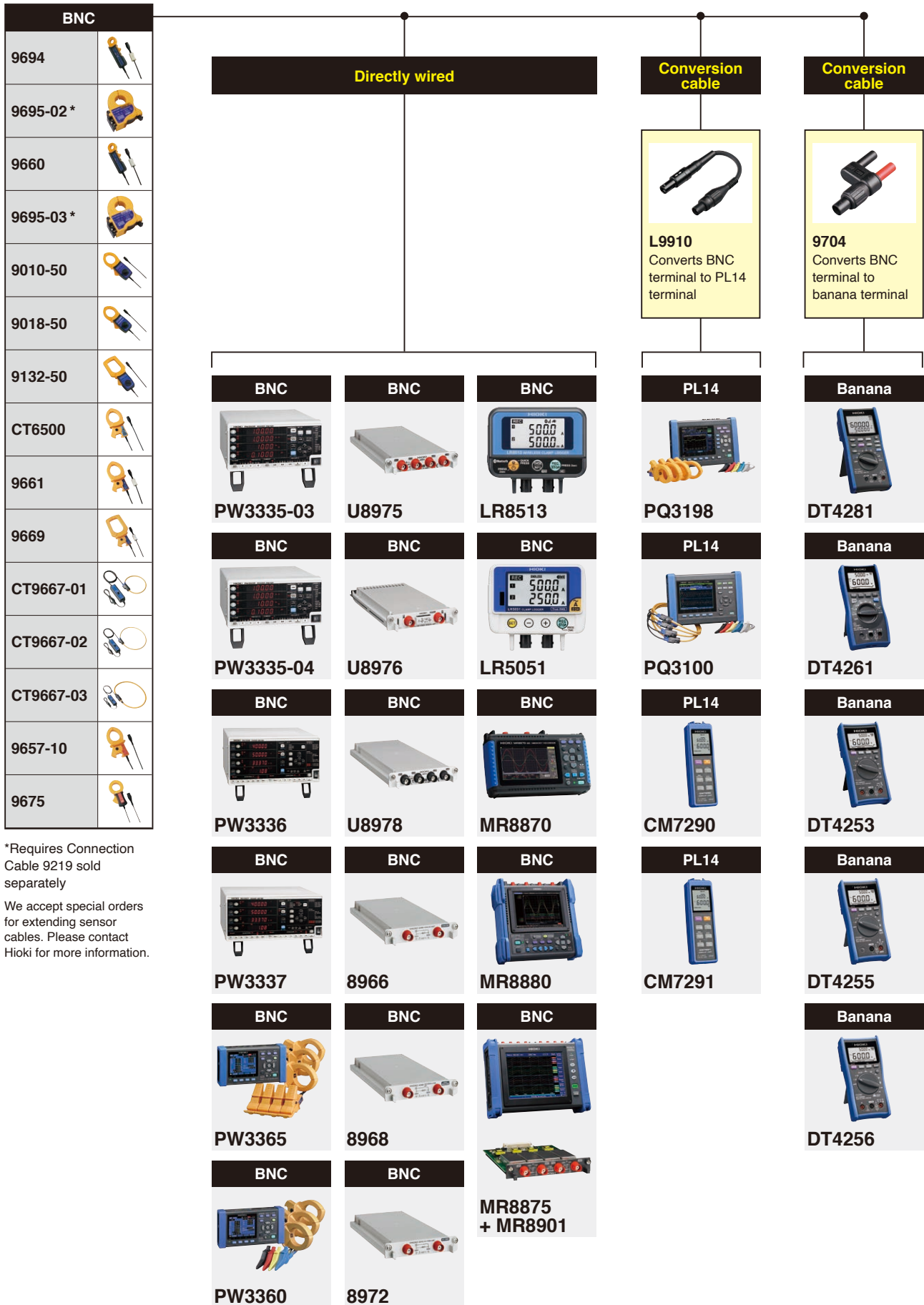

*Requires Connection Cable 9219 sold separately
 We accept special orders for extending sensor cables. Please contact Hioki for more information.

Accurately evaluating power conversion efficiency

Improving power conversion efficiency is a key part of the effort to facilitate the effective use of energy. Devices that operate at high frequencies are increasingly being used to improve efficiency, and evaluation processes undertaken during the development of such devices requires accurate measurement of power at the low frequencies used by in previous devices as well as at high frequencies. Additionally, sensors that can resist noise are necessary since noise becomes stronger as the frequency increases. Hioki offers current sensors that can measure power accurately while providing robust noise resistance over a broad band of frequencies.

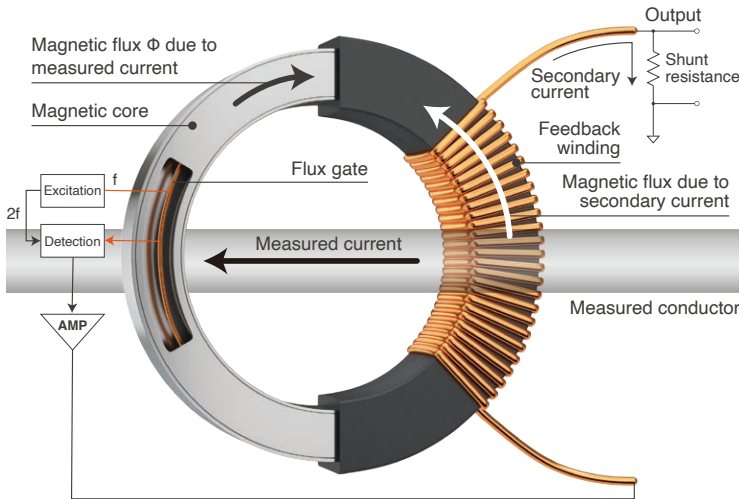

High-frequency currents are detected by a winding (CT), while DC to low-frequency currents are detected by a flux gate.

Zero-flux method: achieving stable, wideband measurement from DC to high frequencies

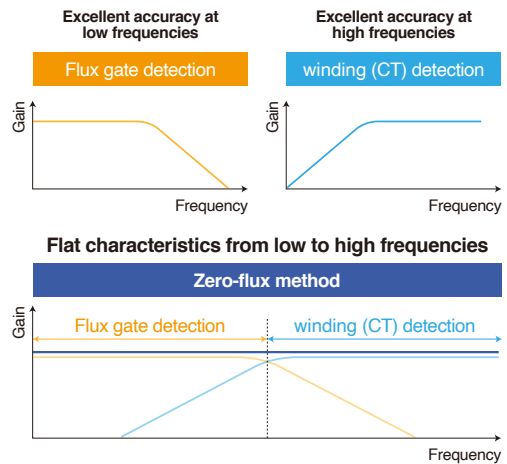

Zero-flux method (flux gate) current sensors



Application

Evaluating the power conversion efficiency of an inverter

When evaluating the power conversion efficiency of an inverter, the inverter's input and output power are measured and its efficiency is checked. PWM (pulse width modulated) inverter output, which has been widely used in recently years, contains a modulated wave (fundamental wave) and a switching frequency along with their respective harmonic components. Since switching frequencies tend to be high, the process requires wide frequency band current sensors.

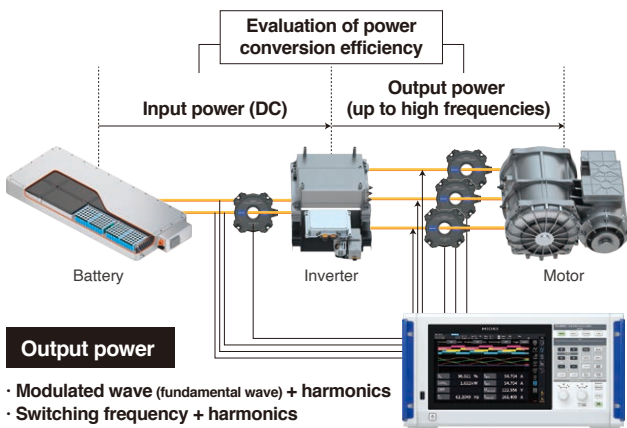

Inverter output: principal active power components

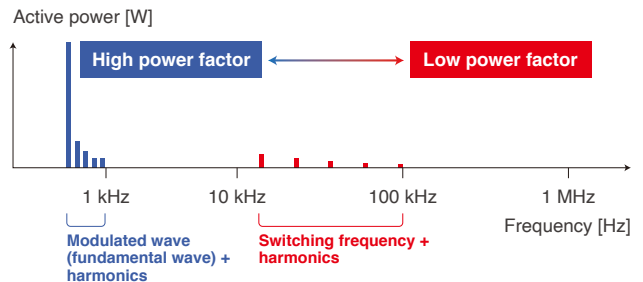

Since the power factor decreases with harmonics, current sensors' phase measurement accuracy becomes key (see right).

Phase measurement accuracy and correction: accurately measuring power at low power factors

For typical current sensors, phase measurement accuracy is not defined. However, phase measurement precision is important in applications where power must be measured with a high degree of accuracy. Power can be measured more accurately by selecting a current sensor for which phase measurement accuracy is defined in the measurement band.

At low power factors, phase error has a significant effect on power error.

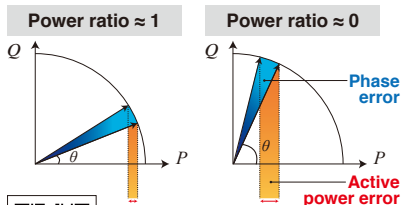

Access the QR Code to view the technical documentation on phase correction.

PW8001: Automatic Phase Correction function

Automatic acquisition of phase correction values

Power supplied from instrument

| | |
|--|---------------|
| Information stored in the current sensors' internal memory | |
| Phase shift | Rated current |
| Sensor model | Serial number |

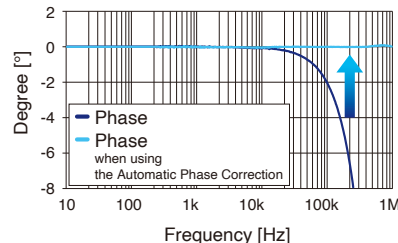

Example of the Automatic Phase Correction for the CT6904A AC/DC current sensor

The power factor decreases in the high-frequency range of the switching frequencies and other frequency components. At low power factors, phase error has a significant effect on power measured values.

For typical sensors, phase error increases with frequency. Since Hioki has developed both current sensors and the measuring instruments, current sensors' phase characteristics can be corrected by the instruments, allowing accurate power values to be calculated.

Common-mode voltage rejection ratio: measuring current values accurately in noisy environments

In high-frequency measurement, sensors' resistance to noise is critical. A sensor's ability to remove noise is expressed by its common-mode rejection ratio (CMRR). Sensors with a high CMRR reject more noise and therefore can make more accurate measurements.

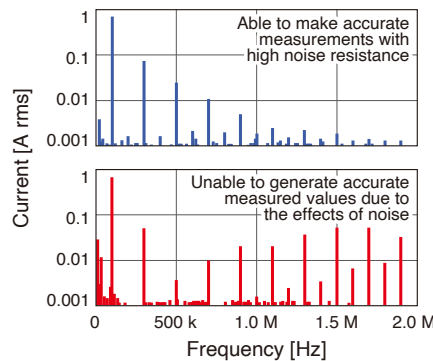
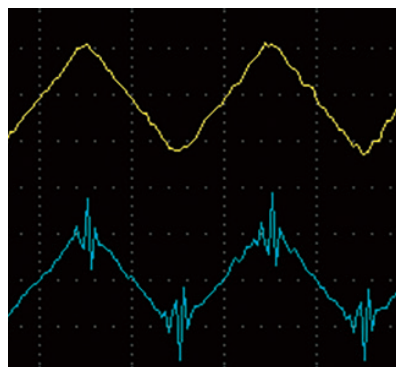
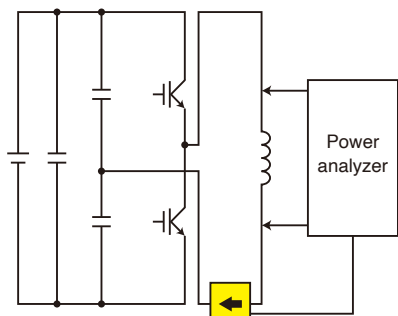

Top: CT6904A CMRR 120 dB or greater (100 Hz); bottom: sensor with a low CMRR

For reactors, higher frequencies mean lower current values. The image to the right shows a waveform obtained by measuring reactor current at high frequency along with variations in current values that accompany variations in the frequency.

Effects of conductor position: stable, highly reproducible sensing

In general, speaking, the effects of conductor position increase with frequency. Since the position of the conductor inside the clamp core affects the measurement accuracy, resulting the reproducibility of measurement reduces. Sensors are designed the effects of conductor position, highly reproducible measurements are possible since conductor position does not affect measured values.

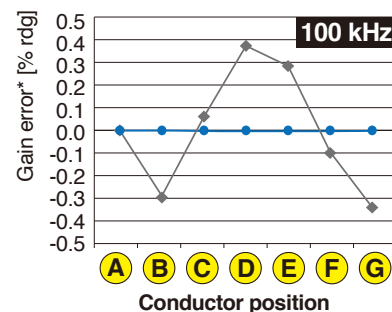
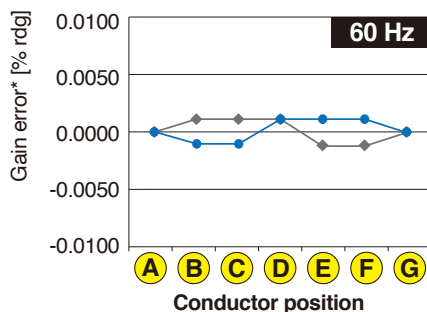

— CT6904A — Sensors designed without accounting for conductor position deviation from center

When using a sensor designed with the effects of conductor position, measured values are not affected when the conductor's position changes.

Clearly observing current waveforms

The magnitude of the currents that flow in power-saving devices during operation and control currents that flow in automotive accessory components have reduced to 1 mA or less. At the same time, reliance on high-speed switching operation for device control is resulting in increased noise. Wideband current probes that are highly resistant to noise are essential in order to clearly observe low-current waveforms without losing them in noise. Hioki offers current probes that enable clear waveform observation while providing robust noise resistance over a broad band of frequencies.

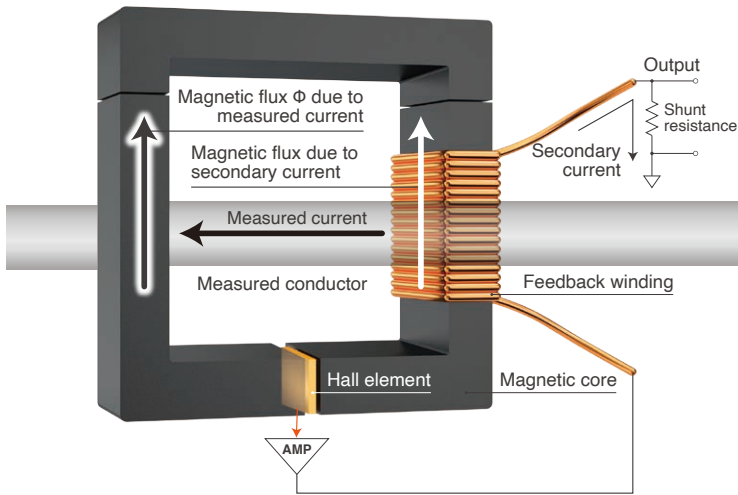

High-frequency currents are detected by the winding (CT), while DC to low-frequency currents are detected by the Hall element.

Zero-flux method: realizing stable, wideband measurement from DC to high frequencies

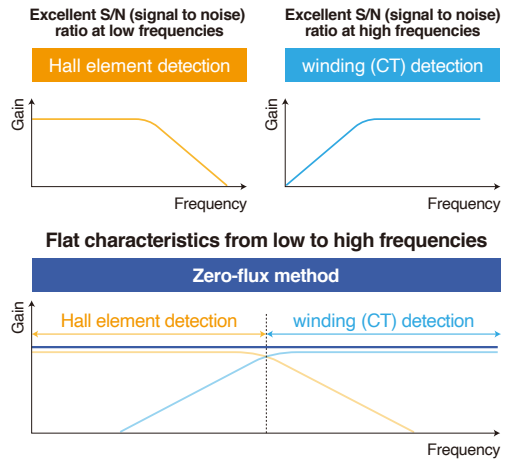

Zero-flux method (hall element) current probes



Application

Evaluating the response performance of switching devices

Switching devices control equipment by turning the power on and off. The response performance of switching devices is evaluated by observing fluctuations of current and voltage when the device cycles the power on and off. Capturing current fluctuations caused by high-speed switching operation requires current probes with a broad frequency band. Additionally, noise resistance is important since switching operation generates noise.

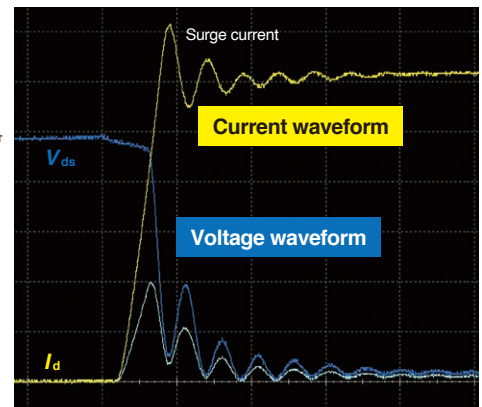
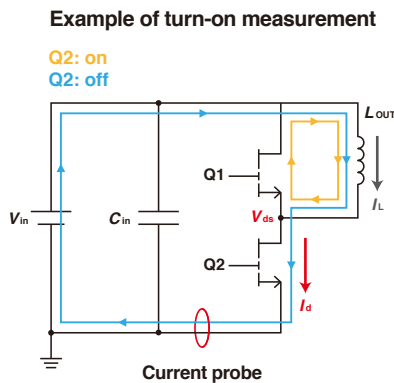
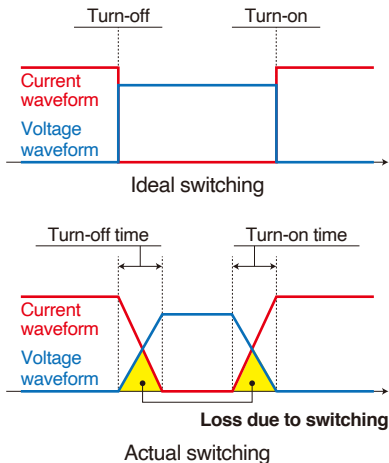

Observing waveforms from minuscule currents to large currents: evaluating the control design of ECUs and accessory components

The control systems used in ECUs and accessory components carry currents of a variety of magnitudes according to the vehicle's operation, from control currents to inrush currents. Using a current probe that can switch current ranges makes it possible to observe current waveforms associated with an array of operating conditions with a single probe.

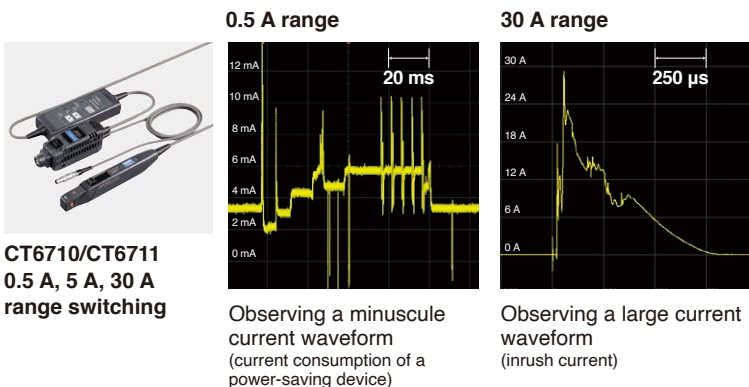

CT6710/CT6711
0.5 A, 5 A, 30 A range switching

Observing a minuscule current waveform (current consumption of a power-saving device)

Observing a large current waveform (inrush current)

| Model | Freq. band | measurement range | output rate |
|---------|---------------|-------------------|-------------|
| CT6710 | DC to 50 MHz | 0.5 A | 10 V/A |
| | | 5 A | 1 V/A |
| | | 30 A | 0.1 V/A |
| CT6711 | DC to 120 MHz | 0.5 A | 10 V/A |
| | | 5 A | 1 V/A |
| | | 30 A | 0.1 V/A |
| CT6700 | DC to 50 MHz | 5 A | 1 V/A |
| CT6701 | DC to 120 MHz | 5 A | 1 V/A |
| 3273-50 | DC to 50 MHz | 30 A | 0.1 V/A |
| 3276 | DC to 100 MHz | 30 A | 0.1 V/A |
| 3274 | DC to 10 MHz | 150 A | 0.01 V/A |
| 3275 | DC to 2 MHz | 500 A | 0.01 V/A |

Observing currents of a variety of magnitudes, from minuscule currents to large currents, with a single probe

Clearly observing minuscule currents: operating currents of power-saving devices and control currents flowing to accessory components

The magnitude of the currents that flow during operation of power-saving devices like wearables and control currents that flow in automotive accessory components tend to decrease in to 1 mA or less. Using a current probe with a high output rate make possible for clearly observing minuscule current waveforms.

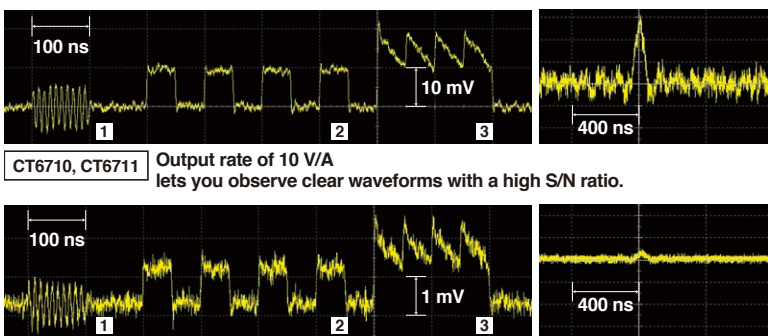

CT6710, CT6711 Output rate of 10 V/A lets you observe clear waveforms with a high S/N ratio.

Earlier model Output rate of 1 V/A precludes observation of accurate waveforms as they are obscured by noise.

- 1 Sine wave: $f = 100$ MHz, 1 mA peak-peak
- 2 Square wave: $f = 10$ MHz, 1 mA peak-peak
- 3 Sawtooth wave: $f = 20$ MHz, 1 mA peak-peak (offset +1 mA)

Noise resistance design: key to increasing output rate

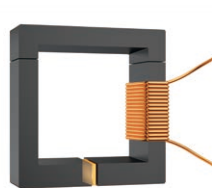

Hioki uses a proprietary Electromagnetic shielding thin-film Hall element to reduce the amount of noise generated inside the probe. resistance to environmental noise.

Observing waveforms across a broad band of frequencies: capturing waveforms and pulse waveforms that fluctuate at high speeds

Currents from switching operation of devices such as SiC and GaN inverters and currents that flow momentarily when a power supply is activated fluctuate at high speeds. Using a current probe with a wide frequency band allows you observe current waveforms that fluctuate at high speed. Additionally, such devices allow you observe current waveforms such as pulse waveforms that contain a variety of frequency components.

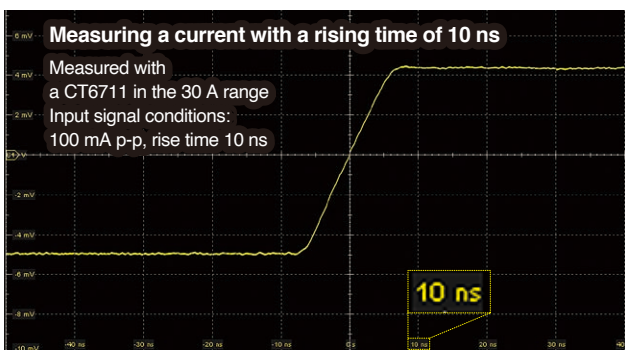

Current probes with a wide frequency band can capture high-speed current fluctuations with a rising time of 10 ns.

Failure to capture accurate waveforms due to insufficient frequency band
Example of measuring a pulse with a cyclic frequency of 1 MHz using different frequency bands

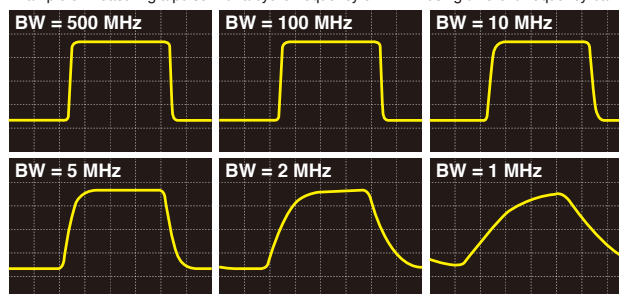

Current probes with a wide frequency band can accurately capture pulse waveforms.

CT6862-05



Product warranty period: 3 years
Guaranteed accuracy period: 1 year

| | |
|--|-------------------------|
| Rated current | 50 A AC/DC |
| Frequency band | DC to 1 MHz (-3 dB) |
| Diameter of measurable conductors | Max. φ 24 mm (0.94 in.) |

Accuracy

| Frequency | Amplitude ±(% of reading + % of full scale) | Phase |
|-----------------------|--|-----------------------|
| DC | ±0.05% ±0.01% | - |
| DC < f ≤ 16 Hz | ±0.10% ±0.02% | ±0.3° |
| 16 Hz < f ≤ 400 Hz | ±0.05% ±0.01% | ±0.2° |
| 400 Hz < f ≤ 1 kHz | ±0.2% ±0.02% | ±0.5° |
| 1 kHz < f ≤ 5 kHz | ±0.7% ±0.02% | ±1.0° |
| 5 kHz < f ≤ 10 kHz | ±1% ±0.02% | ±1.0° |
| 10 kHz < f ≤ 50 kHz | ±1% ±0.02% | ±(0.5 + 0.1 × f kHz)° |
| 50 kHz < f ≤ 100 kHz | ±2% ±0.05% | ±(0.5 + 0.1 × f kHz)° |
| 100 kHz < f ≤ 300 kHz | ±5% ±0.05% | ±(0.5 + 0.1 × f kHz)° |
| 300 kHz < f ≤ 700 kHz | ±10% ±0.05% | - |
| 700 kHz < f < 1 MHz | ±30% ±0.05% | - |

The values above are when the input is a sine wave, the conductor is in the center of the sensor opening, and the measurement instrument's input resistance is 1 MΩ or higher.
Amplitude accuracy: defined at the rated value or less, or within the derating curve; DC < f < 5 Hz is the typical value by design.
Phase accuracy: defined at the rated value or less, or within the derating curve; DC < f < 10 Hz is the typical value by design.

| | |
|---|---|
| Temperature and humidity range for guaranteed accuracy | 0°C to 40°C (32°F to 104°F), 80% RH or less |
| Effect of temperature | In ranges from -30°C to 0°C (-22°F to 32°F) and 40°C to 85°C (104°F to 185°F) Amplitude sensitivity: ±0.005% of reading/°C or less Offset voltage: ±0.005% of full scale/°C or less |
| Effect of common mode voltage | 0.05% of full scale or less (1000 Vrms, DC to 100 Hz) |

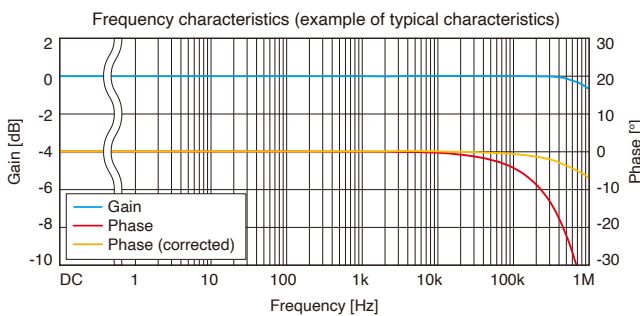
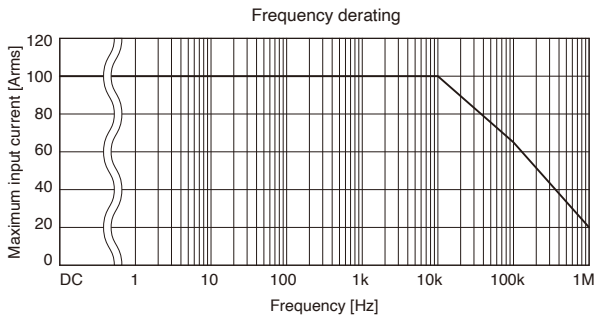

| | |
|---|---|
| Output voltage | 40 mV/A (= 2 V/50 A) |
| Operating temperature and humidity range | -30°C to 85°C (-22°F to 185°F), 80% RH or less (no condensation) |
| Storage temperature and humidity range | -30°C to 85°C (-22°F to 185°F), 80% RH or less (no condensation) |
| Maximum rated voltage to ground | 1000 V AC/DC (50/60 Hz), measurement category III, anticipated transient overvoltage: 8000 V |
| Standards | Safety: EN61010, EMC: EN61326 |
| Cable length | 3 m (9.84 ft.) |
| Dimensions | 70 mm (2.76 in.) W × 100 mm (3.94 in.) H × 53 mm (2.09 in.) D (Excluding protruding parts and cables) |
| Weight | Approx. 340 g (12.0 oz.) |

CT6872 CT6872-01

NEW



Product warranty period: 3 years
Guaranteed accuracy period: 1 year

| | |
|--|-------------------------|
| Rated current | 50 A AC/DC |
| Frequency band | DC to 10 MHz (-3 dB) |
| Diameter of measurable conductors | Max. φ 24 mm (0.94 in.) |

Accuracy

| Frequency | Amplitude ±(% of reading + % of full scale) | Phase |
|---------------------|--|------------------------|
| DC | ±0.03% ±0.002% | - |
| DC < f ≤ 16 Hz | ±0.1% ±0.01% | ±0.1° |
| 16 Hz < f ≤ 45 Hz | ±0.05% ±0.01% | ±0.08° |
| 45 Hz < f ≤ 66 Hz | ±0.03% ±0.007% | ±0.05° |
| 66 Hz < f ≤ 100 Hz | ±0.04% ±0.01% | ±0.1° |
| 100 Hz < f ≤ 500 Hz | ±0.06% ±0.01% | ±0.15° |
| 500 Hz < f ≤ 1 kHz | ±0.1% ±0.01% | ±0.4° |
| 1 kHz < f ≤ 5 kHz | ±0.15% ±0.02% | ±0.4° |
| 5 kHz < f ≤ 10 kHz | ±0.15% ±0.02% | ±0.5° |
| 10 kHz < f ≤ 1 MHz | (0.012 × f kHz)% + 0.05% | ±(0.04 × f kHz)° ±0.1° |

Combined accuracy with HIOKI power analyzer PW8001, PW6001 and PW3390 is specified (DC, 45 Hz ≤ f ≤ 66 Hz). For details of combined accuracy, refer to the instruction manual.
The values above are when the input is a sine wave, the measuring instrument has an input resistance of 1 MΩ ±10%, the voltage to ground is 0 V, there is no external magnetic field, and the conductor is in the center of the sensor opening.
Amplitude accuracy: defined 110% of full scale or less, or within the derating curve; DC < f < 10 Hz is the value by design.
Phase accuracy: defined 110% of full scale or less, or within the derating curve; DC < f < 10 Hz is the value by design.
Add ±0.01% of reading to the amplitude accuracy for input from 100% of full scale to 110% of full scale.
The CT6872-01 adds a phase accuracy of ±(0.015 × f)° at a frequency of 1 kHz < f ≤ 1 MHz.

| | |
|---|---|
| Temperature and humidity range for guaranteed accuracy | 23°C ±5°C (73.4°F ±41°F), 80% RH or less |
| Effect of temperature | In ranges from -40°C to 18°C (-40°F to 64.4°F) and 28°C to 85°C (82.4°F to 185°F) Amplitude sensitivity: ±20 ppm of reading/°C Offset voltage: ±0.2 ppm of full scale/°C |
| Common-Mode Rejection Ratio (CMRR) | (effect on output voltage and common mode voltage) 150 dB or greater (DC to 1 kHz) 140 dB or greater (1 kHz to 10 kHz) 120 dB or greater (10 kHz to 100 kHz) 100 dB or greater (100 kHz to 1 MHz) |
| Linearity error | ±2 ppm |
| Offset error | ±5 ppm |
| Amplitude errors | DC: 7 ppm 10 Hz to 100 Hz: 0.005% 100 Hz to 1 kHz: 0.01% 1 kHz to 50 kHz: 0.1% 50 kHz to 100 kHz: 0.3% 100 kHz to 300 kHz: 1% 300 kHz to 1 MHz: 3% |

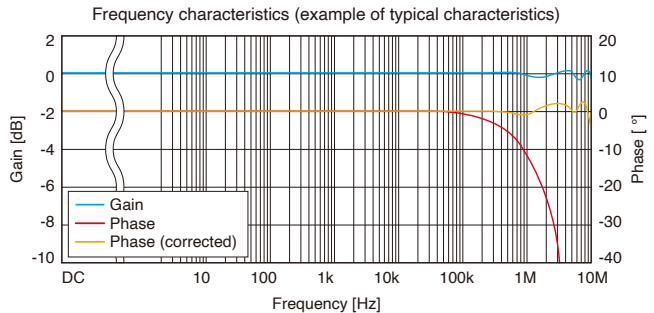
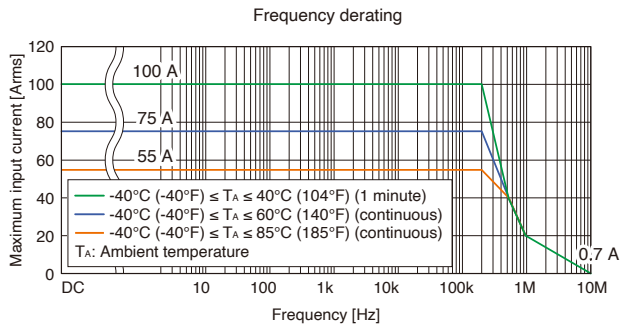

| | |
|---|---|
| Output voltage | 40 mV/A (= 2 V / 50 A) |
| Operating temperature and humidity range | -40°C to 85°C (-40°F to 185°F), 80% RH or less (no condensation) |
| Storage temperature and humidity range | -40°C to 85°C (-40°F to 185°F), 80% RH or less (no condensation) |
| Maximum rated voltage to ground | 1000 V CAT III Anticipated transient overvoltage: 8000 V |
| Standards | Safety: EN61010, EMC: EN61326 |
| Cable length | CT6872: 3 m (9.84 ft.) CT6872-01: 10 m (32.81 ft.) |
| Dimensions | 70 mm (2.76 in.) W × 110 mm (4.33 in.) H × 53 mm (2.09 in.) D (excluding protruding parts and cables) |
| Weight | CT6872: approx. 370 g (13.1 oz.) CT6872-01: approx. 690 g (24.3 oz.) |

CT6863-05



Product warranty period: 3 years
Guaranteed accuracy period: 1 year

| | |
|--|-------------------------|
| Rated current | 200 AAC/DC |
| Frequency band | DC to 500 kHz (-3 dB) |
| Diameter of measurable conductors | Max. φ 24 mm (0.94 in.) |

Accuracy

| Frequency | Amplitude ±(% of reading + % of full scale) | Phase |
|-----------------------|--|-----------------------|
| DC | ±0.05% ±0.01% | - |
| DC < f ≤ 16 Hz | ±0.10% ±0.02% | ±0.3° |
| 16 Hz < f ≤ 400 Hz | ±0.05% ±0.01% | ±0.2° |
| 400 Hz < f ≤ 1 kHz | ±0.2% ±0.02% | ±0.5° |
| 1 kHz < f ≤ 5 kHz | ±0.7% ±0.02% | ±1.0° |
| 5 kHz < f ≤ 10 kHz | ±1% ±0.02% | ±1.0° |
| 10 kHz < f ≤ 50 kHz | ±2% ±0.02% | ±(0.5 + 0.1 × f kHz)° |
| 50 kHz < f ≤ 100 kHz | ±5% ±0.05% | ±(0.5 + 0.1 × f kHz)° |
| 100 kHz < f ≤ 300 kHz | ±10% ±0.05% | ±(0.5 + 0.1 × f kHz)° |
| 300 kHz < f ≤ 500 kHz | ±30% ±0.05% | - |

The values above are when the input is a sine wave, the conductor is in the center of the sensor opening, and the measurement instrument's input resistance is 1 MΩ or higher. Amplitude accuracy: defined at the rated value or less, or within the derating curve; DC < f < 5 Hz is the typical value by design. Phase accuracy: defined at the rated value or less, or within the derating curve; DC < f < 10 Hz is the typical value by design.

| | |
|---|---|
| Temperature and humidity range for guaranteed accuracy | 0°C to 40°C (32°F to 104°F), 80% RH or less |
| Effect of temperature | In ranges from -30°C to 0°C (-22°F to 32°F) and 40°C to 85°C (104°F to 185°F) Amplitude sensitivity: ±0.005% of reading/°C or less Offset voltage: ±0.005% of full scale/°C or less |
| Effect of common mode voltage | 0.05% of full scale or less (1000 Vrms, DC to 100 Hz) |

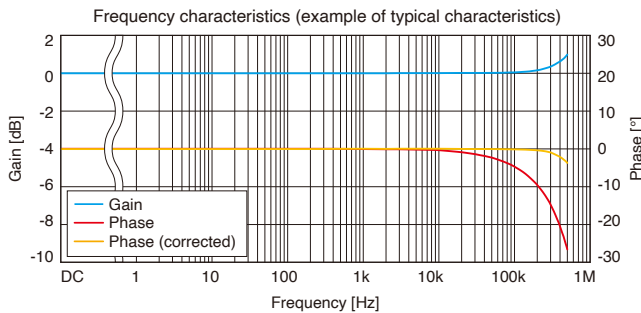
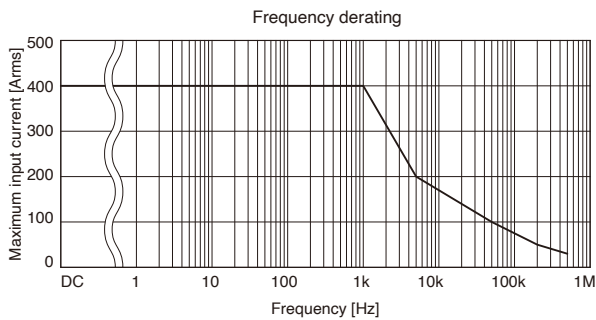

| | |
|---|---|
| Output voltage | 10 mV/A (= 2 V / 200 A) |
| Operating temperature and humidity range | -30°C to 85°C (-22°F to 185°F), 80% RH or less (no condensation) |
| Storage temperature and humidity range | -30°C to 85°C (-22°F to 185°F), 80% RH or less (no condensation) |
| Maximum rated voltage to ground | 1000 V AC/DC (50/60 Hz), measurement category III, anticipated transient overvoltage: 8000 V |
| Standards | Safety: EN61010, EMC: EN61326 |
| Cable length | 3 m (9.84 ft.) |
| Dimensions | 70 mm (2.76 in.) W × 100 mm (3.94 in.) H × 53 mm (2.09 in.) D (excluding protruding parts and cables) |
| Weight | Approx. 340 g (12.0 oz.) |

CT6873 CT6873-01

NEW



Product warranty period: 3 years
Guaranteed accuracy period: 1 year

| | |
|--|-------------------------|
| Rated current | 200 A AC/DC |
| Frequency band | DC to 10 MHz (-3 dB) |
| Diameter of measurable conductors | Max. φ 24 mm (0.94 in.) |

Accuracy

| Frequency | Amplitude ±(% of reading + % of full scale) | Phase |
|---------------------|--|------------------------|
| DC | ±0.03% ±0.002% | - |
| DC < f ≤ 16 Hz | ±0.1% ±0.01% | ±0.1° |
| 16 Hz < f ≤ 45 Hz | ±0.05% ±0.01% | ±0.08° |
| 45 Hz < f ≤ 66 Hz | ±0.03% ±0.007% | ±0.05° |
| 66 Hz < f ≤ 100 Hz | ±0.04% ±0.01% | ±0.1° |
| 100 Hz < f ≤ 500 Hz | ±0.05% ±0.01% | ±0.15° |
| 500 Hz < f ≤ 3 kHz | ±0.1% ±0.01% | ±0.4° |
| 3 kHz < f ≤ 5 kHz | ±0.2% ±0.02% | ±0.4° |
| 5 kHz < f ≤ 10 kHz | ±0.2% ±0.02% | ±0.5° |
| 10 kHz < f ≤ 1 MHz | (0.018 × f kHz)% + 0.05% | ±(0.04 × f kHz)° ±0.1° |

Combined accuracy with HIOKI power analyzer PW8001, PW6001 and PW3390 is specified (DC, 45 Hz ≤ f ≤ 66 Hz). For details of combined accuracy, refer to the instruction manual. The values above are when the input is a sine wave, the measuring instrument has an input resistance of 1 MΩ ±10%, the voltage to ground is 0 V, there is no external magnetic field, and the conductor is in the center of the sensor opening. Amplitude accuracy: defined 110% of full scale or less, or within the derating curve; DC < f < 10 Hz is the value by design. Phase accuracy: defined 110% of full scale or less, or within the derating curve; DC < f < 10 Hz is the value by design. Add ±0.01% of reading to the amplitude accuracy for input from 100% of full scale to 110% of full scale. The CT6873-01 adds a phase accuracy of ±(0.015 × f)° at a frequency of 1 kHz < f ≤ 1 MHz.

| | |
|---|---|
| Temperature and humidity range for guaranteed accuracy | 23°C ±5°C (73.4°F ±41°F), 80% RH or less |
| Effect of temperature | In ranges from -40°C to 18°C (-40°F to 64.4°F) and 28°C to 85°C (82.4°F to 185°F) Amplitude sensitivity: ±15 ppm of reading/°C Offset voltage: ±0.1 ppm of full scale/°C |
| Common-Mode Rejection Ratio (CMRR) | (effect on output voltage and common mode voltage) 150 dB or greater (DC to 1 kHz) 140 dB or greater (1 kHz to 10 kHz) 120 dB or greater (10 kHz to 100 kHz) 100 dB or greater (100 kHz to 1 MHz) |
| Linearity errors | ±2 ppm |
| Offset error | ±5 ppm |
| Amplitude error | DC: ±7 ppm 10 Hz to 500 Hz: ±0.005% 500 Hz to 3 kHz: ±0.01% 3 kHz to 30 kHz: ±0.1% 30 kHz to 100 kHz: ±0.4% 100 kHz to 400 kHz: ±1% 400 kHz to 1 MHz: ±3% |

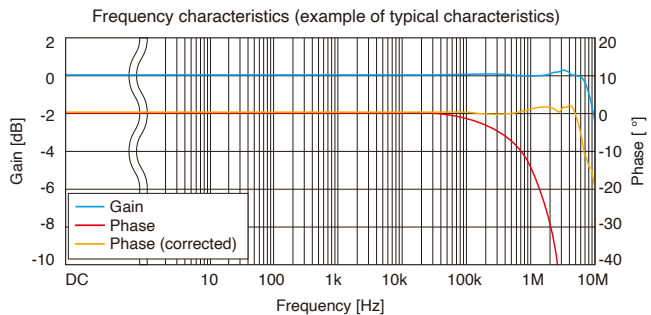
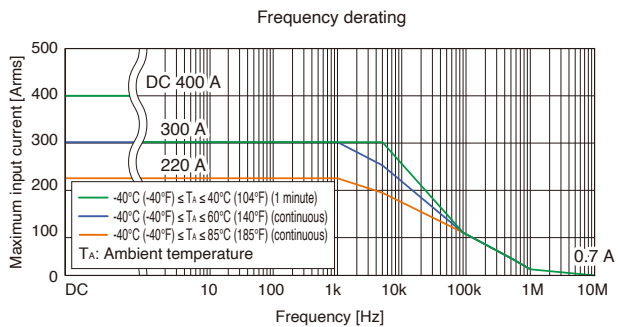

| | |
|---|---|
| Output voltage | 10 mV/A (= 2 V / 200 A) |
| Operating temperature and humidity range | -40°C to 85°C (-40°F to 185°F), 80% RH or less (no condensation) |
| Storage temperature and humidity range | -40°C to 85°C (-40°F to 185°F), 80% RH or less (no condensation) |
| Maximum rated voltage to ground | 1000 V CAT III Anticipated transient overvoltage: 8000 V |
| Standards | Safety: EN61010, EMC: EN61326 |
| Cable length | CT6873: 3 m (9.84 ft.) CT6873-01: 10 m (32.81 ft.) |
| Dimensions | 70 mm (2.76 in.) W × 110 mm (4.33 in.) H × 53 mm (2.09 in.) D (excluding protruding parts and cables) |
| Weight | CT6873: approx. 370 g (13.1 oz.) CT6873-01: approx. 690 g (24.3 oz.) |

CT6875A CT6875A-1



Product warranty period: 3 years
Guaranteed accuracy period: 1 year

| | |
|--|--|
| Rated current | 500 AAC/DC |
| Frequency band | CT6875A: DC to 2 MHz (±3 dB) CT6875A-1: DC to 1.5 MHz (±3 dB) |
| Diameter of measurable conductors | Max. φ 36 mm (1.41 in.) |

Accuracy

| Frequency | Amplitude ±(% of reading + % of full scale) | Phase |
|----------------------|--|-----------------|
| DC | ±0.04% ±0.008% | - |
| DC < f < 16 Hz | ±0.1% ±0.02% | ±0.1° |
| 16 Hz ≤ f < 45 Hz | ±0.05% ±0.01% | ±0.1° |
| 45 Hz ≤ f ≤ 66 Hz | ±0.04% ±0.008% | ±0.08° |
| 66 Hz < f ≤ 100 Hz | ±0.05% ±0.01% | ±0.1° |
| 100 Hz < f ≤ 500 Hz | ±0.1% ±0.02% | ±0.2° |
| 500 Hz < f ≤ 1 kHz | ±0.2% ±0.02% | ±0.4° |
| 1 kHz < f ≤ 5 kHz | ±0.4% ±0.02% | ±0.5° |
| 5 kHz < f ≤ 10 kHz | ±0.4% ±0.02% | ±(0.1 × f kHz)° |
| 10 kHz < f ≤ 50 kHz | ±1.5% ±0.05% | ±(0.1 × f kHz)° |
| 50 kHz < f ≤ 100 kHz | ±2.5% ±0.05% | ±(0.1 × f kHz)° |
| 100 kHz < f ≤ 1 MHz | ±(0.025 × f kHz)% ±0.05% | ±(0.1 × f kHz)° |

Combined accuracy with HIOKI power analyzer PW8001, PW6001 and PW3390 is specified (DC, 45 Hz ≤ f ≤ 66 Hz). For details of combined accuracy, refer to the instruction manual.
Amplitude accuracy: defined 110% of full scale or less, or within the derating curve; DC < f < 10 Hz is the value by design.
Add ±0.01% of reading to the amplitude accuracy for input from 100% of full scale to 110% of full scale
For the CT6875A-1, add the following for frequencies of
1 kHz < f ≤ 1 MHz (the frequency band is 1.5 MHz ±3 dB):
Amplitude accuracy: ±(0.005 × f kHz)% of reading, Phase accuracy: ±(0.015 × f kHz)°

| | |
|---|---|
| Temperature and humidity range for guaranteed accuracy | 0°C to 40°C (32°F to 104°F), 80% RH or less |
| Effect of temperature | In ranges from -40°C to 0°C (-40°F to 32°F) and 40°C to 85°C (104°F to 185°F) Amplitude sensitivity: ±20 ppm of reading / °C Offset voltage: ±1 ppm of full scale / °C |
| Common-Mode Rejection Ratio (CMRR) | (effect on output voltage and common mode voltage) 140 dB or greater (50/60 Hz) 120 dB or greater (100 kHz) |
| Linearity error | ±5 ppm |
| Offset error | ±5 ppm |
| Amplitude error | DC: ±10 ppm 10 Hz to 100 Hz: ±0.005% 100 Hz to 1 kHz: ±0.02% 1 kHz to 20 kHz: ±0.08% 20 kHz to 100 kHz: ±0.5% 100 kHz to 300 kHz: ±1% 300 kHz to 1 MHz: ±5% |

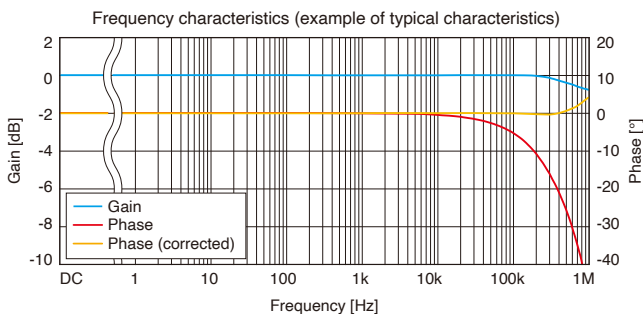
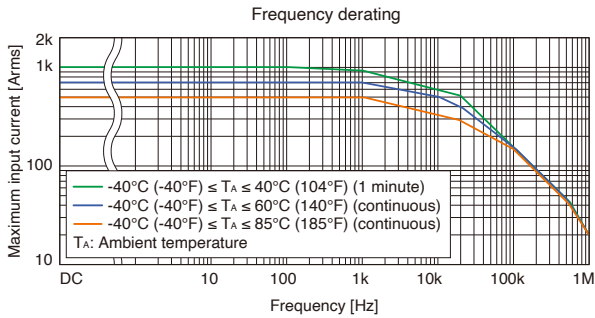

| | |
|---|--|
| Output voltage | 4 mV/A (= 2 V / 500 A) |
| Operating temperature and humidity range | -40°C to 85°C (-40°F to 185°F), 80% RH or less (no condensation) |
| Storage temperature and humidity range | -40°C to 85°C (-40°F to 185°F), 80% RH or less (no condensation) |
| Maximum rated voltage to ground | 1000 V CAT III Anticipated transient overvoltage: 8000 V |
| Standards | Safety: EN61010, EMC: EN61326 |
| Cable length | CT6875A: 3 m (9.84 ft.) CT6875A-1: 10 m (32.81 ft.) |
| Dimensions | 160 mm (6.30 in.) W × 112 mm (4.41 in.) H × 50 mm (1.97 in.) D (excluding protruding parts and cables) |
| Weight | CT6875A: approx. 0.8 kg (28.2 oz.) CT6875A-1: approx. 1.1 kg (38.8 oz.) |

CT6904A CT6904A-1



(CT6904A-1: build-to-order product)
Product warranty period: 3 years
Guaranteed accuracy period: 1 year

| | |
|--|--|
| Rated current | 500 A AC/DC |
| Frequency band | CT6904A: DC to 4 MHz (±3 dB) CT6904A-1: DC to 2 MHz (±3 dB) |
| Diameter of measurable conductors | Max. φ 32 mm (1.25 in.) |

Accuracy

| Frequency | Amplitude ±(% of reading + % of full scale) | Phase |
|-----------------------|--|------------------|
| DC | ±0.025% ±0.007% | - |
| DC < f < 16 Hz | ±0.2% ±0.02% | ±0.1° |
| 16 Hz ≤ f < 45 Hz | ±0.1% ±0.02% | ±0.1° |
| 45 Hz ≤ f ≤ 65 Hz | ±0.02% ±0.007% | ±0.08° |
| 65 Hz < f ≤ 850 Hz | ±0.05% ±0.007% | ±0.12° |
| 850 Hz < f ≤ 1 kHz | ±0.1% ±0.01% | ±0.4° |
| 1 kHz < f ≤ 5 kHz | ±0.4% ±0.02% | ±0.4° |
| 5 kHz < f ≤ 10 kHz | ±0.4% ±0.02% | ±(0.08 × f kHz)° |
| 10 kHz < f ≤ 50 kHz | ±1% ±0.02% | ±(0.08 × f kHz)° |
| 50 kHz < f ≤ 100 kHz | ±1% ±0.05% | ±(0.08 × f kHz)° |
| 100 kHz < f ≤ 300 kHz | ±2% ±0.05% | ±(0.08 × f kHz)° |
| 300 kHz < f ≤ 1 MHz | ±5% ±0.05% | ±(0.08 × f kHz)° |

Combined accuracy with HIOKI power analyzer PW8001 and PW6001 is specified (DC, 45 Hz ≤ f ≤ 65 Hz). For details of combined accuracy, refer to the instruction manual.
Amplitude accuracy and phase accuracy: defined 110% of full scale or less, or within the derating curve (continuous input at an ambient temperature of 50°C); DC < f < 10 Hz is the value by design.
Add ±0.01% of reading to the amplitude accuracy for input from 100% of full scale to 110% of full scale
For the CT6904A-1, add the following for frequencies of
50 kHz < f ≤ 1 MHz (the frequency band is 2 MHz ±3 dB):
Amplitude accuracy: ±(0.015 × f)% of reading

| | |
|---|--|
| Temperature and humidity range for guaranteed accuracy | 23°C ±5°C (73°F ±9°F), 80% RH or less |
| Effect of temperature | In ranges from -10°C to 18°C (14°F to 64.4°F) or 28°C to 50°C (82.4°F to 122°F) Amplitude sensitivity: ±20 ppm of reading / °C Offset voltage: ±1 ppm of full scale / °C Phase: ±0.01°/°C |
| Common-Mode Rejection Ratio (CMRR) | (effect on output voltage and common mode voltage) 140 dB or greater (50/60 Hz) 120 dB or greater (100 kHz) |
| Linearity error | ±5 ppm |
| Offset error | ±10 ppm |

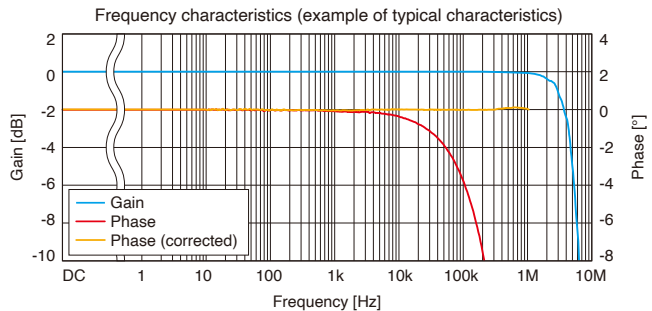
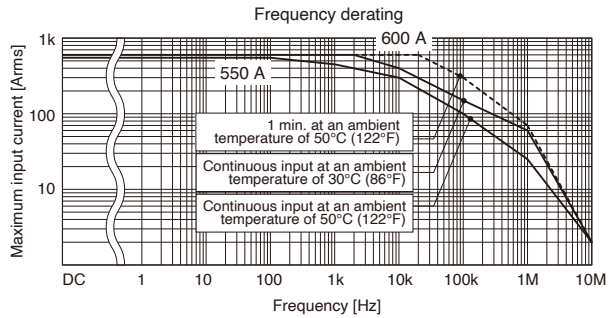

| | |
|---|--|
| Output voltage | 4 mV/A (= 2 V / 500 A) |
| Operating temperature and humidity range | -10°C to 50°C (-14°F to 122°F), 80% RH or less (no condensation) |
| Storage temperature and humidity range | -20°C to 60°C (-4°F to 140°F), 80% RH or less (no condensation) |
| Maximum rated voltage to ground | 1000 V CAT III Anticipated transient overvoltage: 8000 V |
| Standards | Safety: EN61010, EMC: EN61326 |
| Cable length | CT6904A: 3 m (9.84 ft.) (including relay box) CT6904A-1: 10 m (32.81 ft.) (including relay box) |
| Dimensions | 139 mm (5.47 in.) W × 120 mm (4.72 in.) H × 52 mm (2.05 in.) D (excluding protrusions and cables) |
| Weight | CT6904A: approx. 1.05 kg (37.0 oz.) CT6904A-1: approx. 1.35 kg (47.6 oz.) |

CT6904A-2 CT6904A-3

(Build-to-order product)



Product warranty period: 3 years
Guaranteed accuracy period: 1 year

| | |
|--|--|
| Rated current | 800 AAC/DC |
| Frequency band | CT6904A-2: DC to 4 MHz (±3 dB) CT6904A-3: DC to 2 MHz (±3 dB) |
| Diameter of measurable conductors | Max. φ 32 mm (1.25 in.) |

Accuracy

| Frequency | Amplitude ±(% of reading + % of full scale) | Phase |
|-----------------------|--|------------------|
| DC | ±0.030% ±0.009% | - |
| DC < f < 16 Hz | ±0.2% ±0.025% | ±0.1° |
| 16 Hz ≤ f < 45 Hz | ±0.1% ±0.025% | ±0.1° |
| 45 Hz ≤ f ≤ 65 Hz | ±0.025% ±0.009% | ±0.08° |
| 65 Hz < f ≤ 850 Hz | ±0.05% ±0.009% | ±0.12° |
| 850 Hz < f ≤ 1 kHz | ±0.1% ±0.013% | ±0.4° |
| 1 kHz < f ≤ 5 kHz | ±0.4% ±0.025% | ±0.4° |
| 5 kHz < f ≤ 10 kHz | ±0.4% ±0.025% | ±(0.08 × f kHz)° |
| 10 kHz < f ≤ 50 kHz | ±1% ±0.025% | ±(0.08 × f kHz)° |
| 50 kHz < f ≤ 100 kHz | ±1% ±0.063% | ±(0.08 × f kHz)° |
| 100 kHz < f ≤ 300 kHz | ±2% ±0.063% | ±(0.08 × f kHz)° |
| 300 kHz < f ≤ 1 MHz | ±5% ±0.063% | ±(0.08 × f kHz)° |

Combined accuracy with HIOKI power analyzer PW8001 and PW6001 is specified (DC, 45 Hz ≤ f ≤ 65 Hz). For details of combined accuracy, refer to the instruction manual.
Amplitude accuracy and phase accuracy are specified by the following conditions:
· Rated value or less
· At 100Hz or more and within the range of "Continuous input at an ambient temperature of 50°C (122°F)" described in the frequency derating graph below
· For the CT6904A-3, add the following for frequencies of 50 kHz < f ≤ 1 MHz (frequency band is 2 MHz ±3):
Amplitude accuracy: ±(0.015 × f)% of reading

| | |
|---|---|
| Temperature and humidity range for guaranteed accuracy | 23°C ±5°C (73°F ±9°F), 80% RH or less |
| Effect of temperature | In ranges from -10°C to 18°C (14°F to 64.4°F) or 28°C to 50°C (82.4°F to 122°F) Amplitude sensitivity: ± 50 ppm of reading / °C Offset voltage: ±5 ppm of full scale / °C Phase: ±0.01° / °C |
| Common-Mode Rejection Ratio (CMRR) | (effect on output voltage and common mode voltage) 140 dB or greater (50/60 Hz) 120 dB or greater (100 kHz) |
| Linearity error | ±12.5 ppm |
| Offset error | ±10 ppm |

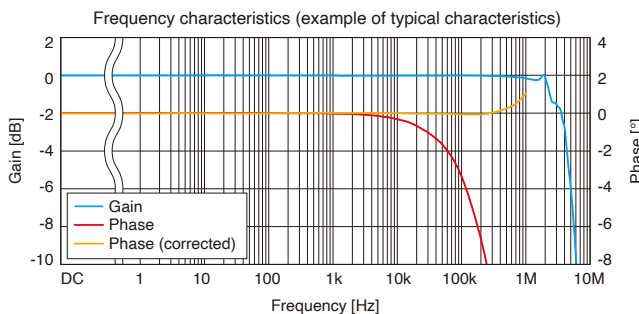
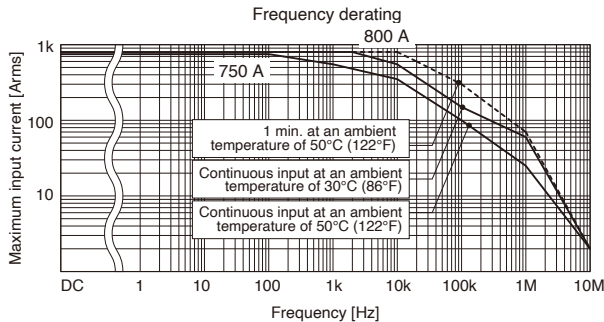

| | |
|---|--|
| Output voltage | 2 mV/A (= 2 V / 1000 A) |
| Operating temperature and humidity range | -10°C to 50°C (-14°F to 122°F), 80% RH or less (no condensation) |
| Storage temperature and humidity range | -20°C to 60°C (-4°F to 140°F), 80% RH or less (no condensation) |
| Maximum rated voltage to ground | 1000 V CAT III Anticipated transient overvoltage: 8000 V |
| Standards | Safety: EN61010, EMC: EN61326 |
| Cable length | CT6904A-2: 3 m (9.84 ft.) (including relay box) CT6904A-3: 10 m (32.81 ft.) (including relay box) |
| Dimensions | 139 mm (5.47 in.) W × 120 mm (4.72 in.) H × 52 mm (2.05 in.) D (excluding protrusions and cables) |
| Weight | CT6904A-2: approx. 1.15 kg (40.6 oz.) CT6904A-3: approx. 1.45 kg (51.1 oz.) |

CT6876A CT6876A-1



Product warranty period: 3 years
Guaranteed accuracy period: 1 year

| | |
|--|--|
| Rated current | 1000 A AC/DC |
| Frequency band | CT6876A: DC to 1.5 MHz (±3 dB) CT6876A-1: DC to 1.2 MHz (±3 dB) |
| Diameter of measurable conductors | Max. φ 36 mm (1.41 in.) |

Accuracy

| Frequency | Amplitude ±(% of reading + % of full scale) | Phase |
|----------------------|--|-----------------|
| DC | ±0.04% ±0.008% | - |
| DC < f < 16 Hz | ±0.1% ±0.02% | ±0.1° |
| 16 Hz ≤ f < 45 Hz | ±0.05% ±0.01% | ±0.1° |
| 45 Hz ≤ f ≤ 66 Hz | ±0.04% ±0.008% | ±0.08° |
| 66 Hz < f ≤ 100 Hz | ±0.05% ±0.01% | ±0.1° |
| 100 Hz < f ≤ 500 Hz | ±0.1% ±0.02% | ±0.2° |
| 500 Hz < f ≤ 1 kHz | ±0.2% ±0.02% | ±0.4° |
| 1 kHz < f ≤ 5 kHz | ±0.5% ±0.02% | ±0.5° |
| 5 kHz < f ≤ 10 kHz | ±0.5% ±0.02% | ±(0.1 × f kHz)° |
| 10 kHz < f ≤ 50 kHz | ±2% ±0.05% | ±(0.1 × f kHz)° |
| 50 kHz < f ≤ 100 kHz | ±3% ±0.05% | ±(0.1 × f kHz)° |
| 100 kHz < f ≤ 1 MHz | ±(0.03 × f kHz)% ±0.05% | ±(0.1 × f kHz)° |

Combined accuracy with HIOKI power analyzer PW8001, PW6001 and PW3390 is specified (DC, 45 Hz ≤ f ≤ 66 Hz). For details of combined accuracy, refer to the instruction manual.
Amplitude accuracy and phase accuracy: defined 110% of full scale or less within the derating curve;
DC < f < 10 Hz is the value by design
· Add ±0.01% of reading to the amplitude accuracy for input from 100% of full scale to 110% of full scale
· For the CT6876A-1, add the following for frequencies of 1 kHz < f ≤ 1 MHz (the frequency band is 1.2 MHz ±3 dB):
Amplitude accuracy: ±(0.005 × f kHz)% of reading, Phase accuracy: ±(0.015 × f kHz)°

| | |
|---|--|
| Temperature and humidity range for guaranteed accuracy | 0°C to 40°C (32°F to 104°F), 80% RH or less |
| Effect of temperature | In ranges from -40°C to 0°C (-40°F to 32°F) and 40°C to 85°C (104°F to 185°F) Amplitude sensitivity: ±20 ppm of reading / °C Offset voltage: ±1 ppm of full scale / °C |
| Common-Mode Rejection Ratio (CMRR) | (effect on output voltage and common mode voltage) 140 dB or greater (50/60 Hz) 120 dB or greater (100 kHz) |
| Linearity error | ±5 ppm |
| Offset error | ±5 ppm |
| Amplitude error | DC: ±10 ppm 10 Hz to 100 Hz: ±0.005% 100 Hz to 1 kHz: ±0.03% 1 kHz to 10 kHz: ±0.2% 10 kHz to 100 kHz: ±1% 100 kHz to 300 kHz: ±3% 300 kHz to 1 MHz: ±15% |

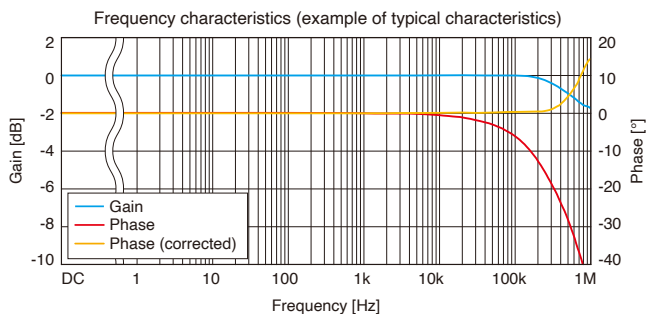
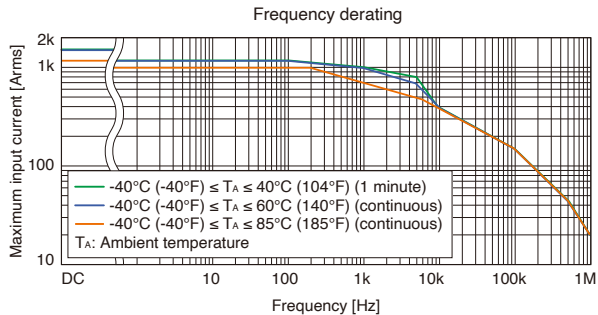

| | |
|---|--|
| Output voltage | 2 mV/A (= 2 V / 1000 A) |
| Operating temperature and humidity range | -40°C to 85°C (-40°F to 185°F), 80% RH or less (no condensation) |
| Storage temperature and humidity range | -40°C to 85°C (-40°F to 185°F), 80% RH or less (no condensation) |
| Maximum rated voltage to ground | 1000 V CAT III Anticipated transient overvoltage: 8000 V |
| Standards | Safety: EN61010, EMC: EN61326 |
| Cable length | CT6876A: 3 m (9.84 ft.) CT6876A-1: 10 m (32.81 ft.) |
| Dimensions | 160 mm (6.30 in.) W × 112 mm (4.41 in.) H × 50 mm (1.97 in.) D (excluding protruding parts and cables) |
| Weight | CT6876A: approx. 0.95 kg (33.5 oz.) CT6876A-1: approx. 1.25 kg (44.1 oz.) |

CT6877A CT6877A-1



Product warranty period: 3 years
Guaranteed accuracy period: 1 year

| | |
|--|-------------------------|
| Rated current | 2000 A AC/DC |
| Frequency band | DC to 1 MHz |
| Diameter of measurable conductors | Max. φ 80 mm (3.14 in.) |

Accuracy

| Frequency | Amplitude ±(% of reading + % of full scale) | Phase |
|-----------------------|--|-----------------------|
| DC | ±0.04% ±0.008% | - |
| DC < f < 16 Hz | ±0.1% ±0.02% | ±0.1° |
| 16 Hz ≤ f < 45 Hz | ±0.05% ±0.01% | ±0.1° |
| 45 Hz ≤ f ≤ 66 Hz | ±0.04% ±0.008% | ±0.08° |
| 66 Hz < f ≤ 100 Hz | ±0.05% ±0.01% | ±0.1° |
| 100 Hz < f ≤ 500 Hz | ±0.1% ±0.02% | ±0.2° |
| 500 Hz < f ≤ 1 kHz | ±0.2% ±0.02% | ±0.4° |
| 1 kHz < f ≤ 5 kHz | ±0.5% ±0.02% | ±(0.3 + 0.1 × f kHz)° |
| 5 kHz < f ≤ 10 kHz | ±0.5% ±0.02% | ±(0.3 + 0.1 × f kHz)° |
| 10 kHz < f ≤ 50 kHz | ±1.5% ±0.05% | ±(0.3 + 0.1 × f kHz)° |
| 50 kHz < f ≤ 100 kHz | ±2.5% ±0.05% | ±(0.3 + 0.1 × f kHz)° |
| 100 kHz < f ≤ 700 kHz | ±(0.025 × f)% ±0.05% | ±(0.3 + 0.1 × f kHz)° |

Combined accuracy with HIOKI power analyzer PW8001, PW6001 and PW3390 is specified (DC, 45 Hz ≤ f ≤ 66 Hz). For details of combined accuracy, refer to the instruction manual.
 * Amplitude accuracy and phase accuracy: defined 110% of full scale or less, or within the derating curve, DC < f < 10 Hz is the value by design.
 * Add ±0.01% of reading to the amplitude accuracy for input from 100% of full scale to 110% of full scale.
 * For the CT6877A-1, add the following for frequencies of 1 kHz < f ≤ 700 kHz:
 Amplitude accuracy: ±(0.005 × f)% of reading, Phase accuracy: ±(0.015 × f)°

| | | |
|---|--|---|
| Temperature and humidity range for guaranteed accuracy | 0°C to 40°C (32°F to 104°F), 80% RH or less | |
| Effect of temperature | In ranges from -40°C to 0°C (-40°F to 32°F) and 40°C to 85°C (104°F to 185°F) Amplitude sensitivity: ±15 ppm of reading / °C Offset voltage: ±0.5 ppm of full scale / °C | |
| Common-Mode Rejection Ratio (CMRR) | (effect on output voltage and common mode voltage) 140 dB or greater (50/60 Hz) 120 dB or greater (100 kHz) | |
| Linearity error | ±10 ppm | |
| Offset error | ±5 ppm | |
| Amplitude error | DC: ±15 ppm | 10 kHz to 100 kHz: ±1% 100 Hz to 100 Hz: ±0.01% 100 kHz to 300 kHz: ±2% 100 Hz to 1 kHz: ±0.04% 300 kHz to 700 kHz: ±10% 1 kHz to 10 kHz: ±0.25% |

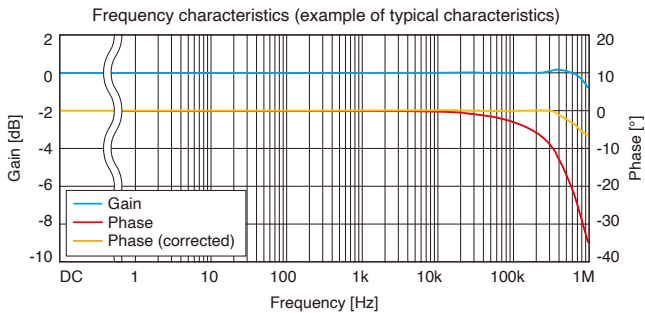
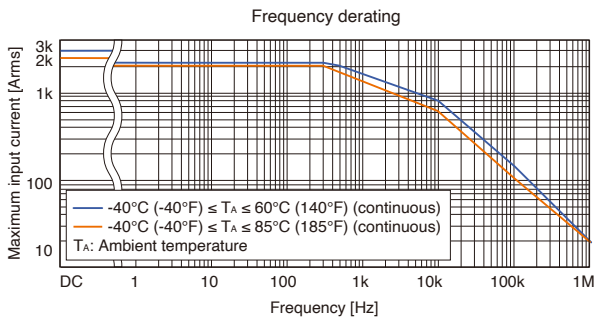

| | |
|---|---|
| Output voltage | 1 mV/A (= 2 V / 2000 A) |
| Operating temperature and humidity range | -40°C to 85°C (-40°F to 185°F), 80% RH or less (no condensation) |
| Storage temperature and humidity range | -40°C to 85°C (-40°F to 185°F), 80% RH or less (no condensation) |
| Maximum rated voltage to ground | 1000 V CAT III Anticipated transient overvoltage: 8000 V |
| Standards | Safety: EN61010, EMC: EN61326 |
| Cable length | CT6877A: 3 m (9.84 ft.) CT6877A-1: 10 m (32.81 ft.) |
| Dimensions | 229 mm (9.02 in.) W × 232 mm (9.13 in.) H × 112 mm (4.41 in.) D (excluding protruding parts and cables) |
| Weight | CT6877A: approx. 5 kg (176.4 oz.) CT6877A-1: approx. 5.3 kg (187.0 oz.) |

PW9100A-3 PW9100A-4



Product warranty period: 3 years
Guaranteed accuracy period: 1 year

| | |
|-------------------------------------|-----------------------------|
| Rated current | 50 A AC/DC |
| Frequency band | DC to 3.5 MHz |
| Input and measurement method | Isolated input, DCCT* input |
| Measurement terminals | Terminal block M6 screws |

*Direct Connection Current Transducer

Accuracy

| Frequency | Amplitude ±(% of reading + % of full scale) | Phase |
|-----------------------|--|------------------|
| DC | ±0.02% ±0.007% | - |
| DC < f < 30 Hz | ±0.1% ±0.02% | ±0.3° |
| 30 Hz ≤ f < 45 Hz | ±0.1% ±0.02% | ±0.1° |
| 45 Hz ≤ f ≤ 65 Hz | ±0.02% ±0.005% | ±0.1° |
| 65 Hz < f ≤ 500 Hz | ±0.1% ±0.01% | ±0.12° |
| 500 Hz < f ≤ 1 kHz | ±0.1% ±0.01% | ±0.5° |
| 1 kHz < f ≤ 5 kHz | ±0.5% ±0.02% | ±0.5° |
| 5 kHz < f ≤ 20 kHz | ±1% ±0.02% | ±1° |
| 20 kHz < f ≤ 50 kHz | ±1% ±0.02% | ±(0.05 × f kHz)° |
| 50 kHz < f ≤ 100 kHz | ±2% ±0.05% | ±(0.06 × f kHz)° |
| 100 kHz < f ≤ 300 kHz | ±5% ±0.05% | ±(0.06 × f kHz)° |
| 300 kHz < f ≤ 700 kHz | ±5% ±0.05% | ±(0.07 × f kHz)° |
| 700 kHz < f ≤ 1 MHz | ±10% ±0.05% | ±(0.07 × f kHz)° |

Combined accuracy with HIOKI power analyzer PW8001, PW6001 and PW3390 is specified (DC, 45 Hz ≤ f ≤ 65 Hz). For details of combined accuracy, refer to the instruction manual.
 * Amplitude accuracy and phase accuracy: defined within the accuracy guarantee range shown in the derating figure below; DC < f < 10 Hz is the value by design.
 * Add ±0.01% of reading to the amplitude accuracy for input from 100% of full scale to 110% of full scale

| | |
|---|---|
| Temperature and humidity range for guaranteed accuracy | 23°C ±5°C (73°F ±9°F), 80% RH or less |
| Effect of temperature | In ranges from 0°C to 18°C (32°F to 64°F) and 28°C to 40°C (82°F to 104°F) Amplitude sensitivity: ±20 ppm of reading / °C Offset voltage: ±1 ppm of full scale / °C Phase: ±0.01° / °C |
| Common-Mode Rejection Ratio (CMRR) | (effect on output voltage and common mode voltage) 120 dB or greater (50/60 Hz, 100 kHz) |

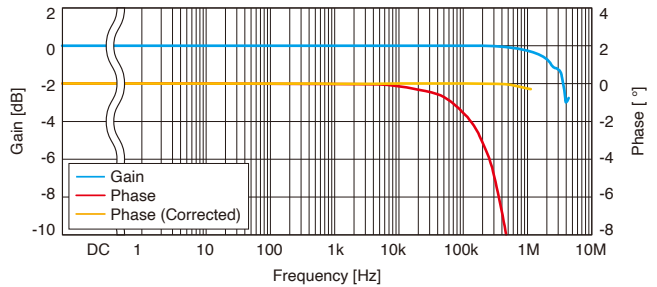
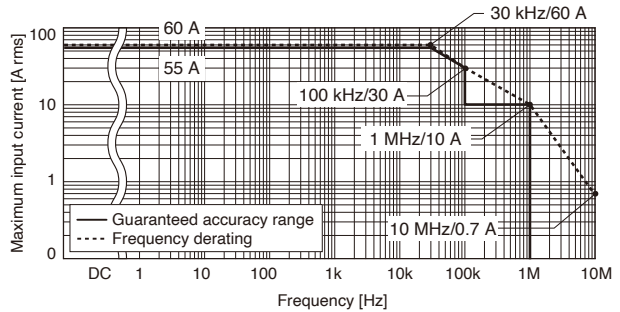

| | |
|---|--|
| Output voltage | 40 mV/A (= 2 V / 50 A) |
| Operating temperature and humidity range | 0°C to 40°C (32°F to 104°F), 80% RH or less (no condensation) |
| Storage temperature and humidity range | -10°C to 50°C (14°F to 122°F), 80% RH or less (no condensation) |
| Maximum rated voltage to ground | 600 V CAT III, 1000 V CAT II Anticipated transient overvoltage: 6000 V |
| Standards | Safety: EN 61010, EMC: EN 61326 Class A |
| Cable length | 0.8 m (2.62 ft.) |
| Dimensions | 430 mm (16.9 in.) W × 88 mm (3.46 in.) H × 260 mm (10.23 in.) D |
| Weight | PW9100A-3: approx. 3.7 kg (130.5 oz.) PW9100A-4: approx. 4.3 kg (151.7 oz.) |

CT6841A



Product warranty period: 3 years
Guaranteed accuracy period: 1 year

| | |
|--|-------------------------|
| Rated current | 20 A AC/DC |
| Frequency band | DC to 2 MHz |
| Diameter of measurable conductors | Max. φ 20 mm (0.79 in.) |

Accuracy

| Frequency | Amplitude ±(% of reading + % of full scale) | Phase |
|-----------------------|--|-----------------------|
| DC | ±0.2% ±0.05%* | - |
| DC < f ≤ 100 Hz | ±0.2% ±0.01% | ±0.1° |
| 100 Hz < f ≤ 500 Hz | ±0.3% ±0.02% | ±0.2° |
| 500 Hz < f ≤ 1 kHz | ±0.5% ±0.02% | ±0.5° |
| 1 kHz < f ≤ 5 kHz | ±1.0% ±0.02% | ±1.0° |
| 5 kHz < f ≤ 10 kHz | ±1.5% ±0.02% | ±1.5° |
| 10 kHz < f ≤ 50 kHz | ±2.0% ±0.02% | ±(0.5 + 0.1 × f kHz)° |
| 50 kHz < f ≤ 100 kHz | ±5.0% ±0.05% | ±(0.5 + 0.1 × f kHz)° |
| 100 kHz < f ≤ 300 kHz | ±10% ±0.05% | ±(0.5 + 0.1 × f kHz)° |
| 300 kHz < f ≤ 500 kHz | ±15% ±0.05% | ±(0.5 + 0.1 × f kHz)° |
| 500 kHz < f < 1 MHz | ±30% ±0.05% | ±(0.5 + 0.1 × f kHz)° |

Combined accuracy with HIOKI power analyzer PW8001, PW6001 and PW3390 is specified (DC, 45 Hz ≤ f ≤ 66 Hz). For details of combined accuracy, refer to the instruction manual.
*DC accuracy after adjusting the offset voltage to ±0.5 mV or less.

- The values above are when the input is a sine wave or DC, the measurement instrument's input resistance is 1 MΩ ± 10%, voltage to ground 0 V, no external magnetic fields and the conductor is in the center of the sensor opening.
- Amplitude accuracy and phase accuracy are defined 110% of full scale or less and within the derating curve. DC < f < 10 Hz is a design value.
- Add ±0.03% of reading to the amplitude accuracy for input from 100% of full scale to 110% of full scale.

| | |
|---|--|
| Temperature and humidity range for guaranteed accuracy | 0°C to 40°C (32°F to 104°F), 80% RH or less |
| Effect of temperature | In ranges from -40°C to 0°C (-40°F to 32°F) and 40°C to 85°C (104°F to 185°F) Amplitude sensitivity: ±0.01% of reading / °C Offset voltage: ±0.005% of full scale / °C |
| Common-Mode Rejection Ratio (CMRR) | (effect on output voltage and common mode voltage) 140 dB or greater (DC to 1 kHz) 125 dB or greater (1 kHz to 10 kHz) 100 dB or greater (10 kHz to 100 kHz) 80 dB or greater (100 kHz to 1 MHz) |
| Linearity error | ±20 ppm |

Frequency derating

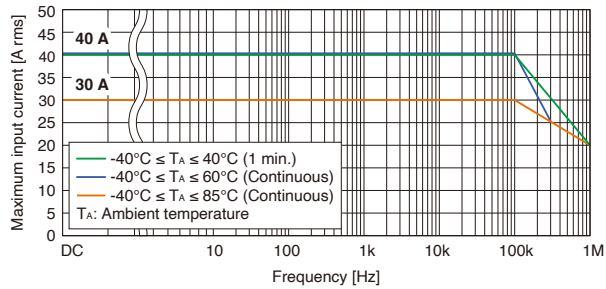

Frequency characteristics (example of typical characteristics)

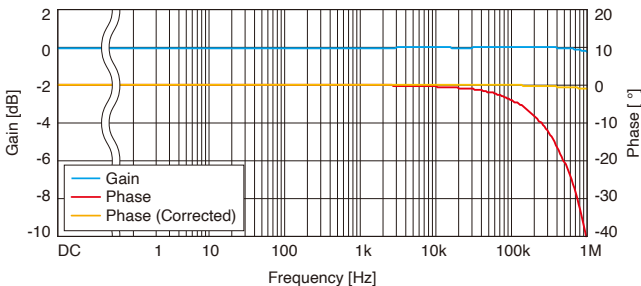

| | |
|---|---|
| Output voltage | 100 mV/A (= 2 V / 20 A) |
| Measurable conductors | Insulated conductor |
| Operating temperature and humidity range | -40°C to 85°C (-40°F to 185°F), 80% RH or less (no condensation) |
| Storage temperature and humidity range | -40°C to 85°C (-40°F to 185°F), 80% RH or less (no condensation) |
| Withstand voltage | 4260 V AC Withstand test current of 1 mA, 50/60 Hz, 1 min., between jaws and cable output terminal |
| Standards | Safety: EN 61010, EMC: EN 61326 |
| Cable length | 3 m (9.84 ft.) |
| Dimensions | 153 mm (6.02 in.) W × 67 mm (2.64 in.) H × 25 mm (0.98 in.) D (excluding protruding parts and cables) |
| Weight | Approx. 370 g (13.1 oz.) |

CT6843A



Product warranty period: 3 years
Guaranteed accuracy period: 1 year

| | |
|--|-------------------------|
| Rated current | 200 A AC/DC |
| Frequency band | DC to 700 kHz |
| Diameter of measurable conductors | Max. φ 20 mm (0.79 in.) |

Accuracy

| Frequency | Amplitude ±(% of reading + % of full scale) | Phase |
|-----------------------|--|-----------------------|
| DC | ±0.2% ±0.02%* | - |
| DC < f ≤ 100 Hz | ±0.2% ±0.01% | ±0.1° |
| 100 Hz < f ≤ 500 Hz | ±0.3% ±0.02% | ±0.2° |
| 500 Hz < f ≤ 1 kHz | ±0.5% ±0.02% | ±0.5° |
| 1 kHz < f ≤ 5 kHz | ±1.0% ±0.02% | ±1.0° |
| 5 kHz < f ≤ 10 kHz | ±1.5% ±0.02% | ±1.5° |
| 10 kHz < f ≤ 50 kHz | ±5.0% ±0.02% | ±(0.5 + 0.1 × f kHz)° |
| 50 kHz < f ≤ 100 kHz | ±15% ±0.05% | ±(0.5 + 0.1 × f kHz)° |
| 100 kHz < f ≤ 300 kHz | ±15% ±0.05% | ±(0.5 + 0.1 × f kHz)° |
| 300 kHz < f ≤ 500 kHz | ±30% ±0.05% | ±(0.5 + 0.1 × f kHz)° |

Combined accuracy with HIOKI power analyzer PW8001, PW6001 and PW3390 is specified (DC, 45 Hz ≤ f ≤ 66 Hz). For details of combined accuracy, refer to the instruction manual.
*DC accuracy after adjusting the offset voltage to ±0.2 mV or less.

- The values above are when the input is a sine wave or DC, the measurement instrument's input resistance is 1 MΩ ± 10%, voltage to ground 0 V, no external magnetic fields and the conductor is in the center of the sensor opening.
- Amplitude accuracy and phase accuracy are defined 110% of full scale or less and within the derating curve. DC < f < 10 Hz is a design value.
- Add ±0.03% of reading to the amplitude accuracy for input from 100% of full scale to 110% of full scale.

| | |
|---|--|
| Temperature and humidity range for guaranteed accuracy | 0°C to 40°C (32°F to 104°F), 80% RH or less |
| Effect of temperature | In ranges from -40°C to 0°C (-40°F to 32°F) and 40°C to 85°C (104°F to 185°F) Amplitude sensitivity: ±0.01% of reading / °C Offset voltage: ±0.005% of full scale / °C |
| Common-Mode Rejection Ratio (CMRR) | (effect on output voltage and common mode voltage) 150 dB or greater (DC to 1 kHz) 135 dB or greater (1 kHz to 10 kHz) 115 dB or greater (10 kHz to 100 kHz) 95 dB or greater (100 kHz to 500 kHz) |
| Linearity error | ±20 ppm |

Frequency derating

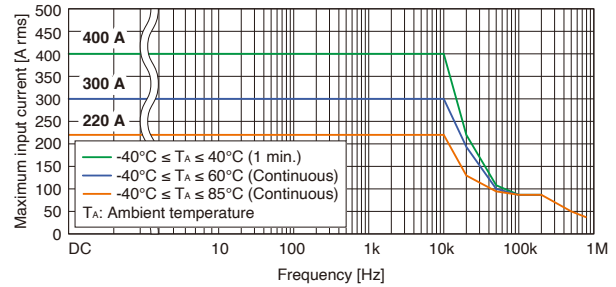

Frequency characteristics (example of typical characteristics)

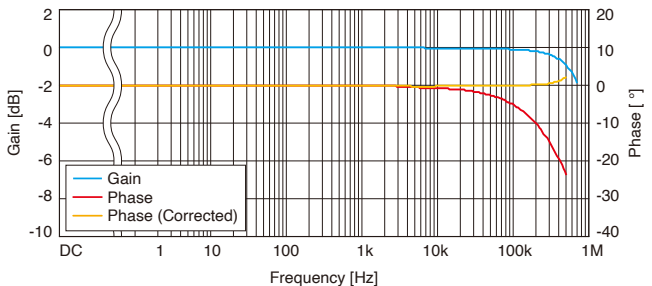

| | |
|---|---|
| Output voltage | 10 mV/A (= 2 V / 200 A) |
| Measurable conductors | Insulated conductor |
| Operating temperature and humidity range | -40°C to 85°C (-40°F to 185°F), 80% RH or less (no condensation) |
| Storage temperature and humidity range | -40°C to 85°C (-40°F to 185°F), 80% RH or less (no condensation) |
| Withstand voltage | 4260 V AC Withstand test current of 1 mA, 50/60 Hz, 1 min., between jaws and cable output terminal |
| Standards | Safety: EN 61010, EMC: EN 61326 |
| Cable length | 3 m (9.84 ft.) |
| Dimensions | 153 mm (6.02 in.) W × 67 mm (2.64 in.) H × 25 mm (0.98 in.) D (excluding protruding parts and cables) |
| Weight | Approx. 380 g (13.4 oz.) |

CT6844A



Product warranty period: 3 years
Guaranteed accuracy period: 1 year

| | |
|--|------------------------------|
| Rated current | 500 A AC/DC |
| Frequency band | DC to 500 kHz |
| Diameter of measurable conductors | Max. ϕ 20 mm (0.79 in.) |

Accuracy

| Frequency | Amplitude \pm (% of reading + % of full scale) | Phase |
|----------------------------|---|---|
| DC | $\pm 0.2\% \pm 0.02\%^*$ | - |
| DC < f \leq 100 Hz | $\pm 0.2\% \pm 0.01\%$ | $\pm 0.1^\circ$ |
| 100 Hz < f \leq 500 Hz | $\pm 0.3\% \pm 0.02\%$ | $\pm 0.2^\circ$ |
| 500 Hz < f \leq 1 kHz | $\pm 0.5\% \pm 0.02\%$ | $\pm 0.5^\circ$ |
| 1 kHz < f \leq 5 kHz | $\pm 1.0\% \pm 0.02\%$ | $\pm 1.0^\circ$ |
| 5 kHz < f \leq 10 kHz | $\pm 1.5\% \pm 0.02\%$ | $\pm 1.5^\circ$ |
| 10 kHz < f \leq 50 kHz | $\pm 5.0\% \pm 0.02\%$ | $\pm (0.15 \times f \text{ kHz})^\circ$ |
| 50 kHz < f \leq 100 kHz | $\pm 15\% \pm 0.05\%$ | $\pm (0.15 \times f \text{ kHz})^\circ$ |
| 100 kHz < f \leq 300 kHz | $\pm 30\% \pm 0.05\%$ | $\pm (0.15 \times f \text{ kHz})^\circ$ |

Combined accuracy with HIOKI power analyzer PW8001, PW6001 and PW3390 is specified (DC, 45 Hz \leq f \leq 66 Hz). For details of combined accuracy, refer to the instruction manual.
*DC accuracy after adjusting the offset voltage to ± 0.2 mV or less.

- The values above are when the input is a sine wave or DC, the measurement instrument's input resistance is $1 \text{ M}\Omega \pm 10\%$, voltage to ground 0 V, no external magnetic fields and the conductor is in the center of the sensor opening.
- Amplitude accuracy and phase accuracy are defined 110% of full scale or less and within the derating curve. DC < f < 10 Hz is a design value.

| | |
|---|---|
| Temperature and humidity range for guaranteed accuracy | 0°C to 40°C (32°F to 104°F), 80% RH or less |
| Effect of temperature | In ranges from -40°C to 0°C (-40°F to 32°F) and 40°C to 85°C (104°F to 185°F) Amplitude sensitivity: $\pm 0.01\%$ of reading / °C Offset voltage: $\pm 0.005\%$ of full scale / °C |
| Common-Mode Rejection Ratio (CMRR) | (effect on output voltage and common mode voltage) 150 dB or greater (DC to 1 kHz) 135 dB or greater (1 kHz to 10 kHz) 120 dB or greater (10 kHz to 100 kHz) 100 dB or greater (100 kHz to 300 kHz) |
| Linearity error | ± 20 ppm |

Frequency derating

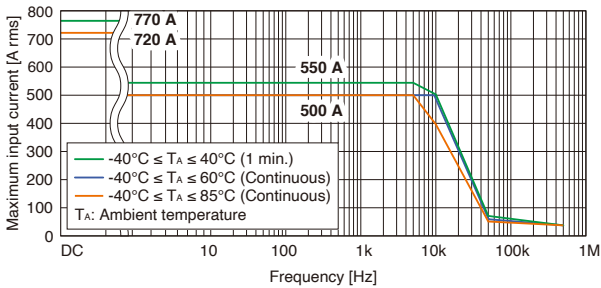

Frequency characteristics (example of typical characteristics)

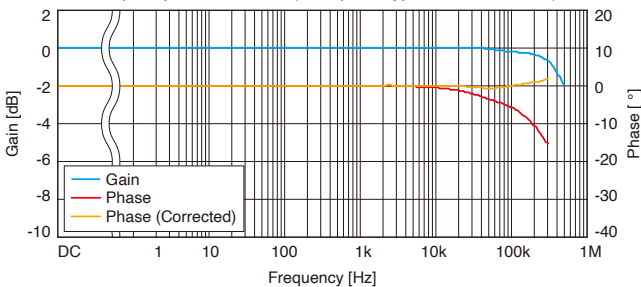

| | |
|---|---|
| Output voltage | 4 mV/A (= 2 V / 500 A) |
| Measurable conductors | Insulated conductor |
| Operating temperature and humidity range | -40°C to 85°C (-40°F to 185°F), 80% RH or less (no condensation) |
| Storage temperature and humidity range | -40°C to 85°C (-40°F to 185°F), 80% RH or less (no condensation) |
| Withstand voltage | 4260 V AC Withstand test current of 1 mA, 50/60 Hz, 1 min., between jaws and cable output terminal |
| Standards | Safety: EN 61010, EMC: EN 61326 |
| Cable length | 3 m (9.84 ft.) |
| Dimensions | 153 mm (6.02 in.) W x 67 mm (2.64 in.) H x 25 mm (0.98 in.) D (excluding protruding parts and cables) |
| Weight | Approx. 400 g (14.1 oz.) |

CT6845A



Product warranty period: 3 years
Guaranteed accuracy period: 1 year

| | |
|--|------------------------------|
| Rated current | 500 A AC/DC |
| Frequency band | DC to 200 kHz |
| Diameter of measurable conductors | Max. ϕ 50 mm (1.97 in.) |

Accuracy

| Frequency | Amplitude \pm (% of reading + % of full scale) | Phase |
|---------------------------|---|--|
| DC | $\pm 0.2\% \pm 0.02\%^*$ | - |
| DC < f \leq 100 Hz | $\pm 0.2\% \pm 0.01\%$ | $\pm 0.1^\circ$ |
| 100 Hz < f \leq 500 Hz | $\pm 0.3\% \pm 0.02\%$ | $\pm 0.2^\circ$ |
| 500 Hz < f \leq 1 kHz | $\pm 0.5\% \pm 0.02\%$ | $\pm 0.5^\circ$ |
| 1 kHz < f \leq 5 kHz | $\pm 1.0\% \pm 0.02\%$ | $\pm (0.5 \times f \text{ kHz})^\circ$ |
| 5 kHz < f \leq 10 kHz | $\pm 1.5\% \pm 0.02\%$ | $\pm (0.5 \times f \text{ kHz})^\circ$ |
| 10 kHz < f \leq 20 kHz | $\pm 5.0\% \pm 0.02\%$ | $\pm (0.5 \times f \text{ kHz})^\circ$ |
| 20 kHz < f \leq 50 kHz | $\pm 10\% \pm 0.05\%$ | $\pm (0.5 \times f \text{ kHz})^\circ$ |
| 50 kHz < f \leq 100 kHz | $\pm 30\% \pm 0.05\%$ | $\pm (0.5 \times f \text{ kHz})^\circ$ |

Combined accuracy with HIOKI power analyzer PW8001, PW6001 and PW3390 is specified (DC, 45 Hz \leq f \leq 66 Hz). For details of combined accuracy, refer to the instruction manual.
*DC accuracy after adjusting the offset voltage to ± 0.2 mV or less.

- The values above are when the input is a sine wave or DC, the measurement instrument's input resistance is $1 \text{ M}\Omega \pm 10\%$, voltage to ground 0 V, no external magnetic fields and the conductor is in the center of the sensor opening.
- Amplitude accuracy and phase accuracy are defined 110% of full scale or less and within the derating curve. DC < f < 10 Hz is a design value.
- Add $\pm 0.03\%$ of reading to the amplitude accuracy for input from 100% of full scale to 110% of full scale.

| | |
|---|--|
| Temperature and humidity range for guaranteed accuracy | 0°C to 40°C (32°F to 104°F), 80% RH or less |
| Effect of temperature | In ranges from -40°C to 0°C (-40°F to 32°F) and 40°C to 85°C (104°F to 185°F) Amplitude sensitivity: $\pm 0.01\%$ of reading / °C Offset voltage: $\pm 0.005\%$ of full scale / °C |
| Common-Mode Rejection Ratio (CMRR) | (effect on output voltage and common mode voltage) 150 dB or greater (DC to 1 kHz) 130 dB or greater (1 kHz to 10 kHz) 100 dB or greater (10 kHz to 100 kHz) |
| Linearity error | ± 20 ppm |

Frequency derating

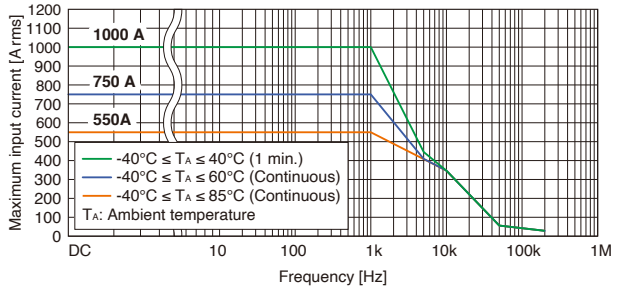

Frequency characteristics (example of typical characteristics)

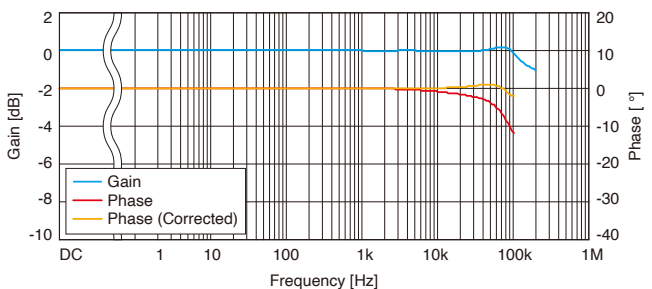

| | |
|---|--|
| Output voltage | 4 mV/A (= 2 V / 500 A) |
| Measurable conductors | Insulated conductor |
| Operating temperature and humidity range | -40°C to 85°C (-40°F to 185°F), 80% RH or less (no condensation) |
| Storage temperature and humidity range | -40°C to 85°C (-40°F to 185°F), 80% RH or less (no condensation) |
| Withstand voltage | 4260 V AC Withstand test current of 1 mA, 50/60 Hz, 1 min., between jaws and cable output terminal |
| Standards | Safety: EN 61010, EMC: EN 61326 |
| Cable length | 3 m (9.84 ft.) |
| Dimensions | 238 mm (9.37 in.) W x 116 mm (4.57 in.) H x 35 mm (1.38 in.) D (excluding protruding parts and cables) |
| Weight | Approx. 860 g (30.3 oz.) |

CT6846A



Product warranty period: 3 years
Guaranteed accuracy period: 1 year

| | |
|--|-------------------------|
| Rated current | 1000 A AC/DC |
| Frequency band | DC to 100 kHz |
| Diameter of measurable conductors | Max. φ 50 mm (1.97 in.) |

Accuracy

| Frequency | Amplitude ±(% of reading + % of full scale) | Phase |
|---------------------|--|-----------------|
| DC | ±0.2% ±0.02%* | - |
| DC < f ≤ 100 Hz | ±0.2% ±0.01% | ±0.1° |
| 100 Hz < f ≤ 500 Hz | ±0.5% ±0.02% | ±0.2° |
| 500 Hz < f ≤ 1 kHz | ±1.0% ±0.02% | ±0.5° |
| 1 kHz < f ≤ 5 kHz | ±2.0% ±0.02% | ±(0.7 × f kHz)° |
| 5 kHz < f ≤ 10 kHz | ±5.0% ±0.02% | ±(0.7 × f kHz)° |
| 10 kHz < f ≤ 50 kHz | ±30% ±0.02% | ±(0.7 × f kHz)° |

Combined accuracy with HIOKI power analyzer PW8001, PW6001 and PW3390 is specified (DC, 45 Hz ≤ f ≤ 66 Hz). For details of combined accuracy, refer to the instruction manual.
*DC accuracy after adjusting the offset voltage to ±0.2 mV or less.

- The values above are when the input is a sine wave or DC, the measurement instrument's input resistance is 1 MΩ ±10%, voltage to ground 0 V, no external magnetic fields and the conductor is in the center of the sensor opening.
- Amplitude accuracy and phase accuracy are defined 110% of full scale or less and within the derating curve. DC < f < 10 Hz is a design value.
- Add ±0.03% of reading to the amplitude accuracy for input from 100% of full scale to 110% of full scale.

| | |
|---|--|
| Temperature and humidity range for guaranteed accuracy | 0°C to 40°C (32°F to 104°F), 80% RH or less |
| Effect of temperature | In ranges from -40°C to 0°C (-40°F to 32°F) and 40°C to 85°C (104°F to 185°F) Amplitude sensitivity: ±0.01% of reading / °C Offset voltage: ±0.005% of full scale / °C |
| Common-Mode Rejection Ratio (CMRR) | (effect on output voltage and common mode voltage) 150 dB or greater (DC to 1 kHz) 130 dB or greater (1 kHz to 10 kHz) 100 dB or greater (10 kHz to 50 kHz) |
| Linearity error | ±20 ppm |

Frequency derating

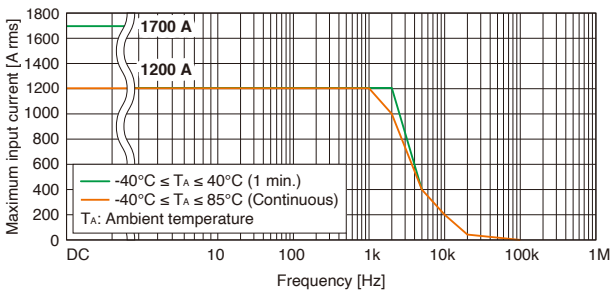

Frequency characteristics (example of typical characteristics)

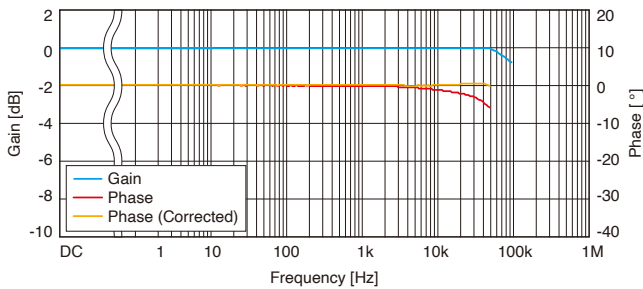

| | |
|---|--|
| Output voltage | 2 mV/A (= 2 V / 1000 A) |
| Measurable conductors | Insulated conductor |
| Operating temperature and humidity range | -40°C to 85°C (-40°F to 185°F), 80% RH or less (no condensation) |
| Storage temperature and humidity range | -40°C to 85°C (-40°F to 185°F), 80% RH or less (no condensation) |
| Withstand voltage | 4260 V AC Withstand test current of 1 mA, 50/60 Hz, 1 min., between jaws and cable output terminal |
| Standards | Safety: EN 61010, EMC: EN 61326 |
| Cable length | 3 m (9.84 ft.) |
| Dimensions | 238 mm (9.37 in.) W × 116 mm (4.57 in.) H × 35 mm (1.38 in.) D (excluding protruding parts and cables) |
| Weight | Approx. 990 g (34.9 oz.) |

9272-05



Product warranty period: 3 years
Guaranteed accuracy period: 1 year

| | |
|--|------------------------------|
| Rated current | 20 A AC, 200 A AC (2 ranges) |
| Frequency band | 1 Hz to 100 kHz |
| Diameter of measurable conductors | φ 46 mm or less |

Accuracy

| Frequency | Amplitude ±(% of reading + % of full scale) | Phase |
|----------------------|--|--------|
| 1 Hz ≤ f < 5 Hz | ±2.0% ±0.10% | - |
| 5 Hz ≤ f < 10 Hz | ±1.0% ±0.05% | ±1.0° |
| 10 Hz ≤ f < 45 Hz | ±0.5% ±0.02% | ±0.5° |
| 45 Hz ≤ f ≤ 66 Hz | ±0.3% ±0.01% | ±0.2° |
| 66 Hz < f ≤ 500 Hz | ±0.5% ±0.02% | ±0.5° |
| 500 Hz < f ≤ 1 kHz | ±0.5% ±0.02% | ±1.0° |
| 1 kHz < f ≤ 5 kHz | ±1.0% ±0.05% | ±2.0° |
| 5 kHz < f ≤ 10 kHz | ±2.5% ±0.10% | ±3.0° |
| 10 kHz < f ≤ 20 kHz | ±5% ±0.1% | ±5.0° |
| 20 kHz < f ≤ 50 kHz | ±5% ±0.1% | ±15.0° |
| 50 kHz < f ≤ 100 kHz | ±30% ±0.1% | - |

Accuracy is specified by the following conditions:
 • Less than or equal to the rated current of each current range
 • Within derating range of each current range
 The accuracy values above are for within the rated current for each range and inside of derating range. (The values are the values by design: amplitude at under 5 Hz and phase at under 10 Hz)

| | |
|---|---|
| Temperature and humidity range for guaranteed accuracy | 23°C ±5°C (73°F ±9°F), 80% RH or less |
| Effect of temperature | Amplitude sensitivity: ±0.03% of reading / °C |

Frequency derating

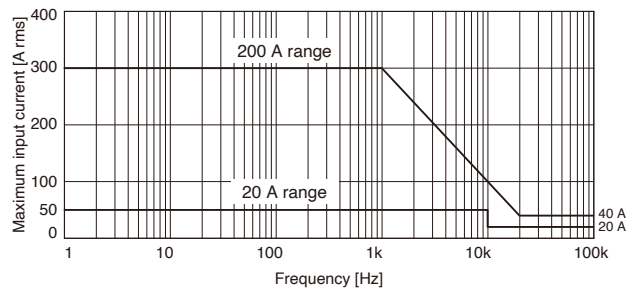

Frequency characteristics (example of typical characteristics)

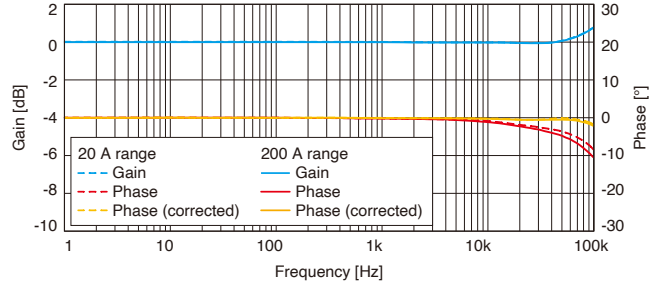

| | |
|---|--|
| Output voltage | 20 A range: 100 mV/A (= 2 V / 20 A) 200 A range: 10 mV/A (= 2 V / 200 A) |
| Operating temperature and humidity range | 0°C to 50°C (32°F to 122°F), 80% RH or less (no condensation) |
| Storage temperature and humidity range | -10°C to 60°C (14°F to 140°F), 80% RH or less (no condensation) |
| Maximum rated voltage to ground | 600 V AC CAT III (50/60 Hz) Anticipated transient overvoltage: 6000 V |
| Standards | Safety: EN 61010, EMC: EN 61326 Class A |
| Cable length | 3 m (9.84 ft.) |
| Dimensions | 78 mm (3.07 in) W × 188 mm (7.40 in) H × 35 mm (1.38 in) D (excluding protruding parts and cables) |
| Weight | Approx. 450 g (15.9 oz.) |

CT6710

Product warranty period: 1 year
Guaranteed accuracy period: 1 year



| | |
|--|--|
| Rated current* (3 ranges) | 30 Arms, 5 Arms, 0.5 Arms AC/DC |
| Frequency band | DC to 50 MHz (-3dB) |
| Diameter of measurable conductors | Max. ϕ 5 mm (0.20 in.) (insulated conductors) |

*DC or sine wave signals of 45 to 66 Hz, within maximum peak current for each range

| | |
|-----------------------------|--|
| Rise time | 7.0 ns or less (10% to 90%) |
| Output voltage | 0.1 V/A (30 A range) 1 V/A (5 A range) 10 V/A (0.5 A range) |
| Maximum peak current | ± 50 A peak* ¹ (30 A range) ± 7.5 A peak (5 A range) ± 0.75 A peak (0.5 A range, ≥ 10 MHz) ± 0.3 A peak (0.5 A range, < 10 MHz) |
| Noise | 75 μ Arms or less* ² (typical: 60 μ Arms) |

*1: Maximum 2 sec input; requires cooling time of at least 10 times longer than the time current has been input
*2: Does not apply to devices to which the probe is connected; applicable in the 0.5 A range and when used with 20 MHz bandwidth instrument devices

Accuracy (amplitude)

| Range | Accuracy | typical |
|-------|------------------------------------|--|
| 30 A | $\pm 3.0\%$ of reading ± 1 mV | $\pm 1.0\%$ of reading ± 1 mV (≤ 10 A) |
| 5 A | $\pm 3.0\%$ of reading ± 1 mV | $\pm 1.0\%$ of reading ± 1 mV |
| 0.5 A | $\pm 3.0\%$ of reading ± 10 mV | $\pm 1.0\%$ of reading ± 10 mV |

The accuracy above is valid within the following conditions:
Warm-up time: 30 minutes, operating environment of 23°C \pm 5°C (73°F \pm 9°F) at 80% RH or less, DC or sine wave signals of 45 to 66 Hz, within maximum peak current for each range

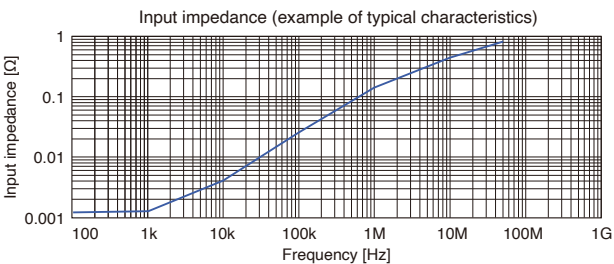
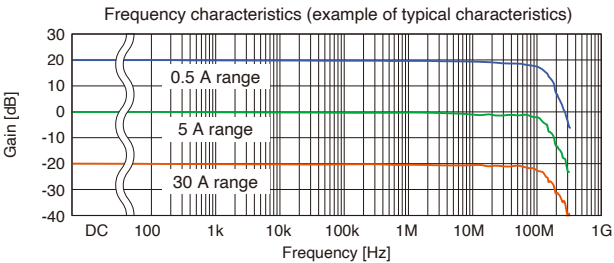
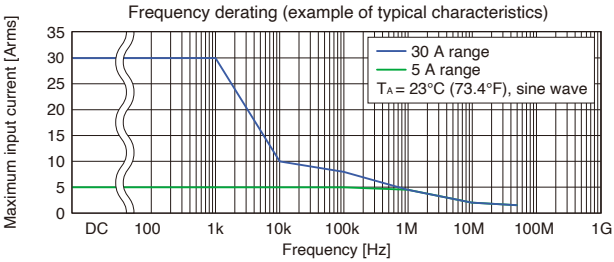

| | |
|---|---|
| Operating temperature and humidity range | 0°C to 40°C (32°F to 104°F), 80% RH or less (no condensation) |
| Storage temperature and humidity range | -10°C to 50°C (14°F to 122°F), 80% RH or less (no condensation) |
| Standards | Safety: EN 61010, EMC: EN 61326 |
| Maximum rated power | 7.8 VA (continuous maximum input) |
| Cable length | Sensor/junction box: 1500 mm (59.06 in.) Junction box/termination unit: 150 mm (5.91 in.) Power cord: 1000 mm (39.37 in.) |
| Dimensions | Sensor: 155 mm (6.10 in.) W \times 18 mm (0.71 in.) H \times 26 mm (1.02 in.) D Junction box: 45 mm (1.77 in.) W \times 120 mm (4.72 in.) H \times 25 mm (0.98 in.) D Termination unit: 29 mm (1.14 in.) W \times 83 mm (3.27 in.) H \times 40 mm (1.57 in.) D (excluding BNC connector or protrusions) |
| Weight | Approx. 370 g (13.1 oz.) |

CT6711

Product warranty period: 1 year
Guaranteed accuracy period: 1 year



| | |
|--|--|
| Rated current* (3 ranges) | 30 Arms, 5 Arms, 0.5 Arms AC/DC |
| Frequency band | DC to 120 MHz (-3dB) |
| Diameter of measurable conductors | Max. ϕ 5 mm (0.20 in.) (insulated conductors) |

*DC or sine wave signals of 45 to 66 Hz, within maximum peak current for each range

| | |
|-----------------------------|--|
| Rise time | 2.9 ns or less (10% to 90%) |
| Output voltage | 0.1 V/A (30 A range) 1 V/A (5 A range) 10 V/A (0.5 A range) |
| Maximum peak current | ± 50 A peak* ¹ (30 A range) ± 7.5 A peak (5 A range) ± 0.75 A peak (0.5 A range, ≥ 10 MHz) ± 0.3 A peak (0.5 A range, < 10 MHz) |
| Noise | 75 μ Arms or less* ² (typical: 60 μ Arms) |

*1: Maximum 2 sec input; requires cooling time of at least 10 times longer than the time current has been input
*2: Does not apply to devices to which the probe is connected; applicable in the 0.5 A range and when used with 20 MHz bandwidth instrument devices

Accuracy (amplitude)

| Range | Accuracy | typical |
|-------|------------------------------------|--|
| 30 A | $\pm 3.0\%$ of reading ± 1 mV | $\pm 1.0\%$ of reading ± 1 mV (≤ 10 A) |
| 5 A | $\pm 3.0\%$ of reading ± 1 mV | $\pm 1.0\%$ of reading ± 1 mV |
| 0.5 A | $\pm 3.0\%$ of reading ± 10 mV | $\pm 1.0\%$ of reading ± 10 mV |

The accuracy above is valid within the following conditions:
Warm-up time: 30 minutes, operating environment of 23°C \pm 5°C (73°F \pm 9°F) at 80% RH or less, DC or sine wave signals of 45 to 66 Hz, within maximum peak current for each range

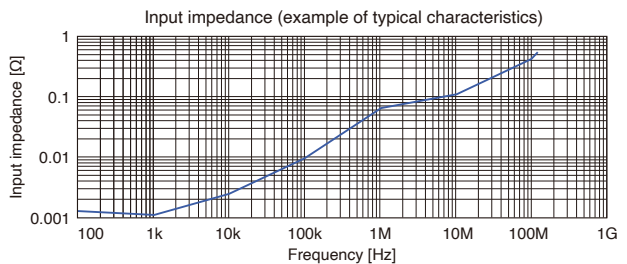
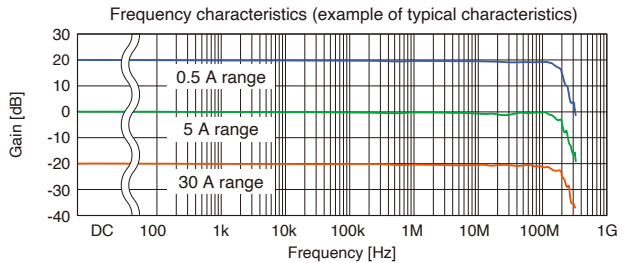
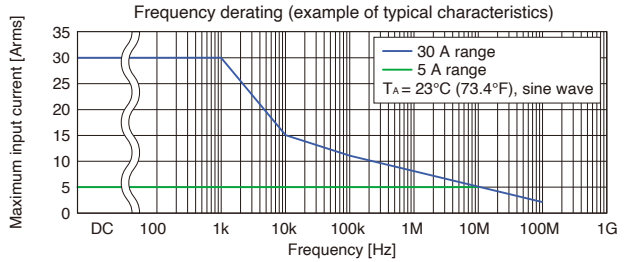

| | |
|---|---|
| Operating temperature and humidity range | 0°C to 40°C (32°F to 104°F), 80% RH or less (no condensation) |
| Storage temperature and humidity range | -10°C to 50°C (14°F to 122°F), 80% RH or less (no condensation) |
| Standards | Safety: EN 61010, EMC: EN 61326 |
| Maximum rated power | 7.8 VA (continuous maximum input) |
| Cable length | Sensor/junction box: 1500 mm (59.06 in.) Junction box/termination unit: 150 mm (5.91 in.) Power cord: 1000 mm (39.37 in.) |
| Dimensions | Sensor: 155 mm (6.10 in.) W \times 18 mm (0.71 in.) H \times 26 mm (1.02 in.) D Junction box: 45 mm (1.77 in.) W \times 120 mm (4.72 in.) H \times 25 mm (0.98 in.) D Termination unit: 29 mm (1.14 in.) W \times 83 mm (3.27 in.) H \times 40 mm (1.57 in.) D (excluding BNC connector or protrusions) |
| Weight | Approx. 370 g (13.1 oz.) |

CT6700



Product warranty period: 1 year
Guaranteed accuracy period: 1 year

| | |
|--|--|
| Rated current* | 5 Arms |
| Frequency band | DC to 50 MHz (-3dB) |
| Diameter of measurable conductors | Max. ϕ 5 mm (0.20 in.) (insulated conductors) |

*DC or sine wave signals of 45 to 66 Hz, within maximum peak current for each range

| | |
|-----------------------------|--|
| Rise time | 7.0 ns or less (10% to 90%) |
| Output voltage | 1 V/A |
| Maximum peak current | ± 7.5 A peak (non-continuous) |
| Noise | 75 μ Arms or less* (typical: 60 μ A rms) |

*Does not apply to devices to which the probe is connected; applicable when used with 30 MHz bandwidth instrument devices

Accuracy (amplitude)

| Accuracy | typical |
|-----------------------------------|-----------------------------------|
| $\pm 3.0\%$ of reading ± 1 mV | $\pm 1.0\%$ of reading ± 1 mV |

The accuracy above is valid within the following conditions:
Warm-up time: 30 minutes, operating environment of 23°C \pm 5°C (73°F \pm 9°F) at 80% RH or less, DC or sine wave signals of 45 to 66 Hz, 0 Arms to 5 Arms

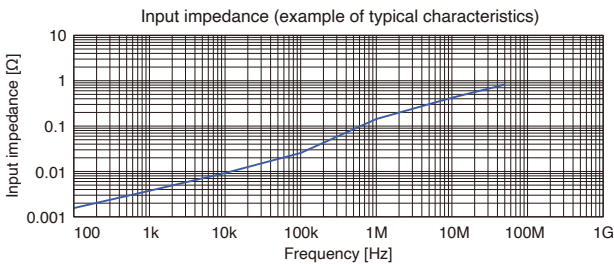
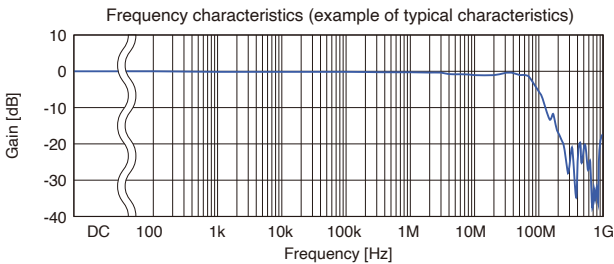
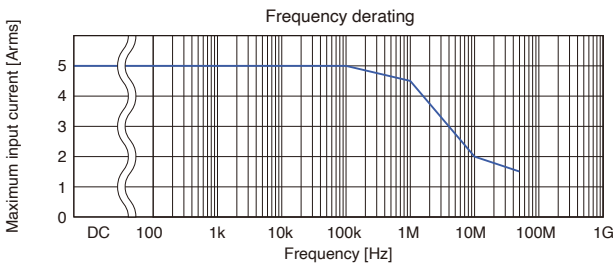

| | |
|---|--|
| Operating temperature and humidity range | 0°C to 40°C (32°F to 104°F), 80% RH or less (no condensation) |
| Storage temperature and humidity range | -10°C to 50°C (14°F to 122°F), 80% RH or less (no condensation) |
| Standards | Safety: EN 61010, EMC: EN 61326 |
| Maximum rated power | 3.2 VA (continuous maximum input) |
| Cable length | Sensor cable: 1500 mm (59.06 in.) Power cord: 1000 mm (39.37 in.) |
| Dimensions | Sensor: 155 mm (6.10 in.) W x 18 mm (0.71 in.) H x 26 mm (1.02 in.) D Termination unit: 29 mm (1.14 in.) W x 83 mm (3.27 in.) H x 40 mm (1.57 in.) D (excluding BNC connector or protrusions) |
| Weight | Approx. 250 g (8.8 oz.) |

CT6701



Product warranty period: 1 year
Guaranteed accuracy period: 1 year

| | |
|--|--|
| Rated current* | 5 Arms |
| Frequency band | DC to 120 MHz (-3dB) |
| Diameter of measurable conductors | Max. ϕ 5 mm (0.20 in.) (insulated conductors) |

*DC or sine wave signals of 45 to 66 Hz, within maximum peak current for each range

| | |
|-----------------------------|--|
| Rise time | 2.9 ns or less (10% to 90%) |
| Output voltage | 1 V/A |
| Maximum peak current | ± 7.5 A peak (non-continuous) |
| Noise | 75 μ Arms or less* (typical: 60 μ A rms) |

*Does not apply to devices to which the probe is connected; applicable when used with 30 MHz bandwidth instrument devices

Accuracy (amplitude)

| Accuracy | typical |
|-----------------------------------|-----------------------------------|
| $\pm 3.0\%$ of reading ± 1 mV | $\pm 1.0\%$ of reading ± 1 mV |

The accuracy above is valid within the following conditions:
Warm-up time: 30 minutes, operating environment of 23°C \pm 5°C (73°F \pm 9°F) at 80% RH or less, DC or sine wave signals of 45 to 66 Hz, 0 Arms to 5 Arms

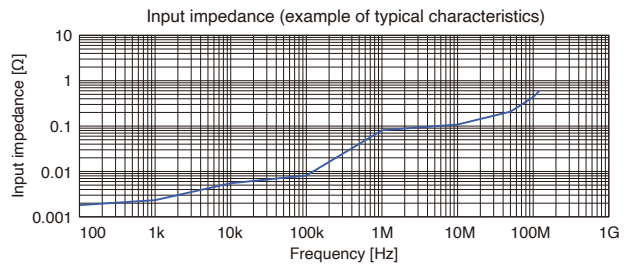
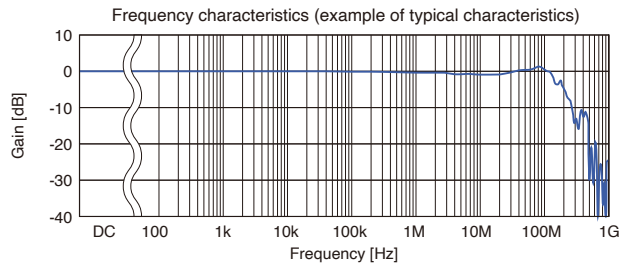
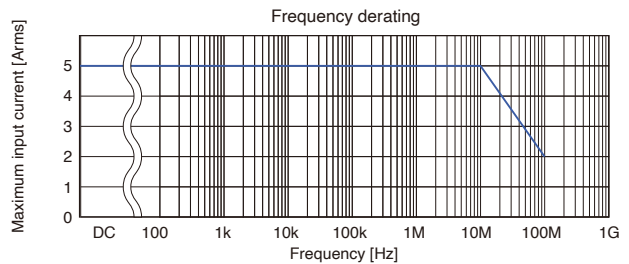

| | |
|---|--|
| Operating temperature and humidity range | 0°C to 40°C (32°F to 104°F), 80% RH or less (no condensation) |
| Storage temperature and humidity range | -10°C to 50°C (14°F to 122°F), 80% RH or less (no condensation) |
| Standards | Safety: EN 61010, EMC: EN 61326 |
| Maximum rated power | 3.2 VA (continuous maximum input) |
| Cable length | Sensor cable: 1500 mm (59.06 in.) Power cord: 1000 mm (39.37 in.) |
| Dimensions | Sensor: 155 mm (6.10 in.) W x 18 mm (0.71 in.) H x 26 mm (1.02 in.) D Termination unit: 29 mm (1.14 in.) W x 83 mm (3.27 in.) H x 40 mm (1.57 in.) D (excluding BNC connector or protrusions) |
| Weight | Approx. 250 g (8.8 oz.) |

3273-50

Product warranty period: 1 year
Guaranteed accuracy period: 1 year



| | |
|--|--|
| Rated current* | 30 Arms |
| Frequency band | DC to 50 MHz (-3dB) |
| Diameter of measurable conductors | Max. ϕ 5 mm (0.20 in.) (insulated conductors) |

*Refer to the graph for frequency derating characteristics.

| | |
|-----------------------------|----------------------------|
| Rise time | 7.0 ns or less |
| Output voltage | 0.1 V/A |
| Maximum peak current | 50 A peak (non-continuous) |
| Noise | 2.5 mArms or less* |

*Does not apply to devices to which the probe is connected;
applicable when used with 20 MHz bandwidth instrument devices

Accuracy (amplitude)

| | |
|-----------------------------------|------------------------|
| to 30 Arms | to 50 A peak |
| $\pm 1.0\%$ of reading ± 1 mV | $\pm 2.0\%$ of reading |

The accuracy above is valid within the following conditions:
Warm-up time: 30 minutes, operating environment of 23°C \pm 5°C (73°F \pm 9°F) at 80% RH or less, DC or sine wave signals of 45 to 66 Hz, 0 Arms to 5 Arms

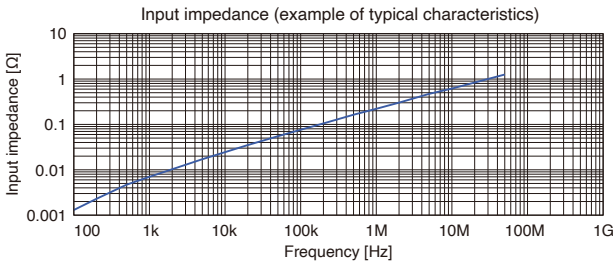
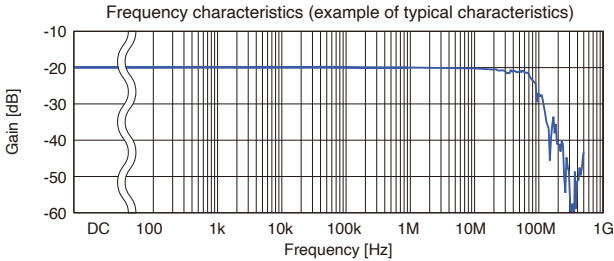
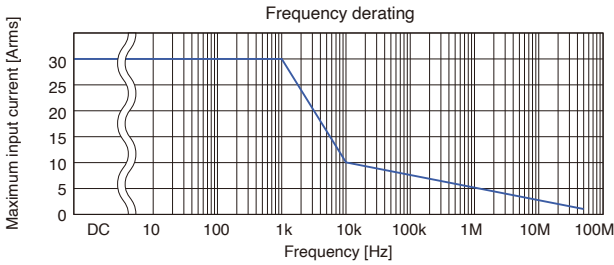

| | |
|---|--|
| Operating temperature and humidity range | 0°C to 40°C (32°F to 104°F), 80% RH or less (no condensation) |
| Storage temperature and humidity range | -10°C to 50°C (14°F to 122°F), 80% RH or less (no condensation) |
| Standards | Safety: EN 61010, EMC: EN 61326 |
| Maximum rated power | 5.6 VA |
| Cable length | Sensor cable: 1500 mm (59.06 in.) Power cord: 1000 mm (39.37 in.) |
| Dimensions | Sensor: 175 mm (6.89 in.) W x 18 mm (0.71 in.) H x 40 mm (1.57 in.) D Termination unit: 27 mm (1.06 in.) W x 55 mm (2.17 in.) H x 18 mm (0.71 in.) D (excluding BNC connector or protrusions) |
| Weight | Approx. 230 g (8.1 oz) |

3276

Product warranty period: 1 year
Guaranteed accuracy period: 1 year



| | |
|--|--|
| Rated current* | 30 Arms |
| Frequency band | DC to 100 MHz (-3dB) |
| Diameter of measurable conductors | Max. ϕ 5 mm (0.20 in.) (insulated conductors) |

*Refer to the graph for frequency derating characteristics.

| | |
|-----------------------------|----------------------------|
| Rise time | 3.5 ns or less |
| Output voltage | 0.1 V/A |
| Maximum peak current | 50 A peak (non-continuous) |
| Noise | 2.5 mArms or less* |

*Does not apply to devices to which the probe is connected;
applicable when used with 20 MHz bandwidth instrument devices

Accuracy (amplitude)

| | |
|-----------------------------------|------------------------|
| to 30 Arms | to 50 A peak |
| $\pm 1.0\%$ of reading ± 1 mV | $\pm 2.0\%$ of reading |

The accuracy above is valid within the following conditions:
Warm-up time: 30 minutes, operating environment of 23°C \pm 5°C (73°F \pm 9°F) at 80% RH or less, DC or sine wave signals of 45 to 66 Hz, 0 Arms to 5 Arms

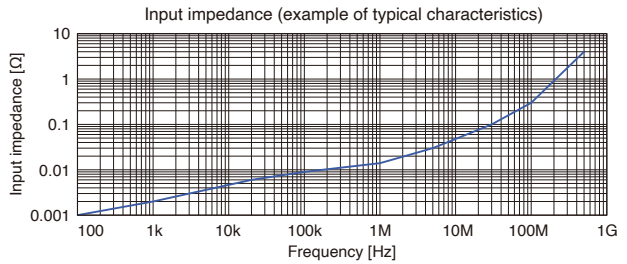
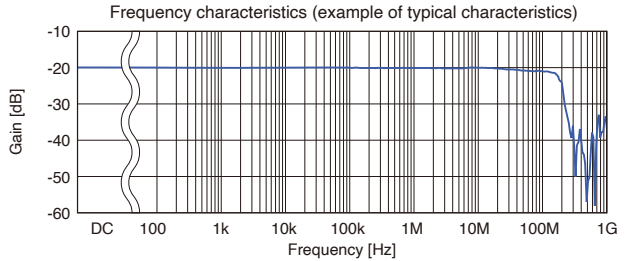
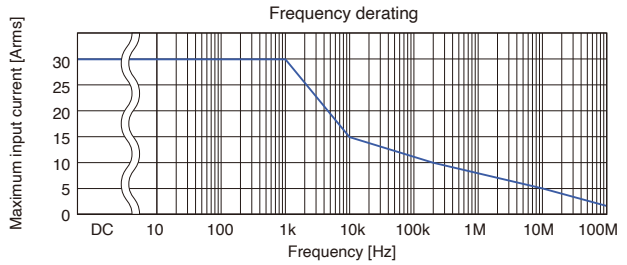

| | |
|---|--|
| Operating temperature and humidity range | 0°C to 40°C (32°F to 104°F), 80% RH or less (no condensation) |
| Storage temperature and humidity range | -10°C to 50°C (14°F to 122°F), 80% RH or less (no condensation) |
| Standards | Safety: EN 61010, EMC: EN 61326 |
| Maximum rated power | 5.3 VA |
| Cable length | Sensor cable: 1500 mm (59.06 in.) Power cord: 1000 mm (39.37 in.) |
| Dimensions | Sensor: 175 mm (6.89 in.) W x 18 mm (0.71 in.) H x 40 mm (1.57 in.) D Termination unit: 27 mm (1.06 in.) W x 55 mm (2.17 in.) H x 18 mm (0.71 in.) D (excluding BNC connector or protrusions) |
| Weight | Approx. 240 g (8.5 oz) |

3274

Product warranty period: 1 year
Guaranteed accuracy period: 1 year



| | |
|--|--|
| Rated current* | 150 Arms |
| Frequency band | DC to 10 MHz (-3dB) |
| Diameter of measurable conductors | Max. φ 20 mm (0.79 in)(insulated conductors) |

*The accuracy above is valid within the following conditions:
DC or sine wave signals of 45 to 66 Hz, within maximum peak current for each range

| | |
|-----------------------------|-------------------------------|
| Rise time | 35 ns or less |
| Output voltage | 0.01 V/A |
| Maximum peak current | 300 A peak (non-continuous)*1 |
| Noise | 25 mArms or less*2 |

*1: 500 A peak with pulse width ≤ 30 μs
*2: Does not apply to devices to which the probe is connected;
when used with a 20 MHz bandwidth instrument devices

Accuracy (amplitude)

| | |
|------------------------|------------------|
| to 150 A | to 300 A peak |
| ±1.0% of reading ±1 mV | ±2.0% of reading |

The accuracy above is valid within the following conditions:
Warm-up time: 30 minutes, operating environment of 23°C± 5°C (73°F ±9°F) at 80% RH or less, DC or sine wave signals of 45 to 66 Hz

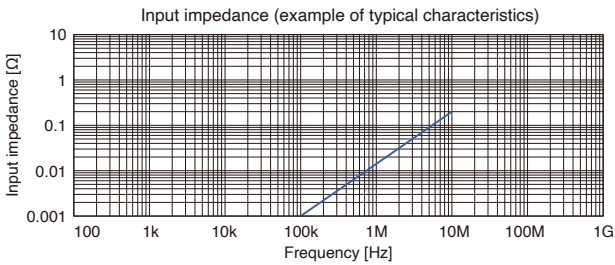
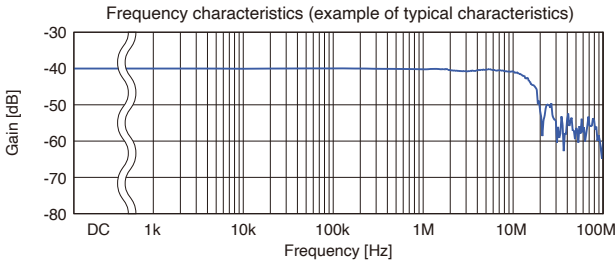
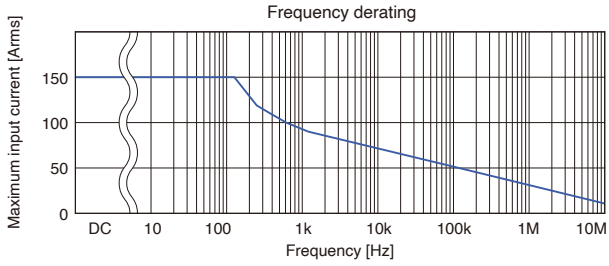

| | |
|---|--|
| Operating temperature and humidity range | 0°C to 40°C (32°F to 104°F), 80% RH or less (no condensation) |
| Storage temperature and humidity range | -10°C to 50°C (14°F to 122°F), 80% RH or less (no condensation) |
| Standards | Safety: EN 61010, EMC: EN 61326 |
| Maximum rated power | 5.5 VA (continuous maximum input) |
| Cable length | Sensor cable: 2000 mm (78.74 in.) Power cord: 1000 mm (39.37 in.) |
| Dimensions | Sensor: 176 mm (6.93 in.) W × 69 mm (2.72 in.) H × 27 mm (1.06 in.) D Termination unit: 27 mm (1.06 in.) W × 55 mm (2.17 in.) H × 18 mm (0.71 in.) D (excluding BNC connector or protrusions) |
| Weight | Approx. 500 g (17.6 oz) |

3275

Product warranty period: 1 year
Guaranteed accuracy period: 1 year



| | |
|--|--|
| Rated current* | 500 Arms |
| Frequency band | DC to 2 MHz (-3dB) |
| Diameter of measurable conductors | Max. φ 20 mm (0.79 in)(insulated conductors) |

*The accuracy above is valid within the following conditions:
DC or sine wave signals of 45 to 66 Hz, within maximum peak current for each range

| | |
|-----------------------------|-----------------------------|
| Rise time | 175 ns or less |
| Output voltage | 0.01 V/A |
| Maximum peak current | 700 A peak (non-continuous) |
| Noise | 25 mArms or less* |

*Does not apply to devices to which the probe is connected;
when used with a 20 MHz bandwidth instrument devices

Accuracy (amplitude)

| | |
|------------------------|------------------|
| to 500 A | to 700 A peak |
| ±1.0% of reading ±5 mV | ±2.0% of reading |

The accuracy above is valid within the following conditions:
Warm-up time: 30 minutes, operating environment of 23°C± 5°C (73°F ±9°F) at 80% RH or less, DC or sine wave signals of 45 to 66 Hz

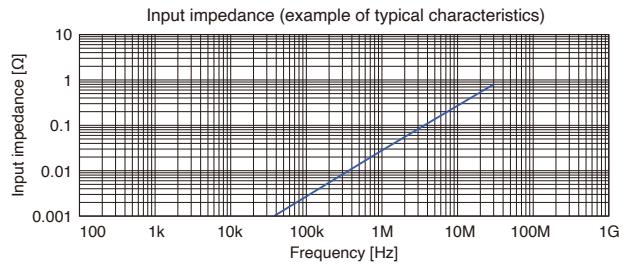
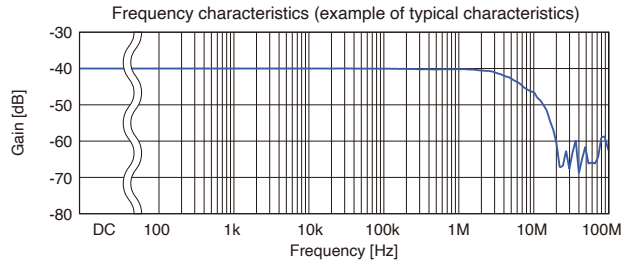
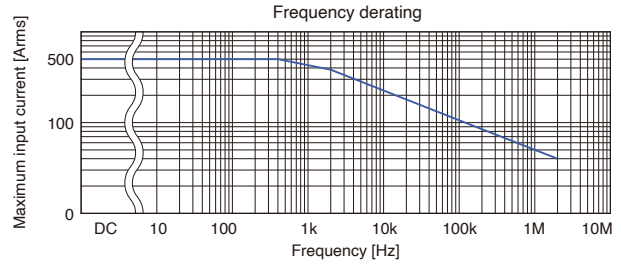

| | |
|---|--|
| Operating temperature and humidity range | 0°C to 40°C (32°F to 104°F), 80% RH or less (no condensation) |
| Storage temperature and humidity range | -10°C to 50°C (14°F to 122°F), 80% RH or less (no condensation) |
| Standards | Safety: EN 61010, EMC: EN 61326 |
| Maximum rated power | 7.2 VA (continuous maximum input) |
| Cable length | Sensor cable: 2000 mm (78.74 in.) Power cord: 1000 mm (39.37 in.) |
| Dimensions | Sensor: 176 mm (6.93 in.) W × 69 mm (2.72 in.) H × 27 mm (1.06 in.) D Termination unit: 27 mm (1.06 in.) W × 55 mm (2.17 in.) H × 18 mm (0.71 in.) D (excluding BNC connector or protrusions) |
| Weight | Approx. 520 g (18.3 oz) |

| High-accuracy measurement (ME15W) | | |
|-----------------------------------|---------------|-----------------|
| Pass-through types | Rated current | Frequency range |
| CT6862-05 | 50 A | DC to 1 MHz |
| CT6872 | 50 A | DC to 10 MHz |
| CT6872-01 | 50 A | DC to 10 MHz |
| CT6863-05 | 200 A | DC to 500 kHz |
| CT6873 | 200 A | DC to 10 MHz |
| CT6873-01 | 200 A | DC to 10 MHz |
| CT6875A | 500 A | DC to 2 MHz |
| CT6875A-1 | 500 A | DC to 1.5 MHz |
| CT6904A | 500 A | DC to 4 MHz |
| CT6904A-1 | 500 A | DC to 2 MHz |
| CT6904A-2 | 800 A | DC to 4 MHz |
| CT6904A-3 | 800 A | DC to 2 MHz |
| CT6876A | 1000 A | DC to 1.5 MHz |
| CT6876A-1 | 1000 A | DC to 1.2 MHz |
| CT6877A | 2000 A | DC to 1 MHz |
| CT6877A-1 | 2000 A | DC to 1 MHz |
| Clamp types | Rated current | Frequency range |
| 9272-05 | 20 A, 200 A | 1 Hz to 100 kHz |
| CT6841A | 20 A | DC to 2 MHz |
| CT6843A | 200 A | DC to 700 kHz |
| CT6844A | 500 A | DC to 500 kHz |
| CT6845A | 500 A | DC to 200 kHz |
| CT6846A | 1000 A | DC to 100 kHz |
| Direct-wired types | Rated current | Frequency range |
| PW9100A-3 | 50 A | DC to 3.5 MHz |
| PW9100A-4 | 50 A | DC to 3.5 MHz |

| Connection options | |
|--------------------|--|
| CT9555 | 1 ch, external power supply, with waveform output function |
| CT9556 | 1 ch, external power supply, with waveform/RMS output function |
| CT9557 | 4 ch, external power supply, includes waveform/aggregated-waveform/aggregated-RMS output functions |
| L9217 | Isolated BNC terminals |
| 9165 | Metallic BNC terminals |
| CT9904 | Used with CT9557 added waveform output |
| CT9901 | Converts ME15W terminal to PL23 terminal |
| CT9902 | Used to extend cable length |

| Waveform observation (BNC) | | |
|-----------------------------------|--|-----------------|
| High-sensitivity observation | Rated current | Frequency range |
| CT6710 | 0.5 A, 5 A, 30 A | DC to 50 MHz |
| CT6711 | 0.5 A, 5 A, 30 A | DC to 120 MHz |
| Observation of minuscule currents | Rated current | Frequency range |
| CT6700 | 5 A | DC to 50 MHz |
| CT6701 | 5 A | DC to 120 MHz |
| Observation of large currents | Rated current | Frequency range |
| 3273-50 | 30 A | DC to 50 MHz |
| 3276 | 30 A | DC to 100 MHz |
| 3274 | 150 A | DC to 10 MHz |
| 3275 | 500 A | DC to 2 MHz |
| Connection options | | |
| 3269 | 4 ch, external power supply, total output 2.5 A | |
| 3272 | 2 ch, external power supply, total output 600 mA | |

| Grid power quality control (PL14) | | |
|-----------------------------------|--|-----------------|
| Measurement of load current | Rated current | Frequency range |
| CT7126 | 60 A | 40 Hz to 2 kHz |
| CT7131 | 100 A | 40 Hz to 2 kHz |
| CT7731 | 100 A | DC to 5 kHz |
| CT7631 | 100 A | DC to 10 kHz |
| CT7736 | 600 A | DC to 5 kHz |
| CT7636 | 600 A | DC to 10 kHz |
| CT7136 | 600 A | 40 Hz to 5 kHz |
| CT7742 | 2000 A | DC to 5 kHz |
| CT7642 | 2000 A | DC to 10 kHz |
| Measurement of large currents | Rated current | Frequency range |
| CT7044 | 6000 A | 10 Hz to 50 kHz |
| CT7045 | 6000 A | 10 Hz to 50 kHz |
| CT7046 | 6000 A | 10 Hz to 50 kHz |
| Measurement of leakage current | Rated current | Frequency range |
| CT7116 | 6 A | 40 Hz to 5 kHz |
| Connection options | | |
| CT9920 | Converts PL14 terminal to ME15W terminal | |
| L9095 | Connects CM7290, CM7291 and instrument | |
| L0220-01 | Extends a cable with a PL14 terminal, 2 m (6.56 ft.) | |
| L0220-02 | Extends a cable with a PL14 terminal, 5 m (16.40 ft.) | |
| L0220-03 | Extends a cable with a PL14 terminal, 10 m (32.81 ft.) | |
| L0220-04 | Extends a cable with a PL14 terminal, 20 m (65.62 ft.) | |
| L0220-05 | Extends a cable with a PL14 terminal, 30 m (98.43 ft.) | |
| L0220-06 | Extends a cable with a PL14 terminal, 50 m (164.04 ft.) | |
| L0220-07 | Extends a cable with a PL14 terminal, 100 m (328.08 ft.) | |

| Grid power quality control (BNC) | | |
|----------------------------------|---|-----------------|
| Measurement of load current | Rated current | Frequency range |
| 9694 | 5 A | 40 Hz to 5 kHz |
| 9695-02 | 50 A | 40 Hz to 5 kHz |
| 9660 | 100 A | 40 Hz to 5 kHz |
| 9695-03 | 100 A | 40 Hz to 5 kHz |
| 9010-50 | 10 A - 500 A*1 | 40 Hz to 1 kHz |
| 9018-50 | 10 A - 500 A*1 | 40 Hz to 3 kHz |
| 9132-50 | 20 A - 1000 A*2 | 40 Hz to 1 kHz |
| CT6500 | 500 A | 40 Hz to 1 kHz |
| 9661 | 500 A | 40 Hz to 5 kHz |
| 9669 | 1000 A | 40 Hz to 5 kHz |
| Measurement of large currents | Rated current | Frequency range |
| CT9667-01 | 500 A, 5000 A | 10 Hz to 20 kHz |
| CT9667-02 | 500 A, 5000 A | 10 Hz to 20 kHz |
| CT9667-03 | 500 A, 5000 A | 10 Hz to 20 kHz |
| Measurement of leakage current | Rated current | Frequency range |
| 9657-10 | 10 A | 40 Hz to 5 kHz |
| 9675 | 10 A | 40 Hz to 5 kHz |
| Connection options | | |
| 9219 | Converts crimped terminal to BNC terminal | |
| L9910 | Converts BNC terminal to PL14 terminal | |
| 9704 | Converts BNC terminal to banana terminal | |

*1: Can switch between ranges (10, 20, 50, 100, 200, 500 AAC)
*2: Can switch between ranges (20, 50, 100, 200, 500, 1000 AAC)

Note: Company names and product names appearing in this brochure are trademarks or registered trademarks of various companies.

HIOKI
HIOKI E. E. CORPORATION

DISTRIBUTED BY



Scan for all regional contact information