

UEI
TEST INSTRUMENTS™

DL599

Wireless TRMS Clamp Meter w/ 3-Phase & Unbalanced Motor Tests

INSTRUCTION MANUAL

ENGLISH

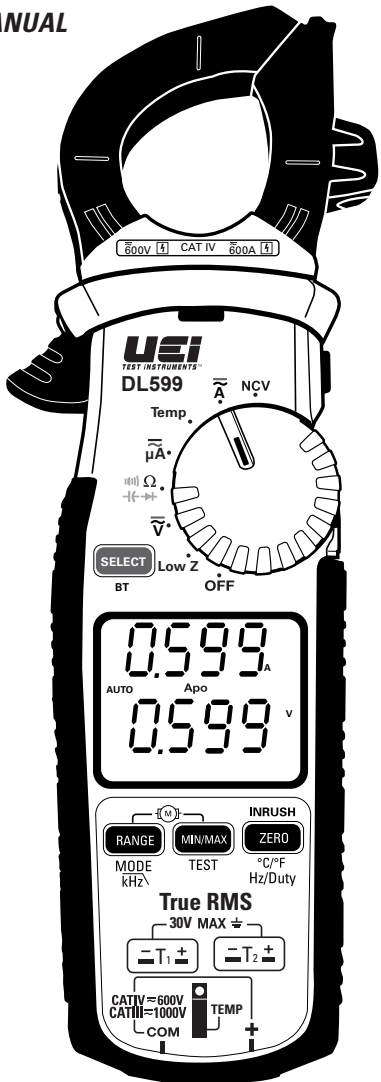

Intertek

600V

CAT IV



**RoHS
Compliant**

Available on the
App Store

ANDROID APP ON
Google play

**Test Equipment
Depot**

1-800-517-8431

5 Commonwealth Ave
Woburn, MA 01801
Phone: 781-665-1400
Toll Free: 1-800-517-8431

Table Of Contents

FUNCTIONS	3
FEATURES	3
GENERAL SPECIFICATIONS	3
IMPORTANT SAFETY WARNINGS	4
SYMBOLS	5
CATEGORY DEFINITIONS	5
OVERVIEW	6 - 7
OPERATING INSTRUCTIONS	
Non-Contact Voltage.....	7
Voltage: 1000V AC/DC.....	8
Frequency (Hz) / Duty Cycle	9
Low Z (Low Impedance)	10
Low Pass Filter.....	10
AC/DC Amps: <600A – Jaw	11
AC/DC Microamps: <2000 μ A	12
Zero DC Amps.....	12
LRA Inrush	13
Phase Rotation.....	13
Voltage Unbalance.....	14
Current Unbalance.....	14
Resistance: < 60M Ω	15
Temperature F $^{\circ}$ /C $^{\circ}$	15
Temperature Calibration	16
Diode	16
Capacitance.....	17
Continuity	17
App Overview.....	18
Test Lead Notes	19
FCC/IC	19
WARRANTY	20
BATTERY REPLACEMENT	20
DISPOSAL	20
CLEANING	20
STORAGE	20

Functions

- True RMS
- 1000V AC/DC
- 600A AC/DC
- Differential temperature
- AC/DC microamps: 2000 μ A
- Capacitance: 9999 μ F
- Frequency: 99.99kHz
- Duty cycle
- Diode test
- Audible continuity
- NCV
- LRA Inrush
- DC Zero
- Temperature range: -328° to 2462°F
- Resistance: 60M Ω
- 3-Phase Rotation Test
- Motor Unbalanced Test
- Low Z (Low Impedance)
- Low Pass Filter

Features

- Wireless capability
- Free App
- Dual display
- Auto/Manual ranging
- Worklight
- Back light
- Low battery indicator
- Data Hold
- Auto power off
- Test lead storage
- Auto calibration
- Built-in Magnet w/ hanging strap
- Visible high-voltage alert
- Input jack locks
- Min/Max/Avg
- Auto selection (voltage & amps)

General Specifications

- Operating Temperature: 32° to 122°F (0° to 50°C)
- Storage Temperature: -4° to 140°F (-20° to 60°C)
- Operating Humidity: <80%
- Pollution Degree: 2
- Display: 3 5/6 digits 6,000 count
- Back light: Yes
- Refresh Rate: 3/sec
- Over-range: "OL" is displayed
- Apo: Auto power off after 30 minutes of use.
- Dimensions: 9.45" x 2.58" x 1.67"
- Item Weight: 0.926 lb.
- CAT Rating: CATIV 600V
- Certifications: cETLus UL 61010-1: 2012, IP42, 6 ft. Drop Protection
- Battery Type: (AAA) 4
- Test Leads: Test leads w/ alligator clips & back probes
Use ATL58 test leads w/ ABP3 back probes and AAC3 alligator clips.
ATL55, ATL57 and ATLTX will not work with DL599

Important Safety Warnings

WARNING

Read entire Safety Notes section regarding potential hazards and proper instructions before using this meter. In this manual the word “**WARNING**” is used to indicate conditions or actions that may pose physical hazards to the user. The word “**CAUTION**” is used to indicate conditions or actions that may damage this instrument.

WARNING

To ensure safe operation and service of the tester, follow these instructions. Failure to observe these warnings can result in severe injury or death.

WARNING

- Before each use, verify meter operation by measuring a known voltage or current.
- Never use the meter on a circuit with voltages that exceed the category based rating of this meter.
- Do not use this meter during electrical storms or in wet weather.
- Do not use the meter or test leads if they appear damaged.
- Ensure meter leads are fully seated and keep fingers away from the metal probe contact when making measurements. Always grip the leads behind the finger guards molded into the probe. For information on test lead shields instructions on page 19.
- Do not open the meter to replace batteries while the probes are connected.
- Use caution when working with voltages above 60 DC or 25 AC RMS. Such voltages pose shock hazards.
- To avoid false readings that can lead to electrical shock, replace batteries if a low battery indicator appears.
- Unless measuring voltage or current, shut off and lockout power before measuring resistance or capacitance.
- Always adhere to national and local safety codes. Use proper personal protective equipment (PPE) to prevent shock and arc blast injury where hazardous live conductors are exposed.
- Always turn off power to a circuit or assembly under test before cutting, unsoldering or breaking the current path. Even small amounts of current can be dangerous.
- Always disconnect the live test lead before disconnecting the common test lead from the circuit.
- In the event of electrical shock, ALWAYS bring the victim to the emergency room for evaluation, regardless of victim’s apparent recovery. Electrical shock can cause unstable heart rhythms that may need medical attention.
- If any of the following occur during testing, turn off the power source to the circuit being tested: arcing, flame, smoke, extreme heat, smell of burning materials or discoloration or melting of components.















WARNING

Higher voltages and currents require greater awareness of physical safety hazards. Before connecting the test leads; turn off power to the circuit under test, set meter to the desired function and range; connect the test leads to the meter first, then connect to the circuit under test. Reapply power. If an erroneous reading is observed, disconnect power immediately and recheck all settings and connections.

WARNING

This meter is designed to provide HVAC/R technicians with the capabilities they need to diagnose and repair HVAC/R system. Observe all recommended safety procedures that include proper lockout utilization and use of personal protective equipment that includes safety glasses, gloves and flame resistant clothing.

Symbols

	AC (Alternating current)		DC (Direct current)
	Negative		AC/DC Voltage or Current
AT	Auto-ranging	OL	Overload: Range Exceeded
	Low pass Filter	BT	Wireless Connection
Apo	Auto power off Active	NCV	Non-Contact Voltage
	Low Battery	HOLD	Hold/Capture Value
MIN	Minimum measured value displayed	MAX	Maximum measured value displayed
%	Duty Cycle	Hz	Hertz/Frequency
V	Voltage	INRUSH	Inrush
A	Amperage	Ω	Ohms/Resistance
	Diode		Capacitance
nF	Nanofarad	μF	Microfarad
μA	Microamps		Continuity
$^{\circ}\text{F}$	Degrees Fahrenheit	$^{\circ}\text{C}$	Degrees Celsius
M	Mega ($\times 10^6$ or 1,000,000)	m	Milli ($\times 10^{-3}$ or 0.001)
k	Kilo ($\times 10^3$ or 1,000)	μ	Micro ($\times 10^{-6}$ or 0.000001)
	Warning or Caution		Ground
	Dangerous Levels		Double Insulation (Protection to Class II)
	Safe for disconnect from live conductors	- - - -	No reading detected
AVG	Average	EF	Electric Field
T₁	Temperature input 1	T₂	Temperature input 2
MΩ	Mega Ohms	kΩ	Kilo Ohms

Category Definitions

Measurement Category	Short-Circuit (typical) kA ^a	Location in the building installation
II	< 10	Circuits connected to mains socket outlets and similar points in the MAINS installation
III	< 50	Mains distributions parts of the building
IV	> 50	Source of the mains installation in the building

Overview

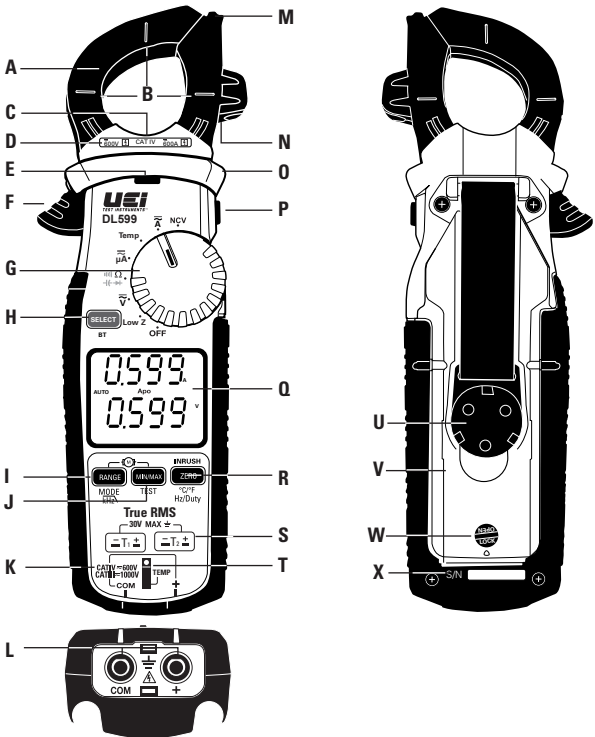

- A. Clamp:** Measure inductive AC/DC current. Opens to 1.25" (32.0mm).
- B. Conductor Alignment Marks:** Use to aid the visual alignment of a conductor when measuring inductive amperage. Greatest accuracy is achieved when the conductor inside the clamp is centered at the intersection of these marks.
- C. Worklight:** Lights clamp area in dark work environments.
- D. Category Max Indicator:** Maximum CAT Rating for clamp jaw.
- E. NCV Alert Light:** Indicates voltage when in NCV (Non Contact Voltage) mode and High Voltage alert.
- F. Clamp Lever:** Opens and closes current clamp jaw.
NOTE: *The clamp uses a high-tension spring to close the jaw. Do not allow fingers or objects to become pinched in the base as the jaws close.*
- G. Rotary Selector Dial:** Set Rotary Selector Dial desired function
- H. SELECT/Wireless (BT) Button:**
- Press to select AC or DC on Low Z setting, AC or DC on voltage setting, AC or DC on Amps setting.
 - Press to activate Ohms, Continuity, Diode, Capacitance on Ohms/Continuity/Diode/Capacitance setting; AC or DC on Low amps setting; T1, T2, T1 - T2 on temperature setting.
 - Press and Hold to activate Wireless mode.
- I. Range/Mode/ $\overline{\text{kHz}}$ Button:**
- Press to set manual range desired
 - Press and hold Range/Mode/ $\overline{\text{kHz}}$ Button to activate Low filter mode
- J. Min/Max/Test Button:**
- Press to capture Max reading
 - Press again to capture Min reading
 - Press again to capture Avg reading
 - Press and hold return to Live readings
 - Press and hold Min/Max/Test Button and Range/Mode/ $\overline{\text{kHz}}$ Button to activate Motor measurement test mode

Overview (Cont.)

- K. Category Max Indicator:** Maximum CAT Rating for input jacks.
- L. Test Lead Input Jacks:** Multifunction and Positive input jacks.
- Multifunction input port used for measuring: AC or DC volts, resistance, continuity, diode, capacitance, AC or DC μ A.
- M. Wire Separation Tab/ NCV sensor:** Use to isolate an individual wire from a bundle for testing. NCV sensor detects live voltage.
- N. Test Lead Holder**
- O. Hand Guide:** Used as a point of reference for the operator's safety.
- P. Hold/Worklight/ Back light Button:**
- Press to hold the reading on the display. Press again to return to live reading.
 - Press and hold to turn on Worklight and Back light. Press and hold again to turn off.
 - Worklight and Backlight turn off after 60 seconds.
- Q. Display:**
- High contrast dual display with backlit.
 - Amps (AC/DC) reading will always display on upper display.
- R. LRA Inrush/Zero/°C/°F/Hz/Duty Button:**
- Press to Zero the DC Amps reading.
 - Press to enter LRA Inrush mode (See page 13 for details) (must be in AC Volts mode first).
 - Press again to return to live readings.
 - Press and hold to select °F or °C in temperature setting
- S. K-Type Temperature Probe Inputs:** T1 (Left) and T2 (Right))
- T. Input Jack Lock:** Switch to use Temperature or Test lead inputs
- U. Built-in versatile magnet to use as a mount or as a strap**
- V. Battery Cover:** Easy access for replacing batteries without breaking calibration seal.
- W. Battery Compartment Latches:**
- X. Serial Number**

Non-Contact Voltage

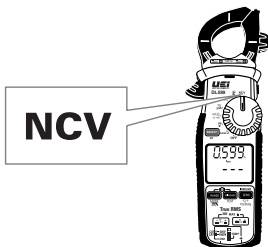

NCV Sensor in the tip.

- Rotate Rotary Selector Dial to **NCV** position move the tip of the clamp meter near voltage source.
- Non-Contact Voltage Detection is used to detect power with sensor located in the tip of the clamp head, indicates positive response with both an Audible and Visual alert.
- Do not use Non-contact voltage detector to determine if there is current on the wire. Detection operation could be affected by socket design, insulation thickness, type or other factors.
- Voltage indicator light may also light when voltage (>AC/DC 30V) is present on the meter's input jack or from an external interference such as motors, flashlights, etc.

Features:



On Voltage

Approx. 24V AC

Voltage: 1000V AC/DC

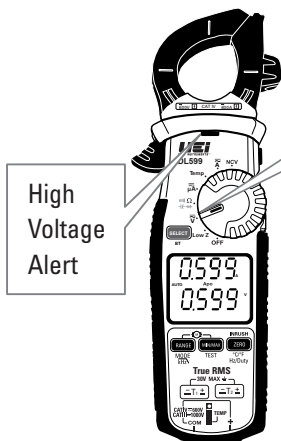

High Voltage Alert



- Default = Auto Selection
- Press SELECT x1 = \tilde{V}
- Press SELECT x2 = \bar{V}
- Press RANGE to select resolution



WARNING

- Use CATIII rated test leads or higher.
- Do not attempt to measure more than 1000V AC/1000V DC.
- Keep hands below line when measuring high current levels.
- Select AC or DC Voltage.

WARNING

- High Voltage indicator will display and audible alert will sound over 600V AC/DC
- AC/DC and High Voltage indicator will display (without audible alert) over 30V AC/DC

Features:



AC Volts

Range	Resolution	Accuracy	Overload Protection
600.0mV	0.1mV	±1.0% + 3dpts	1000V RMS
6.000V	0.001V		
60.00V	0.01V		
600.0V	0.1V		
1000V	1V		

True RMS: 45Hz to 400Hz

DC Volts

Range	Resolution	Accuracy	Overload Protection
600.0mV	0.1mV	±0.5% + 4dpts	1000V RMS
6.000V	0.001V		
60.00V	0.01V		
600.0V	0.1V		
1000V	1V	±0.8% + 5dpts	

Frequency (Hz) / Duty Cycle



- Default = Auto Selection
- Press SELECT x1 = \tilde{V}
- Press and hold ZERO x1 = Hz
- Press and hold ZERO x2 = %
- Press RANGE to select resolution



⚠ Use CAT III rated leads or higher.

Press the SELECT button to select AC voltage, press and hold the button for Frequency and Duty Cycle modes.

⚠ WARNING

Do not attempt to measure more than 1000V AC/1000V DC.

Features:



BT

Frequency Measurement - Test lead input

Range	Resolution	Accuracy	Overload Protection
99.99Hz	0.01Hz	0.1% + 3dpts	1000V RMS
999.9Hz	0.1Hz		
9.999kHz	0.001kHz		
99.99kHz	0.01kHz		

Sensitivity: 1.8Vrms

Duty Cycle - Test lead input

Range	Accuracy	Overload Protection
1.0 to 99.0%	$\pm(0.2\% \text{ per kHz} + 0.1\% + 5 \text{ dpts})$	1000V RMS

Frequency Measurement - Jaw input

Range	Resolution	Accuracy	Overload Protection
999.9Hz	0.1Hz	0.5% + 5dpts	600V RMS
1999Hz	1Hz		

Sensitivity: 5A

Low Z (Low Impedance)



Low Z

- Rotate Selector Dial to Low Z
- Default = Auto Selection
- Press SELECT x1 = \tilde{V}
- Press SELECT x2 = $\overline{\overline{V}}$

Features:



BT

Low Pass Filter



\tilde{V}

- With Selector dial in voltage position or Amps position.
- Press SELECT x1 = \tilde{V}
- Press RANGE button x1 to enter Manual Range
- Press and hold RANGE button to activate Low Pass Filter
- Press and hold RANGE button to return to Live readings
- This function is also activated in Amps.

Features:



BT

AC/DC Amps <600A Jaw

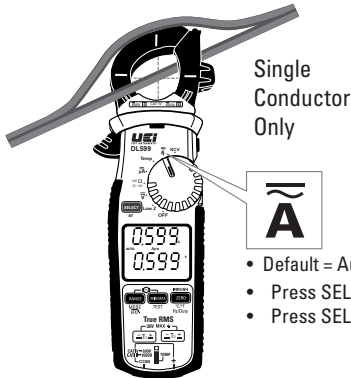

Single
Conductor
Only



- Default = Auto Selection
- Press SELECT x1 = \tilde{A}
- Press SELECT x2 = \square{A}

- Center wire in guides for best accuracy.
- Opposing currents cancel each other (use line-splitter when necessary).
- Keep hands below guard when measuring high current levels.
- Do not attempt to measure more than 600A AC / 600A DC.

Features:



BT

AC Amps Measurement - Jaw input

Range	Resolution	Accuracy	Overload Protection
60.00A	0.01A	$\pm 2.0\% + 5\text{dgts}$	600V RMS
600.0A	0.1A	$\pm 1.8\% + 5\text{dgts}$	

45Hz to 400Hz True RMS

Minimum Current for Clamp Measurement: 0.3A

DC Amps Measurement - Jaw input

Range	Resolution	Accuracy	Overload Protection
60.00A	0.01A	$\pm 2.0\% + 5\text{dgts}$	600V RMS
600.0A	0.1A	$\pm 1.8\% + 5\text{dgts}$	

Minimum Current for Clamp Measurement: 0.2A

AC/DC Microamps: <math> < 2000\mu A </math>



- Default = Auto Selection
- Press SELECT x1 = $\tilde{\mu A}$
- Press SELECT x2 = $\overline{\mu A}$
- Readings show on lower display

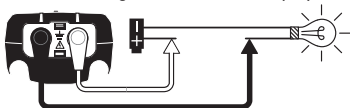

⚠ WARNING

- Do not attempt to measure more than 2000 μA .

Features:



BT

DC Microamps Measurement - Test lead input

Range	Resolution	Accuracy	Overload Protection
600.0 μA	0.1 μA	$\pm 1.2\% + 3\text{dpts}$	600V RMS
2000 μA	1 μA		

AC Microamps Measurement - Test lead input

Range	Resolution	Accuracy	Overload Protection
600.0 μA	0.1 μA	$\pm 1.5\% + 3\text{dpts}$	600V RMS
2000 μA	1 μA		

45Hz to 400Hz True RMS

Zero DC Amps



- Default = Auto Selection
- Press SELECT x1 = \tilde{A}
- Press SELECT x2 = \overline{A}
- Press ZERO = DC Amps Zero
- Press RANGE to select resolution

Select DC current.

- Press to zero any offset in Amps DC.
- Used to monitor change from present displayed value.
- Required during DC Amps measurement to establish a zero level.

⚠ WARNING

Do not use DC Zero mode at amps greater than 600A DC.

LRA Inrush

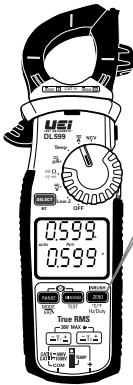

INRUSH

ZERO

- Default = Auto Selection
- Press SELECT x1 = \tilde{A}
- Press ZERO = Inrush

The UEi LRA Inrush is programmed to properly capture the starting current for compressor motors.

- Select AC Amps.
- Select the range capable of capturing the maximum value.
- Press the ZERO button – INRUSH will now be shown on the screen.
- Activate the compressor and read value on the display.
- Press the Zero button to return to live readings.

Phase Rotation

1. Set Dial to V range
2. Press and hold RANGE and MIN/MAX button to enter Phase rotation mode.
Upper display shows "3Pha"
3. Press Min/Max button to enter standby mode
Upper display blinks "L1L2"
NOTE: Each of steps 4 -5 needs to be conducted within 5 seconds. If not, the display will indicate "oVer" and the meter will finish the testing.
4. Connect test leads to any two lines (L1 – L2) of 3-Phase voltage lines.
A beep indicates stable voltage is captured, and the Upper display shows "L1L3"
5. Remove Red test lead from the voltage line
A beep and "L3" blinking on display will indicate test is ready.
6. Connect Red test lead to the third voltage line (L1 – L3)
A beep indicates test is complete
Upper display indicates phase status (Forward or Reverse).

Voltage Unbalance

1. Set the Dial to V range
2. Press and hold RANGE and MIN/MAX button to enter Phase rotation mode.
Press RANGE button to enter Voltage Unbalance test mode
Upper display indicates "V1V2"
Press Min/Max button to enter Testing standby mode.
"V1V2" will blink on display
NOTE: Steps 3 - 4 needs completed within 30 seconds. If not, the display will indicate "oVEr" and the meter will finish the testing.
3. Connect test leads to any two lines (V1 – V2) of the 3-Phase voltage lines
A beep indicates stable voltage is captured, and the Upper display shows "V1V3"
4. Remove Red Test lead from the voltage line
A beep and "V1V3" blinking on display will indicate test is ready.
Connect the Red test lead to the third voltage line (V1 – V3)
5. A beep indicates test is complete
Upper display will indicate test result (PASS or FAIL)
Lower display will indicate the percentage:
PASS % unbalance <2%
FAIL % unbalance > 2%
$$\% V \text{ unbalance} = (\text{Max deviation from Avg Voltages}/\text{Avg Voltage}) \times 100$$

Current Unbalance

1. Set the Dial to A range
2. Press and hold RANGE and MIN/MAX to enter Current Unbalance test mode
Lower Display will indicate "A"
3. Press Min/Max button to enter testing standby mode
"-A1-" will blink on display
NOTE: Each of steps 4 – 6 needs to be conducted within 30 seconds. If not, the display will indicate "oVEr" and the meter will finish the testing.
4. Clamp the jaw around current line (A1)
A beep indicates stable current is captured, and the Lower display shows "-A2-"
Remove clamp jaw from current line
A beep and "-A2-" blinking on display will indicate test is ready.
5. Clamp the jaw around current line (A2)
A beep indicates stable current is captured, and the Lower display shows "-A3-"
Remove clamp jaw from the current line
A beep and "-A3-" blinking on display will indicate test is ready.
6. Clamp the jaw around current line (A3)
A beep indicates stable current is captured
Upper display indicates test results (PASS or FAIL)
Lower display will indicate the percentage:
PASS % unbalance <10%
FAIL % unbalance > 10%
$$\% I \text{ unbalance} = (\text{Max deviation from Avg Currents}/\text{Avg Currents}) \times 100$$

Resistance: < 60MΩ



- Default = Ω
- Press RANGE to select resolution

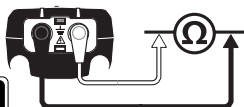

Features:



BT

⚠ WARNING

- Do not measure resistance on a live circuit.

Range	Resolution	Accuracy	Overload Protection
600.0Ω	0.1Ω	±0.8% + 3dpts	600V RMS
6.000kΩ	0.001kΩ		
60.00kΩ	0.01kΩ		
600.0kΩ	0.1kΩ		
6.000MΩ	0.001MΩ	±1.2% + 3dpts	
60.00MΩ	0.01MΩ		

Temperature F°/C°



Temp

- Default = T1
- Press SELECT x1 = T2
- Press SELECT x2 = T1 - T2
- Press and hold ZERO = F° or C°
- Readings show on lower display

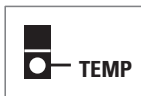

- Disconnect test lead probes from voltage source and meter.
- Move Input Jack Locks to "TEMP" setting.
- Use K-Type thermocouple temperature probes only.
- Stated accuracy does not account for thermocouple accuracy.

Features:



BT

Range	Resolution	Accuracy	Overload Protection
-328°F to 999°F (-200° to 999°C)	0.1°F (0.1°C)	±(1.0% + 3.6°F) ±(1.0% + 2.0°C)	30V RMS
1000°F to 2462°F (1000° to 1350°C)	1°F (1°C)		

Temperature Calibration

The new DL599 clamp meter offers a digital field temperature calibration procedure to make the process easier. Here are the steps.

- 1) Turn on DL599 while holding down RANGE button.
- 2) When 'FLD1' is displayed on LCD, press the ZERO button.
- 3) After entering Calibration mode, set dial to Temp position.
- 4) Confirm DL599 is in T1 mode.
- 5) After immersing T1 temperature probe in ice bath and temperature is stable, press and hold ZERO button to save.
- 6) Press SELECT button to switch to T2 mode.
- 7) After immersing the T2 temperature probe in ice bath and temperature is stable, press and hold ZERO button to save.

Diode

GOOD DIODE

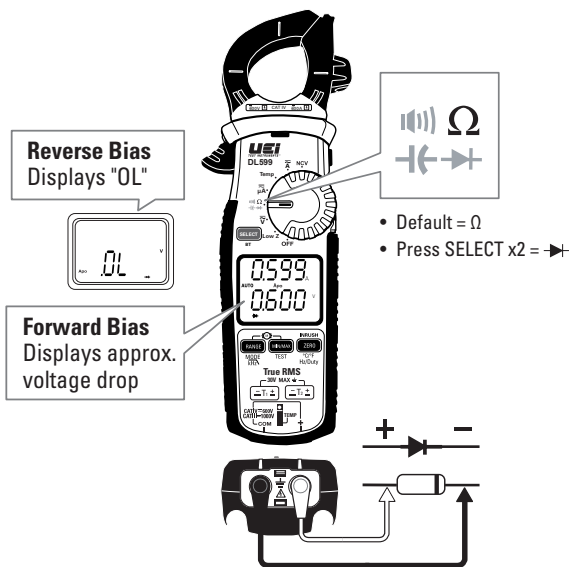

BAD DIODE



- Forward voltage drop if forward biased.
- "O.L." if reverse biased.

Features:



Diode Test

Range	Open Circuit V	Test Current	Overload Protection
3.1V	< 3.2V DC	0.25mA	600V RMS

Capacitance



- Default = Ω
- Press SELECT x3 = $\leftarrow \rightarrow$
- Press RANGE to select resolution

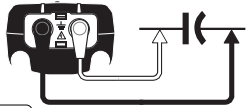

Features:



BT

Range	Resolution	Accuracy	Overload Protection
10.00nF	0.01nF	2.5% + 5dpts	600V RMS
100.0nF	0.1nF		
1.000uF	0.001uF		
10.00uF	0.01uF		
100.0uF	0.1uF	3.0% + 5dpts	600V RMS
9999uF	1uF		

⚠ WARNING To avoid damaging the meter or equipment under test, safely discharge Capacitors before measuring capacitance. Large value capacitors should be discharged through an appropriate resistance load. Use the DC Voltage function to confirm the capacitor discharge.

Continuity



- Default = Ω
- Press SELECT x1 =

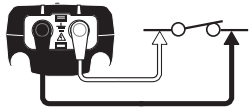

- Buzzer sounds at less than $< 40\Omega$.

⚠ WARNING

- Do not measure resistance on a live circuit.

Features:



BT

Open Circuit V $< 1.00V$	Overload Protection
Threshold Approx. $< 40\Omega$	600V RMS

App Overview

- In the App stores Google Play and the App Store, search “DL599”.
- App is compatible with iOS® 12.0 and up and Android™ 6.0 and up.
- If searching for the iPad version, you may have to filter for “iPhone” only.
- Turn on DL599 and launch the DL599 App on device.
- On DL599, Press and hold SELECT / BT. Beep confirms wireless mode activated. BT shows in display.
- On Device, Press CONNECT
- Devices should pair.

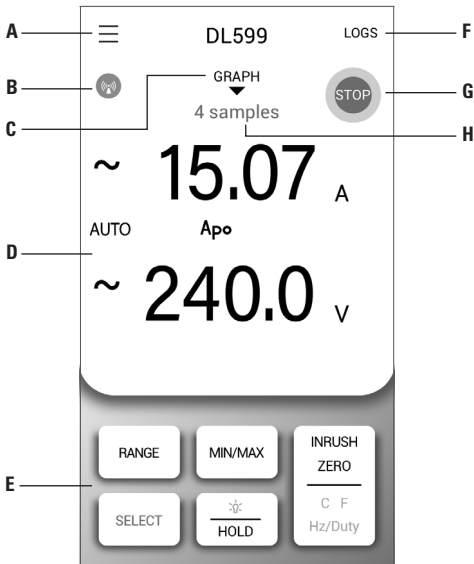

A. Menu screen

- Connection Status
- Settings screen
- Info (Manual)
- UEi App

B. BT connection indication

C. Graphing screen: View live graphing

D. Display: Reading mirrors DL599 display

E. Function Buttons: Operation mirrors DL599 function buttons

- 3-Phase Rotation, Voltage Unbalance and Current Unbalance test processes must be started from the meter, but can be completed from the App screen.

F. Log screen

- Tap to select a log file to view
 - Swipe left to edit (rename or add memo notes) or delete
- SUMMARY: Default
- In the summary screen, the red **SHOW** / **HIDE** button is for displaying a graph of the JAW measurement value, and the black **SHOW** / **HIDE** button is for displaying a graph of the Test lead Input jack measurement value.
 - Each graph can be shown or hidden by pressing the button.

SAMPLE: View individual samples from readings

EXPORT: Select a file format and send data

←: To return to previous screen

HOME: To exit to main menu

G. Record / Stop Button

H. Sample count: Only visible while logging

Test Lead Notes

Cat IV and CAT II Measurement Locations

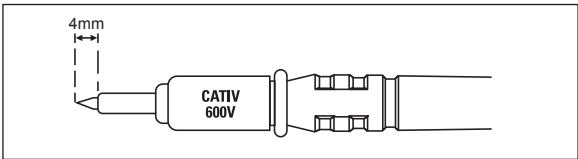

- Ensure the test lead shield is pressed firmly in place. Failure to use the CAT IV shield increases arc-flash risk.

CAT II Measurement Locations

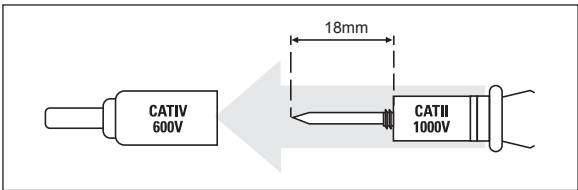

- CAT IV shields may be removed for CAT II locations. This will allow testing on recessed conductors such as standard wall outlets. Take care not to lose the shields.

⚠ WARNING: Test Lead category protections apply only to test leads and should not be confused with the meter's specific CAT rating. Observe the maximum category protection indicated on the meter the test leads are plugged into.

⚠ CAUTION: If the test leads need to be replaced, you must use a new one which should meet EN 61010-031 standard, rated CATIII 1000V or better.

NOTE: DL599 works with UEi ATL58 test leads, ABP3 back probes and AAC3 alligator clips.

ABP3 Back Probes screw-on to test leads, after removing CATIV shields from test leads. Back Probes come with covers on probe tips.

FCC INFORMATION

NOTE: This equipment has been tested and found to comply with the limits for a Class B digital device, pursuant to part 15 of the FCC rules. These limits are designed to provide reasonable protection against harmful interference in a residential installation.

This equipment generates, uses and can radiate radio frequency energy and, if not installed and used in accordance with instructions, may cause harmful interference to radio communications. However, there is no guarantee that interference will not occur in any particular installation. If this equipment does cause harmful interference to radio or television reception, which can be determined by turning the equipment on and off, the user is encouraged to try and correct the interference by one or more of the following measures:

- Reorient or relocate the receiving antenna.
- Increase the separation between the equipment and receiver.
- Connect the equipment into an outlet on a circuit different from that to which the receiver is connected.
- Consult the dealer or an experienced radio/TV technician for help.

CAUTION **⚠** Changes or modifications not expressly approved by the manufacturer responsible for compliance could void the user's authority to operate the equipment.

- (1) this device may not cause interference, and
- (2) this device must accept any interference, including interference that may cause undesired operation of the device.

Warranty

The DL599 is warranted to be free from defects in materials and workmanship for a period of 2 years from the date of purchase. If within the warranty period your instrument should become inoperative from such defects, the unit will be repaired or replaced at UEi's option. This warranty covers normal use and does not cover damage which occurs in shipment or failure which results from alteration, tampering, accident, misuse, abuse, neglect or improper maintenance. Batteries and consequential damage resulting from failed batteries are not covered by warranty.



Any implied warranties, including but not limited to implied warranties of merchantability and fitness for a particular purpose, are limited to the express warranty. UEi shall not be liable for loss of use of the instrument or other incidental or consequential damages, expenses, or economic loss, or for any claim or claims for such damage, expenses or economic loss.

Warranty only covers hardware and does not extend to software applications.

A purchase receipt or other proof of original purchase date will be required before warranty repairs will be rendered. Instruments out of warranty will be repaired (when repairable) for a service charge.

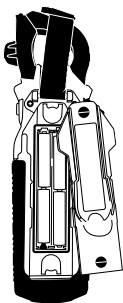
This warranty gives you specific legal rights. You may also have other rights, which vary from state to state.



- Rotate Battery Compartment Latches to open position 
- Remove battery cover
- Replace the old batteries with 4 new (AAA) batteries
- Replace the battery cover
- Rotate Battery Compartment Latches to lock 

Disposal



CAUTION: This symbol indicates that equipment and its accessories shall be subject to separate collection and correct disposal.

Cleaning

Periodically clean your meter's case using a damp cloth. DO NOT use abrasive, flammable liquids, cleaning solvents, or strong detergents as they may damage the finish, impair safety, or affect the reliability of the structural components.

Storage

Remove the batteries when instrument is not in use for a prolonged period of time. Do not expose to high temperatures or humidity. After a period of storage in extreme conditions exceeding the limits mentioned in the General Specifications section, allow the instrument to return to normal operating conditions before using it.