

Uei

DM525

TEST INSTRUMENTS™

True RMS 1000V Digital Multimeter w/Temperature

INSTRUCTION MANUAL

ENGLISH

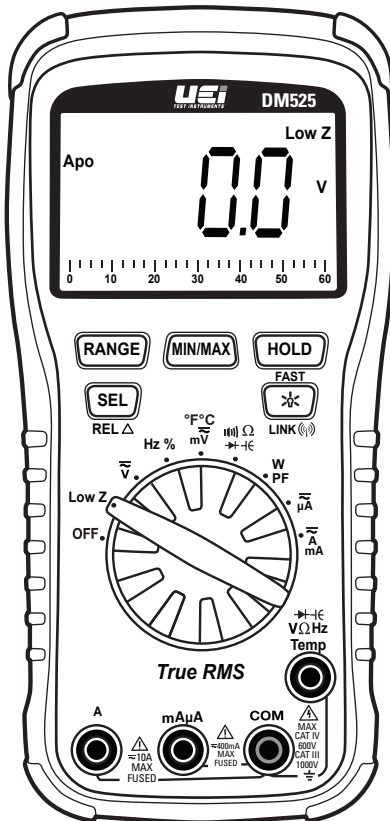

Intertek

600V
CAT IV

1000V
CAT III

TABLE OF CONTENTS

FUNCTIONS	4
FEATURES	4
GENERAL SPECIFICATIONS	4
IMPORTANT SAFETY WARNINGS	5
OVERVIEW	6 - 7
SYMBOLS	7
CATEGORY DEFINITIONS	7
OPERATING INSTRUCTIONS	
AC/DC Voltage: <1000V AC/DC	8
Resistance: <50M Ω	9
Continuity	9
Diode	10
Capacitance.....	10
AC/DC Microamps: 6000 μ A	11
AC/DC Milliamps: 400mA	11
AC/DC Amps: <10A	12
Temperature C°/F°	13
Low Z (Low Impedance) Filter	13
Frequency/Duty Cycle	14
Relative (REL Δ) Mode	14
Wireless Capability	14
Watt (Power Factor)	15
Test Lead Notes	16
Battery Replacement	16
CONNECTING AND USING APP	17-19
FCC/IC INFORMATION	19
WARRANTY	20
DISPOSAL	20
CLEANING	20
STORAGE	20

FUNCTIONS

- 1000V AC/DC
- Resistance 50M Ω
- Diode test
- Audible continuity
- 10A AC/DC
- Capacitance 9999 μ F
- Temperature -328° to 2462°F (-200° to 1350°C)
- Frequency 999.9 kHz
- Microamps
- Milliamps
- Duty cycle 99.0%
- Relative mode
- Watt (Power factor)
- Low Z

FEATURES

- True RMS
- Auto / Manual ranging
- Auto power off
- Min/Max
- Hold
- 1 ms Fast response
- Low battery indicator
- Rubber boot
- Test lead holders
- Kick stand
- High resolution backlit display
- Bargraph
- Wireless to Free App “525 DMM”
- Auto selection

GENERAL SPECIFICATIONS

- **Operating Temperature:** 32° to 122°F (0° to 50°C)
- **Storage Temperature:** -44° to 122°F (-20° to 50°C)
- **Operating Humidity:** <75% max.
- **Operating Altitude:** 6561 ft (2000m)
- **Display:** 6,000
- **Back light:** Yes
- **Over-range:** “OL” is displayed
- **Dimensions:** 7.27 x 3.5 x 2.17
- **Item Weight:** 18.8 oz
- **Calibration:** Recommended annually
- **CAT Rating:** CAT IV 600V/CAT III 1000V
- **Certifications:** cELTus UL 61010-1:2012 3rd,
CE EN 61010-1:2010 3rd, IEC61010-2-033:2012 Ed.1, EN 61326-1:2013,
FCC, RoHS Compliant, TOV protection, IP 42, 6’ Drop protection
- **Battery Type:** (AA) 4
- **Test Leads:** CAT IV Test leads
- **Accuracy:** \pm (% of reading + # of least significant digits)
- **Bar graph:** 24 segments

IMPORTANT SAFETY WARNINGS

WARNING

Read entire Safety Notes section regarding potential hazard and proper instructions before using this meter. In this manual the word “**WARNING**” is used to indicate conditions or actions that may pose physical hazards to the user. The word “**CAUTION**” is used to indicate conditions or actions that may damage this instrument.

WARNING

To ensure safe operation and service of the tester, follow these instructions. Failure to observe these warnings can result in severe injury or death.

WARNING

- Before each use, verify meter operation by measuring a known voltage or current.
- Never use the meter on a circuit with voltages that exceed the category based rating of this meter.
- Do not use this meter during electrical storms or in wet weather.
- Do not use the meter or test leads if they appear damaged.
- Ensure meter leads are fully seated and keep fingers away from the metal probe contact when making measurements. Always grip the leads behind the finger guards molded into the probe.
- Do not open the meter to replace batteries while the probes are connected.
- Use caution when working with voltages above 60 DC or 25 AC RMS. Such voltages pose shock hazards.
- To avoid false readings that can lead to electrical shock, replace batteries if a low battery indicator appears.
- Unless measuring voltage or current, shut off and lockout power before measuring resistance or capacitance.
- Always adhere to national and local safety codes. Use proper personal protective equipment (PPE) to prevent shock and arc blast injury where hazardous live conductors are exposed.
- Always turn off power to a circuit or assembly under test before cutting, unsoldering or breaking the current path. Even small amounts of current can be dangerous.
- Always disconnect the live test lead before disconnecting the common test lead from the circuit.
- In the event of electrical shock, ALWAYS bring the victim to the emergency room for evaluation, regardless of victim's apparent recovery. Electrical shock can cause unstable heart rhythms that may need medical attention.
- If any of the following occur during testing, turn off the power source to the circuit being tested: arcing, flame, smoke, extreme heat, smell of burning materials or discoloration or melting of components.

WARNING

Higher voltages and currents require greater awareness of physical safety hazards. Before connecting the test leads; turn off power to the circuit under test, set meter to the desired function and range; connect the test leads to the meter first, then connect to the circuit under test. Reapply power. If an erroneous reading is observed, disconnect power immediately and recheck all settings and connections.

WARNING

This meter is designed for trade professionals who are familiar with the hazards of their trade. Observe all recommended safety procedures that include proper lockout utilization and use of personal protective equipment that includes safety glasses, gloves and flame resistant clothing.

OVERVIEW

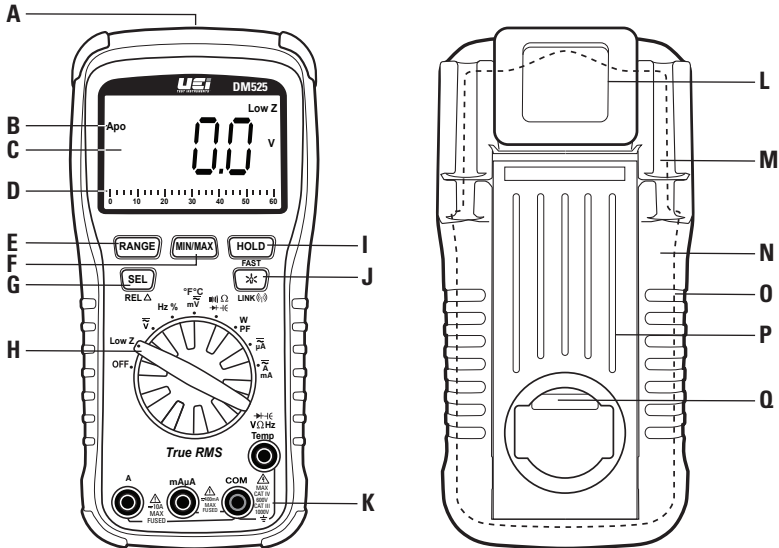

A. Worklight

B. Apo: Auto power off after 30 minutes of use. Press and hold the HOLD button while turning the meter on to disable Apo.

C. Digital Backlit Display

D. Bar graph: 24 segment, displays when in Low Z, Volts AC/DC, mV AC/DC, Ohms, Continuity, Diode, μA AC/DC, mA AC/DC and Amp AC/DC modes.

E. Range Button:

- Press to change from auto ranging to manual ranging.
- Press repeatedly to select proper range.
- Press and hold to return to auto range (AT will be displayed on screen).

F. Min/Max Button:

- Press to enter MAX/MIN mode.
- In the V, μA , mA or Amps function, either select AC/DC or change to manual ranging before pressing this button to enter MAX/MIN mode.
- Press repeatedly to alternate between Maximum and Minimum readings.
- Press and hold to return to live readings.

G. Select Button:

- Press to select AC or DC or Auto Selection in the following functions: Voltage, μA , mA, Amps,
- Press to select Hz/Duty Cycle, DCmV/ACmV/ $^{\circ}\text{F}/^{\circ}\text{C}$, Ohm/Continuity/Diode check/Capacitance or W/VA/VAr/PF.

H. Function Dial: Turns on meter and is used to select the function.

I. Hold/Fast Button:

- Press to hold the reading on the display. Press again to return to live reading.
- Press to enter Fast MAX/MIN mode in MAX/MIN mode.
- Press again to return to normal MAX/MIN mode.

J. Back Light/Worklight Button: Press to on back light. Press again to turn off. Press and hold to enable wireless capability. Back light / Worklight duration is 1 minute.

OVERVIEW (CONT.)

K. Category Max Indicator: Maximum CAT Rating for fused input jacks.

- Multifunction input port used for measuring: AC or DC volts, AC or DC mV, Temperature, Hertz, Duty Cycle, Watts, Resistance, Continuity, Diode, Capacitance, AC or DC Amps, AC or DC μA , AC or DC mA.
- Use CATIV test leads or higher

L. Recess for magnetic hanger

M. Test Lead Holders







































N. Protective Rubber Boot

O. Battery Cover (under protective rubber boot)

P. Kick Stand

Q. Serial Number (under kick stand)

SYMBOLS

	Negative		AC/DC Voltage or Current		Auto power off Active
	Overload: Range Exceeded		Hold/Capture Value		Minimum measured value displayed
	Low Battery		Voltage		Amps
	Maximum measured value displayed		Microamps		Milliamps
	Low Z		Nano Farads		Ohms/Resistance
	Microfarad		Degrees Fahrenheit		Degrees Celsius
	Diode		MilliWatt		Duty cycle
	Continuity		Ground		Fuse
	Warning or Caution		Volt-Ampere		Volt-Ampere reactive
	Bar graph		Watt		Power Factor
	Fast Min/Max		KiloOhms		Dangerous Levels
	MegaOhms		Auto Selection		High Voltage Indication
	Relative (REL)		Auto-ranging		

CATEGORY DEFINITIONS

Measurement Category	Short-Circuit (typical) kA ^a	Location in the building installation
II	< 10	Circuits connected to mains socket outlets and similar points in the MAINS installation
III	< 50	Mains distributions parts of the building
IV	> 50	Source of the mains installation in the building

AC/DC Voltage: <1000V AC/DC

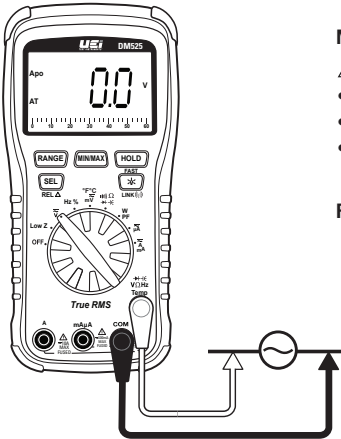

Note: Meter automatically selects AC or DC

⚠ WARNING

- Use CATIV rated Test leads or higher.
- Do not attempt to measure more than 1000V AC/DC.
- Do not exceed 25 volts AC or 60 volts DC – RMS at either the common or multifunction input ports as measured from earth ground.

Features:



AC VOLTS

Ranges	Accuracy			Resolution	Overload Protection
	45Hz to 500Hz	500Hz to 5kHz	5kHz to 20kHz		
6.000V	±(0.75% +5 dgts)	±(2.0% +8 dgts)	±(2.0% +20 dgts)	0.001V	1000V
60.00V				0.01V	
600.0V			Unspecified	0.1V	
1000V	1V				

Minimum sensitivity: 0.5V AC (auto selection mode), *Accuracy for 500Hz to 1kHz only

DC VOLTS

Ranges	Accuracy	Resolution	Overload Protection
6.000V to 1000V	±(0.2% +5 dgts)	0.001V to 1V	1000V

Minimum sensitivity: 0.5V DC (auto selection mode)

AC MILLIVOLTS

Ranges	Accuracy			Resolution	Overload Protection
	45Hz to 500Hz	500Hz to 5kHz	5kHz to 20kHz		
600.0mV	±(0.75% +5 dgts)	±(2.0% +8 dgts)	±(2.0% +20 dgts)	0.1mV	600V

Auto selection mode is not available.

DC MILLIVOLTS

Ranges	Accuracy	Resolution	Overload Protection
600.0mV	±(0.2% +5 dgts)	0.1mV	600V

Auto selection mode is not available.

Resistance: <50MΩ

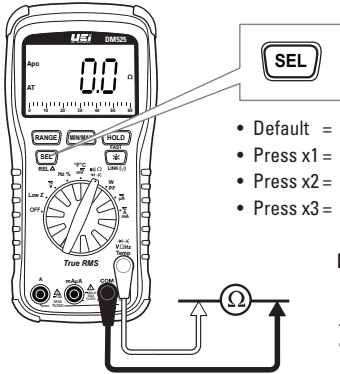

- Default = Ω
- Press x1 =
- Press x2 =
- Press x3 =

Features:



WARNING

- Do not measure resistance on a live circuit.

Ranges	Accuracy	Resolution	Overload Protection
600.0Ω	±(0.3% +5 dgts)	0.1Ω	600V
6.000kΩ		0.001kΩ	
60.00kΩ		0.01kΩ	
600.0kΩ	±(0.75% +5 dgts)	0.1kΩ	
6.000MΩ		0.001MΩ	
50.00MΩ		0.01MΩ	

Continuity

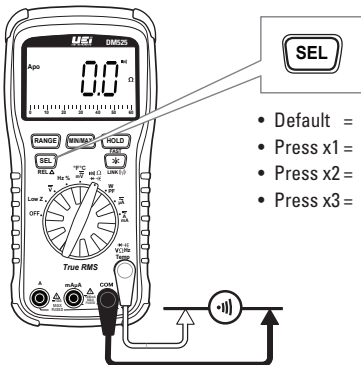

- Default =
- Press x1 =
- Press x2 =
- Press x3 =

Features:



- Buzzer sounds at less than 40Ω.

WARNING

- Do not measure resistance on a live circuit.

Open Circuit Voltage	Audible Threshold	Overload Protection
Approx.: <1.0V	Approx.: 40Ω	600V

Diode

GOOD DIODE

BAD DIODE

Forward Bias
Displays approx. voltage drop

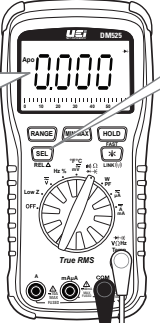

Reverse Bias
Displays "OL"



Open Diode
Displays "OL"
Both directions

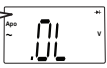

or

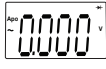

'0' Both directions (shorted)

- Forward voltage drop if forward biased.
- "OL" if reverse biased.

Features:

MIN/MAX
HOLD
SEL
⌘

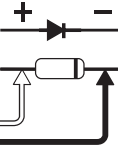

Open Circuit Voltage	Overload Protection
Approx.: <3.0V DC	600V

Capacitance

Features:

RANGE
MIN/MAX
HOLD
SEL
⌘

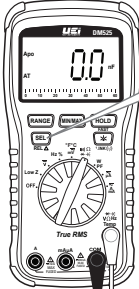

SEL

- Default = Ω
- Press x1 = μF
- Press x2 = pF
- Press x3 = nF

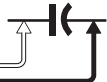

Ranges	Accuracy	Resolution	Overload Protection
10.00nF	±(2.0% +5 dgts)	0.01nF	600V
100.0nF		0.1nF	
1.000μF		0.001μF	
10.00μF	±(2.5% +5 dgts)	0.01μF	
100.0μF		0.1μF	
9999μF	±(3.0% +5 dgts)	1μF	

AC/DC Microamps: <6000 μ A

AC/DC Milliamps: 400mA

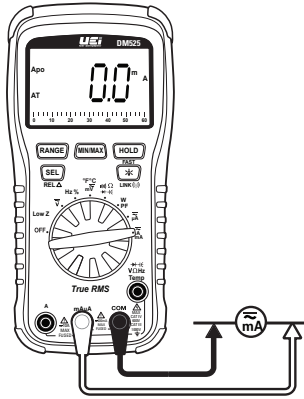
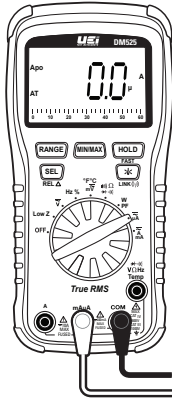

Keep hands below guard when measuring current levels.

Features:



AC μ A

Ranges	Accuracy		Burden Voltage	Resolution	Overload Protection
	45Hz to 500Hz	500Hz to 5kHz			
600.0 μ A	$\pm(1.0\% + 5 \text{ dgts})$	$\pm(1.5\% + 10 \text{ dgts})$	100 μ V/ μ A	0.1 μ A	600mA /1000V Fast Fuse
6000 μ A				1 μ A	

Minimum sensitivity: 50 μ A AC (auto selection mode only)

DC μ A

Ranges	Accuracy		Burden Voltage	Resolution	Overload Protection
	45Hz to 500Hz	500Hz to 5kHz			
600.0 μ A	$\pm(0.8\% + 5 \text{ dgts})$		100 μ V/ μ A	0.1 μ A	600mA /1000V Fast Fuse
6000 μ A				1 μ A	

Minimum sensitivity: 50 μ A DC (auto selection mode only)

ACmA

Ranges	Accuracy		Burden Voltage	Resolution	Overload Protection
	45Hz to 500Hz	500Hz to 5kHz			
60.00mA	$\pm(1.0\% + 5 \text{ dgts})$	$\pm(1.5\% + 10 \text{ dgts})$	2mV/mA	0.01mA	600mA /1000V Fast Fuse
400.0mA				0.1mA	

Minimum sensitivity: 5mA AC (auto selection mode only)

DCmA

Ranges	Accuracy		Burden Voltage	Resolution	Overload Protection
	45Hz to 500Hz	500Hz to 5kHz			
60.00mA	$\pm(0.8\% + 5 \text{ dgts})$		2mV/mA	0.01mA	600mA /1000V Fast Fuse
400.0mA				0.1mV	

Minimum sensitivity: 5mA DC (auto selection mode only)

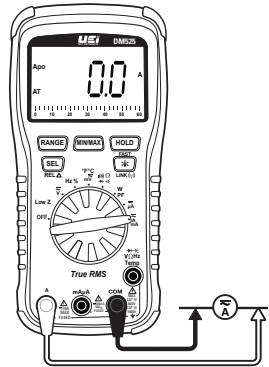

⚠ WARNING

Keep hands below guard when measuring current levels.

- Do not attempt to measure more than 10A AC.

Features:



AC A

Ranges	Accuracy		Burden Voltage	Resolution	Overload Protection
	45Hz to 500Hz	500Hz to 5kHz			
6.000A	±(1.2% +5 dgts)	±(2.0% + 10 dgts)	0.02V/A	0.001A	11A/1000V Fast fuse
10.00A				0.01A	

Minimum sensitivity: 500mA (auto selection mode only)

⚠ CAUTION: 20A overload for 30 seconds max.

DC A

Ranges	Accuracy	Burden Voltage	Resolution	Overload Protection
6.000A	±(1.0% +5 dgts)	0.02V/A	0.001A	11A/1000V Fast fuse
10.00A			0.01A	

Minimum sensitivity: 500mA (auto selection mode only)

⚠ CAUTION: 20A overload for 30 seconds max.

Temperature C°/F°

- Default = $m\bar{V}$
- Press x1 = $m\bar{V}$
- Press x2 = °F
- Press x3 = °C

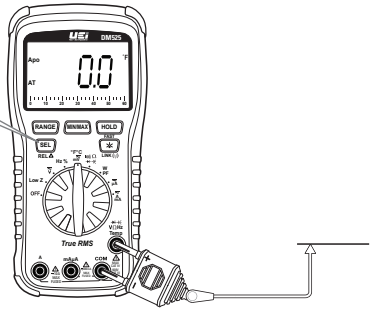

- Press Select button to change scale between Fahrenheit and Celsius.

Features:

°F

Ranges	Accuracy	Resolution	Overload Protection
-328° to 999°F	$\pm(1.5\% + 3.6^\circ\text{F})$	0.1°F	600V
1000° to 2462°F	$\pm(1.5\% + 3.0^\circ\text{F})$	1°F	

°C

Ranges	Accuracy	Resolution	Overload Protection
-200° to 999°C	$\pm(1.5\% + 2.0^\circ\text{C})$	0.1°C	600V
1000° to 1350°C	$\pm(1.5\% + 2.0^\circ\text{C})$	1°C	

Low Z (Low Impedance) Filter

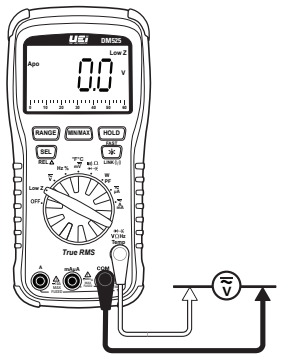

⚠ WARNING

- Use CATIV rated Test leads or higher.
- Do not attempt to measure more than 600V AC/DC

Features:

Ranges	Accuracy		Resolution
	DC, 45Hz to 500Hz	500Hz to 1Hz	
600.0V	$\pm(2.0\% + 8 \text{ dgts})$	$\pm(4.0\% + 8 \text{ dgts})$	0.1V

Frequency/Duty Cycle



- Default = Hz
- Press x1 = %

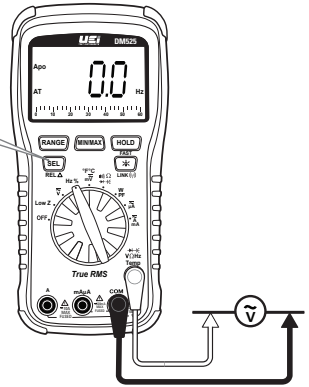

Features:



Frequency

Ranges	Accuracy	Resolution	Overload Protection
99.99Hz to 999.9kHz	$\pm(0.05\% + 3 \text{ dpts})$	0.01Hz to 0.1kHz	600V

Duty Cycle

Ranges	Accuracy	Overload Protection
1.0% to 99.0%	$\pm(0.1\% + 3 \text{ dpts} + 0.2\% \text{ per kHz})$	600V

Relative (REL Δ) Mode

The meter will store a measurement reading (the delta) and resets display to zero. It sets a relative reference point to measure against the measurement reading.

Wireless Capability

Press and hold the **Back light button**  to enable the wireless capability.

Watt (Power Factor)

Measurement of Active, Apparent and Reactive Power; W,VA, VAR

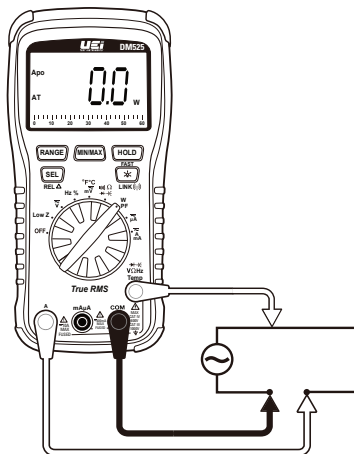

The current path be measured directly (up to 10A maximum; up to 16A briefly for a maximum of 30 seconds) or with the help of current transformers or current clamp transformers. The meter automatically selects the range which allows for the highest possible resolution of the applied quantities.

NOTE:

If the meter activates a measuring range which is too high during automatic measuring range selection, this may be due to peak value monitoring. Check the crest factor of the respective signal in Volts AC or DC or Amps AC or DC.

Significance of the Power Factor:

- ±1: no phase shifting (-0 to 0.99): capacitive; +(0 to 0.99) inductive
- First disconnect supply power from the measured circuit or the power consumer, and discharge any capacitors.
- Set the rotary function dial to W/PF.
- You can switch the display back and forth between active, reactive and apparent power with the **Select button** (including power factor).
- The extreme values can be displayed by pressing the **MIN/MAX button**.

⚠ WARNING Keep hands below guard when measuring current levels.

- Do not attempt to measure more than 10A AC.

Features:



ACTIVE POWER

Ranges	Accuracy	Resolution	Overload Protection
500mW to 5.000kW	±(1.5% +5 dgts)	1mW to 0.001kW	1000V
10.00kW	±(2.0% +8 dgts)	0.01kW	

APPARENT POWER

Ranges	Accuracy	Resolution	Overload Protection
5000mVA to 5.000kVA	±(1.2% +5 dgts)	1mVA to 0.001kVA	1000V
10.00kVA	±(1.5% +8 dgts)	0.01kVA	

REACTIVE POWER

Ranges	Accuracy	Resolution	Overload Protection
5000mVAR to 5.000kVAR	±(1.5% +5 dgts)	1mVAR to 0.001kVAR	1000V
10.00kVAR	±(2.0% +8 dgts)	0.01kVAR	

POWER FACTOR

Ranges	Accuracy	Resolution	Overload Protection
0.05 to 1.00	±(1.5% +5 dgts)	0.01	1000V

Test Lead Notes

CATV 600V Measurement Locations

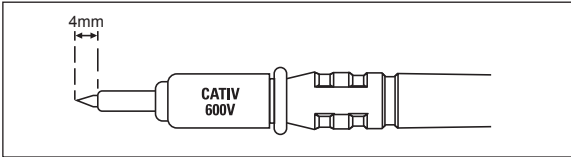

- Ensure the test lead shield is pressed firmly in place. Failure to use the CATIV shield increases arc-flash risk.

CATII 1000V Measurement Locations

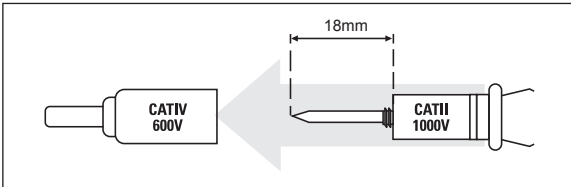

- CAT IV shields may be removed for CAT II locations. This will allow testing on recessed conductors such as standard wall outlets. Take care not to lose the shields.

⚠ WARNING: Test lead category protections apply only to test leads and should not be confused with the meter's specific CAT rating. Observe the maximum category protection indicated on the meter the test leads are plugged into.

Battery Replacement

- When the batteries are too low for safe operation, the Low Battery indicator will display.

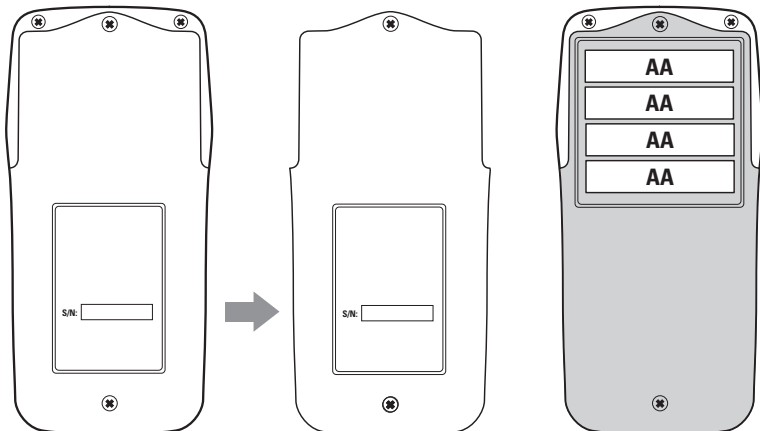

CONNECTING AND USING THE APP

- Search for App as, “525 DMM”.
- Compatible with iPhone 4X and up running iOS7 or higher, Galaxy S4, Nexus5, HTC One running Android 4.4 or higher.
- To install or search on iPad use “iPhone only” to find App.
- Press and hold “LINK” button on the meter to activate wireless “BT”.
- Open App. Meter will connect automatically.

Menu

- Press “  ” to connect, disconnect, and access settings.

CONNECT

SETTINGS

INFO

Settings

- General settings adjust button sound, vibrate and refresh rate.

Recording settings

- Continuous reading
- Number of samples
- Sampling interval

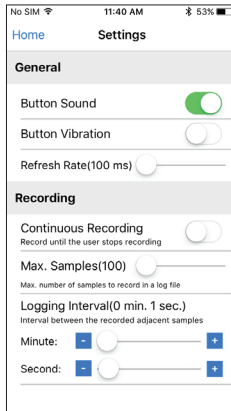

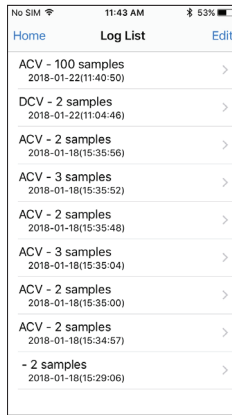
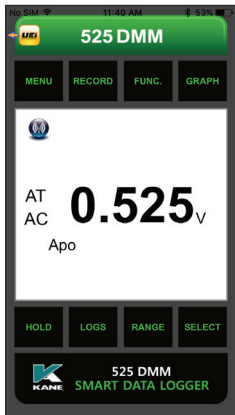

Record

- Press “  ” to start, stop.
- The number of samples will show in real time.



Logs

- Press “ **LOGS** ” to view recorded data.
- Press the entry you wish to view (yyyy-mm-dd hh:mm:ss).
- Functions are noted underneath respectively AMP-AMP (TOP-BOTTOM) Display.
- Press “  ” button for summary.
- Press “  ” button for sample data.
- Press “  ” button to export data via email in .csv, .png or .jpg format.

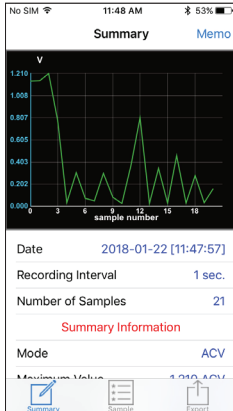

Samples

Date	Time	Value
2018-01-22	[11:47:57]	1.141 V
2018-01-22	[11:47:58]	1.145 V
2018-01-22	[11:47:59]	1.210 V
2018-01-22	[11:48:00]	0.777 V
2018-01-22	[11:48:01]	0.032 V
2018-01-22	[11:48:02]	0.307 V
2018-01-22	[11:48:03]	0.070 V
2018-01-22	[11:48:04]	0.047 V
2018-01-22	[11:48:05]	0.301 V
2018-01-22	[11:48:06]	0.082 V
2018-01-22	[11:48:07]	0.024 V
2018-01-22	[11:48:08]	0.371 V

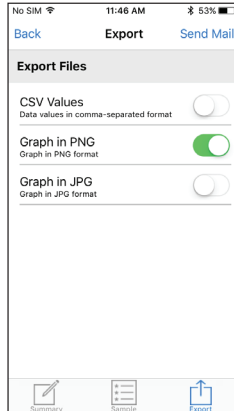

Graph

- Press “ **GRAPH** ” to view trending data in real time during measurement.

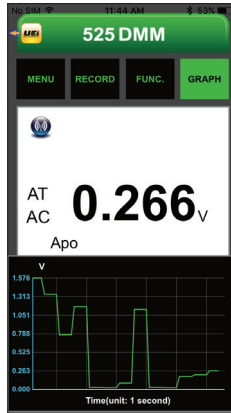

FCC/IC INFORMATION

NOTE: This device complies with Part 15 of the FCC Rules and CAN ICES-3(A). Operation is subject to the following two conditions: (1) this device may not cause harmful interference, and (2) this device must accept any interference received, including interference that may cause undesired operations.

INFORMATION TO THE USER

This equipment has been tested and found to comply with the limits for a Class B digital device, pursuant to part 15 of the FCC Rules. These limits are designed to provide reasonable protection against harmful interference in a residential installation. This equipment generates, uses and can radiate radio frequency energy and, if not installed and used in accordance with the instructions, may cause harmful interference to radio communications. However, there is no guarantee that interference will not occur in a particular installation. If this equipment does cause harmful interference to radio or television reception, which can be determined by turning the equipment off and on, the user is encouraged to try to correct the interference by one or more of the following measures:

- Reorient or relocate the receiving antenna.
- Increase the separation between the equipment and receiver.
- Connect the equipment into an outlet on a circuit different from that to which the receiver is connected.
- Consult the dealer or an experienced radio/TV technician for help.

⚠ WARNING Any changes or modifications not expressly approved by the manufacturer, could void the user's authority to operate equipment.

WARRANTY

The DM525 is warranted to be free from defects in materials and workmanship for a period of 2 years from the date of purchase. If within the warranty period your instrument should become inoperative from such defects, the unit will be repaired or replaced at UEi's option. This warranty covers normal use and does not cover damage which occurs in shipment or failure which results from alteration, tampering, accident, misuse, abuse, neglect or improper maintenance. Batteries and consequential damage resulting from failed batteries are not covered by warranty.

Any implied warranties, including but not limited to implied warranties of merchantability and fitness for a particular purpose, are limited to the express warranty. UEi shall not be liable for loss of use of the instrument or other incidental or consequential damages, expenses, or economic loss, or for any claim or claims for such damage, expenses or economic loss.

A purchase receipt or other proof of original purchase date will be required before warranty repairs will be rendered. Instruments out of warranty will be repaired (when repairable) for a service charge.

For more information on warranty and service, contact:

This warranty gives you specific legal rights. You may also have other rights, which vary from state to state.

DISPOSAL



CAUTION: This symbol indicates that equipment and its accessories shall be subject to separate collection and correct disposal.

CLEANING

Periodically clean your meters' case using a damp cloth. DO NOT use abrasive, flammable liquids, cleaning solvents, or strong detergents as they may damage the finish, impair safety, or affect the reliability of the structural components.

STORAGE

Remove the batteries when instrument is not in use for a prolonged period of time. Do not expose to high temperatures or humidity. After a period of storage in extreme conditions exceeding the limits mentioned in the General Specifications section, allow the instrument to return to normal operating conditions before using it.

Test Equipment Depot - 800.517.8431 - 99 Washington Street Melrose, MA 02176

TestEquipmentDepot.com