

# Portable Product Accessory Catalog

- Current Probes
- Batteries
- Power Supplies
- Measurement Cables
- Carry Cases
- Enclosures
- Communications Accessories
- Power Quality Books
- Software



**Test Equipment  
Depot**  
1-800-517-8431

5 Commonwealth Ave  
Woburn, MA 01801  
Phone 781-665-1400  
Toll Free 1-800-517-8431

visit us at [www.TestEquipmentDepot.com](http://www.TestEquipmentDepot.com)

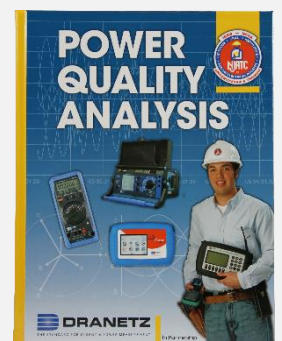

# Table of Contents

Dranetz Clamp-on AC only Current Probes _____	3
Dranetz Clamp-on AC DC Current Probes _____	4
Dranetz DranFlex Flexible AC Current Probes _____	5
Dranetz Dranflex Power Supplies _____	6
HDPQ Family HD Probe Packages _____	7
IP65 Flexible Probes _____	8
HDPQ Family Miscellaneous Accessories, HDPQ Family Batteries and Power Adapters _____	9
HDPQ Family Measurement Accessories _____	10
HDPQ Family Communications Accessories _____	11
HDPQ Family Carrying Cases and Enclosures _____	12
HDPQ Family Lockable Portable Carrying Case _____	13
HDPQ SP Miscellaneous Accessories, HDPQ SP Battery _____	14
HDPQ SP Measurement Accessories _____	15
HDPQ SP Measurement Accessories _____	16
HDPQ SP Carrying Cases and Enclosures and HDPQ SP Communications Accessories _____	17
HDPQ SP Mounting Options _____	18
Portable PX5 Family Measurement Accessories _____	19
Portable PX5 Family Single Phase Measurement Cables _____	20
Portable PX5 Family Batteries and Power Adapters _____	21
Portable PX5 Family Carrying Cases and Enclosures _____	22
Portable PX5 Family Lockable Portable Carrying Case _____	23
Portable PX5 Family Miscellaneous Accessories _____	24
Dranetz Library _____	25
DranView 7 Software _____	26

# Current Probes

Clamp-on - AC only



TR-2500B 10A-500ARMS CT



TR-2501B 100 mA to 1.2ARMS-CT



TR-2530B 20A-300ARMS CT

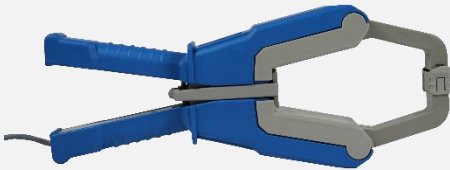

TR-2520B 100A-3000ARMS CT



TR-2510B 1A-10ARMS CT



TR-2550B 1A-100ARMS CT



TR-2540B 10A-1000ARMS CT

Model	Range	Amplitude Accuracy ±	Phase Accuracy ±	Frequency Range	Maximum Conductor Size	Rated Voltage	Connector/ Output
<b>Clamp CT's</b>							
TR-2500B	10A to 500Arms	100A to 500A	1%	1.5°	40Hz to 5KHz	50mm dia.	600V Max. Dranetz 1.5V
		10A to 100A	2%	3°			
TR-2501B	100mA to 1.2Arms	1.2A	1.5%	2°	40Hz to 5KHz	15mm dia.	600V Max. Dranetz 1.5V
		100mA	2%	3°			
TR-2510B	1A to 10Arms	5A to 10A	1.2%	1.5°	40Hz to 5KHz	15mm dia.	600V Max. Dranetz 1.5V
		1A to 5A	1.2%	1°			
TR-2520B	100A to 3000Arms	1000A to 3000A	0.5%	0.5°	40Hz to 5KHz	72mm dia.*	600V Max. Dranetz 1.5V
		300A to 1000A	0.75%	0.75°			
		100A to 300A	1.5%	1.5°			
TR-2530B	20A to 300Arms	50A to 300A	1%	0.5°	30Hz to 5KHz	54mm dia.	600V Max. Dranetz 1.5V
		20A to 50A	1.5%	0.6°			
TR-2540B	10A to 1000A	100A to 1000A	1%	0.4°	30Hz to 5KHz	54mm dia.	600V Max. Dranetz 1.5V
		10A to 100A	1.5%	0.5°			
TR-2550B	1A to 100Arms	10A to 100A	1%	2.5°	40Hz to 10KHz	15mm dia.	600V Max. Dranetz 1.5V
		1A to 10A	2%	5°			

**Note:** These are guidelines only. Many other factors will influence the stated accuracy, including but not limited to, temperature, humidity, frequency, and conductor position. Model numbers and specifications subject to change without notice.

TR probes with an "A" suffix have the same specifications as above.

The current probes shown above have a 1.5V output, Dranetz Hypertronics connector, 3 meter cable and are directly compatible with the following Dranetz products:

**Portable instruments**

Dranetz HDPQ family, PowerXplorer, PowerGuide, PowerVisa, PowerGuia, Energy Platform, PP4300, 658 with CA4300 adapter.

**Permanent instruments**

61000 with 61MAC module, Signature System 55XX. Adapters are available for use with other instrument configurations; Please contact Customer Service for details.

# AC/DC Current Probes

## PR150-SP1B 150A CT PR1500-SP7B 1500A CT

(Requires one PR9VUS AC adapter for each probe. UK, Euro plugs available.)



## PR150-SP2B 150A CT PR1500-SP8B 1500A CT

(9v battery powered only)



Model	Range		Amplitude Accuracy $\pm$	Phase Accuracy $\pm$	Frequency Range	Maximum Conductor Size	Rated Voltage	Connector/Output
PR150B	15A to 150A	15A to 150A	1%	3°	DC to 5KHz	52mm dia.	600V Max.	Dranetz 1.5V
PR1500B	150 to 1500A	150A to 1500A	1%	1°	DC to 5KHz	52mm dia.	600V Max.	Dranetz 1.5V

Note: These are guidelines only. Many other factors will influence the stated accuracy, including but not limited to, temperature, humidity, frequency, and conductor position. Model numbers and specifications subject to change without notice.

The current probes shown above have a 1.5V output, Dranetz Hypertronics connector, 2 meter cable and are directly compatible with the following Dranetz products:

### Portable instruments

Dranetz HDPQ family, PowerXplorer, PowerGuide, PowerVisa, PowerGuia, Energy Platform, PP4300, 658 with CA4300 adapter.

### Permanent instruments

61000 with 61MAC module, Signature System 55XX. Adapters are available for use with other instrument configurations; Please contact Customer Service for details.

### PR9VUA AC Adapter (for PR Probes Only)



AC power adapter for the PR150 and PR1500 AC/DC probes

## Current Probe Accessories

### TR PROBE EXTENSION CABLE



TREXT5B	5' Long	TREXT20B	20' Long
TREXT10B	10' Long	TREXT25B	25' Long
TREXT15B	15' Long	TREXT30B	30' Long

### ISO-65X-5



0-5A ISO CT Term Box (needs CA4300)

### CA4300BNCB



### TRTOREDEL



### CA4300



# Flexible Probes

AC only

## Single Phase



**DRANFLEX3000XLB 30A/300A/3000A Probe**  
**DRANFLEX6000XLB 60A/600A/6000A Probe**  
 Available in 24", 36" and 48"

## Three Phase



**DRANFLEX3003XLB 30A/300A/3000A Probe**  
**DRANFLEX6003XLB 60A/600A/6000A Probe**  
 Available in 24", 36" and 48"

Model	Range	Amplitude Accuracy ±	Phase Accuracy +/-	Frequency Range	Maximum Conductor Size	Rated Voltage	Connector/ Output
DRANFLEX3000XL DRANFLEX3003XL 24/36/48	3A to 3000A (3 Ranges)	3A to 30A	1%rdg, ±0.1A	1°	10Hz to 10KHz	1000V Max	Dranetz 1.5V
		30A to 300A	1%rdg, ±0.1A	1°			
		300A to 3000A	1%rdg, ±1A	1°			
DRANFLEX 6000XL DRANFLEX 6003XL 24/36/48	6A to 6000A 3 ranges	6A to 60 A	1%rdg, ±0.1A	1°	10Hz to 10KHz	1000V Max	Dranetz 1.5V
		60A to 600A	1%rdg, ±0.1A	1°			
		600A to 6000A	1%rdg, ±1A	1°			

Note: These are guidelines only. Many other factors will influence the stated accuracy, including but not limited to; temperature, humidity, frequency, and conductor position. Model numbers and specifications subject to change without notice.

## MicroFlex Probes

AC only-Single phase



**DRANFLEX300MHB 3A/30A/300A Probe**  
 Available in 6", 8" and 12"

Model	Range	Amplitude Accuracy ±	Phase Accuracy +/-	Frequency Range	Maximum Conductor Size	Rated Voltage	Connector/ Output
DRANFLEX300MHB6 DRANFLEX300MHB8 DRANFLEX300MHB12 6/8/12	0.3A to 300A 3 ranges	0.3A to 3A	1%rdg, ± 0.1A	1°	25Hz to 70kHz	1000V MAX	Dranetz 1.5V
		3A to 30A	1%rdg, ± 0.1A	1°			
		30A to 300A	1%rdg, ± 0.5A	1°			

Note: These are guidelines only. Many other factors will influence the stated accuracy, including but not limited to; temperature, humidity, frequency, and conductor position. Model numbers and specifications subject to change without notice.

The current probes shown above have a 1.5V output, Dranetz Hypertronics connector, 3 meter cable ( 2 meters from probe head to Integrator box, 1 meter to instrument) and are directly compatible with the following Dranetz products:

### Portable instruments

Dranetz HDPQ family, PowerXplorer, PowerGuide, PowerVisa, PowerGuia, Energy Platform, PP4300, 658 with CA4300 adapter.

### Permanent instruments

61000 with 61MAC module, Signature System 55XX. Adapters are available for use with other instrument configurations; Please contact Customer Service for details.

# DranFlex Power Supplies

( Not required for use with the Dranetz HDPQ family, when Dranflex XLB (blue) probes are used. )

## ISOFLEX-MHXL\*



Isolated 3 volt power adapter for use with an Instrument's power supply. Does **NOT** include the RR/PS/4A cable for up to 4 probes.

## ISOFLEX-MHXLU



Isolated 3 volt probe power supply. Does **NOT** include the RR/PS/4A cable for up to 4 probes.

## ISOFLEX-MHXL4P\*



Isolated 3 volt power adapter for use with an Instrument's power supply. Powers up to four probes

**ISOFLEX-MHXLU-US** - ISOFLEX-MHXLU with a US 125V cord  
**ISOFLEX-MHXLU-EU** - ISOFLEX-MHXLU with an European 250V cord  
**ISOFLEX-MHXLU-UK** - ISOFLEX-MHXLU with a UK 250V cord  
**ISOFLEX-MHXLU-AU** - ISOFLEX-MHXLU with an Australian 250V cord

## ISOFLEX-MHXLU4P



Isolated 3 volt power supply with a RR/PS/4A cable for up to four probes.  
*Not suitable for use with LPC-4300.*

## RR/PS/4A



Flex power cable for up to 4 probes.

**ISOFLEX-MHXLU4P-US** - ISOFLEX-MHXLU with a US 125V cord  
**ISOFLEX-MHXLU4P-EU** - ISOFLEX-MHXLU with an European 250V cord  
**ISOFLEX-MHXLU4P-UK** - ISOFLEX-MHXLU with a UK 250V cord  
**ISOFLEX-MHXLU4P-AU** - ISOFLEX-MHXLU with an Australian 250V cord

\*ISOFLEX-MHXL and ISOFLEX-MHXL4P Isolated power adapters are intended for use with an instruments power supply. Compatible with PX5, PX5-400, PowerGuide, PowerVisa, Energy Platform EP1, and 61STD instruments.

# HDPQ Family Probe Packages

For use with the Dranetz HDPQ family, HDPQ SP and HDPQ DN Units.



## MFLEX6PKG-HD

### 4 – DRANFLEX300MHB6 Single phase flex probe 3/30/300Amp

3A to 300Amp (3 ranges), 1.5V output, Dranetz Hypertronics connector, 2" dia. maximum conductor size, 1000V Max rated.



## FLEX3K24PKG-HD

### 1- DRANFLEX3003XLB24 Three phase flex probe 30/300/3000Amp

3A to 3000Amp (3 ranges), 1.5V output, Dranetz Hypertronics connector, 8" dia. maximum conductor size, 1000V Max rated.

### 1- DRANFLEX3000XLB24 Single phase flex probe 30/300/3000Amp

3A to 3000Amp (3 ranges), 1.5V output, Dranetz Hypertronics connector, 8" dia. maximum conductor size, 1000V Max rated.



## FLEX3K36PKG-HD

### 1- DRANFLEX3003XLB36 Three phase flex probe 30/300/3000Amp

3A to 3000Amp (3 ranges), 1.5V output, Dranetz Hypertronics connector, 11" dia. maximum conductor size, 1000V Max rated.

### 1- DRANFLEX3000XLB36 Single phase flex probe 30/300/3000Amp

3A to 3000Amp (3 ranges), 1.5V output, Dranetz Hypertronics connector, 11" dia. maximum conductor size, 1000V Max rated.



## FLEX3K48PKG-HD

### 1- DRANFLEX3003XLB36 Three phase flex probe 30/300/3000Amp

3A to 3000Amp (3 ranges), 1.5V output, Dranetz Hypertronics connector, 17" dia. maximum conductor size, 1000V Max rated.

### 1- DRANFLEX3000XLB36 Single phase flex probe 30/300/3000Amp

3A to 3000Amp (3 ranges), 1.5V output, Dranetz Hypertronics connector, 17" dia. maximum conductor size, 1000V Max rated.



## FLEX6K24PKG-HD

### 1- DRANFLEX6003XLB24 Three phase flex probe 60/600/6000Amp

6A to 6000Amp (3 ranges), 1.5V output, Dranetz Hypertronics connector, 8" dia. maximum conductor size, 1000V Max rated.

### 1- DRANFLEX6000XLB24 Single phase flex probe 60/600/6000Amp

6A to 6000Amp (3 ranges), 1.5V output, Dranetz Hypertronics connector, 8" dia. maximum conductor size, 1000V Max rated.



## FLEX6K36PKG-HD

### 1- DRANFLEX6003XLB36 Three phase flex probe 60/600/6000Amp

6A to 6000Amp (3 ranges), 1.5V output, Dranetz Hypertronics connector, 11" dia. maximum conductor size, 1000V Max rated.

### 1- DRANFLEX6000XLB36 Single phase flex probe 60/600/6000Amp

6A to 6000Amp (3 ranges), 1.5V output, Dranetz Hypertronics connector, 11" dia. maximum conductor size, 1000V Max rated.



## FLEX6K48PKG-HD

### 1- DRANFLEX6003XLB48 Three phase flex probe 60/600/6000Amp

6A to 6000Amp (3 ranges), 1.5V output, Dranetz Hypertronics connector, 17" dia. maximum conductor size, 1000V Max rated.

### 1- DRANFLEX6000XLB48 Single phase flex probe 60/600/6000Amp

6A to 6000Amp (3 ranges), 1.5V output, Dranetz Hypertronics connector, 17" dia. maximum conductor size, 1000V Max rated.

# IP65 Flexible Probes

AC only, for use with LPC-HDPQ or HPPQ-SP.

## Single Phase



## Three Phase



**DRANFLEX3000XLB-IP 30A/300A/3000A Probe**

**DRANFLEX6000XLB-IP 60A/600A/6000A Probe**

Available in 24", 36" and 48"

Model	Range	Amplitude Accuracy $\pm$	Phase Accuracy +/-	Frequency Range	Maximum Conductor Size	Rated Voltage	Connector/ Output
DRANFLEX3000XLB-IP DRANFLEX3003XLB-IP 24/36/48	3A to 3000A (3 Ranges)	3A to 30A	1%rdg, $\pm 0.1A$	1°	10Hz to 10KHz	1000V Max	Dranetz 1.5V
30A to 300A		1%rdg, $\pm 0.1A$	1°				
300A to 3000A		1%rdg, $\pm 1A$	1°				
DRANFLEX6000XLB-IP DRANFLEX6006XLB-IP 24/36/48	6A to 6000A 3 ranges	6A to 60 A	1%rdg, $\pm 0.1A$	1°	10Hz to 10KHz	1000V Max	Dranetz 1.5V
60A to 600A		1%rdg, $\pm 0.1A$	1°				
600A to 6000A		1%rdg, $\pm 1A$	1°				

Note: These are guidelines only. Many other factors will influence the stated accuracy, including but not limited to; temperature, humidity, frequency, and conductor position. Model numbers and specifications subject to change without notice.

# IP65 MicroFlex Probes

AC only-Single phase, for use with LPC-HDPQ or HDPQ-SP.



**DRANFLEX300MHB-IP 3A/30A/300A Probe**

Available in 6", 8" and 12"

Model	Range	Amplitude Accuracy $\pm$	Phase Accuracy +/-	Frequency Range	Maximum Conductor Size	Rated Voltage	Connector/ Output
DRANFLEX300MHB6-IP DRANFLEX300MHB8-IP DRANFLEX300MHB12-IP 6/8/12	0.3A to 300A 3 ranges	0.3A to 3A	1%rdg, $\pm 0.1A$	1°	25Hz to 70kHz	1000V MAX	Dranetz 1.5V
3A to 30A		1%rdg, $\pm 0.1A$	1°				
30A to 300A		1%rdg, $\pm 0.5A$	1°				

Note: These are guidelines only. Many other factors will influence the stated accuracy, including but not limited to; temperature, humidity, frequency, and conductor position. Model numbers and specifications subject to change without notice.

The current probes shown above have a 1.5V output, IP65 connector, 3 meter cable ( 2 meters from probe head to IP65 Integrator box, 1 meter to instrument) and are directly compatible with the following Dranetz products:

### Portable instruments

Dranetz HDPQ-XPLORER400-A-SP, HDPQ-XPLORER-A-SP, HDPQ-GUIDE-A-SP and HDPQ-VISA-A-SP.

### IP65 Lockable Portable Cases

LPC-HDPQ only.

**Note:** Custom ordered parts – Please contact the Factory for delivery information.



# HDPQ Family Miscellaneous Accessories

## USB-FLASH



USB flash drive (Micro)-8GB.

## MM-HDPQ Magnetic Mounting Option



Magnetic Mounting Option for HDPQ. (HDPQ unit not included)

## 118308-G1



HDPQ battery door.

## 118313-G1 Keyhole Mounting Kit



Keyhole mounting kit for HDPQ

# HDPQ Family Batteries & Power Adapters

## BP-HDPQ (Standard Accessory)



Battery for HDPQ-Xplorer400, HDPQ-Xplorer, HDPQ-Guide, and HDPQ-Visa.

## PS-HDPQ AC Power Adapter (Standard Accessory)



Instrument power supply for HDPQ-Xplorer400, HDPQ-Xplorer, HDPQ-Guide, and HDPQ-Visa.

## External Battery Charger



- XBC-HDPQ-US**
- XBC-HDPQ-EU**
- XBC-HDPQ-UK**
- XBC-HDPQ-AU**

- External battery charger XBC-HDPQ, and US 125V cord only
- External battery charger XBC-HDPQ, European 250V cord, and US 125V cord
- External battery charger XBC-HDPQ, UK 250V cord, and US 125V cord
- External battery charger XBC-HDPQ, Australian, 250V cord, and US 125V cord

# HDPQ Family Miscellaneous Accessories

## VCS-HDPQ-P Voltage Cable Set for HDPQ Plus



HDPQ Plus Voltage cable set with 4mm connectors.  
Compatible with portable and permanent systems with 4mm voltage connectors.

**Includes:**

- 8 - Six ft. (183cm) measurement cables: 4 White, 1 Red, 1 Yellow, 1 Blue, 1 Gray;
- 4 - Black alligator clips;
- 4 - White alligator clips;
- 4 - Black 25 cm stackable jumpers;
- Wire Marker kit for Current Probes, Snap-on, .218 DIA. Compatible with portable and permanent systems with 4mm voltage connectors.

## CVCS-HDPQ Color Voltage Cable Set for HDPQ (NOT for HDPQ Plus)



Color Voltage cable set with 4mm connectors.  
Compatible with portable and permanent systems with 4mm voltage connectors.

**Includes:**

- 11 - Six ft. (183cm) measurement cables:
  - 4 White (900370), 1 RED (902159-LF), 1 YELLOW (902160-LF), 1 GRAY (902161-LF), 1 BROWN (902162-LF), 1 BLUE (902163-LF), 1 ORANGE (902244-LF) and 1 GREEN (902245-LF).
- 4 - White alligator clips (901962)
- 4 - Black alligator clips (901794)
- 1 - Green alligator clip (902246-LF)
- 4 - Black 25 cm stackable jumpers (114013-G1)
- 1 - Color Ring Label Set (4 white, 4 red, 4 yellow, 4 gray, 4 brown, 4 blue, 4 orange and 4 green)

### WMI-KIT



Wire Marker kit for Current Probes, Snap-on, .218 DIA.

### WMV-KIT



Wire Marker kit for Voltage Cables, Snap-on, .138 DIA.

### WMFV-KIT



Wire Marker kit for Fuse Voltage Kit, Snap-on, .138 DIA.

### CL-KIT-HDPQ



HDPQ colored V/I channel label Kit.

### White Alligator Clip 901962

(Standard Accessory)



### Black Alligator Clip 901794

(Standard Accessory)



### Green Alligator Clip 902246-LF

(Supplied with CVCS-HDPQ)



### 114013-G1 (Standard Accessory)



- 1 - Black 25 cm stackable jumpers

### FVA-1K1 Single Fuse Voltage Adapter



In-line fuse adapter for one voltage channel, 4mm connector, 1000V MAX.  
Compatible with portable and permanent systems with 4mm voltage connectors.

### FVA-1K4



Set of 4 in-line fuse adapters, 4mm connector, 1000V MAX.  
Compatible with portable and permanent systems with 4mm voltage connectors.

# HDPQ Family Communications

## GPSMAKIT-HDPQ



HDPQ GPS receiver and *magnetic mount GPS antenna.*

## USB-MCABLE



USB male A to USB Micro B, 6 foot cable.

## ETH-CABLE



Ethernet cable, CAT5, 10 ft.

## ETHX-CABLE



Ethernet crossover cable, CAT5, 10 ft.

# HDPQ Family Carrying Cases and Enclosures

## SCC-HDPQ Soft Carry Case



Soft carry case. Storage compartments for the instrument, CT's, voltage cables, and more.

**Dimensions:**  
12" L x 18" W x 9" D  
30.5cm L x 45.72cm W x 22.86cm D

## RSC-HDPQ



Rugged shipping container with foam inserts and lid organizer. Retractable extension handle with strong polyurethane wheels.

**(Does NOT include HDPQ).**  
**Interior dimensions:**  
19.75" L x 11.00" W x 7.60" D  
50.1cm L x 27.9cm W x 19.3cm D  
FAA maximum carry on size



## ENCL-HDPQ-US

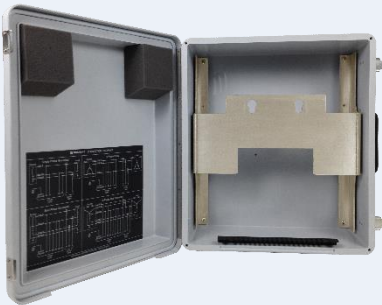

HDPQ weather resistant enclosure, includes 115 volt phase power cable.

**Dimensions:**  
16.75" L x 12" W x 8" D  
42.5cm L x 30.5cm W x 20cm D  
"Also available with a 230 volt phase power cable:  
**ENCL-HDPQ-EU**"

## ENCL-HDPQ-PPA115

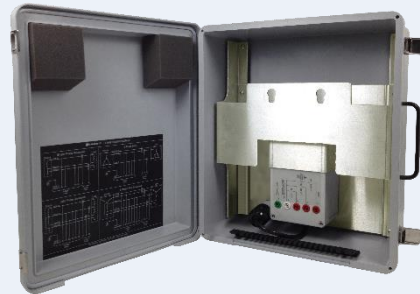

HDPQ weather resistant enclosure, includes a 115 Volt output Phase Power Adapter.

**Dimensions:**  
16.75" L x 12" W x 8" D  
42.5cm L x 30.5cm W x 20cm D  
"Also available for 230 Volt output: **ENCL-HDPQ-PPA230**"

## AMPOLEMNT14

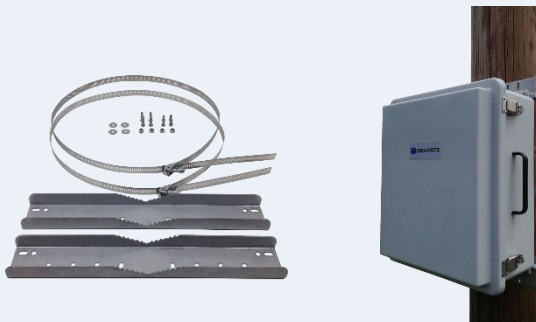

Pole mount kit for ENCL-HDPQ series enclosures, includes mounting hardware.

# HDPQ Family Lockable Portable Carrying Case

## LPC-HDPQ



Dranetz HDPQ IP65 enclosure. Includes: power cord and (4) 16" current probe adapter cables. **(Does NOT include HDPQ unit).**  
Dimensions: 18.5" L x 14.06" W x 7" D, 46.99cm L x 35.71cm W x 17.8cm D  
Models:

**LPC-HDPQ-US**

Includes: US power cord

**LPC-HDPQ-EU**

Includes: Euro power cord

**LPC-HDPQ-UK**

Includes: UK power cord

## HDPQ Lockable Portable Carrying Case Optional Accessories

### LPC-HDPQ-ETH

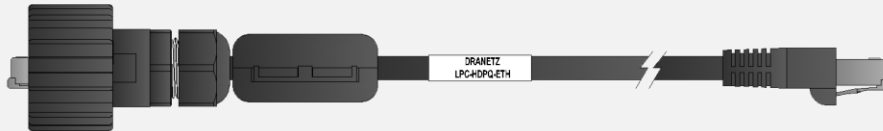

IP65 rated LPC-HDPQ Ethernet cable, 6.5' (2 meters).

### LPC-HDPQ-USB



IP65 rated LPC-HDPQ USB cable (male), 6.5' (2 meters).

### LPC-HDPQ-USBM



IP65 rated LPC-HDPQ Micro USB cable, 6.5' (2 meters).

### LPC-HDPQ-TREXT6



IP65 rated LPC-HDPQ Current adapter extension cable, 6' (1.8 meters).

# HDPQ SP Miscellaneous Accessories

## USB-FLASH



USB flash drive (Micro)-8GB.

## USBMA-OTG USB Micro Adapter



USB Micro Adapter On the Go. (Standard Accessory)

## TRTOIP65-EXT1

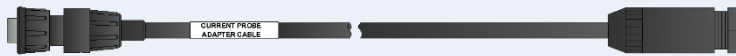

TR to IP65, 16 inch length, (Qty. 1) Current Probe Adapter Cables. (Standard Accessory)

## TRTOIP65-EXT6



TR to IP65, 6 FT length, (Qty. 1) Current Probe Adapter Cables.

## ETH-HDPQ-SP

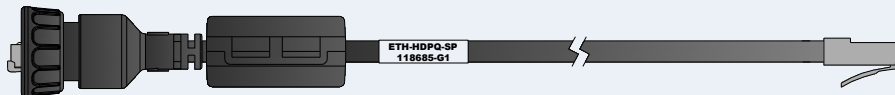

IP65 rated Ethernet cable to be used with HDPQ-SP-Xplorer400, HDPQ-SP-Xplorer, HDPQ-SP-Guide, and HDPQ-SP-Visa.

---

## HDPQ SP Battery

### BP-HDPQ-SP (Standard Accessory)

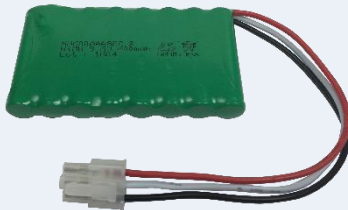

Battery for HDPQ-SP-Xplorer400, HDPQ-SP-Xplorer, HDPQ-SP-Guide, and HDPQ-SP-Visa.

# HDPQ SP Measurement Accessories

## 118707-G1

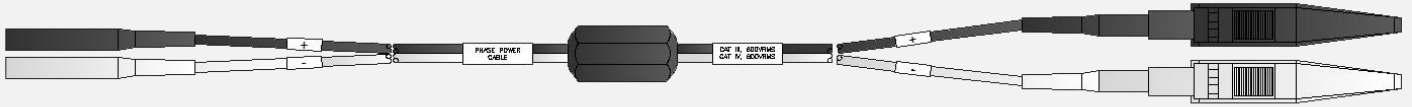

HDPQ-SP CAT IV Phase Power Cables/Clip- Use when powering from a CAT IV source. (Optional Accessory)

## 118708-G1

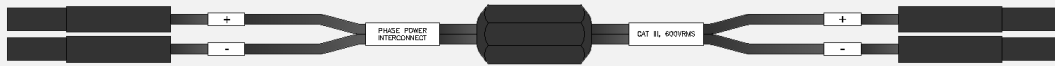

Phase Power Interconnect Cable. (Standard Accessory)

## HDPQ-SPPWR-US

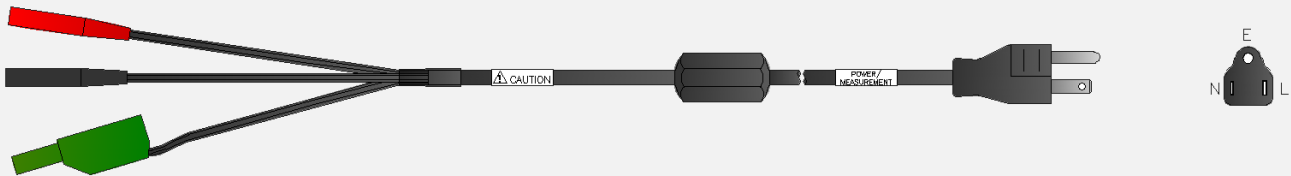

HDPQ-SP US Power Cord, for use when not powering from the phase. (Optional Accessory)

## HDPQ-SPPWR-EU

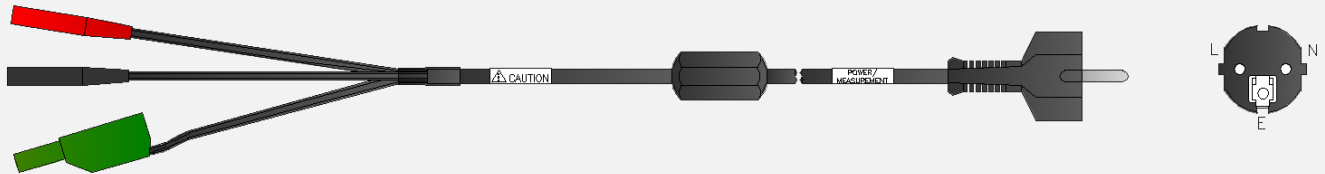

HDPQ-SP Euro Power Cord, for use when not powering from the phase. (Optional Accessory)

## HDPQ-SPPWR-UK

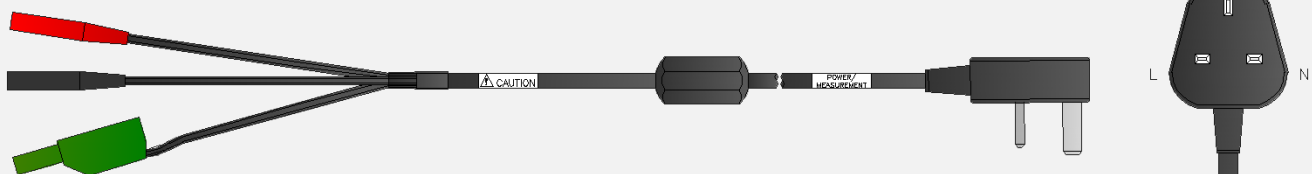

HDPQ-SP UK Power Cord, for use when not powering from the phase. (Optional Accessory)

## HDPQ-SPPWR-AU

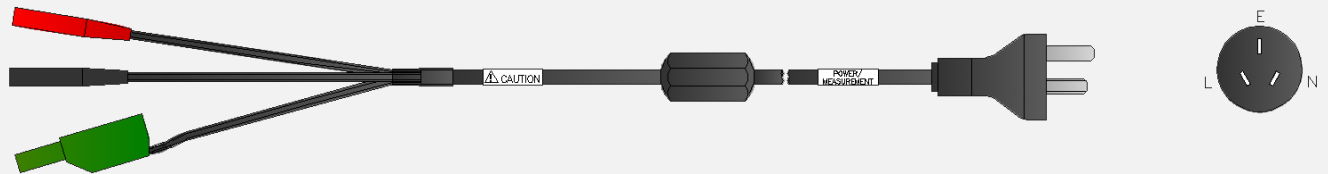

HDPQ-SP AU Power Cord, for use when not powering from the phase. (Optional Accessory)

# HDPQ SP Measurement Accessories

## VCS-HDPQ Voltage Cable Set (Standard Accessory)



Voltage cable set with 4mm connectors. Compatible with portable and permanent systems with 4mm voltage connectors.

**Includes:**

- 8 - Six ft. (183cm) measurement cables: 4 Black (901963), 4 White (900370)
- 4 - White alligator clips (901962)
- 4 - Black alligator clips (901794)
- 4 - Black 25 cm stackable jumpers (114013-G1)
- Current and Voltage Wire Marking Kit (WMI-KIT, WMV-KIT)

## CVCS-HDPQ Color Voltage Cable Set



Color Voltage cable set with 4mm connectors. Compatible with portable and permanent systems with 4mm voltage connectors.

**Includes:**

- 11 - Six ft. (183cm) measurement cables: 4 White (900370), 1 RED (902159-LF), 1 YELLOW (902160-LF), 1 GRAY (902161-LF), 1 BROWN (902162-LF), 1 BLUE (902163-LF), 1 ORANGE (902244-LF) and 1 GREEN (902245-LF).
- 4 - White alligator clips (901962)
- 4 - Black alligator clips (901794)
- 1 - Green alligator clip (902246-LF)
- 4 - Black 25 cm stackable jumpers (114013-G1)
- 1 - Color Ring Label Set (4 white, 4 red, 4 yellow, 4 gray, 4 brown, 4 blue, 4 orange and 4 green)

### WMI-KIT



Wire Marker kit for Current Probes, Snap-on, .218 DIA.

### WMV-KIT



Wire Marker kit for Voltage Cables, Snap-on, .138 DIA.

### WMFV-KIT



Wire Marker kit for Fuse Voltage Kit, Snap-on, .138 DIA.

### CL-KIT-HDPQ



HDPQ colored V/I channel label Kit.

### White Alligator Clip 901962

(Standard Accessory)



### Black Alligator Clip 901794

(Standard Accessory)



### Green Alligator Clip 902246-LF

(Supplied with CVCS-HDPQ)



### 114013-G1 (Standard Accessory)



- 1 - Black 25 cm stackable jumpers

### FVA-1K1 Single Fuse Voltage Adapter



In-line fuse adapter for one voltage channel, 4mm connector, 1000V MAX. Compatible with portable and permanent systems with 4mm voltage connectors.

### FVA-1K4



Set of 4 in-line fuse adapters, 4mm connector, 1000V MAX. Compatible with portable and permanent systems with 4mm voltage connectors.



# HDPQ SP Carrying Cases and Enclosures

## SCC-HDPQ Soft Carry Case



Soft carry case. Storage compartments for the instrument, CT's, voltage cables, and more.

**Dimensions:**

12" L x 18" W x 9" D

30.5cm L x 45.72cm W X 22.86cm D

## RSC-HDPQ-SP



Rugged shipping container with foam inserts

**(Does NOT include HDPQ SP UNIT and HDPQ SP cable pouch).**

**Dimensions:**

20.62" L x 16.82" W x 8.12" D

52.4 cm L x 42.8 cm W x 20.6 cm D

## HDPQ SP Communications

### GPSMA-HDPQ



HDPQ-SP GPS Magnetic Mount GPS Antenna.

### USB-BLUETOOTH-SP

(Standard Accessory on HDPQ Guide SP, HDPQ Xplorer SP and HDPQ Xplorer 400 SP)



USB Bluetooth 2.1 adapter, Class I

### GPS-HDPQ-SP



HDPQ-SP GPS Receiver. Must be specified at time of order. (Factory Installed Option)

### GPSMAKIT-HDPQ-SP



HDPQ-SP GPS Receiver plus a Magnetic Mount GPS Antenna. Must be specified at time of order. (Factory Installed Option)

# HDPQ SP Mounting Options

## HDPQ SP Magnetic Mount MM-HDPQ-SP

The Magnetic Mounting optional accessory **MM-HDPQ-SP** allows the Dranetz HDPQ-SP Instrument to be attached to ferromagnetic Metallic surfaces.

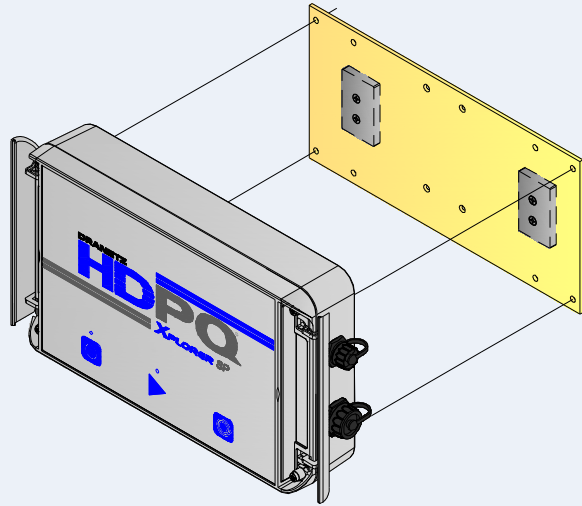

## HDPQ SP Din-Rail Mount DIN-HDPQ-SP

The DIN Rail Mounting optional accessory **DIN-HDPQ-SP** allows the Dranetz HDPQ-SP Instruments to be attached to a 35mm wide Standard DIN rail mount.

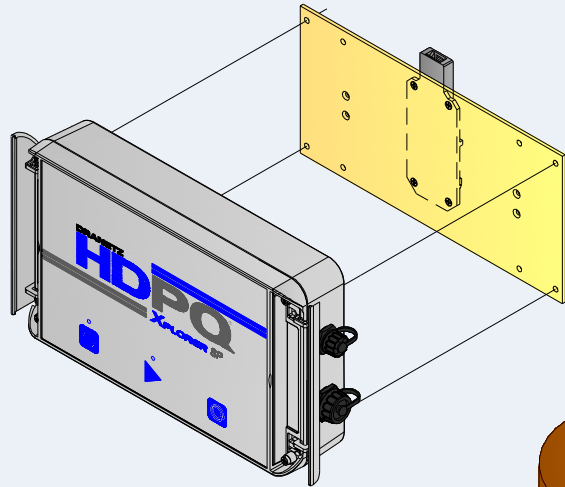

## HDPQ SP Pole Mount PM-HDPQ-SP

The Pole Mounting optional accessory **PM-HDPQ-SP** allows the Dranetz HDPQ-SP Instruments to be attached to many pole shapes and sizes up through 15" diameter.

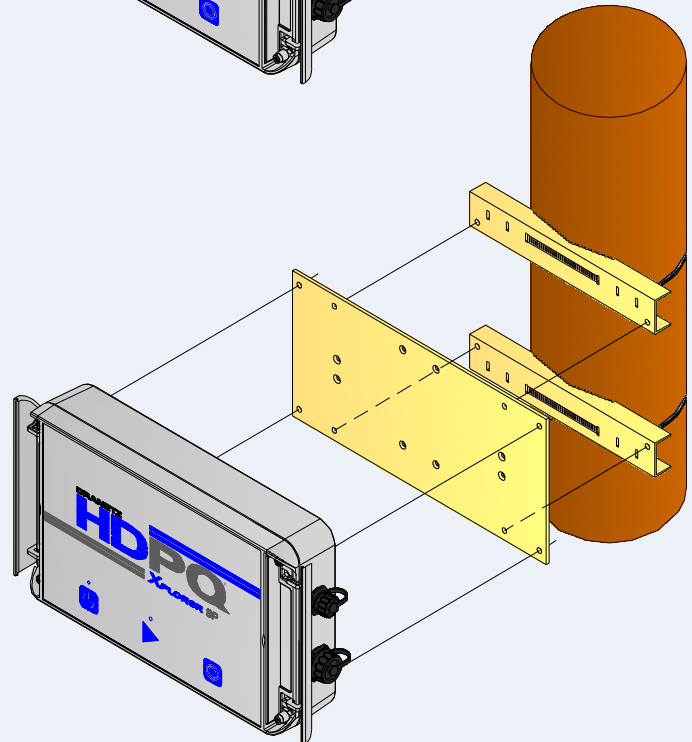

# Portable PX5 Family Measurement Accessories

## PX5 Cable Pouch (Standard Accessory) 116042-G3



Voltage cable set with 4mm connectors.  
Compatible with portable and permanent systems with 4mm voltage connectors.

**Includes:**

- 8 - Six ft. (183cm) measurement cables:
- 1 Red (900366), 1 Yellow (900367), 1 Blue (900368), 1 Gray (900369), 4 White (900370)
- 4 - Red alligator clips (900371)
- 4 - Black alligator clips (900372)
- 4 - Black 25 cm stackable jumpers (114013-G1)

## EP1 Cable Pouch (Standard Accessory) 116042-G6



Voltage cable set with 4mm connectors.  
Compatible with portable and permanent systems with 4mm voltage connectors.

**Includes:**

- 6 - Six ft. (183cm) measurement cables:
- 1 Red (900366), 1 Yellow (900367), 1 Blue (900368), 1 Gray (900369), 2 White (900370)
- 4 - Red alligator clips (900371)
- 2 - Black alligator clips (900372)
- 1 - Black 25 cm stackable jumpers (114013-G1)

## VCP-4300

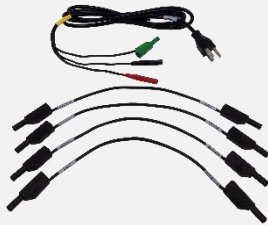

- 1 - US voltage cable with 4mm connectors to measure one single phase circuit
- 4 - Black 25 cm stackable jumpers

## 114013-G1 (Standard Accessory)



- 1 - Black 25 cm stackable jumpers

## FVA-1K1 Single Fuse Voltage Adapter



In-line fuse adapter for one voltage channel, 4mm connector, 1000V MAX.  
Compatible with portable and permanent systems with 4mm voltage connectors.



**Red Alligator Clip  
900371**  
(Standard Accessory)

**Black Alligator Clip  
900372**  
(Standard Accessory)

## 114890-G1



Voltage safety clip set

## FVA-1K4



Set of 4 in-line fuse adapters, 4mm connector, 1000V MAX.  
Compatible with portable and permanent systems with 4mm voltage connectors.

# Portable PX5 Family Single Phase Measurement Cables

114015-G1 US

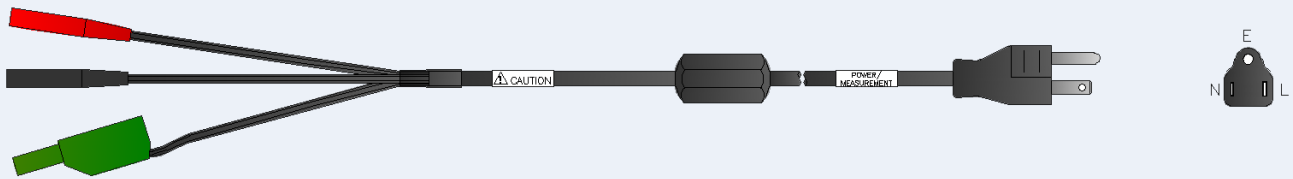

114015-G2 EURO

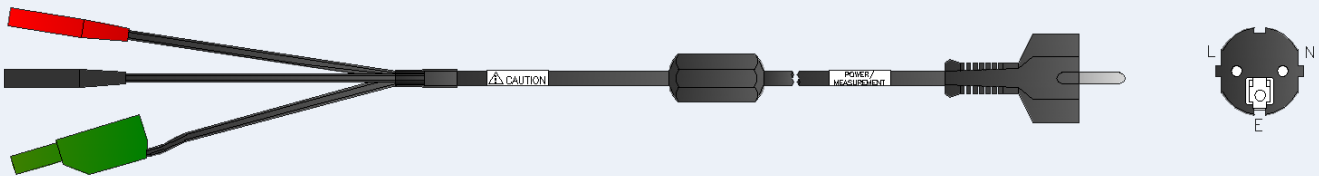

114015-G3 UK

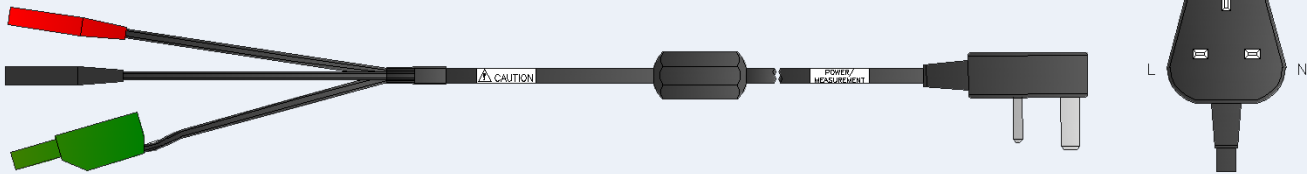

114015-G4 AUSTRALIA

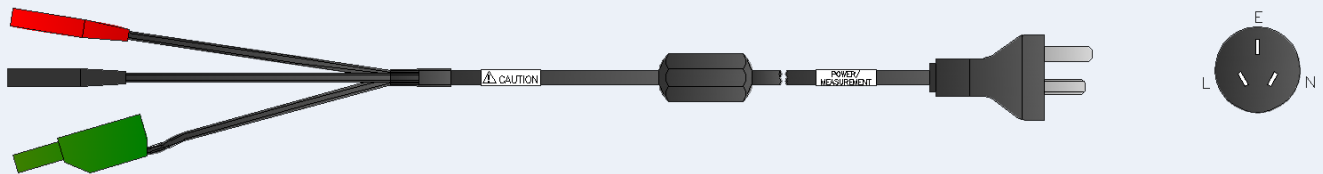

Voltage cable with 4mm connectors to measure one single phase circuit.  
Compatible with portable and permanent systems with 4mm Voltage connectors.

83003967

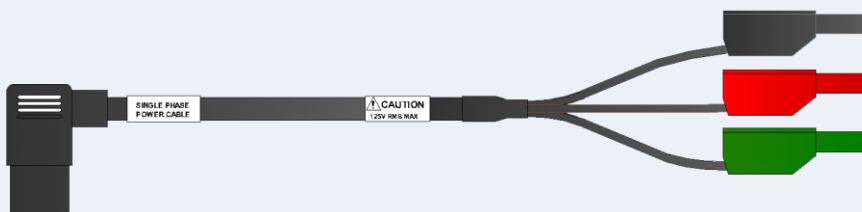

Phase Power AC cord with 4mm connectors .

# Portable PX5 Family Batteries & Power Adapters

**BP-PX5** (Standard Accessory)



Battery for PowerXplorer PX5, PowerGuide, PowerVisa, and EP1.

**PX5 AC Adapter 117029-G1**



Instrument power supply for PowerXplorer PX5, PowerGuide, PowerVisa, and EP1.

**PPA-PP1R/115 Phase Power Adapter**

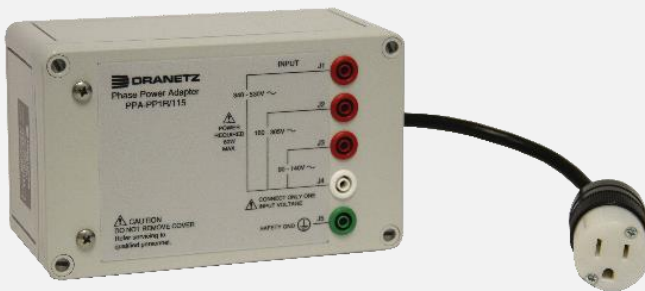

Power the instrument from the phase being measured. For circuits from 90V to 530V rms.

*Dimensions:*

4.3"L x 7.1"W x 3.6"D  
(10.9cm x 18cm x 9.1cm)

*Compatible with portable and permanent systems.*



Power the instrument from the phase being measured. For circuits from 90V to 530V rms.

*Dimensions:*

4.3"L x 7.1"W x 3.6"D  
(10.9cm x 18cm x 9.1cm)

*Compatible with portable and permanent systems.*

# Portable PX5 Family Carrying Cases and Enclosures

## SCC-4300 Soft Carry Case



Soft carry case. Storage compartments for the instrument, CT's, voltage cables, and more.

**Dimensions:**  
12" L x 18" W x 9" D  
30.5cm L x 45.72cm W x 22.86cm D

## RSC-PX5



Rugged shipping container with foam inserts  
**(Does NOT include PX5 and PX5 cable pouch).**

**Dimensions:**  
20.62" L x 16.82" W x 8.12" D  
52.4 cm L x 42.8 cm W x 20.6 cm D

## ENCL-HH



Weather resistant enclosure.

**Dimensions:**  
16.75" L x 12" W x 8" D  
42.5cm L x 30.5cm W x 20cm D

## AMPOLEMNT14



ENCL-HH Pole mount kit, includes mounting hardware.

# PX5 Family Lockable Portable Carrying Case

## LPC-PX5B



Dranetz LPC-PX5B IP65 enclosure. Includes: power cord and (4) 16" current probe adapter cables.

**(Does NOT include PX5 unit or current probes).**

Dimensions: 18.5" L x 14.06" W x 7" D, 46.99cm L x 35.71cm

W x 17.8cm D

Models:

**LPC-PX5B-US** Includes: US power cord

LPC-PX5B Compatible Instruments:

PowerXplorer PX5 400

PowerXplorer PX5

PowerGuide

PowerVisa (PowerGuia) Energy

Platform EP1

## PX5 Family Lockable Portable Carrying Case Optional Accessories

### LPC-HDPQ-TREXT6



IP65 rated LPC-PX5B Current adapter extension cable, 6' (1.8 meters) .

# Portable PX5 Family Miscellaneous Accessories

## CFDATA-DB CF Data Card



4 GB CF Data card  
*Compatible with portables only.*

## FlashReader-USB



USB CF card reader.

## 901122



PCMCIA Compact flash adapter.

## 117169-G1



PX5 dust cover door.

## 116037-G1



PX5 battery door.

---

# Portable PX5 Family Communications

## COMM-RS232



Fiber optic to RS232 adapter  
*(Not for use with the EP1)*

## COMM-OUA



Fiber optic to USB adapter  
*(Not for use with the EP1)*



## Power Quality Analysis

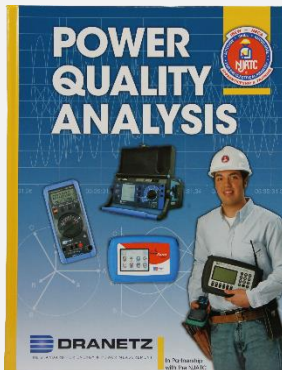

**HB114416** Written in partnership with the NJATC, 228 pages.

## The Dranetz Field Handbook for Power Quality Analysis

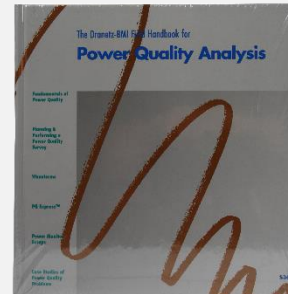

**HB114414-S** Learn the methodology for a successful power monitoring survey, as well as how to establish and maintain a power quality program, 283 pages.

## The Dranetz field handbook for electrical energy management

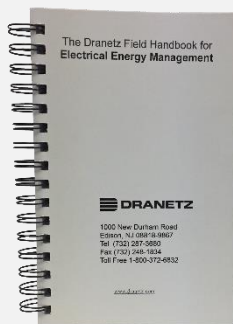

**HB114415** This handbook explores proven energy management techniques useful in a variety of applications.

## Handbook of Power Signatures

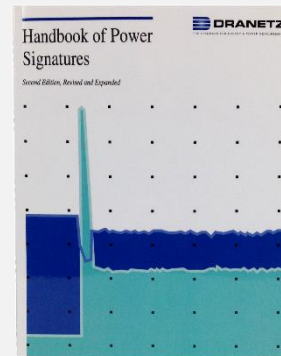

**A-010S** Learn to interpret and solve AC power problems, 290 pages.

## Handbook Set



All 4 of the above handbooks.

# Portable Equipment Software



Dran-View 7 PRO for the following instruments: all Dranetz HDPQ products, PowerVisa, PG4400, PX5, PX5-400, EP1, 4300, PP1, 658, DRANLINK PP1/658, Measuring Pad. Includes DranSet 2.

Dran-View 7 ENTERPRISE for the following instruments: all Dranetz HDPQ Products, PowerVisa, PG4400, PX5, PX5-400, EP1, 4300, PP1 and 658 and DRANLINK PP1/658, PQDIF, COMTRADE, Text Files and includes DRANLINK PP1/658, Measuring Pad. Includes PQDIF Writer. Includes DranSet 2.

Dran-View® 7		
Features and comparison of DV7 Professional with DV7 Enterprise		
Description	DV7 Professional	DV7 Enterprise
<b>User Interface</b>		
Ribbon bar - Modern appearance	●	●
Scrollable (rubber band) chart axes	●	●
View Trends, Waveforms, Magnitude/Duration and DFT	●	●
Chart area marking tool	●	●
Format templates provides unified layout	●	●
Event filtering/sorting	●	●
Drag and drop charts, axes etc.	●	●
Insert pictures and photos	●	●
Floating notations (balloons) with user defined text or data	●	●
Customizable toolbars, keyboard shortcuts and menus.	●	●
<b>File and System features</b>		
64 bit program (Optimized for 64 or 32 bit systems)	●	●
Support for large data files	●	●
Automatic updates via Internet	●	●
Compatible with most Dranetz legacy products and Dran-View 6	●	●
Reads PQDIF and COMTRADE files	●	●
Reads tabulated text files	●	●
REMOVE partial data from measurement	●	●
<b>Report Writing</b>		
Basic report writer modules	●	●
Monitoring mode specific reports	●	●
Integrated text editor (RTF-editor)	●	●
Snapshots / Bookmarks	●	●
Add selected events and trends to report	●	●
Reports against EN, IEC, G5/4, NVE standards	●	●
Multi-Site Report Writing	●	●
<b>Multi-Site Capabilities</b>		
Presentation of up to 16 simultaneous data sets	●	●
Multi-Site events filter (find events occurred at several locations)	●	●
Multi-Site time synchronization	●	●
Mathematical comparisons between data sets (difference etc.)	●	●
<b>Rescue Kit (Data repair)</b>		
Adjust timestamps	●	●
Flip current probes	●	●
Change scaling factors	●	●
Change connection type	●	●
<b>Mathematical</b>		
Calculate trends and harmonics from waveform data	●	●
Separate harmonic scaling for voltage, current and power	●	●
Enhanced DFT features - Analyze harmonic spectra in the signal	●	●
Mathematical formulas (calculate leakage current etc)	●	●
Mathematical comparisons between multiple sites	●	●



Your Sales Partner