

# FLIR Duo Pro R User Guide

---

Official Publication Date: December 2017



## Duo Pro R User Guide



**Version 1.0**

Duo Pro R User Guide, Rev. 1.0

Information on this page is subject to change without notice



The World's **Sixth Sense™**

# FLIR Duo Pro R User Guide

## Table of Contents

1 INTRODUCTION .....	4
1.1 SCOPE.....	4
1.2 REVISION HISTORY .....	4
2 RESOURCES .....	5
2.1 FLIR WEBSITE / TECH SUPPORT INFORMATION .....	5
2.2 FLIR SYSTEMS DOCUMENTS.....	5
2.3 EXTERNAL DOCUMENTS .....	5
2.4 ABBREVIATIONS / ACRONYMS .....	6
3 WHAT’S IN THE BOX .....	7
3.1 UNPACKING YOUR CAMERA .....	8
3.1.1 FLIR Duo Pro R Camera.....	8
3.1.2 Bench Cable .....	8
3.1.3 MicroSD Cards.....	9
3.1.4 Integration Cable .....	10
3.1.5 GPS Antenna.....	11
3.1.6 USB Type-C Cable.....	12
4 Connecting to the Camera .....	13
4.1 MECHANICAL INTERFACE.....	13
4.1.1 SIZE / WEIGHT.....	13
4.1.2 MOUNTING .....	13
4.2 ELECTRICAL INTERFACE.....	14
4.2.1 Bench Testing.....	14
4.2.2 COTS USB-C Cables .....	14
4.2.3 Micro HDMI.....	14
4.2.4 Accessory Port.....	15
4.3 Software Interface.....	16
4.4 Connecting to a MAVLink Compatible Flight Controller .....	16
4.5 Camera Operation.....	16
5 The FLIR UAS App .....	19
5.1 Home Screen .....	19
5.1.1 View Mode.....	20
5.1.2 Scene .....	20
5.1.2.1 Scene Presets .....	21
5.1.2.2 Region of Interest (ROI).....	21
5.1.2.3 DDE.....	22
5.1.2.4 ACE .....	22
5.1.2.5 SSO.....	22
5.1.2.6 Save Custom Scene Presets .....	22
5.1.3 IR Palette .....	22
5.1.4 MSX .....	24
5.1.5 FFC.....	24
5.1.6 Zoom .....	24
5.1.7 Measure .....	25
5.1.8 Capture .....	25
5.1.8.1 Single.....	25
5.1.8.2 Multiple .....	25

Duo Pro R User Guide, Rev. 1.0

Information on this page is subject to change without notice



The World's Sixth Sense™

# FLIR Duo Pro R User Guide

---

5.1.8.3	Video .....	25
5.1.8.4	Record.....	25
5.2	Settings .....	26
5.2.1	Capture .....	26
5.2.1.1	Capture Settings.....	26
5.2.1.2	Thermal.....	26
5.2.1.3	Radiometry .....	27
5.2.1.4	Isotherm.....	29
5.2.1.5	Video Output .....	30
5.2.2	Controller.....	31
5.2.3	Camera.....	35
6	File Formats.....	38
6.1	Visible Video Formats.....	38
6.2	Infrared: Still File Types.....	38
6.2.1	Radiometric JPG (or “RJPEG”, for short).....	38
6.2.2	TIFF.....	39
6.2.3	8-bit JPG.....	40
6.3	Infrared: Video File Types .....	40
6.3.1	14-bit (RJPEG) .....	40
6.3.2	14-bit (TIFF).....	40
6.3.3	8-bit (H264).....	41
6.4	Recommended Application Links .....	42
7	Care of FLIR Duo Pro R .....	43
Appendix A	- Software and Firmware Update.....	44
Appendix B	- MAVLink Implementation .....	46

---

## List of Figures

Figure 1.	Duo Pro R.....	8
Figure 2.	Bench Cable .....	9
Figure 3.	Integration Cable.....	10
Figure 4.	GPS Antenna Cable .....	11
Figure 5.	HDMI Port Pinout.....	15
Figure 6.	Accessory Port drawing. Dimension A is 11.25mm, Dimension B is 15.75mm .....	16
Figure 7.	LED Description .....	17
Figure 8.	Home Screen.....	19
Figure 9.	Video Mode.....	20
Figure 10.	Scene Presets.....	21
Figure 11.	Color Palettes .....	23
Figure 12.	MSX Parameter Adjustment .....	24
Figure 13.	Settings Button.....	26
Figure 14.	Radiometric Settings .....	27
Figure 15.	Spot Meter.....	28

Duo Pro R User Guide, Rev. 1.0

Information on this page is subject to change without notice



The World's Sixth Sense™

# FLIR Duo Pro R User Guide

Figure 16. Scene Meter.....	29
Figure 17: Isotherm Adjustment menu.....	30
Figure 18. Capture Settings.....	31
Figure 19. Controller Settings.....	32
Figure 20. PWM Functions.....	32
Figure 21. MAVLink Settings.....	34
Figure 22. Camera Tab.....	36
Figure 23. Firmware Upgrade.....	37
Figure 24. Using ResearchIR to convert pixel values.....	40
Figure 25. Firmware Upgrade Prompts.....	45

## List of Tables

Table 1. Duo Pro R Lens Options (FOV is Horizontal x Vertical).....	7
Table 2. Duo Pro R Accessory Port Pinout.....	15
Table 3. Thermal Image Formats Recorded on microSD Card.....	38

## 1 INTRODUCTION

### 1.1 SCOPE

Designed for professional use, FLIR’s Duo Pro R camera system is more than a thermal camera. It is a thermal measurement instrument and data recorder that adds tremendous value to sUAS operations and services. This guide shows how to get the plug-and-play FLIR Duo Pro R camera connected & configured to suit your mission needs.

### 1.2 REVISION HISTORY

Version	Date	Comments
1.0	12/08/2017	Initial Release

# FLIR Duo Pro R User Guide

---

## 2 RESOURCES

Here is a sample of some of the resources that can be found:

### 2.1 FLIR WEBSITE / TECH SUPPORT INFORMATION

In several locations throughout this document, FLIR's Duo Pro R website are referenced as a source of additional information. This website can be accessed via the following URL:

Additionally, FLIR's Technical Support department is referenced as a resource for obtaining additional help or information.

### 2.2 FLIR SYSTEMS DOCUMENTS

Document Title	
Duo Pro R Quickstart Guide	
Duo Pro R Datasheet	
FLIR Duo Pro R Technical Drawing	
FLIR Duo Pro STEP File	
UAS Radiometry Tech Note	
Interface Requirements Specification for FLIR TIFF File Format	

### 2.3 EXTERNAL DOCUMENTS

Document Title	
MAVLink Protocol	

# FLIR Duo Pro R User Guide

## 2.4 ABBREVIATIONS / ACRONYMS

Abbreviation/ Acronym	Components
AGC	Automatic Gain Control
DDE	Digital Detail Enhancement
ESD	Electrostatic Damage
FFC	Flat Field Correction
FOV	Field of View
GUI	Graphical User Interface
I/O	Input / Output
ICD	Interface Control Drawing / Document
IDD	Interface Description Drawing / Document
IMU	Internal Measurement Unit
LUT	Look-Up Table
LWIR	Long Wave Infrared
NTSC	National Television System Committee
OSD	On Screen Display
PAL	Phase Alternating Line
PWM	Pulse Width Modulation
RoHS	Reduction of Hazardous Substances
ROI	Region of Interest
TBD	To Be Determined
URL	Uniform Resource Locator

Duo Pro R User Guide, Rev. 1.0

Information on this page is subject to change without notice



The World's Sixth Sense™

# FLIR Duo Pro R User Guide

## 3 WHAT'S IN THE BOX

The FLIR Duo Pro R system comprises a visible camera imager and a thermal longwave infrared imager. The visible imager has a 4000 x 3000 pixel array with a pixel pitch of 2.8um, a 6.4mm diagonal sensor, and a 4mm f/2.8 fixed focus lens. The visible camera lens is focused at infinity, and objects closer than approximately 10 meters will appear out-of-focus. Focus position of the visible camera cannot be changed. The field of view of the visible sensor is 56° x 45° (horizontal x vertical), and the lens has a maximum distortion of 15.7% and a BFL of 10.02mm.

The LWIR core is based on FLIR's Tau2 camera core. It has a 17um pixel pitch and comes in either a 336x256 or 640x512 pixel array. Lens options and their corresponding fields of view are listed in Table 1.

640 x 512	336 x 256
13 mm: 45° x 37°	9 mm: 35° x 27°
19 mm: 32° x 26°	13 mm: 25° x 19°
25 mm: 25° x 20°	19 mm: 17° x 13°

**Table 1. Duo Pro R Lens Options (FOV is Horizontal x Vertical)**

Please note: disassembling the camera can cause permanent damage and will void the warranty. Operating the camera outside of the specified input voltage range or the specified operating temperature range can cause permanent damage. The camera back is not sealed. Avoid exposure to dust and moisture.

# FLIR Duo Pro R User Guide

## 3.1 UNPACKING YOUR CAMERA

FLIR Duo Pro R includes the following components:

### 3.1.1 FLIR Duo Pro R Camera

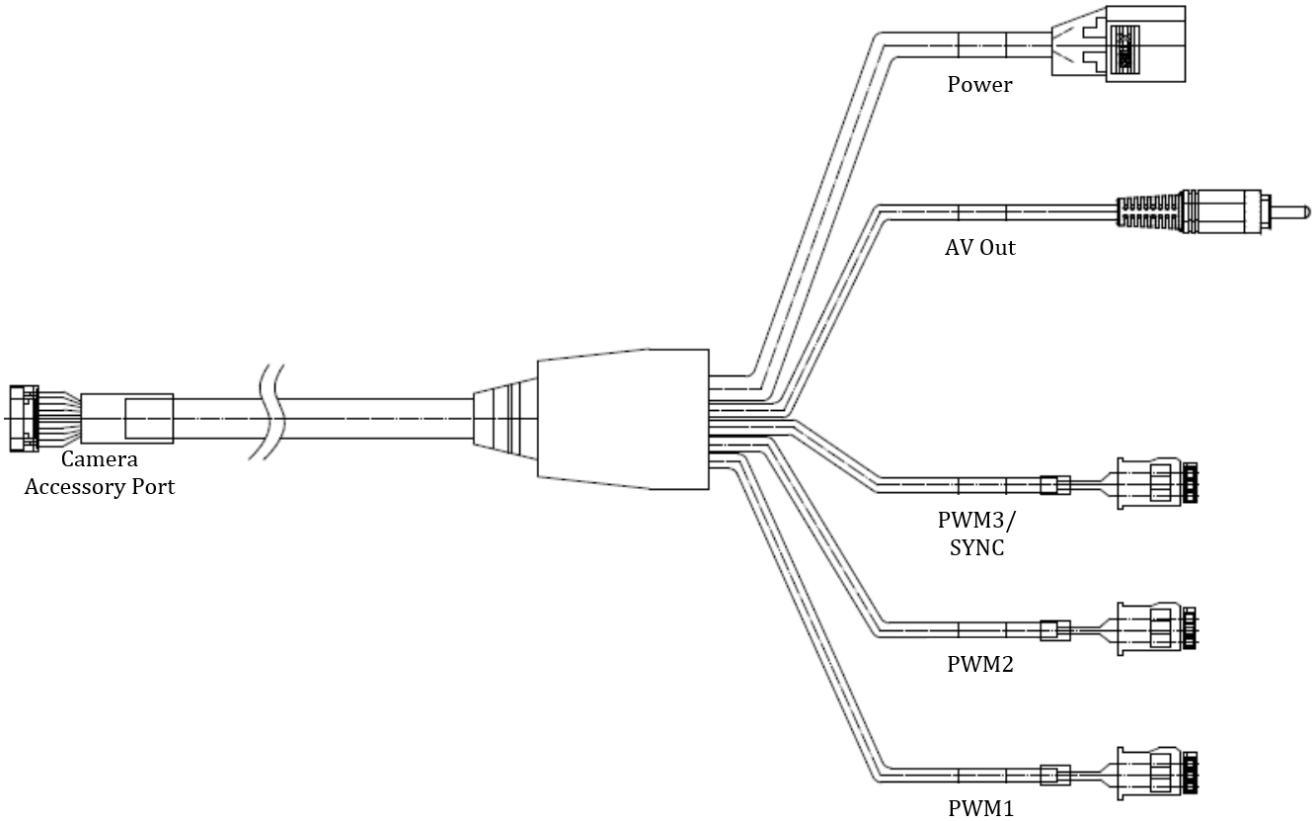

Figure 1. Duo Pro R

### 3.1.2 Bench Cable

The Bench Cable connects to the Duo Pro R via the 10-pin accessory port, and is designed for benchtop testing prior to installing the camera on an airframe. The cable comprises an XT60 connector for power, an analog video RCA connector, and three servo-style connectors for PWM signals.





**Figure 2. Bench Cable**

### 3.1.3 microSD Cards

The microSD card slots are for storing images and/or video, and for upgrading camera firmware. Maximum capacity is 64GB. A Class 10 or greater card should be used to achieve full camera performance. RAW Thermal video files (14-bit (RJPG) and 14-bit (TIFF) files) are recorded to SD Card 1. All other data are recorded on SD Card 2. See Section 6 for more details on file formats.

# FLIR Duo Pro R User Guide

## 3.1.4 Integration Cable

The Integration Cable is for connecting the FLIR Duo Pro R to a MAVLink-compatible autopilot and/or standard R/C PWM outputs. **The MAVLink interface operates at a default data rate of 57.6 kbps.** See Table 2 for pin definitions and Section 5.2.2 **Error! Reference source not found.** for PWM signal profile.

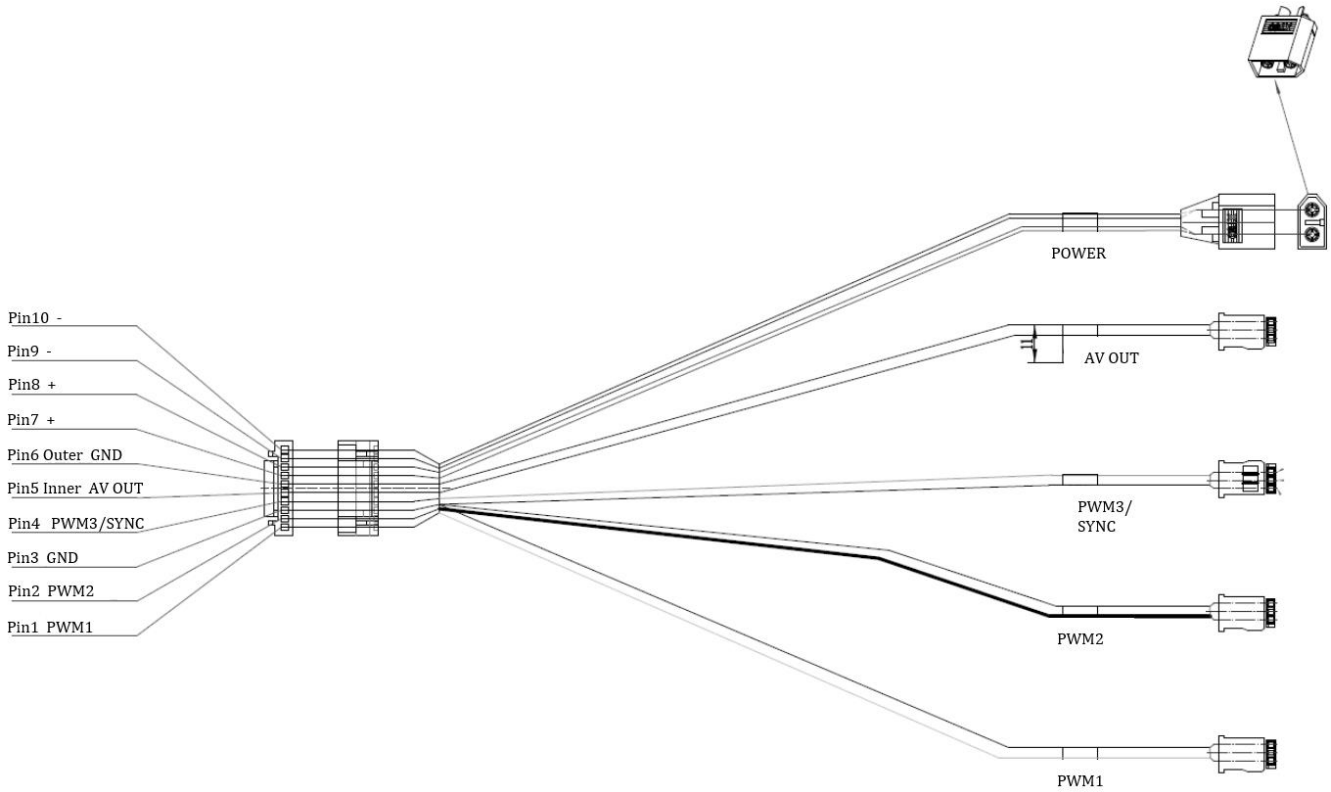

Figure 3. Integration Cable

# FLIR Duo Pro R User Guide

---

## 3.1.5 GPS Antenna

The Duo Pro R includes an internal IMU that provides position information to the camera for geolocating the image data. An appropriate antenna must be attached and mounted with a clear view of the sky for proper operation.

The antenna included with the Duo Pro R is a Taoglas AA.162.301111. There is also a small square of double-sided adhesive included with the Duo Pro R, which can be used to attach the antenna body to your airframe.

Note: the antenna has a small magnet inserted in the base for mounting. FLIR recommends removing this magnet and using the included double-sided adhesive in order to minimize magnetic field interference during airframe operation.



Figure 4. GPS Antenna Cable

# FLIR Duo Pro R User Guide

---

## 3.1.6 USB Type-C Cable

The Duo Pro R includes a Type-C to Type-A USB cable, which can be used to transfer files from the SD cards inserted in the camera to a computer.

NOTE: Connecting the Duo Pro R to a computer does NOT provide sufficient power for the camera to function correctly. The Duo Pro R must be powered from an alternate source via the 10-pin connector in order to transfer files to a computer. Most computer USB ports are not capable of supplying enough power to power the Duo Pro R, and the camera will enter a constant reboot cycle until additional power is provided through the accessory port.

# FLIR Duo Pro R User Guide

---

## 4 Connecting to the Camera

This section describes installation of necessary software, physical camera connections, and software connection to the camera.

### 4.1 MECHANICAL INTERFACE

#### 4.1.1 SIZE / WEIGHT

The overall size of the Duo Pro R is 69mm (h) x 87mm (w) x 82mm (d) (2.72 x 3.43 x 3.23 inches), including the lens but excluding cables. Weight is between 325 and 375 grams, depending on lens configuration. These mechanical specs do not take into consideration any additional mounting hardware or cabling. For additional details, please see the Duo Pro R Technical Drawing referenced in Section 2.2.

#### 4.1.2 MOUNTING

The Duo Pro R camera provides two standard tripod mounting bolt holes on the bottom of the camera. Either or both threaded inserts can be used to install ¼"-20 mounting hardware. Use of a retaining compound such as VIBRA-TITE VC-3 is recommended.

*Note: Do not exceed 5mm (0.2 in) maximum depth as internal damage could occur and warranty will be void. Spacers are recommended for longer tripod mount hardware.*

# FLIR Duo Pro R User Guide

---

## 4.2 ELECTRICAL INTERFACE

### 4.2.1 Bench Testing

For initial bench testing, connect the 10-pin Accessory Port connector on the Bench Cable (see Section 3.1.2) to the Accessory Port on the Duo Pro R camera. Connect the RCA plug on the Bench Cable to an analog video monitor, or use the microHDMI video feed with a compatible monitor.

### 4.2.2 COTS USB-C Cables

FLIR Duo Pro R is USB 3.0 compliant and is compatible with many commercial off-the-shelf (COTS) USB-C cables that are used to provide power to commonly mounted on small unmanned aerial systems (sUAS). Please refer to the Duo Pro R IDD for electrical interface guidelines and USB connector pinout.

Simply plug the USB cable into the USB-C port on the FLIR Duo Pro R, connect power to an appropriate regulated power supply (the Duo Pro R may not function properly if powered solely by a USB port on a computer), and HDMI or analog video to a downlink, if desired. Approximate operating current of the Duo Pro R camera is 2.3 A at 5.2Vdc.

*Note: FLIR Duo Pro R has over-voltage and reverse polarity protection on power pins. However, exceeding the wide voltage specification (5-26 Vdc) will damage the camera and void the warranty. Applying reverse polarity should not damage the unit, but it will prevent the camera from powering on.*

As the Duo Pro R requires greater than 500mA at 5VDC, it may not function properly if powered by a single USB 2.0 port on your computer.

### 4.2.3 Micro HDMI

The Duo Pro R comes equipped with a 19-pin “Type D” micro HDMI connector. The Duo Pro R electronics takes the IR and visible analog video (NTSC or PAL) outputs and upscales them to 720p60, 1080p30 or 1080p60 video streams.

# FLIR Duo Pro R User Guide

PIN	SIGNAL ASSIGNMENT
1	Hot Plug Detect
2	Utility
3	TMDS Data2+
4	TMDS Data2 Shield
5	TMDS Data2-
6	TMDS Data1+
7	TMDS Data1 Shield
8	TMDS Data1-
9	TMDS Data0+
10	TMDS Data0 Shield
11	TMDS Data0-
12	TMDS Clock+
13	TMDS Clock Shield
14	TMDS Clock-
15	CEC
16	DDC/CEC Ground
17	SCL
18	SDA
19	+5V Power

CONNECTION	SIGNALS
FIRST MAKE	TYPE D CONNECTOR
SECOND MAKE	CONNECTOR SHELL
THIRD MAKE	PINS 1 - 18
	PIN 19 (+5V POWER)

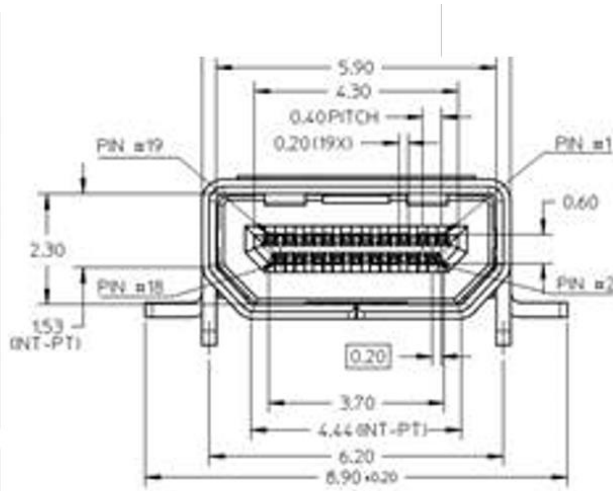

Figure 5. HDMI Port Pinout

## 4.2.4 Accessory Port

The accessory port provides access to the majority of functions of the Duo Pro R. See Table 2 for detailed information on each function.

<a href="#">DF13-7S-1.25C</a>	Signal	Wire Color	Length	Construction
Pin 1	PWM_1	GRN	750mm (30")	30AWG Twisted Pair
Pin 2	PWM_2	WHT		30 AWG Twisted Pair
Pin 3	GND	BLK		
Pin 4	PWM_3 / Sync	ORG		30AWG Twisted Pair
Pin 5	Analog Video Out	BLU		28AWG CoAxial
Pin 6	Analog Video GND	GREY		
Pin 7	Power (+)	RED		28 AWG
Pin 8	Power (+)	RED		28 AWG
Pin 9	Power (-)	BLK		28 AWG
Pin 10	Power (-)	BLK		28 AWG

Table 2. Duo Pro R Accessory Port Pinout

Note: All cable plug part numbers are Hirose

# FLIR Duo Pro R User Guide

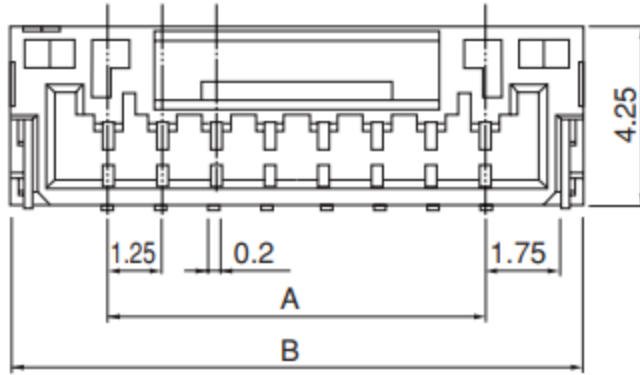

Figure 6. Accessory Port drawing. Dimension A is 11.25mm, Dimension B is 15.75mm

## 4.3 Software Interface

The Duo Pro R camera is configured and operated through the FLIR UAS mobile app. See Section 5 for additional details.

*Note: The Duo Pro R camera is not compatible with the FLIR Camera Controller User Interface software. When connected to the USB port on a computer, the camera appears as two mass storage devices (one for each microSD card) only.*

There is no Software Developer's Kit or API currently available for the Duo Pro R.

## 4.4 Connecting to a MAVLink Compatible Flight Controller

The FLIR Duo Pro R camera is software- and connector-compatible with many MAVLink autopilots. Other flight controllers or I/O modules may require different cables or connectors. Refer to the integration cable pinout in Table 2 and the documentation for your flight controller to correctly connect your camera.

## 4.5 Camera Operation

The Duo Pro R does not have an on/off switch.

- When power is applied to the camera, the Status LED blinks red for approximately 15 seconds, then changes to solid blue. When this happens, Bluetooth becomes enabled. FLIR Duo Pro R beeps three times and the Record LED goes from off to solid green. (If the FLIR Duo Pro R is connected to a computer, or if no SD card is inserted, the Record LED blinks yellow.)
- Launch the FLIR UAS App on your mobile device. Use the App to configure any desired camera settings and then disable the Bluetooth radio in preparation for flight. The Duo Pro R will automatically disable the Bluetooth radio after 2 minutes if no commands are received from the App. It can be re-enabled by pressing the Bluetooth button on the camera.

Duo Pro R User Guide, Rev. 1.0

Information on this page is subject to change without notice



# FLIR Duo Pro R User Guide

*Note: The Bluetooth interface is only intended to be used for ground operations. FLIR does not recommend flying while Bluetooth is enabled.*

- FLIR Duo Pro R is now ready for use. Press the Record button on the camera or in the App, to start recording, or use PWM signals setup on the autopilot. The Record LED will continuously blink red while recording video, or blink red each time a still image is captured. See Section 0 for instructions on how to adjust camera modes, video/still image formats, PWM settings, and other configuration options using the FLIR UAS App.

Camera Status and Record LED Description:



**Figure 7. LED Description**

- Status LED at power up – blinking RED
- Record LED at power up – OFF
  
- Status LED at ready – solid BLUE, Bluetooth is enabled; solid GREEN, Bluetooth disabled
- Record LED at ready – solid GREEN
  
- Record LED – blinking RED during recording; blinking YELLOW if recording alert (microSD card not present, is full, or is in use by PC)
  
- Status LED during firmware update – blinking PURPLE
  
- Press the Record button to initiate recording. The Record LED will blink red when recording video or still imagery.

Duo Pro R User Guide, Rev. 1.0

Information on this page is subject to change without notice



The World's Sixth Sense™

# FLIR Duo Pro R User Guide

---

- To (re)enable Bluetooth, simply press the Bluetooth button on the top of the camera.
- Factory Reset: Simultaneously pressing both the Record and Bluetooth buttons for 12 seconds will cause the system to reboot and do a hard reset, restoring all factory default settings.

*Note: The first time the camera is powered up, FLIR recommends verifying it has the latest firmware revision. Please see Appendix A for update instructions.*

# FLIR Duo Pro R User Guide

## 5 The FLIR UAS App

The FLIR UAS App is the primary control interface available for the Duo Pro R camera. It is compatible with many mobile devices equipped with Bluetooth LE running iOS 9.0 or later and Android v4.3 or above.

### 5.1 Home Screen

When launched, the FLIR UAS App will prompt the user to select the desired camera. Once selected and the connection process completes, the Home screen is displayed (see Figure 8). The Home screen shows current camera settings and provides access to basic system configuration settings such as the camera Display Mode, IR Scene settings, IR Palette, MSX settings, visible and IR digital zoom control, radiometry parameter settings, and Record Mode settings (video, single-still, or still-interval). It also provides access to the more advanced setup control screens. Status indicators of the current PWM and microSD card slot states are displayed at the top of the Home screen.



Figure 8. Home Screen

Duo Pro R User Guide, Rev. 1.0

Information on this page is subject to change without notice



The World's Sixth Sense™

# FLIR Duo Pro R User Guide

## 5.1.1 View Mode

The Duo Pro R streams analog or HDMI video from the output ports. Selection of the display video mode toggles between a **Visible** stream only, thermal infrared (**IR**) stream only, and a **Picture-In-Picture** (PiP) stream that shows a full-screen visible stream with a thermal stream displayed in an inset window. Note: Video mode primarily affects images displayed to HDMI, with minor impact to recorded RJPG images and snapshots taken during video recording. See “Settings” for more details on recorded data types.



Figure 9. Video Mode

## 5.1.2 Scene

Each Scene preset provides a combination of automatic gain control (AGC) settings which have been optimized by FLIR Systems to provide the best image for a specific application. In many cases, selecting a particular Scene preset will be all the camera setup that is required. However, these settings are intended to be used as guidelines and are not guaranteed to be the optimum values for any particular scenario. Depending upon scene content and viewing/recording preferences, individual settings may be further optimized.

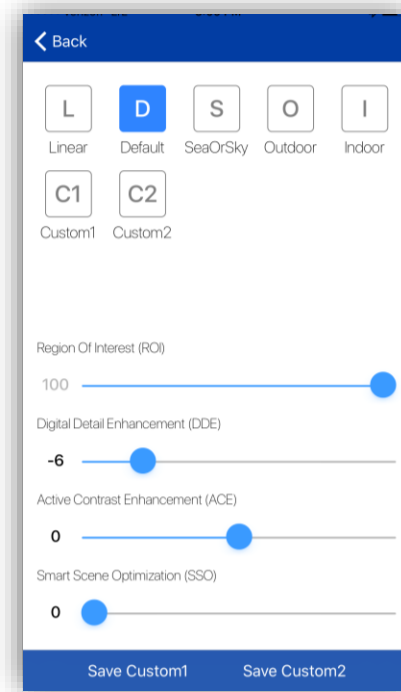

**Figure 10. Scene Presets**

### 5.1.2.1 Scene Presets

The Duo Pro R camera includes the following Scene presets:

1. Linear
2. Default
3. SeaOrSky
4. Outdoor
5. Indoor
6. Custom1
7. Custom2

Scene Algorithms have been tuned for each preset. Each option has its own set of image parameters. When switching between Scene settings, the camera requires roughly two seconds to load. If unsure which setting to use, select Default.

### 5.1.2.2 Region of Interest (ROI)

The Region Of Interest (ROI) slider allows the user to set a region of interest (a rectangular area of pixels on the sensor array) that the Scene algorithm will use for its calculations. This rectangular area can be configured so that varying amounts of sky will be excluded. When set to **100**, the full field of view will affect the image. A setting of **50** will exclude the top half of the image.

# FLIR Duo Pro R User Guide

---

## 5.1.2.3 DDE

Digital Detail Enhancement (DDE) is an algorithm which can be used to enhance image details and/or suppress fixed pattern noise. DDE parameters are computed automatically based on scene content and range from -20 to 100. Higher values represent higher degrees of detail enhancement. If no enhancement is desired, a value of 0 should be set. Values greater than 0 sharpen the image, while values less than 0 soften the image and filter fixed pattern noise. Although large values of DDE will significantly enhance the edges of objects in the scene, it can also raise the fixed pattern noise in the image.

## 5.1.2.4 ACE

The Active Contrast Enhancement (ACE) feature provides a contrast adjustment dependent on the relative scene temperature. ACE thresholds greater than 0 impart more contrast to hotter scene content and decrease contrast for colder scene content (e.g. sky or ocean). ACE threshold settings less than 0 do the opposite by decreasing contrast for hotter scene content and leaving more of the gray-scale shades to represent the colder scene content. ACE can range from -8 to 8 where -8 decreases contrast in darker regions while +8 increases contrast in darker regions. Although individual operator preferences may vary, FLIR recommends using positive values of ACE when selecting WhiteHot-based color palettes and negative values when selecting BlackHot. Color-based palettes typically require only small (if any) changes to ACE.

## 5.1.2.5 SSO

The Smart Scene Optimization (SSO) value defines the percentage of colors that will be linearly mapped. With SSO enabled, the difference in gray shades between two objects is more representative of the difference in temperature. SSO helps to set how linear the Scene algorithms are to provide the highest amount of perceived contrast in every scene. SSO can range from 0 to 100%.

## 5.1.2.6 Save Custom Scene Presets

Two user configurable Scene presets are provided. Saved settings include Scene algorithm, ROI, DDE, ACE, and SSO. The **Save** buttons store the presets, while the **Custom** selections (on the Scene page) recall them. To use this feature, begin by selecting the desired Scene preset. Once selected, the Scene preset can be further optimized using the manual control sliders. Record the desired settings by hitting the Save button.

## 5.1.3 IR Palette

The Duo Pro R detects and images long wave infrared radiation. Within the camera, this radiation is mapped (as determined by the Scene Preset selected) to a range of 255 colors. In a black and white palette, this range is converted to shades of gray with 0 being totally black and 255 being totally white. Different palettes are available to change the appearance of the image. The most common selection is either White Hot (hotter objects appear brighter than cooler objects) or Black Hot (hotter objects appear darker than cooler objects).

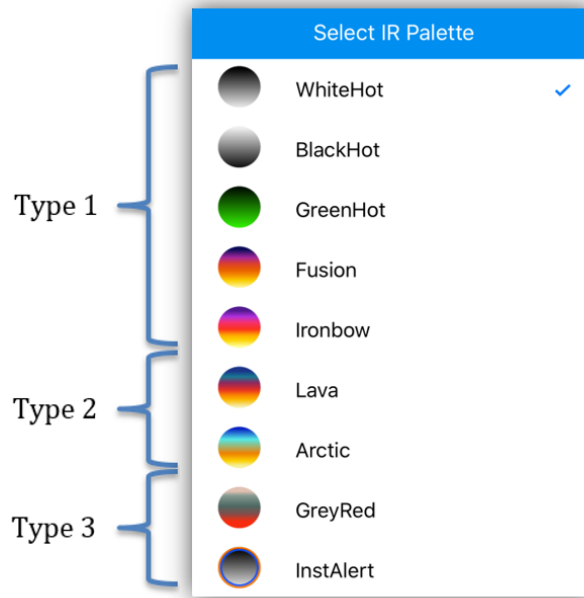

**Figure 11. Color Palettes**

There are four main types of palettes offered in the Duo Pro R camera:

1. **Linear:** Scene radiation is mapped to pixel values where color is uniformly distributed from one shade to another as pixel intensity increases. These palettes are the most common palettes for general use: WhiteHot, BlackHot, GreenHot, Fusion, Ironbow
2. **Contrast:** Enhances observed contrast by mapping pixel values to divergent color schemes. Subtle differences between object temperatures become more apparent. Lava, Arctic.
3. **Alert:** Helps draw attention to the hottest subjects in a scene by applying high-contrast color values to an otherwise linear distribution. GreyRed, InstAlert.
4. **Isothermal (not shown):** Highlights any objects within certain temperature ranges to dramatically call attention to them. See Section 5.2.1.4 for details on how to adjust the highlighted ranges.

*Note: Color palettes are applied to live analog video streams and stored 8-bit image formats. They are not applied to recorded 14-bit (.TIFF or .SEQ) files.*

# FLIR Duo Pro R User Guide

## 5.1.4 MSX

The Duo Pro R camera utilizes FLIR’s patented Multi Spectral Dynamic Imaging (MSX) technology found in FLIR’s Duo and FLIR One products. It provides extraordinary detail in real-time thermal images by embossing visible camera image information onto thermal video and stills. MSX produces exceptional thermal clarity and ensures easier target identification without compromising radiometric data. The UAS App provides the user with control over the strength of the MSX overlay, as well as horizontal and vertical alignment of the two streams.

Please note that the MSX feature is only available at a digital zoom setting of 100% for the 336 camera configurations, and 100% and 200% zoom for the 640 camera configurations.



Figure 12. MSX Parameter Adjustment

## 5.1.5 FFC

To maintain optimum performance, thermal imaging cameras occasionally must perform an internal calibration, or Flat Field Correction (FFC). This is accomplished using an internal shutter and takes less than 1 second. A warning is provided onscreen 1-2 seconds prior to this event and can be seen in the upper right-hand corner of the live image. During re-calibration, an audible “click” can be heard and live video is momentarily frozen. This function takes place automatically, based on internal camera parameters, and can also be manually initiated by the user through one of the available interfaces.

A user may find recalibrating prior to taking critical measurements will ensure best performance.

## 5.1.6 Zoom

Duo Pro R cameras have up to 4x digital zoom (slider setting of 400%) on the IR output, with associated on-screen symbology. For example, a Duo Pro R 336 in NTSC uses the center 320 x 240 pixels of the sensor for analog video. 2x (slider setting of 200%) zoom mode will interpolate the



# FLIR Duo Pro R User Guide

---

center 160 x 120 pixels onto the video stream. Digital zoom setting has no effect on recorded imagery. The visible sensor has up to 8x digital zoom (slider setting of 800%).

## 5.1.7 Measure

The controls displayed under the Measure section of the Home screen provide access to the settings that primarily affect temperature measurement accuracy. These radiometric parameters include sky condition, humidity, air temperature, and object emissivity. See Section 5.2.1.3 **Error! Reference source not found.** for details.

## 5.1.8 Capture

The Capture menu is used to configure the Duo Pro R's data bus for recording either still images or live video. Users can select between single frame, multiple frame, or video recording. The Record button is used to start and stop all file captures.

### 5.1.8.1 Single

Configures single image capture. Duo Pro R can be configured to record visible and IR as separate data (8-bit JPEG & 14-bit TIFF) files or as one combined FLIR Radiometric JPEG.

### 5.1.8.2 Multiple

Configures image capture at a user-selectable interval, similar to time-lapse recordings. Frames are captured as any available Photo Format. Interval can be configured from one frame per second up to one every 60 seconds.

### 5.1.8.3 Video

Video can be recorded in 8-bit H.264, monochrome 14-bit TIFF sequence files, or the FLIR proprietary RJPEG Video (.SEQ) sequence files. TIFF sequences can be captured at roughly 30 frames per second. Video recordings can capture either visible, infrared or both simultaneously. File type settings are configured in the **Capture** tab in the Settings section.

Note: While recording video, an additional "snapshot" button appears. Use this to grab an 8-bit still image while recording video.

- If the Display Mode is set to "IR", the still will be a thermal image.
- If the Display Mode is set to "Visible" or "Picture-in-Picture", the still will be a visible image.

### 5.1.8.4 Record

The Record button either captures a still image, or starts/stops live video recording. See Section 6 for details on available file formats.

# FLIR Duo Pro R User Guide

## 5.2 Settings

The Settings button, located in the upper right-hand corner of the Home screen, is used to configure the operational parameters of the Duo Pro R camera.

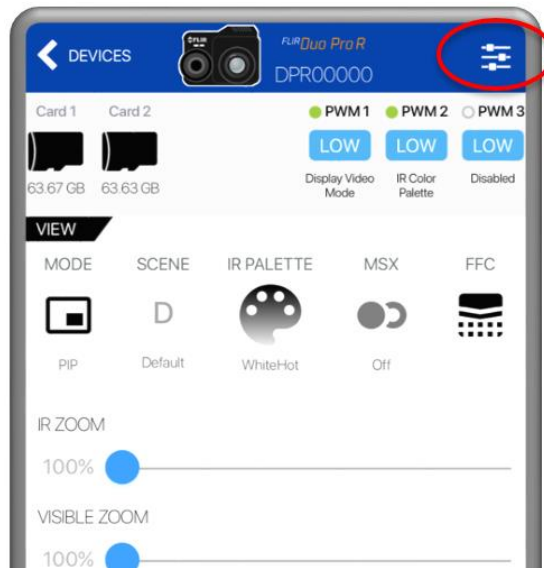

Figure 13. Settings Button

### 5.2.1 Capture

The Capture tab can be used to access image capture settings. It can also be used to access camera configuration controls like capture mode, IR zoom, color palette, etc.

#### 5.2.1.1 Capture Settings

- **Capture Mode:** Select Single, Multiple, Video (see Section 5.1.8)
- **Photo Format:** Select formats for still images saved to the microSD card (see Section 6).
- **IR Video Format:** Select H.264, 14-bit (TIFF Sequence), or FFF-SEQ. See Section 6.
- **Sound When Start/Stop Record:** Turns on/off the audible indicator for recording. Even when turned off, the speaker will beep three times when the camera is ready after power-up.
- **Status Light:** Turns on/off the Status and Bluetooth LEDs. LED indicators will still be displayed while camera is booting up if this setting is turned off.
- **Flip Image:** Select image orientation: normal or inverted. This impacts both the live video output and the recorded data.

#### 5.2.1.2 Thermal

- **IR Zoom:** Sets the IR zoom level (100% to 400%). (Section 5.1.5)
- **Color Palette:** Configures the color palette applied to the live IR video stream. Section 5.1.3)
- **Scene Mode:** Selects the scene mode applied to the IR video stream. (Section 5.1.2)
- **Scene Adjustments:** Selects the scene mode applied to the IR video stream. (Section 5.1.2)
- **Isotherm Adjustments:** Set the units and temperatures ranges for Isotherm color palettes. (Section 5.2.1.4)

Duo Pro R User Guide, Rev. 1.0

Information on this page is subject to change without notice



The World's Sixth Sense™

# FLIR Duo Pro R User Guide

## 5.2.1.3 Radiometry

Provides access to the Radiometry tab where users can configure all the temperature measurement functions and settings available on the Duo Pro R. See FLIR's UAS Radiometry Tech Note (see Section 2.2 for the link) for a detailed discussion on how to obtain accurate temperature readings for UAS applications.

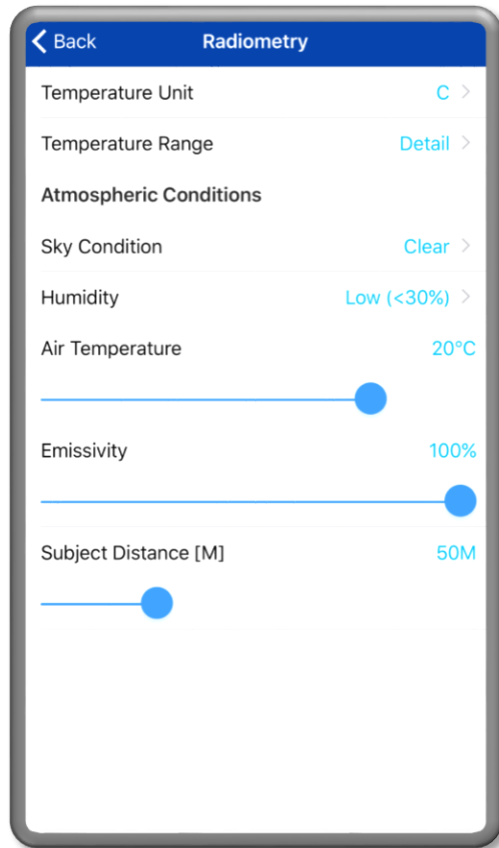

Figure 14. Radiometric Settings

- **Temperature Unit:** Units of measure displayed on the analog video stream. Select between Celsius and Fahrenheit.
- **Temperature Range:** This setting adjusts the camera sensitivity and dynamic range to provide optimum image quality. Detectable temperature ranges are as follows:
  - -25/+135°C (-13/+275°F)
  - -40/+550°C (-40/+1022°F)

Temperature measurements outside these ranges will be unreliable, and the pixels detecting those temperatures may saturate.

# FLIR Duo Pro R User Guide

## Atmospheric Conditions

- **Sky Condition:** Measure of the cloud cover above the operating site. This affects the background radiation incident on the scene. Clear, Scattered and Cloudy are input values.
- **Humidity:** Relative moisture content of the air. Three settings are available; Low (<30%), Medium (~45%), High (>60%).
- **Air Temperature:** Ambient temperature of the operating environment. Values from 0 to 40° C (32 to 104° F) can be configured.
- **Emissivity:** Measure of the target surface ability to emit thermal energy. Values from 50-100% can be configured.
- **Subject Distance:** Distance from the camera to the target in the scene. Values from 0-200m (0-218 yards) can be configured.
- **Spot Meter:** Turns on or off the spot meter (fixed 4x4 pixel array) in the center of the image, the on-screen thermometer on the left edge of the image, and the digital temperature in the lower left corner of the image. The spot consists of a 4x4 pixel array that is averaged to provide the measurement. Spot Meter and Scene Meter cannot be enabled at the same time.



Figure 15. Spot Meter

- **Scene Meter** – The Min and Max temperatures in the center 75% of the scene are actively identified and labeled by 4x4 pixel indicators. The specific values of these points are provided on screen in the lower left-hand corner, and color coded to the labeled points in the image. There is approximately 1 second of latency to process the scene which can lead to some lag and should be considered during use. Spot Meter and Scene Meter cannot be enabled at the same time.



Figure 16. Scene Meter

- **OT Still** – Records a still image any time the **Max:** value in the Scene Meter is greater than the setpoint. Values from 0 to 300° C (32 to 572° F) can be configured. The feature can also be disabled by setting it to **Off**. Scene Meter must be enabled for this feature to be available.
- **OT Alert** – When a temperature in the scene is detected that is greater than the setpoint, the **Max:** Scene Meter label flashes. Values from 0 to 300° C (32 to 572° F) can be configured. The feature can also be disabled by setting it to **Off**. Scene Meter must be enabled for this feature to be available.

#### 5.2.1.4 Isotherm

Isotherm is a unique FLIR feature that allows users to highlight specific temperatures ranges in their thermal imagery. To enable Isotherm, simply select one of the IR color palettes with “Iso” in the name, and tune to temperature range limits to highlight objects of interest for your specific application.

#### Isotherm Adjustment

- **Units:** Select “Temperature” to set your ranges in units of Celcius. Select “Percent” to set your ranges in terms of percent relative to all pixels in the image.
- **Low / Medium / High:** Set the ranges for highlighted values in Isotherm mode.

For example: If you set low/med/high as 10, 15, and 25 with units of Temperature, your thermal image will highlight all pixels with a temperature between 10C and 15C in one color range, and all pixels with a temperature between 15C and 25C in another range. Every pixel above 25C will be the same color, representing the max temp reading for your settings.

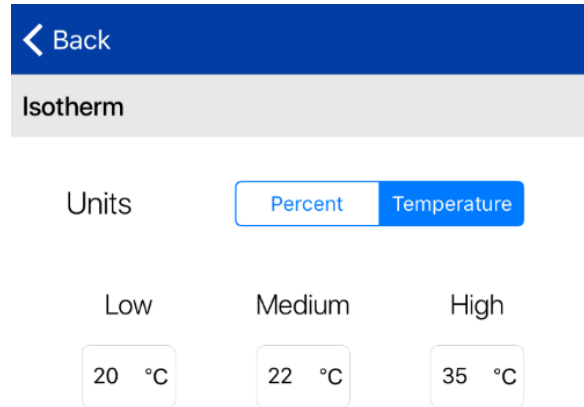

**Figure 17: Isotherm Adjustment menu**

Try setting units to “percent” and low/med/high to 80, 90, 98 to highlight the highest-temperature pixels in each scene.

Play around with these settings for your specific application to find the best palette and setting combination!

### 5.2.1.5 Video Output

- **Analog Video Format:** Select NTSC or PAL as the format of the analog video that is output to the Accessory Port. This setting does not affect the format of the video that is saved to the microSD card.
- **HDMI:** Select the format of the video that is output to the HDMI port. Options are 720p60 (1280x720 60Hz), 1080p30 (1920x1080 30Hz), and 1080p60 (1920x1080 60Hz) formats.

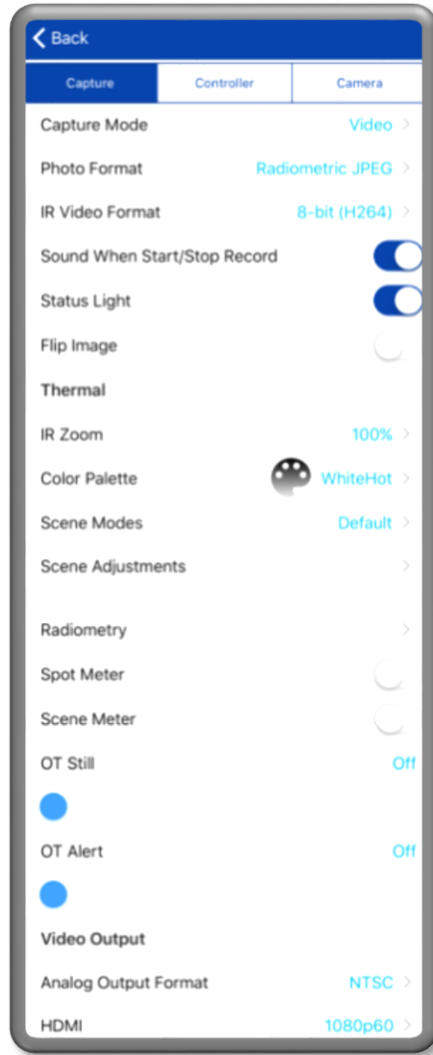

Figure 18. Capture Settings

## 5.2.2 Controller

The Controller tab provides access to the serial protocol settings.

- **PWM:** Using the accessory port on the Duo Pro R and the included Integration Cable (see Section 3.1.4), camera functions can be controlled directly from the sUAS flight controller via PWM signals (refer to the controller manual for configuration instructions, as every brand of controller is a little different). Select the desired setting from the list of available PWM functions. **No two channels can be assigned to the same function.** Any functions currently assigned to PWM channels will not appear in the list of available functions for other channels. PWM 1, PWM2, and PWM 3 are the channels available with the Duo Pro R Accessory Cable. Please refer to Table 2 for wiring guidelines.

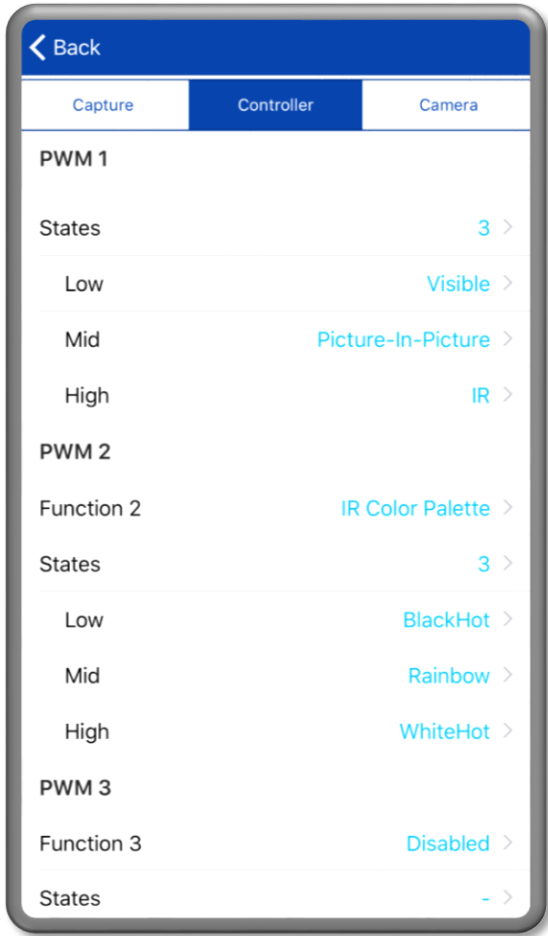

Figure 19. Controller Settings

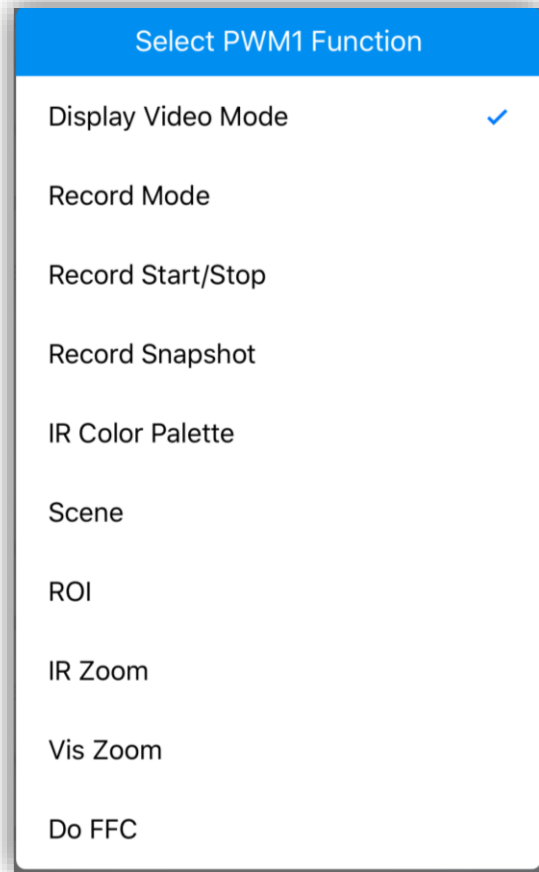

Figure 20. PWM Functions



# FLIR Duo Pro R User Guide

---

To configure:

1. Select the **Settings** button on the Main page.
2. Select the **Controller** tab at the top of the page. Ensure Serial Protocol is set to PWM.
3. Select a PWM channel to configure.
4. Select the desired function.
5. Select the number of states. The number of states will depend on the type of switch that is being mapped on the flight controller. For a three-position switch, the number of states will be three.
6. Assign functions to the available states for each signal.
7. Program the flight controller to provide signals to the Aux Out ports for the P1, P2 and/or P3 connectors on the Accessory Cable.

The Duo Pro R accepts standard PWM inputs for the R/C industry, 3.3-5vdc, 50Hz. LOW = 1ms/20ms, MID = 1.5ms/20ms, HIGH = 2ms/20ms.

- **Frame Sync:** PWM channel 3 (Accessory Port Pin 4) can be configured to provide a 3.3vdc output during image save operations for time synchronization with other external devices. For Still images, the signal is high during the capture of individual frames. During Video and Timelapse the signal is high for the duration of capture. Frame Sync is not available as an input to the Duo Pro R. To enable Frame Sync, select “Frame Sync” as the function for PWM3 through the UAS App.
- **MAVLink:** Many UAS flight controllers support the MAVLink serial protocol to provide an interface with external components. The Duo Pro R can be configured to use this bus to capture available telemetry data provided by GPS, altimeter, accelerometers, etc. This data is saved as standard EXIF metadata in Still Image files (JPG & TIFF). This data is not saved to Video files as there is no current standard for doing this. Metadata is accessible through standard photo editing applications, file explorers, and suggested mapping applications.

# FLIR Duo Pro R User Guide

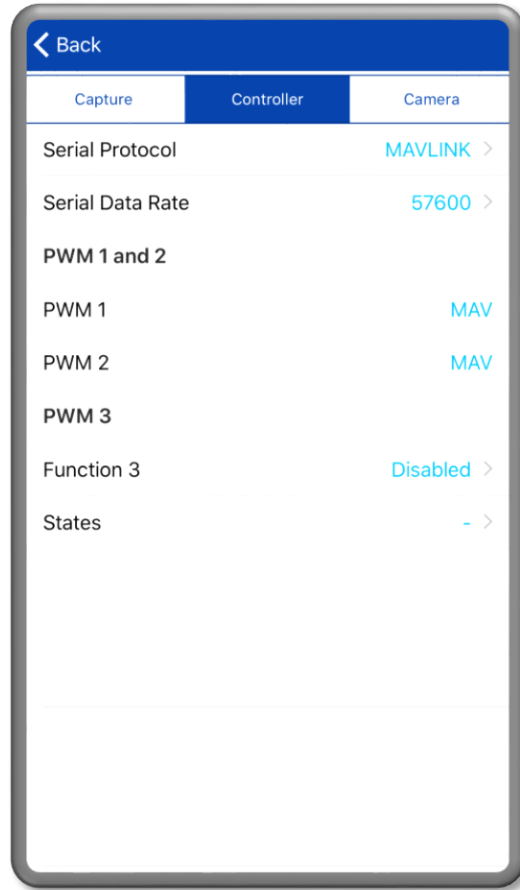

**Figure 21. MAVLink Settings**

The following MAVLink 3.0 commands are currently supported by the Duo Pro R FW 1.0.0:

Command	MAVLink ID	R/S(Receive/Send)	Notes
HEARTBEAT	0	R/S	
PING	4	R/S*	If Duo Pro R has received PING, then will reply with a PING
SYSTEM_TIME	2	R	
ATTITUDE	30	R	
GLOBAL_POSITION_INT	33	R	
GLOBAL_POSITION_INT_COV	63	R	
HIL_GPS	113	R	
MOUNT_STATUS	158	R	

Duo Pro R User Guide, Rev. 1.0

Information on this page is subject to change without notice



The World's Sixth Sense™

# FLIR Duo Pro R User Guide

---

FLIR Duo Pro R communicates on the MAVLink bus at a default 57,600 baud rate, which is standard for most devices. The user can alternatively select 115,200 or 230,400 baud through the App. Where possible, ensure RTSCTS is disabled as this is known to cause issues with communication. The included Integration cable (PN 4210536) and Bench Cable (PN 4210503) are pre-terminated to connect properly with the 3DR PixHawk TELEM 1 port. If this port is already in use, see the [PixHawk documentation](#) for information on how to reconfigure ports.

If all available flight controller ports are full, you may need to investigate using a splitter cable to attach additional devices to a single port. Duo Pro R can operate in a receive only configuration much like an OSD, and therefore does not require the TX pin from the camera to be connected to the RX pin on a flight controller. Only one external device can connect to the flight controller RX port. This device should provide at least HEARTBEAT and request at least SYSTEM TIME and GLOBAL\_POSITION\_INT. Please refer to Table 2 for Accessory Port pin-out when building custom cables.

Please note that some flight controllers (3DR Solo) will sleep a serial port if no connection is detected. Please plan accordingly when setting up your system.

Please see Appendix B for the full MAVLink protocol implementation.

## 5.2.3 Camera

The Camera tab is used to configure Bluetooth settings, and for accessing camera-specific information such as serial number, firmware and APP versions, and to reset the system to factory default conditions.

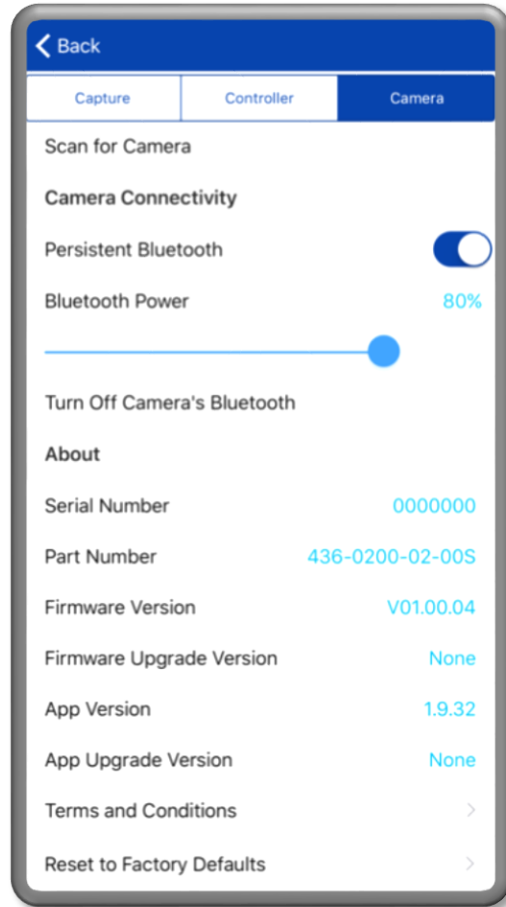

Figure 22. Camera Tab

## Camera Connectivity

- **Scan for Camera:** Prevents the Bluetooth interface from shutting off after 2 minutes by keeping the APP running on the handset.
- **Persistent Bluetooth:** Prevents the Bluetooth interface from shutting off after 2 minutes by keeping the APP running on the handset.
- **Bluetooth Power:** Adjusts the Bluetooth transmitter power and affects the maximum range at which the Duo Pro R camera can connect to the mobile device. Power values are expressed in percent.
- **Turn Off Camera Bluetooth:** Powers down the Bluetooth radio on the camera. The camera will normally disable the Bluetooth after two minutes of inactivity (unless Persistent Bluetooth is enabled).

## About

- **Serial Number** – Duo Pro R camera serial number currently connected to the app.
- **Part Number** – FLIR part number of the Duo Pro R camera currently connected to the app.
- **Firmware Version** – Version of firmware currently loaded in the Duo Pro R camera.

# FLIR Duo Pro R User Guide

---

- **FW Upgrade Version** - Detects if a camera upgrade file exists on the microSD card. If one is available, the Upgrade Available dialog will start. Choose Yes to begin the upgrade process. See Appendix A for details on how to upgrade camera firmware.
- **App Version** - Version of software currently loaded on the mobile device.
- **App Upgrade Version** - If the mobile device is connected to the Internet, the Duo Pro R app will automatically search for any available app updates. If one exists, the user will have the option to update by following the link to the FLIR web page.
- **Terms and Conditions** - Legal disclaimer, warranty info, usage statistics collection.
- **Reset To Factory Defaults** - Resets settings in the Duo Pro R camera to original factory configuration. This is required during most FW updates as the internal memory map will change as new features are added.

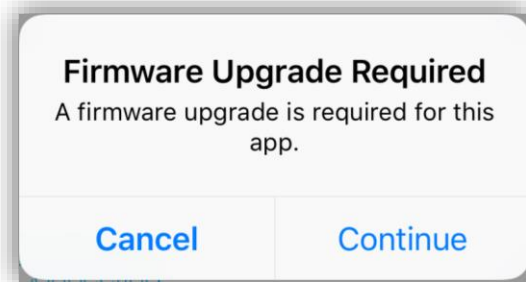

**Figure 23. Firmware Upgrade**

# FLIR Duo Pro R User Guide

## 6 File Formats

The Duo Pro R can save image data in a number of file formats, each with unique characteristics. Table 3 gives a summary of the different file types. Read this section for more detailed explanations of the available data types for still images and recorded video.

Type	Data Format	Extension	Bit depth	Notes
Still	8-bit JPEG	*_8b.JPG	8-bit	LWIR only, AGC & color palette applied Visible image is contained in a separate .JPG
	Radiometric JPEG (recommended)	*_R.JPG	8 & 14-bit	Contains both Thermal & Visible data in a single file: 640 x 512 8-bit thumbnail based on work mode 640 x 512 LWIR 14-bit Flinear data 12MP Visible image
	TIFF	*.TIFF	14-bit	Tlinear data, radiometric parameters fixed at time of capture Visible image is contained in a separate .JPG
Video	8-bit	*.MOV	8-bit	Thermal only. AGC & color palette applied Visible video is contained in a separate .MOV
	14-bit (RJPEG) (recommended)	*.SEQ	14-bit	Flinear data, radiometric parameters can be adjusted in FLIR software Metadata dynamic per frame Visible video is contained in a separate .MOV
	14-bit (TIFF)	*.TIFF	14-bit	Tlinear data, radiometric parameters fixed at time of capture Metadata only for the initial frame Visible video is contained in a separate .MOV

Table 3. Thermal Image Formats Recorded on microSD Card

### 6.1 Visible Video Formats

Visible Video can be saved in 1080p or 4K formats. Both will be saved as .MOV files, but note that 4K video is not currently supported by Windows Media Player, so another video player will need to be used.

Note: Each visible video file will be accompanied by a .SRT file of the same name. This is a subtitle file that captures metadata (date, time, GPS coordinates, and altitude).

### 6.2 Infrared: Still File Types

#### 6.2.1 Radiometric JPG (or “RJPEG”, for short)

The Radiometric JPEG format of the Duo Pro R contains both thermal and visible image data in a single file format. The file is composed of:

- An 8-bit thumbnail image
- A 14-bit thermal image
- An 8-bit visible JPEG

This is FLIR’s recommended file type, because it captures the 14-bit raw thermal image in a format that can be easily post-processed using FLIR Tools and ResearchIR. The major advantage of RJPEG

# FLIR Duo Pro R User Guide

---

is that radiometry parameters, such as emissivity and background temperature, can be adjusted in post-processing for more thorough analysis and reporting.

If a compatible flight controller is available telemetry will be captured and saved in standard metadata fields.

Files have a “\_R.jpg” extension.

Note: the 8-bit thumbnail will change based on the camera video display mode.

- If video display mode is set to “IR”, the JPEG thumbnail will be a thermal image.
- If video display mode is set to “Visible” or “Picture-in-Picture”, the thumbnail will be a low-quality visible image

No matter what the thumbnail appears as, the full IR and Visible image data will always be contained within the file.

## 6.2.2 TIFF

TIFF is uncompressed 14-bit temperature linear sensor data with no post processing. If a compatible flight controller is available, telemetry will be captured and saved in standard metadata fields. This is the standard format required by most mapping applications.

Note: While TIFF is a standard file-format, it should be noted that radiometric parameters (such as emissivity and background temperature) cannot be adjusted in post-processing. This is why FLIR generally recommends the JPEG file format.

The 14-bit TIFF file format of the Duo Pro R camera contains temperature information in the form of pixel intensities. These pixel values can be converted into temperature using the following formulas:

$$\begin{aligned} [\text{counts@High Resolution}] * 0.04 - 273.15 &= \text{deg C} \\ [\text{counts@Low Resolution}] * 0.40 - 273.15 &= \text{deg C} \end{aligned}$$

where “counts@High Resolution” are the individual pixel values recorded using the Temp Range setting of High (-25 to +135C) and “counts@Low Resolution” are pixel values recorded at a Temp Range setting of Low (-40 to +550C).

Individual pixel values can be converted manually. FLIR’s ResearchIR software program can convert the entire image as well. Alternatively, if pixel intensities of TIFF files can be exported in a format that Microsoft Excel can recognize (.CSV for example), the conversion can be performed using Excel tools.

In software programs like FLIR’s ResearchIR, these conversion formulas can be applied to images by utilizing the Filter tools. Enable the Gain Filter and assign it a value of either 0.04 or 0.4, depending on the camera’s Temp Range setting at the time of capture. Enable the Offset filter and assign it a value of -273.15.

Duo Pro R User Guide, Rev. 1.0

Information on this page is subject to change without notice



The World's Sixth Sense™

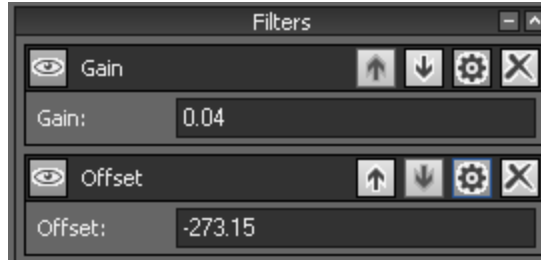

Figure 24. Using ResearchIR to convert pixel values

### 6.2.3 8-bit JPG

The 8-bit JPG format of the Duo Pro R is exclusively a compressed image as seen on the video output, and has no thermal data available for post processing. The 8-bit image has user Scene and Palette processing applied, as well as Spot / Scene Meter if enabled. If a compatible flight controller is available telemetry will be captured and saved in standard metadata fields. Files have a “\_8b.jpg” extension. This format is not suitable for mapping nor later data analysis.

This file type only appears when a snapshot is captured during video recording.

## 6.3 Infrared: Video File Types

### 6.3.1 14-bit (RJPEG)

A 30Hz video file where every frame is an RJPEG. This file format is compatible with FLIR Tools and ResearchIR, and allows users to edit radiometric parameters such as emissivity and background temperature in post-processing.

Radiometric parameters such as subject emissivity and distance can be adjusted in post-processing using FLIR Tools or ResearchIR software, giving maximum flexibility to adjust & edit measurement data in post-processing.

Each video frame has unique metadata, such as GPS coordinates, associated with it.

### 6.3.2 14-bit (TIFF)

A 30Hz video file where every frame is a TIFF. This file format is compatible with many image processing tools, such as MATLAB and ImageJ. To convert the values to temperature (Celcius), see section 6.2.2.

Radiometric parameters such as subject emissivity and distance cannot be adjusted in post-processing.

There is only one set of metadata associated with the entire file, recorded at the start of the video.



# FLIR Duo Pro R User Guide

---

## 6.3.3 8-bit (H264)

A 30Hz video file that matches the IR output to the HDMI or Analog monitor. This is a compressed file which has less information than the 14-bit options. It captures the color palette, AGC settings, and any on-screen radiometry information (spot meter or scene meter), but cannot be adjusted in post-processing. Furthermore, temperature information is not contained in the video file.

There is a .SRT file recorded with each file. This is a subtitle file that contains some metadata information: date, time, GPS coordinates, and altitude.

It is only recommended for basic use-cases where temperature information is not important, and not post-processing is required.

# FLIR Duo Pro R User Guide

Duo Pro R User Guide, Rev. 1.0

Information on this page is subject to change without notice



The World's Sixth Sense™

# FLIR Duo Pro R User Guide

---

## 7 Care of FLIR Duo Pro R

- Power the FLIR Duo Pro R with a regulated 5-26 Vdc power source. Using more than 26 Vdc will damage the camera and void the warranty.
- Do not touch the lens. If the lens gets dirty, a light dusting of air should dislodge any dust particles. If the lens is still noticeably dirty, use 75% Isopropyl alcohol and lens tissue. Use light wiping motions, with a fresh section of lens tissue with each swipe so as not to drag dust or dirt particles back over the lens surface.
- FLIR Duo Pro R cameras have been focused at the factory and optimized for the maximum UAS range. Opening the camera may compromise the external seal of the camera and factory focus may be lost.
- FLIR Duo Pro R is neither water nor dust resistant. Care for it as you would any valuable piece of electronics equipment.

If you have questions about your Duo Pro R camera, contact FLIR Tech Support at [flirsuas-support@flir.com](mailto:flirsuas-support@flir.com) or [SBA-Cores@flir.com](mailto:SBA-Cores@flir.com). In most cases, questions related to integrating the Duo Pro R into a particular airframe should be directed toward one of FLIR's authorized UAS distributors.

## Appendix A - Software and Firmware Update

### How to Update the FLIR UAS App

Download the latest handset application from the appropriate web store for your platform. Some handy links are listed below. Also, be sure to keep the OS up to date on your device, as Bluetooth is an evolving protocol and receives continuous improvements.

iOS APP store  
Android APP store  
Android APK file direct DL

### How to update Duo Pro R Firmware (FW)

#### Duo Pro R Firmware Upgrade Procedure

1. **Make note of your current Duo Pro R settings.** Connect to the Duo Pro R with the Bluetooth application and make note of all your settings. The firmware upgrade will reset the camera settings to defaults since we typically are adding features and the previous settings may not be optimal with the upgraded FW.
2. **Download firmware update to uSD card.** Download then save the firmware upgrade onto the camera micro SD card either by connecting your Duo Pro R to a computer with the included Bench cable, or through another suitable micro SD card reader.
3. **With power off, insert the uSD card into Slot 1 of the Duo Pro R.**
4. **Power on Duo Pro R.** Power on the Duo Pro R and wait for it to complete the boot cycle (you'll hear the three beeps and see the Bluetooth light go steady blue and the Record light go steady red). If the Bluetooth radio does not enable, press the button to turn it on. You will see a blue light.
5. **Initiate Update through the FLIR UAS App.** Open the Duo Pro R app and connect to the camera. The app will read the camera's settings, then display the Firmware update message (Figure 23). Select "Yes" to begin the update. The Bluetooth light will flash purple for 30-45 seconds while it's updating, then the camera will re-boot up to two times. The total process may take a couple minutes. Wait at least 2 minutes and do not attempt to connect to the camera with the FLIR UAS app until it has rebooted and come to a steady power state.

Duo Pro R User Guide, Rev. 1.0

Information on this page is subject to change without notice



The World's Sixth Sense™

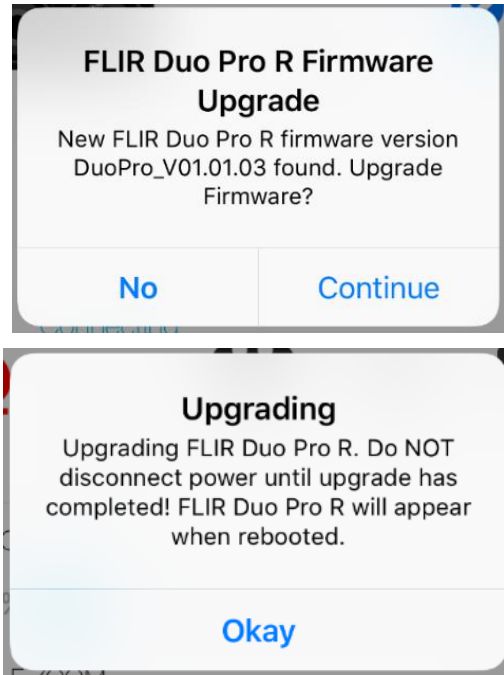

Figure 25. Firmware Upgrade Prompts

6. **Reconnect via Bluetooth.** Once rebooted, reconnect your handset to the camera by selecting 'Yes' from the Bluetooth Disconnect dialogue. The camera should reconnect and present you with the Main screen. If you previously selected 'No' in this dialogue you will need to force quit and restart the APP on your handset.
7. **Restore User Settings.** From your notes in Step 1 reconfigure any custom settings that have been reset to factory default. You can also delete the firmware update file from your microSD card.

# FLIR Duo Pro R User Guide

## Appendix B - MAVLink Implementation

### HEARTBEAT (0)

Field Name	ENUM	Type	Official Description	FLIR Implementation
System ID			MAVlink packet Byte 3	1
Component ID			MAVlink packet Byte 4	100
Type	MAV_TYPE	uint8_t	MAV_TYPE_GENERIC - Generic micro air vehicle.	0
Autopilot	MAV_AUTOPILOT	uint8_t	MAV_AUTOPILOT_INVALID - No valid autopilot, e.g. a GCS or other MAVLink component	8
Base Mode	MAV_MODE_FLAG	uint8_t	MAV_MODE_FLAG_MANUAL_INPUT_ENABLED - 0b01000000 remote control input is enabled.	64
Custom Mode		uint32_t	A bitfield for use for autopilot-specific flags.	0
System Status	MAV_STATE	uint8_t	MAV_STATE_ACTIVE - System is active and might be already airborne. Motors are engaged.	4
MAVLink Version		uint8_t	MAVLink version, not writable by user	default

### PING (4)

Field Name	ENUM	Type	Official Description	FLIR Implementation
Time Unix		uint64_t	Timestamp (microseconds since UNIX epoch or microseconds since system boot)	Ignored
Sequence		uint32_t	PING sequence	Same as official
System ID		uint8_t	0: request ping from all receiving systems, if greater than 0: message is a ping response and number is the system id of the requesting system	See description above
Component ID		uint8_t	0: request ping from all receiving components, if greater than 0: message is a ping response and number is the system id of the requesting system	See description above

### SYSTEM\_TIME (2)

Field Name	ENUM	Type	Official Description	FLIR Implementation
Time Unix		uint64_t	Timestamp of the master clock in microseconds since UNIX epoch.	If time is valid, it will be set to the device.
Time Boot		uint32_t	Timestamp of the component clock since boot time in milliseconds.	Ignored

Duo Pro R User Guide, Rev. 1.0

Information on this page is subject to change without notice



The World's Sixth Sense™

# FLIR Duo Pro R User Guide

## ATTITUDE (30)

Field Name	Type	Official Description	FLIR Implementation
Time Boot	uint32_t	Timestamp (milliseconds since system boot)	Ignored
Roll	float	Roll angle (rad, -pi..+pi)	Meta = MAV Roll
Pitch	float	Pitch angle (rad, -pi..+pi)	Meta = MAV Pitch
Yaw	float	Yaw angle (rad, -pi..+pi)	Meta = MAV Yaw
Roll Rate	float	Roll angular velocity (rad/s)	Meta = MAV Roll Rate
Pitch Rate	float	Pitch angular velocity (rad/s)	Meta = MAV Pitch Rate
Yaw Rate	float	Yaw angular velocity (rad/s)	Meta = MAV Yaw Rate

## GLOBAL\_POSITION\_INT (33)

Field Name	Type	Official Description	FLIR Implementation
Time Boot	uint32_t	Timestamp (milliseconds since system boot)	Ignored
Latitude	int32_t	Latitude, expressed as * 1E7	Meta = GPS Latitude
Longitude	int32_t	Longitude, expressed as * 1E7	Meta = GPS Longitude
Altitude (MSL)	int32_t	Altitude in meters, expressed as * 1000 (millimeters), AMSL (not WGS84 - note that virtually all GPS modules provide the AMSL as well)	Meta = GPS Altitude
Altitude (Relative)	int32_t	Altitude above ground in meters, expressed as * 1000 (millimeters)	Meta = MAVRelativeAltitude
Velocity X	int16_t	Ground X Speed (Latitude), expressed as m/s * 100	Calc = GPS Speed
Velocity Y	int16_t	Ground Y Speed (Longitude), expressed as m/s * 100	Calc = GPS Speed
Velocity Z	int16_t	Ground Z Speed (Altitude), expressed as m/s * 100	Calc = GPS Speed
Heading	uint16_t	Compass heading in degrees * 100, 0.0..359.99 degrees. If unknown, set to: UINT16_MAX	Meta = GPS Track

## GLOBAL\_POSITION\_INT\_COV (63)

Field Name	Type	Official Description	FLIR Implementation
------------	------	----------------------	---------------------

Duo Pro R User Guide, Rev. 1.0

Information on this page is subject to change without notice



The World's Sixth Sense™

# FLIR Duo Pro R User Guide

Time Boot		uint32_t	Timestamp (milliseconds since system boot)	Ignored
Time Unix		uint64_t	Timestamp (microseconds since UNIX epoch) in UTC. 0 for unknown.	Ignored
estimator_type	MAV_ESTIMATOR_TYPE	uint8_t	Class id of the estimator this estimate originated from.	Ignored
Latitude		int32_t	Latitude, expressed as * 1E7	Meta = GPS Latitude
Longitude		int32_t	Longitude, expressed as * 1E7	Meta = GPS Longitude
Altitude (MSL)		int32_t	Altitude in meters, expressed as * 1000 (millimeters), AMSL (not WGS84 - note that virtually all GPS modules provide the AMSL as well)	Meta = GPS Altitude
Altitude (Relative)		int32_t	Altitude above ground in meters, expressed as * 1000 (millimeters)	Meta = MAVRelativeAltitude
Velocity X		float	Ground X Speed (Latitude), expressed as m/s * 100	Calc = GPS Speed
Velocity Y		float	Ground Y Speed (Longitude), expressed as m/s * 100	Calc = GPS Speed
Velocity Z		float	Ground Z Speed (Altitude), expressed as m/s * 100	Calc = GPS Speed
covariance		float[36]	Covariance matrix (first six entries are the first ROW, next six entries are the second row, etc.	Ignored

## HIL\_GPS (113)

Field Name	Type	Official Description	FLIR Implementation
time_usec	uint64_t	Timestamp (microseconds since UNIX epoch or microseconds since system boot)	Ignored
fix_type	uint8_t	0-1: no fix, 2: 2D fix, 3: 3D fix. Some applications will not use the value of this field unless it is at least two, so always correctly fill in the fix.	Ignored
lat	int32_t	Latitude (WGS84), in degrees * 1E7	Meta = GPS Latitude
lon	int32_t	Longitude (WGS84), in degrees * 1E7	Meta = GPS Longitude
alt	int32_t	Altitude (AMSL, not WGS84), in meters * 1000 (positive for up)	Meta = GPS Altitude
eph	uint16_t	GPS HDOP horizontal dilution of position in cm (m*100). If unknown, set to: 65535	Meta = GPSXYAccuracy
epv	uint16_t	GPS VDOP vertical dilution of position in cm (m*100). If unknown, set to: 65535	Meta = GPSZAccuracy
vel	uint16_t	GPS ground speed (m/s * 100). If unknown, set to: 65535	Ignored
vn	int16_t	GPS velocity in cm/s in NORTH direction in earth-fixed NED frame	Ignored
ve	int16_t	GPS velocity in cm/s in EAST direction in earth-fixed NED frame	Ignored
vd	int16_t	GPS velocity in cm/s in DOWN direction in earth-fixed NED frame	Ignored

Duo Pro R User Guide, Rev. 1.0

Information on this page is subject to change without notice



The World's Sixth Sense™



# FLIR Duo Pro R User Guide

cog		uint16_t	Course over ground (NOT heading, but direction of movement) in degrees * 100, 0.0..359.99 degrees. If unknown, set to: 65535	Ignored
satellites_visible		uint8_t	Number of satellites visible. If unknown, set to 255	Ignored

## MOUNT\_STATUS (158)

Field Name		Type	Official Description	FLIR Implementation
pointing_a		uint32_t	Pitch (deg*100)	Meta = Yaw (camera)
pointing_a		uint32_t	Roll angle (rad, -pi..+pi)	Meta = Pitch (camera)
pointing_a		uint32_t	Pitch angle (rad, -pi..+pi)	Meta = Roll (camera)
Target System		uint8_t	Yaw angle (rad, -pi..+pi)	Ignored
Target Component		uint8_t	Roll angular velocity (rad/s)	Ignored

# FLIR Duo Pro R User Guide

---

FLIR Commercial Systems, 2017. All rights reserved worldwide. No parts of this manual, in whole or in part, may be copied, photocopied, translated, or transmitted to any electronic medium or machine-readable form without the prior written permission of FLIR Commercial Systems

Names and marks appearing on the products herein are either registered trademarks or trademarks of FLIR Commercial Systems and/or its subsidiaries. All other trademarks, trade names, or company names referenced herein are used for identification only and are the property of their respective owners.

Liberation fonts are copyright 2009 by RedHat and are used under authority of the GNU public license.

This product is protected by patents, design patents, patents pending, or design patents pending.

This documentation and the requirements specified herein are subject to change without notice.



This equipment must be disposed of as electronic waste.

Contact your nearest FLIR Commercial Systems, Inc. representative for instructions on how to return the product to FLIR for proper disposal.

**FCC Notice.** This device is a subassembly designed for incorporation into other products in order to provide an infrared camera function. It is not an end-product fit for consumer use. When incorporated into a host device, the end-product will generate, use, and radiate radio frequency energy that may cause radio interference. As such, the end-product incorporating this subassembly must be tested and approved under the rules of the Federal Communications Commission (FCC) before the end-product may be offered for sale or lease, advertised, imported, sold, or leased in the United States. The FCC regulations are designed to provide reasonable protection against interference to radio communications. See 47 C.F.R. §§ 2.803 and 15.1 et seq.

**Industry Canada Notice.** This device is a subassembly designed for incorporation into other products in order to provide an infrared camera function. It is not an end-product fit for consumer use. When incorporated into a host device, the end-product will generate, use, and radiate radio frequency energy that may cause radio interference. As such, the end-product incorporating this subassembly must be tested for compliance with the Interference-Causing Equipment Standard, Digital Apparatus, ICES-003, of Industry Canada before the product incorporating this device may be: manufactured or offered for sale or lease, imported, distributed, sold, or leased in Canada.

**Avis d'Industrie Canada.** Cet appareil est un sous-ensemble conçu pour être intégré à un autre produit afin de fournir une fonction de caméra infrarouge. Ce n'est pas un produit final destiné aux consommateurs. Une fois intégré à un dispositif hôte, le produit final va générer, utiliser et émettre de l'énergie radiofréquence qui pourrait provoquer de l'interférence radio. En tant que tel, le produit final intégrant ce sous-ensemble doit être testé pour en vérifier la conformité avec la Norme sur le matériel brouilleur pour les appareils numériques (NMB-003) d'Industrie Canada avant que le produit intégrant ce dispositif puisse être fabriqué, mis en vente ou en location, importé, distribué, vendu ou loué au Canada.

**EU Notice.** This device is a subassembly or component intended only for product evaluation, development or incorporation into other products in order to provide an infrared camera function. It is not a finished end-product fit for general consumer use. Persons handling this device must have appropriate electronics training and observe good engineering practice standards. As such, this product does not fall within the scope of the European Union (EU) directives regarding electromagnetic compatibility (EMC). Any end-product intended for general consumer use that incorporates this device must be tested in accordance and comply with all applicable EU EMC and other relevant directives.