

EDSYN®

...the power of precision

Hands Tools:

Soldapullts, Cutters, Pliers, Tweezers and Production Aids



EDSYN Incorporated is proud to present a new line of hand tools and production aids for electronic assembly and repair. Being a leading manufacturer for over 40 years, Edsyn's mission is to bring innovative ideas to life through quality engineering and commitment to high performance designs dedicated to suit customer needs.

In the following pages, you will find a wide variety of Edsyn Soldapullts, hand tools, cutters, pliers, tweezers and other production aids that fit most any assembly and rework requirement. You will also find alternatives to popular brands of European tools at substantial savings. Whether it's from our high quality line of US made tools or from our value line of tools, you are sure to find the perfect tool for a perfect job at any budget.



EDSYN Quality

© Copyright 2008 by EDSYN, Inc. All Rights Reserved

No part of this catalog, including individual icons, may be reproduced or utilized in any form or by any means without the written permission of EDSYN, Inc.

Most products are covered by U.S. and foreign patents and pending applications.

Design, color, weight and material subject to change without notice. Tip style on tools may vary.

TABLE OF CONTENTS

SOLDAPULLTS

Soldapullts.....	4-5
------------------	-----

TWEEZERS

Tweezer Kits	6
Surface Mount Tweezers.....	7
Carbon Fiber Tip Tweezers	8
Cutting Tweezers.....	8
Precision Electronic Tweezers	8-11
Reverse-Action Tweezers.....	12
Miniature Tweezers.....	12

PLIERS

EDSYN Brand	13-15
LARSON Brand.....	16
EDSYN Value Brand.....	17

CUTTERS

EDSYN Brand Oval Head Cutters.....	18-19
EDSYN Brand Tapered Head Cutters.....	20-22
EDSYN Brand Tip & Oblique Cutters.....	22-23
EDSYN Brand Stand-Off Cutters	23
LARSON Brand Cutters	24-26
LARSON Cutters & Pliers Cross-Reference Guide	27
EDSYN Value Brand Cutters	28

SCREWDRIVERS

Phillips & Slotted Flat Head Screwdrivers	29
Mini Screwdriver Sets.....	30

PRODUCTION AIDS	30-53
------------------------------	--------------

SOLDAPULLTS

SOLDAPULLTS

EDSYN got it's start by introducing the original Soldapull[®] hand desoldering tool. This invention revolutionized the industry 40 years ago. That innovative spirit still drives us forward. The Soldapull[®] line of hand desoldering tools has grown to encompass more than 15 different models.



DS017

Deluxe SOLDAPULLT[®]

- "The Original" Deluxe desoldering tool
- Designed for heavy duty, high volume applications
- High efficiency, durable construction
- Retractable shaft guide for portability and easy storage
- Replacement Tip: SRT12



PT209

SOLDAPULLT[®] III

- Lightweight, petite barrel for smaller hands
- PT209 is a micro-tip model
- Replacement Tip: MRT16



PT109

SOLDAPULLT[®] III

- Lightweight, petite barrel for smaller hands
- Replacement Tip: SRT12



US240

Universal SOLDAPULLT[®]

- Delivers powerful vacuum impulse
- Single-handed loading system
- Adjustable loading stroke to reduce hand strain
- US240 is a micro-tip model
- Replacement Tip: MRT16



US140

Universal SOLDAPULLT[®]













- Delivers powerful vacuum impulse
- Single-handed loading system
- Adjustable loading stroke to reduce hand strain
- US240 is a micro-tip model
- Replacement Tip: SRT12



US340

Low Static Universal SOLDAPULLT[®]

- Powerful vacuum
- Low static barrel
- Single-handed loading system
- Adjustable loading stroke to reduce hand strain
- Replacement Tip: LS197

Replacement Tip	SOLDAPULLT [®]						
	DS017	PT109	PT209	PT309	US140	US240	SS750
LRT14 i.d.= .125"/3.2mm L = 2.00"/50.8mm							
MRT16 i.d.= .084"/2.4mm L = .536"/13.6mm							
SRT12 i.d.= .125"/3.2mm L = .536"/13.6mm							
SRT751 i.d.= .100"/2.5mm L = .875"/22.2mm							
O-Ring	Use OL 111 O-Ring Lube for Lubrication						
OB207 (use for replacement tiplot)							
ODS31							
OSB32							
OS130							

SOLDAPULLTS



SS750LS

Low Static Universal SOLDAPULLT[®]

- Powerful vacuum
- Low static barrel
- Single-handed loading system
- Adjustable loading stroke to reduce hand strain
- Replacement Tip: LS751



SS350

Low Static Universal SOLDAPULLT[®]

- Powerful vacuum
- Low static barrel
- Single-handed loading system
- Adjustable loading stroke to reduce hand strain
- Replacement Tip: LS363



AS196

SILVERSTAT SOLDAPULLT[®]

- Static safe conductive plating
- Designed for heavy duty, high volume applications
- High efficiency, durable construction
- Retractable shaft guide for portability and easy storage
- Replacement Tip: LS197



SS343

Static-Safe Challenger SOLDAPULLT[®]

- Long tapered tip for greater visibility
- One handed operation
- Designed for tight, heavily populated circuit boards
- Replacement Tip: LS915











DS017LS

Low Static Deluxe SOLDAPULLT[®]

- Molded from conductive material
- High efficiency and durable construction
- Retractable shaft guide for portability and easy storage
- Replacement Tip: LS197



Replacement Tip	SOLDAPULLT [®]				
	AS196	DSO17LS	US340	SS350	SS750LS
LS197 i.d.= .125"/3.2mm L = .536"/13.6mm					
LS363 i.d.= .125"/3.2mm L = .536"/13.6mm					
LS751 i.d.= .100"/2.5mm L = .875"/22.2mm					
O-Ring	Use OL 111 O-Ring Lube for Lubrication				
ODS31					
OB207 (use for replacement tiplet)					
OS130					

TWEEZERS

TWEEZER KITS

Edsyn Tweezer Kits contain 6 of our most popular styles in both standard and ergonomic versions. Choose between our Swiss or Italian-Grade tweezer kits. All tweezers are Stainless Steel and Anti-Acid, Anti-Magnetic. All Ergonomic grips are static-safe. Red for Swiss, Green for Italian-Grade materials.



EP-SA-I-KIT1

Italian-Tweezer Kit (Set of 6)
Kit includes EP00-SA, EP2A-SA, EP3C-SA,
EP5-SA, EP7-SA and EPAA-SA



STATIC-SAFE-ERGONOMIC



EP-EG-I-KIT1

Static-Safe Italian-Grade Ergonomic
Tweezer Kit (Set of 6) Kit includes
EP00-SA-I-EG, EP2A-SA-I, EP3C-SA-I,
EP5-SA-I EP7-SA-I and EPAA-SA-I-EG



EP-SA-KIT1

Swiss Tweezer Kit (Set of 6) Kit includes
EP00-SA-SW, EP2A-SA-SW, EP3C-SA-SW,
EP5-SA-SW, EP7-SA-SW and EPAA-SA-SW



STATIC-SAFE-ERGONOMIC



EP-EG-KIT1

Static-Safe Swiss Ergonomic Tweezer Kit
(Set of 6) Kit includes EP00-SA-EG,
EP2A-SA-EG EP3C-SA-EG, EP5-SA-EG,
EP7-SA-EG and EPAA-SA-EG



TWEEZERS

SURFACE-MOUNT TWEEZERS

These Italian-Grade Surface Mount Tweezers are available in many different shapes, angles and paddle sizes. Choose the one that best fits your application. These tweezers will help in holding, positioning, and handling a wide variety of surface mount devices.



EP103-SA

Italian-Grade SMD Tweezers with 30° Angled Tip and Paddle-Shaped Points.
L: 4.5" (114mm)



EP104-SA

Italian-Grade SMD Tweezers with Angled Tip and Paddle-Shaped Points.
L: 4.5" (114mm)



EP105-SA

Italian-Grade SMD Tweezers with Straight Tips and Paddle-Shaped Points.
L: 4.5" (114mm)



EP106-SA

Italian-Grade SMD Tweezers with Angled Paddle-Shaped Tips
L: 4.5" (114mm)



EP107-SA

Italian-Grade SMD Tweezers with 30° Angled Tip and Paddle-Shaped Points.
L: 4.5" (114mm)



EP108-SA

Italian-Grade SMD Tweezers with Straight Tips and a Groove in the Point to protect delicate parts.
L: 4.5" (114mm)



EP109-SA

Italian-Grade SMD Tweezers with Straight Tips and Angled Points.
L: 4.5" (114mm)



EP110-SA

Italian-Grade SMD Tweezers with Straight Tip and Grooved Points to hold parts stable.
L: 4.5" (114mm)



EP112-SA

Italian-Grade SMD Tweezers with 30° Angled Tip and Paddle-Shaped Points.
L: 4.5" (114mm)



TWEEZERS

CARBON TIP TWEEZERS



EP159A-EG

Swiss Tweezers with Carbofib Tips and Red Ergo Grips.
Tip Dia: .019" (0.5mm)
L: 5.0" (127mm)

EP159A-RT

Swiss Tweezers with Replaceable Carbofib Tips.
Tip Dia: .11 in
L: 5" (127mm)

EP159A-RT-EG

Swiss Tweezers with Replaceable Carbofib Tips and Red Ergo Grips.
L: 5" (127mm)

EP169A-RT-EG

Swiss Tweezers with Replaceable Carbofib Tips and Red Ergo Grips.
Tip Dia: .08" (2mm)
L: 4.75" (120 mm)



PRECISION ELECTRONIC TWEEZERS



EP2-MG

Swiss Medical Grade Tweezers with Tapered Tips, Fine Points.
L: 4.75" (121mm)

EP2-SA-SW

Swiss Tweezers with Tapered Tips, Fine Points. L: 4.75" (121mm)

EP2-SA

Italian-Grade Tweezers with Tapered Tips and Medium Points.
L: 4.75" (121mm)

EP2-MG-EG

Swiss Medical-Grade Tweezers with Tapered Tips, Fine Points and Blue Ergo Handle L: 4.75" (121mm)



CUTTING TWEEZERS



EP15AGW

Angled Head Cutting Tweezers.
L: 4.5" (114mm) Swiss Made

EP15AGW-I

Italian-Grade Angled Head Cutting Tweezers. L: 4.5" (114mm)

EP15AGW-EG

Angled Head Cutting Tweezers with Red Ergo Grips.
L: 4.5" (114mm) Swiss Made

EP15AGW-I-EG

Italian-Grade Angled Head Cutting Tweezers with Green Ergo Grips.
L: 4.5" (114mm)

EP15AGW-LF

Italian-Grade Angled Head Cutting Tweezers with Green Ergo Grips and RoHS Logo. L: 4.5" (114mm)



EP2A-MG

Swiss Medical Grade Tweezers with Flat Tips, Rounded Points.
L: 4.5" (114.3mm)

EP2A-SA-SW

Swiss Tweezers with Flat Tips, Rounded Points. L: 4.75" (121mm)

EP2A-SA

Swiss Medical Grade Tweezers with Flat Tips, Rounded Points.
L: 4.5" (114.3mm)

EP2A-SA-EG

Swiss Tweezers with Flat Tips, Rounded Points and Red Ergo Grips.
L: 4.75" (121mm)

EP2A-SA-I-EG

Italian-Grade Tweezers with Flat Tips, Rounded Points and Green Ergo Grips. L: 4.75" (121mm)

EP2A-LF

Italian-Grade Tweezers with Flat Tips, Rounded Points, Green Ergo Grips and RoHS Logo.
L: 4.75" (121mm)



TWEEZERS

PRECISION ELECTRONIC TWEEZERS



EP3-SA

Italian-Grade Tweezers with Straight Tips and Fine Points. L: 4.75" (120mm)

EP3-SA-SW

Swiss Tweezers with Straight Tips and Fine Points. L: 4.75" (120mm)

EP3-SA-EG

Swiss Tweezers with Straight Tips, Fine Points and Red Ergo Grips. L: 4.75" (120mm)

EP3-MG

Swiss Medical-Grade Tweezers with Straight Tips and Fine Points. L: 4.75" (120mm)

EP3-MG-EG

Swiss Medical-Grade Tweezers with Straight Tips, Fine Points and Blue Ergo Grips Handle. L: 4.75" (120mm)



EP4-SA-SW

Swiss Tweezers with Tapered Tips and Fine Points. L: 4.75" (120mm)

EP4-SA-EG

Swiss Tweezers with Tapered Tips and Fine Points and Red Ergo Grips. L: 4.75" (120mm)



EP3C-SA

Italian-Grade Tweezers with Straight Tips, Fine Points L: 4.25" (108mm)

EP3C-SA-SW

Swiss Tweezers with Straight Tips, Fine Points. L: 4.25" (108mm)

EP3C-SA-EG

Swiss Tweezers with Straight Tips, Fine Points and Red Ergo Grips. L: 4.25" (108mm)

EP3-SA-I-EG

Italian-Grade Tweezers with Straight Tips, Fine Points and Green Ergo Grips. L: 4.25" (108mm)

EP3C-MG

Swiss Medical-Grade Tweezers with Straight Tips, Fine Points. L: 4.25" (108mm)

EP3C-LF

Italian-Grade Tweezers with Straight Tips, Fine Points, Green Ergo Grips and RoHS Logo. L: 4.25" (108mm)



EP5-SA

Italian-Grade Tweezers with Extra-Fine Tips, High Precision Points. L: 4.5" (114mm)

EP5-SA-SW

Swiss Tweezers with Extra Fine Tips and High Precision Points. L: 4.5" (114mm)

EP5-SA-EG

Swiss Tweezers with Extra-Fine Tips, High Precision Points and Red Ergo Grips. L: 4.5" (114mm)

EP5-SA-I-EG

Italian-Grade Tweezers with Extra-Fine Tip, High-Precision Points and Green Ergo Grips. L: 4.5" (114mm)

EP5-MG

Swiss Medical-Grade Tweezers with Extra Fine Tips and High Precision Points. L: 4.5" (114mm)

EP5-MG-EG

Swiss Medical-Grade Tweezers with Extra-Fine Tips, High Precision Points and Blue Ergo Grips L: 4.5" (114mm)

EP5-LF

Italian-Grade Tweezers with Straight Tips, Fine Points, Green Ergo Grips and RoHS Logo. L: 4.5" (114mm)



TWEEZERS

PRECISION ELECTRONIC TWEEZERS



EP5A-MG
Swiss Medical-Grade Tweezers with Offset Extra-Fine Tips and High Precision Points. L: 4.5" (114mm)

EP5A-SA-SW
Swiss Tweezers with Offset Extra Fine Tips and High Precision Points. L: 4.5" (114mm)



EP7B-SA
Italian-Grade Tweezers with Curved Serrated Tips and Fine Points. L: 4.5" (114mm)

EP7B-SA-SW
Swiss Tweezers with Fine Curved Tips and Serrated Points. L: 4.5" (114mm)





EP5B-SA-SW
Swiss Tweezers with Oblique Angled Tips and High Precision Points. Great for microscopic work. L: 4.5" (114mm)



EPAA-SA
Italian-Grade Tweezers with Straight Tips and Medium Points. L: 5" (127mm)

EPAA-SA-SW
Swiss Tweezers with Straight Tips and Medium Points. L: 5" (127mm)

EPAA-SA-EG
Swiss Tweezers with Straight Tips, Medium Points, and Red Ergo Grips. L: 5" (127mm)

EP7-MG
Swiss Medical-Grade Tweezers with Fine Curved Tips and Precision Points. L: 4.5" (114mm)

EP7-SA-SW
Swiss Tweezers with Fine Curved Tips and Precision Points. L: 4.5" (114mm)

EP7-SA
Italian-Grade Tweezers with Fine Curved Tips and Precision Points. L: 4.5" (114mm)



EPAA-SA-I-EG
Italian-Grade Tweezers with Straight Tips, Medium Points and Green Ergo Grips. L: 5" (127mm)

EPAA-LF
Italian-Grade Tweezers with Straight Tips, Medium Points, Green Ergo Grips and RoHS Logo. L: 5" (127mm)



EP7-SA-EG
Swiss Tweezers with Fine Curve Tips, Precision Points and Red Ergo Grips. L: 4.5" (114mm)

EP7-SA-I-EG
Italian-Grade Tweezers with Fine Curved Tips, Precision Points and Green Ergo Grips. L: 4.5" (114mm)

EP7-LF
Italian-Grade Tweezers with Fine Curved Tips, Precision Points, Green Ergo Grips and RoHS Logo. L: 4.5" (114mm)



EP51-SA-SW
Swiss Tweezers with Oblique Angle Tips and Extra-Fine Points. L: 4.5" (114mm)

TWEEZERS

PRECISION ELECTRONIC TWEEZERS



EP65A-SA-SW

Swiss Tweezers with Long Oblique Angle Tips and High Precision Points. L: 4.5" (114mm)



EP231-SA

Italian-Grade Tweezers with Straight Tips and Medium Serrated Points. L: 4.5" (114mm)



EPAC-SA

Italian-Grade Tweezers with Strong, Straight Tips and Medium Points. L: 4.5" (114mm)



EPOC-SA-SW

Swiss Tweezers with Straight Tips and Fine Points. L: 4.5" (114mm)



EPOC-SA

Italian-Grade Tweezers with Straight Tips and Fine Points. L: 4.5" (114mm)

EPOC-SA-EG

Italian-Grade Tweezers with Straight Tips, Fine Points and Red Ergo Grips. L: 4.5" (114mm)



EPOO-SA-SW

Swiss Tweezers with Strong Tips and Strong Points L: 4.75" (120mm)

EPOO-SA

Italian-Grade Tweezers with Strong Tips and Strong Points. L: 4.75" (120mm)

EPOO-SA-EG

Swiss Tweezers with Strong Tips and Red Ergo Grips. L: 4.75" (120mm)

EPOO-SA-I-EG

Italian-Grade Tweezers with Strong Tips and Strong Points and Green Ergo Grips. L: 4.75" (120mm)

EPOO-LF

Italian-Grade Tweezers with Strong Tips, Strong Points, Green Ergo Grips and RoHS Logo. L: 4.75" (120mm)



EPOOD-SA-SW

Swiss Tweezers with Strong Tips and Strong, Serrated Points. L: 4.75" (120mm)

EPOOD-SA

Italian-Grade Tweezers with Strong Tips and Strong, Serrated Points. L: 4.75" (120mm)



EPSS-SA

Italian-Grade Tweezers with Long Straight Tips and Precision Points. L: 5.3" (135mm)



EPSSF-SA-SW

Extra-Long Swiss Tweezers with Narrow Body and Precision Points. L: 5.5" (140mm)

EPSSF-SA-EG

Extra-Long Swiss Tweezers with Narrow Body & Precision Points and Red Ergo Grips. L: 5.5" (140mm)



TWEEZERS

REVERSE-ACTION TWEEZERS



EPR133CA-SA
Reverse Action Chip-Handling
Tweezers with Black ESD Tips.



EPR1430A-SA
Reverse Action Chip-Handling
Tweezers with Delrin Tips.



EPR29-SA-MG
Swiss Medical Grade Reverse-Action
Tweezers with Straight Tips.
L: 6.5" (165mm)



EPR5-SA-MG
Swiss Medical Grade
Reverse-Action Tweezers with Extra
Fine Tips and High-Precision Points.
L: 4.5" (114mm)



EPR7-SA-MG
Swiss Medical Grade Reverse-Action
Tweezers with Fine Curved Tips
and Precision Points.
L: 4.50" (114mm)

MINITURE TWEEZERS



EPM2A-SA-SW
Miniature Swiss Tweezers with Flat
Tips and Rounded Points.
L: 4.75" (121mm)



EPM3-SA-SW
Miniature Swiss Tweezers with
Straight Tips and Fine Points.
L: 2.75" (70mm)



EPM4-SA-SW
Miniature Swiss Tweezers with
Tapered Tips and Fine Points.
L: 2.75" (70mm)



EPM5-SA-SW
Miniature Swiss Tweezers with Extra
Fine Tips and High- Precision Points.
L: 3.25" (82mm)



EPM00D-SA-SW
Miniature Swiss Tweezers with
Strong Tips and Strong Serrated
Points. L: 3.50" (89mm)



Regular Bevel



Flush Cut

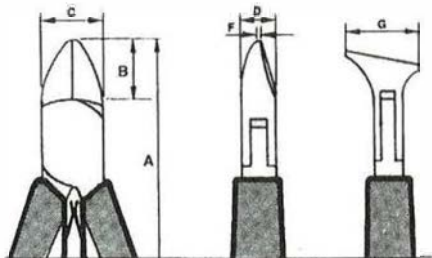

OVAL HEAD

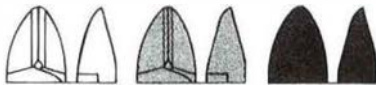

TAPERED HEAD

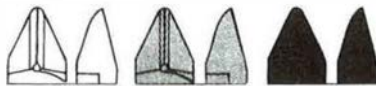

TAPERED & RELIEVED HEAD

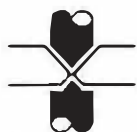
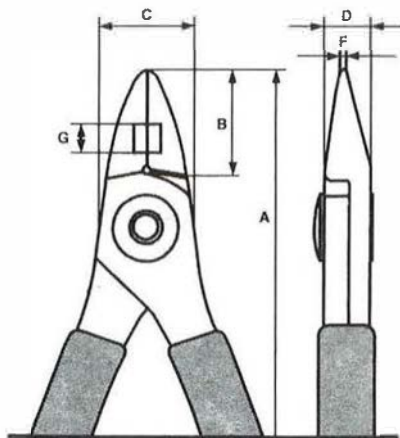
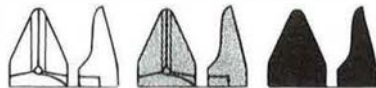

Regular Bevel



Flush Cut



Full Flush Cut

EDSYN CUTTERS & PLIERS

High quality precision cutters and pliers for electronics and telecommunication industries and fine mechanics.

LARSON SERIES 3000

A high quality series of cutters and holding/forming pliers, the SERIES 3000 has a riveted box joint and comes with standard black ESD safe handles. Material: Selected high quality Swedish Steel.

LARSON SERIES 9000

A high quality series of diagonal cutters and strippers, the SERIES 9000 is available in three different sizes, jaw shapes and cutting edges. All types come with standard black ESD safe handles and are made with a screw type precision joint.

MANUFACTURING

All cutters and pliers are made from forged blanks. The Series 9000 pliers and cutters is shaped by an advanced grinding technique in program-controlled machines and are made with an adjustable precision joint.

The Series 3000 is produced by milling in program-controlled machines and finished by hand grinding. The tools are in a box joint design and assembled using a special riveting technique, minimizing the risk of play.

HANDLES

All cutters and pliers have ergonomic handles and are made with black ESD safe protective material, which complies with international ESD standards.

Handles are marked with product numbers, logo-type and the letters "ESD". Cutters are marked with cutting capacity.

SPRINGS

All cutters and pliers have specially designed return spring for precise handling and are easily replaceable if necessary.

PLIERS

EDSYN BRAND

All EDSYN brand pliers are made in the USA to the highest specifications. Most tools are available in both the standard length handles as well as the longer, Ergonomic handles. Just add the "-EG" to a part number for the Ergonomic version. All handles are Static-Safe, Cushion Grips.



KP2843
Static-Safe Round Nose Plier.
L: 5.3" (135 mm) Made in USA

KP2843EG
Static-Safe Round Nose Plier with
Ergo Grips. L: 6.13" (156mm)
Made in USA



KP11-EG
Static-Safe Chain Nose Plier with
Smooth Jaws and Ergo Grips.
L: 4.75" (119mm) Made in USA



KP324
Static-Safe Slim Needle Nose Plier
with Smooth Jaws.
L: 5.36" (136mm) Made in the USA

KP324-EG
Static-Safe Slim Needle Nose Plier
with Smooth Jaws and Grips.
L: 6.21" (158mm) Made in USA



KP14-EG
Static-Safe Extra-Long Nose Plier
with Smooth Jaws and Ergo Grips.
Jaw Length: 2.19" (56mm)
L: 7.35" (186mm) Made in USA



KP325
Static-Safe Slim Needle Nose Plier
with Serrated Jaws.
L: 5.36" (136mm) Made in USA

KP325-EG
Static-Safe Slim Needle Nose Plier
with Serrated Jaws and Ergo Grips.
L: 6.21" (158mm) Made in USA



KP21
Static-Safe Needle Nose Plier with
Serrated Jaws, Beveled Edges and
Cushion Grips.
L: 4.5" (114mm) Made in USA



PLIERS

EDSYN BRAND PLIERS



KP44A

Static-Safe Chain Nose Plier with Smooth Jaws. L: 4.61" (117mm)
Made in USA

KP44A-EG

Chain Nose Plier with Smooth Jaws and Ergo Grips. Static-Safe, Made in the USA



KP47-S

Static-Safe Needle Nose Plier with Smooth Jaws and Black Ergo Grips. L: 6.13" (156mm)
Made in USA



KP49A-EG

Static-Safe Chain Nose Plier with Smooth Jaws and Ergo Grips. L: 6.86" (174mm) Made in USA

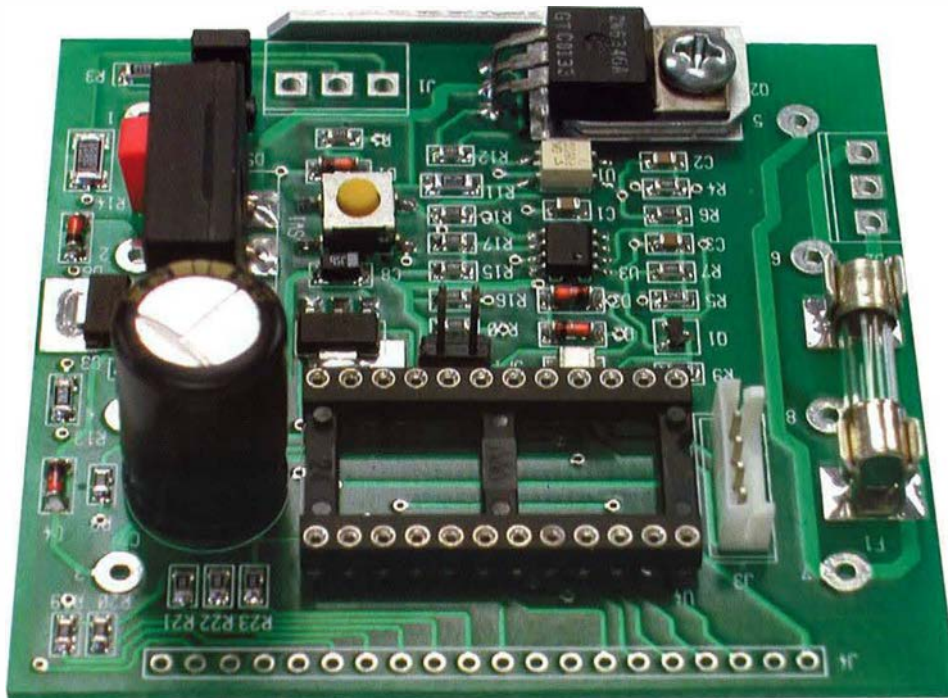

PLIERS

LARSON BRAND

Pliers are made in Sweden and offer the best in European design and quality. Simple, quality products for the professional. Handles are static-safe molded plastic.



KP3011
Flat Nose Plier with Smooth Jaws.
L: 4.6" (116 mm)



KP3021
Snipe Nose Plier with Smooth Jaws.
L: 4.6" (116 mm)

KP3022
Snipe Nose Plier with Serrated
Jaws. L: 4.6" (116mm)



KP3023
Long Nose Snipe Plier with Smooth
Jaws. L: 5" (128mm)

KP3024
Long Nose Snipe Plier with Serrated
Jaws. L: 5" (128mm)



KP3032
Bent Snipe Nose Plier with Smooth
Jaws, Tip Bent @ 60°.
L: 4.9" (125 mm)



KP3041
Round Nose Plier. L: 4.6" (116 mm)



PLIERS

EDSYN VALUE BRAND

Pliers are designed with the enthusiast and occasional user in mind. EDSYN Value Brand pliers are of good quality with exceptional pricing. These pliers have static-safe molded handles.



KP102
Miniature Long Nose Plier with Serrated Jaws. L: 5.6" (142 mm)



KP709
Chain Nose Plier with Serrated Jaws. L: 4.9" (125mm)



KP105
Miniature Bent Nose Plier with Serrated Jaws. L: 5.4" (138 mm)



KP714
Extended Long Nose Plier with Serrated Jaws. L: 5.9" (150 mm)



KP707
Long Nose Plier with Smooth Jaws. L: 4.9" (125 mm)



KP794
Bent Nose Plier with Smooth Jaws. L: 3.9" (100 mm)

CUTTERS

EDSYN BRAND OVAL HEAD CUTTERS

The Oval Head Cutters provide the most strength and have longer service lives. This style is used for most applications. Available in three different cutting styles— Bevel, Flush and Full Flush.

See page 13 for Description of Cuts.



KP111
Static-Safe Oval Head Flush Cutter.
L: 4.25" (108mm) Made in USA

KP111-EG
Static-Safe Oval Head Flush Cutter
with Ergo Grips. L: 5.65" (144mm)
Made in USA



KP413-EG
Static-Safe Slim Oval Head
Flush Cutter with Ergo Grips.
L: 5.65" (144mm) Made in USA



KP511
Static-Safe Oval Head Flush Cutter.
L: 4.93" (125mm) Made in USA

KP511-EG
Static-Safe Oval Head Flush Cutter
with Ergo Grips.
L: 5.78" (147mm) Made in USA



KP7141-EG
Static-Safe Oval Head Flush Cutter
with Ergo Grips. L: 5.5" (140mm)
Made in USA



KP112-EG
Static-Safe Oval Head Ultra- Flush
Cutter with Ergo Grips.
L: 5.65" (144mm) Made in USA



KP7151-EG
Static-Safe Oval Head Flush Cutter
with Ergo Grips. L: 5.5" (140mm)
Made in USA



KP410-EG
Static-Safe Oval Head Bevel Cutter
with Ergo Grips. L: 5.65" (144mm)
Made in USA



KP411-EG
Static-Safe Oval Head Flush Cutter
with Ergo Grips. L: 5.65" (144mm)
Made in USA



CUTTERS

EDSYN BRAND OVAL HEAD CUTTERS



KP7240-EG
Static-Safe Oval Head Flush Cutter
with Ergo Grips. L: 5.5" (140mm)
Made in USA



KP8142
Static-Safe Full Flush Cutter with
Oval Head for Copper Wire:
.004in. (.1mm) - .039in.(1mm)
L: 4.3" (110mm) Made in USA



KP8130
Static-Safe Oval Head Bevel Cutter
with Ergo Grips. L: 4.3" (110mm)
Made in USA



KP8150
Static-Safe Oval Head Bevel Cutter.
L: 4.7" (119mm) Made in USA



KP8150-EG
Static-Safe Oval Head Bevel Cutter
with Ergo Grips. L: 5.5" (140mm)
Made in USA



KP8132
Static-Safe Oval Head Full Flush
Cutter. L: 4.3" (110mm)
Made in USA



KP8132-EG
Static-Safe Oval Head Full Flush
Cutters with Black Ergo Grips.,
L: 5.5" (140mm) Made in USA



KP8160
Static-Safe Oval Head Bevel Cutter.
L: 4.7" (119mm) Made in USA



KP8160-EG
Static-Safe Oval Head Bevel Cutter
with Ergo Grips. L: 5.5" (140mm)
Made in USA



KP8140
Static-Safe Oval Head Bevel Cutter.
L: 4.7" (119mm) Made in USA



KP8140-EG
Static-Safe Oval Head Bevel Cutter
with Ergo Grips. L: 5.5" (140mm)
Made in USA



KP9160-EG
Static-Safe Oval Head Flush Cutter
with Ergo Grips.
L: 6.33" (160mm) Made in USA

CUTTERS

EDSYN BRAND TAPERED HEAD CUTTERS

Tapered Head cutters are designed for applications that require cutting in tight quarters and getting between components or component leads.

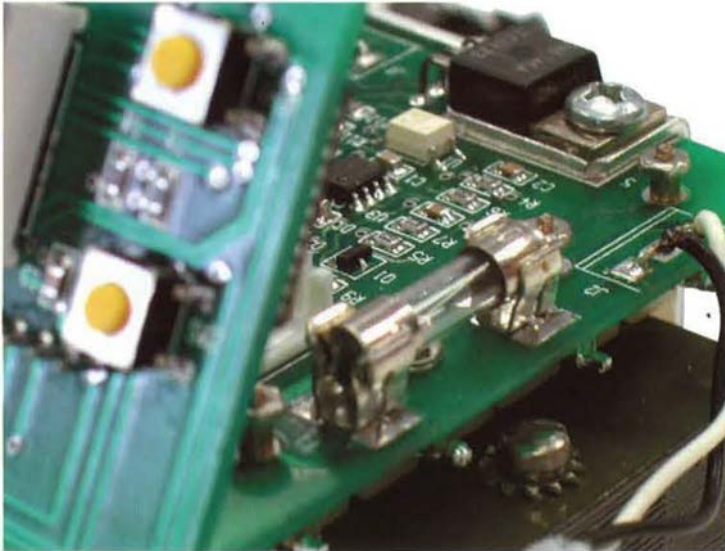

KP421-EG
Static-Safe Slim Tapered Head Full-Flush Cutter with Ergo Grips.
L: 5.65" (144mm) Made in USA



KP515
Static-Safe Tapered Head Flush Cutter. L: 4.93" (125mm)
Made in USA

KP515-EG
Static-Safe Tapered Head Flush Cutter with Ergo Grips.
L: 5.78" (147mm)
Made in USA



KP121-EG
Static-Safe Slim Tapered Head Full Flush Cutter with Ergo Grips.
L: 5.65" (144mm) Made in USA



KP620-EG
Static-Safe Slim Tapered Head Flush Cutter with Ergo Grips.
L: 6.33" (161mm) Made in USA



KP420-EG
Static-Safe Slim Tapered Head Flush Cutter with Ergo Grips.
L: 5.65" (144mm) Made in USA



KP621-EG
Static-Safe Slim Tapered Head Full-Flush Cutter with Ergo Grips.
L: 6.33" (161mm) Made in USA

CUTTERS

EDSYN BRAND TAPERED HEAD CUTTERS



KP677-EG

Static-Safe Tapered Head Flush Cutter with Ergo Grips.
L: 5.65" (144mm) Made in USA



KP7244-EG

Static-Safe Tapered Head Flush Cutter with Ergo Grips.
L: 5.5" (140mm) Made in USA



KP7137-EG

Static-Safe Slim Tapered Short Nose Full Flush Cutter with Ergo Grips.
L: 5.5" (140mm) Made in USA



KP8138-EG

Static-Safe Full Flush Cutter with Tapered and Relieved Jaws for Copper Wire: .004" (.1mm) - .031" (.8mm) and Ergo Grips.
L: 5.5" (140mm) Made in USA



KP7143-EG

Static-Safe Tapered Head Bevel Cutter with Ergo Grips.
L: 5.5" (140mm) Made in USA



KP8147

Static-Safe Flush Cutter with Tapered and Relieved Jaws for Copper Wire: .007in (.2mm) - .039in (1mm)
L: 4.3" (110mm) Made in USA



KP7145-EG

Static-Safe Tapered Head Ultra-Full Cutter with Ergo Grips.
L: 5.5" (140mm) Made in USA



KP8148

Static-Safe Full Flush Cutter with Tapered and Relieved Jaws and pointed head for Copper Wire: .007" (.2mm) - .039" (1mm)
L: 4.7" (119mm) Made in USA



KP7147-EG

Static-Safe Tapered and Relieved Head Flush Cutter with Ergo Grips.
L: 5.5" (140mm) Made in USA



KP8148-EG

Static-Safe Full Flush Cutter with Tapered and Relieved pointed head with Ergo Grips.
L: 5.5" (140mm) Made in USA



CUTTERS

EDSYN BRAND TAPERED HEAD CUTTERS



KP8153
Static-Safe Tapered Head Bevel
Cutter. L: 4.7" (119mm)
Made in USA



KP8153-EG
Static-Safe Tapered Head Bevel
Cutter with Ergo Grips.
L: 5.5" (140mm) Made in USA



KP8158-EG
Static-Safe Full Flush Cutter with
Tapered and Relieved Jaws for
Copper Wire:
.004in. (.1mm) - .031in. (.8mm)
and Ergo Grips.
L: 5.5" (140mm) Made in USA



KP8163
Static-Safe Tapered Head
Bevel Cutter.
L: 4.7" (119mm) Made in USA



KP8163-EG
Static-Safe Tapered Head
Bevel Cutter with Ergo Grips.
L: 5.5" (140mm) Made in USA



KP8165-EG
Static-Safe Tapered Head Ultra-Full
Flush Cutter with Ergo Grips.
L: 6.33" (160mm) Made in USA



EDSYN BRAND TIP & OBLIQUE CUTTERS



KP171
Static-Safe Long Head
Reverse Angle Full-Flush Cutter.
L: 5.73" (145mm) Made in USA



KP423
Static-Safe Slim Oval
Head Full-Flush Tip Cutter.
L: 5.63" (143mm) Made in USA



KP570
Static-Safe Fine Relieved
Head Full-Flush Tip Cutter.
L: 5.14" (131mm) Made in USA



KP7149-EG
Static-Safe Long Nose Ultra-Flush
Tip Cutter with Fine, Relieved Head
and Ergo Grips. L: 6" (152mm)
Made in USA

CUTTERS

EDSYN BRAND TIP & OBLIQUE CUTTERS



KP582-EG
Static-Safe Oblique 45° Full-Flush
Long Nose Cutter with Ergo Grips.
L: 5.84" (148mm) Made in USA



KP8149-EG
Static-Safe Flush Tip Cutter with
Ergo Grips.
L: 5.5" (140mm) Made in USA

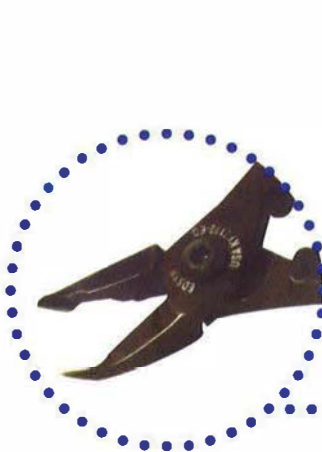

KP7182
Static-Safe Angled 45° Full-Flush
End Cutter. L: 5" (127mm)
Made in USA

KP7182-EG
Static-Safe Angled 45° Full-Flush
End Cutter with Ergo Grips.
L: 5.89" (150mm) Made in USA

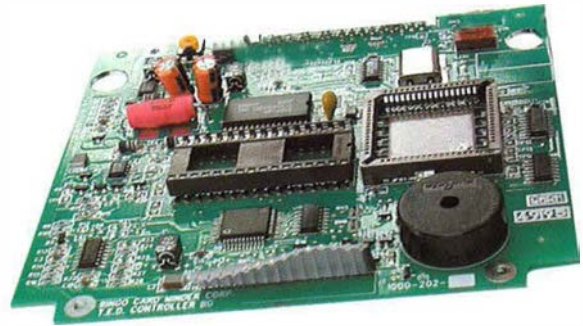

EDSYN BRAND STAND-OFF CUTTERS



KP120
Static-Safe Long Nose,
Ultra-Flush Stand-Off Cutter.
Stand-Off Distance: .04" (1mm)
L: 5" (127mm) Made in USA



KP120-EG
Static-Safe Long Nose,
Ultra-Flush Stand-Off Cutter.
Stand-Off Distance: .04" (1mm)
L: 5.9" (150mm) Made in USA



KP120-.02-EG
Static-Safe Long Nose
Ultra-Flush Stand-Off Cutter.
Stand-Off Distance: .02" (.5mm)
L: 5.9" (150mm) Made in USA

KP120-.01-EG
Static-Safe Long Nose,
Ultra-Flush Stand-Off Cutter.
Stand-Off Distance: .01" (.25mm)
L: 5.9" (150mm) Made in USA

KP120-.06-EG
Static-Safe Long Nose,
Ultra-Flush Stand-Off Cutter.
Stand-Off Distance: .06" (1.5mm)
L: 5.9" (150mm) Made in USA

CUTTERS

LARSON BRAND CUTTERS

Cutters are made in Sweden and offer the best in European design and quality. Simple, quality products for the professional. Handles are static-safe molded plastic.



KP3054
Flush Cutter with Pointed Jaw
for Copper Wire:
.01" (.35 mm) - .049" (1.25 mm)
L: 4.2" (107 mm)



KP3055
Regular Bevel Cutter with Pointed
Jaws for Copper Wire:
.01" (.35 mm) - .049" (1.25 mm)
L: 4.2" (107 mm)



KP3056
Flush Cutter with Pointed and
Relieved Jaws for Copper Wire:
.001in (.35mm) - .039in (1 mm)
L: 4.2" (107 mm)



KP3061
Flush Cut End Cutter for
Copper Wire:
.01" (.35mm) - .039" (1 mm)
L: 4.1" (105 mm)



KP3062
Flush Cutting Oblique End Cutter
Oblique Angle 11° for Copper Wire:
.01" (.35mm) - .039" (1mm)
L: 4.1" (105 mm)



KP3063
Regular Bevel Oblique End Cutter
Oblique Angle 11° for Copper Wire:
.01in (.35mm)- .049in (1.25mm)
L: 4.1" (105 mm)



KP3064
Flush Cutting Oblique End Cutter
with Relieved Jaws Oblique Angle
11° for Copper Wire:
.01in (.35mm) - .039in (1mm) .
L: 4.1" (105 mm)



KP3074
Flush Cutting Oblique End Cutter
Extra Slim 35° Oblique Angle,
for Copper Wire:
.01in (.35mm) - .039in. (1mm)
L: 4.6" (116 mm)



KP3075
Flush Cutting Oblique End Cutter
Extra Slim 45° Oblique Angle,
for Copper Wire:
.01in (.35mm) - .039in. (1mm)
L: 4.6" (116mm)



KP9150
Regular Bevel Cutter with Oval Head
for Copper Wire:
.007" (.2mm) - .049" (1.25 mm)
L: 4.3" (110 mm)

CUTTERS

LARSON BRAND CUTTERS



KP9151
Flush Cutter with Oval Head
for Copper Wire:
.004" (.1mm) - .049"
L: 4.3" (110 mm)



KP9156
Regular Bevel Cutter with Tapered
and Relieved Head for Copper Wire:
.007in. (.2mm) - .039in. (.1mm)
L: 4.3" (110 mm)



KP9152
Flush Cutter with Oval Head
for Copper Wire:
.004" (.1mm) - .049"
L: 4.3" (110 mm)



KP9157
Flush Cutter with Tapered and
Relieved Head for Copper Wire:
.004in (.1mm) - .039in. (.1mm)
L:



KP9153
Regular Bevel Cutter with Pointed
Head for Copper Wire:
.007" (.2mm) - .049" (1.25 mm)
L: 4.3" (110 mm)



KP9158
Full Flush Cutter with Tapered
and Relieved Head for Copper Wire:
.004" (.1mm) - .031" (80 mm)
L: 4.3" (110 mm)



KP9154
Flush Cutter with Tapered Head for
Copper Wire:
.004" (.1mm) - .049" (1.25 mm)
L: 4.3" (110 mm)



KP9350
Regular Bevel Cutter with Oval Head
for Copper Wire:
.012" (.3mm) - .063" (1.6 mm)
L: 4.4" (112 mm)



KP9155
Full Flush Cutter with Tapered Head
for Copper Wire:
.004in. (.1mm) - .039in. (.1mm)
L: 4.3" (110 mm)



KP9351
Flush Cutter with Oval Head for
Copper Wire:
.007" (.2mm) - .063 in. (1.6 mm)
L: 4.4" (112mm)

CUTTERS

LARSON BRAND CUTTERS



KP9352
Full Flush Cutter with Oval Head for Copper Wire:
.007" (.2mm) - .049" (1.25 mm)
L: 4.4" (112 mm)



KP9357
Flush Cutter with Tapered Head for Copper Wire:
.007" (.2mm) - .049" (1.25 mm)
L: 4.4" (112 mm)



KP9353
Regular Bevel Cutter with Tapered Head for Copper Wire:
.012" (.3 mm) - .063" (1.6 mm)
L: 4.4" (112 mm)



KP9358
Full Flush Cutter with Tapered Head for Copper Wire:
.007in. (.2mm) - .039in. (1mm)
L: 4.4" (112 mm)



KP9354
Flush Cutter with Tapered Head for Copper Wire:
.007" (.2 mm) - .063" (1.6 mm)
L: 4.4" (112 mm)



KP9550
Regular Bevel Cutter with Oval Head for Copper Wire:
.015in. (.4mm) - .078in. (2mm)
L: 4.9" (125 mm)



KP9355
Full Flush Cutter with Pointed Head for Copper Wire:
.007" (.2 mm) - .049" (1.25 mm)
L: 4.4" (112 mm)



KP9551
Flush Cutter with Oval Head for Copper Wire:
.02" (.3mm) - .078" (2mm)
L: 4.9" (125 mm)



KP9356
Regular Bevel Cutter with Tapered Head for Copper Wire:
.012" (.3 mm) - .049" (1.25 mm)
L: 4.4" (112 mm)



KP9552
Full Flush Cutter with Oval Head for Copper Wire:
.02" (.3mm) - .063" (1.6mm)
L: 4.9" (125 mm)

LARSON CUTTERS & PLIERS CROSS REFERENCE GUIDE

TOOL TYPE	HEAD SHAPE	CUT	LINDSTROM PN	EDSYN PN
Diagonal Cutter	Oval	Micro Bevel	8140	KP9150
Diagonal Cutter	Oval	Flush	8141	KP9151
Diagonal Cutter	Oval	Ultra Flush	8142	KP9152
Diagonal Cutter	Tapered	Micro Bevel	8143	KP9153
Diagonal Cutter	Tapered	Flush	8144	KP9154
Diagonal Cutter	Tapered	Ultra Flush	8145	KP9155
Diagonal Cutter	Tapered/Relieved	Micro Bevel	8146	KP9156
Diagonal Cutter	Tapered/Relieved	Flush	8147	KP9157
Diagonal Cutter	Tapered/Relieved	Ultra Flush	8148	KP9158
Diagonal Cutter	Oval	Micro Bevel	8150	KP9350
Diagonal Cutter	Oval	Flush	8151	KP9351
Diagonal Cutter	Oval	Ultra Flush	8152	KP9352
Diagonal Cutter	Tapered	Micro Bevel	8153	KP9353
Diagonal Cutter	Tapered	Flush	8154	KP9354
Diagonal Cutter	Tapered	Ultra Flush	8155	KP9355
Diagonal Cutter	Tapered/Relieved	Micro Bevel	8156	KP9356
Diagonal Cutter	Tapered/Relieved	Flush	8157	KP9357
Diagonal Cutter	Tapered/Relieved	Ultra Flush	8158	KP9358
Diagonal Cutter	Oval	Micro Bevel	8160	KP9550
Diagonal Cutter	Oval	Flush	8161	KP9551
Diagonal Cutter	Oval	Ultra Flush	8162	KP9552
Diagonal Cutter	Tapered/Relieved	Flush	7191	KP3056
End Cutter	Oblique/Relieved	Bevel		KP3064
End Cutter	Oblique 35°	Flush		KP3074
End Cutter	Oblique 45°	Flush	8248	KP3075
Flat Nose Plier		Smooth Jaws	7490	KP3011
Round Nose Plier		Smooth Jaws	7590	KP3041
Long Nose Plier	Snipe Nose	Smooth Jaws	7890	KP3023
Long Nose Plier	Snipe Nose	Serrated Jaws	7891	KP3024
Bent Nose Plier	60° Bent Tip	Smooth Jaws	7892	KP3032

CUTTERS

EDSYN VALUE LINE CUTTERS



KP170
Micro-Shear Flush Cutter with Static-Safe Cushioned Grips and Non-Reflective Cutting Head. Flush Cuts Soft Copper Wire up to 20 AWG. L: 5.1" (130mm)



KP101
Micro Flush Nippers 5" (126 mm)



KP710
Diagonal Bevel Cutter Carbide Edge. L: 6.1" (155 mm)



KP2175
Static-Safe Maxi-Shear Flush Cutters for Soft Wire to 14AWG. L: 5.85" (148mm) Made in USA



KP712
Diagonal Flush Cutter Carbide Edge. L: 6.1" (155 mm)

SCREWDRIVERS



EDSYN Screwdrivers offer a great value.
Strong tips and comfortable, ergonomic grips.

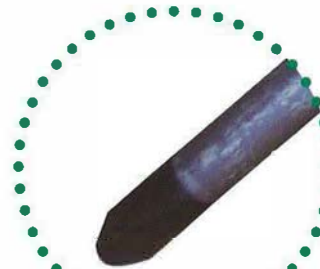

EA62P
Phillips Screwdriver #2
9-1/2" (240 mm)



EA31S
Slotted Flat Screwdriver
5-1/4" (133 mm)



EA30P
Phillips Screwdriver #0
5-1/4" (133 mm)



EA42S
Slotted Flat Screwdriver
7-1/4" (184 mm)



EA41P
Phillips Screwdriver #1
7-1/4" (184 mm)



EA43S
Slotted Flat Screwdriver
7-1/2" (190 mm)



EA42P
Phillips Screwdriver #2
7-1/2" (190 mm)



EA64S
Slotted Flat Screwdriver
9-1/2" (240 mm)

SCREWDRIVERS

MINI SCREWDRIVER SETS

Always looking for that small screwdriver?
Keep them handy and organized with these convenient kits.



EA001
Mini Screwdriver Set. 6 pc with
Slotted Flat Sizes: 0.8, 1.4, 2.0, 2.4,
2.9, & 3.8 mm



EA395
Precision Mini Screwdriver Set. 6 pc
with Slotted Flat Sizes: 1.0, 1.2, 1.6
& 2mm Phillips Tips #0, #1



EA395C
Mini Screwdriver Set. 6 pc. Tools
have Color-Coded Rotating Heads.
Slotted Flat Sizes: 1.0, 1.6, 2.4 &
3.0 mm Phillips Tips: #0, #1

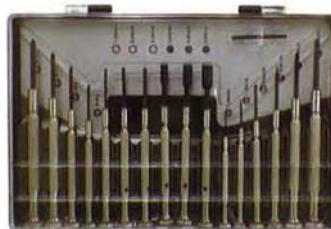

EA397
Mini Screwdriver Set. 16 pc. with
Slotted Flat sizes: 1.0, 1.4, 2.0, 2.4, 3.0 &
3.8mm - Phillips Tips: #00, #0, #1, #1.5
Hex: 1.5, 2.0, 2.5mm
Nut Drivers: 3.0, 4.0, 5.0mm

PRODUCTION AIDS

WIRE STRIPPERS	31
MIRRORS	31
PIN VISES	31
SCISSORS	31
FORCEPS	32
PROBES	32
BRUSHES	33
VACUUM PICKUP UNITS	34
VACUUM NEEDLES	35-36
SMALL PARTS NEEDLES	37-38
SUCTION CUPS	39
DESOLDERING BRAID	39-40

SOLDERING ACCESSORIES	40
MAGNIFIERS	41
PRODUCTION AIDS	42
DISPENSING	43
SYRINGE ADAPTERS	44
DISPENSING NEEDLES	44-51
AIR SYRINGES	51
MANUAL SYRINGES	52
BOTTLES	52-53
FLOW THROUGH BRUSHES	53

*If there's something you need and
it's not listed in our catalog, CALL US!*

PRODUCTION AIDS

WIRE STRIPPERS



EA100

Miller Wire Stripper with Stop Screw Adjustment. Strips and Cuts Wires up to 10AWG. L: 5.1" (130 mm)



EA101S

Miller Wire Stripper with Stop Screw. Adjustment & Spring to keep tool open. Cuts Wires up to 10AWG. L: 5.1" (130 mm)



EA103S

Adjustable Miller Wire Stripper with Cam adjustment. L: 5.3" (135 mm)



EA721

Miller Precision Stripper for Wires 10-20 AWG, with Cam Stop.



EA821

Miller Precision Stripper for Wires 16-26 AWG, with Cam Stop.



MIRRORS

EM15 Shown



EM15

Inspection Mirror with Blue Ergo Handle. Mirror Dia.: 0.866" (22mm) L: 6.5" (165mm) Made in USA

EM18

Inspection Mirror with Blue Ergo Handle. Mirror Dia.: 0.984" (25mm) L: 7" (177.8mm) Made in USA



PIN VISES

EV227B-EG Shown



EV227A-EG

Pin Vise with Blue Ergo Grips. Maximum Chuck Opening: .015" (x.xxmm) L: 3.5" (90mm)

EV227B-EG

Flush Cutter with Pointed and Pin Vise with Blue Ergo Grips. Maximum Chuck Opening: .025" (0.635mm) L: 4" (102mm)

SCISSORS



EA272

Stainless Steel Splicer's Scissors L: 5.1" (130 mm)



ES290

Medium Fine Blade Scissors L: 3.75" (95mm)



ES295

Long Slender Blade Scissors L: 4.12" (105mm)



ES346B

Micro Scissors L: 3.5" (90mm)

PRODUCTION AIDS

FORCEPS



EA20C
Curved Insulated Locking Forceps.
L: 6.3" (160mm)



EA20S
Straight Insulated Locking Forceps.
L: 6.3" (160mm)



PROBES



EA180
Test Probe 4pc-Kit with Stainless Steel Flexible Tip Probes.
L: 5.9" (150 mm)



EP330A
Straight Stainless-Steel Probe.
L: 5.75" (146mm)



EP330A-EG
Straight Stainless-Steel Probe with Blue Ergo Grips. L: 5.75" (146mm)



EP330B
Angled Stainless-Steel Probe.
L: 5.75" (146mm)



EP330B-EG
Angled Stainless-Steel Probe with Blue Ergo Grips. L: 5.75" (146mm)



EP330C
Curved Stainless-Steel Probe.
L: 5.75" (146mm)



EP330C-EG
Curved Stainless-Steel Probe with Blue Ergo Grips. L: 5.75" (146mm)



EP330D
Hook Stainless-Steel Probe.
L: 5.75" (146mm)



EP330D-EG
Hook Stainless-Steel Probe with Blue Ergo Grips. L: 5.75" (146mm)

PRODUCTION AIDS

BRUSHES



EDB12-CK

Aluminum Handle Single Row Hogs Bristle Detail Brush.

EDB12-HH

Aluminum Handle Single Row Horse Hair Detail Brush.

EDB12-SS

Aluminum Handle Single Row Stainless Steel Bristle Detail Brush.

EDB13-CK

Aluminum Handle 3 Row Hogs Bristle Detail Brush.

EDB13-HH

Aluminum Handle 3 Row Horse Hair Detail Brush.

EDB13-SS

Aluminum Handle 3 Row Stainless Steel Bristle Detail Brush.



EDB10-CH

Hogs Bristle Scratch Brush with 4 Rows.

EDB10-HH

Horse Hair Scratch Brush with 4 Rows.

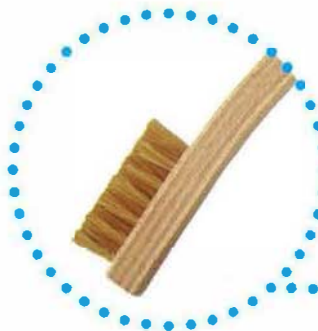

EDB9-CK

Hogs Bristle Scratch Brush with 3 Rows.



EDB9-HH

Horse Hair Scratch Brush with 3 Rows.



EDB8-CK

Applicator Hogs Bristle Brush with Zinc-Plated Handle.

EDB8-HH

Applicator Horse Hair Brush with Zinc-Plated Handle.



EDB11-CK

Heavy-Duty Hogs Bristle Upright Cleaning Brush.

EDB11-HH

Heavy-Duty Horse Hair Upright Cleaning Brush.



EDB6-CK

Double Ended Hogs Bristle Brush (tapered/flat) with Stainless-Steel Handle. (1/4in. Tapered, 1/2in. Flat)

EDB6-HH

Double Ended Horse Hair Bristle Brush with Stainless Steel Handle. (1/4" Tapered, 1/2" Flat)



EDB7-CK

Double Ended Hogs Bristle Brush (tapered/flat) with Stainless-Steel Handle. (3/16" Tapered, 1/4" Flat)

EDB7-HH

Double Ended Horse Hair Bristle Brush with Stainless Steel Handle. (3/16" Tapered, 1/4" Flat)

PRODUCTION AIDS

VACUUM PICK-UP UNITS

The VA175 features new technology and a comfortable, ultra-light weight hand tool that works well on a variety of SMD sizes using air-pressure or vacuum. Positive air pressure causes the component to fly into the pick-up tool thereby lifting and cooling at the same time.



**New
Technology**

VA175

SOLDAVAC® Air and Vacuum Pick-Up System with HB359, LP252 and SPA25. Requires Shop Air (60-90 psi)



LP20

PIXTER® Portable Vacuum Handling Tool. Includes LN251 Straight and LN260 Angled Lifting Needles.



LP200

SOLDAVAC® Lifter by Pen-Vac Portable Vacuum Pick-Up Tool. Includes LN250, LN260 and LN270 Angled Lifting Needles.



VA251

PIXTER® Self-Contained High Performance Vacuum System.



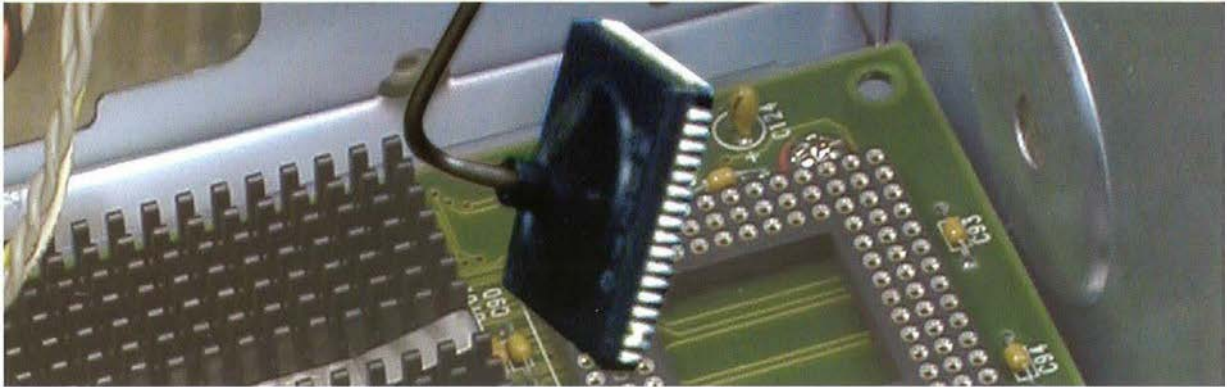

VACUUM NEEDLES

LN240 Small Angled Lifting Needle with SP093 Static-Safe Silicon Suction Cup.
O.D.: .09375" (2.4 mm) L: .50" (12.7 mm)



LN241 Small Straight Lifting Needle with SP093 Static-Safe Silicon Suction Cup.
O.D.: .09375" (2.4mm) L: .50" (12.7 mm)



LN250 Small Angled Lifting Needle with SP125 Static-Safe Silicon Suction Cup for LP200
O.D.: .125" (3.2 mm) L: .50" (12.7 mm)



LN251 Straight Lifting Needle with SP125 Static-Safe Silicon Suction Cup for LP200.
O.D.: .125" (3.2 mm) L: .50" (12.7 mm)



LN260 Angled Lifting Needle with SP250 Static-Safe Silicon Suction Cup for LP200.
O.D.: .25" (6.4 mm) L: .50" (12.7 mm)



LN261 Medium Straight Lifting Needle with SP250 Static-Safe Silicon Suction Cup for LP200.
O.D.: .25" (6.4 mm) L: .50" (12.7 mm)



LN270 Large Angled Lifting Needle with SP375 Static-Safe Silicon Suction Cup for LP200.
O.D.: .375" (9.5 mm) L: .50" (12.7 mm)



LN271 Straight Lifting Needle with SP375 Static-Safe Silicon Suction Cup for LP200.
O.D.: .375" (9.5 mm) L: .50" (12.7 mm)



PRODUCTION AIDS

VACUUM NEEDLES

- LN275** Angled Lifting Needle for LP250, LP252 and VA175.
Includes HC273. O.D.: .03" (.76 mm)



- LN275-1** Angled Lifting Needle for LP250, LP252 and VA175.
Includes HC273. O.D.: .02" (0.5 mm)



- LN275-2** Angled Lifting Needle for LP250, LP252 and VA175 .
Includes HC273. O.D.: .01" (0.2 mm)



- LN76** Angled Lifting Needle for LP250, LP252 and VA175.
Includes HC273. O.D.: .07" (1.8 mm) L: .50" (12.7 mm)



- LN277** Angled Lifting Needle for LP250, LP252 and VA175.
Includes CS468-2 and HC273. O.D.: .05" (1.3 mm) L: .9" (22.9 mm)



- LN278** Angled Lifting Needle for LP250, LP252 and VA175.
Includes CS469 and HC273. O.D.: .05" (1.3 mm) L: 1.9" (48.3 mm)



- LN279** Angled Lifting Needle for LP250, LP252 and VA175.
Includes CS469 and HC273. O.D.: .03" (0.8 mm) L: 1.9" (48.3 mm)



- LN282** Right-Angle Lifting Needle. O.D.: .07" (1.8 mm) L: 2.8" (71 mm)



- LN301** Side Lifting Needle. I.D.: .1" (2.54 mm) Angle: 20°



- LN302** Edge Lifting Needle . I.D.: .023" (.58 mm) Angle: 45°



- LN303** Edge Lifting Needle. I.D.: .1" (2.54 mm) Angle: 30°



- LN304** Side Lifting Needle. I.D.: .07" (1.78 mm) Angle: 30°



SMALL PARTS NEEDLES



LN400 Straight Lifting Needle.
O.D.: .02" (.5 mm) I.D.: .005" (.12 mm) with Static-Safe Delrin Tip



LN400-1 Angled Lifting Probe
O.D.: .02" (.5 mm) I.D.: .005" (.12 mm) with Static-Safe Delrin Tip



LN401 Straight Lifting Needle.
O.D.: .02" (.5 mm) I.D.: .01" (.25 mm) with Static-Safe Delrin Tip



LN401-1 Angled Lifting Needle.
O.D.: .02" (.5 mm) I.D.: .01" (.25 mm) with Static-Safe Delrin Tip



LN401T Straight Lifting Needle
O.D.: .02" (.5 mm) I.D.: .01" (.25 mm) with High-Temperature Torlon Tip



LN401T-1 Angled Lifting Needle.
O.D.: .02" (.5 mm) I.D.: .01" (.25 mm) with High Temperature Torlon Tip



LN402 Straight Lifting Needle.
O.D.: .03" (.76 mm) I.D.: .02" (.5 mm) with Static-Safe Delrin Tip



LN402-1 Angled Lifting Needle.
O.D.: .03" (.76 mm) I.D.: .02" (.5 mm) with Static-Safe Delrin Tip



LN402T Straight Lifting Needle.
O.D.: .03" (.76 mm) I.D.: .02" (.5 mm) with High-Temperature Torlon Tip



LN402T-1 Angled Lifting Needle.
O.D.: .03" (.76 mm) I.D.: .02" (.5 mm) with High-Temperature Torlon Tip



LN403 Straight Lifting Needle.
O.D.: .04" (1 mm) I.D.: .03" (.76 mm) with Static-Safe Delrin Tip



PRODUCTION AIDS

SMALL PARTS NEEDLES



LN403-1

Angled Lifting Needle.
O.D.: .04" (1 mm) I.D.: .03" (.76 mm) with Static-Safe Delrin Tip



LN403T

Straight Lifting Needle.
O.D.: .04" (1 mm) I.D.: .03" (.76 mm) with High-Temperature Torlon Tip



LN403T-1

Angled Lifting Needle.
O.D.: .04" (1 mm) I.D.: .03" (.76 mm) with High-Temperature Torlon Tip



LN404

Straight Lifting Needle.
O.D.: .06" (1.5 mm) I.D.: .04" (1 mm) with Static-Safe Delrin Tip



LN404-1

Angled Lifting Needle.
O.D.: .06" (1.5 mm) I.D.: .04" (1 mm) with Static-Safe Delrin Tip



LN404T

Straight Lifting Needle.
O.D.: .06" (1.5 mm) I.D.: .04" (1 mm) with High-Temperature Torlon Tip



LN404T-1

Angled Lifting Needle.
O.D.: .06" (1.5 mm) I.D.: .04" (1 mm) with High-Temperature Torlon Tip



LN405

Straight Lifting Needle.
O.D.: .08" (2 mm) I.D.: .06" (1.5 mm) with Static-Safe Delrin Tip



LN405-1

Angled Lifting Needle.
O.D.: .08" (2 mm) I.D.: .06" (1.5 mm) with Static-Safe Delrin Tip



LN405T

Straight Lifting Needle.
O.D.: .08" (2 mm) I.D.: .06" (1.5 mm) with High-Temperature Torlon Tip



LN405T-1

Angled Lifting Needle.
O.D.: .08" (2 mm) I.D.: .06" (1.5 mm) with High-Temperature Torlon Tip



PRODUCTION AIDS

SUCTION CUPS

- SP093** OCTAVAC 3/32" Static-Safe Silicone Suction Cup for LN250 Lifting Needle.

- SP125** OCTAVAC 1/8" Static-Safe Silicone Suction Cup for LN250 Lifting Needle.

- SP250** OCTAVAC 1/4" Static-Safe Silicone Suction Cup fits all Lifting Needles except LN250.

- SP375** OCTAVAC 3/8" Static-Safe Silicone Suction Cup fits all Lifting Needles except LN250.

- SP500** OCTAVAC 1/2" Static-Safe Silicone Suction Cup fits all Lifting Needles except LN250.

- SP625** OCTAVAC 5/8" Static-Safe Silicone Suction Cup fits all Lifting Needles except LN250.

- SP750** OCTAVAC 3/4" Static-Safe Silicone Suction Cup fits all Lifting Needles except LN250.



DESOLDERING BRAID

- SW081** No-Clean (Size #1) White Desolder Braid .035" x 5 ft (.9mm x 1.5m) Comes with Static-Safe Bobbin.

- SW081-10** No-Clean (Size #1) White Desolder Braid .035" x 10ft (.9mm x 3m) Comes with Static-Safe Bobbin.

- SW082** No-Clean (Size #2) Yellow Desolder Braid .055" x 5 ft (1.4mm x 1.5m) Comes with Static-Safe Bobbin.

- SW082-10** No-Clean (Size #2) Yellow Desolder Braid .055" x 10ft (1.4mm x 3m) Comes with Static-Safe Bobbin.

- SW083** No-Clean (Size #3) Green Desolder Braid .075" x 5 ft (1.9mm x 1.5m) Comes with Static-Safe Bobbin.

- SW083-10** No-Clean (Size #3) Green Desolder Braid .075" x 10ft (1.9mm x 3m) Comes with Static-Safe Bobbin.

- SW084** No-Clean (Size #4) Blue Desolder Braid .098" x 5 ft (2.5mm x 1.5m) Comes with Static-Safe Bobbin.

- SW084-10** No-Clean (Size #4) Blue Desolder Braid .098" x 10ft (2.5mm x 3m) Comes with Static-Safe Bobbin.

- SW085** No-Clean (Size #5) Brown Desolder Braid .13" x 5 ft. (3.3mm x 1.5m) Comes with Static-Safe Bobbin.

- SW085-10** No-Clean (Size #5) Brown Desolder Braid .13" x 10ft. (3.3mm x 3m) Comes with Static-Safe Bobbin.

- SW086** No-Clean (Size #6) Red Desolder Braid .19" x 5 ft. (4.9mm x 1.5m) Comes with Static-Safe Bobbin.



PRODUCTION AIDS

DESOLDERING BRAIDS

- SW091** Rosin (Size #1) White Desolder Braid .035" x 5 ft (0.9mm x 1.5m) Comes with Static-Safe Bobbin.
- SW091-10** Rosin (Size #1) White Desolder Braid .035" x 10 ft (0.9mm x 3m) Comes with Static-Safe Bobbin.
- SW092** Rosin (Size #2) Yellow Desolder Braid .055" x 5 ft (1.4mm x 1.5m) Comes with Static-Safe Bobbin.
- SW092-10** Rosin (Size #2) Yellow Desolder Braid .055" x 10ft (1.4mm x 3m) Comes with Static-Safe Bobbin.
- SW093** Rosin (Size #3) Gray Desolder Braid .075" x 5ft (1.9mm x 1.5m) Comes with Static-Safe Bobbin.
- SW093-10** Rosin (Size #3) Gray Desolder Braid .075" x 10 ft (1.9mm x 3m) Comes with Static-Safe Bobbin.
- SW094** Rosin (Size #4) Blue Desolder Braid .098" x 5ft (2.5mm x 1.5m) Comes with Static-Safe Bobbin.
- SW094-10** Rosin (Size #4) Blue Desolder Braid .098" x 10 ft (2.5mm x 3m) Comes with Static-Safe Bobbin.
- SW095** Rosin (Size #5) Brown Desolder Braid .13" x 5 ft (3.3mm x 1.5m) Comes with Static-Safe Bobbin.
- SW095-10** Rosin (Size #5) Brown Desolder Braid .13" x 10 ft (3.3mm x 3m) Comes with Static-Safe Bobbin.
- SW096** Rosin (Size #6) Red Desolder Braid .193" x 5 ft (4.9mm x 1.5m) Comes with Static-Safe Bobbin.



SOLDERING ACCESSORIES



CT-1
CROWN Lead-Free
Tip Tinner and Cleaner
Dia: 1.88" (47.8 mm)
Net Weight: 1.5 oz. (42.5 g)



SL287LF
Static-Safe Empty Solder
Holder with Self-Adhesive
Bottom for Lead-Free Solder.



SL287LS
Static-Safe Empty Solder
Holder with
Self-Adhesive Bottom.



LT-1
LONER Lead-Free
Tip Tinner and Cleaner.
Dia: 1.22" (26.6 mm)
Net Weight: .5 oz. (14.2 g)



EA439-1
Replacement Metallic Tip Cleaning
Element for EA439.



EA439-C
Dry Soldering Tip Cleaner and
Stand. Carded for Display.

PRODUCTION AIDS

MAGNIFIERS



EA30
Folding Magnifier - 10x
Lens Dia.: 1.18" (30 mm)



EA3030
Loupe Magnifier - 10x
Lens Dia.: 1.18" (30 mm)



EA3075
Loupe Magnifier - 5.5x
Lens Dia.: 2.95" (75 mm)



EA55
Pocket Magnifier - 2.5x
Lens Dia.: 2.2" (56mm)



EA56
Pocket Magnifier - 5x
Lens Dia.: 1.57" (40mm)



EA75
Folding Magnifier - 3.5x
Lens Dia.: 2.95" (75 mm)



EA7501
Illuminated Magnifier.
Lens Dia. 2" (50 mm)
Magnification: 4.5x



EA7502
Illuminated Magnifier.
Lens Dia.: 3.5" (90 mm)
Magnification: 2.5x



EA7701
High Profile Illuminated Magnifier.
Lens Dia.: 3.5" (90 mm)
Magnification: 2.5x



EA7703
High Profile Illuminated Magnifier.
Lens Dia.: 2" (50 mm)
Magnification: 4.5x



EAL15
High Power Eye Loupe.
Lens Dia.: .59" (15 mm)
Magnification: 10x



EA490
Helping Hand & Magnifier Consisting
of a Board Holder with Alligator Clips
and Adjustable Arms.
Magnification: 2x.

PRODUCTION AIDS

PRODUCTION AIDS



EA171

Pronged Pick-Up Tool
L: 4.7" (120 mm)



EA26

Line Voltage Tester and Screwdriver.



EA450

Burnishing Brush with Metal Nose Cap
and Adjustable Fiberglass Fill.
L: 4.75" (120 mm)



EA450-1

Fiberglass Refills for EA450.
(Set of 12)



EA603

Mini Tool Set - 21 pc.
Wrenches: 4.0, 4.5, 5.0, 5.5, 6.0 mm
Nut Drivers: 3.0, 3.5, 4.0, 4.5, 5.0mm
Phillips: #0, #1
Hex Keys: 1.5, 2.0, 2.5mm
Slotted Flat Sizes: 0.8, 1.4,



EA605

Precision File Set - 5 pc.
1-Round; 1-Square; 1-Triangular;
1-Oval; 1-Flat.
Overall Length 7" (175 mm),
Blade Length 2.5" (65 mm)



EA609

Insulated IC Puller L: 4" (102 mm)



EA610

ESD Safe PLCC Extractor
L: 3.9" (100 mm)



EA760

Spring Hook Set - 5pc.
Includes 5 Hook and Lifters of
Various Sizes and 2-Extension Rods.



EA8001

Alignment Tool Set - 10 pc.



EA801

Component Bender for 1/4 & 1/2
Watt Resistors and Diodes.
L: 5.4" (137 mm)



EA901

Component Bender for
1 & 2 Watt Resistors and Diodes.
L: 5.4" (137 mm)

PRODUCTION AIDS

DISPENSING



EDS2002
Digital Dispensing System with
10 Program memory Storage
and a Timer range from
.008 - 99.9 Seconds.

EDSDEMK
Dispensing Accessory Needle and
Syringe Demo Kit.



EDN-K1
Sample Package of (5) Needles in
Various Sizes: 14, 16, 18, 20 and
25mm.

EDKN-K2
Assorted Needles (500/pkg).

SYRINGE ADAPTERS



EDA3
3cc Universal Syringe Adapter.



EDA3H
3cc Plastic Universal Adapter.
(Adapter Head Only w/out Hose)



EDA3X
3cc Standard Air Syringe Adapter with
6 ft. hose and Quick Disconnect.
(Fits EDSYN & EFD Air Syringe)



EDA5
5cc Universal Syringe Adapter.



EDA5H
5cc Plastic Universal Adapter.
(Adapter Head Only w/out Hose)



EDA5X
5cc Standard Air Syringe Adapter with
6 ft. hose and Quick Disconnect.
(Fits EDSYN & EFD Air Syringe)

PRODUCTION AIDS

SYRINGE ADAPTERS



EDA10
10cc Universal Syringe Adapter.



EDA10H
10cc Plastic Universal Adapter.
(Adapter Head Only w/out Hose)



EDA10X
10cc Standard Air Syringe Adapter with
6 ft. hose and Quick Disconnect.
(Fits EDSYN & EFD Air Syringe)



EDA30
30cc Universal Syringe Adapter.



EDA30H
30cc Plastic Universal Adapter.
(Adapter Head Only w/out Hose)



EA7701
30cc Standard Air Syringe Adapter with
6 ft. hose and Quick Disconnect.
(Fits EDSYN & EFD Air Syringe)

DESPENSING NEEDLES

EDN14 14 Gauge Dispensing Needle- Olive (Set of 50) L: .5" (12.7 mm) ID: .067" (1.7 mm)

EDN14-1 14 Gauge Dispensing Needle- Olive (Set of 50) L: 1" (25.4 mm) ID: .067" (1.7 mm)

EDN14-1-M 14 Gauge Dispensing Needle- Olive (Set of 1000) L: 1" (25.4 mm) ID: .067" (1.7 mm)

EDN14-1.5 14 Gauge Dispensing Needle- Olive (Set of 50) L: 1.5" (38.1 mm) ID: .067" (1.7 mm)

EDN14-1.5-M 14 Gauge Dispensing Needle- Olive (Set of 1000) L: 1.5" (38.1 mm) ID: .067" (1.7 mm)

EDN14-M 14 Gauge Dispensing Needle- Olive (Set of 1000) L: 0.5" (12.7 mm) ID: .067" (1.7 mm)

EDN14T 14 Gauge Tapered Dispensing Needle-Salmon (Set of 50) L: 1.25" (31.8 mm) ID: .063" (1.6 mm)

EDN14T-M 14 Gauge Tapered Dispensing Needle-Salmon (Set of 1000) L: 1.25" (31.8 mm) ID: .063" (1.6 mm)

EDN14TX 14 Gauge Teflon Dispensing Needle-Olive (Set of 50) L: .5" (12.7 mm) ID: .063" (1.6 mm)

EDN14TX-2 14 Gauge Teflon Dispensing Needle-Olive (Set of 50) L: 2" (50.8 mm) ID: .063" (1.6 mm)



PRODUCTION AIDS

DISPENSING NEEDLES

- EDN14** 14 Gauge Dispensing Needle- Olive (Set of 50) L: .5" (12.7 mm) ID: .067" (1.7 mm)
.....
- EDN14-1** 14 Gauge Dispensing Needle- Olive (Set of 50) L: 1" (25.4 mm) ID: .067" (1.7 mm)
.....
- EDN14-1-M** 14 Gauge Dispensing Needle- Olive (Set of 1000) L: 1" (25.4 mm) ID: .067" (1.7 mm)
.....
- EDN14-1.5** 14 Gauge Dispensing Needle- Olive (Set of 50) L: 1.5" (38.1 mm) ID: .067" (1.7 mm)
.....
- EDN14-1.5-M** 14 Gauge Dispensing Needle- Olive (Set of 1000) L: 1.5" (38.1 mm) ID: .067" (1.7 mm)
.....
- EDN14-M** 14 Gauge Dispensing Needle- Olive (Set of 1000) L: 0.5" (12.7 mm) ID: .067" (1.7 mm)
.....
- EDN14T** 14 Gauge Tapered Dispensing Needle-Salmon (Set of 50) L: 1.25" (31.8 mm) ID: .063" (1.6 mm)
.....
- EDN14T-M** 14 Gauge Tapered Dispensing Needle-Salmon (Set of 1000) L: 1.25" (31.8 mm) ID: .063" (1.6 mm)
.....
- EDN14TX** 14 Gauge Teflon Dispensing Needle-Olive (Set of 50) L: .5" (12.7 mm) ID: .063" (1.6 mm)
.....
- EDN14TX-2** 14 Gauge Teflon Dispensing Needle-Olive (Set of 50) L: 2" (50.8 mm) ID: .063" (1.6 mm)
.....
- EDN15** 15 Gauge Dispensing Needle- Orange (Set of 50) L: .50" (12.7 mm) ID: .06" (1.52 mm)
.....
- EDN15-1** 15 Gauge Dispensing Needle- Orange (Set of 50) L: 1" (25.4 mm) ID: .06" (1.52 mm)
.....
- EDN15-1-M** 15 Gauge Dispensing Needle- Orange (Set of 1000) L: 1" (25.4 mm) ID: .06" (1.52 mm)
.....
- EDN15-1.5** 15 Gauge Dispensing Needle- Orange (Set of 50) L: 1.5" (38.1 mm) ID: .06" (1.52 mm)
.....
- EDN15-1.5-M** 15 Gauge Dispensing Needle- Orange (Set of 1000) L: 1.5" (38.1 mm) ID: .06" (1.52 mm)
.....
- EDN15-M** 15 Gauge Dispensing Needle- Orange (Set of 1000) L: 0.5" (12.7 mm) ID: .06" (1.52 mm)
.....
- EDN16** 16 Gauge Dispensing Needle- Purple (Set of 50) L: 0.5" (12.7 mm) ID: .053" (1.3462 mm)
.....
- EDN16-1** 16 Gauge Dispensing Needle- Purple (Set of 50) L: 1" (25.4 mm) ID: .053" (1.3462 mm)
.....



PRODUCTION AIDS

DISPENSING NEEDLES

- EDN16-1-M** 16 Gauge Dispensing Needle- Purple (Set of 1000) L: 1" (25.4 mm) ID: .053" (1.3462 mm)
.....
- EDN16-1.5** 16 Gauge Dispensing Needle- Purple (Set of 50) L: 1.5" (38.1 mm) ID: .053" (1.3462 mm)
.....
- EDN16-1.5-M** 16 Gauge Dispensing Needle- Purple (Set of 1000) L: 1.5" (38.1 mm) ID: .053" (1.3462 mm)
.....
- EDN16-M** 16 Gauge Dispensing Needle- Purple (Set of 1000) L: 0.5" (12.7 mm) ID: .053" (1.3462 mm)
.....
- EDN16T** 16 Gauge Tapered Dispensing Needle-Grey (Set of 50) L: 1.25" (31.8 mm) ID: .048" (1.2 mm)
.....
- EDN16T-M** 16 Gauge Tapered Dispensing Needle-Grey (Set of 1000) L: 1.25" (31.8 mm) ID: .048" (1.2 mm)
.....
- EDN16TX** 16 Gauge Teflon Dispensing Needle-Purple (Set of 50) L: .5" (12.7 mm)
.....
- EDN16TX-2** 16 Gauge Teflon Dispensing Needle-Purple (Set of 50) L: 2" (50.8 mm)
.....
- EDN17** 17 Gauge Dispensing Needle- White (Set of 50) L: 0.5" (12.7 mm) ID: .047" (1.1938 mm)
.....
- EDN17-1** 17 Gauge Dispensing Needle- White (Set of 50) L: 1" (25.4 mm) ID: .047" (1.1938 mm)
.....
- EDN17-1-M** 17 Gauge Dispensing Needle- White (Set of 1000) L: 1" (25.4 mm) ID: .047" (1.1938 mm)
.....
- EDN17-1.5** 17 Gauge Dispensing Needle- White (Set of 50) L: 1.5" (38.1 mm) ID: .047" (1.1938 mm)
.....
- EDN17-1.5-M** 17 Gauge Dispensing Needle- White (Set of 1000) L: 1.5" (38.1 mm) ID: .047" (1.1938 mm)
.....
- EDN17-M** 17 Gauge Dispensing Needle- White (Set of 1000) L: 0.5" (12.7 mm) ID: .047" (1.1938 mm)
.....
- EDN18** 18 Gauge Dispensing Needle- Pink (Set of 50) L: .50" (12.7 mm) ID: .038" (0.97 mm)
.....
- EDN18-1** 18 Gauge Dispensing Needle- Pink (Set of 50) L: 1" (25.4 mm) ID: .038" (.97 mm)
.....
- EDN18-1-M** 18 Gauge Dispensing Needle- Pink (Set of 1000) L: 1" (25.4 mm) ID: .038" (.97 mm)
.....
- EDN18-1.5** 18 Gauge Dispensing Needle- Pink (Set of 50) L: 1.50" (38.1 mm) ID: .038" (0.97 mm)
.....



PRODUCTION AIDS

DISPENSING NEEDLES

- EDN18-1.5-M** 18 Gauge Dispensing Needle- Pink (Set of 1000) L: 1.50" (38.1 mm) ID: .038" (0.97 mm)
.....
- EDN18-M** 18 Gauge Dispensing Needle- Pink (Set of 1000) L: 0.5" (12.7 mm) ID: .038" (.97 mm)
.....
- EDN18T** 18 Gauge Tapered Dispensing Needle-Green (Set of 50) L: 1.25" (31.8 mm) ID: .034" (0.05 mm)
.....
- EDN18T-M** 18 Gauge Tapered Dispensing Needle-Green (Set of 1000) L: 1.25" (31.8 mm) ID: .034" (0.9 mm)
.....
- EDN18TX** 18 Gauge Teflon Dispensing Needle-Pink (Set of 50) L: .5" (12.7 mm)
.....
- EDN18TX-2** 18 Gauge Teflon Dispensing Needle-Pink (Set of 50) L: 2" (50.8 mm)
.....
- EDN19** 19 Gauge Dispensing Needle- Brown (Set of 50) L: .5" (12.7 mm) ID: .032" (0.8126 mm)
.....
- EDN19-1** 19 Gauge Dispensing Needle- Brown (Set of 50) L: 1" (25.4 mm) ID: .032" (.81 mm)
.....
- EDN19-1-M** 19 Gauge Dispensing Needle- Brown (Set of 1000) L: 1" (25.4 mm) ID: .032" (.81 mm)
.....
- EDN19-1.5** 19 Gauge Dispensing Needle- Brown (Set of 50) L: 1.50" (38.1 mm) ID: .032" (0.8126 mm)
.....
- EDN19-1.5-M** 19 Gauge Dispensing Needle- Brown (Set of 1000) L: 1.50" (38.1 mm) ID: .032" (0.8126 mm)
.....
- EDN19-M** 19 Gauge Dispensing Needle- Brown (Set of 1000) L: 0.5" (12.7 mm) ID: .032" (.81 mm)
.....
- EDN20** 20 Gauge Dispensing Needle- Yellow (Set of 50) L: .50" (12.7 mm) ID: .026" (0.7 mm)
.....
- EDN20-1** 20 Gauge Dispensing Needle- Yellow (Set of 50) L: 1" (25.4 mm) ID: .026" (.7 mm)
.....
- EDN20-1-M** 20 Gauge Dispensing Needle- Yellow (Set of 1000) L: 1" (25.4 mm) ID: .026" (.7 mm)
.....
- EDN20-1.5** 20 Gauge Dispensing Needle- Yellow (Set of 50) L: 1.5" (38.1 mm) ID: .026" (.7 mm)
.....
- EDN20-1.5-M** 20 Gauge Dispensing Needle- Yellow (Set of 1000) L: 1.5" (38.1 mm) ID: .026" (.7 mm)
.....
- EDN20-M** 20 Gauge Dispensing Needle- Yellow (Set of 1000) L: 0.5" (12.7 mm) ID: .026" (.7 mm)
.....



PRODUCTION AIDS

DISPENSING NEEDLES

EDN20T 20 Gauge Tapered Dispensing Needle-Pink (Set of 50) L: 1.25" (31.8 mm) ID: .024" (0.6 mm)

EDN20T-M 20 Gauge Tapered Dispensing Needle-Pink (Set of 1000) L: 1.25" (31.8 mm) ID: .024" (0.6 mm)

EDN20TX 20 Gauge Teflon Dispensing Needle-Yellow (Set of 50) L: .5" (12.7 mm)

EDN20TX-2 20 Gauge Teflon Dispensing Needle-Yellow (Set of 50) L: 2" (50.8 mm)

EDN21 21 Gauge Dispensing Needle- Green (Set of 50) L: .50" (12.7 mm) ID: .023" (0.6 mm)

EDN21-1 21 Gauge Dispensing Needle- Green (Set of 50) L: 1" (25.4 mm) ID: .023" (0.6 mm)

EDN21-1-M 21 Gauge Dispensing Needle- Green (Set of 1000) L: 1" (25.4 mm) ID: .023" (0.6 mm)

EDN21-1.5 21 Gauge Dispensing Needle- Green (Set of 50) L: 1.50" (38.1 mm) ID: .022" (0.6 mm)

EDN21-1.5-M 21 Gauge Dispensing Needle- Green (Set of 1000) L: 1.50" (38.1 mm) ID: .022" (0.6 mm)

EDN21-M 21 Gauge Dispensing Needle- Green (Set of 1000) L: 0.5" (12.7 mm) ID: .023" (.6 mm)

EDN22 22 Gauge Dispensing Needle- Black (Set of 50) L: .50" (12.7 mm) ID: .019" (0.5 mm)

EDN22-1 22 Gauge Dispensing Needle- Black (Set of 50) L: 1" (25.4 mm) ID: .019" (0.5 mm)

EDN22-1-M 22 Gauge Dispensing Needle- Black (Set of 1000) L: 1" (25.4 mm) ID: .019" (0.5 mm)

EDN22-1.5 22 Gauge Dispensing Needle- Black (Set of 50) L: 1.5" (38.1 mm) ID: .019" (0.5 mm)

EDN22-1.5-M 22 Gauge Dispensing Needle- Black (Set of 1000) L: 1.5" (38.1 mm) ID: .019" (0.5 mm)

EDN22-M 22 Gauge Dispensing Needle- Black (Set of 1000) L: 0.5" (12.7 mm) ID: .019" (.5 mm)

EDN22T 22 Gauge Tapered Dispensing Needle-Blue (Set of 50) L: 1.25" (31.8 mm) ID: .017" (0.4 mm)

EDN22T-M 22 Gauge Tapered Dispensing Needle-Blue (Set of 1000) L: 1.25" (31.8 mm) ID: .017" (0.4 mm)



DISPENSING NEEDLES

- EDN22TX** 22 Gauge Teflon Dispensing Needle-Black (Set of 50) L: .5" (12.7 mm)
-
- EDN22TX-2** 22 Gauge Teflon Dispensing Needle-Black (Set of 50) L: 2" (50.8 mm)
-
- EDN23** 23 Gauge Dispensing Needle- Sky Blue (Set of 50) L: .5" (12.7 mm) ID: .017" (0.43 mm)
-
- EDN23-1** 23 Gauge Dispensing Needle- Sky Blue (Set of 50) L: 1" (25.4 mm) ID: .017" (0.43 mm)
-
- EDN23-1-M** 23 Gauge Dispensing Needle- Sky Blue (Set of 1000) L: 1" (25.4 mm) ID: .017" (.4318 mm)
-
- EDN23-1.5** 23 Gauge Dispensing Needle- Sky Blue (Set of 50) L: 1.5" (38.1 mm) ID: .017" (0.43 mm)
-
- EDN23-1.5-M** 23 Gauge Dispensing Needle- Sky Blue (Set of 1000) L: 1.5" (38.1 mm) ID: .017" (0.43 mm)
-
- EDN23-M** 23 Gauge Dispensing Needle- Sky Blue (Set of 1000) L: 0.5" (12.7 mm) ID: .017" (.4318 mm)
-
- EDN23TX** 23 Gauge Teflon Dispensing Needle-Sky Blue (Set of 50) L: .5" (12.7 mm)
-
- EDN24** 24 Gauge Dispensing Needle- Red (Set of 50) L: .5" (12.7 mm) ID: .014" (0.56 mm)
-
- EDN24-1** 24 Gauge Dispensing Needle- Red (Set of 50) L: 1" (25.4 mm) ID: .014" (0.56 mm)
-
- EDN24-1-M** 24 Gauge Dispensing Needle- Red (Set of 1000) L: 1" (25.4 mm) ID: .014" (0.56 mm)
-
- EDN24-1.5** 24 Gauge Dispensing Needle- Red (Set of 50) L: 1.5" (38.1 mm) ID: .014" (0.56 mm)
-
- EDN24-1.5-M** 24 Gauge Dispensing Needle- Red (Set of 1000) L: 1.5" (38.1 mm) ID: .014" (0.56 mm)
-
- EDN24-M** 24 Gauge Dispensing Needle- Red (Set of 1000) L: .5" (12.7 mm) ID: .014" (0.56 mm)
-
- EDN24T** 24 Gauge Tapered Dispensing Needle-Red (Set of 50) L: 1.25" (31.8 mm)
-
- EDN24T-M** 24 Gauge Tapered Dispensing Needle-Red (Set of 1000) L: 1.25" (31.8 mm)
-
- EDN25** 25 Gauge Dispensing Needle- Blue (Set of 50) L: .50" (12.7 mm) ID: .012" (.3 mm)
-



PRODUCTION AIDS

DISPENSING NEEDLES

EDN25-1 25 Gauge Dispensing Needle- Blue (Set of 50) L: 1" (25.4 mm) ID: .012" (.3 mm)

EDN25-1-M 25 Gauge Dispensing Needle- Blue (Set of 1000) L: 1" (25.4 mm) ID: .012" (.3 mm)

EDN25-1.5 25 Gauge Dispensing Needle- Blue (Set of 50) L: 1.5" (38.1 mm) ID: .012" (.3 mm)

EDN25-1.5-M 25 Gauge Dispensing Needle- Blue (Set of 1000) L: 1.5" (38.1 mm) ID: .012" (.3 mm)

EDN25-M 25 Gauge Dispensing Needle- Blue (Set of 1000) L: 0.5" (12.7 mm) ID: .012" (.3 mm)

EDN254-10 Dispensing Nozzle 2.5in(63.5mm Opening: 1/8" (3.2mm) (Bag of 10

EDN26 26 Gauge Dispensing Needle- Cream (Set of 50) L: .50" (12.7 mm) ID: .011" (.279 mm)

EDN26-1 26 Gauge Dispensing Needle- Cream (Set of 50) L: 1" (25.4 mm) ID: .011" (.279 mm)

EDN26-1-M 26 Gauge Dispensing Needle- Cream (Set of 1000) L: 1" (25.4 mm) ID: .011" (.279 mm)

EDN26-1.5 26 Gauge Dispensing Needle- Cream (Set of 50) L: 1.5" (38.1 mm) ID: .011" (.279 mm)

EDN26-1.5-M 26 Gauge Dispensing Needle- Cream (Set of 1000) L: 1.5" (38.1 mm) ID: .011" (.28 mm)

EDN26-M 26 Gauge Dispensing Needle- Cream (Set of 1000) L: .50" (12.7 mm) ID: .01" (.254 mm)

EDN27 27 Gauge Dispensing Needle- Gray (Set of 50) L: .50" (12.7 mm) ID: .009" (.229 mm)

EDN27-1 27 Gauge Dispensing Needle- Gray (Set of 50) L: 1" (25.4 mm) ID: .009" (.229 mm)

EDN27-1-M 27 Gauge Dispensing Needle- Gray (Set of 1000) L: 1" (25.4 mm) ID: .009" (.229 mm)

EDN27-1.5 27 Gauge Dispensing Needle- Gray (Set of 50) L: 1.5" (38.1 mm) ID: .009" (.229 mm)

EDN27-1.5-M 27 Gauge Dispensing Needle- Gray (Set of 1000) L: 1.5" (38.1 mm) ID: .009" (.23 mm)

EDN27-M 27 Gauge Dispensing Needle- Gray (Set of 1000) L: 0.5" (12.7 mm) ID: .009" (.229 mm)



PRODUCTION AIDS

DISPENSING NEEDLES

EDN30 30 Gauge Dispensing Needle- Lavender (Set of 50) L: .50" (12.7 mm) ID: .006" (.1524 mm)

EDN30-1 30 Gauge Dispensing Needle- Lavender (Set of 50) L: 1" (25.4 mm) ID: .006" (.1524 mm)

EDN30-1-M 30 Gauge Dispensing Needle- Lavender (Set of 1000) L: 1" (25.4 mm) ID: .006" (.1524 mm)

EDN30-1.5 30 Gauge Dispensing Needle- Lavender (Set of 50) L: 1.5" (38.1 mm) ID: .006" (.1524 mm)

EDN30-1.5-M 30 Gauge Dispensing Needle- Lavender (Set of 1000) L: 1.5" (38.1 mm) ID: .006" (.1524 mm)

EDN30-M 30 Gauge Dispensing Needle- Lavender (Set of 1000) L: .50" (12.7 mm) ID: .006" (.1524 mm)

EDN30TX 30 Gauge Teflon Dispensing Needle-Lavender (Set of 50) L: .5" (12.7 mm)



AIR SYRINGES

EDS3 3cc Air Syringe with Stopper (Set of 50)

EDS5 5cc Air Syringe with Stopper (Set of 40)

EDS10 10cc Air Syringe with Stopper (Set of 30)

EDS30 30cc Air Syringe with Stopper (Set of 20)

EDS30UV 30cc Air Operated UV Black Syringe and Stopper (Set of 10)

EDS30UVA 30cc Air Operated UV Amber Syringe and Stopper (Set of 20)

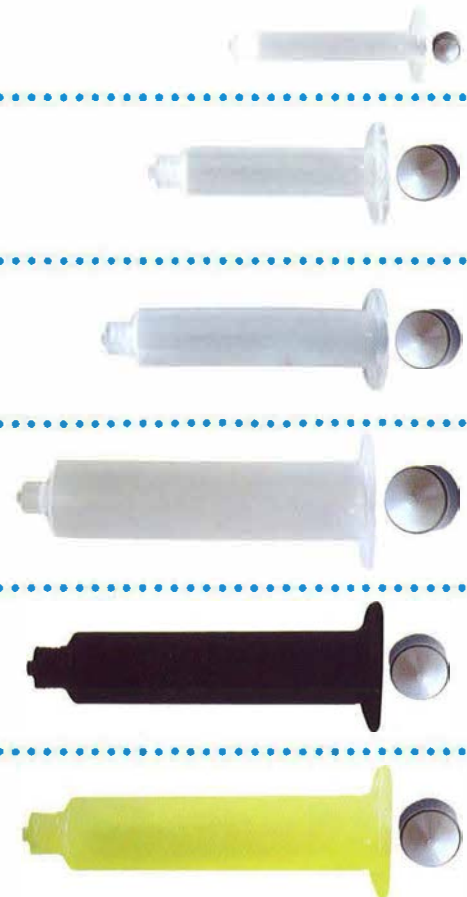

PRODUCTION AIDS

MANUAL SYRINGES

EDSM1-20 1cc Assembled Calibrated Syringes (Set of 20)



EDSM3 3cc Manual Syringe Assembled and Calibrated (Set of 10)



EDSM5 5cc Manual Syringe Assembled and Calibrated (Set of 10)



EDSM10 10cc Manual Syringe Assembled and Calibrated (Set of 10)



EDSM30 30cc Manual Syringe Assembled and Calibrated (Set of 10)



EDSM60 60cc Manual Syringe Assembled and Calibrated (Set of 5)



EDTC-B Luer Lock Tip Cap-Black for All Dispensing Syringes (Set of 100)



EDTC-B-M Luer Lock Tip Cap-Black (Set of 1000)



BOTTLES



EPB-04
One-Touch Plastic Dispensing
Pump Bottle - 4 oz.



EPB-06
One-Touch Plastic Dispensing
Pump Bottle - 6 oz.



EPB-06Y
Yellow Dissipative ESD Safe
One-Touch Dispensing Pump
Bottle - 6 oz.

PRODUCTION AIDS

BOTTLES



EPB08

One-Touch Plastic Dispensing Pump Bottle - 8 oz.



ESB05

Poly Dispensing Bottle Set 1/2 oz. (10 Bottles) with Luer Lock Cap.



ESB10

Poly Dispensing Bottle Set 1 oz. (10 Bottles) with Luer Lock Cap.



ESB20

Poly Dispensing Bottle Set 2 oz. (10 Bottles) with Luer Lock Cap.



ESB40

Poly Dispensing Bottle Set 4 oz. (10 Bottles) with Luer Lock Cap.



ESB80

Poly Dispensing Bottle Set 8 oz. (10 Bottles) with Luer Lock Cap.

FLOW-THROUGH BRUSHES



EDB-16

Flow-Through Brush Stiff 16 Gauge.



EDB-16S

Flow-Through Brush Soft 16 Gauge.



EDB18

Flow-Through Brush Stiff 18 Gauge.



EDB18S

Flow-Through Brush Soft 18 Gauge.



EDB-22

Flow-Through Brush Stiff 22 Gauge.



EDB-22S

Flow-Through Brush Soft 22 Gauge.

HISTORY, MISSION, QUALITY

HISTORY

Established in 1961, Edsyn has set the standard in quality engineering and manufacturing of high performance products for the electronics industry. Inventing the industry's first patented desoldering hand tool known as the Soldapullt, Edsyn launched a revolution in soldering and desoldering technology that continues to this day. Today, Edsyn's general product line has expanded and now includes a wide variety of hand tools, stations, systems and accessories used in the assembly, rework and repair of all types of electronic assemblies particularly those that incorporate the use of Surface Mount Technology.

MISSION

To bring innovative ideas to life through quality engineering and commitment to high performance designs dedicated to suit customer needs.

QUALITY

Total Quality is a responsibility and commitment at Edsyn. We believe this responsibility rests on every employee, and everyone is expected to comply with our Total Quality Standards and Policy at Edsyn. We call this EDSYN QUALITY which is symbolized by the "EQ" stamp and logo. By implementing and enforcing these standards we will be in a position to fulfill our mission, remain financially strong, increase market share, insure employee safety, remain socially responsible and continue to meet the needs of our customers worldwide.



WARRANTY, RETURNS, RMA's & REPAIRS

WARRANTY

Edsyn stands behind its products. We warrant that new tools will be free from defects for 90-days from the date of purchase. During this time period Edsyn will repair or, at its option, replace the tool at no charge. This warranty does not include tips and accessories. Any tool that appears to have been deliberately abused, altered, or destroyed is not covered by this warranty.

RETURNS, RMA's & REPAIRS

Returns of unused Edsyn products to the Edsyn factory is allowed up to 30 days after the date product was shipped from Edsyn. Obsolete items are non-returnable. A 20% restocking fee will be strictly enforced and a substantial restocking order is required. Goods may not be returned to Edsyn without a RMA number issued before goods are returned. Goods returned without an RMA number will not be accepted. Used Goods being returned for repair or replacement must be returned by the customer directly to the Edsyn factory repair department. Edsyn will not accept debits from Authorized Edsyn Distributors for any goods replaced by the Distributor directly to the customer.

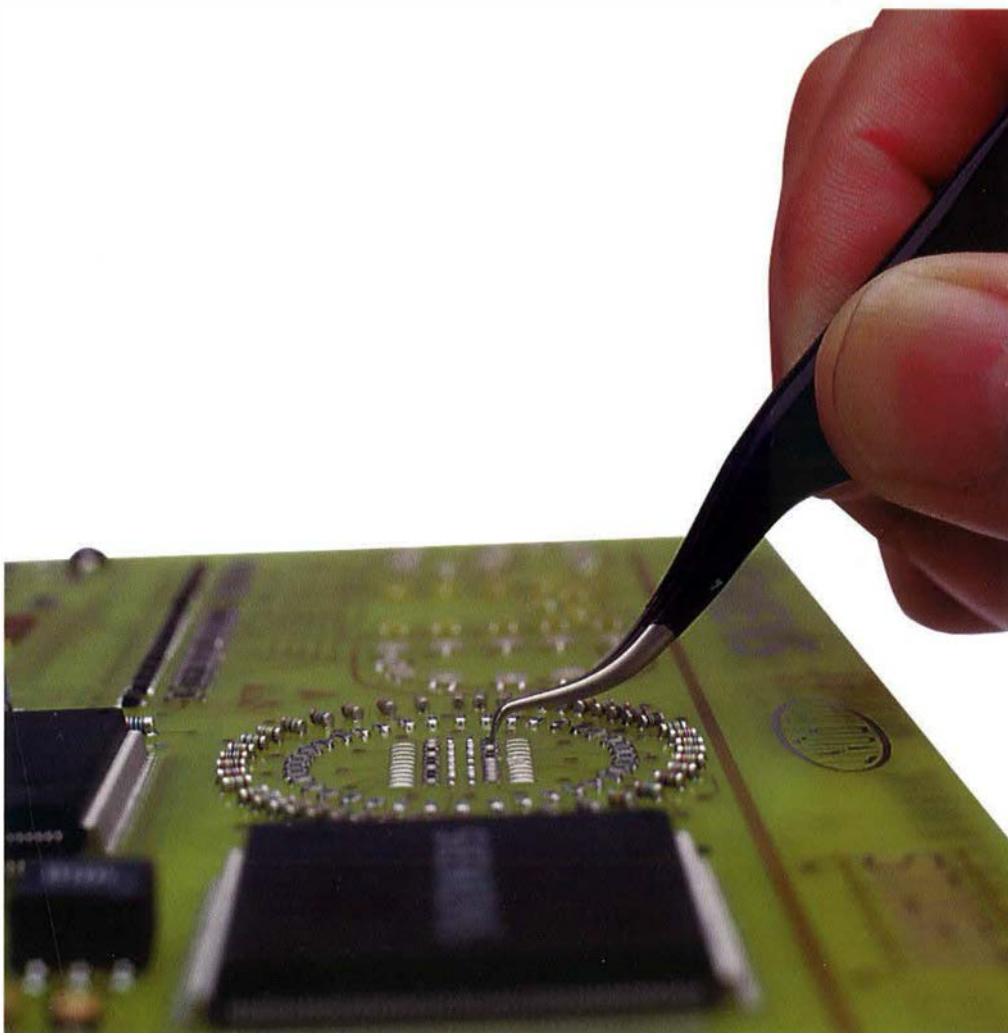



EDSYN®

...the power of precision



**Test Equipment
Depot**
1-800-517-8431

99 Washington Street
Melrose, MA 02176
Phone 781-665-1400 Toll
Free 1-800-517-8431



Visit us at www.TestEquipmentDepot.com