



Elektro-Automatik

Operating Manual

EL 9000 DT

Electronic DC Load



Attention! This document is only valid for devices with firmwares "KE: 3.07", "HMI: 2.19" and "DR: 1.0.6" or higher. For availability of updates for your device check our website or contact us.



Doc ID: EL9DEN
Revision: 04
Date: 08/2020



TABLE OF CONTENTS

1 GENERAL

1.1	About this document	5
1.1.1	Retention and use	5
1.1.2	Copyright	5
1.1.3	Validity	5
1.1.4	Symbols and warnings	5
1.2	Warranty	5
1.3	Limit of liability	5
1.4	Disposal of equipment	6
1.5	Product key	6
1.6	Intended usage	6
1.7	Safety	7
1.7.1	Safety notices	7
1.7.2	Responsibility of the user	7
1.7.3	Responsibility of the operator	8
1.7.4	User requirements	8
1.7.5	Alarm signals	9
1.8	Technical data	9
1.8.1	Approved operating conditions	9
1.8.2	General technical data	9
1.8.3	Specific technical data	10
1.8.4	Views	14
1.8.5	Control elements	16
1.9	Construction and function	17
1.9.1	General description	17
1.9.2	Block diagram	17
1.9.3	Scope of delivery	17
1.9.4	Optional accessories	17
1.9.5	The control panel (HMI)	18
1.9.6	USB port (back side)	21
1.9.7	Ethernet port	21
1.9.8	Analog interface	21
1.9.9	“Sense” connector (remote sensing)	21

2 INSTALLATION & COMMISSIONING

2.1	Storage	22
2.1.1	Packaging	22
2.1.2	Storage	22
2.2	Unpacking and visual check	22
2.3	Installation	22
2.3.1	Safety procedures before installation and use	22
2.3.2	Preparation	22
2.3.3	Installing the device	22
2.3.4	Connection to DC sources	27
2.3.5	Grounding of the DC input	27
2.3.6	Connection of remote sensing	27
2.3.7	Connecting the analog interface	28
2.3.8	Connecting the USB port (rear side)	28
2.3.9	Initial commission	28
2.3.10	Commission after a firmware update or a long period of non use	29

3 OPERATION AND APPLICATION

3.1	Personal safety	30
3.2	Operating modes	30
3.2.1	Voltage regulation / Constant voltage	30
3.2.2	Current regulation / constant current / current limitation	31
3.2.3	Resistance regulation / constant resistance	31
3.2.4	Power regulation / constant power / power limitation	31
3.2.5	Dynamic characteristics and stability criteria	32
3.3	Alarm conditions	33
3.3.1	Power Fail	33
3.3.2	Overtemperature	33
3.3.3	Overvoltage	33
3.3.4	Overcurrent	33
3.3.5	Overpower	33
3.4	Manual operation	34
3.4.1	Powering the device	34
3.4.2	Switching the device off	34
3.4.3	Configuration via MENU	34
3.4.4	Adjustment limits	39
3.4.5	Changing the operating mode	39
3.4.6	Manual adjustment of set values	40
3.4.7	Switching the main screen view	40
3.4.8	The meter bars	41
3.4.9	Switching the DC input on or off	41
3.4.10	Recording to USB stick (logging)	42
3.5	Remote control	43
3.5.1	General	43
3.5.2	Controls locations	43
3.5.3	Remote control via a digital interface	43
3.5.4	Remote control via the analog interface (AI)	44
3.6	Alarms and monitoring	48
3.6.1	Definition of terms	48
3.6.2	Device alarm and event handling	48
3.7	Control panel (HMI) lock	51
3.8	Limits lock	51
3.9	Loading and saving an user profile	52
3.10	The function generator	53
3.10.1	Introduction	53
3.10.2	General	53
3.10.3	Method of operation	54
3.10.4	Manual operation	54
3.10.5	Sine wave function	55
3.10.6	Triangular function	56
3.10.7	Rectangular function	56
3.10.8	Trapezoidal function	57
3.10.9	DIN 40839 function	57
3.10.10	Arbitrary function	58
3.10.11	Ramp function	62

3.10.12	Battery test function	62
3.10.13	MPP tracking function	65
3.10.14	Remote control of the function generator....	66
3.11	Other applications	67
3.11.1	Series connection	67
3.11.2	Parallel operation	67

4 SERVICE AND MAINTENANCE

4.1	Maintenance / cleaning.....	68
4.2	Fault finding / diagnosis / repair.....	68
4.2.1	Replacing a defect mains fuse	68
4.2.2	Firmware updates	68
4.3	Calibration	69
4.3.1	Preface	69
4.3.2	Preparation.....	69
4.3.3	Calibration procedure	69

5 CONTACT AND SUPPORT

5.1	Repairs	71
5.2	Contact options	71

1. General

1.1 About this document

1.1.1 Retention and use

This document is to be kept in the vicinity of the equipment for future reference and explanation of the operation of the device. This document is to be delivered and kept with the equipment in case of change of location and/or user.

1.1.2 Copyright

Reprinting, copying, also partially, usage for other purposes as foreseen of this manual are forbidden and breach may lead to legal process.



1.1.3 Validity

This manual is valid for the following equipment:

Model	Article nr.	Model	Article nr.
EL 9080-45 DT	33 210 501	EL 9080-60 DT	33 210 506
EL 9200-18 DT	33 210 502	EL 9200-36 DT	33 210 507
EL 9360-10 DT	33 210 503	EL 9360-20 DT	33 210 508
EL 9500-08 DT	33 210 504	EL 9500-16 DT	33 210 509
EL 9750-05 DT	33 210 505	EL 9750-10 DT	33 210 510

1.1.4 Symbols and warnings

Warning and safety notices as well as general notices in this document are shown in a box with a symbol as follows:

	Symbol for a life threatening danger
	Symbol for general safety notices (instructions and damage protection bans)
	<i>Symbol for general notices</i>

1.2 Warranty

EA Elektro-Automatik guarantees the functional competence of the device within the stated performance parameters. The warranty period begins with the delivery of free from defects equipment.

Terms of guarantee are included in the general terms and conditions of EA Elektro-Automatik.

1.3 Limit of liability

All statements and instructions in this manual are based on current norms and regulations, up-to-date technology and our long term knowledge and experience. EA Elektro-Automatik accepts no liability for losses due to:

- Usage for purposes other than defined
- Use by untrained personnel
- Rebuilding by the customer
- Technical changes
- Use of non authorized spare parts

The actual delivered device(s) may differ from the explanations and diagrams given here due to latest technical changes or due to customized models with the inclusion of additionally ordered options.

1.4 Disposal of equipment

A piece of equipment which is intended for disposal must, according to European laws and regulations (ElektroG, WEEE) be returned to EA Elektro-Automatik for scrapping, unless the person operating the piece of equipment or another, delegated person is conducting the disposal. Our equipment falls under these regulations and is accordingly marked with the following symbol:



1.5 Product key

Decoding of the product description on the label, using an example:

EL 9080 - 45 DT

	Construction: DT = Desktop housing
	Maximum current of the device in Ampere
	Maximum voltage of the device in Volt
	Series : 9 = Series 9000
	Type identification: EL = Electronic Load

1.6 Intended usage

The equipment is intended to be used, if a power supply or battery charger, only as a variable voltage and current source, or, if an electronic load, only as a variable current sink.

Typical application for a power supply is DC supply to any relevant user, for a battery charger the charging of various battery types and for electronic loads the replacement of Ohm resistance by an adjustable DC current sink in order to load relevant voltage and current sources of any type.



- Claims of any sort due to damage caused by non-intended usage won't be accepted.
- All damage caused by non-intended usage is solely the responsibility of the operator.

1.7 Safety

1.7.1 Safety notices

Mortal danger - Hazardous voltage



- **Electrical equipment operation means that some parts will be under dangerous voltage. Therefore all parts under voltage must be covered!**
- **All work on connections must be carried out under zero voltage (input not connected to voltage sources) and may only be performed by qualified and informed persons. Improper actions can cause fatal injury as well as serious material damage.**
- **Never touch cables or connectors directly after unplugging from mains supply as the danger of electric shock remains.**
- **Never touch a blank contact on the DC input right after usage of the device, because between DC- and DC+ there is potential against ground (PE) which discharges more or less slowly or not at all!**



- The equipment must only be used as intended
- The equipment is only approved for use within the connection limits stated on the product label.
- Do not insert any object, particularly metallic, through the ventilator slots
- Avoid any use of liquids near the equipment. Protect the device from wet, damp and condensation.
- For power supplies and battery chargers: do not connect consumers, particularly such with low resistance, to devices under power; sparking may occur which can cause burns as well as damage to the equipment and to the person operating the equipment.
- For electronic loads: do not connect power sources to equipment under power, sparking may occur which can cause burns as well as damage to the equipment and to the source.
- ESD regulations must be applied when plugging interface cards or modules into the relative slot
- Interface cards or modules may only be attached or removed after the device is switched off. It isn't necessary to open the device.
- Do not connect external power sources with reversed polarity to DC inputs or outputs! The equipment will be damaged.
- For power supply devices: avoid where possible connecting external power sources to the DC output, and never those that can generate a higher voltage than the nominal voltage of the device.
- For electronic loads: do not connect a power source to the DC input which can generate a voltage more than 120% of the nominal input voltage of the load. The equipment isn't protected against over voltage and may be irreparably damaged.
- Always configure the various protecting features against overcurrent, overpower etc. for sensitive sources to what the currently used application requires

1.7.2 Responsibility of the user

The equipment is in industrial operation. Therefore the operators are governed by the legal safety regulations. Alongside the warning and safety notices in this manual the relevant safety, accident prevention and environmental regulations must also be applied. In particular the users of the equipment:

- must be informed of the relevant job safety requirements
- must work to the defined responsibilities for operation, maintenance and cleaning of the equipment
- before starting work must have read and understood the operating manual
- must use the designated and recommended safety equipment.

Furthermore, anyone working with the equipment is responsible for ensuring that the device is at all times technically fit for use.

1.7.3 Responsibility of the operator

Operator is any natural or legal person who uses the equipment or delegates the usage to a third party, and is responsible during its usage for the safety of the user, other personnel or third parties.

The equipment is in industrial operation. Therefore the operators are governed by the legal safety regulations. Alongside the warning and safety notices in this manual the relevant safety, accident prevention and environmental regulations must also be applied. In particular the operator has to

- be acquainted with the relevant job safety requirements
 - identify other possible dangers arising from the specific usage conditions at the work station via a risk assessment
 - introduce the necessary steps in the operating procedures for the local conditions
 - regularly check that the operating procedures are current
 - update the operating procedures where necessary to reflect changes in regulation, standards or operating conditions.
 - define clearly and unambiguously the responsibilities for operation, maintenance and cleaning of the equipment.
 - ensure that all employees who use the equipment have read and understood the manual. Furthermore the users are to be regularly schooled in working with the equipment and the possible dangers.
 - provide all personnel who work with the equipment with the designated and recommended safety equipment
- Furthermore, the operator is responsible for ensuring that the device is at all times technically fit for use.

1.7.4 User requirements

Any activity with equipment of this type may only be performed by persons who are able to work correctly and reliably and satisfy the requirements of the job.

- Persons whose reaction capability is negatively influenced by e. g. drugs, alcohol or medication may not operate the equipment.
- Age or job related regulations valid at the operating site must always be applied.



Danger for unqualified users

Improper operation can cause person or object damage. Only persons who have the necessary training, knowledge and experience may use the equipment.

Delegated persons are those who have been properly and demonstrably instructed in their tasks and the attendant dangers.

Qualified persons are those who are able through training, knowledge and experience as well as knowledge of the specific details to carry out all the required tasks, identify dangers and avoid personal and other risks.

1.7.5 Alarm signals

The equipment offers various possibilities for signalling alarm conditions, however, not for danger situations. The signals may be optical (on the display as text) acoustic (piezo buzzer) or electronic (pin/status output of an analog interface). All alarms will cause the device to switch off the DC input.

The meaning of the signals is as follows:

Signal OT (OverTemperature)	<ul style="list-style-type: none"> • Overheating of the device • DC input will be switched off • Non-critical
Signal OVP (OverVoltage)	<ul style="list-style-type: none"> • Overvoltage shutdown of the DC input occurs due to high voltage entering the device • Critical! The device and/or the load could be damaged
Signal OCP (OverCurrent)	<ul style="list-style-type: none"> • Shutdown of the DC input due to excess of the preset limit • Non-critical, protects the source from excessive current drain
Signal OPP (OverPower)	<ul style="list-style-type: none"> • Shutdown of the DC input due to excess of the preset limit • Non-critical, protects the source from excessive power drain
Signal PF (Power Fail)	<ul style="list-style-type: none"> • DC input shutdown due to AC undervoltage or internal auxiliary supply defect • Critical on AC overvoltage! AC mains input circuit could be damaged

1.8 Technical data

1.8.1 Approved operating conditions

- Use only inside dry buildings
- Ambient temperature 0-50 °C
- Operational altitude: max. 2000 m above sea level
- Maximum 80% humidity, not condensing

1.8.2 General technical data

Display: Colour TFT touch screen with gorilla glass, 4.3", 480pt x 272pt, capacitive

Controls: 2 rotary knobs with pushbutton functions, 1 button

The nominal values for the device determine the maximum adjustable ranges.

1.8.3 Specific technical data

Up to 600 W	Model				
	EL 9080-45 DT	EL 9200-18 DT	EL 9360-10 DT	EL 9500-08 DT	EL 9750-05 DT
AC mains supply					
Supply voltage	90...264 V AC				
Connection type	Wall socket				
Frequency	45...65 Hz				
Fuse	T 2 A				
Power consumption	Max. 40 W				
Leak current	< 3.5 mA				
Inrush current at 230 V	≈ 23 A				
DC Input					
Max. input voltage U_{Max}	80 V	200 V	360 V	500 V	750 V
Peak input power P_{Peak}	600 W	500 W	450 W	400 W	400 W
Steady input power $P_{Steady}^{(2)}$	500 W	500 W	450 W	400 W	400 W
Max. input current I_{Max}	45 A	18 A	10 A	8 A	5 A
Overvoltage protection range	$0...1.03 * U_{Max}$	$0...1.03 * U_{Max}$	$0...1.03 * U_{Max}$	$0...1.03 * U_{Max}$	$0...1.03 * U_{Max}$
Overcurrent protection range	$0...1.1 * I_{Max}$	$0...1.1 * I_{Max}$	$0...1.1 * I_{Max}$	$0...1.1 * I_{Max}$	$0...1.1 * I_{Max}$
Overpower protection range	$0...1.1 * P_{Peak}$	$0...1.1 * P_{Peak}$	$0...1.1 * P_{Peak}$	$0...1.1 * P_{Peak}$	$0...1.1 * P_{Peak}$
Max. allowed input voltage	88 V	220 V	396 V	550 V	825 V
Min. input voltage for I_{Max}	≈ 2.2 V	≈ 2 V	≈ 2 V	≈ 6.5 V	≈ 5.5 V
Temperature coefficient for set values Δ / K	Voltage / current: 100 ppm				
Voltage regulation					
Adjustment range	0...81.6 V	0...204 V	0...367.2 V	0...510 V	0...765 V
Stability at ΔI	< 0.05% U_{Max}	< 0.05% U_{Max}	< 0.05% U_{Max}	< 0.05% U_{Max}	< 0.05% U_{Max}
Accuracy ⁽¹⁾ (at 23 ± 5°C)	≤ 0.1% U_{Max}	≤ 0.1% U_{Max}	≤ 0.1% U_{Max}	≤ 0.1% U_{Max}	≤ 0.1% U_{Max}
Display: Adjustment resolution	See section „1.9.5.4. Resolution of the displayed values“				
Display: Accuracy ⁽³⁾	≤ 0.1%				
Remote sensing compensation	Max. 5% U_{Max}				
Current regulation					
Adjustment range	0...45.9 A	0...18.36 A	0...10.2 A	0...8.16 A	0...5.1 A
Stability at ΔU	< 0.1% I_{Max}	< 0.1% I_{Max}	< 0.1% I_{Max}	< 0.1% I_{Max}	< 0.1% I_{Max}
Accuracy ⁽¹⁾ (at 23 ± 5°C)	≤ 0.2% I_{Max}	≤ 0.2% I_{Max}	≤ 0.2% I_{Max}	≤ 0.2% I_{Max}	≤ 0.2% I_{Max}
Display: Adjustment resolution	See section „1.9.5.4. Resolution of the displayed values“				
Display: Accuracy ⁽³⁾	≤ 0.1%				
Rise time 10...90% I_{Nom}	< 23 μs	< 40 μs	< 24 μs	< 22 μs	< 18 μs
Fall time 90...10% I_{Nom}	< 46 μs	< 42 μs	< 38 μs	< 29 μs	< 40 μs
Power regulation					
Adjustment range	$0...1.02 * P_{Peak}$	$0...1.02 * P_{Peak}$	$0...1.02 * P_{Peak}$	$0...1.02 * P_{Peak}$	$0...1.02 * P_{Peak}$
Accuracy ⁽¹⁾ (at 23 ± 5°C)	< 0.5% P_{Steady}	< 0.5% P_{Steady}	< 0.5% P_{Steady}	< 0.5% P_{Steady}	< 0.5% P_{Steady}
Display: Adjustment resolution	See section „1.9.5.4. Resolution of the displayed values“				
Display: Accuracy ⁽³⁾	≤ 0.2%				

(1) Related to the nominal values, the accuracy defines the maximum deviation between an adjusted values and the true (actual) value.

Example: a 45 A model has a max. 0.2% tolerance (i.e. min. accuracy), which calculates as 90 mA. When adjusting the current to 5 A, the actual value is allowed to differ max. 90 mV, which means it may be between 4.91 A and 5.09 A.

(2) At 25°C ambient temperature

(3) The display accuracy adds to the accuracy of the corresponding value on the DC input

(4) Includes the accuracy of the display actual value

Up to 600 W	Model				
	EL 9080-45 DT	EL 9200-18 DT	EL 9360-10 DT	EL 9500-08 DT	EL 9750-05 DT
Resistance regulation					
Adjustment range	0.09...30.6 Ω	0.5...173.4 Ω	1.6...550.8 Ω	3...1020 Ω	7...2244 Ω
Accuracy ⁽⁴⁾ (at 23 ± 5°C)	≤1% of maximum resistance + 0.3% of maximum current				
Display: Adjustment resolution	See section „1.9.5.4. Resolution of the displayed values“				
Analog interface ⁽¹⁾					
Set value inputs	U, I, P, R				
Actual value output	U, I				
Control signals	DC input on/off, Remote on/off, R mode on/off				
Status signals	CV, OVP, OT, OPP, OCP, PF, DC status				
Galvanic isolation to the device	Max. 400 V DC				
Insulation					
Input (DC) to enclosure	DC minus: permanent max. ±400 V DC plus: permanent max. ±400 V + max. input voltage				
Input (AC) to input (DC)	Max. 2500 V, short-term				
Environment					
Cooling	Temperature controlled fans				
Ambient temperature	0..50 °C				
Storage temperature	-20...70 °C				
Digital interfaces					
Featured	1x USB-B for communication, 1x USB-A for functions, 1x LAN for communication				
Galvanic isolation to the device	Max. 400 V DC				
Terminals					
Rear side	AC input, analog interface, USB-B, Ethernet				
Front side	DC input, USB-A, remote sensing				
Dimensions					
Enclosure (WxHxD)	276 x 103 x 355 mm				
Total (WxHxD)	308 x max. 195 x min. 391 mm				
Standards	EN 60950:2006 + A11:2009 + A1:2010 + A12:2011 + AC:2011 + A2:2013 EN 61000-6-3:2011-09, EN 61000-6-1:2007-10				
Weight	≈ 6.5 kg	≈ 6.5 kg	≈ 6.5 kg	≈ 6.5 kg	≈ 6.5 kg
Article number	33210501	33210502	33210503	33210503	33210504

(1 For technical specifications of the analog interface see „3.5.4.4 Analog interface specification“ on page 45

Up to 1200 W	<i>Model</i>				
	<i>EL 9080-60 DT</i>	<i>EL 9200-36 DT</i>	<i>EL 9360-20 DT</i>	<i>EL 9500-16 DT</i>	<i>EL 9750-10 DT</i>
AC mains supply					
Supply voltage	90...264 V AC				
Connection type	Wall socket				
Frequency	45...65 Hz				
Fuse	T 2 A				
Power consumption	Max. 40 W				
Leak current	< 3.5 mA				
Inrush current at 230 V	≈ 23 A				
DC Input					
Max. input voltage U_{Max}	80 V	200 V	360 V	500 V	750 V
Peak input power P_{Peak}	1200 W	1000 W	900 W	600 W	600 W
Steady input power $P_{Steady}^{(2)}$	900 W	900 W	900 W	600 W	600 W
Max. input current I_{Max}	60 A	36 A	20 A	16 A	10 A
Overvoltage protection range	$0...1.03 * U_{Max}$	$0...1.03 * U_{Max}$	$0...1.03 * U_{Max}$	$0...1.03 * U_{Max}$	$0...1.03 * U_{Max}$
Overcurrent protection range	$0...1.1 * I_{Max}$	$0...1.1 * I_{Max}$	$0...1.1 * I_{Max}$	$0...1.1 * I_{Max}$	$0...1.1 * I_{Max}$
Overpower protection range	$0...1.1 * P_{Peak}$	$0...1.1 * P_{Peak}$	$0...1.1 * P_{Peak}$	$0...1.1 * P_{Peak}$	$0...1.1 * P_{Peak}$
Max. allowed input voltage	88 V	220 V	396 V	550 V	825 V
Min. input voltage for I_{Max}	≈ 2.2 V	≈ 2 V	≈ 2 V	≈ 6.5 V	≈ 5.5 V
Temperature coefficient for set values Δ / K	Voltage / current: 100 ppm				
Voltage regulation					
Adjustment range	0...81.6 V	0...204 V	0...367.2 V	0...510 V	0...765 V
Stability at ΔI	< 0.05% U_{Max}	< 0.05% U_{Max}	< 0.05% U_{Max}	< 0.05% U_{Max}	< 0.05% U_{Max}
Accuracy ⁽¹⁾ (at 23 ± 5°C)	≤ 0.1% U_{Max}	≤ 0.1% U_{Max}	≤ 0.1% U_{Max}	≤ 0.1% U_{Max}	≤ 0.1% U_{Max}
Display: Adjustment resolution	See section „1.9.5.4. Resolution of the displayed values“				
Display: Accuracy ⁽³⁾	≤ 0.1%				
Remote sensing compensation	Max. 5% U_{Max}				
Current regulation					
Adjustment range	0...61.2 A	0...36.72 A	0...20.4 A	0...16.32 A	0...10.2 A
Stability at ΔU	< 0.1% I_{Max}	< 0.1% I_{Max}	< 0.1% I_{Max}	< 0.1% I_{Max}	< 0.1% I_{Max}
Accuracy ⁽¹⁾ (at 23 ± 5°C)	≤ 0.2% I_{Max}	≤ 0.2% I_{Max}	≤ 0.2% I_{Max}	≤ 0.2% I_{Max}	≤ 0.2% I_{Max}
Display: Adjustment resolution	See section „1.9.5.4. Resolution of the displayed values“				
Display: Accuracy ⁽³⁾	≤ 0.1%				
Rise time 10...90% I_{Nom}	< 23 μs	< 40 μs	< 24 μs	< 22 μs	< 18 μs
Fall time 90...10% I_{Nom}	< 46 μs	< 42 μs	< 38 μs	< 29 μs	< 40 μs
Power regulation					
Adjustment range	$0...1.02 * P_{Peak}$	$0...1.02 * P_{Peak}$	$0...1.02 * P_{Peak}$	$0...1.02 * P_{Peak}$	$0...1.02 * P_{Peak}$
Accuracy ⁽¹⁾ (at 23 ± 5°C)	< 0.5% P_{Steady}	< 0.5% P_{Steady}	< 0.5% P_{Steady}	< 0.5% P_{Steady}	< 0.5% P_{Steady}
Display: Adjustment resolution	See section „1.9.5.4. Resolution of the displayed values“				
Display: Accuracy ⁽³⁾	≤ 0.2%				

(1) Related to the nominal values, the accuracy defines the maximum deviation between an adjusted values and the true (actual) value.
Example: a 45 A model has a max. 0.2% tolerance (i.e. min. accuracy), which calculates as 90 mA. When adjusting the current to 5 A, the actual value is allowed to differ max. 90 mV, which means it may be between 4.91 A and 5.09 A.

(2) At 25°C ambient temperature

(3) The display accuracy adds to the accuracy of the corresponding value on the DC input

(4) Includes the accuracy of the display actual value

Up to 1200 W	<i>Model</i>				
	<i>EL 9080-60 DT</i>	<i>EL 9200-36 DT</i>	<i>EL 9360-20 DT</i>	<i>EL 9500-16 DT</i>	<i>EL 9750-10 DT</i>
Resistance regulation					
Adjustment range	0.09...30.6 Ω	0.5...173.4 Ω	1.6...550.8 Ω	3...1020 Ω	7...2244 Ω
Accuracy ⁽⁴⁾ (at 23 ± 5°C)	≤1% of maximum resistance + 0.3% of maximum current				
Display: Adjustment resolution	See section „1.9.5.4. Resolution of the displayed values“				
Analog interface ⁽¹⁾					
Set value inputs	U, I, P, R				
Actual value output	U, I				
Control signals	DC input on/off, Remote on/off, R mode on/off				
Status signals	CV, OVP, OT, OPP, OCP, PF, DC status				
Galvanic isolation to the device	Max. 400 V DC				
Sample rate (set value inputs)	500 Hz				
Insulation					
Input (DC) to enclosure	DC minus: permanent max. ±400 V DC plus: permanent max. ±400 V + max. input voltage				
Input (AC) to input (DC)	Max. 2500 V, short-term				
Environment					
Cooling	Temperature controlled fans				
Ambient temperature	0..50 °C				
Storage temperature	-20...70 °C				
Digital interfaces					
Featured	1x USB-B for communication, 1x USB-A for functions, 1x LAN for communication				
Galvanic isolation to the device	Max. 400 V DC				
Terminals					
Rear side	AC input, analog interface, USB-B, Ethernet				
Front side	DC input, USB-A, remote sensing				
Dimensions					
Enclosure (WxHxD)	276 x 103 x 355 mm				
Total (WxHxD)	308 x max. 195 x min. 451 mm				
Standards	EN 60950:2006 + A11:2009 + A1:2010 + A12:2011 + AC:2011 + A2:2013 EN 61000-6-3:2011-09, EN 61000-6-1:2007-10				
Weight	≈ 7.5 kg	≈ 7.5 kg	≈ 7.5 kg	≈ 7.5 kg	≈ 7.5 kg
Article number	33210506	33210507	33210508	33210509	33210510

(1 For technical specifications of the analog interface see „3.5.4.4 Analog interface specification“ on page 45

1.8.4 Views

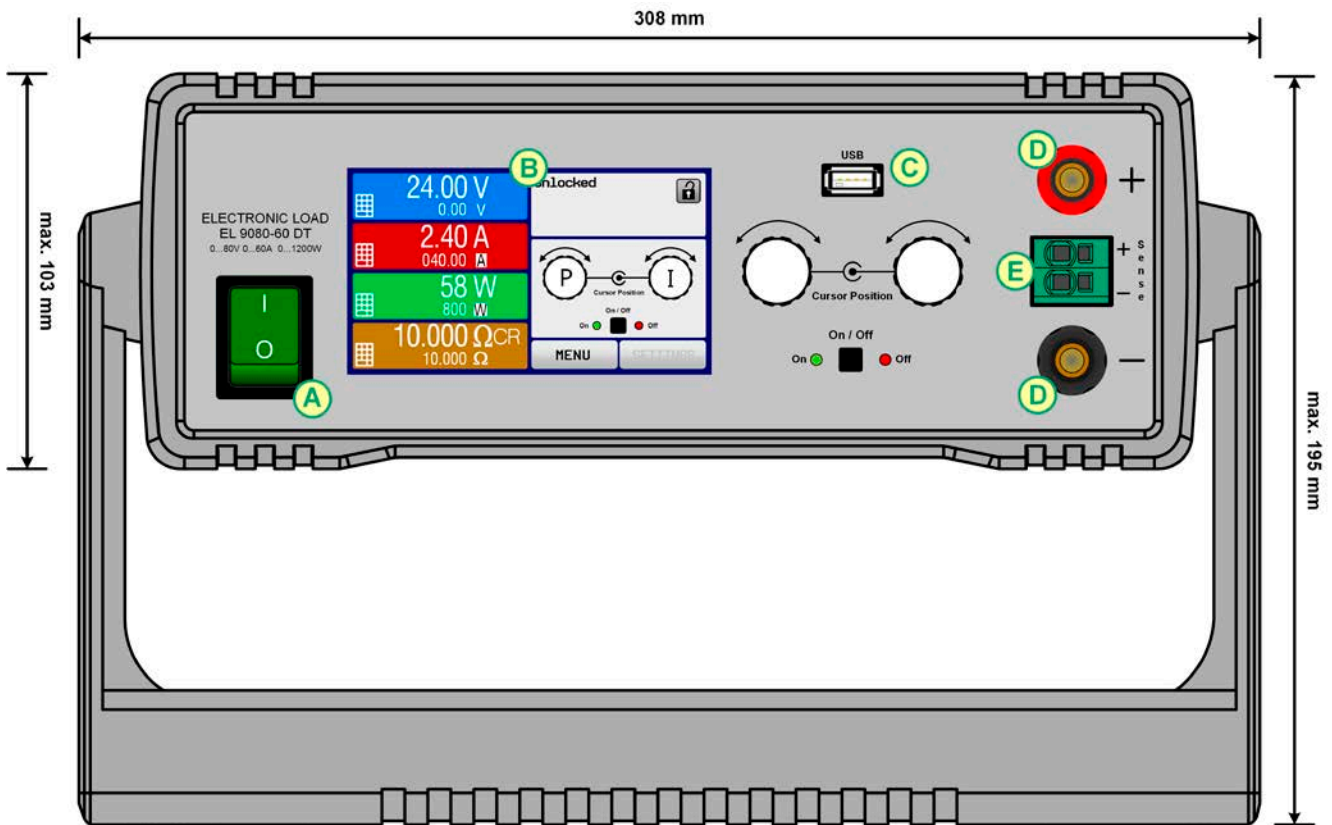

Figure 1 - Front side

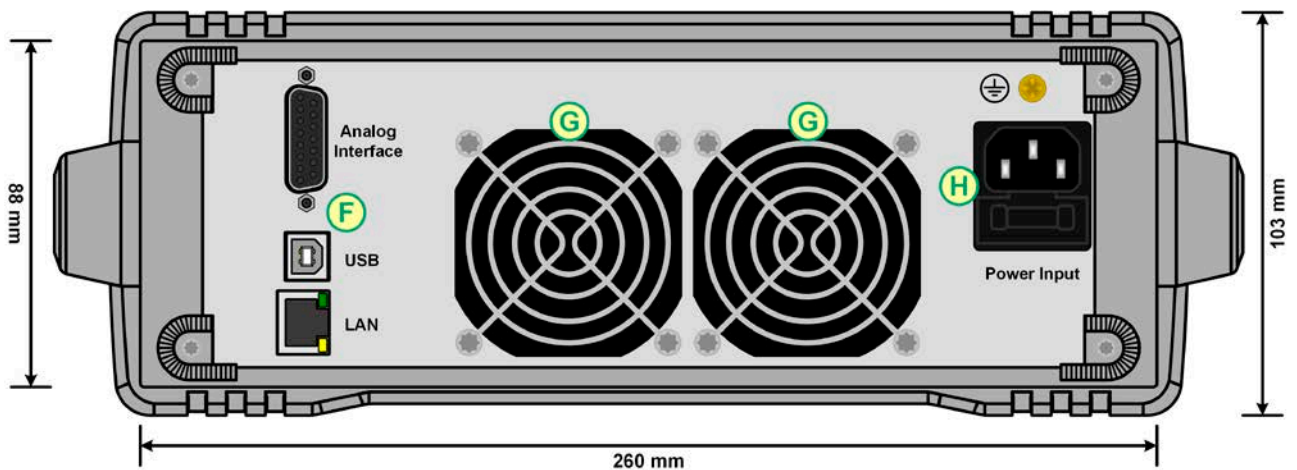

Figure 2 - Back side



Do not loosen the grounding point (brass screw next to fuse holder H) in order to connect PE cables! The device is supposed to be grounded via the AC cord, while the grounding point is used to connect the enclosure to PE.

A - Power switch

B - Control panel

C - Front USB port (type A)

D - DC input

E - Remote sensing input

F - Remote control interfaces (digital, analog)

G - Fan exhausts

H - AC supply connection

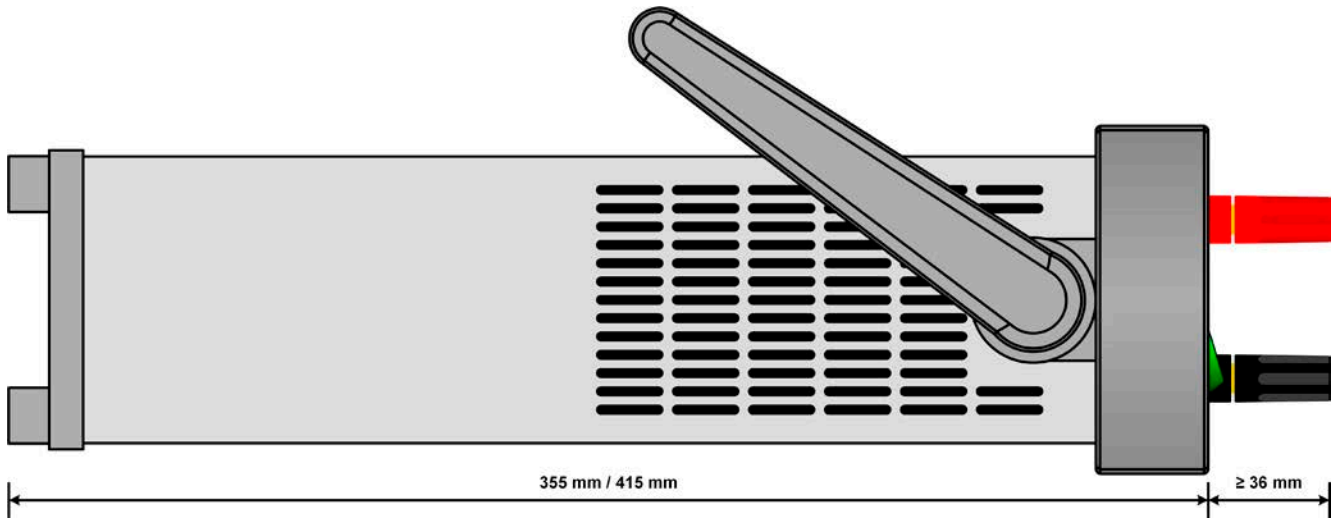

Figure 3 - Side view from left, horizontal position

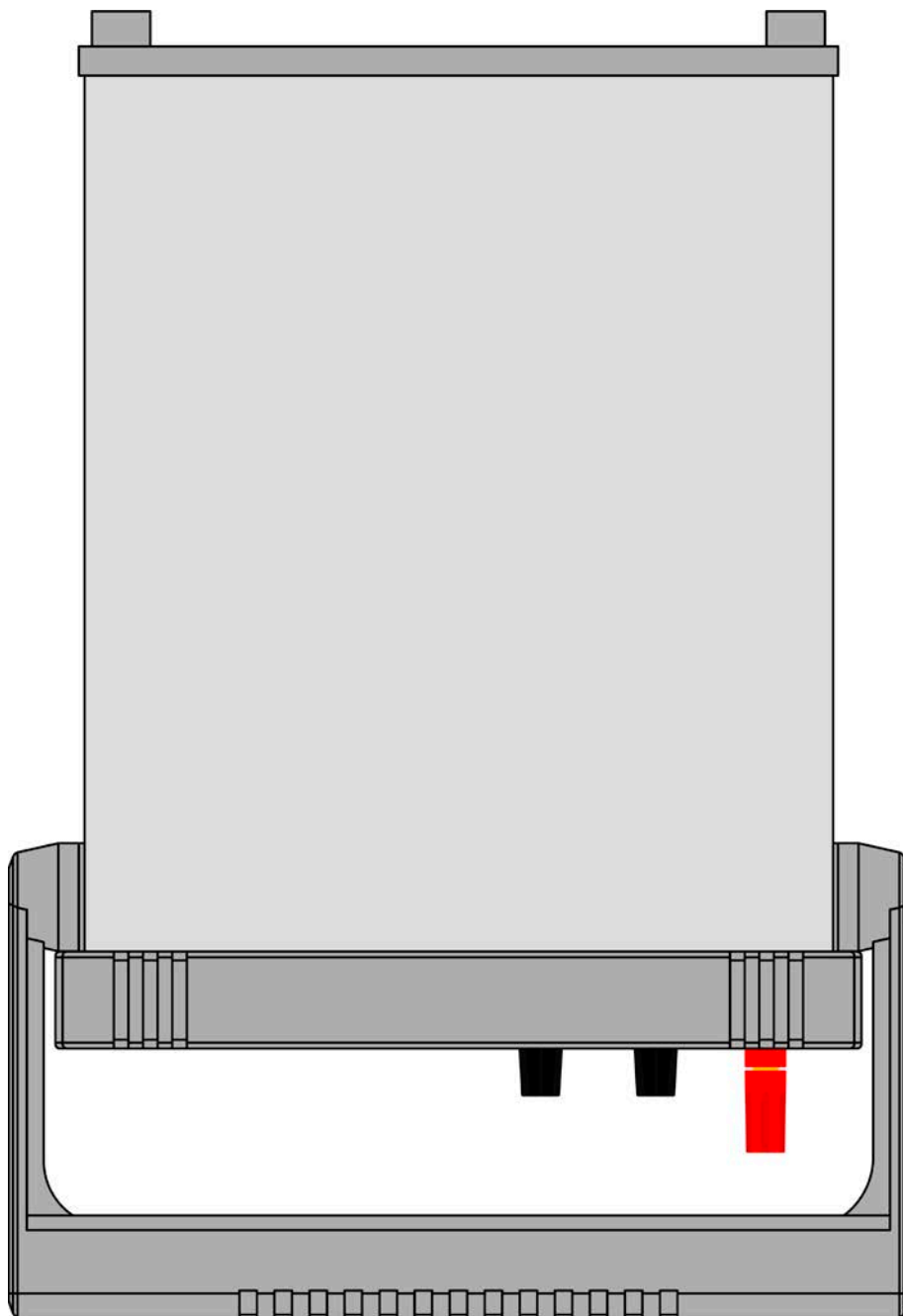

Figure 4 - Top view

1.8.5 Control elements

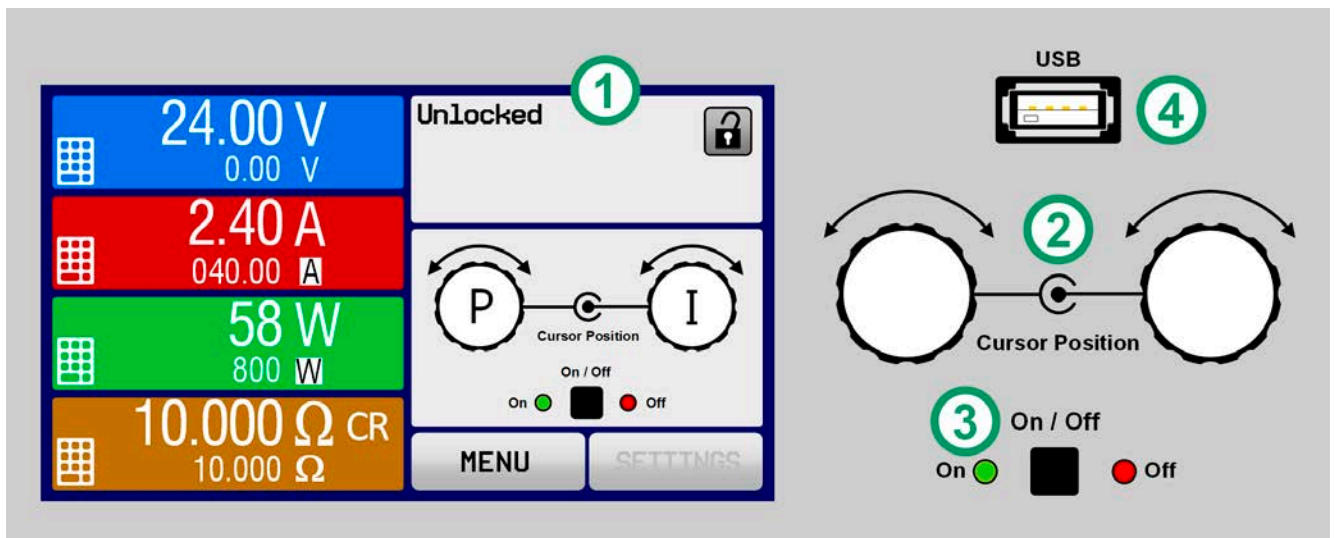

Figure 5 - Control Panel

Overview of the elements on the control panel

For a detailed description see section „1.9.5. The control panel (HMI)“ and „1.9.5.2. Rotary knobs“.

(1)	Touchscreen display Used for selection of set values, menus, display of actual values and status. The touchscreen can be operated with the fingers or with a stylus.
(2)	Rotary knob with push button function Left knob (turn): adjusting the voltage, power or resistance set values, or setting the parameter values in the menu. Left knob (push): selection of the decimal position to be (cursor) changed by value adjustment. Right knob (turn): adjusting the current set value, or setting parameter values in the menu. Right knob (push): selection of the decimal position to be (cursor) changed by value adjustment.
(3)	On/Off Button for DC input Used to toggle the DC input between on and off, also used to start a function run. The LEDs “On” and “Off” indicate the state of the DC input, no matter if the device is manually controlled or remotely
(4)	USB-A port For the connection of standard USB sticks. See section „1.9.5.5. USB port (front side)“ for more details.

1.9 Construction and function

1.9.1 General description

The conventional, electronic DC loads of the EL 9000 DT series are especially suitable for research laboratories, test applications or educational purposes, all due to their compact construction in a rugged desktop enclosure.

Apart from basic functions of electronic loads, set point curves can be generated in the integrated function generator (sine, rectangular, triangular and other curve types). Arbitrary curves can be stored on and uploaded from an USB stick.

For remote control using a PC or PLC the devices are provided as standard with USB and Ethernet/LAN ports on the back side, as well as a fast and galvanically isolated analog interface.

A carrying handle can serve as tilt stand, allowing for simple setup of different positions by the user in order to make it easier to read from the display or access the control elements.

All models are controlled by microprocessors. These enable an exact and fast measurement and display of actual values.

1.9.2 Block diagram

The block diagram illustrates the main components inside the device and their relationships.

There are digital, microprocessor controlled components (KE, DR, HMI), which can be target of firmware updates.

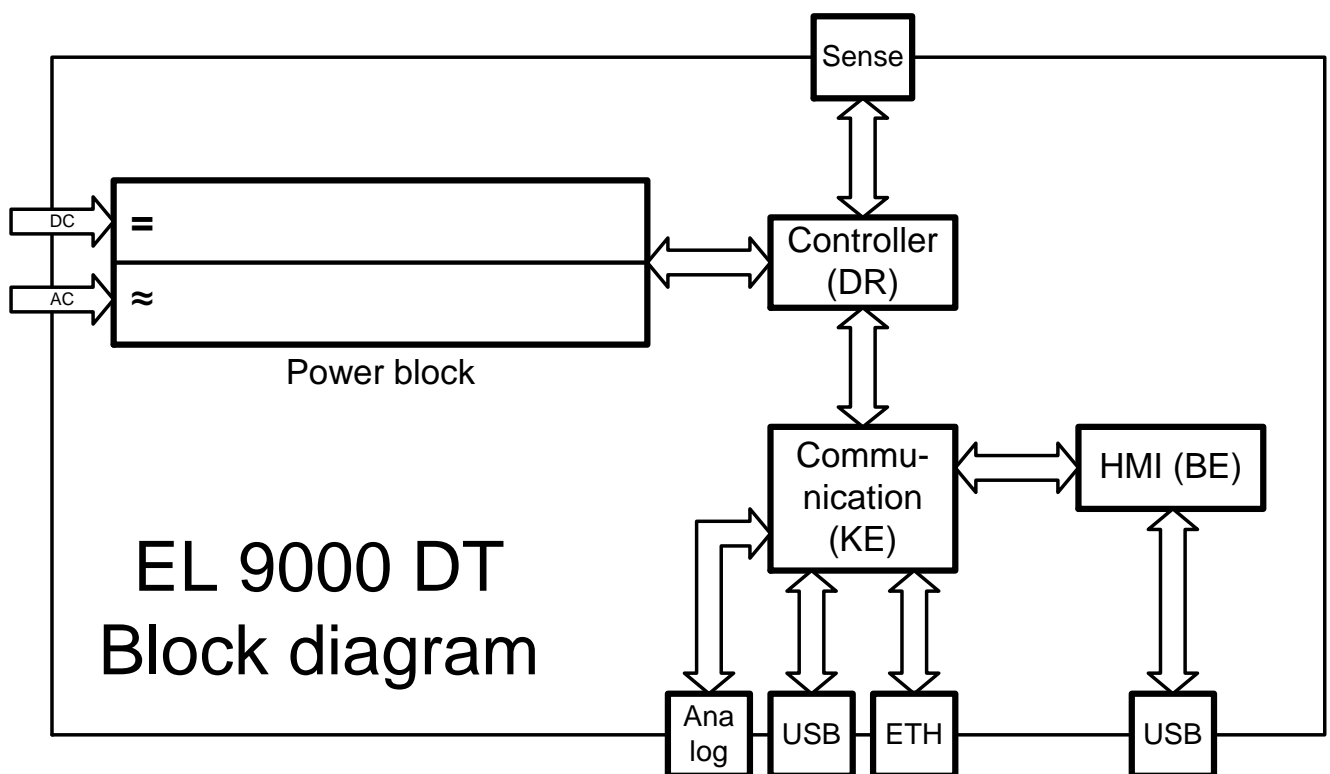

1.9.3 Scope of delivery

1 x Electronic load device

1 x 1.8 m USB cable

1 x USB stick with documentation and software

1 x Mains cord (Schuko IEC), plus either cable with UK plug or adapter (depends on shipping destination)

1.9.4 Optional accessories

For these devices the following accessories are available:

19" PSI/EL 9000 DT Ordering nr. 10 400 111	Metal frame kit for the mount of one EL 9000 DT device in a 19" system (cabinet, rack). Height: 2U.
--	---

1.9.5 The control panel (HMI)

The HMI (Human Machine Interface) consists of a display with touchscreen, two rotary knobs, a button and an USB port.

1.9.5.1 Touchscreen display

The graphic touchscreen display is divided into a number of areas. The complete display is touch sensitive and can be operated by finger or stylus to control the equipment.

In normal operation the left hand side is used to show actual and set values and the right hand side to display status information:

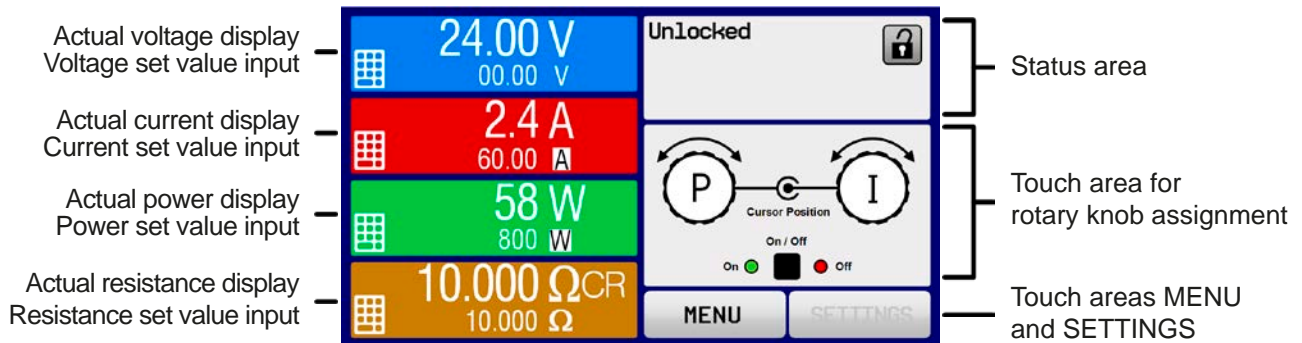

Touch areas may be enabled or disabled:



MENU

Black text or symbol = Enabled

SETTINGS

Grey text or symbol = Disabled

This applies to all touch areas on the main screen and all menu pages..

• Actual / set values area (left hand side)

In normal operation the DC input values (large numbers) and set values (small numbers) for voltage, current and power are displayed. The resistance set value is only displayed if resistance mode is activated.

When the DC input is switched on, the actual regulation mode, **CV**, **CC**, **CP** or **CR** is displayed next to the corresponding actual values, as shown in the figure above.

The set values can be adjusted with the rotary knobs next to the display screen or can be entered directly via the touchscreen. When adjusting with the knobs, pushing the knob will select the digit to be changed. Logically, the values are increased by clockwise turning and decreased by anti-clockwise turning.

General display and setting ranges:



Display	Unit	Range	Description
Actual voltage	V	0-125% U_{Nom}	Actual value of DC input voltage
Set value of voltage ⁽¹⁾	V	0-102% U_{Nom}	Set value for limiting the DC input voltage
Actual current	A	0.2-125% I_{Nom}	Actual value of DC input current
Set value of current ⁽¹⁾	A	0-102% I_{Nom}	Set value for limiting the DC input current
Actual power	W	0-125% P_{Peak}	Calculated actual value of input power, $P = U_{IN} * I_{IN}$
Set value of power ⁽¹⁾	W	0-102% P_{Peak}	Set value for limiting DC input power
Actual resistance	Ω	0...99.999 Ω	Calculated actual internal resistance, $R = U_{IN} / I_{IN}$
Set value of resistance ⁽¹⁾	Ω	$x^{(2)}$ -102% R_{Max}	Set value for the desired internal resistance
Adjustment limits 1	A,V,W	0-102% nom	U-max, I-min etc., related to the physical values
Adjustment limits 2	Ω	$x^{(2)}$ -102% nom	R-max
Protection settings 1	A,W	0-110% nom	OCP and OPP, related to the physical values
Protection settings 2	V	0-103% nom	OVP, related to the physical values

⁽¹⁾ Valid also for values related to these physical values, such as OVD for voltage and UCD for current

⁽²⁾ The minimum adjustable resistance set value varies depending on the model. See technical specifications in 1.8.3

• Status display (upper right)

This area displays various status texts and symbols:

Display	Description
Locked	The HMI is locked
Unlocked	The HMI is unlocked
Remote:	The device is under remote control from....
Analogthe built-in analog interface
USBthe built-in USB port
Ethernetthe built-in Ethernet port
Local	The device has been locked by the user explicitly against remote control
Alarm:	Alarm condition which has not been acknowledged or still exists.
Event:	An user defined event has occurred which isn't yet acknowledged.
Function:	Function generator activated, function loaded
 / 	Data logging to USB stick active or failed

• Area for assigning the rotary knobs

The two rotary knobs next to the display screen can be assigned to various functions. This area shows the actual assignments. These can be changed by tapping this area, as long as it's not locked. The display changes to:

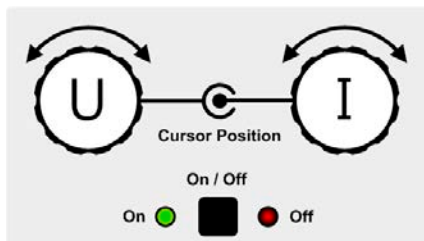

The physical quantities on the depiction of the knobs show the current assignment. With an electronic load, the right-hand knob is always assigned to the current I, while the left knob can be switched by tapping the depiction.

The area will then show the assignment:

U I

Left rotary knob: voltage
Right rotary knob: current

P I

Left rotary knob: power
Right rotary knob: current

R I

Left rotary knob: resistance
Right rotary knob: current

The other set values can't be adjusted via the rotary knobs, unless the assignment is changed. However, values can be entered directly with a ten-key pad by tapping on the small icon . Alternatively to the knob depiction, the assignment can also be changed by tapping the coloured set value areas.

1.9.5.2 Rotary knobs



As long as the device is in manual operation the two rotary knobs are used to adjust set values as well as setting the parameters in SETTINGS and MENU. For a detailed description of the individual functions see section „3.4 Manual operation“ on page 34.

1.9.5.3 Button function of the rotary knobs

The rotary knobs also have a pushbutton function which is used anywhere during value adjustment to shift the cursor as shown:



1.9.5.4 Resolution of the displayed values

In the display, set values can be adjusted with a fixed step width. The number of decimal places depends on the device model. The values have 4 or 5 digits. Actual and set values always have the same number of digits.

Adjustment resolution and number of digits of set values in the display:

Voltage, OVP, UVD, OVD, U-min, U-max			Current, OCP, UCD, OCD, I-min, I-max			Power, OPP, OPD, P-max			Resistance, R-max		
Nominal	Digits	Min. increment	Nominal	Digits	Min. increment		Digits	Min. increment	Nominal	Digits	Min. increment
80 V	4	0.01 V	5 A / 8 A	4	0.001 A	< 1000 W	4	0.1 W	30 Ω	5	0.001 Ω
200 V	5	0.01 V	10 A - 20 A	5	0.001 A	>= 1000 W	4	1 W	170 Ω / 540 Ω	5	0.01 Ω
360 V	4	0.1 V	36 A - 60 A	4	0.01 A				1000 Ω	5	0.1 Ω
500 V	4	0.1 V							2200 Ω	5	0.1 Ω
750 V	4	0.1 V									

1.9.5.5 USB port (front side)

The frontal USB port, located to the right of the rotary knobs, is intended for the connection of standard USB 2.0 sticks (USB 3.0 is accepted, but it depends on the chip manufacturer). The stick can be used for uploading or downloading of sequences for the arbitrary function generator and more.

USB sticks must be **FAT32** formatted and have a **maximum capacity of 32GB**. All supported files must be held in a designated folder in the root path of the USB drive in order to be found. This folder must be named **HMI_FILES**, such that a PC would recognize the path G:\HMI_FILES if the drive were to be assigned the letter G.

The control panel of the device can read the following file types from an USB stick:

wave_u<arbitrary_text>.csv wave_i<arbitrary_text>.csv	Function generator for an arbitrary function on voltage (U) or current (I) The name must begin with <i>wave_u</i> / <i>wave_i</i> , the rest is user defined.
profile_<nr>.csv	Saved user profile. The number in the file name is a counter and not related to the actual user profile number in the HMI. A max. of 10 files can be stored by the HMI.
mpp_curve_<arbitrary_text>.csv	User-defined curve data (100 voltage values) for mode MPP4 of the MPPT function

The control panel of the device can save the following file types to an USB stick:

battery_test_log_<nr>.csv	File with log data recorded from the battery test function. For a battery test log, data different and/or additional to log data of normal logging is recorded. The <nr> field in the file name is automatically counted up if equally named files already exist in the folder.
usb_log_<nr>.csv	File with log data recorded during normal operation in all modes. The file layout is identical to the those generated from the Logging feature in EA Power Control. The <nr> field in the file name is automatically counted up if equally named files already exist in the folder.
profile_<nr>.csv	Saved user profile. The number in the file name is a counter and not related to the actual user profile number in the HMI. A max. of 10 files to select from is shown when loading an user profile.
wave_u<nr>.csv wave_i<nr>.csv	Set point data (here: sequence points) from the arbitrary function generator
mpp_result_<nr>.csv	Result data from MPP tracking mode 4 in form of a table with 100 data groups (Umpp, Impp, Pmpp)

1.9.6 USB port (back side)

The USB port on the back side of the device is provided for communication with the device and for firmware updates. The included USB cable can be used to connect the device to a PC (USB 2.0 or 3.0). The driver is delivered on the included USB stick and installs a virtual COM port. Details for remote control can be found on the web site of Elektro-Automatik or on the included USB stick.

The device can be addressed via this port either using the international standard ModBus RTU protocol or by SCPI language. The device recognizes the message protocol automatically.

If remote control is in operation the USB port has no priority over either the interface module (see below) or the analog interface and can, therefore, only be used alternatively to these. However, monitoring is always available.

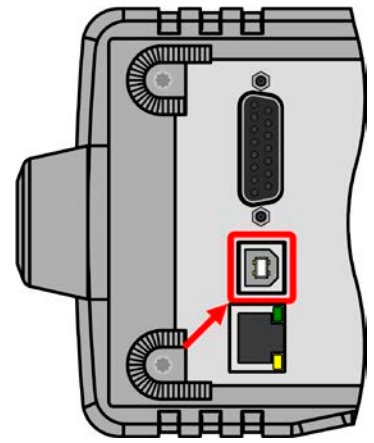

1.9.7 Ethernet port

The Ethernet port on the back side of the device is provided for communication with the device in terms of remote control or monitoring. The user has basically two options of access:

1. A website (HTTP, port 80) which is accessible in a standard browser under the IP or the host name given for the device. This website offers to configuration page for network parameters, as well as a input box for SCPI commands.
2. TCP/IP access via a freely selectable port (except 80 and other reserved ports). The standard port for this device is 5025. Via TCP/IP and this port, communication to the device can be established in most of the common programming languages.

Using the Ethernet port, the device can either be controlled by commands from SCPI or ModBus RTU protocol, while automatically detecting the type of message.

The network setup can be done manually or by DHCP. The transmission speed is set to "Auto negotiation" and means it can use 10 MBit/s or 100 MBit/s. 1 GBit/s isn't supported. Duplex mode is always full duplex.

If remote control is in operation the Ethernet port has no priority over either the analog interface or the USB interface and can, therefore, only be used alternatively to these. However, monitoring is always available.

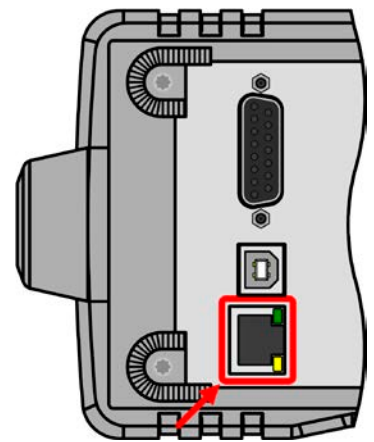

1.9.8 Analog interface

This 15 pole Sub-D socket on the back side of the device is provided for remote control of the device via analog or digital signals.

If remote control is in operation this analog interface can only be used alternately to the digital interface. However, monitoring is always available.

The input voltage range of the set values and the output voltage range of the monitor values, as well as reference voltage level can be switched in the settings menu of the device between 0-5 V and 0-10 V, in each case for 0-100%.

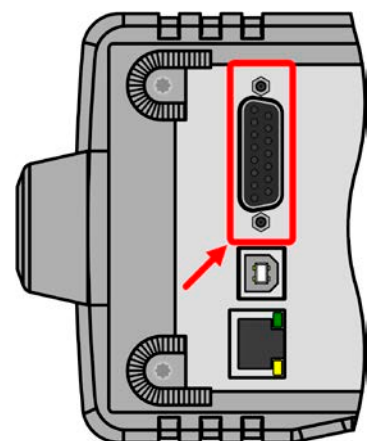

1.9.9 "Sense" connector (remote sensing)

In order to compensate for voltage drops along the DC cables, the **Sense** input (between the DC input terminals) can be connected to the source. The device will automatically detect when the sense input is wired (Sense+) and compensate the input voltage accordingly.

The maximum possible compensation is given in the technical specifications.

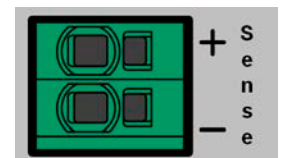

2. Installation & commissioning

2.1 Storage

2.1.1 Packaging

It's recommended to keep the complete transport packaging for the lifetime of the device for relocation or return to Elektro-Automatik for repair. Otherwise the packaging should be disposed of in an environmentally friendly way.

2.1.2 Storage

In case of long term storage of the equipment it's recommended to use the original packaging or similar. Storage must be in dry rooms, if possible in sealed packaging, to avoid corrosion, especially internal, through humidity.

2.2 Unpacking and visual check

After every transport, with or without packaging, or before commissioning, the equipment should be visually inspected for damage and completeness using the delivery note and/or parts list (see section „1.9.3. *Scope of delivery*“). An obviously damaged device (e. g. loose parts inside, damage outside) must under no circumstances be put in operation.

2.3 Installation

2.3.1 Safety procedures before installation and use



- When installing the device in a 19" rack using the optionally available mount frame, rails suitable for the total weight of the device are to be used (see „1.8.3. *Specific technical data*“).
- Before connecting to the mains ensure that the connection is as shown on the product label. Overvoltage on the AC supply can cause equipment damage.
- Before connecting a voltage source to the DC input make sure, that the source can't generate a voltage higher than specified for a particular model or install measures which can prevent damaging the device by overvoltage input.

2.3.2 Preparation

Mains connection with an EL 9000 DT series device is done via the included 1.5 meters long 3 pole mains cord. Dimensioning of the DC wiring to the source has to reflect the following:



- The cable cross section should always be specified for at least the maximum current of the device.
- Continuous operation at the approved limit generates heat which must be removed, as well as voltage loss which depends on cable length and heating. To compensate for these the cable cross section should be increased and/or the cable length reduced.

2.3.3 Installing the device



- Select the location for the device so that the connection to the source is as short as possible.
- Leave sufficient space behind the equipment, minimum 30 cm, for ventilation of warm air that will be exhausted
- Never obstruct the air inlets on the sides!
- In case the handle is used to bring the device into an uplifted position, never place any objects onto the top of the unit!

2.3.3.1 The handle

The included handle isn't only used to carry the device, it can also uplift the device's front for easier access to knobs and buttons or better display readability.

The handle can be rotated into various positions in an angle of 300°, such as a variable position (60...150°), 0°, -45°, -90° and -150°.

It's rotated by pulling on both sides of the handle first in order to loosen the detent and then moving the handle around its axis.

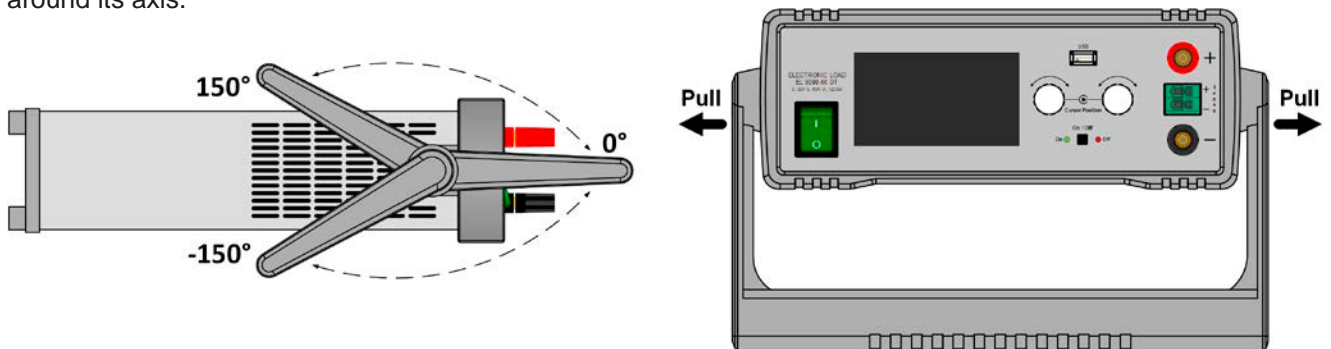

2.3.3.2 Placement on horizontal standing surfaces

The device is designed as a desktop unit and should only be operated in horizontal position on horizontal surfaces, which are capable of securely carrying the weight of the device.

Acceptable and unacceptable operating positions:

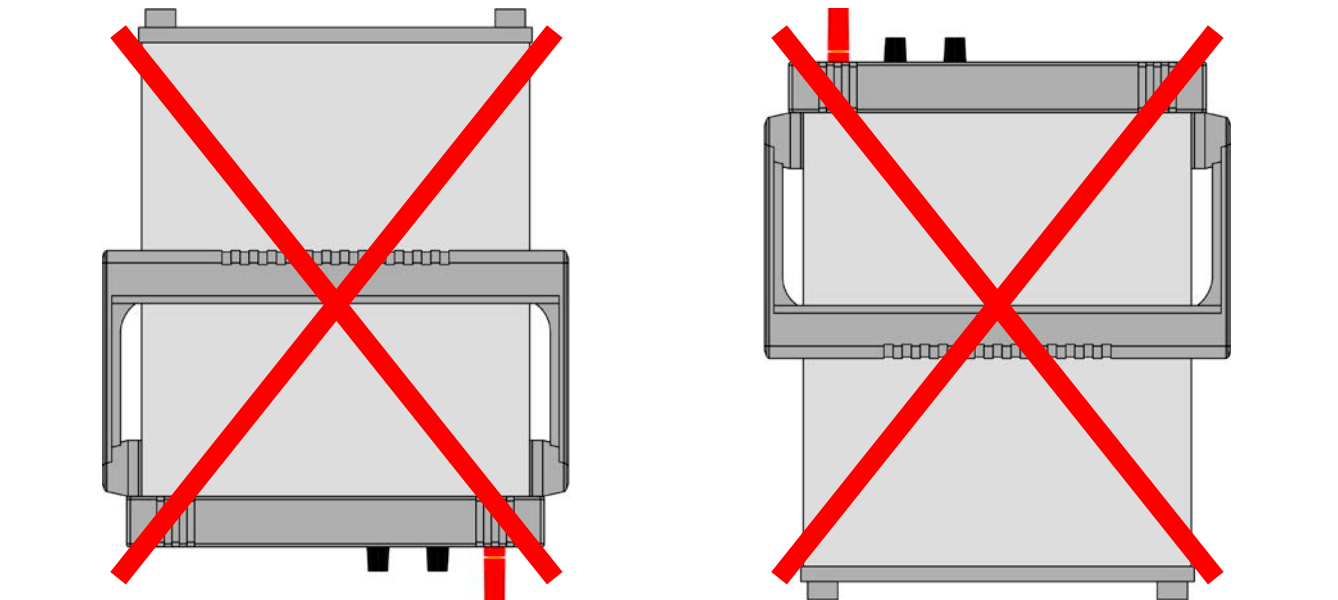

Standing surface

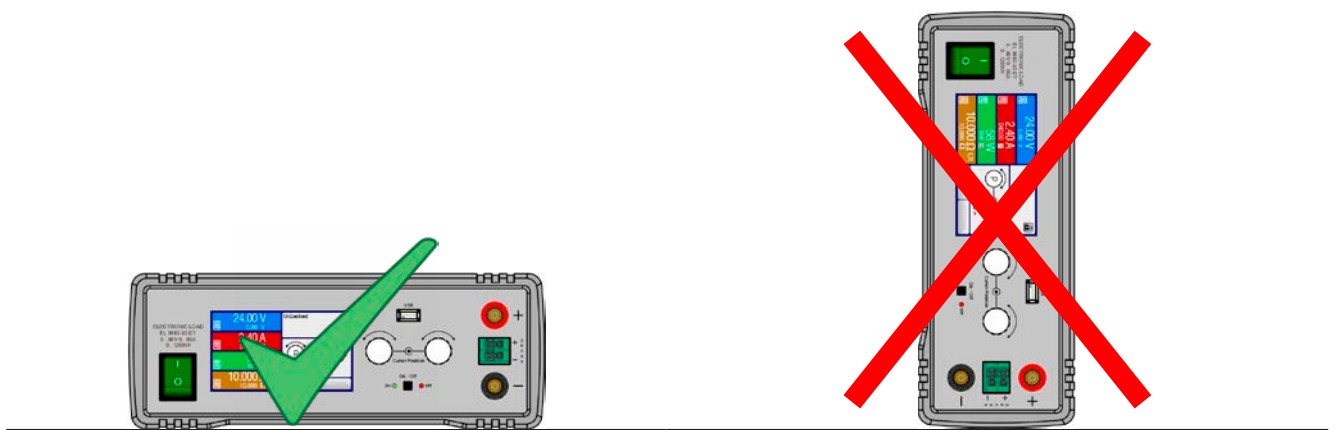

Standing surface

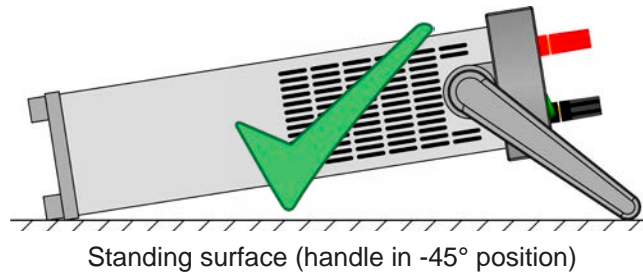

2.3.3.3 Installation in a 19" system

The optionally available 2U mounting frame (see 1.9.4) can be used to install the power supply in a 19" cabinet or other 19" related system with at least 2U of space. The frame will center the device horizontally on the front plate of the frame. The entire front of the device remains accessible.

Due to the relatively short depth of the DT housing, the rear side is probably or only hardly accessible once the frame is installed and tied. It's thus recommended to make all necessary connections before actually inserting the frame into the cabinet.



The mounting frame requires to install and use support rails in the 19" system. The rear part of the frame is 449 mm wide and can rest on small rails capable of supporting the weight of the device.

Recommended procedure (also see *Figure 6* to *Figure 9* below):

1. Remove the carrying handle from the electronic load device:
 - a. Rotate the handle into -90° position. See *Figure 6* below.
 - b. Simultaneously pull on both sides of the handle until the axis can slip out of the housing (also see section 2.3.3.1).
2. Remove the front frame (1). Also remove the rear frame (1) by loosening the 4 screws.
3. Place the mounting brackets (2) and fix them with 2x screw M4x10 and 2x contact disc M4 each. Here it's recommended to use a 90° Torx screw driver (ratchet etc.).
4. Screw the 4 hex spacers (3) M3x10 into the threaded holes which were used to hold the rear frame (*Figure 9*).
5. Place the rear part of the mounting frame (4) on the hex spacers and fix it with 4 screws M3x6 and 4 lock washers M3 (5). Select the window which fits the EL 9000 DT rear side layout (*Figure 10*).
6. If long enough, connect all rear side cables before inserting the frame. If the cables are not long enough, it's best to insert the frame into the 19" system first.
7. Fully insert the frame and tighten the front with typical 19" system front tightening screws (not included).
8. Connect the front side DC input to your source.

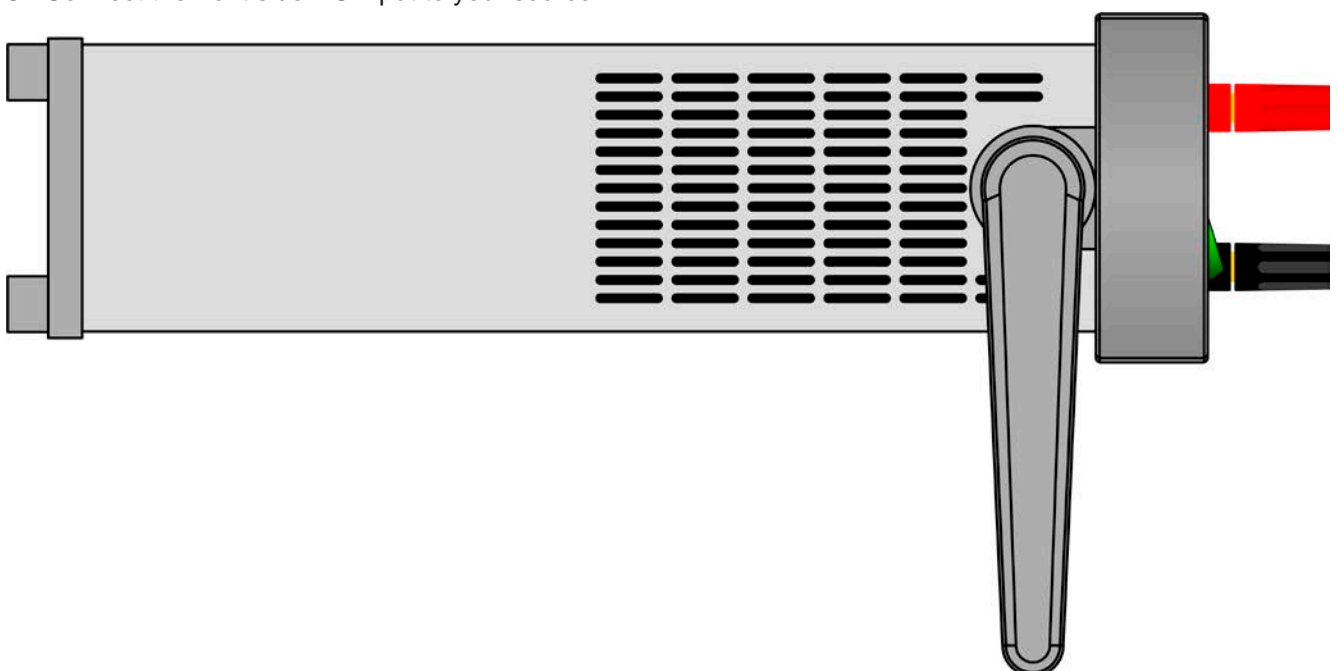

Figure 6 - Position (-90°) of the carrying handle for removal



Figure 7 - Removal of the front and rear frame

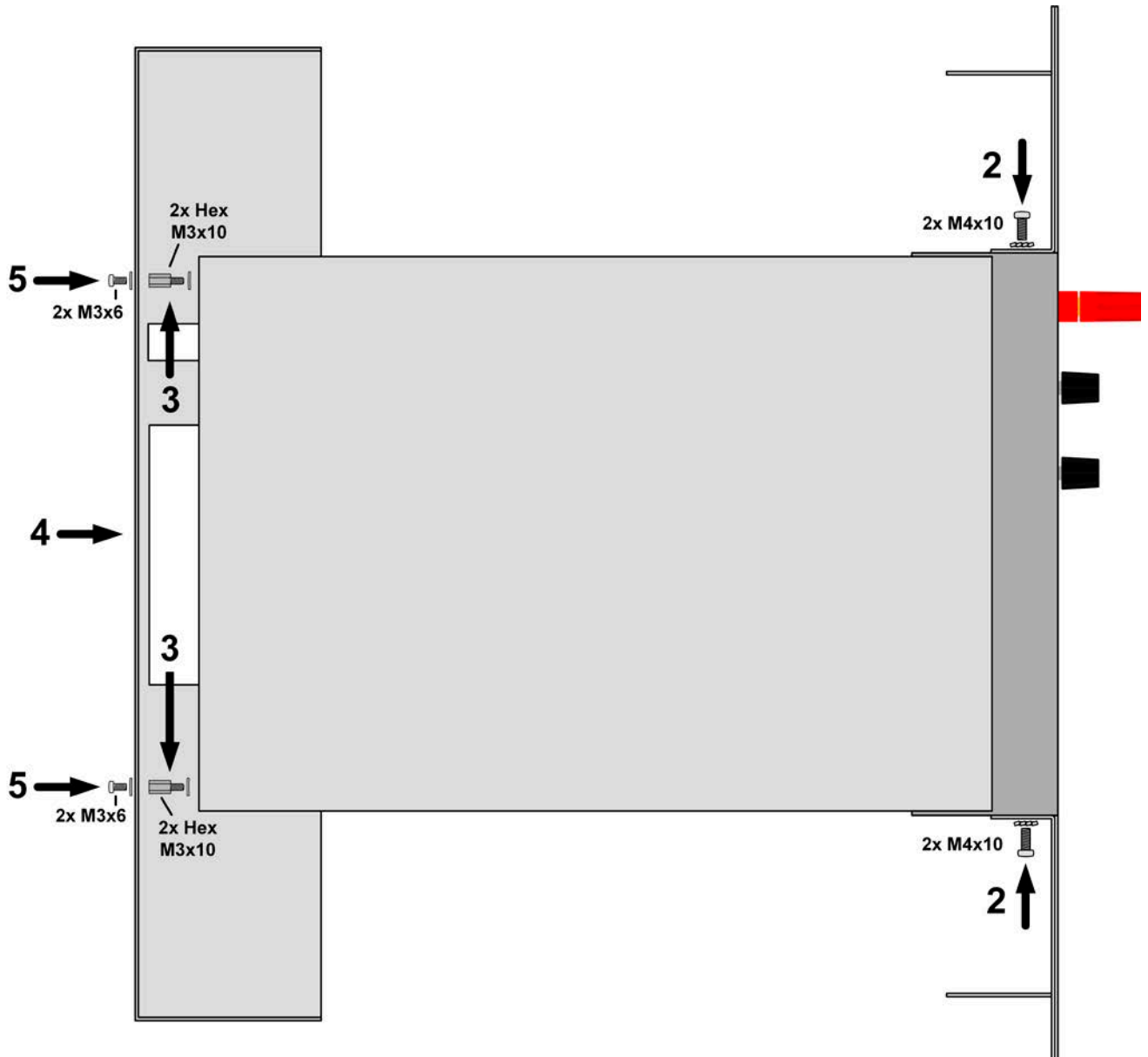

Figure 8 - Assembly steps for the mounting frame

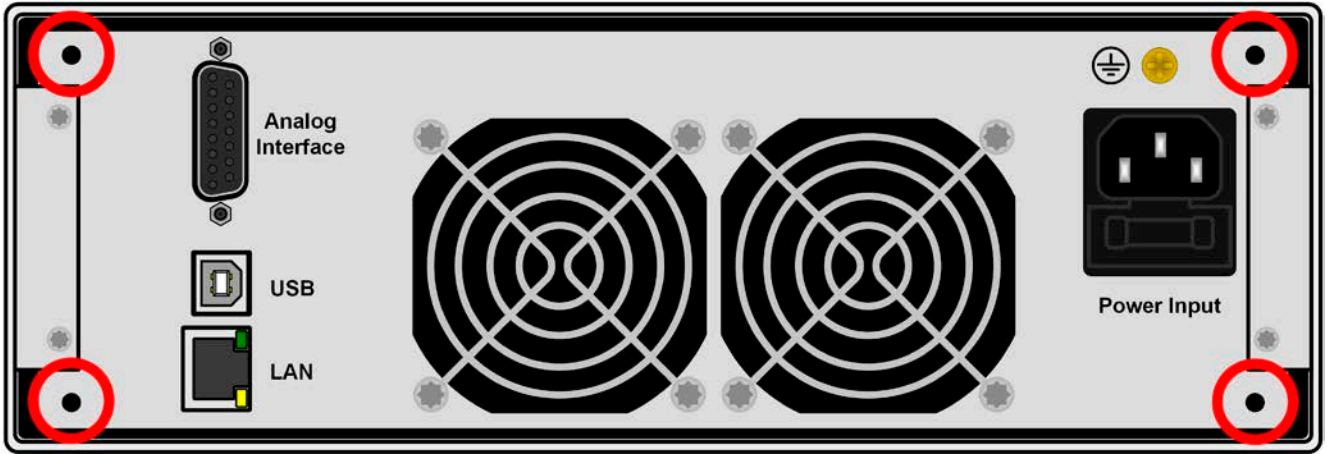

Figure 9 - Positions for the hex spacers (3)

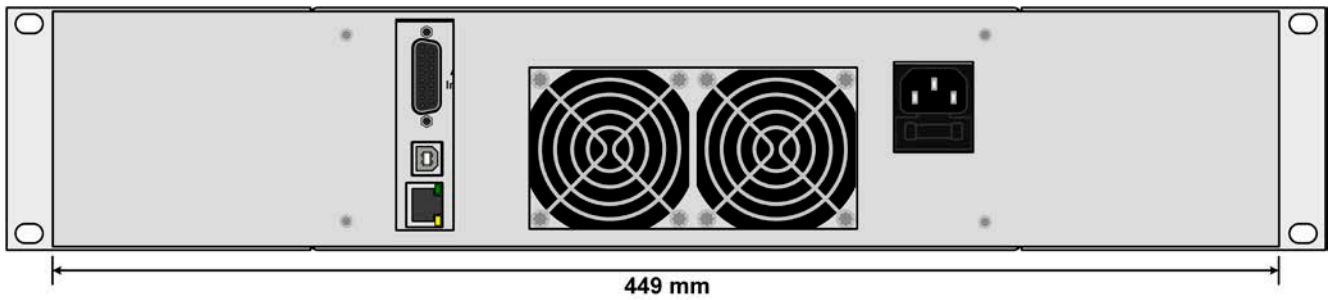

Figure 10 - Rear view after complete assembly of the mounting frame

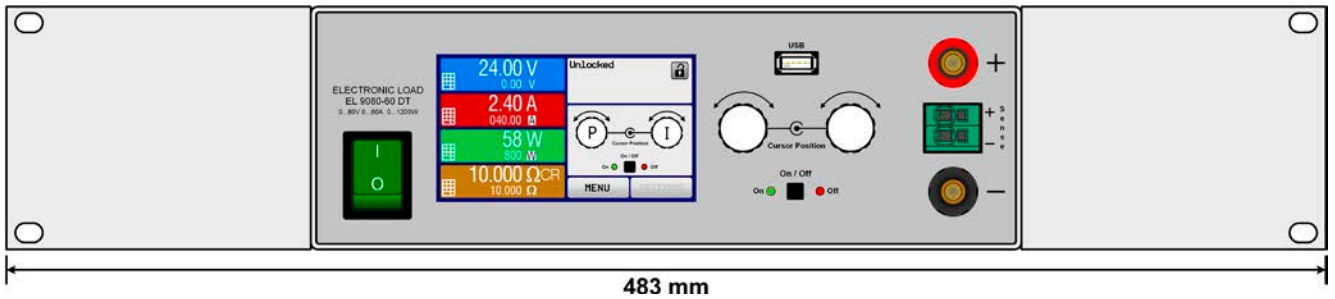

Figure 11 - Front view after complete assembly of the mounting frame

2.3.4 Connection to DC sources



- When using any model which is rated for 40 A or higher current, attention has to be paid to where the load is connected on the DC input terminals. The front-side 4mm connection point is only rated for **max. 32 A!**
- Connection of voltage sources which can generate a voltage higher than 110% nominal of the device model isn't allowed!
- Connection of voltage sources with reversed polarity isn't allowed!

The DC load input is on the front side of the device and isn't protected by a fuse. The cross section of the connection cable is determined by the current consumption, cable length and ambient temperature.

For cables **up to 5 m** and average ambient temperature up to 50°C, we recommend:

up to **10 A**: 0.75 mm² (AWG18) up to **15 A**: 1.5 mm² (AWG14)

up to **20 A**: 4 mm² (AWG10) up to **40 A**: 10 mm² (AWG8)

up to **60 A**: 16 mm² (AWG4)

per lead (multi-conductor, insulated, openly suspended). Single cables of, for example, 16 mm² may be replaced by e. g. 2x 6 mm² etc. If the cables are long then the cross section must be increased to avoid voltage loss and overheating.

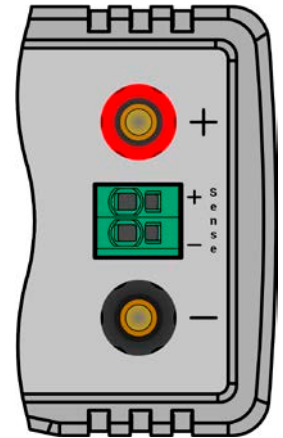

2.3.4.1 Possible connections on the DC input

The DC input on the front is of type clamp & plug and can be used with:

- 4 mm system plugs (Büschel, banana, safety) for **max. 32 A**
- Spade lugs (6 mm or bigger)
- Soldered cable ends (only recommended for small currents up to 10 A)

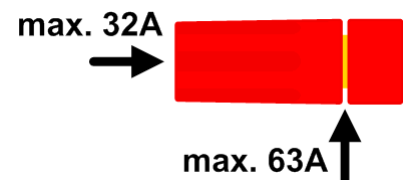

When using any type of lugs or cable end sleeves, only use those with insulation to ensure electric shock protection!

2.3.5 Grounding of the DC input

The device can always be grounded on the DC minus pole, i.e. can be directly connected to PE. The DC plus pole, however, if it's to be grounded, may only be so for input voltages up to 400 V, because the potential of the minus pole is shifted into negative direction by the value of the input voltage. Also see technical specification sheets in 1.8.2, item "Insulation".

For this reason, for all models which can support an input voltage higher than 400 V grounding of the DC plus pole isn't allowed.



Do not ground the DC plus pole on any model with >400 V nominal voltage

2.3.6 Connection of remote sensing



- *Remote sensing is only effective during constant voltage operation (CV) and for other regulation modes the sense input should be disconnected, if possible, because connecting it generally increases the oscillation tendency.*
- *The cross section of the sensing cables is noncritical. Recommendation for cables up to 5 m: use at least 0.5 mm²*
- *Sensing cables should be twisted and laid close to the DC cables to damp oscillation. If necessary, an additional capacitor can be installed at the source to eliminate oscillation*
- *Sensing cables must be connected + to + and - to - at the source, otherwise the sense input of the device can be damaged. For an example see Figure 12 below.*

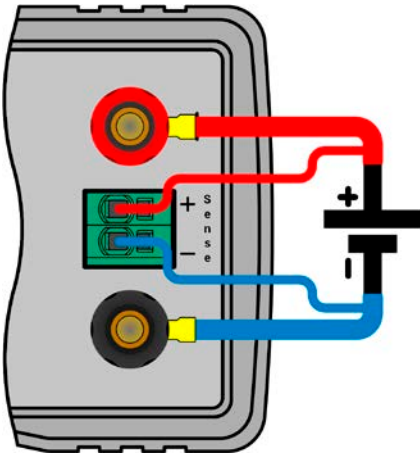

Figure 12 - Example for remote sensing wiring

The connector Sense is a clamp terminal. It means for the remote sensing cables:

- Insert cables: crimp sleeves onto the cable ends and simply push them into the bigger square hole
- Remove cables: use a small flat screwdriver and push into the smaller square hole next to the bigger one to loosen the cable clamp, then remove cable end

2.3.7 Connecting the analog interface

The 15 pole connector (Type: Sub-D, D-Sub) on the rear side is an analog interface. To connect this to a controlling hardware (PC, electronic circuit), a standard plug is necessary (not included in the scope of delivery). It's generally advisable to switch the device completely off before connecting or disconnecting this connector, but at least the DC input.

2.3.8 Connecting the USB port (rear side)

In order to remotely control the device via this port, connect the device with a PC using the included USB cable and switch the device on.

2.3.8.1 Driver installation (Windows)

On the initial connection with a PC the operating system will identify the device as new hardware and will try to install a driver. The required driver is for a Communications Device Class (CDC) device and is usually integrated in current operating systems such as Windows 7 or 10. But it's strongly recommended to use the included driver installer (on USB stick) to gain maximum compatibility of the device to our softwares.

2.3.8.2 Driver installation (Linux, MacOS)

We can't provide drivers or installation instructions for these operating systems. Whether a suitable driver is available is best found out by searching the Internet. With newer versions of Linux or MacOS, a generic CDC driver should be "on board".

2.3.8.3 Alternative drivers

In case the CDC driver described above isn't available on your system, or for some reason do not function correctly, commercial suppliers can help. Search the Internet for suppliers using the keywords "cdc driver windows" or "cdc driver linux" or "cdc driver macos".

2.3.9 Initial commission

For the first start-up after purchasing and installing the device, the following procedures have to be executed:

- Confirm that the connection cables to be used are of a satisfactory cross section!
- Check if the factory settings of set values, safety and monitoring functions and communication are suitable for your intended application of the device and adjust them if required, as described in the manual!
- In case of remote control via PC, read the additional documentation for interfaces and software!
- In case of remote control via the analog interface, read the section in this manual concerning analog interfaces!

2.3.10 Commission after a firmware update or a long period of non use

In case of a firmware update, return of the equipment following repair or a location or configuration change, similar measures should be taken to those of initial start up. Refer to „2.3.9. *Initial commission*“.

Only after successful checking of the device as listed may it be operated as usual.

3. Operation and application

3.1 Personal safety



- In order to guarantee safety when using the device, it's essential that only persons operate the device who are fully acquainted and trained in the required safety measures to be taken when working with dangerous electrical voltages
- For models which accept dangerous voltages, a protection against unwanted physical contact has to be installed on the DC input
- Whenever the DC input is being re-configured, you must switch off or even better, disconnect the source!

3.2 Operating modes

An electronic load is internally controlled by different control or regulation circuits, which shall bring voltage, current and power to the adjusted values and hold them constant, if possible. These circuits follow typical laws of control systems engineering, resulting in different operating modes. Every operating mode has its own characteristics which is explained below in short form.

3.2.1 Voltage regulation / Constant voltage

Constant voltage operation (CV) or voltage regulation is a subordinate operating mode of electronic loads. In normal operation, a voltage source is connected to device, which represents a certain input voltage for the load. If the set value for the voltage in constant voltage operation is higher than the actual voltage of the source, the value can't be reached. The load will then take no current from the source. If the voltage set value is lower than the input voltage then the load will attempt to drain enough current from the source to achieve the desired voltage level. If the resulting current exceeds the maximum possible or adjusted current value or the total power according to $P = U_{IN} * I_{IN}$ is reached, the load will automatically switch to constant current or constant power operation, whatever comes first. Then the adjusted input voltage can no longer be achieved.

While the DC input is switched on and constant voltage mode is active, then the condition "CV mode active" will be shown on the graphics display by the abbreviation CV, as well it will be passed as a signal to the analog interface and stored as internal status which can be read via digital interface.

3.2.1.1 Speed of the voltage controller

The internal voltage controller can be switched between **Slow** and **Fast** (see „3.4.3.1. Menu "General Settings""). Factory default value is "Slow". Which setting to select depends on the actual situation in which the device is going to be operated, but primarily it depends of the type of voltage source. An active, regulated source such as a switching mode power supply has its own voltage control circuit which works concurrently to the load's circuit. Both might work against each other and lead to oscillation. If this occurs it's recommended to set the controller speed to "Slow".

In other situations, e. g. operating the function generator and applying various functions to the load's input voltage and setting of small time increments, it might be necessary to set the voltage controller to "Fast" in order to achieve the expected results.

3.2.1.2 Minimum voltage for maximum current

Due to technical reasons, all models in this series have a minimum internal resistance that makes the unit to be supplied with a minimum input voltage (U_{MIN}) in order to be able to draw the full current (I_{MAX}). This minimum input voltage varies from model to model and is listed in the technical specifications. If less voltage than U_{MIN} is supplied, the load proportionally draws less current, which can be calculated easily.

See principle view to the right.

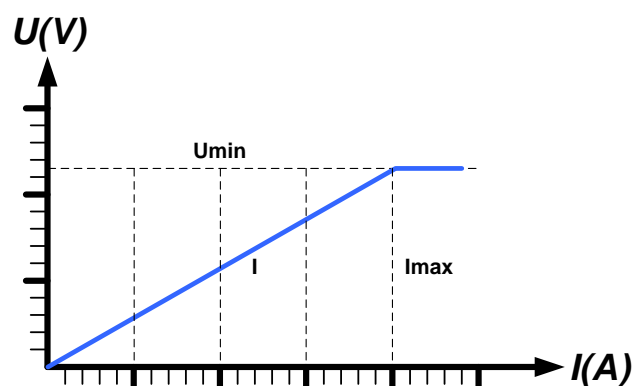

3.2.2 Current regulation / constant current / current limitation

Current regulation is also known as current limitation or constant current mode (CC) and is fundamental to the normal operation of an electronic load. The DC input current is held at a predetermined level by varying the internal resistance according to Ohm's law $R = U / I$ such that, based on the input voltage, a constant current flows. Once the current has reached the adjusted value, the device automatically switches to constant current mode. However, if the power consumption reaches the adjusted power level, the device will automatically switch to power limitation and adjust the input current according to $I_{MAX} = P_{SET} / U_{IN}$, even if the maximum current set value is higher. The current set value, as determined by the user, is always and only an upper limit.

While the DC input is switched on and constant current mode is active, the condition "CC mode active" will be shown on the graphics display by the abbreviation CC, as well it will be passed as a signal to the analog interface and stored as internal status which can be read via digital interface.

3.2.3 Resistance regulation / constant resistance

Inside electronic loads, whose operating principle is based on a variable internal resistance, constant resistance mode (CR) is almost a natural characteristic. The load attempts to set the internal resistance to the user defined value by determining the input current depending on the input voltage according to Ohm's law $I_{IN} = U_{IN} / R_{SET}$. The internal resistance is naturally limited between almost zero and maximum (resolution of current regulation too inaccurate). As the internal resistance can't have a value of zero, the lower limit is defined to an achievable minimum. This ensures that the device, at very low input voltages, can consume a high input current from the source, up to the maximum.

While the DC input is switched on and constant resistance mode is active, the condition "CR mode active" will be shown on the graphics display by the abbreviation CR, as well it will be stored as internal status which can be read via digital interface.

3.2.4 Power regulation / constant power / power limitation

Power regulation, also known as power limitation or constant power (CP), limits the DC input power of the device at the adjusted value, so that the current flowing from the source, together with the input voltage, achieves the desired value. Power limitation then limits the input current according to $I_{IN} = P_{SET} / U_{IN}$ as long as the power source is able to provide this power.

Power limitation operates according to the auto-range principle such that at lower input voltages higher current can flow and vice versa, in order to maintain constant power within the range P_N (see diagram to the right).

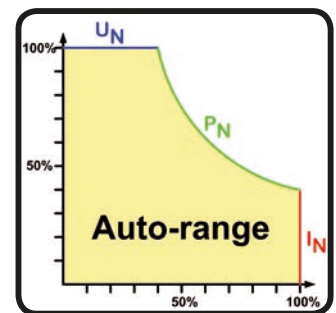

While the DC input is switched on and constant power operation is active, the condition "CP mode active" will be shown on the graphic display by the abbreviation CP, as well it will be stored as internal status which can be read via digital interface.

Constant power operation impacts the internal set current value. This means that the maximum set current may not be reachable if the set power value according to $I = P / U$ sets a lower current. The user defined and displayed set current value is always the upper limit only.

3.2.4.1 Temperature dependent derating

This series consists of conventional electronic loads which convert the consumed electrical energy into heat and dissipate it. In order to avoid overheating, the device will automatically reduce, i.e. derate the actual input power when heating up. It means, at a cold start it can take the peak power (see technical specs) for a certain time before it starts reducing.

This derating is depending on the ambient temperature. It means, that at 10°C the load can take the peak power for a much longer time than at 20°C ambient temperature or higher. Disregarding the ambient temperature, the derating will be constant at a certain power per degree Kelvin (x W/K, see technical specifications), down to the steady power which is rated for the typical ambient temperature of 40°C (104°F) and further down.

The time which elapses during the derating phase, is typically between 150 and 210 seconds. It includes the peak power time.

If the device is supplied with less power than the rated steady power at a certain ambient temperature, the derating won't necessarily impact the operation. However, the internal power reduction is always imminent. For example, if you would run a model with rated 600 W steady power at 400 W constant actual power while the power limit is set to 1200 W and your source would make a voltage step or the load a current step, the power limit of 1200 W could still not be achieved.

See the diagrams below for clarification.

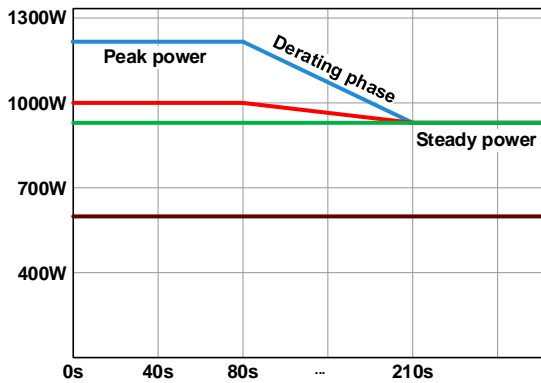

Principle derating progression, depicted on the models of the 1200 W power class.

The peak power is absorbed by the load device for a time x , until derating starts. After the start of derating, the max. power of the load will settle around the point of steady power. The momentary true value of steady power can only be read from the device's actual power value (display or via interface). In case the ambient temperature rises, the derating will continue.

blue / red / green: models with 80 V, 200 V and 360 V

brown: models with 500 V and 750 V

3.2.5 Dynamic characteristics and stability criteria

An electronic load is characterised by short rise and fall times of the current, which are achieved by a high bandwidth of the internal regulation circuit.

In case of testing sources with own regulation circuits at the load, like for example power supplies, a regulation instability may occur. This instability is caused if the complete system (feeding source and electronic load) has too little phase and gain margin at certain frequencies. 180° phase shift at $> 0\text{dB}$ amplification fulfils the condition for an oscillation and results in instability. The same can occur when using sources without own regulation circuit (eg. batteries), if the connection cables are highly inductive or inductive-capacitive.

The instability isn't caused by a malfunction of the load, but by the behaviour of the complete system. An improvement of the phase and gain margin can solve this. In practice, a capacity is directly connected to the DC input of the load. The value to achieve the expected result isn't defined and has to be found out. We recommend:

80 V models: 1000 μF ...4700 μF

200 V models: 100 μF ...470 μF

360 V models: 68 μF ...220 μF

500 V models: 47 μF ...150 μF

750 V models: 22 μF ...100 μF

3.3 Alarm conditions



This section only gives an overview about device alarms. What to do in case your device indicates an alarm condition is described in section „3.6. Alarms and monitoring“.

As a basic principle, all alarm conditions are signaled optically (text + message in the display), acoustically (if activated) and as a readable status and alarm counter via the digital interface. In addition, the alarms are reported as signals on the analogue interface. For later acquisition, an alarm counter can be read from the display or via digital interface.

3.3.1 Power Fail

Power Fail (PF) indicates an alarm condition which may have various causes:

- AC input voltage too low (mains undervoltage, mains failure)
- Defect in the input circuit (PFC)

As soon as a power fail occurs, the device will stop to sink power and switch off the DC input. In case the power fail was an undervoltage and is gone later on, the alarm will vanish from display and doesn't require to be acknowledged.

The condition of the DC input after a gone PF alarm can be determined in the MENU. See 3.4.3.



The device can't distinguish between intended (power switch) and unintended (blackout) disconnection from AC and thus will also signalize a PF alarm every time the device is switched off. It has to be ignored in this moment.

3.3.2 Overtemperature

An overtemperature alarm (OT) can occur from an excess temperature inside the device and causes it to stop sinking power temporarily. This can occur due to a defect of the internal fan regulation or due to excessive ambient temperature.

After cooling down, the device will automatically continue to work, while the condition of the DC input remains and the alarm doesn't require to be acknowledged.

3.3.3 Overvoltage

An overvoltage alarm (OVP) will switch off the DC input and can occur if:

- the connected voltage source provides a higher voltage to the DC input than set in the overvoltage alarm threshold (OVP, 0...103% U_{NOM})

This function serves to warn the user of the device acoustically or optically that the connected voltage source has generated an excessive voltage and thereby could damage or even destroy the input circuit and other parts of the device.



The device is not fitted with protection from external overvoltage and could even be damaged when not powered.

3.3.4 Overcurrent

An overcurrent alarm (OCP) will switch off the DC input and can occur if:

- The input current in the DC input exceeds the adjusted OCP limit.

This function serves to protect the voltage and current source so that this isn't overloaded and possibly damaged, rather than offering protection to the device.

3.3.5 Overpower

An overpower alarm (OPP) will switch off the DC input and can occur if:

- the product of the input voltage and input current in the DC input exceeds the adjusted OPP limit.

This function serves to protect the voltage and current source so that this isn't overloaded and possibly damaged, rather than offering protection to the device.

3.4 Manual operation

3.4.1 Powering the device

The device should, as far as possible, always be switched on using the toggle switch on the front of the device. After switching on, the display will first show the company logo, followed by a language selection which will close automatically after 3 seconds and later manufacturer's name and address, device type, firmware version(s), serial number and item number.

In setup (see section „3.4.3. Configuration via MENU“), in the second level menu **General settings** is an option **DC input after power ON** in which the user can determine the condition of the DC input after power-up. Factory setting here is **OFF**, meaning that the DC input will always be switched off on power-up, while **Restore** means that the last condition of the DC input will be restored, either on or off. All set values are also restored.



For the time of the start phase the analog interface can signal undefined statuses on the output pins such as ALARMS 1. Those signals must be ignored until the device has finished booting and is ready to work.

3.4.2 Switching the device off

On switch-off, the last input condition and the most recent set values and input status are saved. Furthermore, a PF alarm (power failure) will be reported, but has to be ignored here.

The DC input is immediately switched off and after a short while fans will shut down and after another few seconds the device will be completely powered off.

3.4.3 Configuration via MENU

The MENU serves to configure all operating parameters which are not constantly required. These can be set by finger touch on the MENU touch area, but only if the DC input is switched OFF. See figure to the right.

If the DC input is switched on the settings menu won't be shown, only status information.

Menu navigation is by finger touch. Values are set using the rotary knobs. The assignment of the knobs to the adjustable values isn't indicated in menu pages, but there is an assignment rule: upper value -> left-hand knob, lower values -> right-hand knob.

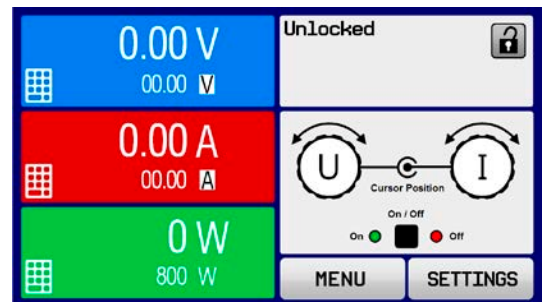

Some setting parameters are self-explanatory, others are not. Those will be explained on the next pages.

3.4.3.1 Menu “General Settings”

Setting	Description
Allow remote control	Selection No means that the device can't be remotely controlled over either the digital or analog interfaces. If remote control isn't allowed, the status will be shown as Local in the status area on the main display. Also see section 1.9.5.1.
Analog interface range	Selects the voltage range for the analog set values, monitoring outputs and reference voltage output. <ul style="list-style-type: none"> • 0...5 V = Range is 0...100% set /actual values, reference voltage 5 V • 0...10 V = Range is 0...100% set /actual values, reference voltage 10 V See also section „3.5.4. Remote control via the analog interface (AI)“
Analog interface Rem-SB	Selects how the input pin REM-SB of the analog interface shall be working regarding levels and logic: <ul style="list-style-type: none"> • Normal = Levels and function as described in the table in 3.5.4.4 • Inverted = Levels and function will be inverted Also see „3.5.4.7. Application examples“
Analog Rem-SB action	Selects the action on the DC input that is initiated when changing the level of analog input REM-SB: <ul style="list-style-type: none"> • DC OFF = the pin can only be used to switch the DC input off • DC ON/OFF = the pin can be used to switch the DC input off and on again, if it has been switched on before at least from a different control location
Analog interface pin 6	Pin 6 of the analog interface (see section 3.5.4.4) is by default assigned to only signal the device alarms OT and PF. This parameter allows to also enable signalling only one of both (3 possible combinations): <ul style="list-style-type: none"> • Alarm OT = Enable/disable signaling of alarm OT on pin 6 • Alarm PF = Enable/disable signaling of alarm PF on pin 6
Analog interface pin 14	Pin 14 of the analog interface (see section 3.5.4.4) is by default assigned to only signal the device alarm OVP. This parameter allows to also enable signaling further device alarms (7 possible combinations): <ul style="list-style-type: none"> • Alarm OVP = Enable/disable signaling of alarm OVP on pin 14 • Alarm OCP = Enable/disable signaling of alarm OCP on pin 14 • Alarm OPP = Enable/disable signaling of alarm OPP on pin 14
Analog interface pin 15	Pin 15 of the analog interface (see section 3.5.4.4) is by default assigned to only signal the regulation mode CV. This parameter allows to enable signaling a different device status (2 options): <ul style="list-style-type: none"> • Regulation mode = Enable/disable signaling of CV reg mode on pin 15 • DC status = Enable/disable signaling of DC input status on pin 15
DC input after OT alarm	Determines how the DC power stages shall react after an overtemperature (OT) alarm has occurred and the power stages have cooled down again: <ul style="list-style-type: none"> • OFF = DC power stage(s) will be off • AUTO = The device will automatically restore the situation before the OT alarm, which usually means the DC power stage(s) to be on
DC input after power ON	Determines the condition of the DC input after power-up. <ul style="list-style-type: none"> • OFF = DC input is always off after switching on the device. • Restore = DC input condition will be restored to the condition prior to switch off.
Voltage controller setting	Selects the regulation speed of the internal voltage regulator between Slow and Fast . See „3.2.1.1. Speed of the voltage controller“.
DC input after PF alarm	Determines how the DC input shall react after a power fail (PF) alarm has occurred: <ul style="list-style-type: none"> • OFF = DC input will be switched off and remain until user action • AUTO = DC input will switch on again after the PF alarm cause is gone and if it was switched on before the alarm occurred

Setting	Description
DC input after remote	Determines the condition of the DC input after leaving remote control either manually or by command. <ul style="list-style-type: none"> • OFF = DC input will be always off when switching from remote to manual • AUTO = DC input will keep the last condition
Enable R mode	Activates the internal resistance control with Yes or deactivates it with No . If activated, the resistance set value can be adjusted on the main screen as additional value. For details refer to „3.2.3. Resistance regulation / constant resistance“.
USB file separator format	Switches the decimal point format of values and also the CSV file separator for USB logging (see 1.9.5.5 and 3.4.10), as well as for other features where a CSV file can be loaded <ul style="list-style-type: none"> • US = Comma separator (US standard for CSV files) • Default = Semicolon separator (german/european standard for CSV files)
USB logging with units (V,A,W)	CSV files generated from USB logging by default add physical units to values. This can be deactivated by setting this option to No
Calibrate device	Touch area Start starts a calibration routine (see „4.3. Calibration“), but only if the device is in U/I or P/I mode.
Reset device to defaults	Touch area Start will initiate a reset of all settings (HMI, profile etc.) to factory default, as shown in the menu structure diagrams on the previous pages
Restart device	Will initiate a warm start of the device

3.4.3.2 Menu “User Events”

See „3.6.2.1 User defined events“ on page 50.

3.4.3.3 Menu “Profiles”

See „3.9 Loading and saving an user profile“ on page 52.

3.4.3.4 Menu “Overview”

This menu page displays an overview of the set values (U, I, P or U, I, P, R) and alarm settings as well as adjustment limits.

3.4.3.5 Menu “About HW, SW...”

This menu page displays an overview of device relevant data such as serial number, article number etc., as well as an alarm history which lists the number of device alarms that probably occurred since the device has been powered.

3.4.3.6 Menu “Function Generator”

See „3.10 The function generator“ on page 53.

3.4.3.7 Menu “Communication”

Here settings for the Ethernet port are configured. The USB port there doesn't require any settings.

After delivery or a complete reset, the Ethernet port has following default settings assigned:

- DHCP: off
- IP: 192.168.0.2
- Subnet mask: 255.255.255.0
- Gateway: 192.168.0.1
- Port: 5025
- DNS: 0.0.0.0
- Host name: empty, but configurable via HMI
- Domain: empty, but configurable via HMI

Those settings can be changed anytime and configured to meet local requirements. Furthermore, there are global communication settings available regarding timing and protocols.

Submenu "Ethernet -> IP Settings"

Element	Description
DHCP	With setting DHCP the device will instantly try to get network parameters (IP, subnet mask, gateway, DNS) assigned from a DHCP server after power-on or when changing from Manual to DHCP and submitting the change with button ENTER. If the DHCP configuration attempt fails, the device will use the settings from Manual . In this case, the overview in screen View settings will indicate the DHCP status as DHCP (failed) , otherwise as DHCP(active)
Manual	Manual (default setting): uses either the default network parameters (after reset) or the last user setting. Those parameters are not overwritten by selection DHCP and are thus available when switching to Manual again.
IP address	Only available with setting Manual . Default value: 192.168.0.2 Permanent manual setting of the device's IP address in standard IP format
Subnet mask	Only available with setting Manual . Default value: 255.255.255.0 Permanent manual setting of the subnet mask in standard IP format
Gateway	Only available with setting Manual . Default value: 192.168.0.1 Permanent manual setting of the gateway address in standard IP format
Port	Default value: 5025 Adjust the socket port here, which belongs to the IP address and serves for TCP/P access when controlling the device remotely via Ethernet
DNS address	Default value: 0.0.0.0 Permanent manual setting of the network address of a domain name server (short: DNS) which has to be present in order to translate the host name to the device's IP, so the device could alternatively access by the host name

Submenu "Ethernet"

Element	Description
Host name	Configure the host name for the device here for the use with a local DNS entry
Domain name	Configure the domain name for the device here for the use with a local DNS entry
TCP Keep-Alive	Default setting: disabled Enables/disables the "keep-alive" functionality of TCP.

Submenu "Com Protocols" (communication protocols)

Element	Description
SCPI / ModBus RTU	Default setting: both enabled Enables/disables SCPI or ModBus RTU communication protocols for the device. The change is immediately effective after submitting it with ENTER button. Only one of both can be disabled.

Submenu "Com Timeout" (communication timeout)

Element	Description
Timeout USB (ms)	Default value: 5, Range: 5...65535 USB/RS232 communication timeout in milliseconds. Defines the max. time between two subsequent bytes or blocks of a transferred message. For more information about the timeout refer to the external programming documentation "Programming ModBus RTU & SCPI".
Timeout ETH (s)	Default value: 5, Range: 5...65535 Defines a timeout after which the device would close the socket connection if there was no command communication between the controlling unit (PC, PLC etc.) and the device for the adjusted time. The timeout is ineffective as long as option TCP Keep-alive is enabled.

3.4.3.8 Menu “HMI settings”

These settings refer exclusively to the control panel (HMI).

Element	Description
Language	Selection of the display language between German, English, Russian or Chinese. This selection screen is also shown for 3 seconds during the startup phase of the device.
Backlight Setup	The choice here is whether the backlight remains permanently on or if it should be switched off when no input via screen or rotary knob is made for 60 s. As soon as input is made, the backlight returns automatically. Furthermore the backlight intensity can be adjusted here.
HMI Lock	See „3.7 Control panel (HMI) lock“ on page 51.
Limits Lock	See „3.8 Limits lock“ on page 51
Key Sound	Activates or deactivates sounds when touching a touch area in the display. It can usefully signal that the action has been accepted.
Alarm Sound	Activates or deactivates the additional acoustic signal of an alarm or user defined event which has been set to Action = ALARM . See also „3.6 Alarms and monitoring“ on page 48.
Status Page	Enables/disables two display related options for the main screen with actual and set values: Show meter bar: in U/I/P mode, i. e. resistance mode not activated, a meter bar for 0-100% actual values of voltage, current and power is shown (see example figure below) Alternative status page: switches the main screen of the device with its actual and set values of voltage, current, power and - if activated - resistance to a simpler display with only voltage and current, plus status. Default setting: both disabled

3.4.4 Adjustment limits



Adjustment limits are only effective on the related set values, no matter if using manual adjustment or remote control!



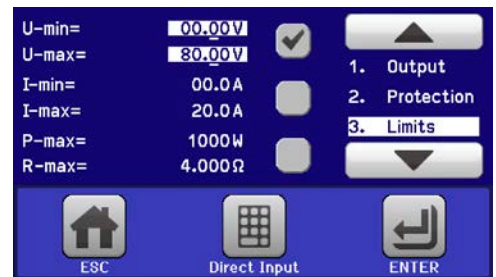

Defaults are, that all set values (U, I, P, R) are adjustable from 0 to 102% of the rated value.

This may be obstructive in some cases, especially for protection of applications against overcurrent. Therefore upper and lower limits for current (I) and voltage (U) can be set which limit the range of the adjustable set values.

For power (P) and resistance (R) only upper value limits can be set.



► How to configure the adjustment limits:

1. On the main screen, tap **SETTINGS** to access the SETTINGS menu.
2. Tap the arrows   to select "3. Limits".
3. In each case a pair of upper and lower limits for U/I or the upper limit for P/R are assigned to the rotary knobs and can be adjusted. Tap the selection area for another choice .
4. Accept the settings with .



The set values can be entered directly using the ten-key pad. This appears when tapping touch area "Direct input".



The adjustment limits are coupled to the set values. It means, that the upper limit may not be set lower than the corresponding set value. Example: If you wish to set the upper limit for the current (I-max) to 35 A while the set value of currently is adjusted to 40 A, then the set value of current would first have to be reduced to 35 A or less in order to enable setting I-max down to 35 A.

3.4.5 Changing the operating mode

In general, the manual operation of an EL 9000 DT distinguishes between three operating modes, U/I, P/I and R/I, which are tied to set value input using the rotary knobs or ten-key pad. This assignment must be changed if one of the four set values is to be adjusted which is currently not assigned to any of the knobs.

► How to change the operating mode (two options)

1. Unless the device is device in remote control or the panel is locked, you can switch the operation mode anytime. Tap the depiction of the left-hand knob (see figure to the right) to change its assignment between U, P and R.
2. Directly tap on the coloured areas with the set values, like shown in the figure to the right. The physical unit next to the set value, when inverted, indicates the assignment of the knob. In the example in the figure it has P and I assigned, which means P/I mode.

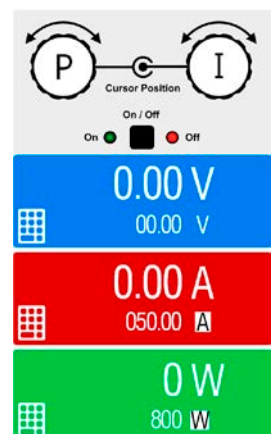

Depending on the selection the left rotary knob will be assigned different setting values, the right knob is always assigned to the current.



In order to avoid constant changing of the assignments it's possible, e. g. with selection R/I, to change the other values U and P by direct input. Also see section 3.4.6.

The actual operating mode of the load, which is only effective and indicated while the DC input is switched on, solely depends on the set values. For more information see section „3.2. Operating modes“.

3.4.6 Manual adjustment of set values

The set values for voltage, current, power and resistance are the fundamental operating possibilities of an electronic load and hence the two rotary knobs on the front of the device are always assigned to two of the four values in manual operation. Default assignment is power and current.

The set values can be entered manually in two ways: via rotary knob or direct input.



Entering a value changes it immediately and no matter if the DC input is switched on or off.



When adjusting the set values, upper or lower limits may come into effect. See section „3.4.4. Adjustment limits“. Once a limit is reached, the display will show a note like “Limit: U-max” etc. for 1.5 seconds next to the adjusted value or will refuse to accept a value entered by direct input.

► How to adjust values with the rotary knobs

1. First check if the value you want to change is already assigned to one of the rotary knobs. The main screen displays the assignment as depicted in the figure to the right.
2. If, as shown in the example, the assignment is voltage (U, left) and current (I, right), and it's required to set the power, then the assignments can be changed by tapping this touch area. A set of selection fields then appears.
3. After successful selection, the desired value can be set within the defined limits. Selecting a digit is done by pushing the rotary knob which shifts the cursor from right to left (selected digit will be underlined):

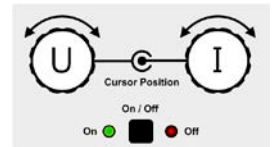

► How to adjust values via direct input

1. In the main screen, depending on the rotary knob assignment, values can be set for voltage (U), current (I), power (P) or resistance (R) via direct input by tapping on the small keypad symbol in the set/actual value display areas, e. g. in the uppermost area of voltage.
2. Enter the required value using the ten-key pad. Similar to a pocket calculator the key **c** clears the input.

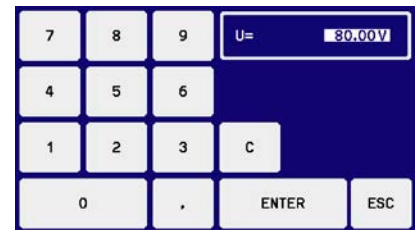

Decimal values are set by tapping the point key. For example, 54.3 V is set with **5** **4** **.** **3** and **ENTER**.

3. The display reverts to the main page and the set values take effect.

3.4.7 Switching the main screen view

The main screen, also called status page, with its set values, actual values and device status can be switched from the standard view mode with three or four values to a simpler mode with only voltage and current display. The advantage of the alternative view mode is that actual values are displayed with **much bigger characters**, so they read be read from a larger distance. Refer to „3.4.3.8. Menu “HMI settings”“ to see where to switch the view mode in the MENU. Comparison:

Standard status page

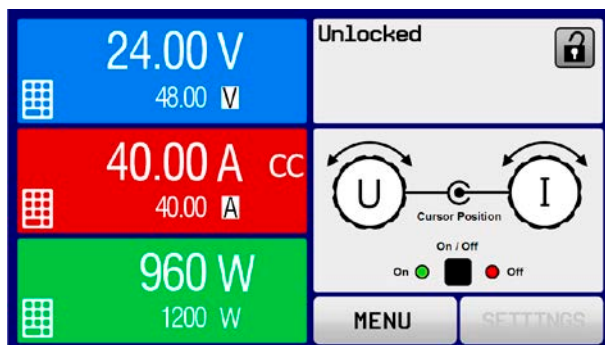

Alternative status page

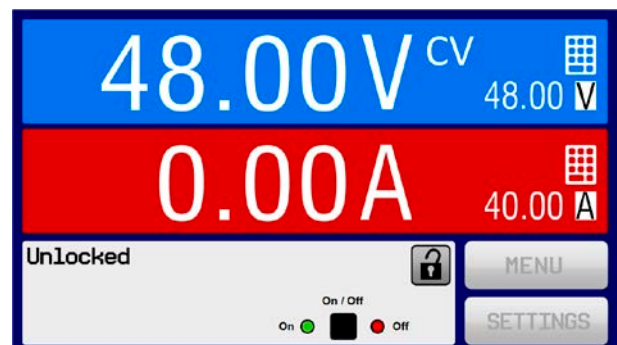

Limitations of the alternative status page:

- Set and actual values of power and resistance are not displayed and the set values are only indirectly accessible
- No access to the settings overview (MENU button) while the DC input is on



In alternative status page mode, the set values of power and resistance are not adjustable while the DC input is switched on. They can only be accessed and adjusted in SETTINGS while the DC input is off.

Rules for manual handling of the HMI in alternative status page mode:

- The two rotary knobs are assigned to voltage (left knob) and current (right knob) all the time, except for menus
- Set values input is the same as in standard status page mode, with knobs or by direct input
- Regulation modes CP and CR are displayed alternatively to CC at the same position

3.4.8 The meter bars

Additionally to the actual values being displayed as numbers, meter bars for U, I and P can be enabled in the MENU. The meter bars are not displayed as long as resistance mode, i. e. U/I/R is activated. Refer to „3.4.3.8. Menu “HMI settings”“ to see where to enable the meter bars in the MENU. Depiction:

Standard status page with meter bar

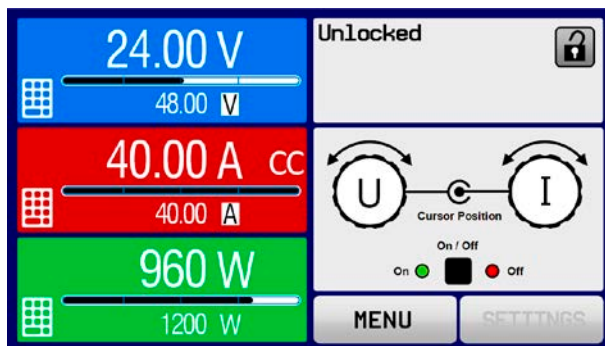

Alternative status page with meter bar

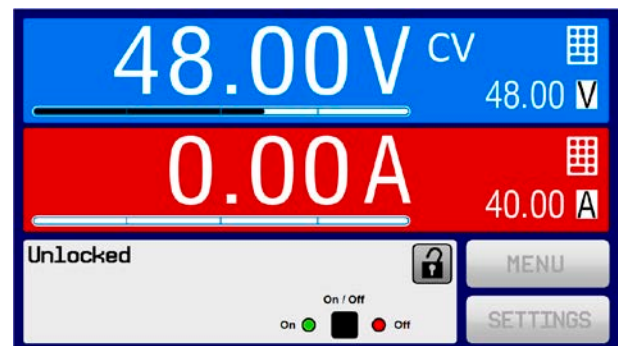

3.4.9 Switching the DC input on or off

The DC input of the device can be manually or remotely switched on and off. This can be restricted in manual operation by the control panel being locked.



Switching the DC input on during manual operation or digital remote control can be disabled by pin REM-SB of the built-in analog interface. For more information refer to 3.4.3.1 and example a) in 3.5.4.7. In such a situation, the device will show a notification in the display.

► How to manually switch the DC input on or off

1. As long as the control panel (HMI) isn't fully locked press the button ON/OFF. Otherwise you are asked to disable the HMI lock (simple unlock or by entering the PIN, if activated in menu "HMI Lock").
2. The ON/OFF button toggles between on and off, as long as a change isn't restricted by any alarm or the device being in "Remote". The DC input condition is shown in the display.

► How to remotely switch the DC input on or off via the analog interface

1. See section „3.5.4 Remote control via the analog interface (AI)“ on page 44.

► How to remotely switch the DC input on or off via the digital interface

1. See the external documentation "Programming Guide ModBus RTU & SCPI" if you are using custom software, or refer to the external documentation of LabView VIs or other documentation provided by EA Elektro-Automatik.

3.4.10 Recording to USB stick (logging)

Device data can be recorded to USB stick (2.0 / 3.0 may work, but not all vendors are supported) anytime. For specifications of the USB stick and the generated log files refer to section „1.9.5.5. USB port (front side)“.



The logging stores files of CSV format on the stick. The layout of the log data is the same as when logging via PC with software EA Power Control. The advantage of USB logging over PC logging is the mobility and that no PC is required. The logging feature just has to be activated and configured in the MENU.

3.4.10.1 Configuration

Also see section 3.4.3.7. After USB logging has been enabled and the parameters “Logging interval” and “Start/Stop” have been set, logging can be started anytime from within the MENU or after leaving it, depends on the selected start/stop mode.

3.4.10.2 Handling (start/stop)

With setting **Start/stop with DC input ON/OFF** logging will start each time the DC input of the device is switched on, no matter if manually with the front button “On/Off” or remotely via analog or digital interface. With setting **Manual start/stop** it's different. Logging is then started and stopped only in the MENU, in the logging configuration page.

Soon after logging has been started, the symbol  indicates the ongoing logging action. In case there is an error while logging, such as USB stick full or removed, it will be indicated by another symbol (). After every manual stop or switching the DC input off the logging is stopped and the log file closed.

3.4.10.3 Log file format

Type: text file in european CSV format

Layout:

	A	B	C	D	E	F	G	H	I	J	K	L	M
1	U set	U actual	I set	I actual	P set	P actual	R set	R actual	R mode	Output/Input	Device mode	Error	Time
2	2,00V	11,92V	1,20A	1,20A	7344W	15W	N/A	N/A	OFF	ON	CC	NONE	00:00:00,942
3	2,00V	11,90V	1,20A	1,20A	7344W	15W	N/A	N/A	OFF	ON	CC	NONE	00:00:01,942
4	2,00V	11,89V	1,20A	1,20A	7344W	15W	N/A	N/A	OFF	ON	CC	NONE	00:00:02,942
5	2,00V	11,87V	1,20A	1,20A	7344W	15W	N/A	N/A	OFF	ON	CC	NONE	00:00:03,942

Legend:

U set / I set / P set / R set: Set values

U actual / I actual / P actual / R actual: Actual values

Error: device alarms

Time: elapsed time since logging start

Device mode: actual regulation mode (also see „3.2. Operating modes“)

Important to know:

- R set and R actual are only recorded if UIR mode is active (refer to section 3.4.5)
- Unlike the logging on PC, every log start here creates a new log file with a counter in the file name, starting generally with 1, but minding existing files

3.4.10.4 Special notes and limitations

- Max. log file size (due to FAT32 formatting): 4 GB
- Max. number of log files in folder HMI_FILES: 1024
- With setting **Start/stop with DC input ON/OFF** the logging will also stop on alarms or events with action “Alarm”, because they switch off the DC input
- With setting **Manual start/stop** the device will continue to log even on occurring alarms, so this mode can be used to determine the period of temporary alarms like OT or PF

3.5 Remote control

3.5.1 General

Remote control is possible via the built-in analog interface, USB port or Ethernet port. Important here is that only the analog or any of the digital interfaces can be in control.

It means that if, for example, an attempt were to be made to switch to remote control via the digital interface whilst analog remote control is active (pin REMOTE = LOW) the device would report an error via the digital interface. In the opposite direction, a switch-over via Pin Remote would be ignored. In both cases, however, status monitoring and reading of values are always possible.

3.5.2 Controls locations

Control locations are those locations from where the device is control. Essentially there are two: at the device (manual control) and external (remote control). The following locations are defined:

Displayed location	Description
-	If neither of the other locations is displayed then manual control is active and access from the analog and digital interfaces is allowed. This location isn't explicitly displayed
Remote	Remote control via any interface is active
Local	Remote control is locked, only manual operation is allowed.

Remote control may be allowed or inhibited using the setting **Allow remote control** (see „3.4.3.1. Menu “General Settings”). In **inhibited** condition, the status **Local** will be displayed top right. Activating the lock can be useful if the device is remotely controlled by software or some electronic device, but it's required to make adjustments at the device or deal with emergency, which would not be possible remotely.

Activating condition **Local** causes the following:

- If remote control via the digital interface is active (displayed as **Remote:**), then it's immediately terminated and in order to continue remote control once **Local** is no longer active, it has to be reactivated at the PC
- If remote control via the analog interface is active (displayed as **Remote:**), then it's temporarily interrupted until remote control is allowed again by deactivating **Local**, because pin REMOTE continues to signal “remote control = on”, unless this has been changed during the **Local** period.

3.5.3 Remote control via a digital interface

3.5.3.1 Selecting an interface

The device only supports the built-in digital interfaces USB and Ethernet.

For USB, a standard USB cable is included in the delivery, as well as a driver for Windows on USB stick. The USB interface requires no setup in the MENU.

The Ethernet interface typically requires network setup (manual or DHCP), but can also be used with its default parameters right from the start.

3.5.3.2 General

For the network port installation refer to „1.9.7. Ethernet port“.

The digital interface require little or no setup for operation and can be directly used with their default configuration. All specific settings will be permanently stored, but could also be reset to defaults with the setup menu item **Reset Device**.

Via the digital interface primarily the set values (voltage, current, power) and device conditions can be set and monitored. Furthermore, various other functions are supported as described in separate programming documentation.

Changing to remote control will retain the last set values for the device until these are changed. Thus a simple voltage control by setting a target value is possible without changing any other values.

3.5.3.3 Programming

Programming details for the interfaces, the communication protocols etc. are to be found in the documentation “Programming Guide ModBus RTU & SCPI” which is supplied on the included USB stick or which is available as download from the EA Elektro-Automatik website.

3.5.4 Remote control via the analog interface (AI)

3.5.4.1 General

The built-in, galvanically isolated, 15-pole analog interface (short: AI) is on the back side of the device offers the following possibilities:

- Remote control of current, voltage, power and resistance
- Remote status monitoring (CV, DC input status)
- Remote alarm monitoring (OT, OVP, OPP, OCP, PF)
- Remote monitoring of actual values
- Remote on/off switching of the DC input

Setting the **three** set values of voltage, current and power via the analog interface must always be done concurrently. It means, that for example the voltage can't be given via the AI and current and power set by the rotary knobs, or vice versa. The internal resistance set value can additionally be adjusted.

The OVP set value and other supervision (events) and alarm thresholds can't be set via the AI and therefore must be adapted to the given situation before the AI will be in control. Analog set values can be supplied by an external voltage or generated from the reference voltage on pin 3. As soon as remote control via the analog interface is activated, the display set values will be those provided by the interface.

The AI can be operated in the common voltage ranges 0...5 V and 0...10 V, both representing 0...100% of the nominal value. The selection of the voltage range can be done in the device setup. See section „3.4.3. Configuration via MENU“ for details. The reference voltage sent out from pin 3 (VREF) will be adapted accordingly:

0-5 V: Reference voltage = 5 V, 0...5 V set value signal for VSEL, CSEL, PSEL and RSEL correspond to 0...100% nominal value, 0...100% actual values correspond to 0...5 V at the actual value outputs CMON and VMON.

0-10 V: Reference voltage = 10 V, 0...10 V set value signal for VSEL, CSEL, PSEL and RSEL correspond to 0...100% nominal values, 0...100% actual values correspond to 0...10 V at the actual value outputs CMON and VMON.

Input of set values, also excess ones like >5 V in the selected 5 V range or >10 V in the 10 V range, are always clipped by the adjustment limits.

Before you begin, please read these important notes for use of the interface:

- Analog remote control of the device must be activated by switching pin REMOTE (5) first. Only exception is pin REM-SB, which can be used independently
- Before the hardware is connected that will control the analog interface, it shall be checked that it can't provide voltage to the pins higher than specified
- Set value inputs, such as VSEL, CSEL, PSEL and RSEL (if R mode is activated), must not be left unconnected (i.e. floating) during analog remote control. In case any of the set values isn't used for adjustment, it can be tied to a defined level or connected to pin VREF (solder bridge or different), so it gives 100%

3.5.4.2 Resolution

The analog interface is internally sampled and processed by a digital microcontroller. This causes a limited resolution of analog steps. The resolution is the same for set values (VSEL etc.) and actual values (VMON/CMON) and is 26214 when working with the 10 V range. In the 5 V range this resolution halves. Due to tolerances, the truly achievable resolution can be slightly lower.

3.5.4.3 Acknowledging device alarms

Device alarms (see 3.6.2) are always indicated in the front display and some of them are also reported as signal on the analog interface socket (see table below).

In case of a device alarm occurring during remote control via analog interface, the DC input will be switched off the same way as in manual control. While alarms like OT (overtemperature), PF (power fail) and OV (overvoltage) can be monitored via the corresponding pins of the interface, other alarms like overcurrent (OC) can't. Those could only be detected via the actual values of voltage and current being all zero contrary to the set values.

Some device alarms (OV, OC and OP) have to be acknowledged, either by the user of the device or by the controlling unit. Also see „3.6.2. Device alarm and event handling“. Acknowledgement is done with pin REM-SB switching the DC input off and on again, means a HIGH-LOW-HIGH edge (at least 50 ms for LOW).

3.5.4.4 Analog interface specification

Pin	Name	Type*	Description	Default levels	Electrical specification
1	VSEL	AI	Set voltage value	0...10 V or. 0...5 V correspond to 0..100% of U_{Nom}	Accuracy 0-5 V range: < 0.4% ***** Accuracy 0-10 V range: < 0.2% *****
2	CSEL	AI	Set current value	0...10 V or. 0...5 V correspond to 0..100% of I_{Nom}	Input impedance $R_i > 40\text{ k} \dots 100\text{ k}$
3	VREF	AO	Reference voltage	10 V or 5 V	Tolerance < 0.2% at $I_{max} = +5\text{ mA}$ Short-circuit-proof against AGND
4	DGND	POT	Ground for all digital signals		For control and status signals
5	REMOTE	DI	Switch between manual and remote control	Remote = LOW, $U_{Low} < 1\text{ V}$ Manual = HIGH, $U_{High} > 4\text{ V}$ Manual, when not wired	Voltage range = 0...30 V $I_{Max} = -1\text{ mA}$ at 5 V $U_{LOW\ to\ HIGH\ typ.} = 3\text{ V}$ Rec'd sender: Open collector against DGND
6	ALARMS 1	DO	Overtemperature Power fail alarm	Alarm= HIGH, $U_{High} > 4\text{ V}$ No Alarm= LOW, $U_{Low} < 1\text{ V}$	Quasi open collector with pull-up against V_{cc} ** With 5 V on the pin max. flow +1 mA $I_{Max} = -10\text{ mA}$ at $U_{CE} = 0,3\text{ V}$ $U_{Max} = 30\text{ V}$ Short-circuit-proof against DGND
7	RSEL	AI	Set internal resistance value	0...10 V or. 0...5 V correspond to 0..100% of R_{Max}	Accuracy 0-5 V range: < 0.4% ***** Accuracy 0-10 V range: < 0.2% *****
8	PSEL	AI	Set power value	0...10 V or. 0...5 V correspond to 0..100% of P_{Nom}	Input impedance $R_i > 40\text{ k} \dots 100\text{ k}$
9	VMON	AO	Actual voltage	0...10 V or. 0...5 V correspond to 0..100% of U_{Nom}	Accuracy < 0.2% at $I_{Max} = +2\text{ mA}$ Short-circuit-proof against AGND
10	CMON	AO	Actual current	0...10 V or. 0...5 V correspond to 0..100% of I_{Nom}	
11	AGND	POT	Ground for all analog signals		For -SEL, -MON, VREF signals
12	R-ACTIVE	DI	R mode on / off	Off = LOW, $U_{Low} < 1\text{ V}$ On = HIGH, $U_{High} > 4\text{ V}$ On, when not wired	Voltage range = 0...30 V $I_{Max} = -1\text{ mA}$ at 5 V $U_{LOW\ to\ HIGH\ typ.} = 3\text{ V}$ Rec'd sender: Open collector against DGND
13	REM-SB	DI	DC input OFF (DC input ON) (ACK alarms ****)	Off = LOW, $U_{Low} < 1\text{ V}$ On= HIGH, $U_{High} > 4\text{ V}$ On, when not wired	Voltage range = 0...30 V $I_{Max} = +1\text{ mA}$ at 5 V Rec'd sender: Open collector against DGND
14	ALARMS 2	DO	Overvoltage Overcurrent Overpower	Alarm = HIGH, $U_{High} > 4\text{ V}$ No alarm = LOW, $U_{Low} < 1\text{ V}$	Quasi open collector with pull-up against V_{cc} ** With 5 V on the pin max. flow +1 mA $I_{Max} = -10\text{ mA}$ at $U_{CE} = 0,3\text{ V}$ $U_{Max} = 30\text{ V}$ Short-circuit-proof against DGND
15	STATUS***	DO	Constant voltage regulation active DC input	CV = LOW, $U_{Low} < 1\text{ V}$ CC/CP/CR = HIGH, $U_{High} > 4\text{ V}$ Off = LOW, $U_{Low} < 1\text{ V}$ On = HIGH, $U_{High} > 4\text{ V}$	

* AI = Analog Input, AO = Analog Output, DI = Digital Input, DO = Digital Output, POT = Potential

** Internal V_{cc} approx. 10 V

*** Only one of both signals possible, see section 3.4.3.1

**** Only during remote control

***** The error of a set value input adds to the general error of the related value on the DC input of the device

3.5.4.5 Overview of the Sub-D Socket

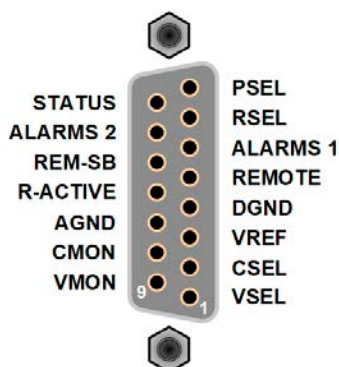

3.5.4.6 Simplified diagram of the pins

	<p>Digital Input (DI)</p> <p>The DI is internally pulled up and thus it requires to use a contact with low resistance (relay, switch, contactor etc.) in order to clearly pull the signal down to DGND.</p>		<p>Analog Input (AI)</p> <p>High resistance input (impedance >40 k...100 kΩ) of an operational amplifier circuit.</p>
	<p>Digital Output (DO)</p> <p>A quasi open collector, realized as high resistance pull-up against the internal supply. The design doesn't allow the pin to be loaded, but to switch signals by sinking current.</p>		<p>Analog Output (AO)</p> <p>Output from an operational amplifier circuit, with low impedance. See specifications table above.</p>

3.5.4.7 Application examples

a) Switching off the DC input via the pin REM-SB



A digital output, e. g. from a PLC, may be unable to cleanly effect this as it may not be of low enough resistance. Check the specification of the controlling application. Also see pin diagrams above.

In remote control, pin REM-SB is used to switch the DC input of the device on and off. This is also available without remote control being active.

It's recommended that a low resistance contact such as a switch, relay or transistor is used to switch the pin to ground (DGND).

Following situations can occur:

- **Remote control has been activated**

During remote control via analog interface, only pin REM-SB determines the states of the DC input, according to the levels definitions in 3.5.4.4. The logical function and the default levels can be inverted by a parameter in the setup menu of the device. See 3.4.3.1.



If the pin is unconnected or the connected contact is open, the pin will be HIGH. With parameter "Analog interface Rem-SB" being set to "Normal", it requests "DC input on". So when activating remote control, the DC input would instantly switch on.

- **Remote control isn't active**

In this mode of operation pin "REM-SB" can serve as lock, preventing the DC input from being switched on by any means. This results in following possible situations:

DC input	+	Level on pin REM-SB	+	Parameter „Analog interface Rem-SB“	→	Behavior
is off	+	HIGH	+	Normal	→	The DC input isn't locked. It can be switched on by pushbutton "On/Off" (front panel) or via command from digital interface.
		LOW	+	Inverted		
	+	HIGH	+	Inverted	→	The DC input is locked. It can't be switched on by pushbutton "On/Off" (front panel) or via command from digital interface. When trying to switch on, a pop-up in the display resp. an error message will be generated.
		LOW	+	Normal		

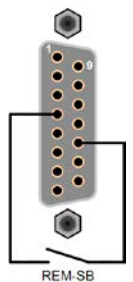

In case the DC input is already switched on, toggling the pin will switch the DC input off, similar to what it does in analog remote control:

DC input	+	Level on pin REM-SB	+	Parameter „Analog interface Rem-SB“	→	Behavior
is on	+	HIGH	+	Normal	→	The DC input remains on, nothing is locked. It can be switched on or off by pushbutton or digital command.
		LOW	+	Inverted		
	+	HIGH	+	Inverted	→	The DC input will be switched off and locked. Later it can be switched on again by toggling the pin. During lock, pushbutton or digital command can delete the request to switch on by pin.
		LOW	+	Normal		

b) Remote control of current and power.

Requires remote control to be activated (Pin REMOTE = LOW)

The set values PSEL and CSEL are generated from, for example, the reference voltage VREF, using potentiometers for each. Hence the device can selectively work in current limiting or power limiting mode. According to the specification of max. 5 mA load for the VREF output, potentiometers of at least 10 kΩ must be used.

The voltage set value VSEL is directly connected to AGND (ground) and therefore has no influence on constant current or power operation.

If the control voltage is fed in from an external source it's necessary to consider the input voltage ranges for set values (0...5 V or 0...10 V).



Use of the input voltage range 0...5 V for 0...100% set value halves the effective resolution.

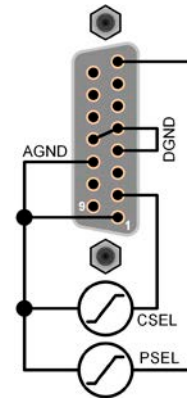

Example with external voltage source

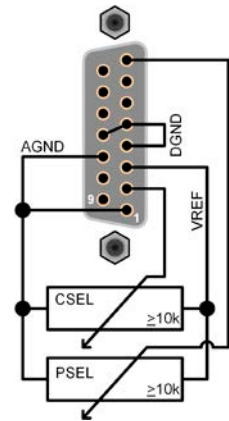

Example with potentiometers

c) Reading actual values

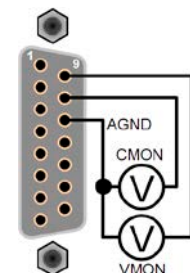

The AI provides the DC input values as current and voltage monitor. These can be read using a standard multimeter or similar.



3.6 Alarms and monitoring

3.6.1 Definition of terms

There is a clear distinction between equipment alarms (see „3.3. Alarm conditions“) such as overvoltage or overheating, and user defined events such as e. g. **OVD** overvoltage monitoring. Whilst device alarms primarily serve to protect the source by switching off the DC input, user defined events can also switch off the DC input (**Action = ALARM**), but can also simply give an acoustic signal to make the user aware. The actions driven by user defined events can be selected:

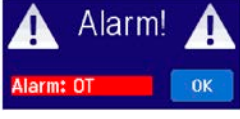
Action	Impact	Example
NONE	User defined event is disabled.	
SIGNAL	On reaching the condition which triggers the event, the action SIGNAL will show a text message in the status area of the display.	
WARNING	On reaching the condition which triggers the event, the action WARNING will show a text message in the status area of the display and pop up an additional warning message. It would additionally trigger an acoustic signal (if activated).	
ALARM	On reaching the condition which triggers the event, the action ALARM will show a text message in the status area of the display with an additional alarm pop-up, and additionally emit an acoustic signal (if activated). Furthermore the DC input is switched off. Certain device alarms are also signaled to the analog interface or can be queried via the digital interface.	

3.6.2 Device alarm and event handling

Important to know:



- The current drained from a switching power supply or similar sources can be much higher than expected due to capacities on the source’s output, even if the source is current limited, and might thus trigger the overcurrent shutdown OCP or the overcurrent event OCD of the device, in case these supervision thresholds are adjusted to too sensitive levels
- When switching off the DC input of the device while a current limited source still supplies energy, the output voltage of the source will rise immediately and due to response and settling times in effect, the output voltage can have an overshoot of unknown level which might trigger the overvoltage shutdown OVP or overvoltage supervision event OVD, in case these thresholds are adjusted to too sensitive levels

A device alarm incident will usually lead to DC input switch-off, the appearance of a pop-up in the middle of the display and, if activated, an acoustic signal to make the user aware. The alarm must always be acknowledged. If the alarm condition no longer exists, e. g. the device has cooled down following overheating, the alarm indication will disappear. If the condition persists, the display remains and, following elimination of the cause, must be acknowledged again.

► How to acknowledge an alarm in the display (during manual control)

1. If the alarm is currently shown as pop-up, tap **OK**.
2. If the alarm has already been acknowledged, but is still displayed in the status area, first tap the status area to display the pop-up again, then acknowledge with **OK**.



In order to acknowledge an alarm during analog remote control, see „3.5.4.3. Acknowledging device alarms“. To acknowledge in digital remote control, refer to the external documentation “Programming ModBus RTU & SCPI”.

Some device alarms are configurable:

Alarm	Meaning	Description	Range	Indication
OVP	OverVoltage Protection	Triggers an alarm as soon as the DC input voltage reaches the defined threshold. The DC input will be switched off..	0 V...1.03*U _{Nom}	Display, analog & digital interfaces
OCP	OverCurrent Protection	Triggers an alarm as soon as the DC input current reaches the defined threshold. The DC input will be switched off..	0 A....1.1*I _{Nom}	
OPP	OverPower Protection	Triggers an alarm as soon as the DC input power reaches the defined threshold, The DC input will be switched off..	0 W...1.1*P _{Nom}	

These device alarms can't be configured and are based on hardware:

Alarm	Meaning	Description	Indication
PF	Power Fail	AC supply over- or undervoltage. Triggers an alarm if the AC supply is out of specification or when the device is cut from supply, for example when switching it off with the power switch. The DC input will be switched off. The condition of the DC input after a temporary undervoltage can be determined with a setting. See section 3.4.3.1.	Display, analog & digital interfaces
OT	OverTemperature	Triggers an alarm if the internal temperature exceeds a certain limit. The DC input will be switched off. The condition of the DC input after cooling down can be determined with a setting. See section 3.4.3.1	

► How to configure the device alarms

1. While the DC input is switched off tap touch area **SETTINGS** on the main screen.
2. On the right side tap the arrows to select **2. Protect**.
3. Set the thresholds for the device alarms relevant to your application if the default value of 103% (OVP) resp. 110% (OCP, OPP) is unsuitable.



The set values can be entered using a numeric pad, which appears when tapping the numeric pad symbol below.

The user also has the possibility of selecting whether an additional acoustic signal will be sounded if an alarm or user defined event occurs.

► How to configure the alarm sound (also see “3.4.3. Configuration via MENU“)

1. While the DC input is switched off tap the touch area **MENU** on the main screen.
2. In the menu page, tap **HMI Settings**.
3. In the following menu page, tap **Alarm Sound**.
4. In the settings page select **Sound on** or **Sound off** and confirm with .

3.6.2.1 User defined events

The monitoring functions of the device can be configured for user defined events. By default, events are deactivated (**Action = NONE**). Contrary to device alarms, the events only work while the DC input is switched on.



The following events can be configured independently and can, in each case, trigger the actions **NONE**, **SIGNAL**, **WARNING** or **ALARM**.

Event	Meaning	Description	Range
UVD	UnderVoltage Detection	Triggers an event if the input voltage falls below the defined threshold.	0 V...U _{Nom}
OVD	OverVoltage Detection	Triggers an event if the input voltage exceeds the defined threshold.	0 V...U _{Nom}
UCD	UnderCurrent Detection	Triggers an event if the input current falls below the defined threshold.	0 A...I _{Nom}
OCD	OverCurrent Detection	Triggers an event if the input current exceeds the defined threshold.	0 A...I _{Nom}
OPD	OverPower Detection	Triggers an event if the input power exceeds the defined threshold.	0 W...P _{Nom}



These events should not be confused with alarms such as OT and OVP which are for device protection. User defined events can, however, if set to action "ALARM", switch off the DC input and thus protect the source (power supply, battery)

► How to configure user defined events

1. Tap the touch area **SETTINGS** on the main screen.
2. On the right side tap the arrows   to select **4.1 Event U** or **4.2 Event I** or **4.3 Event P**.
3. Set the monitoring limits with the left hand rotary knob and the triggered action with the right hand knob relevant to the application (also see „3.6.1. Definition of terms“).
4. Accept the settings with .



User events are an integral part of the actual user profile. Thus, if another user profile, or the default profile, is selected and used, the events will be either differently or not configured.





The set values can be entered using the ten-key tab. This will appear by tapping the touch area "Direct input".

3.7 Control panel (HMI) lock

In order to avoid the accidental alteration of a value during manual operation, the rotary knobs or the touchscreen can be locked so that no alteration of values will be accepted without prior unlocking.

► How to lock the HMI

1. In the main page, tap the lock symbol  (upper right corner).
2. In the settings page **HMI Lock** you are then asked to chose between a complete HMI (setting: **Lock all**) lock or one where the **On/Off** button is still usable (setting: **ON/OFF possible**), resp. chose to activate the additional PIN (setting: **Enable PIN**). The device would later request to enter this PIN every time you want to unlock the HMI, until the PIN is deactivated again.
3. Activate the lock with . The status **Locked** as shown in the figure to the right.

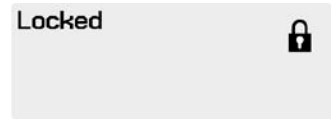

If an attempt is made to alter something whilst the HMI is locked, a requester appears in the display asking if the lock should be disabled.

► How to unlock the HMI

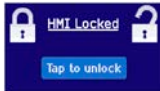
1. Tap any part of the touchscreen of the locked HMI, or turn one of the rotary knobs or press the button **On/Off** (only in **Lock all** situation).
2. This request pop-up will appear: .
3. Unlock the HMI by tapping on **Tap to unlock** within 5 seconds, otherwise the pop-up will disappear and the HMI remains locked. In case the additional PIN code lock has been activated in the menu **HMI Lock**, another requester will pop up, asking you to enter the PIN before it finally unlocks the HMI.

3.8 Limits lock

In order to avoid the alteration of the adjustment limits (also see „3.4.4. Adjustment limits“) by an unprivileged user, the screen with the adjustment limit settings (“Limits”) can be locked by a PIN code. The menu pages **3.Limits** in **SETTINGS** and **Profiles** in **MENU** will then become inaccessible until the lock is removed by entering the correct PIN or in case it has been forgotten, by resetting the device as last resort.

► How to lock the Limits

1. While the DC input is switched off, tap the touch area  on the main screen.
2. In the menu tap on **HMI Setup**, then on **Limits Lock**.
3. In the next page set the check mark for **Lock**.



The same PIN as with the HMI lock is used here. It should be set before activating the Limits lock. See „3.7. Control panel (HMI) lock“

4. Activate the lock by leaving the settings page with .



Be careful to enable the lock if you are unsure what PIN is currently set. In doubt use ESC to exit the menu page. In menu page “HMI Lock” you can define a different PIN, but not without entering the old one.

► How to unlock the limits settings

1. While the DC input is switched off, tap the touch area  on the main screen.
2. In the menu tap **Limits Lock**.
3. In the next page tap on touch area **Unlock** and then you will be asked to enter the 4-digit PIN.
4. Deactivate the lock by entering the correct PIN and submitting with **ENTER**.



3.9 Loading and saving an user profile

The menu “**Profiles**” serves to select between a default profile and up to 5 user profiles. A profile is a collection of all settings and set values. Upon delivery, or after a reset, all 6 profiles have the same settings and all set values are 0. If the user changes settings or sets target values then these create a working profile which can be saved to one of the 5 user profiles. These profiles or the default one can then be switched. The default profile is read-only.

The purpose of a profile is to load a set of set values, settings limits and monitoring thresholds quickly without having to readjust these. As all HMI settings are saved in the profile, including language, a profile change can also be accompanied by a change in HMI language.

On calling up the menu page and selecting a profile the most important settings can be seen, but not changed.

► How to save the current values and settings as an user profile

1. Tap the touch area  on the main screen
2. In the menu page, tap .
3. In the selection screen (right) choose between user profile 1-5 in which the settings are to be saved. The profile will then be displayed and the values can be checked, but not changed.
4. Save using the touch area .

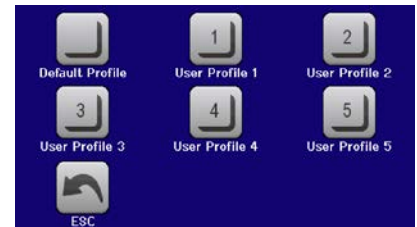

3.10 The function generator

3.10.1 Introduction

The built-in **function generator** (short: **FG**) is able to create various signal forms and apply these to the set value of voltage or current.

The standard functions are based on an **arbitrary generator** and directly accessible and configurable using manual control. For remote control, the fully customizable arbitrary generator replicates the functions with sequences containing 8 parameters each. Battery test and MPP tracking are software based functions only.

The following functions are retrievable, configurable and controllable:

Function	Short description
Sine wave	Sine wave generation with adjustable amplitude, offset and frequency
Triangle	Triangular wave signal generation with adjustable amplitude, offset, rise and fall times
Rectangular	Rectangular wave signal generation with adjustable amplitude, offset and duty cycle
Trapezoid	Trapezoidal wave signal generation with adjustable amplitude, offset, rise time, pulse time, fall time, idle time
DIN 40839	Simulated automobile engine start curve according to DIN 40839 / EN ISO 7637, split into 5 curve parts (sequence points), each with a start voltage, final voltage and time
Arbitrary	Generation of a process with up to 99 freely configurable curve points, each with a start and end value (AC/DC), start and end frequency, phase angle and duration
Ramp	Generation of a linear rise or fall ramp with start and end values and time before and after the ramp
Battery test	Battery discharge test with constant or pulsed current, along with Ah, Wh and time counters
MPP Tracking	Simulation of the characteristic tracking behavior of solar inverters when seeking to find the maximum power point (MPP) when being connected to typical sources such as solar panels



With R/I being activated, access to the function generator isn't available.

3.10.2 General

3.10.2.1 Limitations

The function generator isn't accessible, neither for manual access, nor for remote control, if resistance mode (R/I adjustment mode, also called UIR mode) is active.

3.10.2.2 Resolution

Amplitudes generated by the arbitrary generator have an effective resolution of approx. 52428 steps. If the amplitude is very low and the time long, the device would generate less steps and set multiple identical values after another, generating a staircase effect. It's furthermore not possible to generate every possible combination of time and a varying amplitude (slope).

3.10.2.3 Minimum slope / maximum ramp time

When using a rising or falling offset (i.e. DC part) at functions like ramp, trapezoid, triangle and even sine wave, a minimum slope, calculated from the rated values of voltage or current, is required or else the adjusted settings would be neglected by the device. Calculating the minimum slope can help to determine if a certain ramp over time can be achieved by the device or not. Example: model EL 9080-60 DT is going to be used, with 80 V and 60 A rating. **Formula: minimum slope = 0.000725 * rated value / s.** For the example model it results in $\Delta U/\Delta t$ of 58 mV/s and $\Delta I/\Delta t$ of 43 mA/s. The maximum time which can be achieved with the minimum slope then calculates as approximately 1379 seconds according to formula **$t_{Max} = \text{rated value} / \text{min. slope}$** .

3.10.3 Method of operation

In order to understand how the function generator works and how the value settings interact, the following should be noted:

The device operates always with the three set values U,I and P, also in function generator mode.

The selected function can be used on one of the values U or I, the other two are then constants and have a limiting effect. That means, if, e. g. a voltage of 10 V is applied to the DC input and a sine wave function should operate on the current with an amplitude of 20 A and offset 20 A, then the function generator will create a sine wave progression of current between 0 A (min) and 40 A (max), which will result in an input power between 0 W (min) and 400 W (max). The input power, however, is limited to its set value. If this were 300 W then, in this case, the current would be limited to 30 A and, if clamped to an oscilloscope, it would be seen to be truncated at 30 A and never reach the target of 40 A.

Another case is when working with a function which is applied to the input voltage. If here the static voltage is set higher than the amplitude plus offset then at function start there will be no reaction, as the voltage regulation limits down to 0 with an electronic load, other than current or power. The correct settings for each of the other set values is therefore essential.

3.10.4 Manual operation

3.10.4.1 Function selection and control



Via the touch screen one of the functions listed in 3.10.1 can be called up, configured and controlled. This is only possible when the DC input is switched off.



► How to select a function and adjust parameters

1. While the DC input is switched off tap touch area  on the main screen.

2. In the menu overview tap on the touch area  and then on the desired function.

3. Depending on the choice of function there follows a request to which value the function generator is going to be applied:  or .

4. Adjust the parameters as you desire, like offset, amplitude and frequency for a sine wave, for example.



For the AC part of a function and if the difference between start and end value of amplitude or frequency is too low (min. $\Delta Y/\Delta t$), depending on the time that is defined for one function run, the function generator won't accept the settings and pop up an error.

5. Also adjust the overall limits of voltage, current and power, which you can access with touch area .



When entering function generator mode, those global limits are reset to safe values, which might prevent the function from working at all. For example, if you apply the selected function to the input current, then the overall current limit should not interfere and should at least be as high as offset + amplitude.

Setting the various functions is described below. After setting it up, the function can be loaded.

► How to load a function

1. After setting the values for the required signal generation, tap on the touch area .

The device will then load the data into the internal controller and changes the display. Shortly afterwards the static values are set (power and voltage or current), the DC input is switched on and the touch area  enabled. Only then can the function be started.

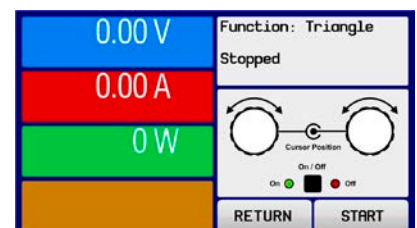



Because the DC input is automatically switched on in order to settle the start situation, the static values are effective to the source immediately after loading the function. These static values represent the situation before start and after the end of the function, so it doesn't need to start from 0. Only exception: when applying any function to the current (I), there is no adjustable static current value, so the function would always start from 0 A.

► How to start and stop a function

1. The function can be **started** either by tapping **START** or pushing the "On/Off" button, if the DC input is currently switched off. The function then starts immediately. In case START is used while the DC input is still switched off, the DC input will be switched on automatically.
2. The function can be **stopped** either by tapping **STOP** or pushing the "On/Off" button. There is different behaviour:
 - a) The **STOP** button only stops the function, the DC input remains ON with the static values in effect.
 - b) The "On/Off" button stops the function and switches the DC input off.



Any device alarm (overvoltage, overtemperature etc.), protection (OPP, OCP) or event with action = Alarm stops the function progress automatically, switches off the DC input and reports the alarm.

3.10.5 Sine wave function

The following parameters can be configured for a sine function:

Value	Range	Description
I(A), U(A)	0...(Nominal value - (Off)) of U, I	A = Amplitude of the signal to be generated
I(Off), U(Off)	(A)...(Nominal value - (A)) of U, I	Off = Offset, based on the zero point of the mathematical sine curve, may not be smaller than the amplitude.
f (1/t)	1...10000 Hz	Static frequency of the signal to be generated

Schematic diagram:

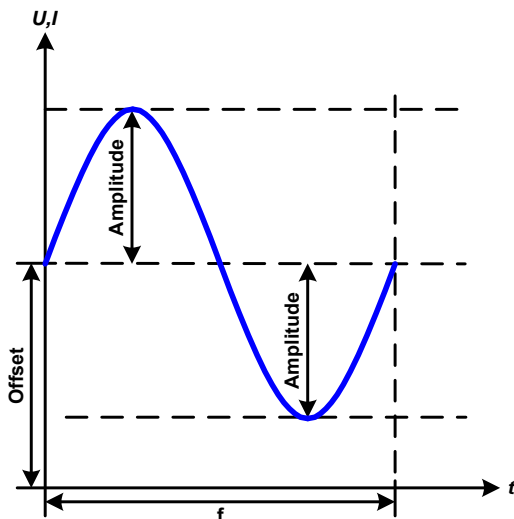

Application and result:

A normal sine wave signal is generated and applied to the selected set value, e. g. current (I). At a constant input voltage the current input of the load will follow a sine wave.

For calculating the maximum power input the amplitude and offset values for the current must be added.

Example: with an input voltage of 15 V and sin(I) selected, set the amplitude to 250 A and the offset to 300 A. The resulting maximum input power is then achieved at the highest point of the sine wave and is $(300 \text{ A} + 250 \text{ A}) \cdot 15 \text{ V} = 8.25 \text{ kW}$.

3.10.6 Triangular function

The following parameters can be configured for a triangular wave function:

Value	Range	Description
I(A), U(A)	0...(Nominal value - (Off)) of U, I	A = Amplitude of the signal to be generated
I(Off), U(Off)	0...(Nominal value - (A)) of U, I	Off = Offset, based on the foot of the triangular wave
t1	0.01 ms...36000 s	Time for the positive slope of the triangular wave signal.
t2	0.01 ms...36000 s	Time for the negative slope of the triangular wave signal



When adjusting very short time value for t1 and t2 not every adjustable amplitude can be gained on the DC input. Rule of thumb: the smaller the time value, the lower the true amplitude.

Schematic diagram:

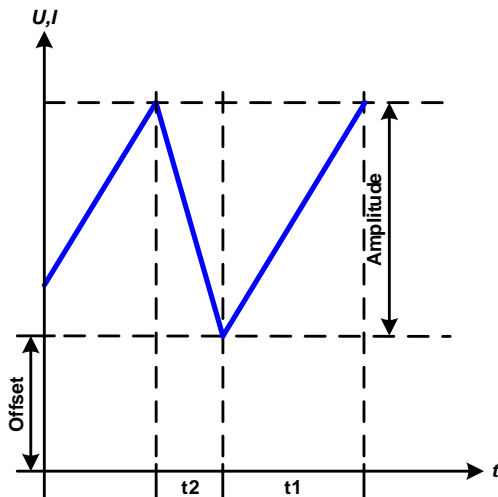

Application and result:

A triangular wave signal for input current (direct) or input voltage (indirect) is generated. The positive and negative slope times are variable and can be set independently.

The offset shifts the signal on the Y-axis.

The sum of the intervals t1 and t2 gives the cycle time and its reciprocal is the frequency.

Example: a frequency of 10 Hz is required and would lead to periodic duration of 100 ms. This 100 ms can be freely allocated to t1 and t2, e. g. 50 ms:50 ms (isosceles triangle) or 99.9 ms:0.1 ms (right-angled triangle or sawtooth).

3.10.7 Rectangular function

The following parameters can be configured for a rectangular wave function:

Value	Range	Description
I(A), U(A)	0...(Nominal value - (Off)) of U, I	A = Amplitude of the signal to be generated
I(Off), U(Off)	0...(Nominal value - (A)) of U, I	Off = Offset, based on the foot of the rectangular wave
t1	0.01 ms...36000 s	Time (pulse width) of the upper level (amplitude)
t2	0.01 ms...36000 s	Time (pause width) of the lower level (offset)



When adjusting very short time value for t1 and t2 not every adjustable amplitude can be gained on the DC input. Rule of thumb: the smaller the time value, the lower the true amplitude.

Schematic diagram:

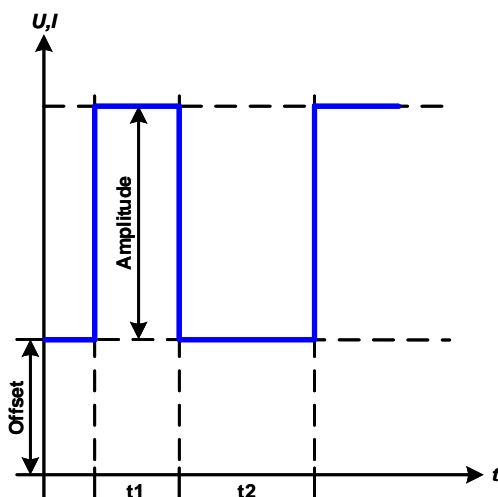

Application and result:

A rectangular or square wave signal for input current (direct) or input voltage (indirect) is generated. The intervals t1 and t2 define how long the value of the amplitude (pulse) and how long the value of the offset (pause) are effective.

The offset shifts the signal on the Y axis.

Intervals t1 and t2 can be used to define a duty cycle. The sum of t1 and t2 gives the period and its reciprocal is the frequency.

Example: a rectangular wave signal of 25 Hz and a duty cycle of 80% are required. The sum of t1 and t2, the period, is 1/25 Hz = 40 ms. For a duty cycle of 80% the pulse time (t1) is 40 ms*0.8 = 32 ms and the pause time (t2) is 8 ms

3.10.8 Trapezoidal function

The following parameters can be configured for a trapezoidal curve function:

Value	Range	Description
I(A), U(A)	0...(Nominal value - (Off)) of U, I	A = Amplitude of the signal to be generated
I(Off), U(Off)	0...(Nominal value - (A)) of U, I	Off = Offset, based on the foot of the trapezium
t1	0.01 ms...36000 s	Time for the negative slope of the trapezoidal wave signal
t2	0.01 ms...36000 s	Time for the top value of the trapezoidal wave signal
t3	0.01 ms...36000 s	Time for the negative slope of the trapezoidal wave signal
t4	0.01 ms...36000 s	Time for the base value (offset) of the trapezoidal wave signal

Schematic diagram:

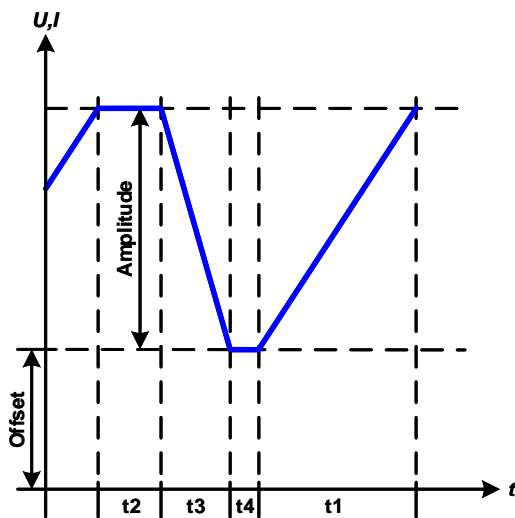

Application and result:

Here a trapezoidal signal can be applied to a set value of U or I. The slopes of the trapezium can be varied by setting different times for rise and fall.

The periodic duration and repeat frequency are the result of four time elements. With suitable settings the trapezium can be deformed to a triangular or rectangular wave. It has, therefore, universal use.



When adjusting very short time values for t1 not every adjustable amplitude can be gained on the DC input. Rule of thumb: the smaller the time value, the lower the true amplitude.

3.10.9 DIN 40839 function

This function is based on the curve defined in DIN 40839 / EN ISO 7637 (test impulse 4), and is only applicable to voltage. It shall replicate the progress of automobile battery voltage during engine starting. The curve is divided into 5 sequence points (see diagram below) which each have the same parameters. The standard values from the DIN are set already as default values for the five points.

The following parameters can be configured for the DIN 40839 function:

Value	Range	Seq	Description
Ustart	0...Nominal value of U	1-5	Start voltage of the ramp
Uend	0...Nominal value of U	1-5	End voltage of the ramp
Seq.time	0.01 ms...36000 s	1-5	Time of the ramp
Seq.cycles	∞ or 1...999	-	Number of repetitions of the entire curve
Time t1	0.01 ms...36000 s	-	Time after cycle before repetition (cycle <> 1)

Schematic diagram:

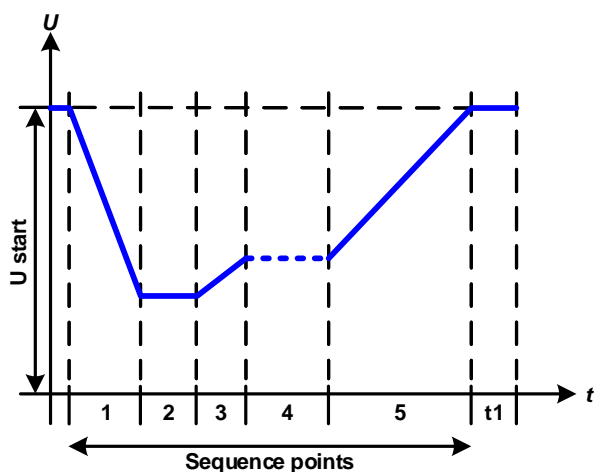

Application and result:

The function isn't suitable for standalone operation of an electronic load, but optimal in conjunction with a power supply load, for example one from PSI 9000 series. The load acts as a sink to achieve a rapid fall of the output voltage of the power supply enabling it to progress as defined by the DIN curve.

The curve conforms to test impulse 4 of the DIN. With suitable settings, other test impulses can be simulated. If the curve part in sequence point 4 should be a sine wave, then these 5 points would have to be reconstructed using the arbitrary generator.

3.10.10 Arbitrary function

The arbitrary, i. e. freely definable function offers the user a wider scope. There are 99 freely configurable sequence points available. While all have the same set of parameters, they can be configured differently so that a complex function process can be created. The 99 sequence points or a part of them can run one after another in a sequence point block and this block can then be repeated up to 999 times or infinitely. A sequence point or sequence point block is always assigned to either current or voltage, thus a mix of assignment to current or voltage isn't possible.

The arbitrary curve overlays a linear progression (DC) with a sine curve (AC), whose amplitude and frequency are shaped between start and end values. If the start frequency (f_s) = end frequency (f_e) = 0 Hz the AC values have no impact and only the DC part is effective. Each sequence point is allocated a sequence point time in which the AC/DC curve from start to finish will be generated.

The following parameters can be configured for each point in the arbitrary function sequence (the table lists parameters for current, for voltage it would be U_s , U_e etc.)

Value	Range	Description
$I_s(AC) / U_s(AC)$	0...50% Nominal value I or U	Start amplitude of the sine wave part
$I_e(AC) / U_e(AC)$	0...50% Nominal value I or U	End amplitude of the sine wave part
$f_s(1/T)$	0 Hz...10000 Hz	Start frequency of the sine wave part
$f_e(1/T)$	0 Hz...10000 Hz	End frequency of the sine wave part
Angle	0°...359 °	Start angle of the sine wave part
$I_s(DC) / U_s(DC)$	$I_s(AC)$...(Nominal value of I - $I_s(AC)$) $U_s(AC)$...(Nominal value of U - $U_s(AC)$)	Start value of the DC
$I_e(DC) / U_e(DC)$	$I_e(AC)$...(Nominal value of I - $I_e(AC)$) $U_e(AC)$...(Nominal value of U - $U_e(AC)$)	End value of the DC
Seq.time	0.01 ms...36000 s	Time for the selected sequence point



The sequence point time (seq. time) and the start and end frequency are related. The minimum value for $\Delta f/s$ is 9.3. Thus, for example, a setting of $f_s = 1$ Hz, $f_e = 11$ Hz and Seq.time = 5 s would not be accepted as $\Delta f/s$ is only 2. A time of 1 s would be accepted, or, if the time remains at 5 s, then $f_e = 51$ Hz must be set.



The amplitude change between start and end is related to the sequence point time. A minimal change over an extended time isn't possible and in such a case the device will report an inapplicable setting.

After the settings for the selected sequence are accepted with SAVE, further sequence points can be configured. If the button NEXT is touched a second settings screen appears in which global settings for all 99 sequence points are displayed.

The following parameters can be set for the total run of an arbitrary function:

Value	Range	Description
Start seq.	1...End seq.	First sequence point in the block
End seq.	Start seq. ... 99	Last sequence point in the block
Seq. Cycles	∞ or 1...999	Number of cycles to run the block.

Schematic diagram:

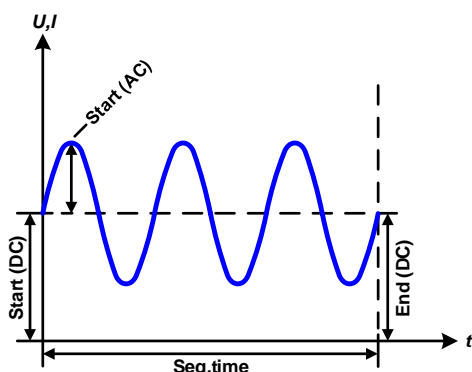

Applications and results:

Example 1

Focusing 1 cycle of 1 sequence point:

DC values for start and end are the same, also the AC amplitude. With a frequency >0 a sine wave progression of the set value is generated with a defined amplitude, frequency and Y shift (offset, DC value at start and end)

The number of sine waves per cycle depend on the time and the frequency. If the time was 1 s and the frequency 1 Hz, there would be exactly 1 sine wave. If the time was 0.5 s at the same frequency, there would only be a half sine wave.

Schematic diagram:

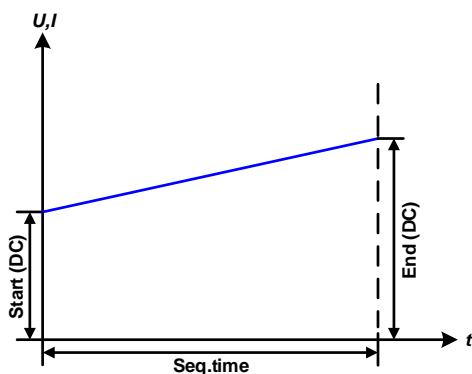
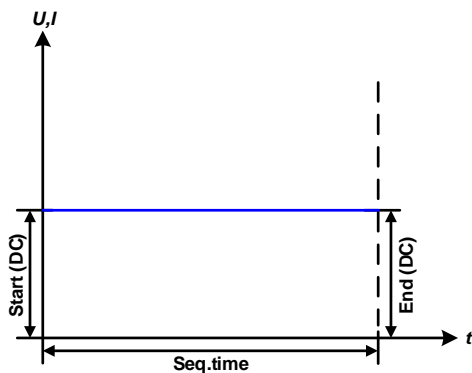
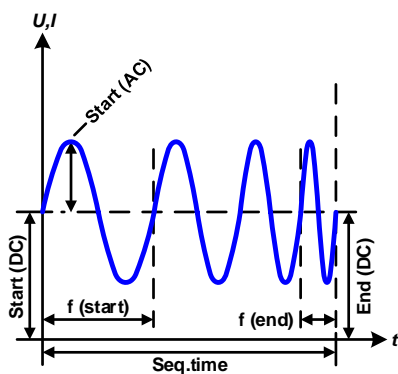
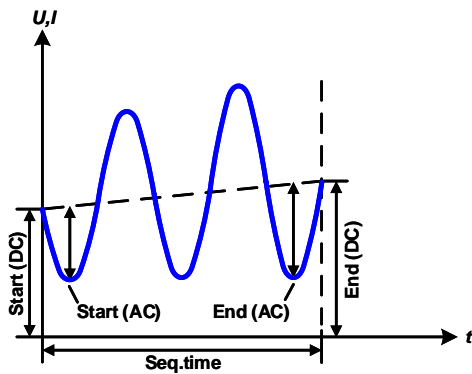
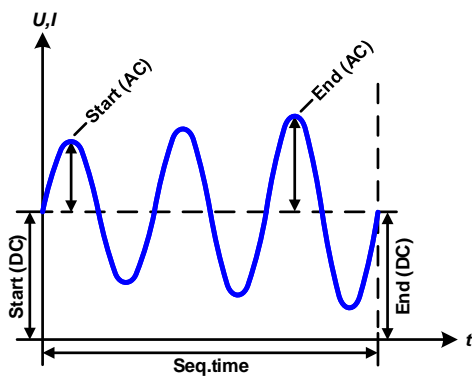

Applications and results:

Example 2

Focusing 1 cycle of 1 sequence point:

The DC values at start and end are the same but the AC (amplitude) not. The end value is higher than the start so that the amplitude increases with each new half sine wave continuously through the sequence point. This happens, of course, only if the time and frequency allow for multiple waves to be created. e. g. for $f=1$ Hz and Seq. time = 3 s, three complete waves would be generated (for angle = 0°) and reciprocally the same for $f=3$ s and Seq. time=1 s.

Example 3

Focusing 1 cycle of 1 sequence point:

The DC values at start and end are unequal, as are also the AC values. In both cases the end value is higher than the start so that the offset increases from start to end (DC) and the amplitude also with each new half sine wave.

Additionally the first sine wave starts with a negative half wave because the angle is set at 180° . The start angle can be shifted at will in 1° steps between 0° and 359° .

Example 4

Focusing 1 cycle of 1 sequence point:

Similar to example 1 but with another end frequency. Here this is shown as higher than the start frequency. This impacts the period of the sine waves such that each new wave will be shorter over the total span of the sequence point time.

Example 5

Focusing 1 cycle of 1 sequence point:

Similar to example 1 but with a start and end frequency of 0 Hz. Without a frequency no sine wave part (AC) will be created and only the DC settings will be effective. A ramp with a horizontal progression is generated.

Example 6

Focusing 1 cycle of 1 sequence point:

Similar to example 1 but with a start and end frequency of 0 Hz. Without a frequency no sine wave part (AC) will be created and only the DC settings will be effective. Here start and end values are unequal and a steadily increasing ramp is generated.

By linking together a number of differently configured sequence points, complex progressions can be created. Smart configuration of the arbitrary generator can be used to match triangular, sine, rectangular or trapezoidal wave functions and thus, e. g. a sequence of rectangular waves with differing amplitudes or duty cycles could be produced.

Schematic diagrams:

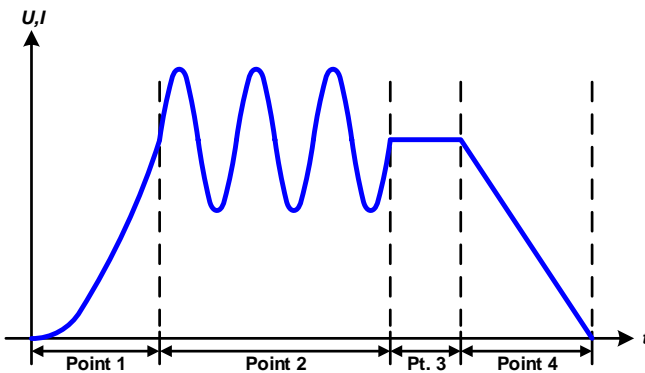
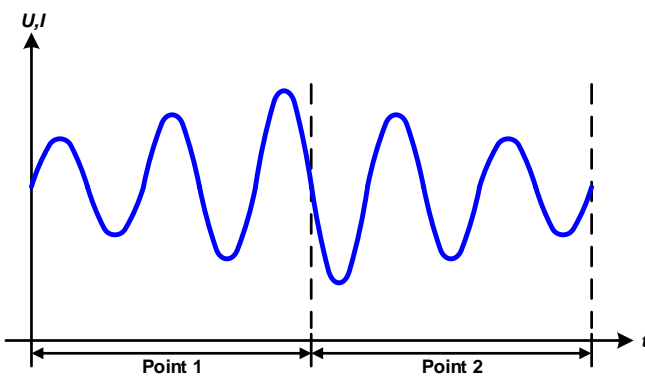
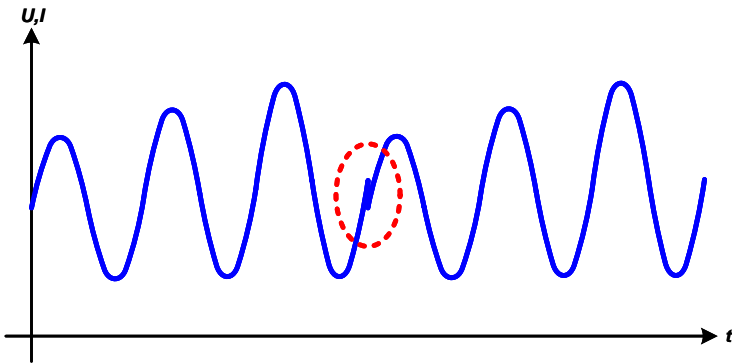

Applications and results:

Example 7

Focusing 2 cycles of 1 sequence point:

A sequence point configured as in example 3 is run. As the settings demand that the end offset (DC) is higher than the start, the second sequence run will revert to the same start level as the first, regardless of the values achieved at the end of the first run. This can produce a discontinuity in the total progression (marked in red) which may only be compensated with a careful choice of settings.

Example 8

Focusing 1 cycle of 2 sequence points:

Two sequence points run consecutively. The first one generates a sine wave with increasing amplitude, the second one a decreasing amplitude. Together they produce a progression as shown to the left. In order to ensure that the peak in the middle occurs only once, the first sequence point must end with a positive half wave and the second one start with a negative half wave as shown in the diagram..

Example 9

Focusing 1 cycle of 4 sequence points:

Point 1: 1/4th of sine wave (angle = 270 °)

Point 2: 3 Sine waves (ratio of frequency to sequence point time: 1:3)

Point 3: Horizontal ramp (f = 0)

Point 4: Falling ramp (f = 0)

3.10.10.1 Loading and saving the arbitrary function

The 99 sequence points of the arbitrary function, which can be manually configured with the control panel of the device and which are applicable either to voltage (U) or current (I), can be saved to or loaded from a common USB stick via the front side USB port. Generally, all 99 points are saved or loaded using a text file of type CSV (semicolon separator), which represents a table of values.

In order to load a sequence point table for the arbitrary generator, following requirements have to be met:

- The table must contain exactly 99 rows (100 are also accepted for compatibility reasons) with 8 subsequent values (8 columns) and must not have gaps
- The column separator (semicolon, comma) must be as selected by parameter “USB file separator format”; it also defines the decimal separator (dot, comma)
- The files must be stored inside a folder called HMI_FILES which has to be in the root of the USB drive
- The file name must always start with WAVE_U or WAVE_I (not case-sensitive)
- All values in every row and column have to be within the specified range (see below)
- The columns in the table have to be in a defined order which must not be changed

Following value ranges are given for use in the table, related to the manual configuration of the arbitrary generator (column headers like in Excel):

Column	Parameter	Range
A	AC start amplitude	0...50% U or I
B	AC end amplitude	0...50% U or I
C	Start frequency	0...10000 Hz
D	End frequency	0...10000 Hz
E	AC start angle	0...359°
F	DC start offset	0...(Nominal value of U or I) - AC start amplitude
G	DC end offset	0...(Nominal value of U or I) - AC end amplitude
H	Sequence point time in μ s	100...36.000.000.000 (36 billion μ s)

For details about the parameter and the arbitrary function refer to „3.10.10. Arbitrary function“.

Example CSV:



	A	B	C	D	E	F	G	H	
1	20,00	30,00		5	5	90	50,00	50,00	50000000
2	30,00	20,00		5	5	90	50,00	50,00	30000000
3	0,00	0,00		0	0	0	0,00	0,00	1000
4	0,00	0,00		0	0	0	0,00	0,00	1000
5	0,00	0,00		0	0	0	0,00	0,00	1000
6	0,00	0,00		0	0	0	0,00	0,00	1000

The example shows that only the first two sequence points are configured, while all others are set to default values. The table could be loaded as WAVE_U or WAVE_I when using, for example, the model EL 9080-60 DT, because the values would fit both, voltage and current. The file naming, however, is unique. A filter prevents you from loading a WAVE_I file after you have selected “Arbitrary --> U” in the function generator menu. The file would not be listed at all.

► How to load a sequence point table from USB stick:

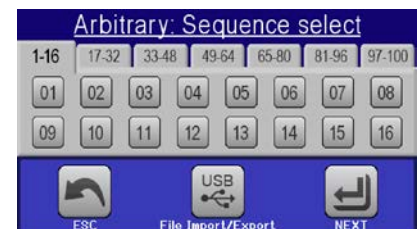
1. Do not plug the USB drive yet or remove it.
2. Access the function selection menu of the function generator with MENU -> Function Generator -> Arbitrary -> U/I, to see the main screen “Sequence select”, as depicted to the right.



3. Tap touch area , then  and follow the instructions on screen. If at least one valid files has been recognized (for file and path naming see above), the device will show a list of files to select from with .

4. Tap touch area  in the bottom right corner. The selected file is then checked and loaded, if valid. In case it isn't valid, the device will show an error message. Then the file must be corrected and the steps repeated.

► How to save a sequence point table to USB stick:

1. Do not plug the USB stick yet or remove it.
2. Access the function selection menu of the function generator via MENU -> Function Generator -> Arbitrary



3. Tap on **File Import/Export**, then **SAVE to USB**. The device will request you to plug the USB stick now.
4. After plugging it, the device will try to access the USB stick and find the folder HMI_FILES and read the content. If there are already WAVE_U or WAVE_I files present, they will be listed and you can either select one for overwriting with , otherwise select **-NEW FILE-** for a new file.



5. Finally save the sequence table with **SAVE to USB**.

3.10.11 Ramp function

The following parameters can be configured for a ramp function.

Value	Range	Description
Ustart / Istart	0...Nominal value of U, I	Start value (U,I)
Uend / Iend	0...Nominal value of U, I	End value (U, I)
t1	0.01 ms...36000 s	Time before ramp-up or ramp-down of the signal
t2	0.01 ms...36000 s	Ramp-up or ramp-down time

Schematic diagram:

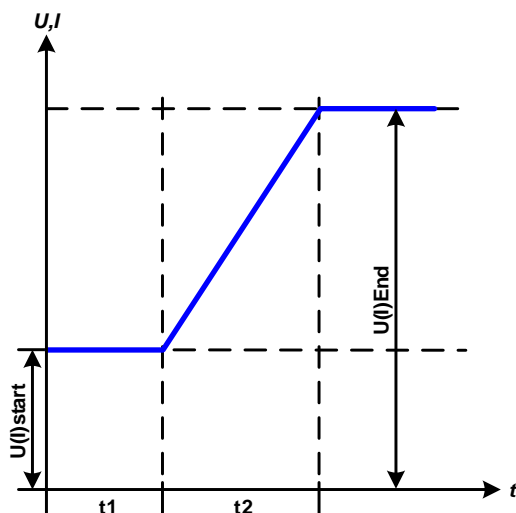

Application and result:

This function generates a rising or falling ramp between start and end values over the time t_2 . Time t_1 creates a delay before the ramp starts.

The function runs once and stops at the end value. To have a repeating ramp, function Trapezoid would have to be used instead (see 3.10.8).

Important to consider are the static values of U and I which define the start levels at the beginning of the ramp. It's recommended that these values are set equal to those in Ustart/Istart, unless the power source shall not be loaded before the start of the ramp. In that case the static values should be set to zero.



10h after reaching the ramp end, the function will stop automatically (i.e. $I = 0$ A resp. $U = 0$ V), unless it has been stopped manually before.

3.10.12 Battery test function

The purpose of the battery test function is to discharge various battery types in industrial product tests or laboratory applications. It's only available via access on the HMI, at least as setup and use are described below, but can also be achieved in remote control using the arbitrary function generator. The only disadvantage in remote control are the missing counters of battery capacity (Ah), energy (Wh) and time. But those can be calculated by custom remote control software when programming a time counter and regularly querying actual values from the device.

The function is usually applied on the DC input current and can either be selected and run in "**Static**" (**constant current**) or "**Dynamic**" (**pulsed current**) mode. In static mode, the settings for power or resistance can also let the device run the function in constant power (CP) or constant resistance (CR). Like in the normal operation of the load the set values determine what regulation mode (CC, CP, CR) is resulting on the DC input. If, for example, CP operation is projected, the set values of current should be set to maximum and resistance mode should be turned off, so that both don't interfere. For a projected CR operation it's similar. There current and power should be set to maximum.

For dynamic mode there is also a power setting, but it can't be used to run the dynamic battery test function in pulsed power mode or at least the result would not be as expected. It's recommended to adjust the power values always according to the test parameters, so it doesn't interfere with the pulsed current, i. e. dynamic mode.

When discharging with high currents, compared to the nominal battery capacity and in dynamic mode, it may happen that the battery voltage shortly drops below the U-DV threshold and the test will unintentionally stop. Here it's recommended to adjust U-DV accordingly.

Graphical depiction of both battery test modes:

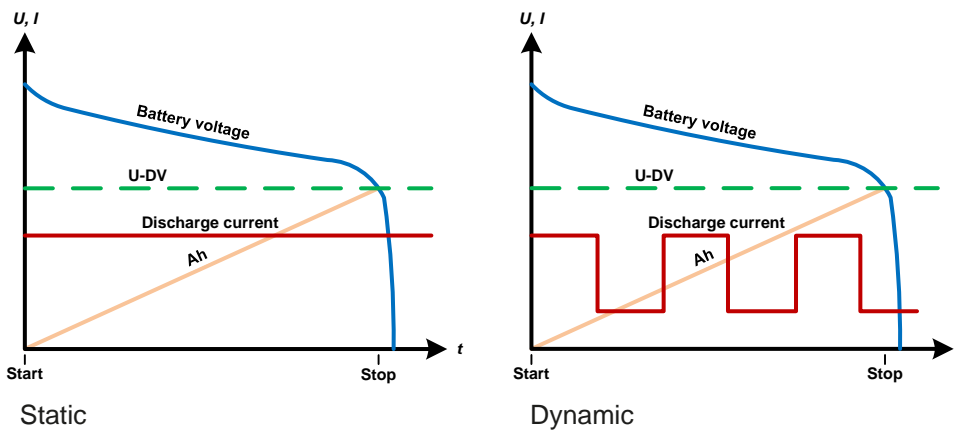

3.10.12.1 Parameters for static mode

The following parameters can be configured for the static battery test function.

Value	Range	Description
I	0...Nominal value of I	Maximum discharge current in Ampere
P	0...Nominal value of P	Maximum discharge power in Watt
R	Min....max. nominal value of R	Maximum discharge resistance in Ω (can be deactivated --> "OFF")

3.10.12.2 Parameters for dynamic mode

The following parameters can be configured for the dynamic battery test function.

Value	Range	Description
I_1	0...Nominal value of I	Upper resp. lower current setting for pulsed operation (the higher value of both is automatically used as upper level)
I_2	0...Nominal value of I	
P	0...Nominal value of P	Maximum discharge power in Watt
t_1	1 s ... 36000 s	t_1 = Time for the upper level of the pulsed current (pulse)
t_2	1 s ... 36000 s	t_2 = Time for the lower level of the pulsed current (pause)

3.10.12.3 Other parameters

These parameters are available in both battery test modes, but the values are separately adjustable in each.

Parameter	Range	Description
Discharge voltage	0...Nominal value of U	Variable voltage threshold to make the test stop when reached (is connected to the battery voltage on the DC input of the load)
Discharge time	0...10 h	Maximum test time after which the test can stop automatically
Discharge capacity	0...99999 Ah	Maximum capacity to consume from the battery after which the test can stop automatically
Action	NONE, SIGNAL, End of test	Separately defines an action for parameters „Discharge time“ and „Discharge capacity“. It determines what shall happen with the test run once the adjusted values for those parameters are reached: NONE = No action, test will continue SIGNAL = Text "Time limit" will be displayed, test will continue End of test = The test will stop
Enable USB logging	on/off	By setting the check mark, USB logging is enabled and will record data on a properly formatted USB stick, if plugged in to the front USB port. The recorded data differs from the USB log data recorded during the regular USB logging in all other operation modes of the device.
Logging interval	100 ms - 1 s, 5 s, 10 s	Writing interval for USB logging

3.10.12.4 Displayed values

During the test run, the display will show a set of values and status:

- Actual battery voltage on the DC input in V
- Actual discharge current in A
- Actual power in W
- Discharge voltage U_{DV} in V
- Consumed battery capacity in Ah
- Consumed energy in Wh
- Elapsed time in HH:MM:SS,MS
- Regulation mode (CC, CP, CR)



3.10.12.5 Data recording (USB logging)

At the end of the configuration of both, static and dynamic mode, there is the option to enable the USB logging feature. With an USB stick plugged and formatted as required (see), the device can record data during the test run directly to the stick and in the defined interval. Active USB logging is indicated in the display with a small disk symbol. After the test has stopped, the recorded data will be available as text file in CSV format.

Log file format:

	A	B	C	D	E	F	G
1	Static:Uset	Iset	Pset	Rset	DV	DT	DC
2	0,00V	0,00A	1200W	OFF	0,00V	10:00:00	99999,00Ah
3							
4	Uactual	Iactual	Pactual	Ah	Wh	Time	
5	0,34V	0,00A	0W	0,00Ah	0,00Wh	00:00:00,800	
6	0,28V	0,00A	0W	0,00Ah	0,00Wh	00:00:01,800	
7	0,28V	0,00A	0W	0,00Ah	0,00Wh	00:00:02,800	
8	0,28V	0,00A	0W	0,00Ah	0,00Wh	00:00:03,800	

Static = Selected mode

Iset = Max. current

Pset = Max. power

Rset = Desired resistance

DV = Discharge voltage

DT = Discharge time

DC = Discharge capacity

U/I/Pactual = Actual values

Ah = Consumed battery capacity

Wh = Consumed energy



Regardless the setting for the recording interval, the values "Ah" and "Wh" are only calculated by the device once per second. When using an interval setting of < 1 s, several identical values of Ah and Wh are written into the CSV.

3.10.12.6 Possible reasons for battery test stop

The battery test function run can stop due to different reasons:

- Manual stop on the HMI with touch area STOP
- After the max. test time has been reached and action "End of test" was set for it
- After the max. battery capacity to consume has been reached and action "End of test" was set for it
- Any device alarm which would also switch off the DC input, like OT
- Passing the threshold U_{DV} (discharge voltage), which is equivalent to any voltage drop on the DC input caused by whatever reason



After an automatic stop, caused by any of the listed reasons, the test can't be continued or run again immediately. The full battery configuration has to be run through, accessible via touch area BACK.

3.10.13 MPP tracking function

MPP stands for the maximum power point (see principle view to the right) on the power curve of solar panels. Solar inverters, when connected to such panels, constantly track this MPP once it has been found.

The device simulates this behaviour by a function. It can be used to test even huge solar panels without having to connect a usually big solar inverter device which also requires to have a load connected to its AC output. Furthermore, all MPP tracking related parameters of the load can be adjusted and it so is much more flexible than an inverter with its limited DC input range.

For evaluation and analysis purposes, the load can also record measured data, i. e. DC input values such as actual voltage, current or power, to USB stick or provide them for reading via digital interface.

The MPP tracking function offers four modes. Unlike with other functions or general use of the device, values for the MPP tracking are only entered by direct input via the touch screen.

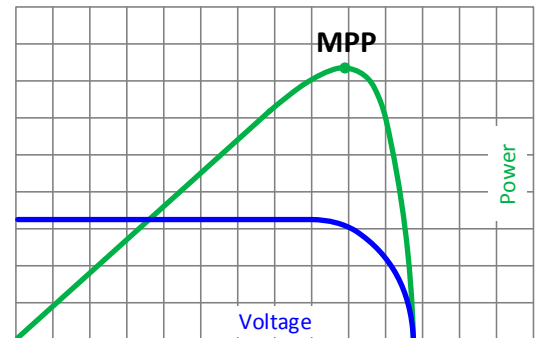
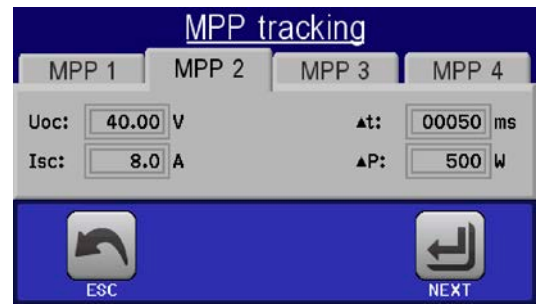

3.10.13.1 Mode MPP1

This mode is also called “find MPP”. It’s the simplest option to have the device find the MPP of a connected solar panel. It requires to set only three parameters. Value U_{OC} is necessary, because it helps to find the MPP quicker as if the load would start at 0 V or maximum voltage. Actually, it would start at a voltage level slightly above U_{OC} .

I_{SC} is used as an upper limit for the current, so the load would not try to draw more current than the panel is specified for.

Following parameters can be configured for tracking mode **MPP1**:

Value	Range	Description
U_{OC}	0...Nominal value of U	Voltage of the solar panel when unloaded, taken from the panel specs
I_{SC}	0...Nominal value of I	Short-circuit current, max. specified current of the solar panel
Δt	5 ms...65535 ms	Interval for measuring U and I during the process of finding the MPP

Application and result:

After the three parameters have been set, the function can be started. As soon as the MPP has been found, the function will stop and switch off the DC input. The acquired MPP values of voltage (U_{MPP}), current (I_{MPP}) and power (P_{MPP}) are then shown in the display.

The time of a function run depends on the parameter Δt . Even with the minimum setting of 5 ms one run take already a few seconds.

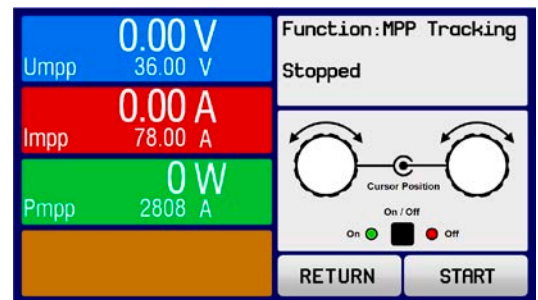

3.10.13.2 Mode MPP2

This mode tracks the MPP, so it’s closest to the operation of a solar inverter. Once the MPP is found, the function won’t stop, but try to track the MPP permanently. Due to the nature of solar panels this can only be done below the level of the MPP. As soon as this point is reached, the voltage starts to sink further and so does the actual power. The additional parameter ΔP defines how much the power may sink before the direction is reversed and the voltage starts to rise again until the load reaches the MPP. The result is a zigzag shaped curve of both, voltage and current.

A typical curve display is shown in the picture to the right. For the example, the ΔP was set to a quite small value, so the power curve looks almost linear. With a small ΔP the load would always track close to the MPP.

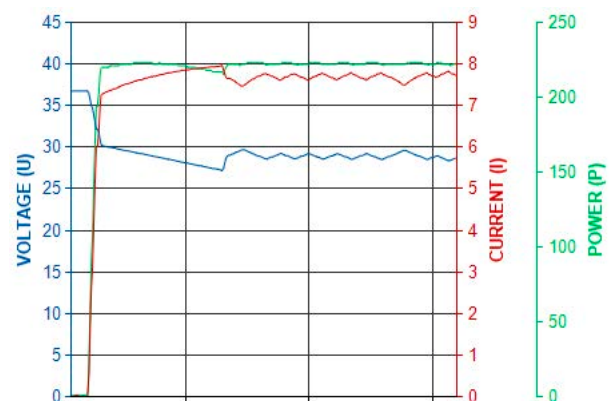

Following parameters can be configured for tracking mode **MPP2**:

Value	Range	Description
U_{OC}	0...Nominal value of U	Voltage of the solar panel when unloaded, taken from the panel specs
I_{SC}	0...Nominal value of I	Short-circuit current, max. specified current of the solar panel
Δt	5 ms...65535 ms	Interval for measuring U and I during the process of finding the MPP
ΔP	0 W...0.5 P_{Nom}	Tracking/regulation tolerance below the MPP

3.10.13.3 Mode MPP3

Also called “fast track”, this mode is very similar to mode MPP2, but without the initial step which is used to find the actual MPP, because mode MPP3 would directly jump to the power point defined by user input (U_{MPP} , P_{MPP}). In case the MPP values of the equipment under test are known, this can save a lot of time in repetitive tests. The rest of the function run is the same as with MPP2 mode. During and after the function, the least acquired MPP values of voltage (U_{MPP}), current (I_{MPP}) and power (P_{MPP}) are shown in the display.

Following parameters can be configured for tracking mode **MPP3**:

Value	Range	Description
U_{MPP}	0...Nominal value of U	Voltage in the MPP
I_{SC}	0...Nominal value of I	Short-circuit current, max. specified current of the solar panel
P_{MPP}	0...Nominal value of P	Power in the MPP
Δt	5 ms...65535 ms	Interval for measuring U and I during the process of finding the MPP
ΔP	0 W...0.5 P_{Nom}	Tracking/regulation tolerance below the MPP

3.10.13.4 Mode MPP4

This mode is different, because it does not track automatically. It rather offers the choice to define an user curve by setting up to 100 points of voltage values, then track this curve, measure current and power and return the results in up to 100 sets of acquired data. The curve points can be entered manually or loaded from USB stick. Start and end point can be adjusted arbitrarily, Δt defines the time between two points and the function run can be repeated up to 65535 times. Once the function stops at the end or by manual interrupt, the DC input is switched off and the measured data is made available. After the function, the acquired set of data with the highest actual power will be shown in the display as voltage (U_{MPP}), current (I_{MPP}) and power (P_{MPP}) of the MPP. Going back on the screen with RETURN then allows for data export to USB stick.

Following parameters can be configured for tracking mode **MPP4**:

Value	Range	Description
$U_1...U_{100}$	0...Nominal value of U	Voltage for the up to 100 user definable curve points
Start	1-100	Start point for the run of x out of 100 subsequent points
End	1-100	End point for the run of x out of 100 subsequent points
Δt	5 ms...65535 ms	Time before the next point
Rep.	0-65535	Number of repetitions for the run from Start to End

3.10.14 Remote control of the function generator

The function generator can be remotely controlled, but configuration and control of the functions with individual commands is different from manual operation. The external documentation “Programming Guide ModBus RTU & SCPI” on the included USB stick explains the approach. In general the following items apply:

- The function generator isn’t controllable via the analog interface
- The function generator is unavailable if R mode (resistance) is activated
- Function “Battery test” isn’t available for remote control

3.11 Other applications

3.11.1 Series connection



Series connection isn't a permissible operating method for electronic loads and must not be installed or operated under any circumstances!

3.11.2 Parallel operation

Multiple devices of same kind and ideally same model can be connected in parallel in order to create a system with higher total current and hence higher power. This can be achieved by connecting all units to the DC source in parallel, so the total current can spread across all devices. There is no support for a balancing between the individual units, like in form of a master-slave system. All loads would have to be controlled and set up separately. However, it's possible to have a parallel control by the signals on the analog interface, as this one is galvanically isolated from the rest of the device. There are few general points to consider and adhere:

- Always make parallel connections only with device of same voltage, current and power rating, but at least with those of the same voltage rating
- Never connect the ground signal of any analog interface with the negative DC input, because it will void the galvanic isolation. This rule is especially important when going to connect any DC input pole to ground (PE) or to shift its potential.
- Never connect DC input cables from load device to load device, but instead from every load device directly to the source, else the total current will exceed the current rating of the DC input clamp

4. Service and maintenance

4.1 Maintenance / cleaning

The device needs no maintenance. Cleaning may be needed for the internal fans, the frequency of cleanse is depending on the ambient conditions. The fans serve to cool the components which are heated by the inherent high dissipation of energy. Heavily dirt filled fans can lead to insufficient airflow and therefore the DC input would switch off too early due to overheating or possibly lead to defects.

Cleaning the internal fans can be performed with a vacuum cleaner or similar. For this the device needs to be opened.

4.2 Fault finding / diagnosis / repair

If the equipment suddenly performs in an unexpected way, which indicates a fault, or it has an obvious defect, this can't and must not be repaired by the user. Contact the supplier in case of suspicion and elicit the steps to be taken.

It will then usually be necessary to return the device to Elektro-Automatik (with or without warranty). If a return for checking or repair is to be carried out, ensure that:

- the supplier has been contacted and it's clarified how and where the equipment should be sent.
- the device is in fully assembled state and in suitable transport packaging, ideally the original packaging.
- a fault description in as much detail as possible is attached.
- if shipping destination is abroad, the necessary customs papers are attached.

4.2.1 Replacing a defect mains fuse

The device is protected by a fusible which is inside a fuse holder on the rear of the device. The fuse rating is printed next to the fuse holder. Replace the fuse only with one of same size and rating.

4.2.2 Firmware updates



Firmware updates should only be installed when they can eliminate existing bugs in the firmware in the device or contain new features.

The firmware of the control panel (HMI), of the communication unit (KE) and the digital controller (DR), if necessary, is updated via the rear side USB port. For this the software EA Power Control is needed which is included with the device or available as download from our website together with the firmware update, or upon request.

However, be advised not to install updates promptly. Every update includes the risk of an inoperable device or system. We recommend to install updates only if...

- an imminent problem with your device can directly be solved, especially if we suggested to install an update during a support case
- a new feature has been added which you definitely want to use. In this case, the full responsibility is transferred to you.

Following also applies in connection with firmware updates:

- Simple changes in firmwares can have crucial effects on the application the devices are use in. We thus recommend to study the list of changes in the firmware history very thoroughly.
- Newly implemented features may require an updated documentation (user manual and/or programming guide, as well as LabVIEW VIs), which is often delivered only later, sometimes significantly later

4.3 Calibration

4.3.1 Preface

The devices of series EL 9000 DT feature a function to re-adjust the most important input related values when doing a calibration and in case these values have moved out of tolerance. The re-adjustment is limited to compensate small differences of up to 1% or 2% of the max. value. There are several reasons which could make it necessary to re-adjust a unit: component aging, component deterioration, extreme ambient conditions, high frequent use.

In order to determine if a value is out of tolerance, the parameter must be verified first with measurement tools of high accuracy and with at least half the error of the EL device. Only then a comparison between values displayed on the EL device and true DC input values is possible.

For example, if you want to verify and possibly re-adjust the input current of model EL 9080-60 DT which has 60 A maximum current stated with a max. error of 0.2%, you can only do that by using a high current shunt with max. 0.1% error or less. Also, when measuring such high currents, it's recommended to keep the process short, in order to avoid the shunt heating up too much. It's furthermore recommended to use a shunt with at least 25% reserve.

When measuring the current with a shunt, the measurement error of the multimeter on the shunt adds to the error of the shunt and the sum of both must not exceed the given max. 0.4% of the device.

4.3.2 Preparation

For a successful calibration and, if necessary, re-adjustment a few tools and certain ambient conditions are required:

- A measurement device (multimeter) for voltage, with a max. error of half the EL's voltage error. That measurement device can also be used to measure the shunt voltage when re-adjusting the current
- If the current is also going to be calibrated: a suitable DC current shunt, ideally specified for at least 1.25 times the max. input current of the EL and with a max. error that is half or less than the max. current error of the EL device
- Normal ambient temperature of approx. 20-25 °C
- An adjustable voltage & current source which is capable of providing at least 102% of the max. voltage and current of the EL device, or separate voltage source and current source units

Before starting the calibration procedure, a few measures have to be taken:

- Let the EL device warm up for at least 10 minutes under 50% power, in connection with the voltage / current source
- In case the remote sensing input is going to be calibrated, prepare a cable for the remote sensing connector to DC input, but leave it yet unconnected
- Abort any form of remote control and set device to **UI** mode
- Install the shunt between source and EL device and make sure the shunt is cooled somehow. For example , you might want to place it in the warm air stream coming out of the rear of the EL device. This helps the shunt to warm up as well to operation temperature
- Connect suitable measurement devices to the DC input and to the shunt, depending on whether the voltage is going to be calibrated first or the current

4.3.3 Calibration procedure

After the preparation, the device is ready to be calibrated. From now on, a certain sequence of parameter calibration is important. Generally, you don't need to calibrate all three parameters, but it's recommended to do so.

Important:



*The input current calibration should be done before any voltage calibration, because the calibrated input current is used for voltage calibration.
When calibrating the input voltage, the remote input sense on the rear of the device has to be disconnected.*

The calibration procedure, as explained below, is an example with model EL 9080-60 DT. Other models are treated the same way, with values according to the particular EL model and the required power source.

4.3.3.1 Calibrating the set values

► How to calibrate the voltage

1. Adjust the connected voltage source to approx. 102% of the maximum voltage specified for the EL device. For the example with an 80 V EL this would be 81.6 V for the source. Set the current limitation of the voltage source to >5% of the nominal current specified for EL device, for this example it's at least 3 A. Check again, that for voltage calibration, the sensing connector (Sense) on the front of the device isn't connected.
2. In the display tap on MENU, then **General Settings**, then use  to reach **Calibrate device:** and then tap **START**.
3. In the next screen select **Voltage calibration**, then **Calibrate input val.** and **NEXT**. The load will switch the DC input on and start to measure the input voltage (**U-mon**).
4. The next screen requests you to enter the measured input voltage at **Measured value=** from the multimeter. Enter it using the keypad, that appears when tapping the value. Assure yourself the value is correct and submit with **ENTER**.
5. Repeat step 4. for the next three steps (total of four steps).

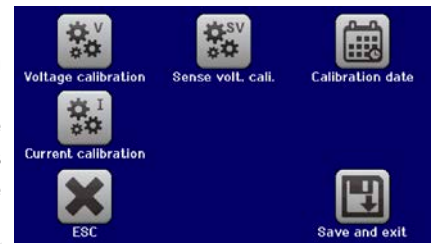

► How to calibrate the current

1. Adjust the current source to approx. 102% nominal current of the EL device, for the sample model with 60 A this would be 61.2 A, rounded to 62 A. Make sure the source can provide more current than the EL can draw, else the source's voltage will collapse. Set the output voltage of the current source to 10% of the nominal voltage specified for EL, in the example 8 V, and switch the DC output of the source on.
2. In the display, tap MENU, then **General Settings**, then use  to reach **Calibrate device:** and then tap **START**.
3. In the next screen select: **Current calibration**, then **Calibrate input val.** and **NEXT**. The load will switch on the DC input and start to measure (**I-mon**).
4. The next screen requests you to enter the input current **Measured value=** measured with the shunt. Enter it using the keypad, assure yourself the value is correct and submit with **ENTER**.
5. Repeat step 4. for the next three steps (total of four steps).

4.3.3.2 Calibrating the remote sensing

In case you are generally using the remote sensing feature (Sense), it's recommended to readjust this parameter too, for best results. The procedure is identical to the calibration of voltage, except for it requires to have the sensing connector on the rear to be plugged and connected with correct polarity to the DC input of the EL.

► How to calibrate the remote sensing voltage

1. Adjust the connected voltage source to approx. 102% of the maximum voltage specified for the EL device. For example with an 80 V EL this would be 81.6 V for the source. Set the current limitation of the voltage source to >5% of the nominal current specified for EL device, for this example it's at least 3 A.
2. In the display, tap MENU, then **General Settings**, then use  to reach **Calibrate device:** and then tap **START**.
3. In the next screen select: **Sense volt. calibration**, then **Calibrate input val.** and **NEXT**.
4. The next screen requests you to enter the measured sensing voltage **Measured value=** from the multimeter. Enter it using the keypad, that appears when tapping the value. Assure yourself the value is correct and submit with **ENTER**.
5. Repeat step 4. for the next three steps (total of four steps).

4.3.3.3 Calibrating the actual values

Actual values of the input voltage (with and without remote sensing) and the input current are calibrated almost the same way as the set values, but here you don't need to enter anything, but just confirm the displayed values. Please proceed the above steps and instead of **Calibrate input val.** select **Calibrate actual val.** in the sub menus. After the device shows the measured values on display, wait at least 2s for the measured value to settle and then tap **NEXT** until you are through all steps.

4.3.3.4 Save and exit

After calibration you may furthermore enter the current date as “calibration date” by tapping  in the selection screen and enter the date in format YYYY / MM / DD.



Last but not least save the calibration data permanently by tapping



Leaving the calibration selection menu without “Save and exit” will discard calibration data and the procedure would have to be repeated!

