

## PRODUCT DESCRIPTION

The EM32-1B is a 3 ½ digit LCD voltmeter which is designed to be panel mounted in most low and medium volume applications. The meter features 8mm digit height, 3 decimal points, auto-polarity, auto-zero, 200mV full scale reading and a very low current consumption. This product is designed so no soldering is required. Connection is via screw terminals, and options are selected via jumper links. The module features a round metal bezel, requiring a 32.5mm (1.28") diameter cut-out. It is secured with the nut provided. Protection from the front to IP 67 / NEMA 4X standards is achieved by placing the rubber seal between the module and panel during assembly.

## FEATURES

- 8mm (0.31") Digit Height
- 200mV d.c. Full Scale Reading
- 3.5 to 6.5V or 7.5 to 14.0V Operation
- Auto-zero and Auto-polarity
- Selectable Decimal Points
- Requires 32.5mm (1.28") Diameter Cut-out
- IP67 / NEMA 4X Protected



## TYPICAL APPLICATIONS

- Panel Mount Instrumentation
- Process & Control
- Automotive

## ORDERING INFORMATION

Standard Meter

Stock Number  
EM32-1B

## ELECTRICAL SPECIFICATIONS

Specification	Min.	Typ.	Max.	Unit	
Accuracy (overall error) *		0.1		% ( $\pm 1$ count)	
Linearity			$\pm 1$	count	
Sample rate		2.5		samples/sec	
Operating temperature range	0		50	$^{\circ}\text{C}$	
Temperature stability		100		ppm/ $^{\circ}\text{C}$	
Supply voltage	L1 in default configuration	3.5	5.0	6.5**	V d.c.
	L1 re-configured	7.5	9.0	14.0**	V d.c.
Supply current	L1 in default configuration		500		$\mu\text{A}$
	L1 re-configured		150		$\mu\text{A}$
Input leakage current ( $V_{in} = 0\text{V}$ )		1	10	$\text{pA}$	

\* To ensure maximum accuracy, re-calibrate periodically.

\*\* Operation of the meter beyond the maximum supply voltage rating may cause permanent damage to the meter.

Unless otherwise noted, specifications apply at  $T_A = 25^{\circ}\text{C}$ ,  $V_{supply} = 5\text{Vd.c.}$  ( $f_{clock} = 48\text{kHz}$ ) and are tested with the module configured for floating input mode.

## SAFETY

To comply with the Low Voltage Directive (LVD 93/68/EEC), input voltages to the module's pins must not exceed 60Vdc. The user must ensure that the incorporation of the panel meter into the user's equipment conforms to the relevant sections of BS EN 61010 (Safety Requirements for Electrical Equipment for Measuring, Control and Laboratory Use).



99 Washington Street  
Melrose, MA 02176  
Phone 781-665-1400  
Toll Free 1-800-517-8431

Visit us at [www.TestEquipmentDepot.com](http://www.TestEquipmentDepot.com)

## DIMENSIONS

All dimensions in mm (inches)

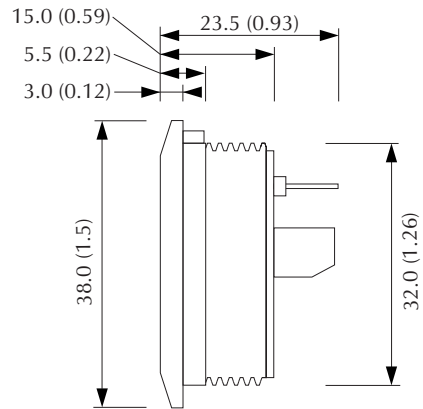
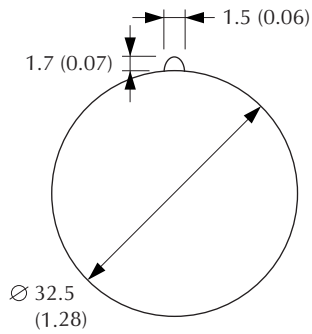

## PANEL MOUNTING

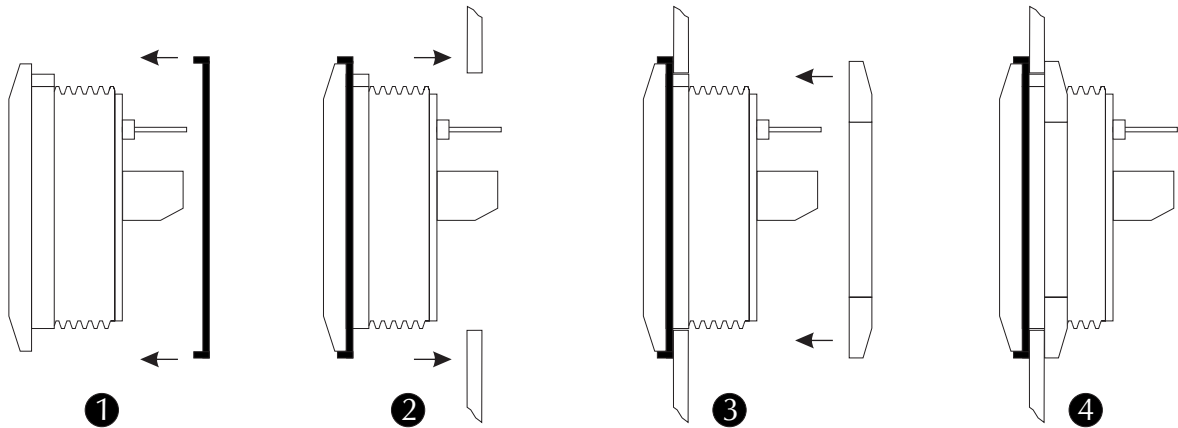

## FUNCTIONAL BLOCK DIAGRAM

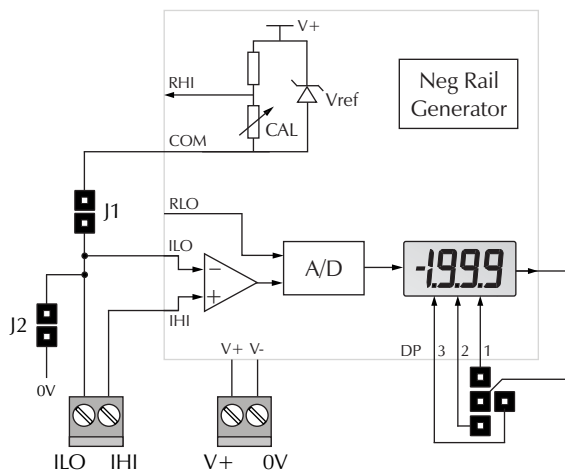

## CONNECTIONS (rear view)

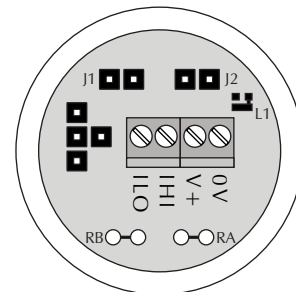

## CIRCUIT DIAGRAM

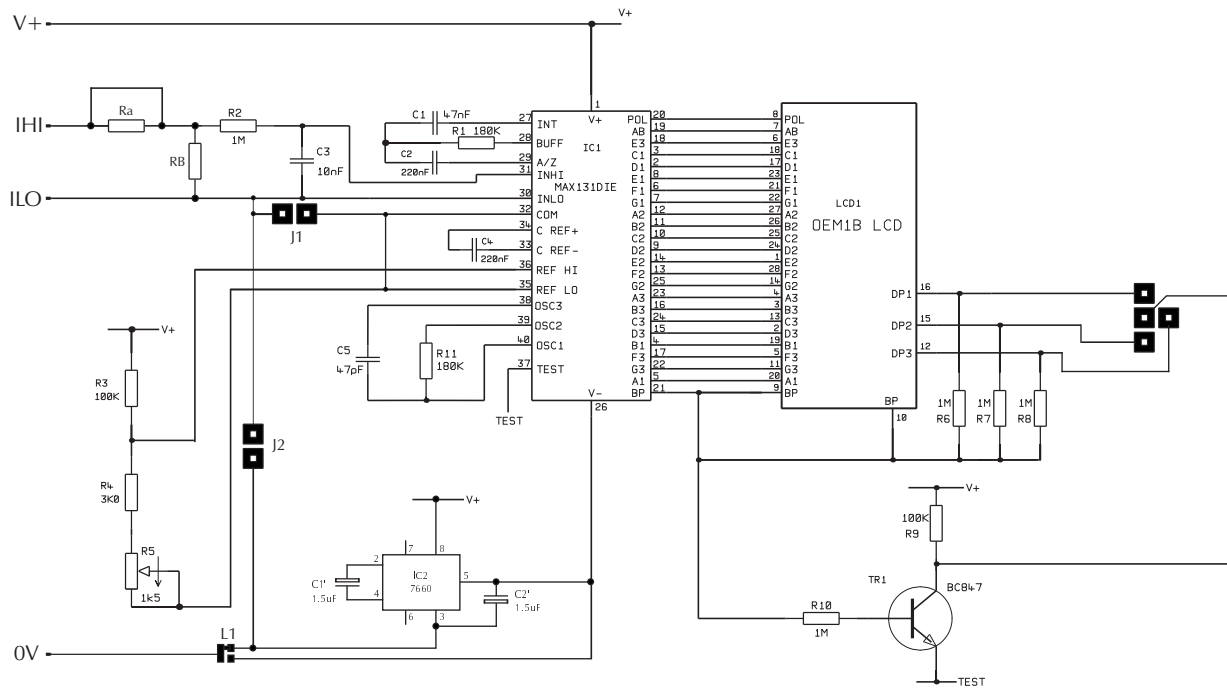

## PIN FUNCTIONS

- 0V Negative power supply to the meter.
- V+ Positive power supply to the meter.
- IHI Positive measuring input.  
IHI must be no closer than 1.5V to either the positive or negative supply.
- ILO Negative measuring input.  
ILO must be no closer than 1.5V to either the positive or negative supply.

## JUMPER LINKS

- J1 Connects ILO to COM, when jumper link is fitted.
- J2 Connects ILO to 0V, when jumper link is fitted.

## Solder LINK L1

Solder Link L1 is used to select the power supply mode of the EM32-1B.

With L1 in the default configuration, the module operates from a 3.5 to 6.5Vd.c. supply, and measurements can be made with respect to power supply 0V.

When L1 is re-configured, the module operates from a 7.5 to 14.0Vd.c supply. The voltage being measured must then be floating with respect to the meter's power supply.

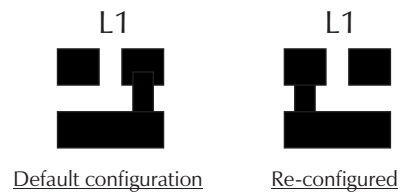

## SCALING

Two resistors Ra and Rb may be used to alter the full scale reading (FSR) of the meter - see table. The meter will have to be re-calibrated by adjusting the calibration potentiometer on the rear of the module.

	FSR	Ra	Rb
Voltage Vin	2V	910k	100k
	20V	1M	10k
	200V	1M	1k
	2000V*	1M	100R
Current Iin	200µA	0R	1k
	2mA	0R	100R
	20mA	0R	10R
	200mA	0R	1R

\*Ensure that Ra is rated for high voltage use.

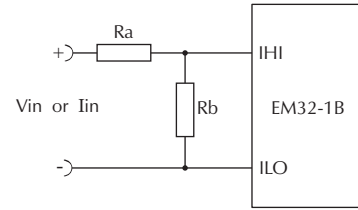

## APPLICATIONS

Do not connect more than one meter to the same power supply if the meters cannot use the same signal ground. Taking any input beyond the power supply rails will damage the meter.

### 5V supply operation (3.5 to 6.5V Meter Power Supply)

L1 =

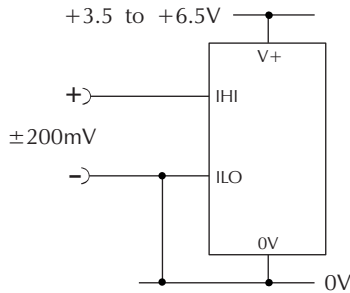

Measuring a single ended input voltage referenced to supply, i.e. the input voltage and the meter's power supply share the same 0V rail. Ensure jumper link J1 is not fitted. Ensure jumper link J2 is not fitted.

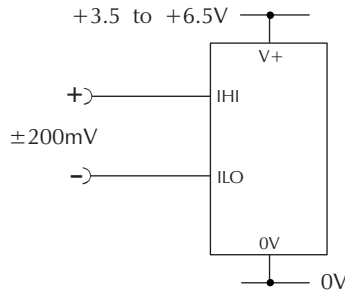

Measuring an input voltage referenced to a floating supply, i.e. the input voltage and the meter's power supply are isolated from each other. Ensure jumper link J1 is fitted. Ensure jumper link J2 is not fitted.

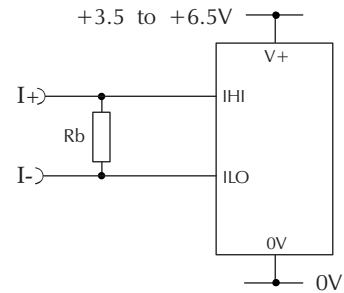

Measuring a current from a circuit which is floating with respect to the meter's supply, i.e. the current and the meter's power supply are isolated from each other. Ensure jumper link J1 is fitted. Ensure jumper link J2 is not fitted.

### 9V supply operation (7.5 to 14.0V Meter Power Supply)

L1 =

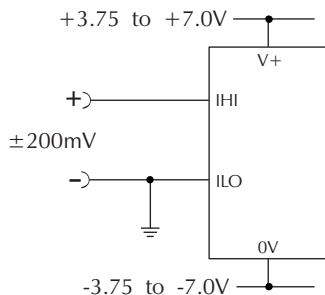

Measuring a single ended input voltage referenced to supply, i.e. the input voltage and the meter's power supply share the same 0V rail. Ensure jumper link J1 is not fitted. Ensure jumper link J2 is fitted.

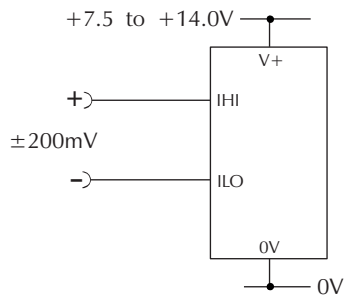

Measuring an input voltage referenced to a floating supply, i.e. the input voltage and the meter's power supply are isolated from each other. Ensure jumper link J1 is fitted. Ensure jumper link J2 is not fitted.

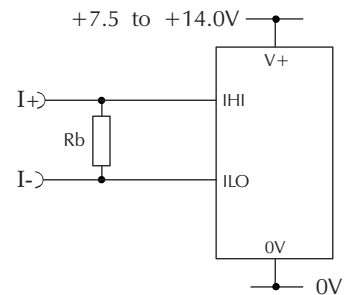

Measuring a current from a circuit which is floating with respect to the meter's supply, i.e. the current and the meter's power supply are isolated from each other. Ensure jumper link J1 is fitted. Ensure jumper link J2 is not fitted.