

User's Guide

EXTECH[®] INSTRUMENTS

Autoranging True RMS Multimeter

Extech EX505

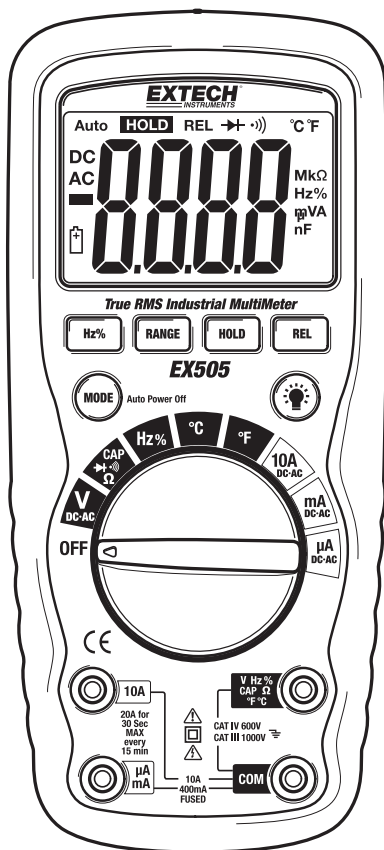

**Test Equipment
Depot**

1-800-517-8431

99 Washington Street
Melrose, MA 02176
Phone 781-665-1400
Toll Free 1-800-517-8431

 Visit us at www.TestEquipmentDepot.com

 Back to the Extech EX500 Series Info Page

Introduction

Congratulations on your purchase of the Extech EX505 True RMS Autoranging Multimeter. This meter measures AC/DC Voltage, AC/DC Current, Resistance, Capacitance, Frequency, Diode Test, and Continuity plus Thermocouple Temperature. It features a waterproof, rugged design for heavy duty use. This meter is shipped fully tested and calibrated and, with proper use, will provide years of reliable service.

Safety



This symbol adjacent to another symbol, terminal or operating device indicates that the operator must refer to an explanation in the Operating Instructions to avoid personal injury or damage to the meter.

WARNING

This **WARNING** symbol indicates a potentially hazardous situation, which if not avoided, could result in death or serious injury.

CAUTION

This **CAUTION** symbol indicates a potentially hazardous situation, which if not avoided, may result damage to the product.



This symbol advises the user that the terminal(s) so marked must not be connected to a circuit point at which the voltage with respect to earth ground exceeds (in this case) 1000 VAC or VDC.

This symbol adjacent to one or more terminals identifies them as being associated with ranges that may, in normal use, be subjected to particularly hazardous voltages. For maximum safety, the meter and its test leads should not be handled when these terminals are energized.

This symbol indicates that a device is protected throughout by double insulation or reinforced insulation.

PER IEC1010 OVERVOLTAGE INSTALLATION CATEGORY

OVERVOLTAGE CATEGORY I

Equipment of OVERVOLTAGE CATEGORY I is equipment for connection to circuits in which measures are taken to limit the transient overvoltages to an appropriate low level.

Note – Examples include protected electronic circuits.

OVERVOLTAGE CATEGORY II

Equipment of OVERVOLTAGE CATEGORY II is energy-consuming equipment to be supplied from the fixed installation.

Note – Examples include household, office, and laboratory appliances.

OVERVOLTAGE CATEGORY III

Equipment of OVERVOLTAGE CATEGORY III is equipment in fixed installations.

Note – Examples include switches in the fixed installation and some equipment for industrial use with permanent connection to the fixed installation.

OVERVOLTAGE CATEGORY IV

Equipment of OVERVOLTAGE CATEGORY IV is for use at the origin of the installation.

Note – Examples include electricity meters and primary over-current protection equipment

SAFETY INSTRUCTIONS

This meter has been designed for safe use, but must be operated with caution. The rules listed below must be carefully followed for safe operation.

1. **NEVER** apply voltage or current to the meter that exceeds the specified maximum:

Input Protection Limits	
Function	Maximum Input
V DC or V AC	1000VDC/AC rms
mA AC/DC	400mA AC/DC
A AC/DC	10A AC/DC (20A for 30 sec)
Frequency, Resistance, Capacitance, Diode Test, Continuity, Temperature	600VDC/AC rms

2. **USE EXTREME CAUTION** when working with high voltages.
3. **DO NOT** measure voltage if the voltage on the "COM" input jack exceeds 600V above earth ground.
4. **NEVER** connect the meter leads across a voltage source while the function switch is in the current, resistance, or diode mode. Doing so can damage the meter.
5. **ALWAYS** discharge filter capacitors in power supplies and disconnect the power when making resistance or diode tests.
6. **ALWAYS** turn off the power and disconnect the test leads before opening the covers to replace the fuse or batteries.
7. **NEVER** operate the meter unless the back cover and the battery and fuse covers are in place and fastened securely.
8. If the equipment is used in a manner not specified by the manufacturer, the protection provided by the equipment may be impaired.

Controls and Jacks

1. 4,000 count LCD display
2. RANGE button
3. Hz and % button
4. Mode button
5. Function switch
6. mA, μ A and 10A input jacks
7. COM input jack
8. Positive input jack
9. Backlight button
10. **REL** button
11. **HOLD** button

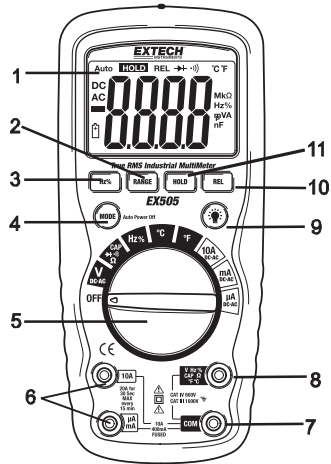

Note: Tilt stand and battery compartment are on rear of unit.

Symbols and Annunciators

•)))	Continuity
▶	Diode test
⊕	Battery status
n	nano (10^{-9}) (capacitance)
μ	micro (10^{-6}) (amps)
m	milli (10^{-3}) (volts, amps)
A	Amps
k	kilo (10^3) (ohms)
F	Farads (capacitance)
M	mega (10^6) (ohms)
Ω	Ohms
Hz	Hertz (frequency)
%	Percent (duty ratio)
AC	Alternating current
DC	Direct current
$^{\circ}$ F	Degrees Fahrenheit

V	Volts
REL	Relative
Auto	Autoranging
HOLD	Display hold
$^{\circ}$ C	Degrees Centigrade

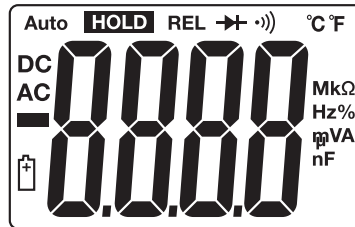

Operating Instructions

WARNING: Risk of electrocution. High-voltage circuits, both AC and DC, are very dangerous and should be measured with great care.

1. ALWAYS turn the function switch to the **OFF** position when the meter is not in use.
2. If “**OL**” appears in the display during a measurement, the value exceeds the range you have selected. Change to a higher range.

DC VOLTAGE MEASUREMENTS

CAUTION: Do not measure DC voltages if a motor on the circuit is being switched ON or OFF. Large voltage surges may occur that can damage the meter.

1. Set the function switch to the **V** position.
2. Press the MODE button to select DC (if necessary).
3. Insert the black test lead banana plug into the negative **COM** jack. Insert the red test lead banana plug into the positive **V** jack.
4. Touch the black test probe tip to the negative side of the circuit.
Touch the red test probe tip to the positive side of the circuit.
5. Read the voltage in the display.

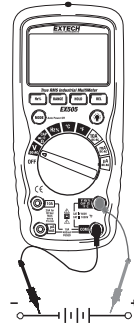

AC VOLTAGE (FREQUENCY, DUTY CYCLE) MEASUREMENTS

WARNING: Risk of Electrocutation. The probe tips may not be long enough to contact the live parts inside some 240V outlets for appliances because the contacts are recessed deep in the outlets. As a result, the reading may show 0 volts when the outlet actually has voltage on it. Make sure the probe tips are touching the metal contacts inside the outlet before assuming that no voltage is present.

CAUTION: Do not measure AC voltages if a motor on the circuit is being switched ON or OFF. Large voltage surges may occur that can damage the meter.

1. Set the function switch to the **V** position.
2. Press the MODE button to select AC (if necessary).
3. Insert the black test lead banana plug into the negative **COM** jack. Insert red test lead banana plug into the positive **V** jack.
4. Touch the black test probe tip to the neutral side of the circuit.
Touch the red test probe tip to the “hot” side of the circuit.
5. Read the voltage in the display.
6. Press the **HZ/%** button to indicate “Hz”.
7. Read the frequency in the display.
8. Press the **HZ/%** button again to indicate “%”.
9. Read the % of duty cycle in the display.

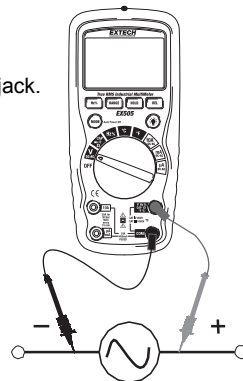

DC CURRENT MEASUREMENTS

CAUTION: Do not make 20A current measurements for longer than 30 seconds. Exceeding 30 seconds may cause damage to the meter and/or the test leads.

1. Insert the black test lead banana plug into the negative **COM** jack.
2. For current measurements up to 4000 μ A DC, set the function switch to the **μ A** position and insert the red test lead banana plug into the **μ A/mA** jack.
3. For current measurements up to 400mA DC, set the function switch to the **mA** position and insert the red test lead banana plug into the **μ A/mA** jack.
4. For current measurements up to 10A DC, set the function switch to the **10A** position and insert the red test lead banana plug into the **10A** jack.
5. Press the **MODE** button to indicate “**DC**” on the display.
6. Remove power from the circuit under test, then open up the circuit at the point where you wish to measure current.
7. Touch the black test probe tip to the negative side of the circuit. Touch the red test probe tip to the positive side of the circuit.
8. Apply power to the circuit.
9. Read the current in the display.

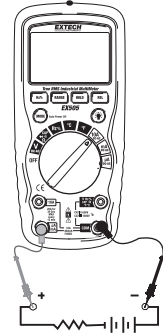

AC CURRENT (FREQUENCY, DUTY CYCLE) MEASUREMENTS

CAUTION: Do not make 20A current measurements for longer than 30 seconds. Exceeding 30 seconds may cause damage to the meter and/or the test leads.

1. Insert the black test lead banana plug into the negative **COM** jack.
2. For current measurements up to 4000 μ A AC, set the function switch to the **μ A** position and insert the red test lead banana plug into the **μ A/mA** jack.
3. For current measurements up to 400mA AC, set the function switch to the **mA** position and insert the red test lead banana plug into the **μ A/mA** jack.
4. For current measurements up to 10A AC, set the function switch to the **10A** position and insert the red test lead banana plug into the **10A** jack.
5. Press the **MODE** button to indicate “**AC**” on the display.
6. Remove power from the circuit under test, then open up the circuit at the point where you wish to measure current.
7. Touch the black test probe tip to the neutral side of the circuit. Touch the red test probe tip to the “hot” side of the circuit.
8. Apply power to the circuit.
9. Read the current in the display.
10. Press the **Hz/%** button to indicate “**Hz**”.
11. Read the frequency in the display.
12. Press the **Hz/%** button again to indicate “**%**”.
13. Read the % duty cycle in the display.
14. Press the **Hz/%** button to return to current measurement.

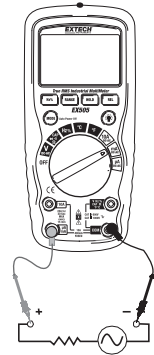

RESISTANCE MEASUREMENTS

WARNING: To avoid electric shock, disconnect power to the unit under test and discharge all capacitors before taking any resistance measurements. Remove the batteries and unplug the line cords.

1. Set the function switch to the Ω CAP \rightarrow \rightarrow) position.
2. Insert the black test lead banana plug into the negative **COM** jack. Insert the red test lead banana plug into the positive Ω jack.
3. Press the **MODE** button to indicate " Ω " on the display.
4. Touch the test probe tips across the circuit or part under test. It is best to disconnect one side of the part under test so the rest of the circuit will not interfere with the resistance reading.
5. Read the resistance in the display.

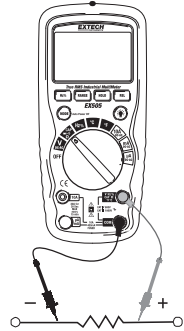

CONTINUITY CHECK

WARNING: To avoid electric shock, never measure continuity on circuits or wires that have voltage on them.

1. Set the function switch to the Ω CAP \rightarrow \rightarrow) position.
2. Insert the black lead banana plug into the negative **COM** jack. Insert the red test lead banana plug into the positive Ω jack.
3. Press the **MODE** button to indicate \rightarrow) and " Ω " on the display.
4. Touch the test probe tips to the circuit or wire you wish to check.
5. If the resistance is less than approximately 100Ω , the audible signal will sound. If the circuit is open, the display will indicate "**OL**".

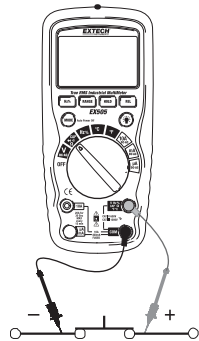

DIODE TEST

1. Set the function switch to the Ω CAP \rightarrow \rightarrow) position.
2. Insert the black test lead banana plug into the negative **COM** jack and the red test lead banana plug into the positive **V** jack.
3. Press the **MODE** button to indicate \rightarrow and **V** on the display.
4. Touch the test probes to the diode under test. Forward voltage will typically indicate 0.400 to 0.700V. Reverse voltage will indicate "**OL**". Shorted devices will indicate near 0V and an open device will indicate "**OL**" in both polarities.

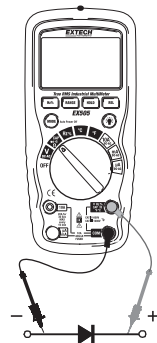

TEMPERATURE MEASUREMENTS

1. Set the function switch to the °F or °C position.
2. Insert the Temperature Probe into the input jacks, making sure to observe the correct polarity.
3. Touch the Temperature Probe head to the part whose temperature you wish to measure. Keep the probe touching the part under test until the reading stabilizes (about 30 seconds).
4. Read the temperature in the display.

Note: The temperature probe is fitted with a type K mini connector. A mini connector to banana connector adaptor is supplied for connection to the input banana jacks.

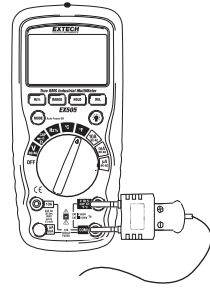

CAPACITANCE MEASUREMENTS

WARNING: To avoid electric shock, disconnect power to the unit under test and discharge all capacitors before taking any capacitance measurements. Remove the batteries and unplug the line cords.

1. Set the rotary function switch to the Ω CAP \rightarrow ∞ position.
2. Insert the black test lead banana plug into the negative **COM** jack. Insert the red test lead banana plug into the positive **V** jack.
3. Press the **MODE** button to indicate "nF" on the display.
4. Touch the test leads to the capacitor to be tested.
5. The test may take up to 3 minutes or more for large capacitors to charge. Wait until the readings settle before ending the test.
6. Read the capacitance value in the display

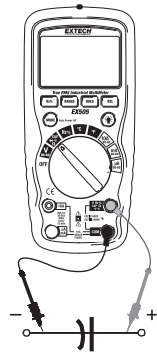

FREQUENCY/DUTY CYCLE MEASUREMENTS (ELECTRONIC)

1. Set the rotary function switch to the "Hz %" position.
2. Press the Hz/% button to indicate "Hz" in the display.
3. Insert the black lead banana plug into the negative **COM** jack and the red test lead banana plug into the positive **Hz** jack.
4. Touch the test probe tips to the circuit under test.
5. Read the frequency on the display.
6. Press the **Hz/%** button again to indicate "%" on the display.
7. Read the % of duty cycle on the display.

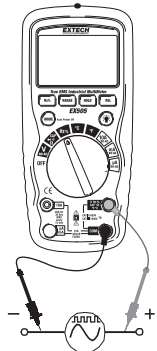

FREQUENCY SENSITIVITY (ELECTRICAL)

The frequency sensitivity is range dependent when the function is selected from while in the voltage or current measuring function. Below are typical sensitivities for the "electrical" measurement modes.

Range (DC/AC)	Sensitivity	Frequency width
4V	≥ 1.5V rms	5Hz~10kHz
40V, 400V	≥ 10V rms	5Hz~20kHz
	≥ 20V rms	5Hz~200kHz
1000V/1000V	≥ 420V rms	50Hz~1kHz
400mA	≥ 45mA rms	5Hz~5kHz
10A	≥ 4A rms	5Hz~1kHz

AUTORANGING/MANUAL RANGE SELECTION

When the meter is first turned on, it automatically goes into Autoranging. This automatically selects the best range for the measurements being made and is generally the best mode for most measurements. For measurement situations requiring that a range be manually selected, perform the following:

1. Press the **RANGE** key. The "Auto" display indicator will turn off.
2. Press the **RANGE** key to step through the available ranges. Observe the decimal point and units displayed until the preferred range is located.
3. To exit the Manual Ranging mode and return to Autoranging, press and hold the **RANGE** key for 2 seconds.

Note: Manual ranging does not apply for the Capacitance and Frequency functions.

RELATIVE MODE

The relative measurement feature allows you to make measurements relative to a stored zero reference value. A reference voltage, current, etc. can be stored and measurements made in comparison to that value. The displayed value is the difference between the reference value and the measured value.

1. Perform the measurement as described in the operating instructions.
2. Press the **REL** button to store (zero) the reading in the display and the "REL" indicator will appear on the display.
3. The display will now indicate the difference between the stored value and the measured value.
4. Press the **REL** button to exit the relative mode.

Note: The Relative function does not operate in the Frequency function.

DISPLAY BACKLIGHT

Press the backlight  button for >2 second to turn on. Press the button again to turn the backlight off.

HOLD

The hold function freezes the reading in the display. Press the **HOLD** key momentarily to activate or to exit the **HOLD** function.

AUTO POWER OFF

The auto off feature will turn the meter off after 30 minutes. To disable the auto power off feature, hold down the **MODE** button and turn the meter on.

LOW BATTERY INDICATION

The  icon will appear in the display when the battery voltage becomes low. Replace the battery when this appears.

Maintenance

WARNING: To avoid electric shock, disconnect the test leads from any source of voltage before removing the back cover or the battery or fuse covers.

WARNING: To avoid electric shock, do not operate your meter until the battery and fuse covers are in place and fastened securely.

This MultiMeter is designed to provide years of dependable service, if the following care instructions are performed:

1. **KEEP THE METER DRY.** If it gets wet, wipe it off.
2. **USE AND STORE THE METER IN NORMAL TEMPERATURES.** Temperature extremes can shorten the life of the electronic parts and distort or melt plastic parts.
3. **HANDLE THE METER GENTLY AND CAREFULLY.** Dropping it can damage the electronic parts or the case.
4. **KEEP THE METER CLEAN.** Wipe the case occasionally with a damp cloth. **DO NOT** use chemicals, cleaning solvents, or detergents.
5. **USE ONLY FRESH BATTERIES OF THE RECOMMENDED SIZE AND TYPE.** Remove old or weak batteries so they do not leak and damage the unit.
6. **IF THE METER IS TO BE STORED FOR A LONG PERIOD OF TIME,** the batteries should be removed to prevent damage to the unit.

BATTERY INSTALLATION

WARNING: To avoid electric shock, disconnect the test leads from any source of voltage before removing the battery cover.

1. Turn power off and disconnect the test leads from the meter.
2. Open the rear battery cover by removing two screws (B) using a Phillips head screwdriver.
3. Insert the battery into battery holder, observing the correct polarity.
4. Put the battery cover back in place. Secure with the screws.

WARNING: To avoid electric shock, do not operate the meter until the battery cover is in place and fastened securely.

NOTE: If your meter does not work properly, check the fuses and batteries to make sure that they are still good and that they are properly inserted.

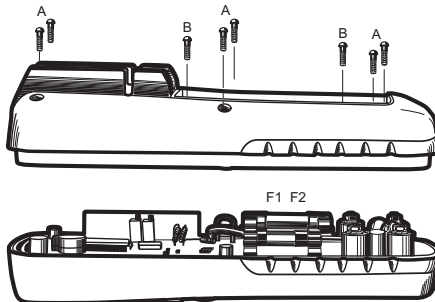

REPLACING THE FUSES

WARNING: To avoid electric shock, disconnect the test leads from any source of voltage before removing the fuse cover.

1. Disconnect the test leads from the meter.
2. Remove the battery cover (two "B" screws) and the battery.
3. Remove the six "A" screws securing the rear cover.
4. Gently remove the old fuse and install the new fuse into the holder.
5. Always use a fuse of the proper size and value (0.5A/1000V fast blow for the 400mA range [SIBA 70-172-40], 10A/1000V fast blow for the 20A range [SIBA 50-199-06]).
6. Replace and secure the rear cover, battery and battery cover.

WARNING: To avoid electric shock, do not operate your meter until the fuse cover is in place and fastened securely.

Specifications

Function	Range	Resolution	Accuracy
DC Voltage	400mV	0.1mV	$\pm(0.5\% \text{ reading} + 2 \text{ digits})$
	4V	0.001V	
	40V	0.01V	$\pm(1.2\% \text{ reading} + 2 \text{ digits})$
	400V	0.1V	
	1000V	1V	
AC Voltage	400mV	0.1mV	$\pm(2.0\% \text{ reading} + 10 \text{ digits})$
	4V	0.001V	$\pm(2.0\% \text{ reading} + 5 \text{ digits})$
	40V	0.01V	
	400V	0.1V	
	1000V	1V	
DC Current	400 μ A	0.1 μ A	$\pm(1.0\% \text{ reading} + 3 \text{ digits})$
	4000 μ A	1 μ A	$\pm(1.5\% \text{ reading} + 3 \text{ digits})$
	40mA	0.01mA	
	400mA	0.1mA	
	10A	0.01A	
AC Current	400 μ A	0.1 μ A	$\pm(2.5\% \text{ reading} + 10 \text{ digits})$
	4000 μ A	1 μ A	$\pm(2.5\% \text{ reading} + 5 \text{ digits})$
	40mA	0.01mA	
	400mA	0.1mA	
	10A	0.01A	
			$\pm(3.0\% \text{ reading} + 7 \text{ digits})$

NOTE: Accuracy is stated at 65°F to 83°F (18°C to 28°C) and less than 75% RH.



99 Washington Street
Melrose, MA 02176
Phone 781-665-1400
Toll Free 1-800-517-8431



Visit us at www.TestEquipmentDepot.com



Back to the Exttech EX500 Series Info Page

Function	Range	Resolution	Accuracy	
Resistance	400Ω	0.1Ω	±(1.2% reading + 4 digits)	
	4kΩ	0.001kΩ	±(1.0% reading + 2 digits)	
	40kΩ	0.01kΩ	±(1.2% reading + 2 digits)	
	400kΩ	0.1kΩ		
	4MΩ	0.001MΩ		
		40MΩ	0.01MΩ	±(2.0% reading + 3 digits)
Capacitance	40nF	0.01nF	±(5.0% reading + 7 digits)	
	400nF	0.1nF	±(3.0% reading + 5 digits)	
	4μF	0.001μF		
	40μF	0.01μF		
		100μF	0.1μF	±(5% reading + 5 digits)
Frequency	5.999Hz	0.001Hz	±(1.5% reading + 1 digits)	
	59.99Hz	0.01Hz		
	599.9Hz	0.1Hz	±(1.2% reading + 3 digits)	
	5.999kHz	0.001kHz		
	59.99kHz	0.01kHz		
	599.9kHz	0.1kHz		
		5.999MHz	0.001MHz	±(1.5% reading + 4 digits)
		9.999MHz	0.001MHz	
		Sensitivity: 0.5V rms <500kHz; 3V rms >500kHz		
Duty Cycle	0.1 to 99.9%	0.1%	±(1.2% reading + 2 digits)	
	Pulse width: 100μs to 100ms, Frequency: 5Hz to 150kHz			
Temp (type-K)	-4 to 1382°F	0.1°<400°	±(3.0% reading + 5°C /9°F) (probe accuracy not included)	
	-20 to 750°C	1° ≥ 400°		

Note: Accuracy specifications consist of two elements:

- (% reading) – This is the accuracy of the measurement circuit.
- (+ digits) – This is the accuracy of the analog to digital converter.

Enclosure	Double molded, waterproof (IP67)
Shock (Drop Test)	6.5 feet (2 meters)
Diode Test	Test current of 0.3mA typical, open circuit voltage 1.5V DC typical
Continuity Check	Audible signal will sound if the resistance is less than 100Ω (approx.), test current <0.3mA
Temperature Sensor	Requires type K thermocouple
Input Impedance	7.8MΩ
AC Response	True rms
ACV Bandwidth	50Hz to 400Hz
Crest Factor	≤3 at full scale up to 500V, decreasing linearly to ≤1.5 at 1000V
Display	4,000 count backlit liquid crystal
Overrange indication	"OL" is displayed
Auto Power Off	30 minutes (approximately)
Polarity	Automatic (no indication for positive); Minus (-) sign for negative
Measurement Rate	2 times per second, nominal
Low Battery Indication	"  " is displayed if battery voltage drops below operating voltage
Battery	One 9 volt (NEDA 1604) battery
Fuses	mA, μA ranges; 0.5A/1000V ceramic fast blow A range; 10A/1000V ceramic fast blow
Operating Temperature	41°F to 104°F (5°C to 40°C)
Storage Temperature	-4°F to 140°F (-20°C to 60°C)
Operating Humidity	Max 80% up to 87°F (31°C) decreasing linearly to 50% at 104°F (40°C)
Storage Humidity	<80%
Operating Altitude	7000ft. (2000meters) maximum.
Weight	0.753lb (342g) (includes holster).
Size	7.2" x 3.2" x 2.2" (182 x 82 x 55mm)
Safety	This meter is intended for origin of installation use and protected, against the users, by double insulation per EN61010-1 and IEC61010-1 2 nd Edition (2001) to Category IV 600V and Category III 1000V; Pollution Degree 2. The meter also meets UL 61010-1, 2 nd Edition (2004), CAN/CSA C22.2 No. 61010-1 2 nd Edition (2004), and UL 61010B-2-031, 1 st Edition (2003)
Approvals	UL CE
UL Listed	The UL mark does not indicate that this product has been evaluated for the accuracy of its readings.