



**FDS Dual-Channel Series**  
**QUICK\_GUIDE**

**Aug. 2023 edition V1.0.4**

Copyright © LILLIPUT Company. All rights reserved.

The LILLIPUT's products are under the protection of the patent rights, including ones which have already obtained the patent rights and those which are applying for. The information in this manual will replace all that in the materials published originally.

The information in this manual was correct at the time of printing. However, LILLIPUT will continue to improve products and reserves the rights to change specification at any time without notice.

**owon**® is the registered trademark of the LILLIPUT Company.

# General Warranty

We warrant that the product will be free from defects in materials and workmanship for a period of 3 years from the date of purchase of the product by the original purchaser from our company. The warranty period for accessories such as probes is 12 months. This warranty only applies to the original purchaser and is not transferable to a third party.

If the product proves defective during the warranty period, we will either repair the defective product without charge for parts and labour, or will provide a replacement in exchange for the defective product. Parts, modules and replacement products used by our company for warranty work may be new or reconditioned like new. All replaced parts, modules and products become the property of our company.

To obtain service under this warranty, the customer must notify our company of the defect before the expiration of the warranty period. Customer shall be responsible for packaging and shipping the defective product to our designated service centre, a copy of the customer's proof of purchase is also required.

This warranty shall not apply to any defect, failure or damage caused by improper use or improper or inadequate maintenance and care. We shall not be obligated to furnish service under this warranty a) to repair damage resulting from attempts by personnel other than our company representatives to install, repair or service the product; b) to repair damage resulting from improper use or connection to incompatible equipment; c) to repair any damage or malfunction caused by the use of not our supplies; or d) to service a product that has been modified or integrated with other products when the effect of such modification or integration increases the time or difficulty of servicing the product.

Please contact the nearest sales and service offices for services.

**Excepting the after-sales services provided in this summary or the applicable warranty statements, we will not offer any guarantee for maintenance definitely declared or hinted, including but not limited to the implied guarantee for marketability and special-purpose acceptability. We should not take any responsibilities for any indirect, special or consequent damages.**

# Table of Contents

1. General Safety Requirements .....	1
2. Safety Terms and Symbols .....	3
How to conduct a general inspection .....	5
How to conduct function inspection .....	6
3. Primary User Guide .....	7
A general knowledge of the structure of the instrument .....	8
Front Panel .....	8
Rear Panel .....	9
A general knowledge of the user interface of the instrument .....	10
Power Output Inspection .....	11
How to Implement the Probe Compensation .....	12
How to Set the Probe Attenuation Coefficient .....	13
How to Use the Probe Safely .....	14
How to conduct self-calibration .....	14
4. Use the Android System .....	15
Front Panel Android System Area .....	15
5. Use the Oscilloscope .....	17
A general Knowledge of Oscilloscope .....	17
Front Panel Oscilloscope Area .....	17
A general knowledge of vertical system .....	18
A general Knowledge of Horizontal System .....	19
A general knowledge of Trigger System .....	20
How to use touch screen control .....	20
Use the touch screen to operate the menu .....	20
Operate the touch screen .....	22
Operate the touch screen in waveform amplification mode .....	24
Other touch screen operations .....	25
How to conduct automatic measurement .....	28
6. Use Arbitrary Waveform/Function Generator .....	29
Arbitrary waveform/function generator area of front panel .....	29
Display window of arbitrary waveform/function generator .....	29
Setting Window of arbitrary waveform/function generator .....	30
Connect the output end .....	30
Set the channel .....	31
Set the waveform .....	32
Output Built-in Waveform .....	33

Output Modulation Waveform .....	34
Output Sweep Waveform .....	34
Generate Burst .....	35
<b>7. Use the Power Supply .....</b>	<b>36</b>
Power Supply Area on the Front Panel .....	36
Power Display Window .....	36
Power Setting Window .....	37
<b>8. Use the Multimeter .....</b>	<b>38</b>
Multimeter Area on the Front Panel .....	38
Multimeter Zoom Box .....	38
Multimeter Setting Window .....	39
<b>9. Appendix .....</b>	<b>41</b>
Appendix A: Enclosure .....	41
Appendix B: General Care and Cleaning .....	41

# 1.General Safety Requirements

Before use, please read the following safety precautions to avoid any possible bodily injury and to prevent this product or any other connected products from damage. In order to avoid any contingent danger, ensure this product is only used within the range specified.

Only the qualified technicians can implement the maintenance.

To avoid Fire or Personal Injury:

- **Connect the probe correctly.** The grounding end of the probe corresponds to the grounding phase. Please don't connect the grounding end to the positive phase.
- **Use Proper Power Cord.** Use only the power cord supplied with the product and certified to use in your country.
- **Connect or Disconnect Correctly.** When the probe or test lead is connected to a voltage source, please do not connect and disconnect the probe or test lead at random.
- **Product Grounded.** This instrument is grounded through the power cord grounding conductor. To avoid electric shock, the grounding conductor must be grounded. The product must be grounded properly before any connection with its input or output terminal.

**When powered by AC power, it is not allowed to measure AC power source directly, because the testing ground and power cord ground conductor are connected together, otherwise, it will cause short circuit.**

**When powered by battery, the product must ground connection. To avoid electric shock, there must be a ground wire connect between ground and the ground port (on the back of product panel).**

- **Check all Terminal Ratings.** To avoid fire or shock hazard, check all ratings and markers of this product. Refer to the user's manual for more information about ratings before connecting to the instrument.
- **Do not operate without covers.** Do not operate the instrument with covers or panels removed.
- **Use Proper Fuse.** Use only the specified type and rating fuse for this instrument.
- **Avoid exposed circuit.** Do not touch exposed junctions and components when the instrument is powered.
- **Do not operate if in any doubt.** If you suspect damage occurs to the instrument, have it inspected by qualified service personnel before further operations.
- **Use your Oscilloscope in a well-ventilated area.** Make sure the instrument installed with proper ventilation, refer to the user manual for more details.

- **Do not operate in wet conditions.**
- **Do not operate in an explosive atmosphere.**
- **Keep product surfaces clean and dry.**
- When measuring current, turn off the circuit power before connecting the multimeter in the circuit. Remember to place the multimeter in series with the circuit.
- When servicing the multimeter, use only the specified replacement parts.
- Use caution when working above 60 V DC, 30 V AC RMS, or 42.4 V peak. Such voltages pose a shock hazard.
- When using the test leads, keep your fingers behind the finger guards on the test leads.
- Disconnect circuit power and discharge all high-voltage capacitors before testing resistance, continuity, diodes, or capacitance.
- **Use the proper terminals, function, and range for your measurements.** When the range of the value to be measured is unknown, choose the auto ranging mode. To avoid damages to the multimeter, do not exceed the maximum limits of the input values shown in the technical specification tables.
- Connect the common test lead before you connect the live test lead. When you disconnect the leads, disconnect the live test lead first.
- Before changing functions, disconnect the test leads from the circuit under test.

## 2.Safety Terms and Symbols

### Safety Terms

**Terms in this manual.** The following terms may appear in this manual:



**Warning:** Warning indicates the conditions or practices that could result in injury or loss of life.



**Caution:** Caution indicates the conditions or practices that could result in damage to this product or other property.

**Terms on the product.** The following terms may appear on this product:









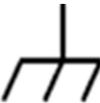

**Danger:** It indicates an injury or hazard may immediately happen.

**Warning:** It indicates an injury or hazard may be accessible potentially.

**Caution:** It indicates a potential damage to the instrument or other property might occur.

### Safety Symbols

**Symbols on the product.** The following symbol may appear on the product:

	Hazardous Voltage		Protective Earth Terminal
	Chassis Ground		Test Ground
	Direct current (DC)		Fuse
	Alternating current (AC)		Caution, risk of danger (refer to this manual for specific Warning or Caution information)
	Both direct and alternating current	<b>CAT II</b>	Category II overvoltage protection
	Conforms to European Union directives	<b>CAT III</b>	Category III overvoltage protection
	Equipment protected throughout by double insulation or reinforced insulation	<b>CAT IV</b>	Category IV overvoltage protection



To avoid body damage and prevent product and connected equipment damage, carefully read the following safety information before using the test tool. This product can only be used in the specified applications.

 **Warning:**

The two channels of the oscilloscope are not electrically isolated. The channels should adopt a common ground during measuring. To prevent short circuits, the 2 probe grounds must not be connected to 2 different non-isolated DC levels.

 **Warning:**

Note when measuring the channel to the public base, otherwise may cause short circuit because of the oscilloscope probe ground wire.

The diagram of the oscilloscope ground wire connection:

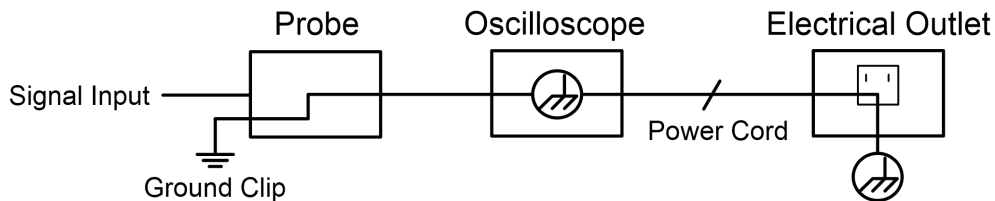

The diagram of the ground wire connection when the battery-powered oscilloscope is connected to the AC-powered PC through the ports:

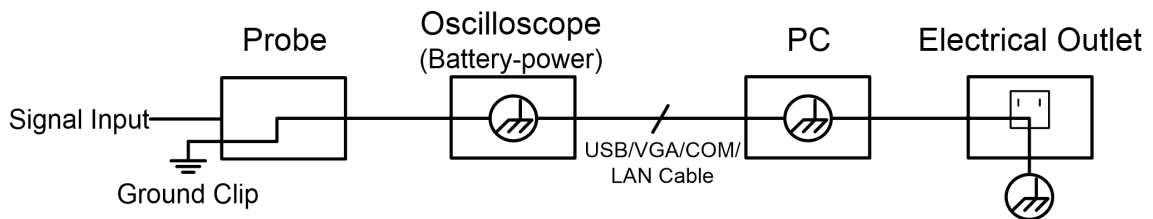

It is not allowed to measure AC power when the oscilloscope is AC powered, or when the battery-powered oscilloscope is connected to the AC-powered PC through the ports.



### **Warning:**

**To avoid fire or electrical shock, when the oscilloscope input signal connected is more than 42V peak (30Vrms) or on circuits of more than 4800VA, please take note of below items:**

- **Only use accessory insulated voltage probes and test lead.**
- **Check the accessories such as probe before use and replace it if there are any damages.**
- **Remove probes, test leads and other accessories immediately after use.**
- **Remove USB cable which connects oscilloscope and computer.**
- **Do not apply input voltages above the rating of the instrument because the probe tip voltage will directly transmit to the oscilloscope. Use with caution when the probe is set as 1:1.**
- **Do not use exposed metal BNC or banana plug connectors.**
- **Do not insert metal objects into connectors.**

## **How to conduct a general inspection**

After you get a new device, it is recommended that you should make a check on the instrument according to the following steps:

### **1. Check whether there is any damage caused by transportation.**

If it is found that the packaging carton or the foamed plastic protection cushion has suffered serious damage, do not throw it away first till the complete device and its accessories succeed in the electrical and mechanical property tests.

### **2. Check the Accessories**

The supplied accessories have been already described in the "Appendix A: Enclosure" of this Manual. You can check whether there is any loss of accessories with reference to this description. If it is found that there is any accessory lost or damaged, please get in touch with our distributor responsible for this service or our local offices.

### **3. Check the Complete Instrument**

If it is found that there is damage to the appearance of the instrument, or the instrument can not work normally, or fails in the performance test, please get in touch with our distributor responsible for this business or our

local offices. If there is damage to the instrument caused by the transportation, please keep the package. With the transportation department or our distributor responsible for this business informed about it, a repairing or replacement of the instrument will be arranged by us.

### **How to conduct function inspection**

Conduct a quick function inspection to confirm if the instrument is running in normal state.

#### **Power-on Inspection**

**To power on the instrument, long press  in the lower left of the host.**

The instrument screen shows the startup screen, will display Android screen and wait a few seconds, the relay in the host will make a slight click sound. After performing all self-inspection items on the instrument, the instrument will directly enter instrument system.

## **3.Primary User Guide**

**This chapter elaborates the following topics:**

- **A general knowledge of the structure of the instrument**
- **A general knowledge of the user interface of the instrument**
- **How to conduct probe compensation**
- **How to set the probe attenuation coefficient**
- **How to use the probe safely**
- **How to conduct self-calibration**

## A general knowledge of the structure of the instrument

This chapter gives a brief description and introduction to the operations and functions of the front panel of the instrument, so as to facilitate your operations of the instrument in the shortest time.

### Front Panel

On the instrument panel, knobs and function buttons are used to set different options for current menu, and other buttons are used to enter different function menus or directly obtain specific function application.

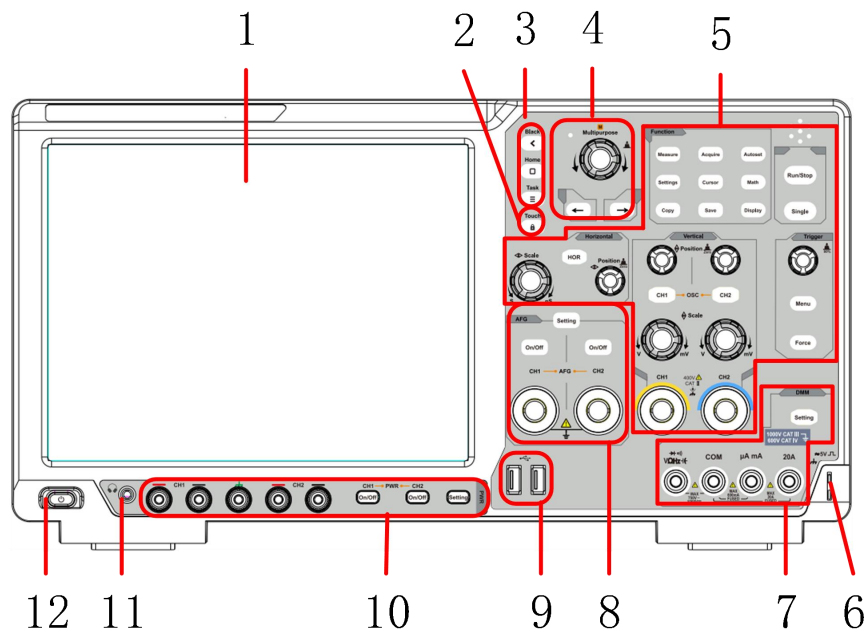

Figure 3- 1 Front panel

1. Display area.
2. Touch key.
3. Android function keys.
4. General knob and arrow keys.
5. Oscilloscope key and knob control area.
6. Probe compensation: 5V/1kHz signal output.
7. Multimeter keys and port control area.
8. Signal generator key and port control area.
9. **USB Host** Interface: When the oscilloscope is connected to an external USB device as a “master device”, the USB Host interface is used to transmit the data.
10. Power key and output port control area.
11. Headphone socket.
12. Instrument switch with memory (self-lock) switch and auto memory of last shutdown; if the instrument is shut down by powering the supply off, there is no need to press the switch to start it up after next power-on; if the instrument is shut down by pressing the switch key, it is required to press

the switch key again to power it on.

## Rear Panel

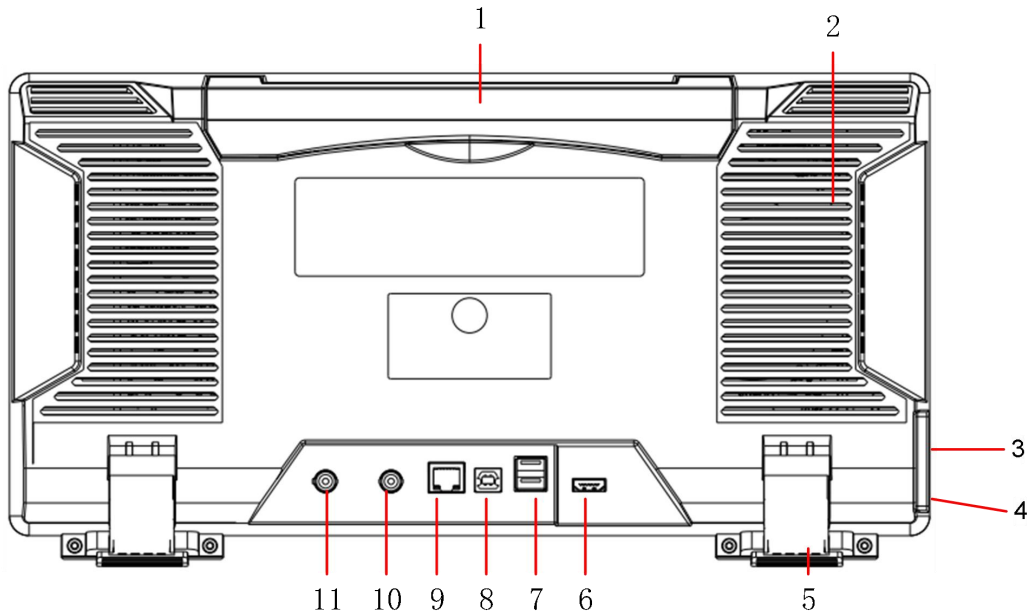

Figure 3-2: Rear Panel

1. **Foldable Handle.**
2. **Heat Emission Hole.**
3. **Power Outlet.**
4. **Fuse .**
5. **Foot Rest:** To adjust the inclined angle of the oscilloscope.
6. **HDMI Interface:** To connect HDMI output to the external monitor or projector.
7. **USB Host Interface:** When the oscilloscope is connected to an external USB device as a “master device”, the USB Host interface is used to transmit the data.
8. **USB Device Interface:** When the oscilloscope is connected to an external USB device as a “slave device”, the USB Device interface is used to transmit the data. For example, use the interface to connect a PC or printer.
9. **LAN Interface:** The network interface to connect a PC or router.
10. **External Trigger Input Interface (EXT Trig In).**
11. **Trig Out (P/F) Interface:** Trigger output or pass/fail output port.

## A general knowledge of the user interface of the instrument

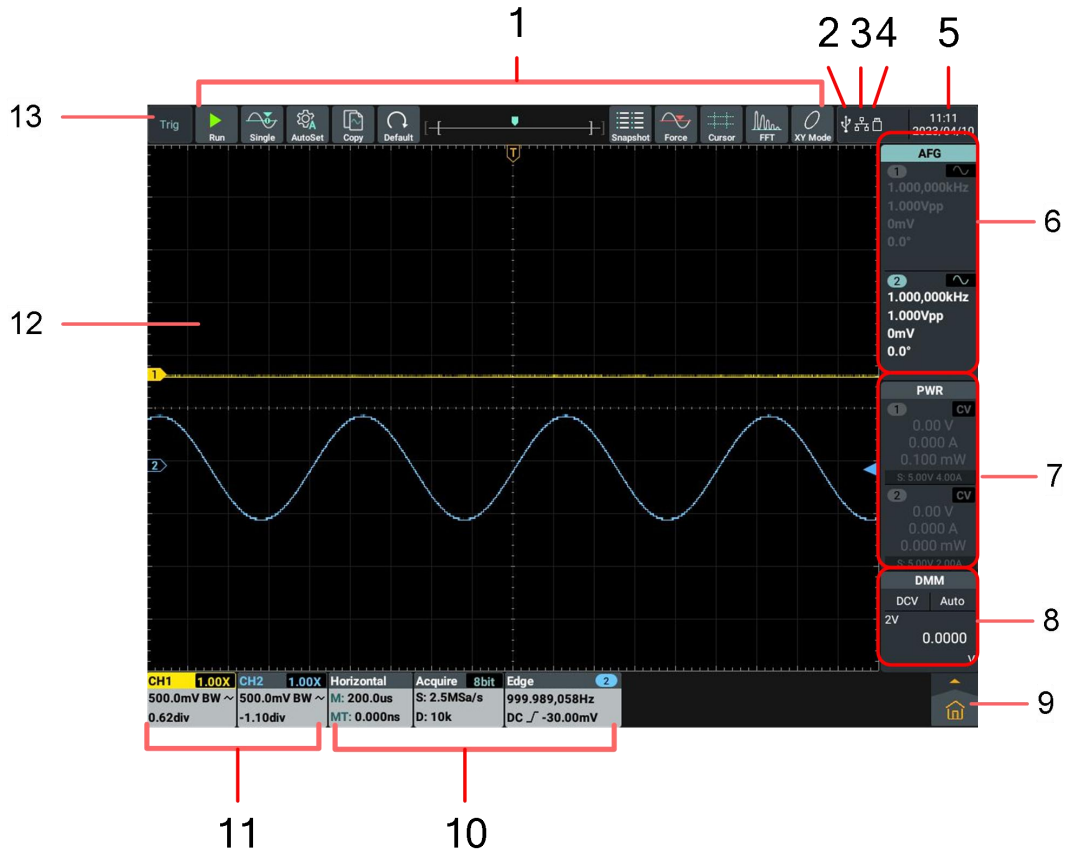



Figure 3-3: Illustrative Drawing of Display Interfaces

1. Shortcut soft keys of oscilloscope functions.
2. It indicates that a USB Device cable is inserted currently.
3. It indicates that a network cable is connected, that is, the LAN port is accessed (If icon for the  , it indicates the Wi-Fi is enabled and connected currently).
4. It indicates that a USB flash drive is inserted currently.
5. Display the system set time.
6. Display window of signal generator.
7. Power display window.
8. Multimeter display window.
9. Main menu, click to pop up the oscilloscope and general function menu window.
10. Information display bar of oscilloscope horizontal, acquire and trigger functions.
11. Information display bar of oscilloscope channel.
12. Waveform display area.

13. Display current operating status.

## Oscilloscope Inspection

1. **Set the Switch in the Oscilloscope Probe as 10X and Connect the Oscilloscope with CH1 Channel.**

Align the slot in the probe with the plug in the CH1 connector BNC, and then tighten the probe with rotating it to the right side.

Connect the probe tip and the ground clamp to the connector of the probe compensator.

2. **Push the Autoset Button at the top left of the screen or on the front panel.**

The square wave of 1 kHz frequency and 5V peak-peak value will be displayed in several seconds (see Figure 3-4).

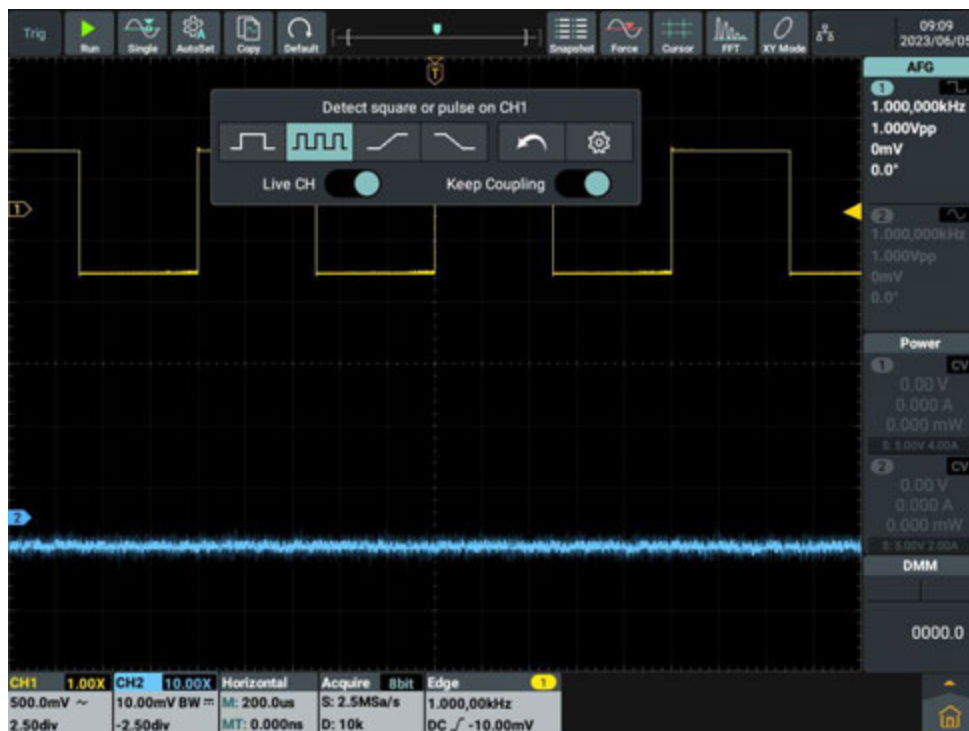

Figure 3-4: Auto set

Check CH2 by repeating Step 2 and Step 3.

## Power Output Inspection

Output inspection is to ensure that the instrument can achieve its rated outputs and properly respond to operation from the front panel.

1. **Voltage Output Inspection**



- (1) When the instrument is under no load, select a channel and ensure the output current setting for this channel is not at zero.
- (2) Turn on the channel output, then ensure the channel is in Constant Voltage output mode.
- (3) Set some different voltage values on this channel; check if the actual voltage value displayed is close to the set voltage value, and also that the actual current value displayed is nearly to zero.
- (4) Check CH1 and CH2 channel if the output voltage can be adjusted from 0.1V to the maximum rating.

## 2. Current Output Inspection

The following steps check basic current functions with a short across the power supply's output:

- (1) Power on.
- (2) Connect a short across (+) and (-) output terminals with an insulated test lead on this channel. Use a wire size sufficient to handle the maximum current.
- (3) Set the output voltage to the maximum rating on this channel.
- (4) Turn on the channel output. Ensure the channel you used is in Constant Current output mode.
- (5) Set some different current values on this channel; check if the actual current value displayed is close to the set current value, and to check if the actual voltage value displayed is nearly zero.
- (6) Check CH1 and CH2 channel if the output current can be adjusted from zero to the maximum rating, When it is set to the maximum or minimum, a beep is heard, indicating that the limit has been reached..
- (7) Turn off the channel output and remove the short circuit from the output terminals.

## How to Implement the Probe Compensation

When connect the probe with any input channel for the first time, make this adjustment to match the probe with the input channel. The probe which is not compensated or presents a compensation deviation will result in the measuring error or mistake. For adjusting the probe compensation, please carry out the following steps:

1. Set the attenuation coefficient of the probe in the menu as 10X and that of the switch in the probe as 10X (see "*How to Set the Probe Attenuation Coefficient*" on P13), and connect the probe with the CH1 channel. If a probe hook tip is used, ensure that it keeps in close touch with the probe.

Connect the probe tip with the signal connector of the probe compensator and connect the reference wire clamp with the ground wire connector of the probe connector, and then push the **Autoset** button on the front panel.

2. Check the displayed waveforms and regulate the probe till a correct compensation is achieved (see Figure 3-5 and Figure 3-6).

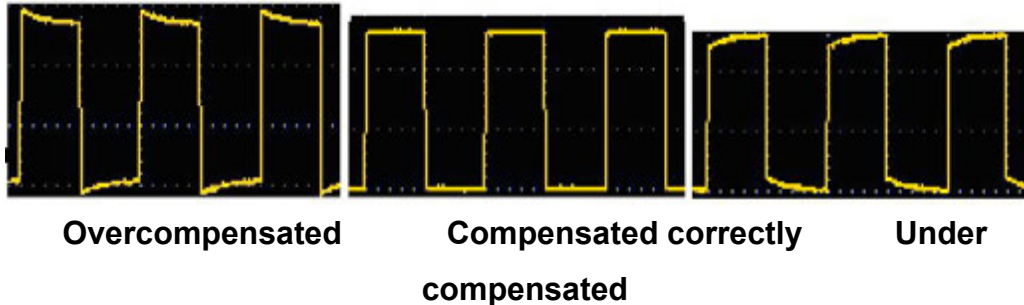

Figure 3-5 Displayed Waveforms of the Probe Compensation

3. Repeat the steps mentioned if needed.

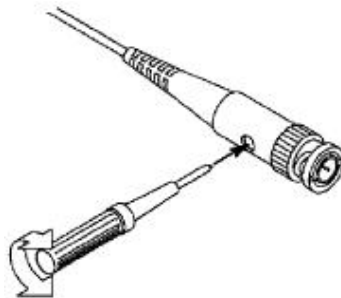

Figure 3-6 Adjust Probe

## How to Set the Probe Attenuation Coefficient

The probe has several attenuation coefficients, which will influence the vertical scale factor of the oscilloscope.

To change or check the probe attenuation coefficient in the menu of oscilloscope:

- (1) Push the function menu button of the used channels(**CH1** channel or **CH2** channel).
- (2) Select **Probe Attenu** (**1X** , **10X** or other custom probe magnifications) in the displayed channel setting window. The setting will remain in effect until changed again after selection

This setting will be valid all the time before it is changed again.



**Caution:**

The default attenuation coefficient of the probe on the instrument is preset to 10X.

Make sure that the set value of the attenuation switch in the probe is the same as the menu selection of the probe attenuation coefficient in the oscilloscope.

---

The set values of the probe switch are 1X and 10X (see *Figure 3-7*).

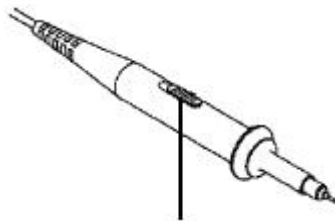

Figure 3-7 Attenuation Switch



**Caution:**

When the attenuation switch is set to 1X, the probe will limit the bandwidth of the oscilloscope in 5MHz. To use the full bandwidth of the oscilloscope, the switch must be set to 10X.

---

## How to Use the Probe Safely

The safety guard ring around the probe body protects your finger against any electric shock, shown as *Figure 3-8*.

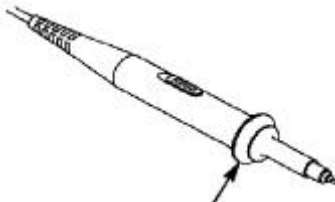

Figure 3-8 Finger Guard



**Warning:**

To avoid electric shock, always keep your finger behind the safety guard ring of the probe during the operation.

To protect you from suffering from the electric shock, do not touch any metal part of the probe tip when it is connected to the power supply.

Before making any measurements, always connect the probe to the instrument and connect the ground terminal to the earth.

---

## How to conduct self-calibration

Self-calibration program is used to quickly make the oscilloscope be in the optimum condition to obtain the most accurate measurement. This program can be performed at any time. It is especially necessary when the ambient

temperature reaches or exceeds 5°C.

To conduct self-calibration, disconnect all probes and wires from the input connector. Then, press **Settings** key at the oscilloscope area of the front panel or click “🏠” in the lower right of the screen, select **Oscilloscope** from the right menu and **Self-calibration** from the menu displayed, and click **Start** in the self-calibration display box.

## 4.Use the Android System

### Front Panel Android System Area

Four keys are contained at the front panel area of the instrument. They are **Back**, **Home**, **Task** and **Touch**.

**Note:** The Touch Lock is only available in EduInstr system and does not work on the main homepage and other application interface.



### Android System Homepage Window

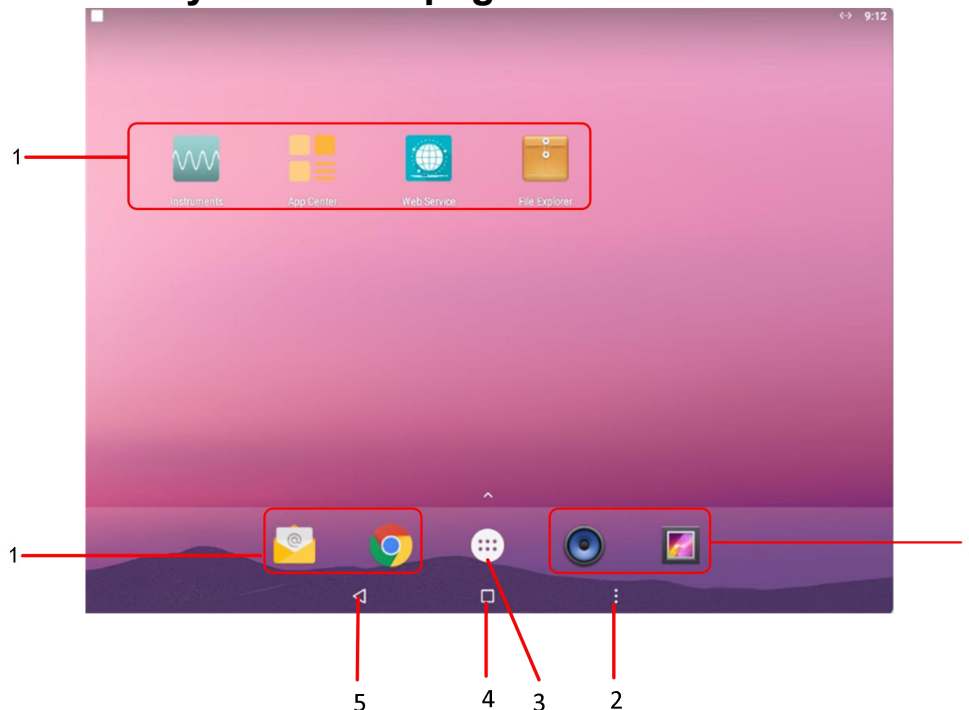

1. Application shortcut key
2. Task key
3. App Drawer (Click to see all apps)
4. Home key
5. Back key

### System built-in application list

Open the application drawer of the main page. There are 17 built-in applications in the system, including: App Center, Calculator, Calendar, Chrome, Browser, Clock, Email, File Explorer, Gallery, Instruments, Music, Pydroid3, Screen Recorder, Settings, Sound Recorder, USB Camera, Web Service and WPS Office, as illustrated in the figure below:

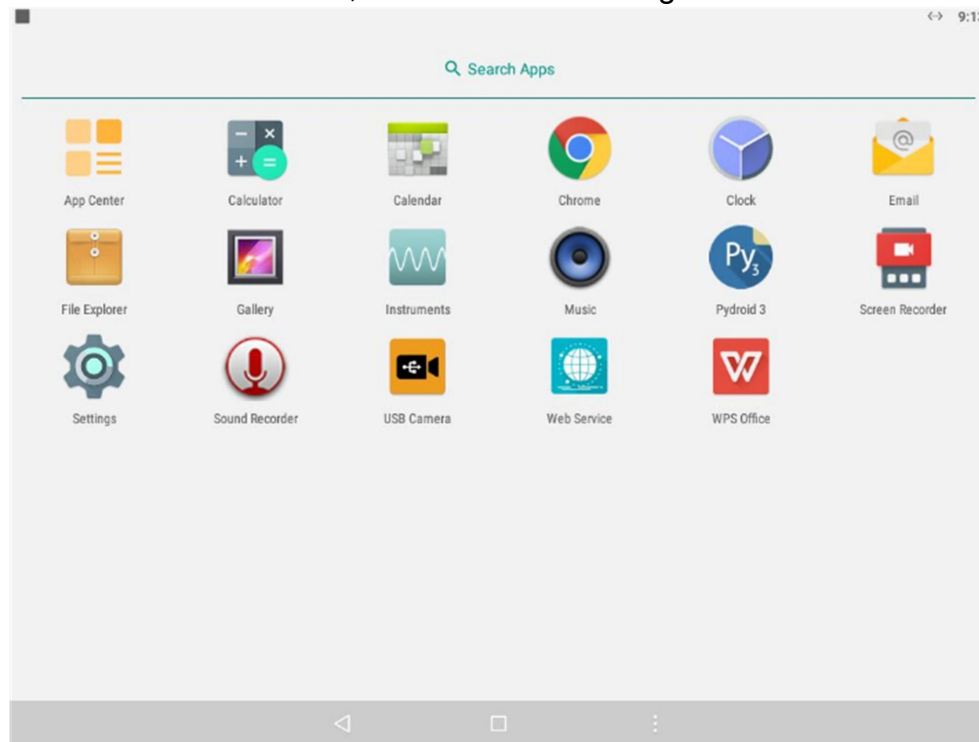

## 5. Use the Oscilloscope

### A general Knowledge of Oscilloscope

#### Front Panel Oscilloscope Area

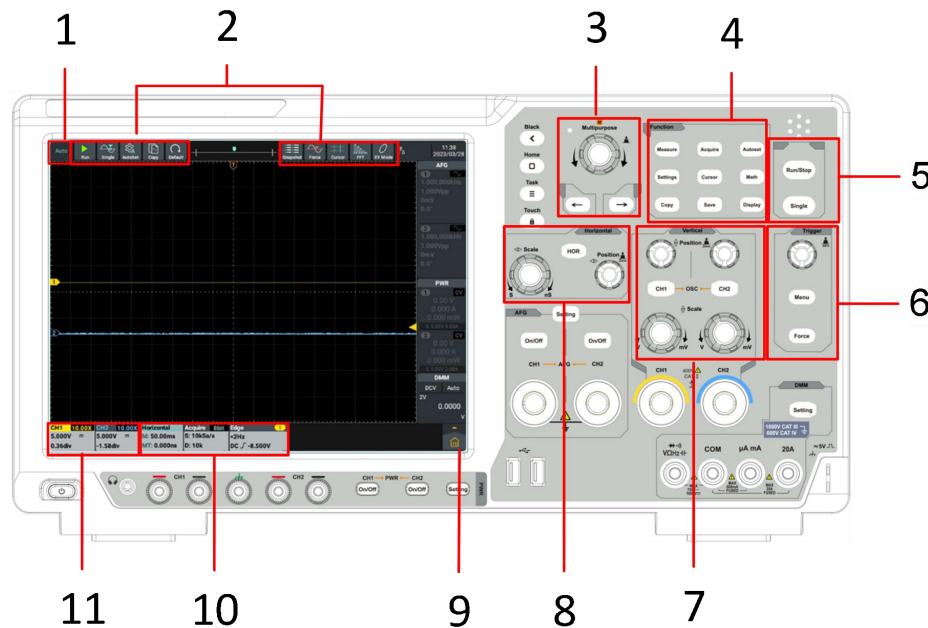

#### Instructions:

1. Trigger state.
2. Oscilloscope function shortcut keys.
3. General knob and arrow keys.  
**General knob:** When **M** appears in the screen menu, it indicates that the **General** knob can be turned to select current menu or set the value.  
**Arrow keys:** Move to select the parameter.
4. **Function key area:** There are 9 keys in total.
5. **Shortcut key:** Run/Stop, Signal.
6. **Trigger control area:**  
 Contain two keys and one knob.  
 "Trigger Level" knob is to adjust the trigger level.  
 Menu button correspond to the settings of the trigger system;  
 Force button is the forced trigger shortcut button.
7. **Vertical control area:**  
 Contain two keys and four knobs.  
 In the oscilloscope state, the "CH1" key and "CH2" key correspond to the channel switch of Channel 1 and Channel 2, respectively. Two "Vertical Displacement" knobs are to control the vertical displacement of Channel 1 and Channel 2, respectively. And two "Gear" knobs are used to control the voltage of Channel 1 and Channel 2, respectively

8. **Horizontal control area:**

Contain one key and two knobs.



In the oscilloscope state, the “Horizontal Menu” key corresponds to the setup menu of the horizontal system, the “Horizontal Displacement” knob is to control the horizontal displacement triggered, when pressing the knob horizontal displacement can be zero and the “Gear” knob is used to control the time base gear.

9. Main menu button: Click to display/hide the main menu, including the oscilloscope and general function menu list.

10. Oscilloscope function information box: Display horizontal, acquisition, and trigger information content separately. Click to display/hide corresponding function setting window.

11. Vertical channel information box: Display the configuration information content of channel 1 and channel 2 respectively. The information content includes: channel switch, voltage gear, zero position, bandwidth limit, etc. In the display content, BW indicates that the bandwidth limit is 20MHz.

The icon indicates the coupling mode of the channel:

- “” indicates DC coupling
- “” indicates AC coupling
- “” indicates ground coupling

## A general knowledge of vertical system

As shown in Figure 5-1, there are two buttons and four knobs in the Vertical Control Area. The following exercises are to guide you through the use of the vertical settings.

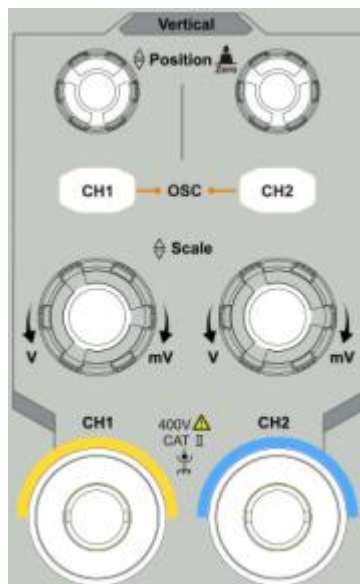

Figure 5- 1: Vertical Control Area

1. Press the **Vertical Displacement** knob to center display the signal in the waveform window. It is used to control the vertical display position of the signal. When turning the **Vertical Displacement** knob, the pointer

indicating the **Grounding Reference Point** of the channel moves up and down following the waveform. When press the **Vertical Displacement** button, the vertical displacement can be zero.

### Measuring Skills

If the DC coupling mode is adopted for the channel, observe the gap between the waveform and the signal ground to quickly measure the DC component of the signal.

If the AC coupling mode is adopted for the channel, the DC component of the signal is filtered out, facilitating you to display the AC component of the signal with higher sensitivity.

2. Change the vertical settings and observe the resulting status change. You can determine the change of the vertical gear factor of any channel through the information displayed in the status bar at the lower part of the waveform window.
  - Turn the **Vertical Gear** knob to change the **Vertical Gear Factor (Voltage Gear)**, and the gear factor of corresponding channel in the status bar changes accordingly.
3. Press the **CH1** and **CH2** key to enable or disenable corresponding channel.

## A general Knowledge of Horizontal System

As shown in Figure 5-2, there is a key and two knobs in the **Horizontal Control Area**. The following exercises are to guide you through the use of the horizontal time base settings.

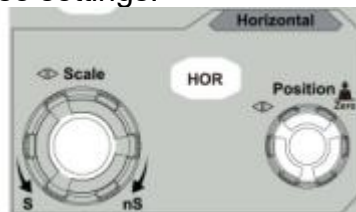

Figure 5- 2:Horizontal Control Area

1. Turn the **Horizontal Gear** knob to change the settings of the horizontal time base and thus observe the resulting change of the status information, then the corresponding **Horizontal Time Base** in the status bar changes accordingly.
 

Press the **Horizontal Gear** knob enter or exit waveform amplification mode.
2. Turn the **Horizontal Displacement** knob to adjust the horizontal displacement of the signal in the waveform window.
3. The **Horizontal Displacement** knob is to control the triggered horizontal displacement of the signal; when turning the knob, the waveform moves horizontally with the knob. When press the **Horizontal Displacement** button, the horizontal displacement can be zero.
4. Press the **HOR** key to pop up the horizontal Settings window.



## A general knowledge of Trigger System

As shown in Figure 5-3, there is a knob and two keys in the **Trigger Control Area**. The following exercises are to guide you through the settings of the trigger system.



Figure 5-3: Trigger Control Area

1. Press the **Trigger Menu** key to call the trigger menu, and operate the menu displayed to change the trigger settings.
2. Use **Trigger Level** knob to change the settings of the trigger level.  
Turn the **Trigger Level** knob, the trigger pointer on the screen moves up and down as the knob turns. While moving the trigger pointer, the value of the trigger level on the screen changes accordingly.  
**Note:** Turning the **Trigger Level** knob can not only change the trigger level value, but also set the shortcut key of the trigger level at the vertical midpoint of the trigger signal amplitude.
3. Press **Forced Trigger** key to generate a trigger signal forcibly, mainly used in the “Normal” and “Single” trigger mode.

## How to use touch screen control

The touch screen can be used to control the oscilloscope by various gestures.

Operate the touch screen when the light of the touch lock in the upper left of the front panel is off; click the key to light up the indicator; the touch function is disabled when the touch lock is in locked state.

The instructions of the touch screen operations are as follows, the contents in the parentheses indicate the key or knob that plays the same role.

### Use the touch screen to operate the menu

- **Open the Settings window function:** Directly click menu items in the lower menu bar or the right menu bar of the display area to pop up the setting window of the corresponding function.
- **Set Menu Item:** In the Settings window, you can change the configuration of the relevant menu item by touching it. The types of operable parts include: switch, button, radio, gear hobbing (scrolling list), etc. The

following box selects the radio type, click directly to switch the options.

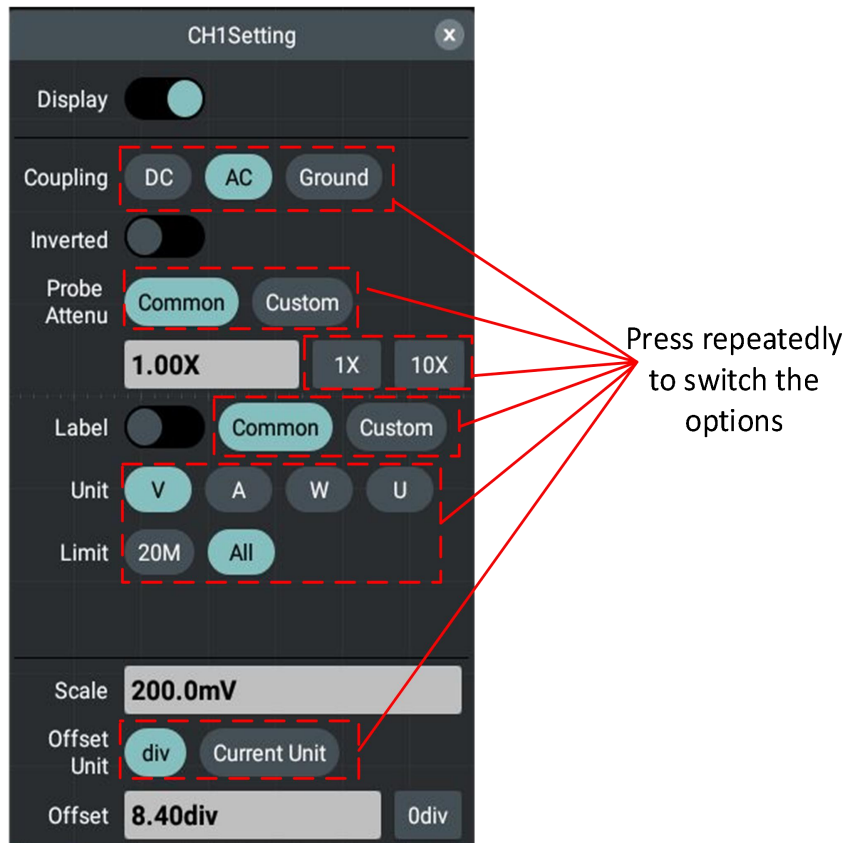

- **Scroll List:** When the scroll bar appears in the menu or file system window, swipe the screen up and down with the finger to scroll the list, as shown in the figure below.



- **Open Main Menu:** Click the  icon in the lower right of the display area, the main menu window pops up, as shown below, with each item corresponding to the keys with the same name on the panel or the shortcut keys at the upper part of the screen. Clicking the item is equivalent to pressing the corresponding key on the panel or the shortcut key at the upper part of the screen.

## 5. Use the Oscilloscope



### Operate the touch screen

- **Select a Channel (CH1 channel or CH2 channel):** Click the channel pointer at the left side or the channel waveform to select the channel point.
- **Set the vertical position of the selected channel waveform (Vertical Displacement knob):** Waveform area on the right side of two for trigger level touch mobile area, slide up and down in the area can change the trigger level, as shown in the figure below.

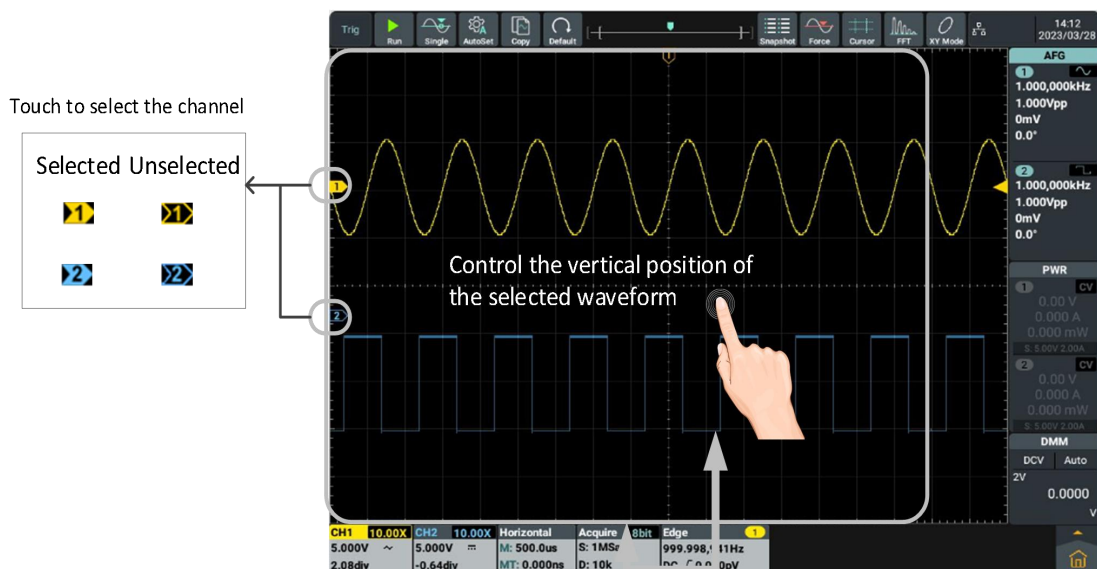

- **Set the trigger level of the signal source in the Trigger Menu (Trigger Level knob):** Swipe the screen up and down with the finger near the trigger area two squares to the right side, as shown in the figure below.

## 5. Use the Oscilloscope

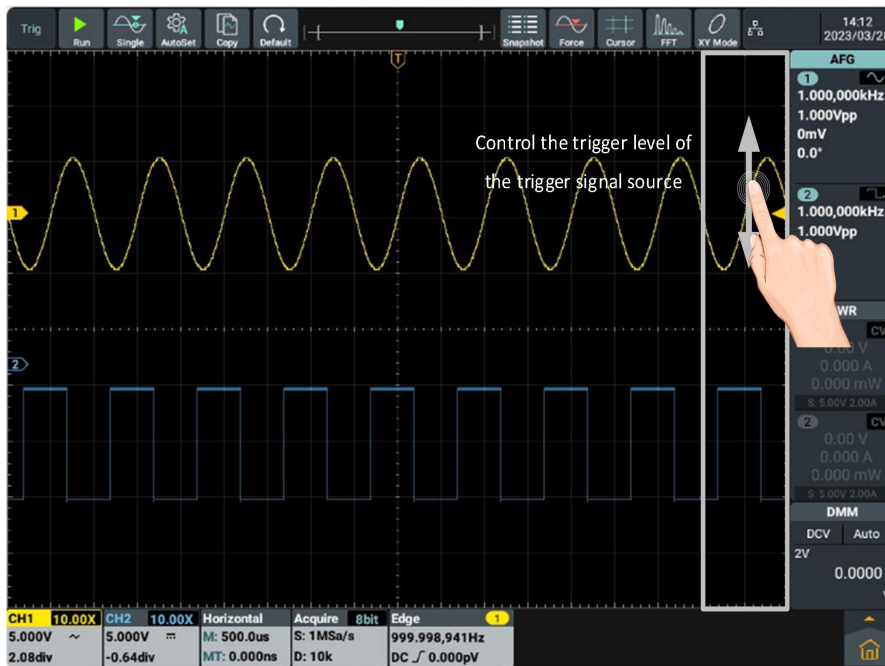

- Set **Horizontal Position (Horizontal Displacement knob)**: Swipe the screen left and right with the finger in the waveform display area, as shown in the figure below.

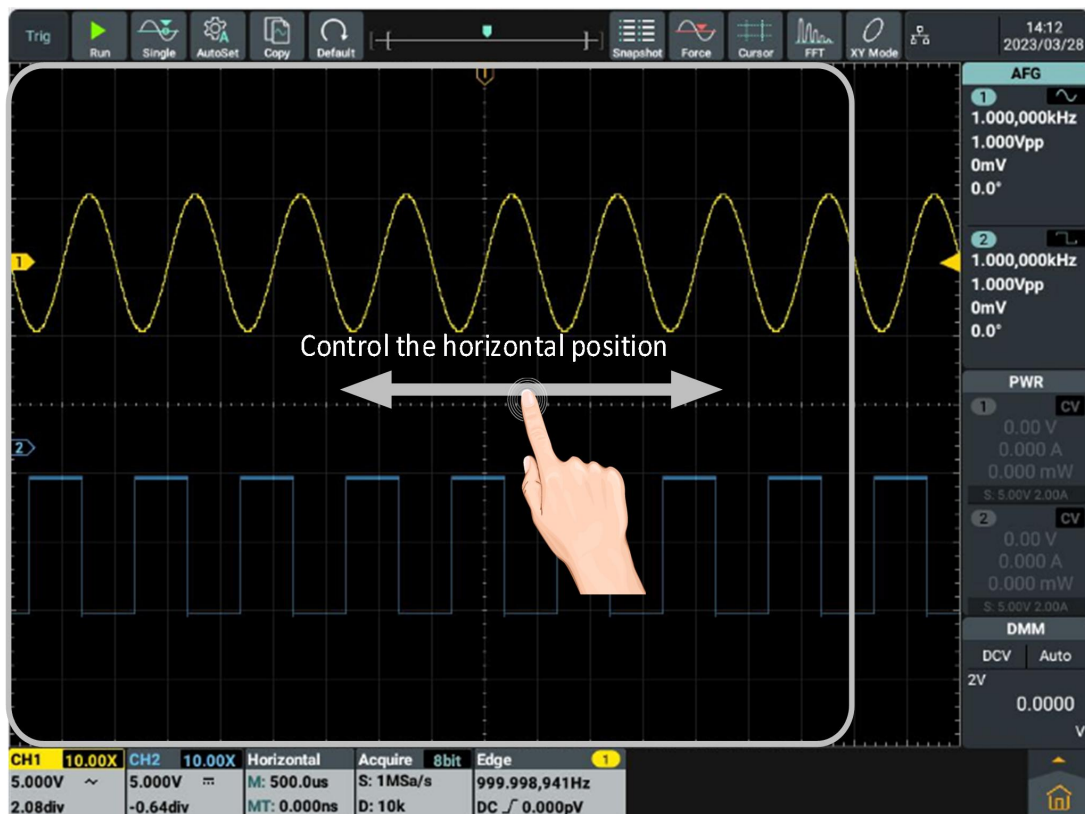

- Control the voltage gear and time base by pinch action: Pinch the thumb and the index finger up and down/left and right in the waveform display area, as shown in the figure below.

## 5. Use the Oscilloscope

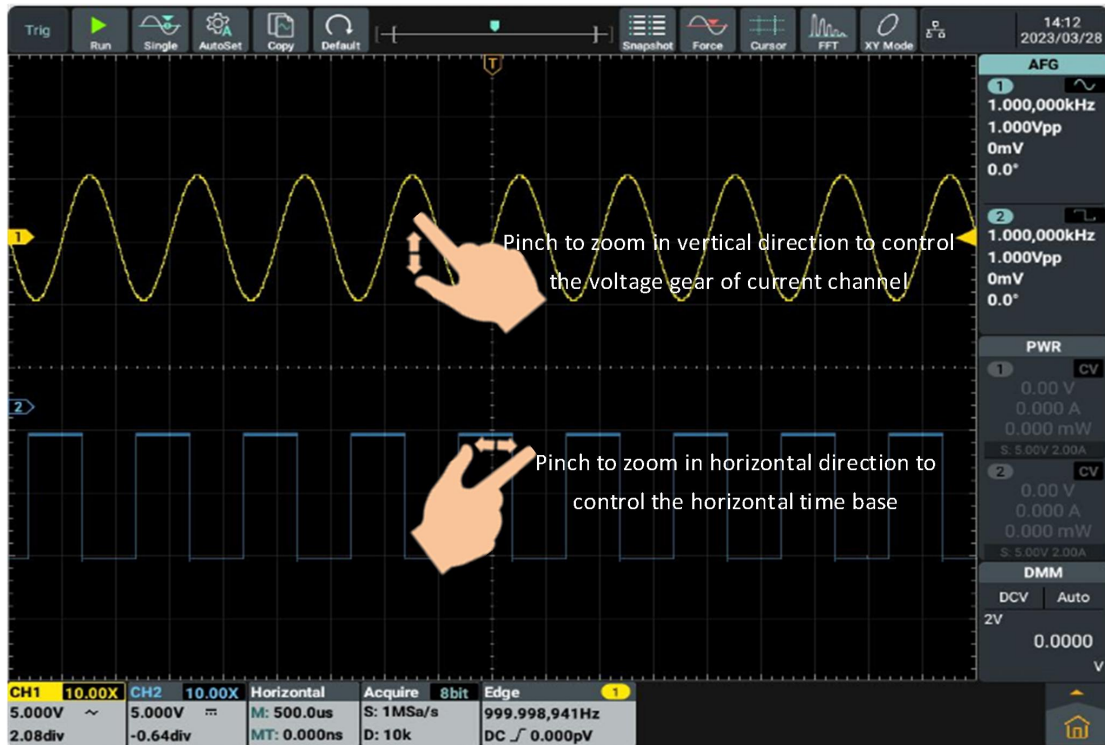

### Operate the touch screen in waveform amplification mode

Press **Horizontal Gear Knob** to enter the waveform amplification mode, the main window is displayed at the top half of the screen and the amplified window is displayed at the bottom half of the screen. The amplified window is the amplified part of the main window that is selected.

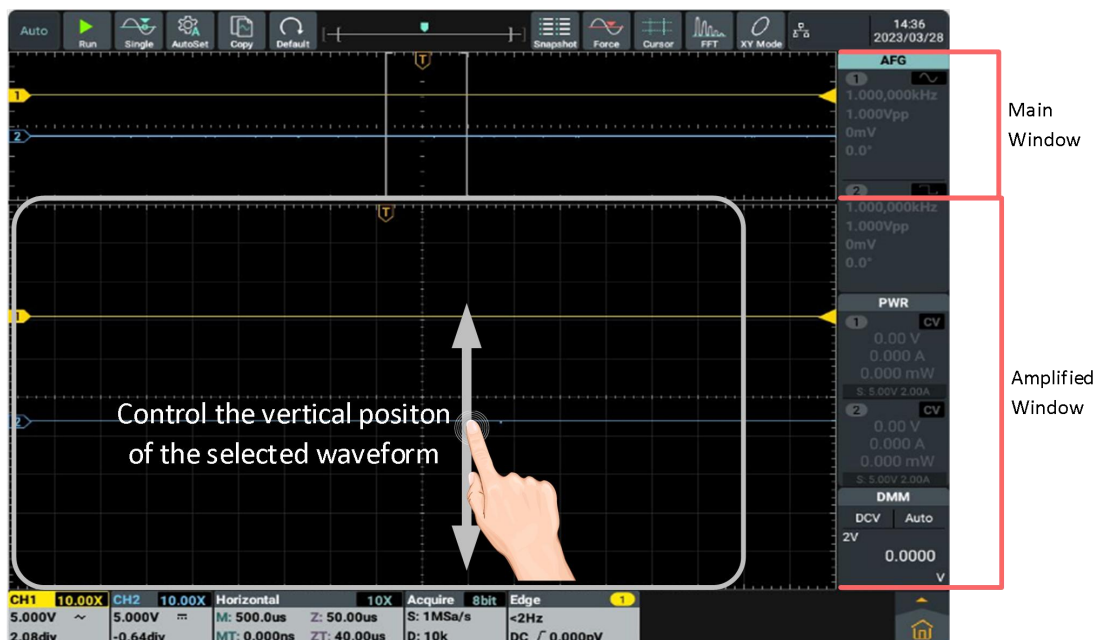

## 5. Use the Oscilloscope

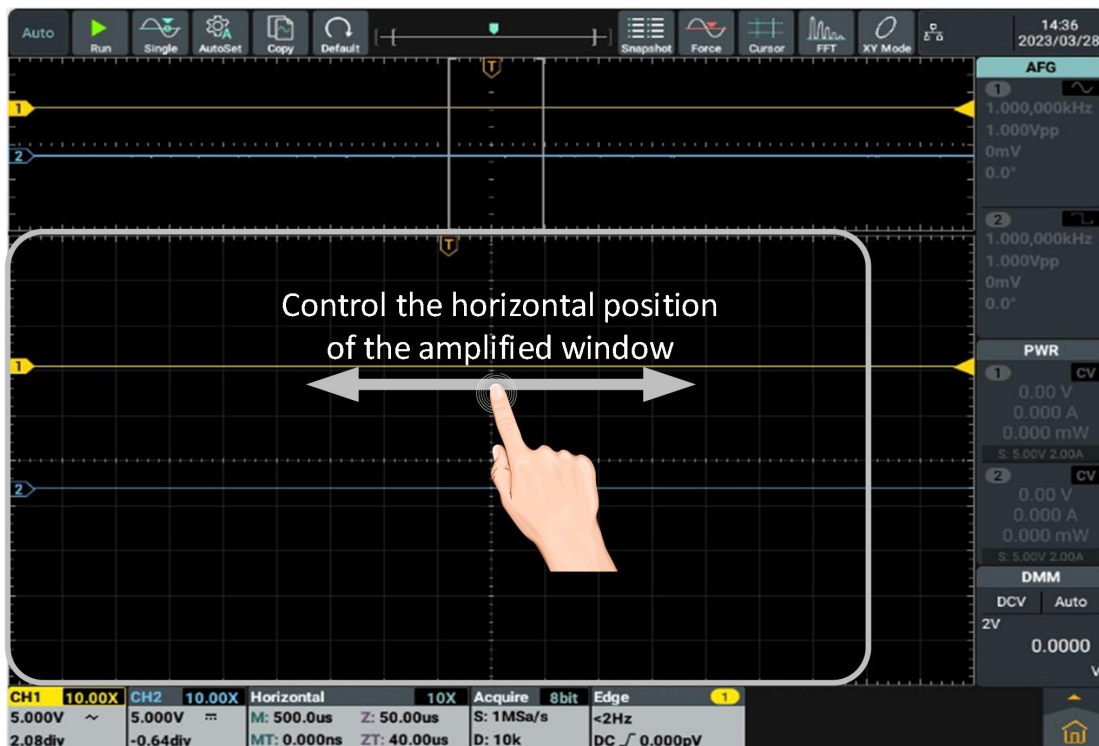
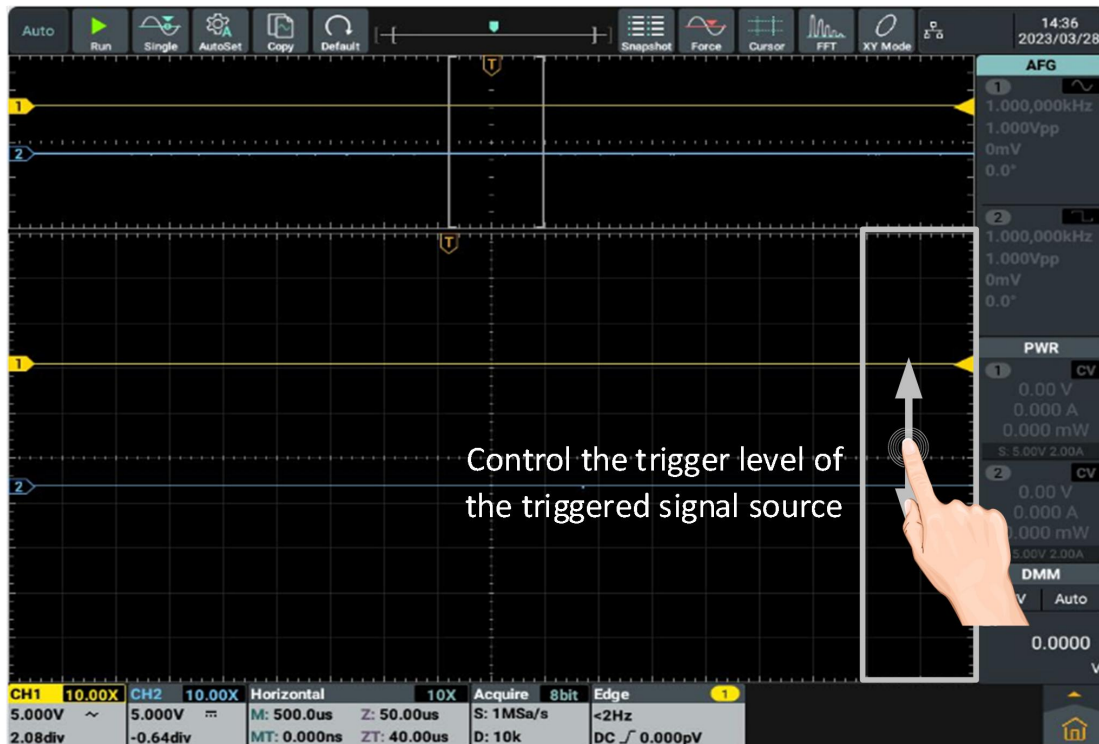



### Other touch screen operations

- Click and drag the open menu item to move itself to the appropriate location.
- Control the horizontal or vertical cursor lines under cursor measurement:

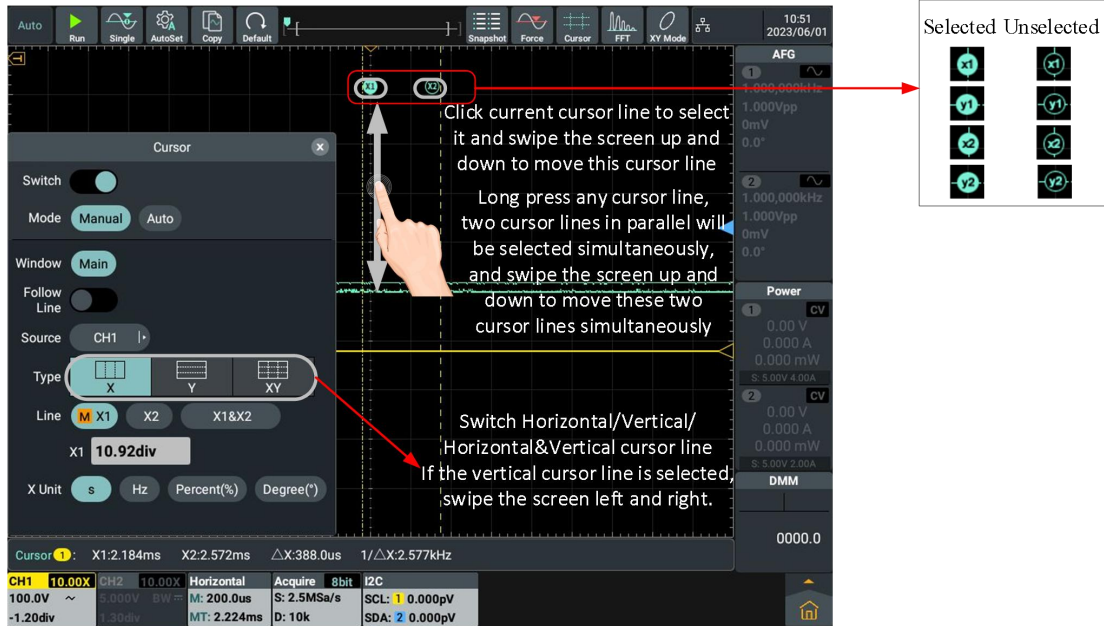
## 5. Use the Oscilloscope



- **Run/Stop:** Click  or  in the upper left of the display area to switch Run/Stop.
- **Parameter Setting Keyboard in Menu Item:** There are digital input mode and gear input mode.

Digital input mode: Click to input.

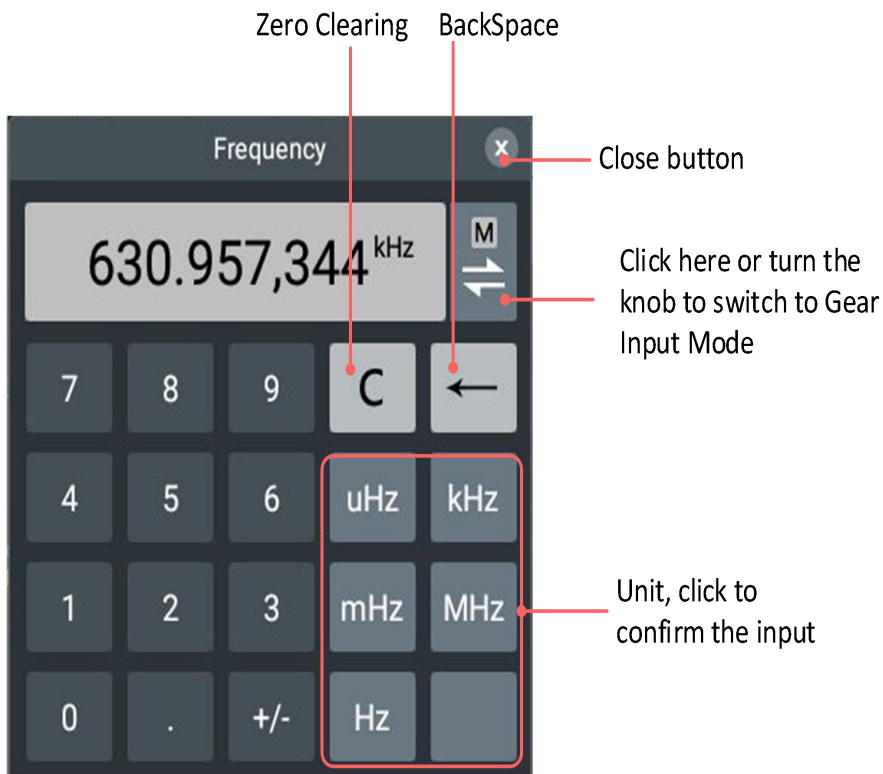

Gear input mode, as shown in the figure below:

## 5. Use the Oscilloscope

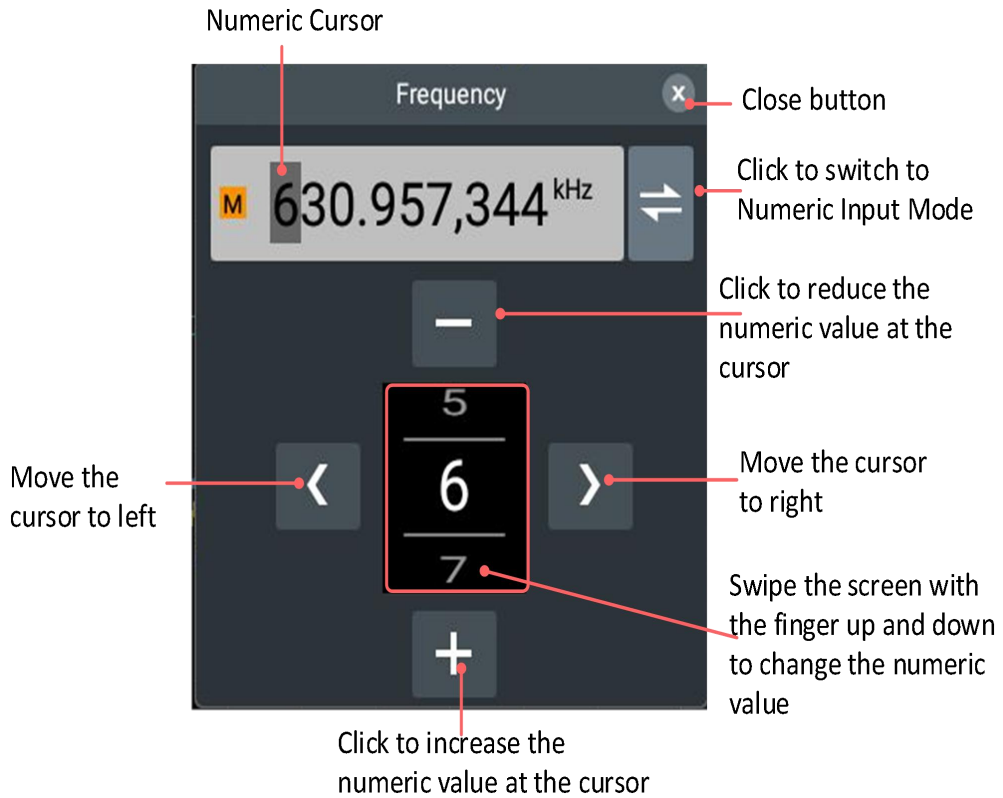



## How to conduct automatic measurement

Push the **Measure** button to display the menu for the settings of the Automatic Measurements. At most 8 types of measurements could be displayed on the bottom left of the screen.

The oscilloscopes provide 43 parameters for auto measurement, including Period, Period, Frequency, + Width, - Width, Rise Time, Fall Time, Positive Duty Ratio, Negative Duty Ratio, Screen Pulse Width Ratio, Average Value, Peak-to-Peak Value, Root-mean-square Value, Maximum Value, Minimum Value, Top Value, Bottom Value, Amplitude, Pre-shoot, Over-shoot, Cycle Root-mean-square Value, Standard deviation, Number of Positive Pulse, Number of Negative Pulse, Number of Rising Edge, Number of Falling Edge, Area, Cycle Area, Delayed (1  $\mu$ -2  $\mu$ ), Delayed (1  $\mu$ -2  $\mu$ ), Delayed (1  $\mu$ -2  $\mu$ ), Delayed (1  $\mu$ -2  $\mu$ ), Phase Position (1  $\mu$ -2  $\mu$ ), Phase Position (1  $\mu$ -2  $\mu$ ), Phase Position (1  $\mu$ -2  $\mu$ ), Phase Position (1  $\mu$ -2  $\mu$ ), FRR (1  $\mu$ -2  $\mu$ ), FRF (1  $\mu$ -2  $\mu$ ), FFR (1  $\mu$ -2  $\mu$ ), FFF (1  $\mu$ -2  $\mu$ ), LRR (1  $\mu$ -2  $\mu$ ), LRF (1  $\mu$ -2  $\mu$ ), LFR (1  $\mu$ -2  $\mu$ ), LFF (1  $\mu$ -2  $\mu$ ).

The waveform channel must be opened for measurement. The automatic measurement can not be performed in the following situation: 1) On the saved waveform. 2) On the Dual Wfm Math waveform.

**For example:** To measure the cycle and frequency of CH1 channel signal, operate according to the following steps:

1. Press **Measure** key and the automatic measurement menu is displayed on the screen.
2. Click the Switch to On state and the circle is highlighted.
3. Click Signal Source **CH1** to highlight it.
4. Click **Cycle** and **Frequency** in the horizontal measurement, and the circle is checked and highlighted.

The measured values will be automatically displayed at the lower left of the screen.

## 6.Use Arbitrary Waveform/Function Generator

### Arbitrary waveform/function generator area of front panel

Signal Source Display window, click to display /

hide the signal source setting window

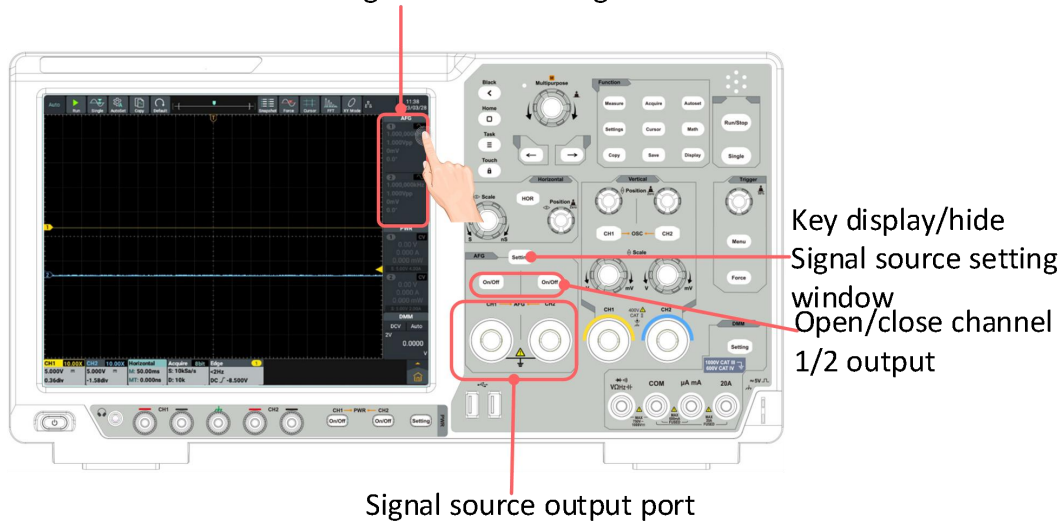

### Display window of arbitrary waveform/function generator

The display window of arbitrary waveform/function generator is located at the upper right of the screen. Refer to Channel 1 for the descriptions of Channel 2.

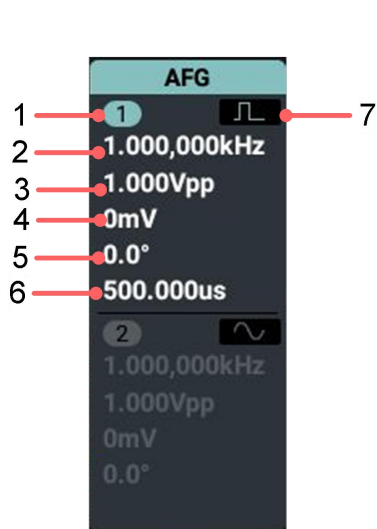

Figure A



Figure B

#### Descriptions:

1. Display the channel name and the channel output switch status.

2. Display the frequency/cycle.
3. Display the amplitude/high level.
4. Display the offset/low level.
5. Initial phase .
6. Figure A: Display the pulsewidth/duty ratio.
7. Figure A: Display the current waveform.
8. Figure B: Display the current modulation mode.

## Setting Window of arbitrary waveform/function generator

The display window of arbitrary waveform/function generator is located at the upper right of the screen. Refer to Channel 1 for the descriptions of Channel 2.

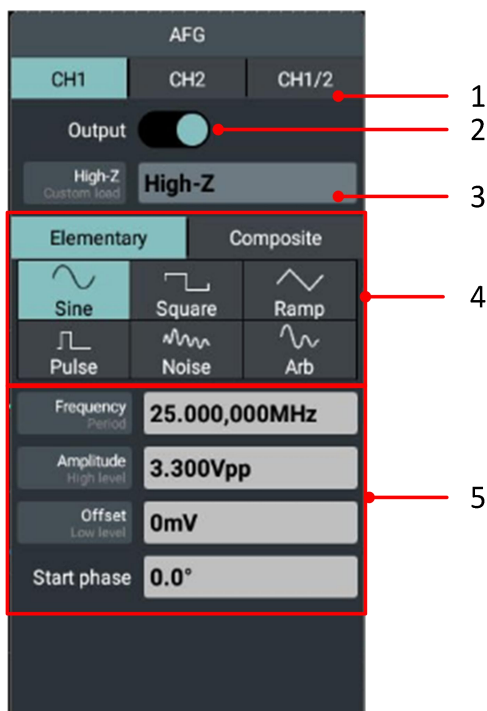

Descriptions:

1. Select the channel.
2. Enable or disable the channel output.
3. Select the load: **high resistance** or **Custom load**(Range is a to **10k $\Omega$** , default is **50 $\Omega$** ).
4. Waveform selection area.
5. Output parameter setting area.

## Connect the output end

Connect BNC cable to the output end of **Channel 1** or **Channel 2** signal generator of the oscilloscope's front panel.

Press the **On/Off** keys of two channels. To view the output of the signal

generator, connect the other end of BNC cable to the signal input channel of the oscilloscope's front panel.

## Set the channel

- **How to switch the channels displayed in the menu**

Open the signal source setting window and click CH1, CH2 or CH1/2 at the upper of the window to switch among **Channel 1** menu, **Channel 2** menu and **Channel Copy** menu.

- **How to enable/disable the channel output**

Press **On/Off** key of two channels to enable/disable the output of corresponding channel. The key light of corresponding channel turns on when the output is enabled.

- **Channel copy menu**

Press **CH1/CH2** softkey to switch to the Channel Copy menu.



### Align Phase

Click **Align Phase** softkey in the menu below to align the initial phases of two channel signals.

### Copy channel

Select From **CH2→CH1** in the menu below to copy the parameters of Channel 2 to Channel 1.

Select From **CH1→CH2** in the menu below to copy the parameters of Channel 1 to Channel 2.

### Frequency synchronization

Select **Frequency Sync** as **On** in the menu below. When adjusting the frequency of one channel, that of the other changes simultaneously.

### Amplitude synchronization

Select **Amplitude Sync** as **On** in the menu below. When adjusting the amplitude of one channel, that of the other changes simultaneously.

## Set the waveform

- (1) Click **CH 1** or **CH 2** display window to display the setting window of the signal generator.
- (2) Select the waveform required and corresponding waveform setting menu from the menu items at the lower part of the window.
- (3) Operate the setting menu to set the parameters of the waveform required.

Example: Press **Frequency** in the menu below (if there is only **Period** other than **Frequency**, click the title to switch it to **Frequency**), and set the required value, the specific methods are as follows.

**There are 3 methods to change the parameter values selected:**

- **Use digital soft keyboard input mode:** Click **Numeric Display Box** and the soft keyboard appears, and input the required value directly.

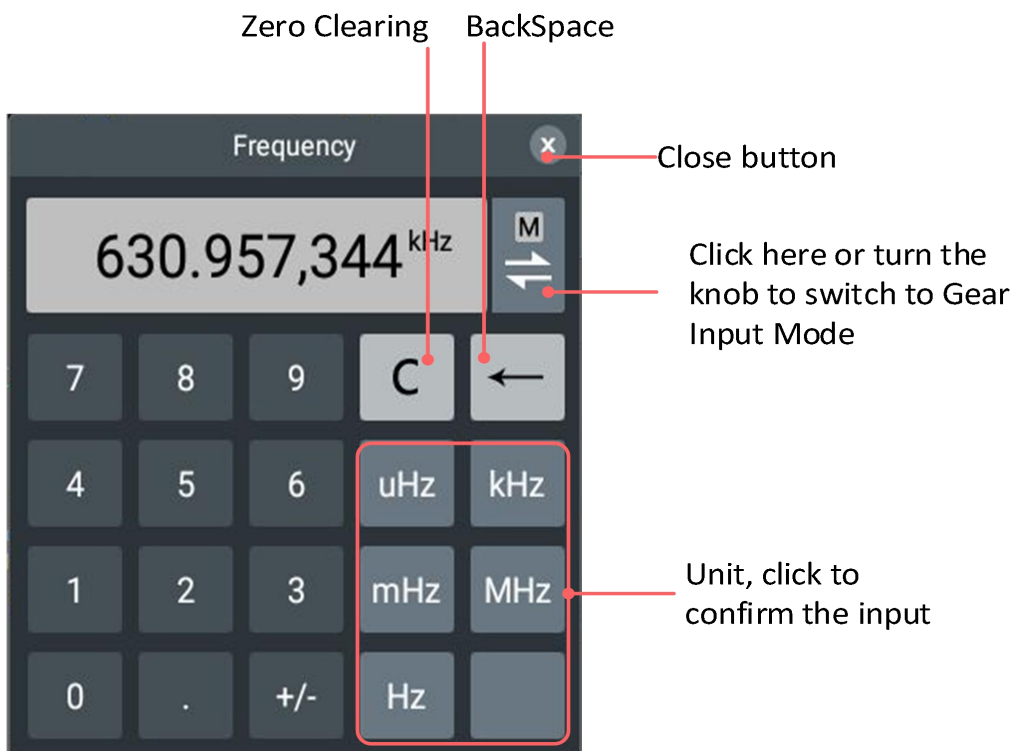

● **Use gear input mode:**

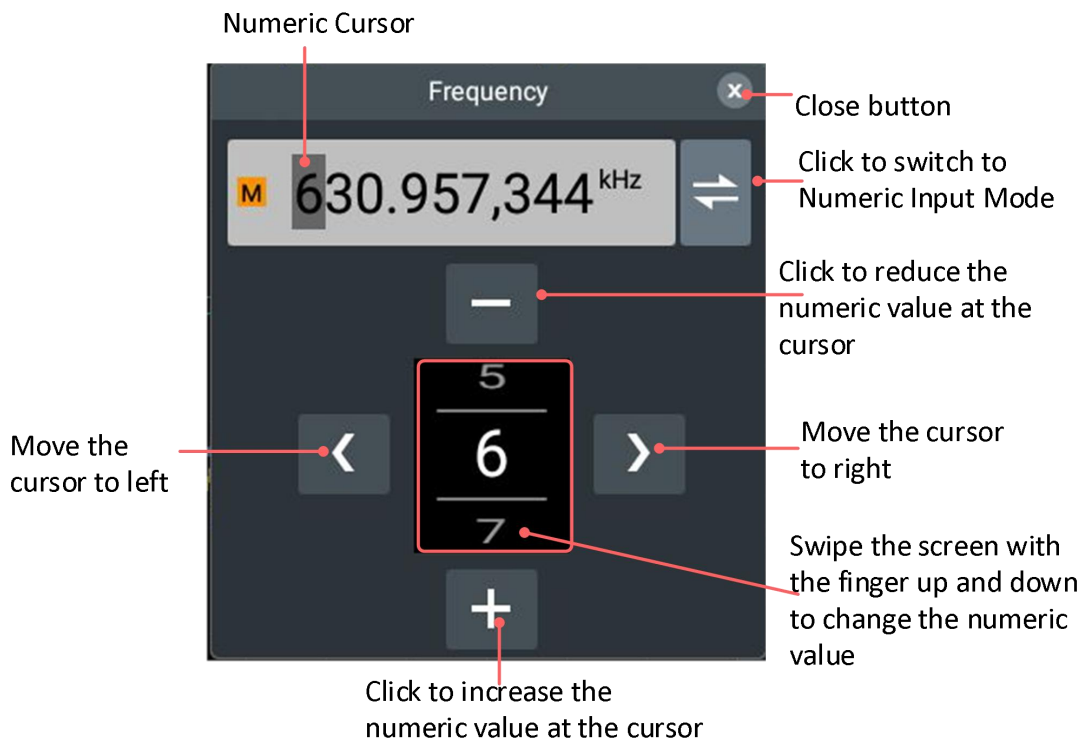

- **Use General Knob:** Turn **General Knob** to increase or decrease the value at the cursor. Press / to move the cursor left and right, see the gear input mode diagram for details.

Parameters that can be set for each waveform

Name	Menu Items
Sine	Frequency/Period, Amplitude/High Level, Offset/Low Level, Start Phase
Square	Frequency/Period, Amplitude/High Level, Offset/Low Level, Start Phase
Ramp	Frequency/Period, Amplitude/High Level, Offset/Low Level, Start Phase, Symmetry
Pulse	Frequency/Period, Amplitude/High Level, Offset/Low Level, Start Phase, Pulse width/Duty Cycle
Noise	Amplitude/High Level, Offset/Low Level
Arbitrary	Frequency/Period, Amplitude/High Level, Offset/Low Level, Start Phase, Built-in/External

## Output Built-in Waveform

There are 28 kinds of built-in waveforms. To select the built-in waveform, follow the steps below:

- (1) Click **CH 1** or **CH 2** display window to display the setting window of the signal generator.
- (2) Select **Arbitrary Wave** in the menu below and click **Built-in External**.
- (3) Select the classification of the built-in wave in the menu: **Engineering**, **Maths**, **Medical**, **Trigonometric** or **Others**. For example, select **Others**.
- (4) Click **DC** to output the DC voltage waveform.

## Output Modulation Waveform

Supported modulation types include: Amplitude Modulation (AM), Frequency Modulation (FM), Phase Modulation (PM) and Frequency-shift Keying (FSK).

Press **Setting** key in the signal source area of the panel or directly click the signal source display window at the right side of the screen to pop up the signal source setting window, click **Composite** and select **Modulation**; click **Type** menu to select the modulation type. To disable the modulation, pop up the signal source setting window again, select **Continue** in the **Composite**.

Parameters that can be set for various modulation types

Type	Settings
AM	Mod.Wave、 Mod.Freq、 Mod.Depth
FM	Mod.Wave、 Mod.Freq、 Frequency deviation
PM	Mod.Wave、 Mod.Freq、 Phase.Dev
FSK	Mod.Freq、 Hop Freq

## Output Sweep Waveform

In the sweep mode, the output varies from the start frequency to stop frequency within the specific scan time. Only sine wave, square wave, sawtooth wave or arbitrary wave (except DC) can be used to product sweep waveforms.

When the output signal is sine wave, square wave, ramp wave or arbitrary wave, press **Setting** key at the signal source area of the front panel or directly press the signal source display window at the right side of the screen to pop up the signal source setting window, then click **Sweep** in the **Composite** to enter the sweep mode.

Parameters that can be set include **sweep time**, **Linear/Log**, **Start Freq/Ctr Freq**, **Stop Freq/Freq Span**, and **trigger source**. When the trigger source is switched to manual, the soft key is displayed at the bottom. Click the soft key to perform a frequency sweep trigger. To turn off the **sweep**, call up the signal

source setting window again and select **continuous** in the **composite**.

## **Generate Burst**

Press **Setting** function key at the signal source area of the front panel or directly click the signal source display window at the right side of the screen to pop up the signal source setting window, click **Burst** in the **Composite** to generate pulse train waveform output of various waveform functions. The pulse trains can last a specific number of waveform cycles (N cycle pulse trains). Sine wave, square wave, sawtooth wave, pulse wave or arbitrary wave functions can be used (this function is unavailable for noise wave).



# 7. Use the Power Supply

## Power Supply Area on the Front Panel

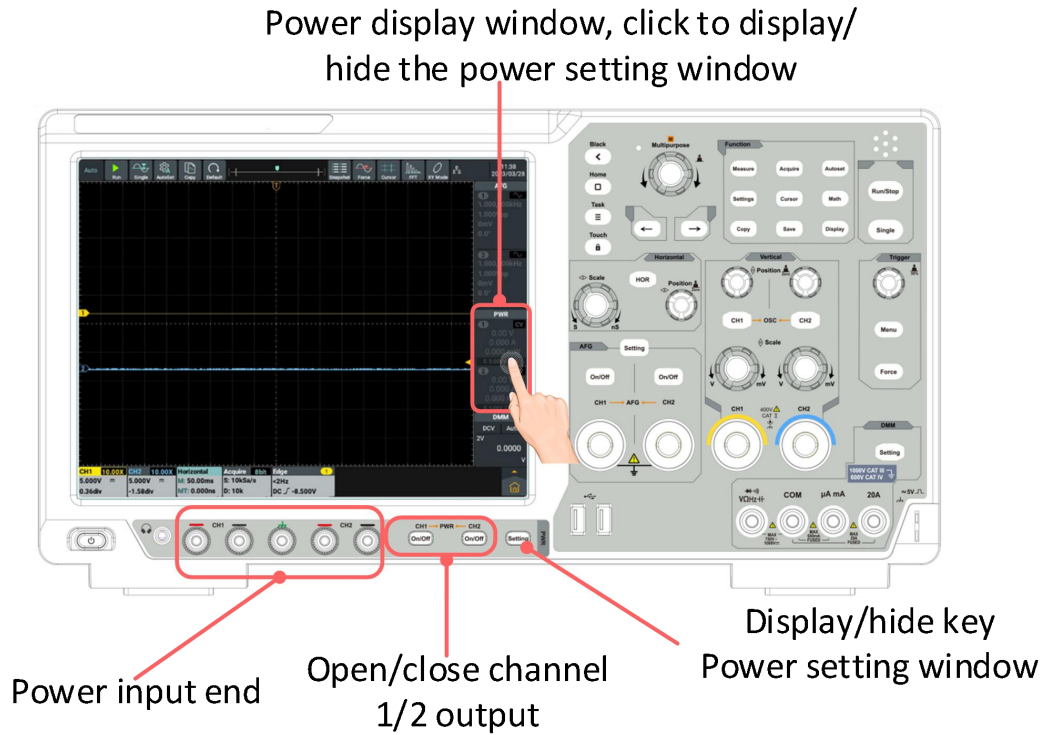

## Power Display Window

The power display window is located in the middle right of the screen. Please refer to Channel 1 for the descriptions of Channel 2.

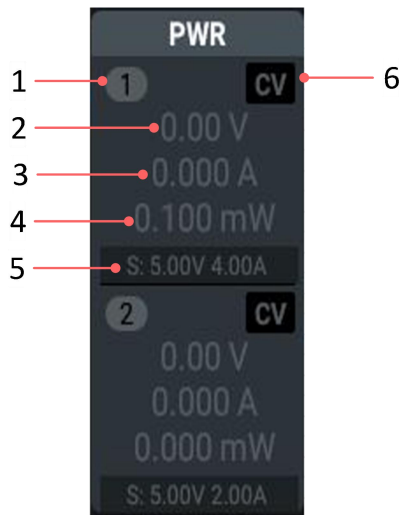

Descriptions:

1. Display channel name and channel output switch status.
2. Actual Output Value of Voltage.
3. Actual Output Value of Current.
4. Actual Output Power.
5. Set Values of Output Voltage/Current.
6. Display Constant Voltage/Constant Current.  
CV: Constant Voltage Output;  
CC: Constant Current Output.

## Power Setting Window

Click Screen Power Display window or press **Setting** key at the power supply area on the screen to display/hide the power measurement setting window.

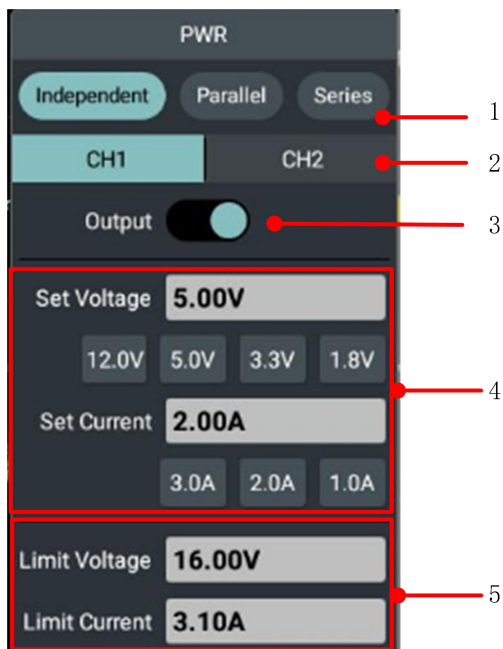

Descriptions:

1. Set current function mode.
2. Select CH1 or CH2 as the channel output parameter.
3. Click to enable/disable measured value output.
4. Voltage/Current setting area.
5. Overvoltage/Overcurrent protection Settings.

# 8.Use the Multimeter

## Multimeter Area on the Front Panel

In the Multimeter area on the front panel of the instrument, there is 1 multimeter setting key and 4 multimeter input ends. The input end of the multimeter is located at the lower right of the front panel, with 4 sockets marked  $\text{V}\Omega\text{Hz}\text{Hz}$ , COM,  $\mu\text{A}$  mA and 20A, respectively.

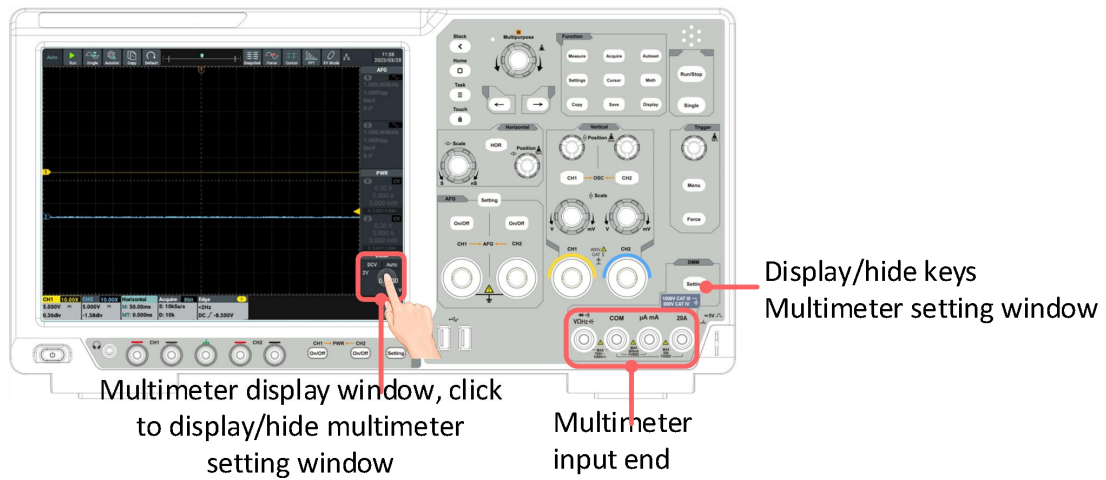

Figure 8- 1: Multimeter Area

## Multimeter Zoom Box

The multimeter Zoom Box is located at the lower right of the screen.

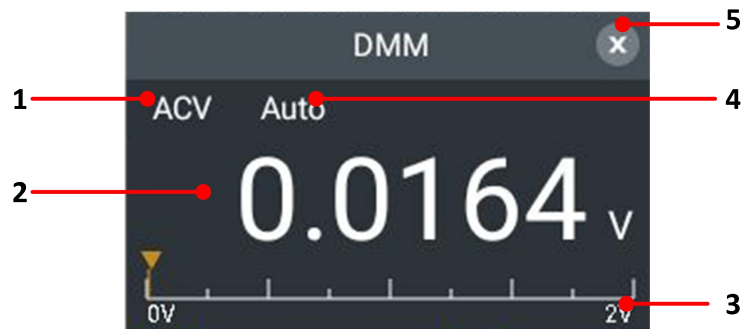

Figure 8-2: Multimeter Zoom Box

Descriptions:

1. Display window drag icon.
2. Measuring type indication:

**AC** ----- AC Voltage Measurement

<b>DC</b>	-----	AC Voltage Measurement
<b>ACI</b>	-----	AC Current Measurement
<b>DCI</b>	-----	DC Current Measurement
<b>±</b>	-----	Capacitance Measurement
<b>Ω</b>	-----	Resistance Measurement
<b>🔊</b>	-----	On-off Measurement
<b>▶</b>	-----	Diode Measurement

3. Measured display value; if the measured value is out of range, “**OL**” is displayed.
4. Current Range.
5. Manual Range/Automatic Range Indication: **Manual** indicates manual range; **Auto** indicates automatic range.
6. Zoom Frame Off key.

## Multimeter Setting Window

Click Multimeter display window on the screen or press **Setting** key at the multimeter area of the front panel to display/hide the multimeter measurement setting window.

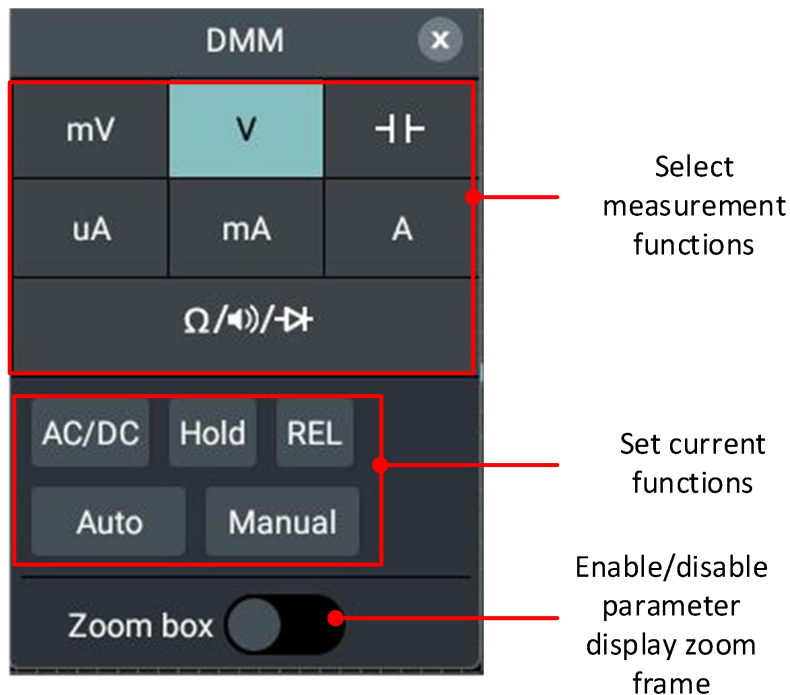

Figure 8- 3: Multimeter setting Window

## 8. Use the Multimeter

	<b>Soft Key</b>	<b>Descriptions</b>
<b>Function</b>	<b>mV, V</b>	Measure the voltage.
	⇄	Measure the capacitance.
	<b>uA, mA, A</b>	Measure the current.
	Ω/⚡/⇄	Measure the resistance/on-off testing/measure the diode.
<b>Settings</b>	AC/DC	Switch AC/DC upon voltage or current measurement.
	Hold	Keep the current reading on the display.
	REL	Reading is the difference between the stored reference value and the input signal.
	Auto	Select auto range mode.
	Manual	Select manual range mode and press to switch the range.
<b>Zoom box</b>		Open/Close the parameter display zoom box.

## 9.Appendix

### Appendix A: Enclosure

(The accessories subject to final delivery.)

#### Standard Accessories:



Power Cord



Quick Guide



USB Cable



Probe



Probe Adjust



Multimeter Lead

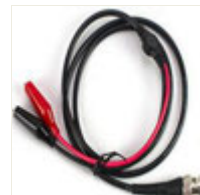

BNC to alligator  
clip Q9 cable



banana plug to  
alligator clip cable

### Appendix B: General Care and Cleaning

#### General Care

Do not store or leave the instrument where the liquid crystal display will be exposed to direct sunlight for long periods of time.

**Caution: To avoid any damage to the instrument or probe, do not exposed it to any sprays, liquids, or solvents.**

#### Cleaning

Inspect the instrument and probes as often as operating conditions require. To clean the instrument exterior, perform the following steps:

1. Wipe the dust from the instrument and probe surface with a soft cloth. Do not make any scuffing on the transparent LCD protection screen when clean the LCD screen.
2. Disconnect power before cleaning your Oscilloscope. Clean the instrument with a wet soft cloth not dripping water. It is recommended to scrub with soft detergent or fresh water. To avoid damage to the instrument or probe, do not use any corrosive chemical cleaning agent.



**Warning:** Before power on again for operation, it is required to confirm that the instrument has already been dried completely, avoiding any electrical short circuit or bodily injury resulting from the moisture.

---