

Fieldpiece®

Combustion Analyzer

OPERATOR'S MANUAL

Model CAT45

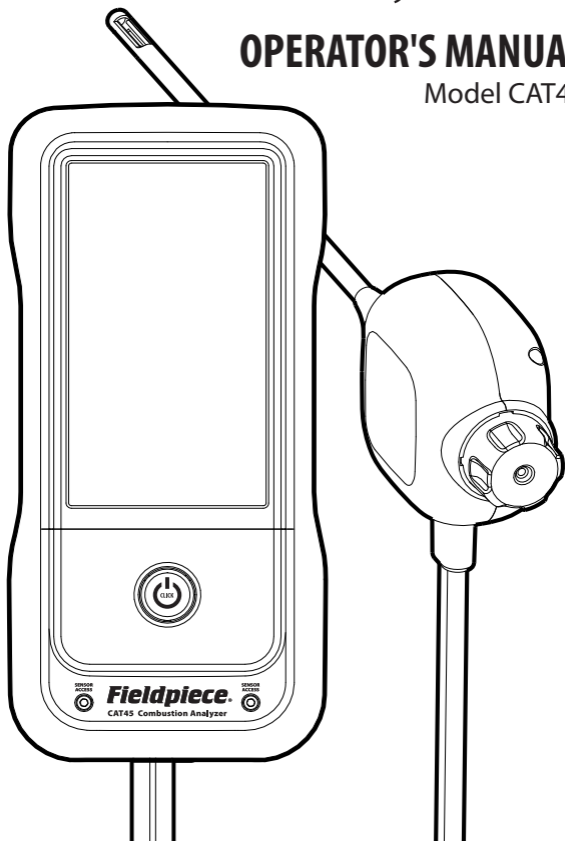

Contents

Safety Information.	4
Warning and Caution	

Description	6
Features	
What's Included	
CAT45 Hardware	

Operation.	10
SensorVault™ Technology	
Inline Water Trap	
Battery Life and Charging	
Powering ON	
Powering OFF	
Storage	
Common Sampling Points	

Job Menu	16
Combustion	
Ambient CO	
Drafts	
Primary Air	
Smoke	

Customer	23
Note	
Report	
Save and Exit	
Job Archive	

Settings	26
-----------------	----

Maintenance.	28
General	
Dust Filter Replacement	
Sensor Replacement	
Calibration	

Specifications	32
Sensors	
Test Parameters	

Limited Warranty	36
Sensor Warranty	
Obtaining Service	

Safety Information

Only qualified personnel trained in service and installation of electric heaters, boilers, and furnaces shall use this combustion analyzer.

This device measures and analyzes key parameters of combustion equipment including oxygen, carbon monoxide, temperature, carbon dioxide, efficiency, and draft pressure.

Read and understand this operator's manual in its entirety before using to prevent injury or damage to you or the equipment. As with any job, appropriate use of personal protective equipment (PPE) is required.

WARNING

- Do not use the analyzer as a safety device.
- Always be aware of and test for ambient CO levels.
- Do not use unless in a well-ventilated location.
- Do not use in areas classified as hazardous locations; not intrinsically safe.
- Do not use unless a visual inspection ensures it's safe to do so.
- Ensure any connections to fuel sources are leak-free.
- Do not touch or store probe until it cools to ambient temperature.
- Condensate may be acidic.
- Combustion gases may be toxic even in low concentrations.
- Seal any equipment holes used during testing in order to prevent dangerous flue gas entering the space.

CAUTION

- Do not use or store near solvents.
- Do not clean with solvents.
- Do not use on a continuous basis.
- Refer to 3rd party smoke test documentation to verify if smoke in equipment is at a safe level (1 or less). Not verifying this prior to conducting other tests, such as combustion, can result in damage of the analyzer and produce incorrect measurements.
- This device should only be opened and/or serviced by authorized personnel. Gas sensors may be replaced by user.
- Do not apply pressures above maximum specifications.
- Do not disconnect combustion probe cable when powered on.
- Use only within operating environment specification.
- Do not use in the rain or wet environments.

Description

The Fieldpiece CAT45 Combustion Analyzer provides a hassle-free solution for technicians to get the job done quickly, easily, and safely while improving system efficiency.

Accurate sensors of O₂, CO, pressure, and temperature along with powerful trending, provide key insight into equipment performance. SensorVault™ technology seals to prolong sensor life.

Features

- 4 Year Gas Sensor Warranty
- Large Intuitive Touchscreen
- Powerful Trending
- SensorVault™ Technology
- Inline Water Trap
- Rechargeable Battery
- In-use USB-C Charging
- Field Replaceable Smart Sensors
- Job Link® System App Compatible
- Wireless Printer (CATPR) Compatible
- Durable Hard Lined Case

What's Included

- Combustion Analyzer + Probe
- Hard Lined Carrying Case
- Extra Dust Filters and O-rings
- USB-C Charging Cable
- Operator's Manual
- 1 Year Device Warranty
- 4 Year Sensor Warranty

CAT45 Hardware

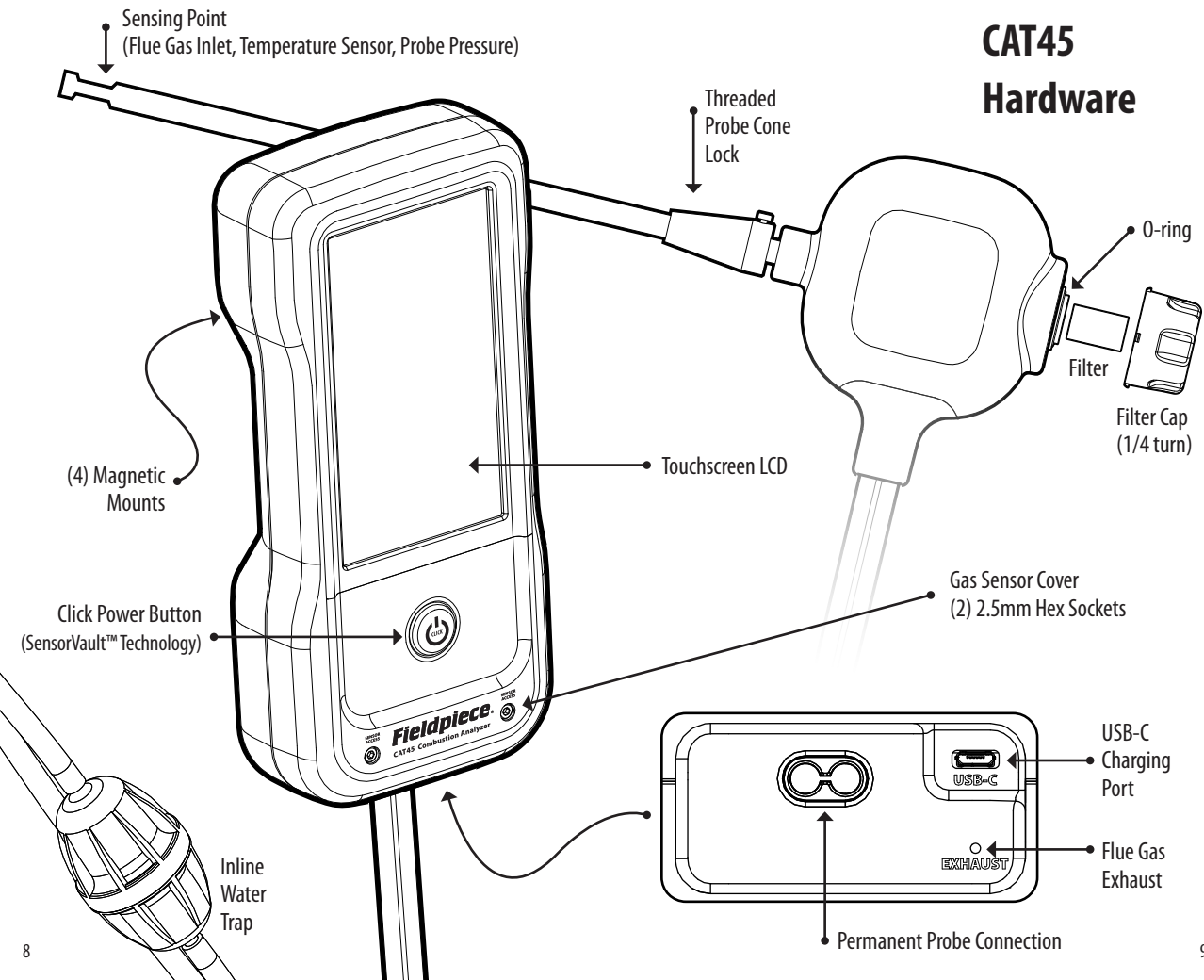

Operation

The CAT45 workflow is streamlined to quickly get into your job, complete your testing, send your report, and get onto your next job.

SensorVault™ Technology

SensorVault™ technology mitigates the typical degradation of electrochemical sensors by placing a gas-tight cover over the gas sensors when the analyzer is powered off which seals the sensors in storage.

This sealing and unsealing is done with the power button, so be sure to press far enough down to hear and feel the “click” of the seal.

Inline Water Trap

Condensate of the hot flue gas must be emptied as the water trap fills else airflow to the sensors eventually stops. Rotate 1/4 turn to open and dispose condensate.

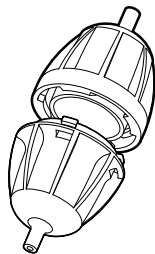

Battery Life and Charging

CAT45 can be operated while charging its battery so it's a good idea to store a charger and cable with the analyzer.

Charge with the included USB-C to USB-A cable connected to a 5V/2A DC charger/port/adaptor. High speed chargers are not supported.

To maximize battery life, you can disable the Job Link® system, lower display brightness, disable button sounds, and stop the pump when it's not needed.

It's possible CAT45 may power on automatically when plugged in to charge. This occurs if the battery had depleted and powered off without pressing the power button, leaving the sensors unsealed. Fully press the power button down to seal the sensors, power off, and continue charging.

Powering ON

Read “**Safety Information**” section.

1. Ensure inline water trap is sealed.
2. Move probe to fresh ambient air for accurate sensor zeroing.
 - *This step should be executed outside of the test room and away from any vehicle exhaust where traces of CO could be lingering.*
 - *Do not rely on the analyzer alone to check for unsafe CO levels.*
3. Fully press the power button down until you feel and hear the “click” of the SensorVault™ technology UNSEAL the sensors. *Press deeper if it displays “SEALED”.*
4. Wait for start countdown to complete.
5. Start testing. See “**Job Menu**” section.
 - *Electrochemical gas sensors require extra time to stabilize if sealed for an extended period of time or sealed shortly after being over-exposed to target gases. In these cases, you may see an unusually high CO or oxygen reading. To prepare the sensors for testing, start a COMBUSTION test in fresh air until the CO reading returns to 0 and oxygen reading is stable (typically less than half an hour), then ZERO PROBE to 20.9% O₂.*

Allow ON/OFF countdowns to complete. Interrupting requires pressing the power button a third time to UNSEAL/SEAL the sensors and restart the countdown.

Powering OFF

Read “**Safety Information**” section.

1. Complete your testing and reporting.
2. Empty inline water trap.
3. Move probe to fresh ambient air to clear CAT45 of hot flue gas.
4. Fully press the power button down until you feel and hear the “click” of the SensorVault™ technology seal the sensors. *The unit powers off when SEALED and purging is complete. Press deeper if it displays “UNSEALED.”*
5. Store safely. See “**Storage**” section below.

Storage

Read “**Safety Information**” section.

- Ensure the probe has cooled to ambient temperature before inserting into its protective sleeve of the carrying case.
- Insert the CAT45 body upside down into the padded pocket so the display is fully covered and the cable is free to move.
- Do not stack objects on top of the case.
- Warmup is extended if freezing temperatures are detected, but it's best to store at room temperature.
- Store in a dry environment.

Common Sampling Points

The many types of combustion equipment vary in their design and therefore their ideal sampling points. However, there are commonalities that make for useful guidelines when analyzing performance.

Heed equipment manufacturer instructions above anything mentioned in this manual.

- Before inserting the probe in the flue, it's good practice to test for excessive soot which may lead to carbon buildup within the analyzer or overexpose sensors.
- Use the probe cone lock to hold the probe tightly in place at the sampling point. The probe is designed to function in any orientation.
- The center of the flue is often a good place to locate the sensing point of the probe, but locating at the highest point of CO is best.
- After testing, consider using silicone or metal plugs to cover drilled holes. These are especially useful for double-walled flues.

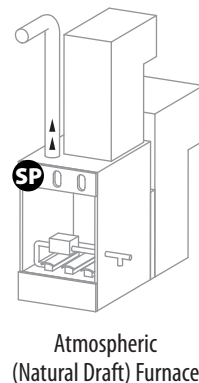
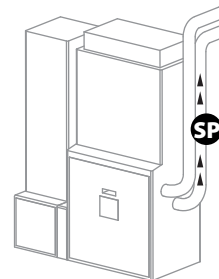
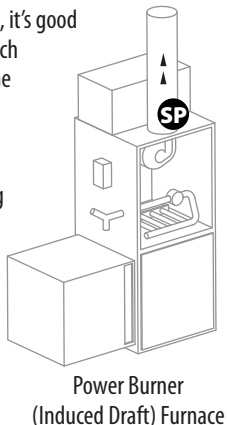

Sample Point



Flue Gas Direction

Job Menu

The JOB MENU is the central hub of CAT45. In addition to being the access point to SETTINGS and the JOB ARCHIVE, you can think of the JOB MENU as the form you complete for each job. Select a test, save the result, and go onto the next. Saved tests are highlighted, and you can always select a saved test to view, delete, or save over previous results.

Open the REPORT to send it to the Fieldpiece Wireless Thermal Printer (model CATPR). Alternatively, you can view live combustion and saved tests directly in the Job Link® mobile app.

When the job's done, select SAVE AND EXIT to store the job and automatically start a new one. Up to 1000 jobs can be stored and are sequentially numbered for easy tracking.

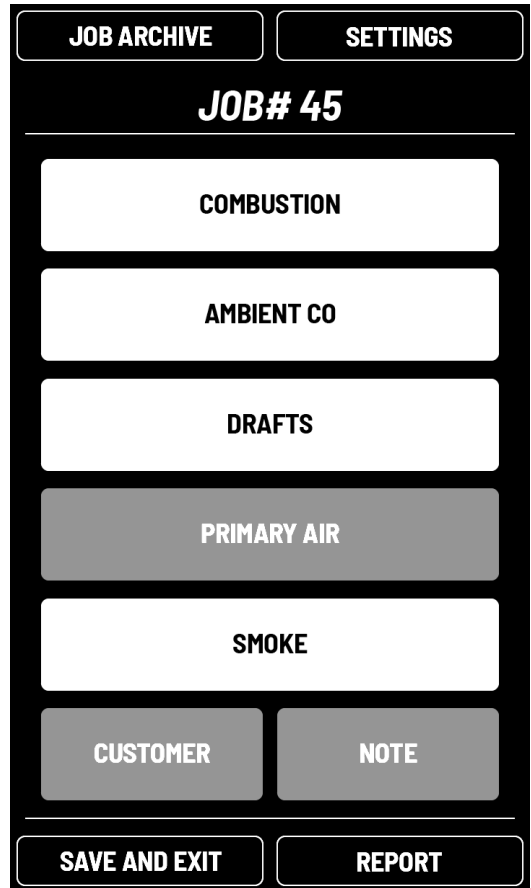

Combustion

By default, the COMBUSTION test starts automatically after startup is complete. This test analyzes flue gas from various heating equipment. Use this test to setup, test, and document equipment performance. You can view up to 8 parameters simultaneously which can be selected and positioned in SETTINGS. All 10 combustion parameters are saved and available for reporting.

CO Sensor Overexposure

Do not power off if you see this warning. It appears if the CO sensor detects a potentially damaging level of CO. Remove the probe from the flue so fresh ambient air can pump through the device.

Read “Safety Information” section.

1. Ensure startup is complete. See “Powering On” section.
2. Mount the CAT45 onto a secure, cool, magnetic surface near the sampling point.
3. Twist probe cone lock into the flue port at the sampling point and secure the probe. See “Common Sampling Points” section.
4. Select COMBUSTION from the JOB MENU.
5. Select the fuel and equipment type.
6. View live measurements.
For best results, test for at least 5 minutes where you find the highest level of CO - typically near the center of the flue.
7. SAVE ALL measurements displayed.
Remove the probe and cone from the flue when finished.
 - *Be careful not to let the metal touch anything until it cools.*
 - *It is normal for condensation to form in the filter cap.*

ZERO PROBE

ZERO PROBE resets the oxygen zero point. Always remove the probe from the flue before using ZERO PROBE. For the very best O2 measurements, start the pump and keep the probe in ambient air for 2 minutes before using ZERO PROBE. You should see a reading of approximately 20.9% O2 in ambient air.

Reference Ranges

If assigned to one of the top 4 measurement slots, the position of Stack Temperature, O2, CO, and CO Air Free within its generally accepted range is shown for supported equipment. Supported equipment is indicated by an icon during selection. A GREEN arrow suggests an acceptable level. The arrow and reading are YELLOW if outside the range. *These ranges are for reference only.*



Trending

Use trending to check how combustion parameters change over time. See “Settings” section for TRENDING SETUP.

Gas Sensor Insights

- If O2 is reading normally, but CO is reading extremely low, the equipment may be burning very clean. Check the manufacturer’s specification or test on known equipment to verify.
- If CO is reading normally, but O2 reads 0%, the O2 sensor may be clogged and needs to be replaced.
- If O2 is reading normally, but CO is reading higher than expected, the CO sensor may have been exposed to high CO concentration and needs to recover. See “Powering On” section.
- If O2 is not reading 20.9% in clean, ambient air, the sensor may have been sealed for a very long time. See “Powering On” section.

Ambient CO

CO is a very dangerous gas and it's critical that living spaces are clear of carbon monoxide.

Read "Safety Information" section.

1. Ensure startup is complete. *See "Powering On" section.*
2. Select AMBIENT CO from the JOB MENU.
3. View CO measurement while walking through the living space.
4. SAVE the measurement displayed.
"DELETE" temporarily deletes a single value so you can retest.
"DELETE TEST" deletes the test.

Ambient CO Warning

Vacate the area immediately if you see the Ambient CO warning. It appears if the CO sensor detects a harmful level of CO. The CO warning level can be adjusted from the warning screen.

Drafts

CAT45 does not measure draft pressure with the COMBUSTION test, but a saved FLUE DRAFT measurement shows during COMBUSTION. Draft pressure measurement is important for safety and performance.

Read "Safety Information" section.

1. Ensure startup is complete. *See "Powering On" section.*
2. Select DRAFTS from the JOB MENU.
3. Mount the CAT45 onto a secure, cool, magnetic surface near the sampling point.
4. ZERO PROBE to zero the probe's pressure sensor.
Always remove the probe from the flue before using ZERO PROBE.
5. Move probe to desired sampling point- DILUTED, FLUE, or OVERFIRE.
6. View live measurement.
7. SAVE the measurement displayed.
"DELETE" temporarily deletes a single value so you can retest.
"DELETE TEST" deletes the test.
8. Remove the probe from the sampling point when finished.
Be careful not to let the metal touch anything until it cools.

Primary Air

Primary air temperature is measured during startup and is used for the COMBUSTION test. This is the temperature of the air going into the combustion equipment. It's sometimes useful to set it after startup if the ambient temperature changes. You can enter it manually or use the probe's temperature sensor.

Read "Safety Information" section.

1. Ensure startup is complete. *See "Powering On" section.*
2. Select PRIMARY AIR from the JOB MENU.
3. Move the probe to the entry point of air into the combustion equipment.
4. View live measurement or use the keyboard onscreen to manually enter a value.
5. SAVE the temperature.
"DELETE" temporarily deletes a single value so you can retest.
"DELETE TEST" deletes the test.

Smoke

The smoke test is used to document the soot levels within the flue. This is good practice when "dirty" combustion is expected in order to extend the life of CAT45 and equipment. A third party smoke tester is needed.

Read "Safety Information" section.

1. Ensure startup is complete. *See "Powering On" section.*
2. Select SMOKE from the JOB MENU.
3. Use your smoke tester to find the smoke level.
4. Select the corresponding level on screen.
5. SAVE the smoke level.
"DELETE" deletes the entry.

Customer

Each job has a customer entry. JOB ARCHIVE uses this entry for searching. You can use this field for whatever you want. For example, it can be a serial number or a phone number. See "Settings" section for report contents.

1. Ensure startup is complete. *See "Powering On" section.*
2. Select CUSTOMER from the JOB MENU.
3. Use the keyboard to enter.
4. SAVE the customer.
"DELETE" deletes the entry.

Note

Each job has a note entry.

1. Ensure startup is complete. *See "Powering On" section.*
2. Select NOTE from the JOB MENU.
3. Use the keyboard to enter.
4. SAVE the note.
"DELETE" deletes the entry.

Report

Each job has a report which is a collection of saved tests, your company info, reference O2, date, and time. Date and time is recorded at the time of sending the report. Edit report contents from settings.

1. Ensure startup is complete. See *“Powering On”* section.
2. Select REPORT from the JOB MENU.
*At least one test must be saved to view the job report.
Saved jobs are opened from JOB ARCHIVE.*
3. Scroll through the report using the scroll bar.
4. PRINT to model CATPR wireless thermal printer (optional).
SEARCHING button changes to *PRINT* button if CATPR is detected.
5. DELETE JOB deletes the job from memory.

Job Link® System Reporting

Turn Job Link System ON to view CAT45 in the Job Link system mobile app (see *“Settings”* section). Communication is one-way, from the analyzer to the app. View live combustion and all saved tests of the current job directly in the app. Then, email a report directly from your mobile device.

Save and Exit

SAVE AND EXIT to save your job and start a new job, sequentially numbered. You can return to saved jobs from JOB ARCHIVE.

Low Memory Notice

A notice appears when memory is too low to SAVE AND EXIT. Delete jobs individually from JOB ARCHIVE or delete all jobs from SETTINGS.

Job Archive

Open JOB ARCHIVE from the JOB MENU.

- Sort jobs by date.
- Search jobs by customer.
- Select a job to open it.
- Use the X icon to delete a job

Settings

Access SETTINGS from the top right corner of the Job Menu. Each setting button cycles through its options or to its own screen (blue arrow).

The DEFAULTS button in the top right corner of the settings reverts to default settings, but jobs are not deleted.

Job Link® System: OFF (default), ON

Select ON to view live combustion and saved tests on the Job Link system mobile app.

Brightness: HIGH, MEDIUM (default), LOW

Button Sound: ON (default), OFF

Sensor Remaining (status): % O₂ and % CO sensor life remaining.

New sensors show approximately 100%. When life of either sensor is below 5%, a notice appears at startup.

Memory % Free (status): % of memory remaining for saving jobs.

Up to 1000 fully tested jobs can be saved. When memory is too low, a notice appears when trying to SAVE AND EXIT a job. DELETE ALL is a quick way to delete all jobs and restart at JOB #1. Delete single jobs from within the JOB ARCHIVE screen.

Date and Time: *EDIT to adjust date and time. 24 hour time is always used. Date format is always set to Year-Month-Day for easy sorting.*

Company Information: *EDIT to adjust Company Information shown on reports.*

Startup Screen: COMBUSTION (default), JOB MENU, FUEL TYPE

Set which screen you want to see after start countdown is complete.

Auto Hold Display: PUMP STOP (default), NEVER

Select NEVER to continue viewing live temperature while the pump is stopped.

Combustion Setup: *EDIT to select parameters and their slots on the COMBUSTION screen. To hide a slot completely, assign a parameter to the slot you want to hide, then assign that parameter to another slot.*

Trending Setup: *EDIT to select parameters on the TRENDING screen. SET LIMITS to adjust each parameter's UPPER (maximum) and LOWER (minimum) values of the graph. Controlling these limits allows you to effectively zoom and shift each parameter independently for better visibility.*

Report Contents: *EDIT to select what is shown on reports.*

Language (status): English (default) *This is not adjustable.*

Temperature Unit: ° F (default), ° C

Pressure Unit: inWC (default), torr, Pa

[%] Reference O₂: 6.0% (default) *EDIT to adjust the reference oxygen % used for calculating CO Air Free.*

Efficiency Calculation: Standard (default), Siegert
Siegert's formula is typically only used in parts of Europe.

Firmware [version]: *UPDATE to install new firmware if it becomes*

Maintenance

General

Wipe with damp cloth to clean the exterior.
Do not use solvents.

Dust Filter Replacement

Replace the dust (particulate) filter if you notice an increase in response times or when it's visually darker.

Dust Filters: model RFC10

1. Ensure the probe has cooled before opening to avoid contact with hot gas and liquid that may be within the probe.
2. Rotate the Filter Cap 1/4 turn counter-clockwise to release.
3. Pull out the old Probe Filter and replace if needed.
4. Pull out the O-ring and replace if needed.
5. Replace the Filter Cap.

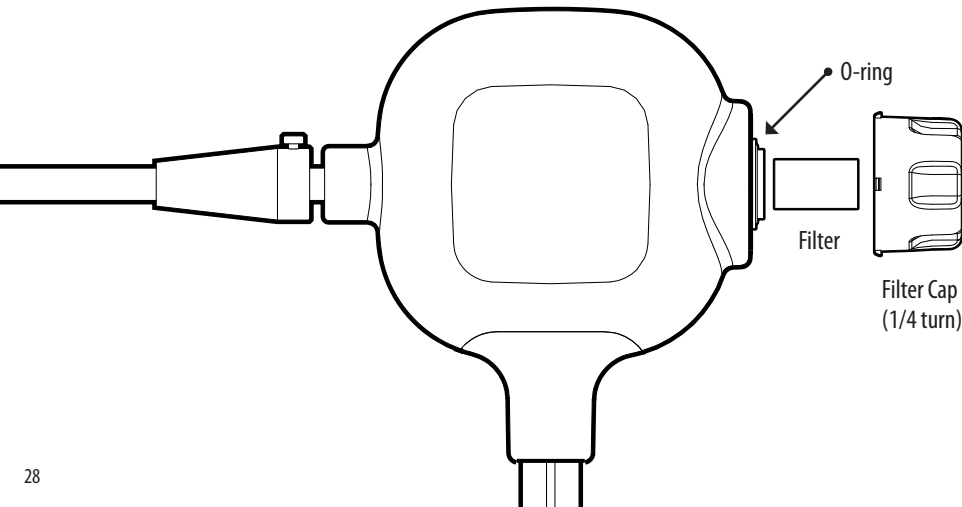

Sensor Replacement

SensorVault™ technology prolongs the life of sensors, but they eventually need to be replaced. When a sensor's life drops below 5%, a notification appears during startup to inform you it's time to replace it. You can view estimated remaining life at any time in SETTINGS.

O2 sensor: model RSO2L

CO sensor: model RSCOR

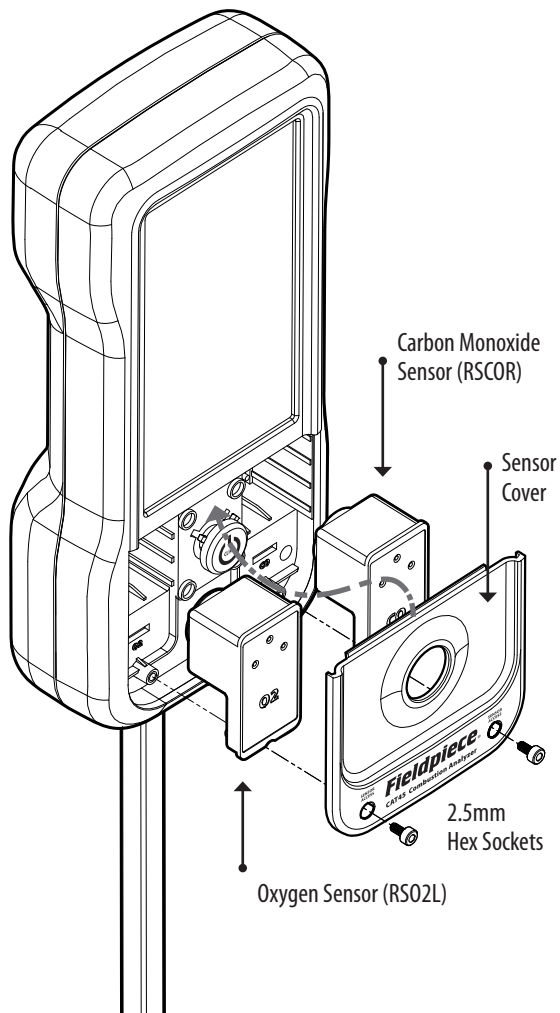

1. Double check which sensor needs to be replaced.
Leave a new sensor in its packaging until you're ready to install it.
2. Power off CAT45.
3. Use a 2.5mm hex key to remove the two socket head screws on the sensor cover labeled SENSOR ACCESS.
4. Lift up the bottom of the sensor cover to reveal the gas sensors.
5. Pull the old sensor straight out.
6. Check and remove the new sensor from its packaging.
7. Align and push the new sensor straight in.
The sensor cover won't close if the sensor is inserted incorrectly.
8. Tilt the sensor cover lip back into place and fasten screws.
9. Power on CAT45 to check sensor life in SETTINGS.
Anything above 95% is normal.

Calibration

Replacement sensors have air-tight packaging and are pre-calibrated. Annual re-calibration of existing sensors is recommended. Contact Fieldpiece for calibration service information.

Specifications

- Display:** Touchscreen TFT LCD (5.5 in diagonal)
Probe Size: 10.7 in (272 mm) length, 0.32 in (8.0 mm) diameter
Accuracy: Stated accuracies at 23°C ±5°C, <75% R.H.
Battery Type: 3.7 VDC (nominal), 6400mAh, non-replaceable
Battery Life: 7 hours typical (pump running 80% of the time)
Charging Port: USB-C (5V/2.0-2.4A DC)
(USB-A power adapter/charger not included)
(High speed chargers not supported)
Recharge Time: < 7 hours typical (Can be used while charging)
Memory: 1000 jobs (approx.)
Warm Up Time: 45 seconds (90 seconds near freezing)
Operating Environment:
14°F to 104°F (-10°C to 40°C); < 75% RH (non-condensing)
Storage Temperature: -4°F to 140°F (-20°C to 60°C); < 80% RH
Weight: 39.5 oz (1120 g) with probe

- Wireless Range:** 1000 feet (305 meters)
Fuel Types: Natural Gas, Propane (LPG), Oil #2 (Light), Oil #6 (Heavy),
Biofuel, Coal, Coal Town Gas, Coking Oven Gas, KOKS, Custom (x3)
Warranty: 1 year (4 years sensors only)
Job Link® System Minimum:
BLE 4.0 devices running iOS 7.1 or Android™ Kitkat 4.4

- Printer:** Fieldpiece Wireless Thermal Printer (model CATPR)
Certifications:



IC: Industry Canada
IC: 22518-CATX5



Waste Electrical and
Electronic Equipment

Sensors

Temperature

- Sensor Type:** Type K rod thermocouple (fixed)
Response Time: < 30 seconds (T90)

Oxygen %

- Sensor Type:** Electrochemical (replaceable)
Response Time: < 30 seconds (T90)
Max Overload: 30% Oxygen

Carbon Monoxide PPM

- Sensor Type:** Electrochemical (replaceable)
Response Time: < 90 seconds (T90)
Max Overload: 10000 ppm Carbon Monoxide
Filter: NOx filter

Pressure (Probe)

- Sensor Type:** MEMS pressure sensor
Response Time: < 10 seconds (T90)
Max Pressure: 4.0 inWC will cause damage
Units: inWC, torr, Pa

Test Parameters

Stack Temperature

Range: 32 to 752°F; 0 to 400°C

Best resolution: 0.1°F; 0.1°C

Accuracy:

±2.5°F [32°F to 212°F], ±(3.6°F or 1.5%rdg) [213°F to 752°F];

±1.4°C [0°C to 100°C], ±(2.0°C or 1.5%rdg) [101°C to 400°C]

O₂

Range: 0 to 21 vol.%

Best resolution: 0.1 vol.%

Accuracy: ±0.3 vol.%

CO

Range: 0 to 4000 ppm

Best resolution: 1 ppm

Accuracy: ±10 ppm [0 to 200 ppm], ±5%rdg [201 to 2000 ppm],

±10%rdg [2001 to 4000 ppm]

Draft Pressure

Range: 0 to ±0.8 inWC

Best resolution: 0.01 inWC

Accuracy: ±0.02 inWC

CO Air Free (Calculated)

Range: 0 to 4000 ppm

Best resolution: 1 ppm

CO₂ (Calculated)

Range: 0 to CO₂max vol.%

Best resolution: 0.1 vol.%

Excess Air (Calculated)

Range: 0 to 999%

Best resolution: 0.1%

Efficiency (Calculated)

Range: 0 to 100%

Best resolution: 0.1%

qA (Calculated)

Range: 0 to 25%

Best resolution: 0.1%

Dew Point (Calculated)

Range: 32 to 212°F; 0 to 100°C

Best resolution: 0.1°F; 0.1°C

Primary Air Temp

Range: 32 to 212°F; 0 to 100°C

Best resolution: 0.1°F; 0.1°C

Accuracy: ±2.5°F [32°F to 212°F]; ±1.4°C [0°C to 100°C]

Ambient CO

Range: 0 to 200 ppm

Best resolution: 1 ppm

Accuracy: ±10 ppm

Limited Warranty

This device is warranted against defects in material or workmanship for one year from date of purchase from an authorized Fieldpiece dealer.

The O2 and CO sensors are warranted against defects in material or workmanship for four years from date of purchase from an authorized Fieldpiece dealer.

Fieldpiece will replace or repair the defective unit, at its option, subject to verification of the defect.

This warranty does not apply to defects resulting from abuse, neglect, accident, unauthorized repair, alteration, or unreasonable use of the analyzer.

Any implied warranties arising from the sale of a Fieldpiece product, including but not limited to implied warranties of merchantability and fitness for a particular purpose, are limited to the above. Fieldpiece shall not be liable for loss of use of the analyzer or other incidental or consequential damages, expenses, or economic loss, or for any claim of such damage, expenses, or economic loss.

State laws vary. The above limitations or exclusions may not apply to you.

Obtaining Service

Warranty for products purchased outside of the U.S. should be handled through local distributors. Visit our website to find your local distributor.

(Intentionally Blank)

(Intentionally Blank)

CAT45

© Fieldpiece Instruments, Inc 2023; v04

Test Equipment Depot - 800.517.8431 - [TestEquipmentDepot.com](https://www.TestEquipmentDepot.com)